

## Development of Statistical Models for Predicting Performance of R12, R134a and R290/R600 Mixture Refrigerants using Design of Experiments

K. Mani<sup>1\*</sup>, V. Selladurai<sup>2</sup>, N. Murugan<sup>2</sup>

<sup>1</sup>Department of Mechanical Engineering, Panimalar Engineering College, Chennai, India

<sup>2</sup>Department of Mechanical Engineering, Coimbatore Institute of Technology, Coimbatore, India

E-mail: [maniakmani@yahoo.com](mailto:maniakmani@yahoo.com)

### Abstract

In this paper, the performance of hydrocarbon mixture refrigerant R290/R600 (79/21 by wt %) has been analyzed as an alternative to R12 and R134a. Experiments are conducted with R12, R134a and R290/R600 mixture refrigerant at different condensing and evaporating temperatures and at various compressor speeds. Further, the statistical models are developed using design of experiments technique for the prediction of refrigeration system parameters such as refrigerating capacity, power consumption and coefficient of performance. The models developed are checked for their adequacy using F-test. The performances of vapour compression refrigeration system with various refrigerants R12, R134a and R290/R600 are compared. The R290/R600 mixture shows 19.3-27.9% higher coefficient of performance than that with R12 and R134a and it is found that the hydrocarbon mixture with 79% propane and 21% butane can be used as a substitute for R12 and R134a.

**Keywords:** Design; modelling; hydrocarbon; energy consumption; HFC; refrigerant.

### 1. Introduction

The chlorofluorocarbons (CFC) and hydrochlorofluorocarbons (HCFC) are being replaced by hydrofluorocarbons (HFC) and their mixtures in refrigeration, heat pump and air-conditioning systems due to environmental concerns on the depletion of the ozone layer and global warming. Chlorofluorocarbons have been already banned in most countries in 1996 because of their high ozone depletion potential (ODP) and global warming potential (GWP). R134a has been developed as an alternative refrigerant to R12 (Devotta et al., 1992; Butler, 2001). The refrigerant R134a is found to cause climate change because of its high global warming potential. The Montreal Protocol and the Kyoto Protocol have been subscribed to call for complete phasing out of CFCs and HFCs. Granryd (2001) discussed the possibilities and problems of using hydrocarbons as working fluids in refrigerating and heat pump equipment. Hydrocarbons (HC) are natural refrigerants and environmentally benign. They have zero ODP and negligible GWP. There are many studies and publications on hydrocarbons as substitutes for R12. Hydrocarbon (HC) refrigerants have several positive characteristics such as zero ODP, very low GWP, non-toxicity, high miscibility with mineral oil, good compatibility with the materials usually employed in refrigerating systems. The main disadvantage of using hydrocarbons as refrigerant is their flammability (Richards et. al., 1992; Ritter, 1996). If safety measures are taken to prevent refrigerant leakage from the system then a flammable refrigerant could be as safe as other refrigerants.

The thermodynamic properties of R12, R134a, propane, n-butane and iso-butane are shown in Table 1. From the table it is evident that the thermodynamic properties of pure hydrocarbons do not match with that of R12 and R134a. The variation of saturated vapour pressure with temperature of R12, R134a, propane, butane and a propane-butane

mixture is depicted in Figure 1. From the figure it is clear that the R290/R600 (79/21 by wt %) mixture can be used as a potential retrofit refrigerant instead of R12 and R134a as the vapour pressure curve of the mixture is very close to that of R12 and R134a. The thermodynamic properties of the refrigerants are taken from the NIST REFPROP database (2002).

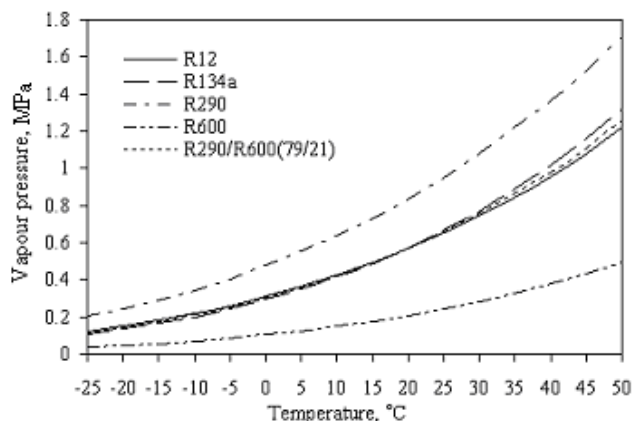

Figure 1. Vapour pressure curves of refrigerants.

The R290/R600 (79/21 by wt %) is a zeotropic refrigerant mixture with different vapour and liquid compositions in equilibrium. A zeotropic refrigerant (Chen, 2005; Rajapaksha, 2007) needs a temperature range to condense or to evaporate at a given pressure, with the dew point temperature always higher than the corresponding bubble point temperature. This leads to a shift in the composition of the phase changing mixture. The temperature glide of R290/R600 (79/21 by wt %) mixture is 10.43°C at 101 kPa. The refrigerant 290/R600 (79/21 by wt %) mixture was charged in the liquid state to assure proper

Table 1. Thermodynamic properties of Refrigerant.

Refrigerant	Molecular weight (g/mol)	Boiling point (°C)	Freezing point (°C)	Critical temperature (°C)	Critical pressure (MPa)	Latent heat (kJ/kg)
R12	120.9	-29.8	-158	112	4.14	166.2
R134a	102	-26.1	-104	101.1	4.06	217
R290	44.1	-42.1	-188	96.7	4.25	421.4
R600	58.12	-0.51	-139	152	3.79	386
R600a	58.12	-11.7	-160	134.7	3.64	364.4

mixture. The specific volume of hydrocarbon mixture is more than that of CFCs and HFCs. The amount of HC refrigerant charged is approximately one-third of CFC refrigerants.

## 2. Literature Review

Many studies have been concentrated on the research of substitutes for CFC12. This R290/R600 (79/21 by wt %) mixture is a new HC blend composed of propane 79% and n-butane 21% on mass basis and performed better than the other propane/butane mixture. Some of the recent works are reviewed here. Richardson & Butterworth (1995) investigated the performance of HC 290/HC 600a mixture in a vapour compression refrigeration system. In this study, it is shown that propane and propane/isobutane mixtures may be used in an unmodified R12 system and gives better COP than that of R12 under the same operating conditions. It is also reported that mixtures of around 50% propane and 50% isobutane had very similar saturation characteristics to that of R12 but COP seems to improve as the proportion of propane has increased. Jung et al. (1996) tested the performance of R 290/R 600a mixture in the composition range of 0.2 to 0.6 mass fractions of R 290 and compared with that of R12. It is reported that the COP of the mixture increases from 1.7% to 2.4% respectively. R290/R 600a mixture at 0.6 mass fraction of R 290 shows a 3% to 4% increase in energy efficiency and a faster cooling rate as compared to R-12. Baskin (1998) studied different mixtures of HC600a/HC290 performance in residential refrigerator/freezers. The 60/40% and 70/30% (isobutane/propane) are the best overall mixtures. Kuijpers et al. (1988) theoretically showed that 21/79 wt% propane/isobutane mixture should be considered as a substitute to CFC-12. This composition has an evaporation pressure and volumetric refrigeration capacity comparable to CFC-12. Hammad & Alsaad (1999) carried out experimental study with four ratios of propane, butane and isobutane as possible alternative to R12 in an unmodified R12 domestic refrigerator. The hydrocarbon mixture with 50% propane, 38.3 % butane and 11.7% isobutane shows better performance among all other hydrocarbon mixtures investigated. Experimental results of Jung et al. (2000) indicated that the mixture of propane and iso-butane with 60% mass fraction of propane has higher COP, faster cooling rate, shorter compressor on-time and lower compressor dome temperatures than that of R12. Akash & Said (2003) conducted performance test with LPG (30% propane, 55% n-butane and 15% iso-butane by mass fraction) as a possible substitute for R12 in domestic refrigerator. The cooling capacity and COP are comparable

to that of R12. Fatouh & Kafafy (2006) conducted experiment in a single evaporator domestic refrigerator using LPG of 60% propane and 40% commercial butane. Experimental results of the refrigerator using LPG of 60g and capillary tube length of 5m are compared with those using R134a of 100g and capillary tube length of 4m. The actual COP of LPG refrigerator is higher than that of R134a refrigerator by about 7.6%. Boumaza (2010) performed the assessment of natural refrigerants as substitutes to CFC and HCFC for air-conditioning and refrigeration purposes. Bolaji (2010) conducted experiments using R152a and R32 to replace R134a in a domestic refrigerator.

In this work, this R290/R600 (79/21 by wt %) new environmentally friendly alternative refrigerant is proposed and comparison experiments between this new refrigerant and R12, R134a are carried out using design of experiment technique to prove its potential as a promising substitute. Design of experiments (DOE) is a standard statistical technique used to identify factors and levels that have the most and least impact on system performance. The statistical analysis of the results allows the determination of the significance of the results and to obtain a mathematical equation that relates the variables and the results. The DOE technique is used in many fields such as welding, grinding, machining, etc. In this work an attempt has been made to develop a statistical model to predict and compare the performance of the refrigeration system with R12, R134a and R290/R600.

## 3. Experimental Setup and Procedure

An experimental setup of a vapour compression refrigeration system was built up to investigate the performance of R12, R134a and R290/R600 (79/21 by wt %) mixture. A schematic diagram of the experimental setup is shown in Figure 2, which consists of two loops; a main loop and a secondary loop. The main loop is composed of compressor, condenser, a filter-drier, refrigerant flow meter, sight glass, expansion valve and evaporator. The compressor is an open, reciprocating type. The compressor speed can be changed by a variable diameter belt pulley of the electrical motor. The condenser and evaporator are made up of copper double tube. In the double tube condenser, the refrigerant flows through the inner tube while the cooling water flows through the annular space between the inner and outer tube. In the double tube evaporator, the brine solution (calcium chloride/water solution) flows through the inner tube and the refrigerant flows through the annular space between them. For minimizing the heat loss, the outer tube is well insulated. Two sight glasses are incorporated into the system, one in the liquid line at the condenser outlet and another in the

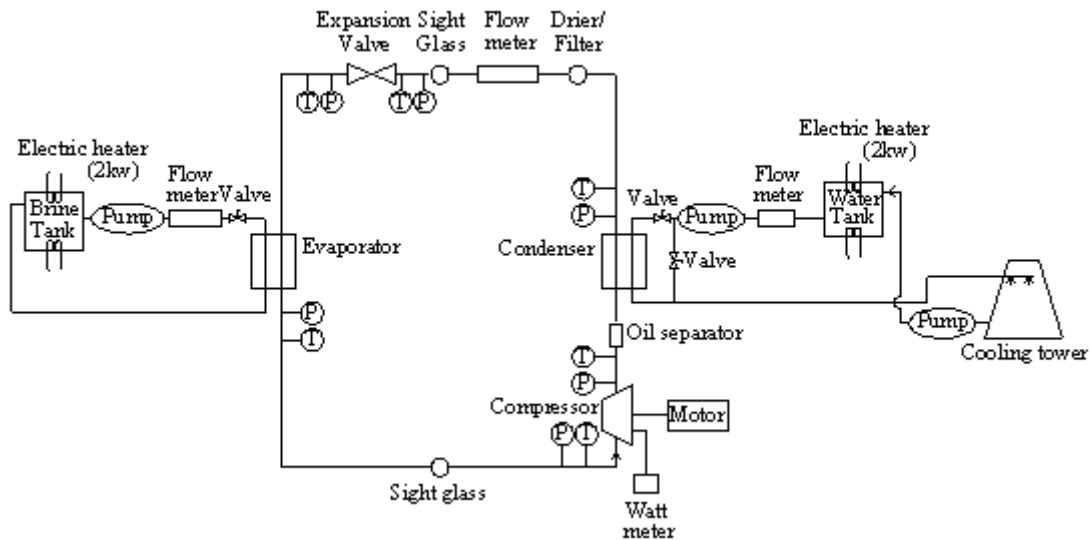

Figure 2. Schematic diagram of the experimental setup.

vapour line at the evaporator outlet in order to give a visual indication of the refrigerant circulation. The secondary loop is composed of a pump, a flow meter and an electrically heated unit within the insulated tank. One tank is filled with cooling water and circulated through the condenser tube while the other tank is filled with brine solution and circulated through the evaporator tube. The hot water coming out of this condenser tube is supplied to a cooling tower and gets cooled. This cooled water is pumped to the cooling water tank through a separate pump.

Rotameters are used to measure the flow rates of the cooling water and brine solution with an accuracy of  $\pm 0.05$  lpm. The refrigerant flow meter is used to measure the refrigerant flow rate with an accuracy of  $\pm 0.0125$  kg/min. RTD type thermocouples are used to measure the temperatures with an accuracy of  $\pm 0.1^\circ\text{C}$  and pressures are measured using calibrated pressure gauges with an accuracy of  $\pm 1$  psi. The temperatures and pressures of the refrigerant and secondary fluid temperature are measured at various locations in the experimental setup as shown in Figure 2. The compressor power consumption is measured using a wattmeter. The accuracy of rotation of wattmeter disc is  $\pm 1$  sec for 10 revolutions. An expansion device is used to regulate the mass flow rate of refrigerant and to set pressure difference. The refrigerant is charged after the system had been evacuated. Drop-in experiments are carried out without any modifications to the experimental apparatus. The experiment is started with R12 to set up the base reference for further comparisons with the other two refrigerants. The desired evaporating and condensing temperatures are obtained by adjusting all the other

parameters in the system such as cooling water flow rate and its temperature, refrigerant flow rate and brine solution flow rate and its temperature. The readings are taken after the system had reached steady state conditions and all observed values are recorded. Table 2 shows the observed values from the experimental setup for the parameter level at zero and  $T_e = -8^\circ\text{C}$ ,  $T_c = 40^\circ\text{C}$  and  $N = 855$  rpm.

Figure 3 shows the vapour compression refrigeration cycle for refrigerants R12, R134a and R290/R600 on P-H and T-S diagrams.

#### 4. Development of Statistical Models

The independent controllable parameters such as evaporating temperature ( $T_e$ ), condensing temperature ( $T_c$ ) and compressor speed ( $N$ ) are identified to carry out the experimental work. The upper limit of a parameter is coded as +1.682 and the lower limit as -1.682. The coded values for the intermediate values which are taken as levels are calculated from the Eq. (1) (Cohran & Cox, 1992).

$$X_i = 1.682 [2X - (X_{\max} + X_{\min})] / (X_{\max} - X_{\min}) \quad (1)$$

Where  $X_i$  is the required coded value of a variable  $X$ .  $X$  is any value of the variable from  $X_{\min}$  to  $X_{\max}$ .  $X_{\min}$  and  $X_{\max}$  are the lower and upper limits of the variable  $X$ , respectively. The decided levels of the selected refrigeration system parameters with their units and notations are given in Table 3.

Table 2. Observed values from the experimental setup for Level = 0,  $T_e = -8^\circ\text{C}$ ,  $T_c = 40^\circ\text{C}$  and  $N = 855$  rpm.

Refrigerants	Main cycle parameters			Secondary loop parameters						RC (kW)	PC (kW)	COP
	Compressor discharge pressure (bar)	Compressor discharge temperature ( $^\circ\text{C}$ )	Refrigerant flow rate (kg/min)	Brine solution		Water		flow rate (lpm)	Temperatures			
				Flow rate (lpm)	Temperatures	Inlet ( $^\circ\text{C}$ )	Outlet ( $^\circ\text{C}$ )					
R12	12.4	86	0.2625	2.7	21	16	1.7	33	39	0.87	0.53	1.65
R134a	12.2	84	0.275	1.5	11	4	1.5	32	39	0.85	0.52	1.64
R290/R600	13	77	0.2875	2.7	20	11.5	1.8	29	38	1.35	0.68	1.99

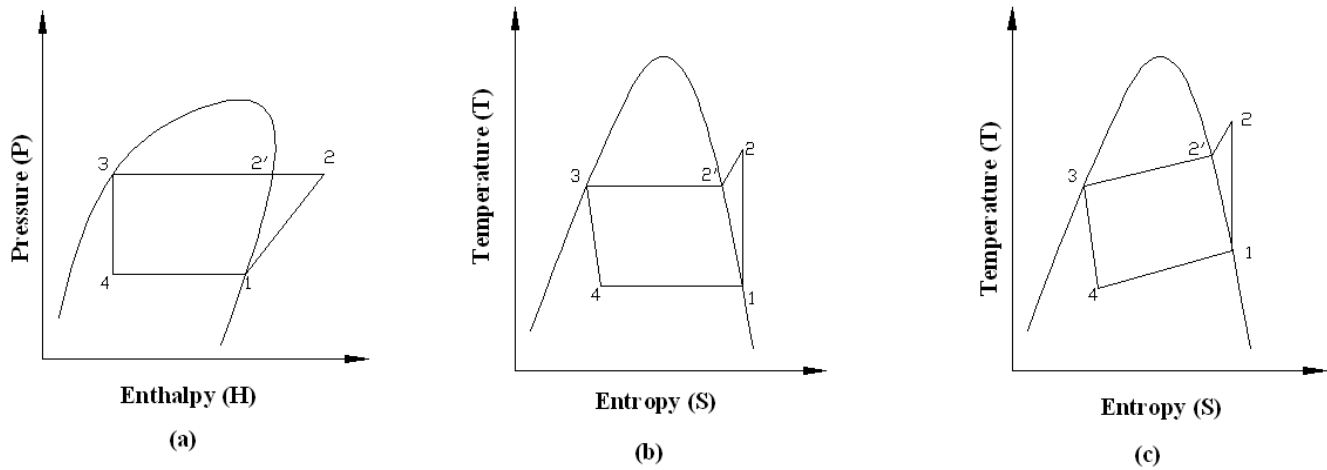

Figure 3. P-H and T-S diagram for the vapour compression refrigeration cycle: (a) P-H diagram for R12, R134a and R290/R600 (b) T-S diagram for R12 and R134a (c) T-S diagram for R290/R600.

Table 3. Control parameters and its levels

Parameters	Unit	Notation	Parameter levels				
			-1.682	-1	0	1	1.682
Evaporating temperature	°C	$T_e$	-18	-14	-8	-2	2
Condensing temperature	°C	$T_c$	32	35	40	45	48
Compressor speed	rpm	N	552	675	855	1035	1157

The design matrix is developed consisting of three factors and five levels central composite rotatable design (Cohran & Cox, 1992). It is composed of a full replication of  $2^3 = 8$  factorial design plus 6 centre points and 6 star points. The selected design matrix is shown in Table 4.

The experiments are conducted according to the design matrix at random to avoid systematic errors creeping into

the system. The data obtained from these experiments are used to develop the statistical models and analyze the performance of the refrigerants R12, R134a and R290/R600 mixture. The response function representing any of the refrigeration system output can be expressed as given in Eq. (2).

$$Y = f(T_e, T_c, N) \quad (2)$$

The second order polynomial (regression) equation used to represent the response function for three factors is given by the Eq. (3).

$$Y = b_0 + b_1T_e + b_2T_c + b_3N + b_{11}T_e^2 + b_{22}T_c^2 + b_{33}N^2 + b_{12}T_eT_c + b_{13}T_eN + b_{23}T_cN \quad (3)$$

Table 4. Design matrix and calculated responses of refrigeration system

Sl.No	Design matrix			Responses of refrigerant								
				R12			R134a			R290/R600		
	$T_e$	$T_c$	N	RC	PC	COP	RC	PC	COP	RC	PC	COP
1	-1	-1	-1	0.53	0.34	1.57	0.56	0.39	1.43	0.74	0.46	1.61
2	1	-1	-1	0.74	0.52	1.43	0.67	0.52	1.29	1.27	0.69	1.85
3	-1	1	-1	0.42	0.41	1.04	0.45	0.42	1.07	0.53	0.47	1.12
4	1	1	-1	0.64	0.53	1.19	0.56	0.51	1.1	1.06	0.71	1.49
5	-1	-1	1	1.24	0.51	2.41	1.11	0.51	2.17	1.44	0.55	2.62
6	1	-1	1	1.44	0.67	2.14	1.46	0.7	2.08	2.23	0.85	2.63
7	-1	1	1	1.03	0.53	1.94	0.95	0.52	1.82	1.24	0.59	2.06
8	1	1	1	1.24	0.71	1.74	1.28	0.7	1.82	1.8	0.89	2.01
9	-1.682	0	0	0.72	0.36	1.96	0.58	0.4	1.45	0.79	0.42	1.89
10	1.682	0	0	1.03	0.67	1.54	0.89	0.66	1.36	1.41	0.82	1.72
11	0	-1.682	0	1.03	0.53	1.95	0.87	0.56	1.57	1.43	0.65	2.19
12	0	1.682	0	0.8	0.55	1.44	0.75	0.56	1.33	1.11	0.73	1.52
13	0	0	-1.682	0.35	0.4	0.88	0.28	0.39	0.72	0.64	0.55	1.16
14	0	0	1.682	1.53	0.69	2.22	1.53	0.66	2.34	2.24	0.8	2.79
15	0	0	0	0.87	0.53	1.65	0.85	0.52	1.64	1.35	0.68	1.99
16	0	0	0	0.87	0.53	1.64	0.85	0.52	1.63	1.35	0.67	2.01
17	0	0	0	0.87	0.53	1.65	0.85	0.52	1.62	1.35	0.67	2.01
18	0	0	0	0.87	0.53	1.66	0.85	0.52	1.63	1.35	0.67	2.02
19	0	0	0	0.87	0.54	1.63	0.85	0.52	1.62	1.35	0.68	2
20	0	0	0	0.87	0.53	1.64	0.85	0.52	1.64	1.35	0.67	2

Table 5. Analysis of variance for testing adequacy of models for R12, R134a and R290/R600

Refrigerants	System responses	Sum of squares		Degrees of freedom		Mean square		F-ratio <sup>a</sup>	Remarks
		regression	residual	regression	residual	regression	residual		
R12	RC	1.778	0.002	9	10	0.198	0.000	845.03	adequate
	PC	0.195	0.002	9	10	0.022	0.000	125.65	adequate
	COP	2.671	0.034	9	10	0.297	0.003	86.67	adequate
R134a	RC	1.843	0.026	9	10	0.205	0.003	78.89	adequate
	PC	0.161	0.000	9	10	0.018	0.000	687.38	adequate
	COP	2.625	0.128	9	10	0.292	0.013	22.75	adequate
R290/R600	RC	3.672	0.084	9	10	0.408	0.008	48.79	adequate
	PC	0.308	0.001	9	10	0.034	0.000	345.89	adequate
	COP	3.515	0.095	9	10	0.391	0.010	41.05	Adequate

<sup>a</sup>F-ratio (9, 10, 0.05) = 3.02.

The values of the coefficients of the polynomial are calculated by regression (Cohran & Cox, 1992) with the help of Eqs. (4)-(7).

$$b_0 = 0.1663\Sigma(Y) - 0.0568\Sigma(X_{ii}Y) \quad (4)$$

$$b_i = 0.0732\Sigma(X_iY) \quad (5)$$

$$b_{ii} = 0.0625\Sigma(X_{ii}Y) + 0.00689\Sigma(X_{ii}Y) - 0.0568\Sigma(Y) \quad (6)$$

$$b_{ij} = 0.1250\Sigma(X_{ij}Y) \quad (7)$$

where  $X_i$ ,  $X_{ii}$ ,  $X_{ij}$  are the values of first order, second order square and interaction terms of the refrigeration system variables, respectively.

A SYSTAT software package is used to calculate the values of these coefficients for direct responses. The adequacies of the models are tested using analysis of variance technique (ANOVA). As per this technique, if the calculated value of the F-ratio of the model developed exceeds the standard tabulated value of F-ratio for a desired level of confidence (95%), then the model is considered adequate within the confidence limit. It has been found from Table 5 that all models are adequate.

The calculation of F-ratio is given by

$$F\text{-ratio} = \frac{\text{Mean sum of squares for regression}}{\text{Mean sum of squares for error}} \quad (8)$$

The squared multiple R values, adjusted squared multiple R values and standard error of estimates for all the developed statistical models are given in Table 6. Squared multiple R is the ratio of the sum of squares explained by a regression model to the total sum of squares around the mean.

Adjusted squared multiple R is the multiple correlation coefficient after adjusted for shrinkage and Standard error of estimate is the standard deviation of the residuals. The statistical models with parameters in coded form for R12, R134a and R290/R600 mixture, developed by the above analysis are represented in the following Eqs. (9)-(17):

For refrigerant R12

$$RC = 0.875 + 0.1N - 0.075 T_c + 0.337 T_e - 0.001N^2 + 0.013T_c^2 + 0.023 T_e^2 - 0.001T_e * N + 0.001T_c * N - 0.025T_c * T_e \quad (9)$$

Table 6. Comparison of squared multiple R, Adjusted squared multiple R and Standard error of estimate for the developed models.

Refrigerants	Response	Squared multiple R	Adjusted Squared multiple R	Standard error of estimate
R12	RC	0.999	0.998	0.015
	PC	0.991	0.983	0.013
	COP	0.987	0.976	0.059
R134a	RC	0.986	0.974	0.051
	PC	0.998	0.997	0.005
	COP	0.953	0.912	0.113
R290/R600	RC	0.978	0.958	0.091
	PC	0.997	0.994	0.010
	COP	0.987	0.950	0.098

$$PC = 0.532 + 0.086N + 0.013T_c + 0.082T_e - 0.006N^2 + 0.002T_c^2 + 0.004T_e^2 - 0.004T_c * N + 0.004T_e * N - 0.003 T_c * T_e \quad (10)$$

$$COP = 1.645 - 0.086N - 0.183T_c + 0.385T_e + 0.04N^2 - 0.03T_e^2 - 0.022T_c^2 + 0.044T_c * N - 0.059T_e * N - 0.014T_c * T_e \quad (11)$$

For refrigerant R134a

$$RC = 0.846 + 0.104N - 0.056T_c + 0.342T_e - 0.025N^2 + 0.034T_e^2 + 0.001T_c^2 + 0.056T_e * N - 0.003T_c * N - 0.015T_c * T_e \quad (12)$$

$$PC = 0.521 + 0.074N + 0.003T_c + 0.077T_e + 0.013T_c^2 + 0.002N^2 + 0.001T_e^2 - 0.006T_c * N + 0.018T_e * N - 0.001T_c * T_e \quad (13)$$

$$COP = 1.597 - 0.114T_c + 0.418T_e - 0.025N - 0.044N^2 - 0.032T_c^2 - 0.006T_e^2 + 0.032T_c * N + 0.003T_e * N - 0.007T_c * T_e \quad (14)$$

For refrigerant R290/R600

$$RC = 1.351 + 0.253N - 0.116T_c + 0.425T_e - 0.083N^2 + 0.035T_e^2 - 0.023T_c^2 + 0.036T_e * N - 0.027T_c * N - 0.026T_c * T_e \quad (15)$$

$$PC = 0.674 + 0.128N + 0.019T_c + 0.072T_e + 0.005T_c^2 - 0.020N^2 - 0.001T_e^2 + 0.002T_c*N + 0.016T_e*N + 0.008T_c*T_e \quad (16)$$

$$COP = 2.005 + 0.018N - 0.230T_c + 0.440T_e - 0.060N^2 - 0.043T_c^2 - 0.001T_e^2 + 0.008T_c*N - 0.082T_e*N - 0.042T_c*T_e \quad (17)$$

## 5. Results and Discussion

From the developed statistical models, the direct effects  $T_e$ ,  $T_c$  and  $N$  on vapour compression refrigeration system parameters are obtained and presented in Figs. 4-12.

### 5.1 Direct Effect of Evaporating Temperature on Refrigerating Capacity, Power Consumption and Coefficient of Performance

Figure 4 shows the variation of the refrigerating capacity ( $RC$ ) for various evaporating temperatures with condensing temperature of  $40^\circ\text{C}$  and compressor speed of 855 rpm. The evaporating temperature in all these cases is measured at the inlet of the evaporator. In the case of mixture this corresponds to the bubble-point temperature. It is observed that as  $T_e$  increases, the refrigerating capacity of the refrigerants is increased. This is due to the increased mass flow rate of the refrigerants as the  $T_e$  increases. The refrigerating capacity of R290/R600 is 49% higher for lower  $T_e$  temperatures and 30% higher for higher  $T_e$  temperatures than that with R12 and R134a. Bilal & Said (2003) and Wongwises et al. (2006) reported that the hydrocarbon mixtures showed a higher cooling capacity than that of R12 and R134a. The increasing percentage of propane in the hydrocarbon mixture reduces the specific volume of the refrigerant vapour. This causes the refrigerant circulated per unit of time and the refrigeration capacity to increase. The  $RC$  of R134a shows a very close match with R12 for all the operating conditions. R290/R600 mixture shows a higher cooling rate than that with R12 and R134a at higher evaporating temperatures. This is due to their higher latent heat of evaporation at higher evaporating temperatures.

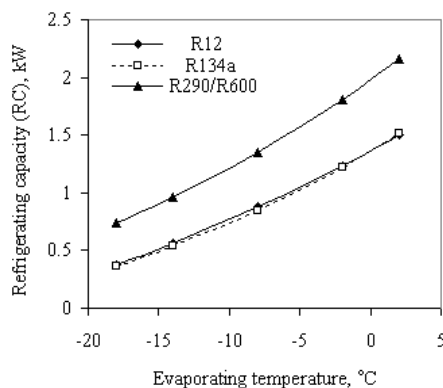

Figure 4. Effect of evaporating temperature on  $RC$ .

The relationship between the power consumption and the evaporating temperature of R12, R134a and R290/R600 mixture is shown in Figure 5. It is found that when the  $T_e$  increases, the power consumed by the compressor increases. This is due to the increased mass flow rate of the refrigerants as the evaporating temperature increases. The

power consumed by the system with R290/R600 mixture is higher by 14%-26.3% for all the operating conditions than that with R12 and R134a. This is due to the higher enthalpy of hydrocarbon mixture than that of R12 and R134a at the same operating conditions. The refrigerant R12 consumed 1.48%-4.1% higher energy than R134a. This is due to the higher viscosity index of polyol ester oil lubricant with R134a compared with traditional mineral oil with R12 (Carpenter, 1992).

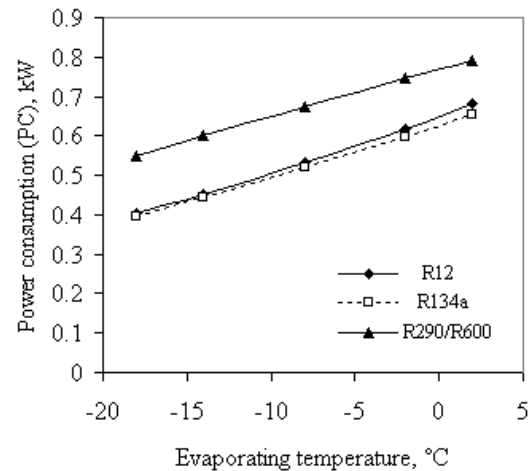

Figure 5. Effect of evaporating temperature on  $PC$ .

Figure 6 shows the coefficient of performance for R12, R134a and R290/R600 mixture for various evaporating temperatures. It is observed that the  $COP$  of R290/R600 mixture is 19.3%-27.9% higher than that of R12. This is due to the higher rate of increase of the refrigerating capacity than that of compressor work. Bilal & Said (2003) and Wongwises et al. (2006) reported that the hydrocarbon mixtures showed a higher performance than that of R12 and R134a. The  $COP$  of R134a is 4% less at lower  $T_e$  and 3.2% higher at  $T_e = 2^\circ\text{C}$  than that with R12.

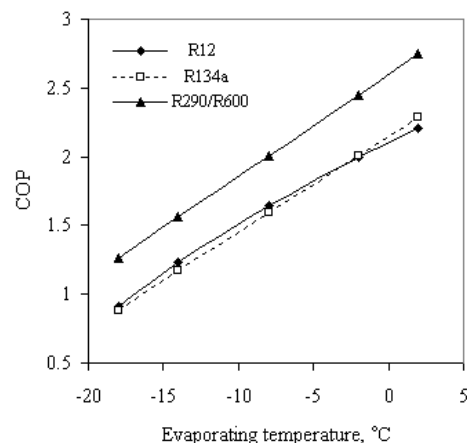

Figure 6. Effect of evaporating temperature on  $COP$ .

### 5.2 Direct Effect of Condensing Temperature on Refrigerating Capacity, Power Consumption and Coefficient of Performance

As  $T_c$  increases, the refrigerating capacity ( $RC$ ) of the refrigerants decreases as shown in Figure 7. It can be seen from the figure that when  $T_c$  increases, the refrigerating capacity decreased because of the reduced flow rate of the refrigerant. The R290/R600 mixture shows a higher  $RC$  for all the condensing temperatures. The  $RC$  of the R290/R600

mixture is 29.7% higher for the lower  $T_c$  and 28% higher for the higher  $T_c$  than that with R12 and R134a. This is due to their higher latent heat of evaporation. For all the operating conditions the RC of R134a is 4% lower than that with R12. This is due to the use of R134a in the existing R12 system without any modification. Carpenter (1992) reported that the cooling performance of a system retrofitted with R134a has shown little change from an existing R12 system.

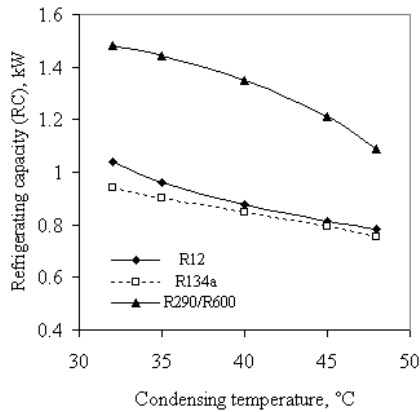

Figure 7. Effect of condensing temperature on RC.

Figure 8 shows the effect of condensing temperature on power consumption. The power consumed by the compressor increases as  $T_c$  increases. This is due to its increased discharge pressure at higher condensing temperature. R290/R600 mixture consumed 21.3%-22.2% higher power than R12 and R134a at all the operating conditions due to the increased work of compression per unit mass. The power consumed by the system with R134a is very close to that of R12.

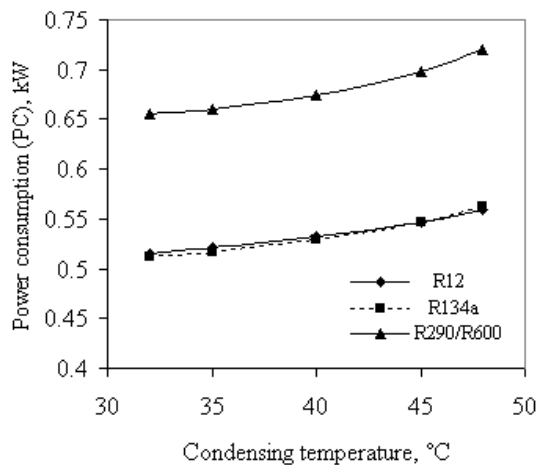

Figure 8. Effect of condensing temperature on PC.

The variation in COP as a function of condensing temperature with  $T_e = -8^\circ\text{C}$  and  $N = 855$  rpm is shown in Figure 9. It is observed that the COP of the refrigerants decreases as the condensing temperature increases. This is due to decrease in refrigerating capacity and increase in compressor work as the  $T_c$  increases. The R290/R600 mixture has 15.3-16.7% higher COP than that with R12. The COP of R134a is less than that of R12 at lower value of  $T_c$  and matches with R12 at the higher condensing temperatures. Bolaji (2010) reported that the COP of R134a is close to that of R12 with 6.6% reductions.

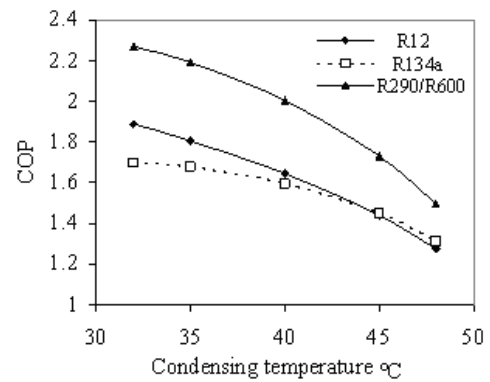

Figure 9. Effect of condensing temperature on COP.

### 5.3 Direct Effect of Compressor Speed on Refrigerating Capacity, Power Consumption and Coefficient of Performance

Figure 10 shows the effect of compressor speed ( $N$ ) on refrigerating capacity. From the figure it is observed that the RC increases as the compressor speed increases. This is due to increased mass flow rate of refrigerants at higher compressor speeds. The RC of R290/R600 mixture is close to R12 at the lower compressor speed of 552 rpm and increases at a faster rate for the higher compressor speeds. The RC of R134a is slightly lower than that of R12 for all the operating conditions

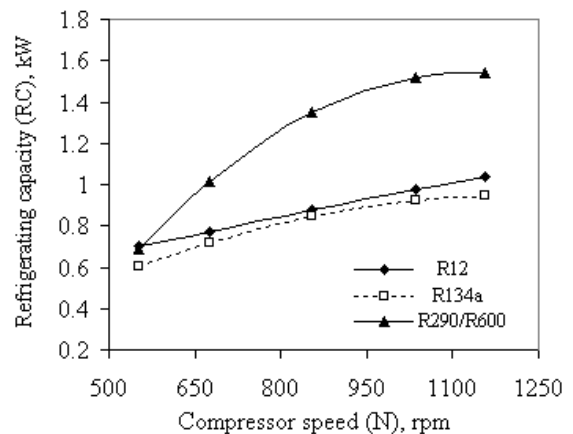

Figure 10. Effect of compressor speed on RC.

Figure 11 shows the variation of power consumed by the compressor at different speeds for R12, R134a and R290/R600. As the compressor speed increases, the mass flow rate of the refrigerant increases causing compressor work to increase. R290/R600 mixture consumed 8-20.6% higher power than that of R12. This is due to increased mass flow rate and discharge pressure of the refrigerant. R134a consumed 7.9% higher power than that of R12 at the lower compressor speed of 552 rpm and R12 consumed 2% higher power than that of R134a at higher speeds.

Figure 12 shows the variation of COP for various compressor speed with  $T_c = 40^\circ\text{C}$  and  $T_e = -8^\circ\text{C}$ . The COP of R12 is higher than R134a and decreases as the compressor speed increases. This is because the compressor work increases more than the refrigerating capacity. The COP of R12 and R134a closely matches with the compressor speed of 855 rpm. For refrigerants R134a and R290/R600, the COP increases up to the compressor speed of 855 rpm and then decreases at higher compressor speeds because the compressor work is less than the rate of increase of refrigerating capacity at higher compressor

speeds. The *COP* of R290/R600 mixture varies from 1.83 to 2 for all the operating conditions and is higher than that with R12 and R134a. This is due to the increased refrigerating capacity of R290/R600 than that of R12 and R134a.

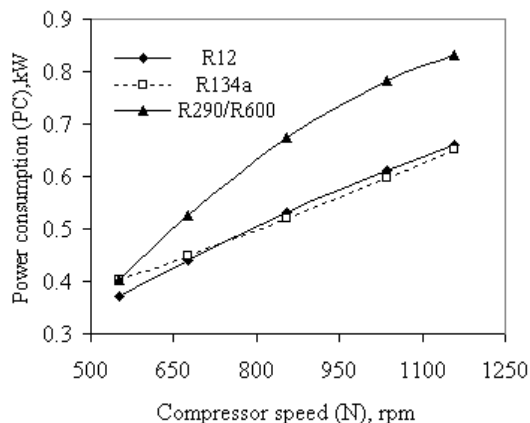

Figure 11. Effect of compressor speed on PC.

#### 5.4 Interaction Effect of $T_e$ , $T_c$ and $N$ on RC for Refrigerants R12, R134a and R290/R600 using 3D plot

Figure 13 shows the interaction effect of  $T_e$ ,  $T_c$  and  $N$  on RC for Refrigerants R12, R134a and R290/R600 and the following observations are made.

(i) It is evident that as evaporating temperature  $T_e$  increases, the RC of the refrigerants is increased. This is due to the increased mass flow rate of the refrigerants as the  $T_e$  increases.

(ii) It is found that as condensing temperature  $T_c$  increases, the RC of the refrigerants is decreased. This is due to the reduced mass flow rate of the refrigerants as the  $T_c$  increases

(iii) It is observed that as compressor speed  $N$  increase, the RC of the refrigerants is increased. This is due to the increased mass flow rate of the refrigerants at higher compressor speeds.

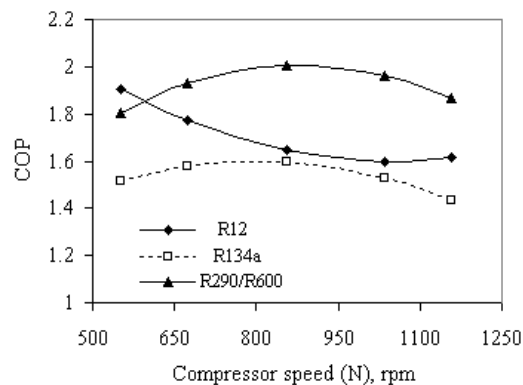

Figure 12. Effect of compressor speed on COP.

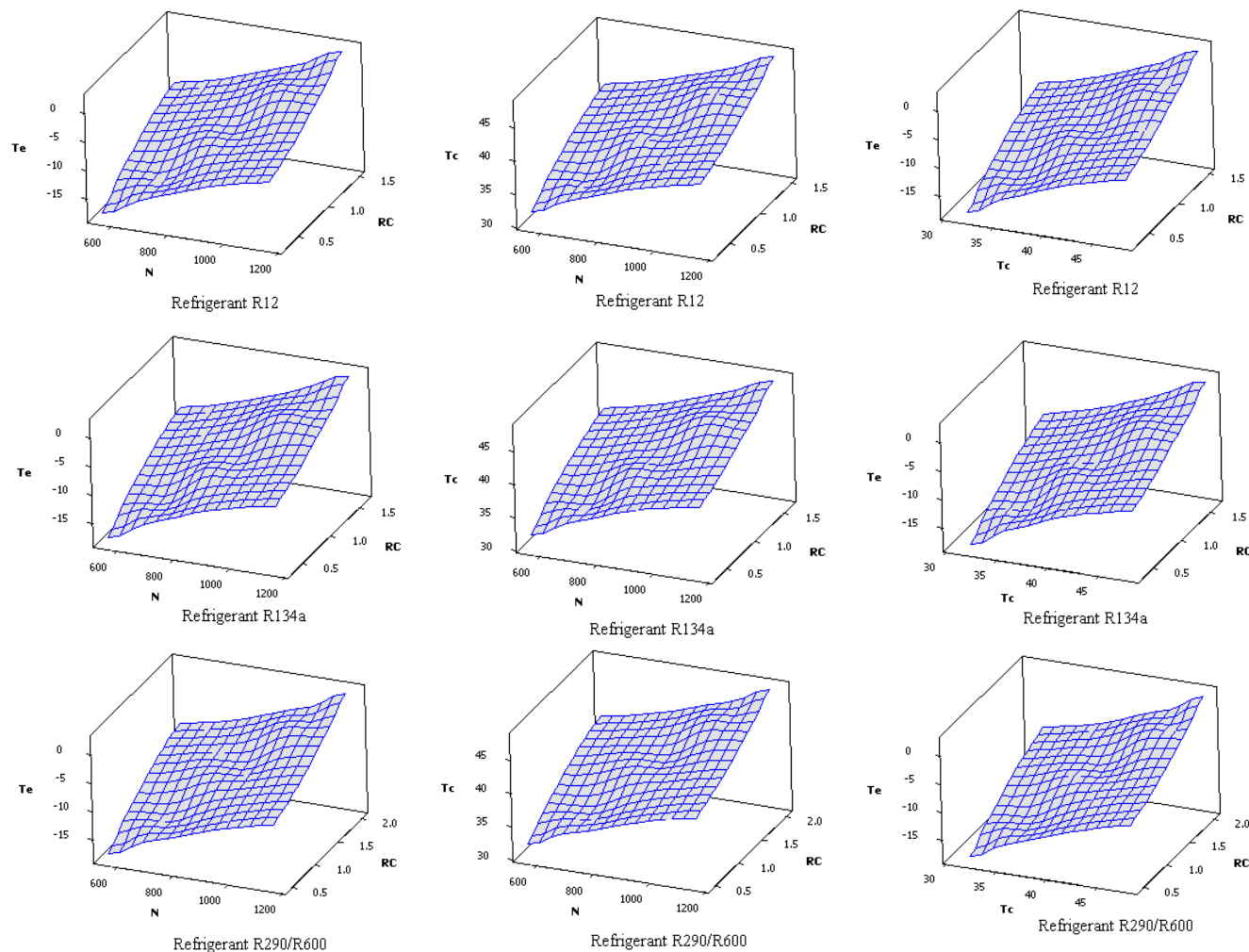

Figure 13. Interaction effect of  $T_e$ ,  $T_c$  and  $N$  on RC for R12, R134a and R290/R600.



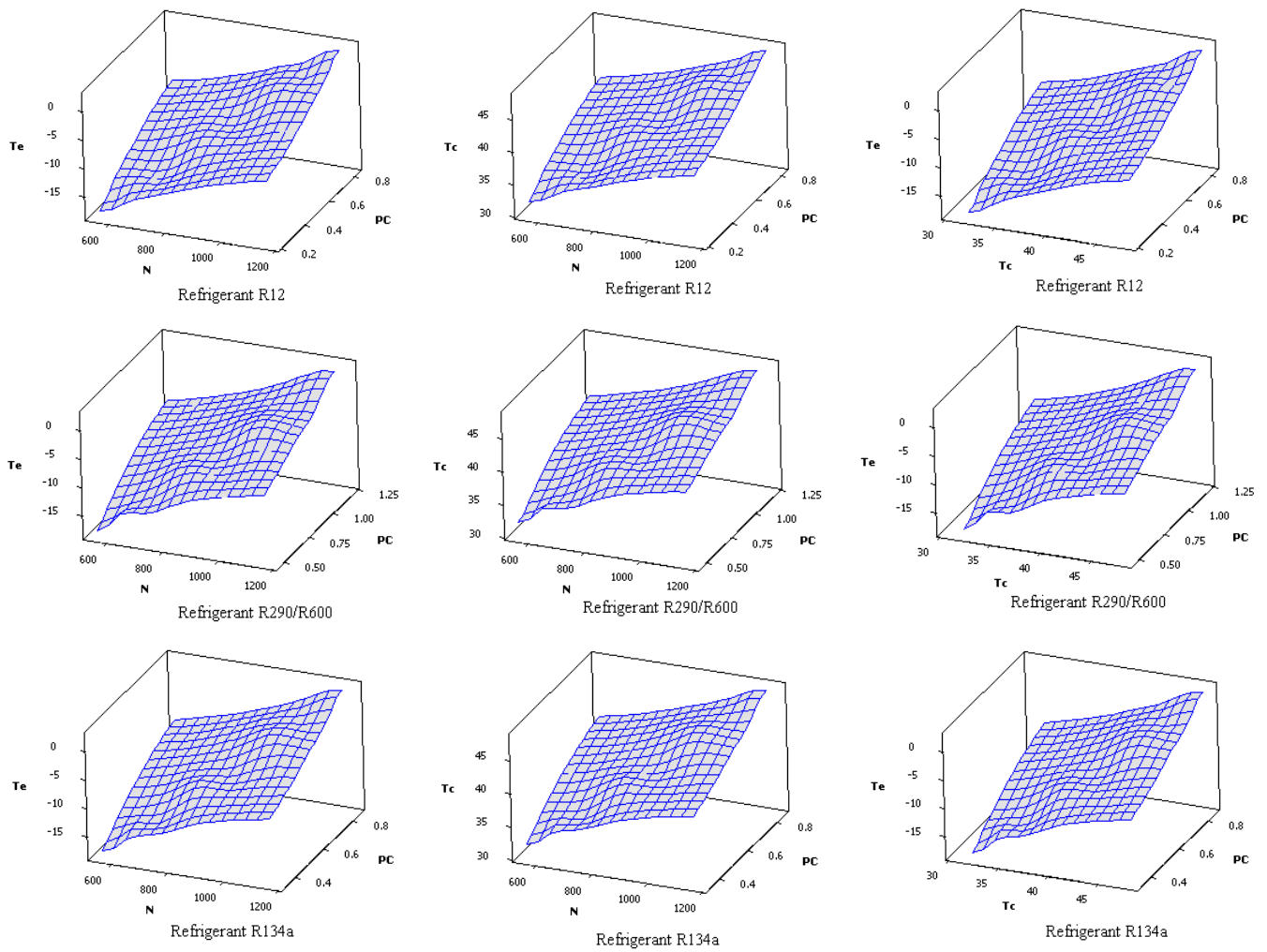

Figure 14. Interaction effect of  $T_e$ ,  $T_c$  and  $N$  on  $PC$  for R12, R134a and R290/R600.

### 5.5 Interaction Effect of $T_e$ , $T_c$ and $N$ on $PC$ for Refrigerants R12, R134a and R290/R600

Figure 14 shows the interaction effect of  $T_e$ ,  $T_c$  and  $N$  on  $PC$  for Refrigerants R12, R134a and R290/R600 and the following observations are made.

- (i) It is evident that as  $T_e$  increases, the power consumed by the compressor is increased. This is due to the increased mass flow rate of the refrigerants as  $T_e$  increases.
- (ii) It is found that the power consumed by the compressor increased as the  $T_c$  increases. This is due to the increased discharge pressure at higher condensing temperatures.
- (iii) It is observed that the power consumed by the compressor increased as the compressor speed ( $N$ ) increases. This is because as  $N$  increases, the mass flow rate of the refrigerant increases causing compressor work to increase.

### 5.6 Interaction Effect of $T_e$ , $T_c$ and $N$ on $COP$ for Refrigerants R12, R134a and R290/R600

Figure 15 shows the interaction effect of  $T_e$ ,  $T_c$  and  $N$  on  $COP$  for Refrigerants R12, R134a and R290/R600 and the following observations are made.

- (i) It is evident that as the  $T_c$  increases, the  $COP$  of the refrigerants is increased. This is due to the increased refrigerating capacity of the refrigerants than that of the

work consumed by the compressor for each of the refrigerants and for all the evaporating temperatures.

- (ii) It is found that as the  $T_c$  is increases, the  $COP$  of the refrigerants is decreased. This is because of the increased rate of compressor work at higher condensing temperatures than that of the refrigerating capacity.
- (iii) It is observed that as the  $N$  increases, the  $COP$  increases up to the middle value of  $N$  and then  $COP$  decreases as the value of  $N$  increases. This is because the compressor work is less than the rate of increase of refrigerating capacity at higher compressor speeds

### 6. Conclusions

Experiments are conducted using R12, R134a and R290/R600 mixture refrigerants. In this work the following conclusions are made.

\*A five level factorial experimentation technique is employed for developing statistical models and the performance of R12, R134a and R290/R600 (79/21 by wt %) mixture are compared.

\* The refrigerating capacity of R290/R600 (79/21 by wt %) is 49% higher for lower  $T_e$  temperatures and 30% higher for higher  $T_e$  than that with R12 and R134a

\*R290/R600 mixture consumed 21.3%-22.2% higher power than R12 and R134a at all the operating conditions due to the increased work of compression

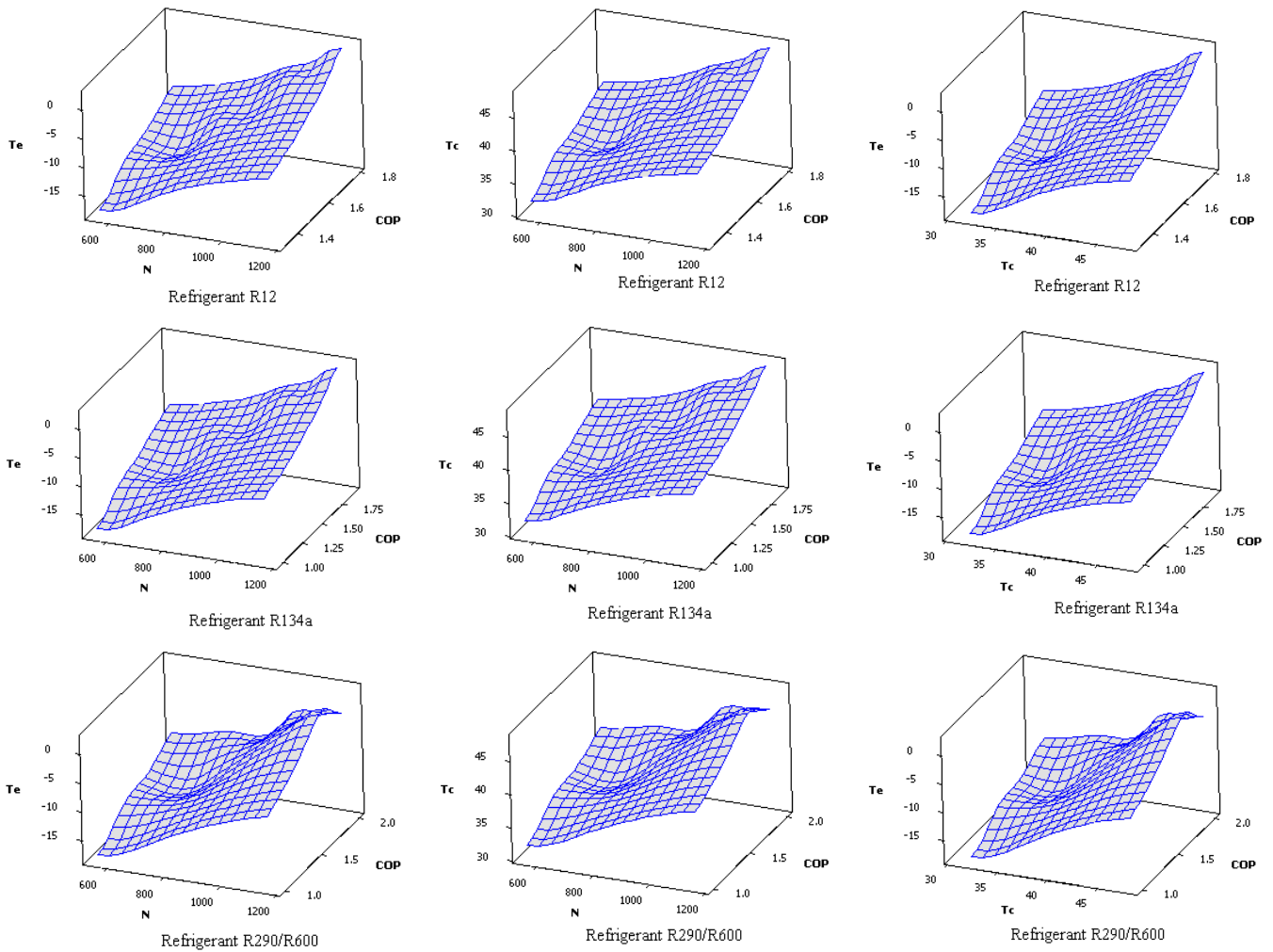

Figure 15. . Interaction effect of  $T_e$ ,  $T_c$  and  $N$  on COP for R12, R134a and R290/R600.

\* The COP of R290/R600 (79/21 by wt %) mixture is 19.3%-27.9% higher than that of R12 and the COP of R134a is close to that of R12 for the range of evaporating temperatures.

\*Interaction effects of  $T_e$ ,  $T_c$  and  $N$  on RC, PC and COP for the refrigerants R12, R134a and R290/R600 are discussed using 3D plots.

\* The investigated hydrocarbon mixture R290/R600 (79/21 by wt %) can be used as a possible alternative refrigerant for R12 and R134a.

#### Nomenclature

CFC	chlorofluorocarbon
HCFC	hydrochlorofluorocarbon
HFC	hydrofluorocarbon
HC	hydrocarbon
ODP	ozone depletion potential
GWP	global warming potential
RC	refrigerating capacity (kW)
COP	coefficient of performance
PC	power consumption (kW)

#### Subscripts

c	condensing/ condenser
e	evaporating/ evaporator

#### References

- Baskin, E. (1998). TECHNICAL PAPERS-4206-Synopsis of Residential Refrigerator/Freezer Alternative Refrigerants Evaluation. *ASHRAE Transactions-American Society of Heating Refrigerating Air Conditioning Engin*, 104(2), 266-273.
- Bilal A. Akash., & Salem A. Said. (2003). Assessment of LPG as a Possible Alternative to R12 in Domestic Refrigerators. *Energy conversion and Management*, 44, 381- 388.
- Bolaji, B.O. (2010). Experimental Study of R152a and R32 to Replace R134a in a Domestic Refrigerator. *Energy*, 35, 3793-3798.
- Bolaji, B.O. (2010). Experimental Analysis of Reciprocating Compressor Performance with Eco-friendly Refrigerants. *Proceedings of the Institution of Mechanical Engineers, Part A: Journal of Power and Energy*, 224, 781-786.
- Boumaza, M. (2010). Performance Assessment of Natural Refrigerants as Substitutes to CFC and HCFC in Hot Climate. *Int. J. of Thermal & Environmental Engineering*, 1, 125-130.
- Butler, D. (2001). Life After CFCs and HCFCs, *CIBSE National Conference*, Regents College, London, 1-3.

- Carpenter, N.E. (1992). Retrofitting HFC-134a into Existing CFC12 systems. *Int. J. of Refrigeration*, 15, 332-339.
- Chen, J. (2005). Zeotropic Refrigerants and the Special Characteristics. *Proceedings of the IMechE part E, Journal of Process Mechanical Engineering*, 219, 183-186.
- Cochran, W. G. & Cox, G. M. (1992). *Experimental Designs*, (2<sup>nd</sup> ed.). New York, John Wiley and Sons.
- Devotta, S., & Gopichand, S. (1992). Comparative Assessment of HFC 134a and Some Refrigerants as Alternatives to CFC 12. *Int. J. of Refrigeration*, 15, 112-118.
- Fatouh, M., & Kafafy, M.E. (2006). Experimental Evaluation of a Domestic Refrigerator Working with LPG. *Applied Thermal Engineering*, 26, 1593-1603.
- Granryd, E. (2001). Hydrocarbons as Refrigerants – an Overview. *Int. J. of Refrigeration*, 24, 15-24.
- Hammad, M.A., & Alsaad, M.A. (1999). The use of Hydrocarbon Mixture as Refrigerants in Domestic Refrigerators. *Applied Thermal Engineering*, 19, 1181-1189.
- Jung, D., Kim, C. B., Lim, B. H., & Lee, H. W. (1996). Testing of a hydrocarbon mixture in domestic refrigerators. *ASHRAE Transactions*, 102(1), 1077-1084.
- Jung, D., Kim, C., Song, K., & Park, B. (2000). Testing of Propane/Isobutene Mixture in Domestic Refrigerators. *International Journal of Refrigeration*, 23, 517- 527.
- Kuijpers, L. J. M., De Wit, J. A., & Janssen, M. J. P. (1988). Possibilities for the Replacement of CFC 12 in Domestic Equipment. *Int. J. of Refrigeration*, 11(4), 284-291.
- Rajapaksha, L. (2007). Influence of special attributes of zeotropic refrigerant mixtures on design and operation of vapour compression refrigeration and heat pump systems. *Energy conversion and management*, 48(2), 539-545.
- Richard, R. G., & Shankland, I. R. (1992). Flammability of alternative refrigerants. *ASHRAE journal*, 34(4), 20-24.
- Richardson, R.N., & Butterworth, J.S. (1995). The Performance of Propane/Isobutane Mixtures in a Vapour Compression Refrigeration System, *Int. J. of Refrigeration*, 18, 58-62.
- Ritter, T.J. (1996). Flammability-Hydrocarbon Refrigerants. *Proceedings of the Institute of Refrigeration Conference, Safe and Reliable Refrigeration*, London.
- Thermodynamic Properties of Refrigerants and Refrigerant Mixtures. (2002). NIST Standard Reference Database version 7.0. Gaithersburg.
- Wongwises, S., Kamboon, A. & Orachon, B. (2006). Experimental Investigation of Hydrocarbon Mixtures to Replace HFC-134a in an Automotive Air Conditioning System. *Energy Conversion and Management*, 47, 1644-1659.