



## COMPARATIVE ANALYSIS OF CASCADE REFRIGERATION SYSTEMS' PERFORMANCE and ENVIRONMENTAL IMPACTS

Ebru Mançuhan<sup>a\*</sup>, Barış Tunç<sup>a</sup>, Kübra Yetkin<sup>a</sup>, Cem Çelik<sup>b</sup>

<sup>a</sup> Faculty of Engineering, Chemical Engineering Department, Marmara University, 34722, İstanbul Turkey

<sup>b</sup> Faculty of Engineering, Mechanical Engineering Department, Marmara University, 34722, İstanbul Turkey

**Abstract:** The aim of our study is to propose a theoretical model to analyze the energy efficient and environment friendly cascade system for various refrigerant pairs. In order to realize, the optimum cascade evaporation temperature ( $T_{OPT,CAS,E}$ ) which maximize the performance, coefficient of performance (COP) values are determined for different refrigerant pairs of the system. After the optimization, two different cases have been investigated through a thermodynamic analysis to discover the best refrigerant pair for the system. Natural refrigerant  $CO_2$  is selected instead of R404A which has high Global Warming Potential (GWP) value for the low temperature cycle (LTC). On the other hand, synthetic refrigerants (R134a, R152a) and a natural refrigerant ( $NH_3$ ) are chosen for the high temperature cycle (HTC). In order to determine, energy efficient and environmentally friendly cascade system, R134a/ $CO_2$ , R152a/ $CO_2$  and  $NH_3$ / $CO_2$  refrigerant pairs are investigated in Case 1. On the other hand, R134a/R404A, R152a/R404A and  $NH_3$ /R404A refrigerant pairs are investigated in Case 2. In calculations, the evaporation temperature ( $T_E$ ) is varied from -20 °C to -40 °C in LTC. The condensation temperature ( $T_C$ ) is considered to be between 30 °C and 45 °C in HTC. Mass flow rate requirements of systems for various refrigeration capacities ( $Q_{Evap}$ ) are calculated for different refrigerant pairs. Moreover, the  $COP_{max}$  and total equivalent warming impact (TEWI) values of the system's refrigerant pairs are evaluated and compared for various operating conditions.

**Keywords:** Cascade system, Optimization, TEWI, COP, Refrigerant pairs.

**Submitted:** November 12, 2018. **Accepted:** March 13, 2019.

**Cite this:** Mançuhan E, Tunç B, Yetkin K, Çelik C. COMPARATIVE ANALYSIS OF CASCADE REFRIGERATION SYSTEMS' PERFORMANCE and ENVIRONMENTAL IMPACTS. JOTCSB. 2019;2(2):97-108.

**\*Corresponding author. E-mail:** [emancuhan@marmara.edu.tr](mailto:emancuhan@marmara.edu.tr).

### INTRODUCTION

Cascade refrigeration systems have been widely used in commercial and industrial applications. The system incorporates two or more refrigeration cycles with relevant refrigerants. An appropriate selection of refrigerants to operate the LTC and HTC should be made in order to obtain high COP values, besides reducing the refrigerants' impact on the environment during operation, leakage and recharge. Therefore, it is important to improve the energy efficiency of

cascade systems using different refrigerant pairs and to determine their total contribution to global warming. For this purpose, the COP and TEWI values are calculated and compared for various refrigerant pairs of the cascade system (1-4).

In the previous studies, there are few theoretical and experimental studies to evaluate the alternative refrigerants with respect to performance and environmental considerations in refrigeration applications (1-7). Llopis et al. (1) presented the

experimental evaluation of refrigerants R404A and R507A in the double-stage refrigeration plant. They concluded that the performance of R404A system is considerably higher than R507A system's when the plant operates without inter-stage system at low evaporation temperatures. Kilicaslan and Hosoz, (2) determined and compared the COP and irreversibility values of the cascade system with various refrigerant pairs such as R152a/R23, R290/R23, R507/R23, R717/R23, R404a/R23. They reported that refrigerant pair R717/R23 is the best for the cascade systems among all selected pairs. If there are some limitations for the use of the natural refrigerants, the pair R152a/R23 is the best solution. Cabello et al. (3) performed an experimental comparison of a cascade refrigeration plant with the refrigerant pairs R134a/R744 and R152a/R744 under a wide range of operating conditions. They concluded that the high GWP refrigerant (R134a) can be replaced with the low GWP refrigerant (R152a) in accordance with the new environmental regulations. As a result, the replacement of R134a with R152a is technically and energetically feasible. Oruç et al. (4) investigated experimentally a refrigeration system using low GWP alternative refrigerants of R453A and R442A as drop in replacements for R404A. Using R453A and R442A as alternatives for R404A reduced the GWP by %55 and %52. In addition, the alternative refrigerants could be directly used in a system constructed to operate with R404A. Baakem et al. (5) performed energy, exergy and economic analyses of a multistage refrigeration system using Engineering Equation Solver (EES) software. In this theoretical study, they examined eight different refrigerants such as R717, R22, R134a, R1234yf, R1234ze, R410A, R404A and R407C. The maximum COP (6.17) was calculated for R717 system whereas the minimum COP value (4.95) was calculated for R407C. It was found that the best alternative was R717, compared to the other refrigerants. Vaghela (6) examined theoretically the different alternative refrigerants such as R290, R600a, R407C, R410A, R404A, R152a and R1234yf as a drop in replacement of R134a. As a result of the

thermodynamic analysis, R1234yf is determined to be the best suitable alternative refrigerant to replace R134a. It has very low GWP although it causes lower COP values compared to R134a. Karampour and Savalla (7) identified the most promising solutions of CO<sub>2</sub> trans-critical booster systems. They determined that the state-of-the-art integrated CO<sub>2</sub> systems are energy efficient, environmentally friendly and compact solutions which provide the whole thermal demands of supermarkets in cold and warm climates.

### CASCADE REFRIGERATION SYSTEM

Some industrial applications require moderately low temperatures and the temperature range between high and low temperatures may be too large for a single refrigeration cycle. Moreover, a large temperature range means that a large pressure range in the cycle and poor performance for a compressor. In these conditions, the refrigeration process is performed in stages, namely, to have two or more refrigeration cycles operate in series. These refrigeration cycles are called cascade refrigeration cycles (8). The cascade system is principally two single vapor compression cycles that are integrated by a heat exchanger. In this study, the upper cycle utilizes R134a, R152a and NH<sub>3</sub> and rejects heat to the ambient air at high temperature ( $T_H$ ). The lower cycle uses CO<sub>2</sub> or R404A and absorbs heat from the refrigerated space at low temperature ( $T_L$ ). Figure 1a displays a schematic view of the cascade system. The lower cycle rejects heat to the upper cycle in the cascade heat exchanger. The cascade heat exchanger functions as an evaporator for the HTC and a condenser for the LTC. As shown in the T-s diagram in Figure 1b, there are the evaporation and condensation temperatures. These temperatures depend on the refrigerated space and ambient conditions. Moreover, in a cascade system, there are two additional temperatures being the condensation temperature of the LTC ( $T_{CAS,C}$ ) and the evaporation temperature of the HTC ( $T_{CAS,E}$ ).

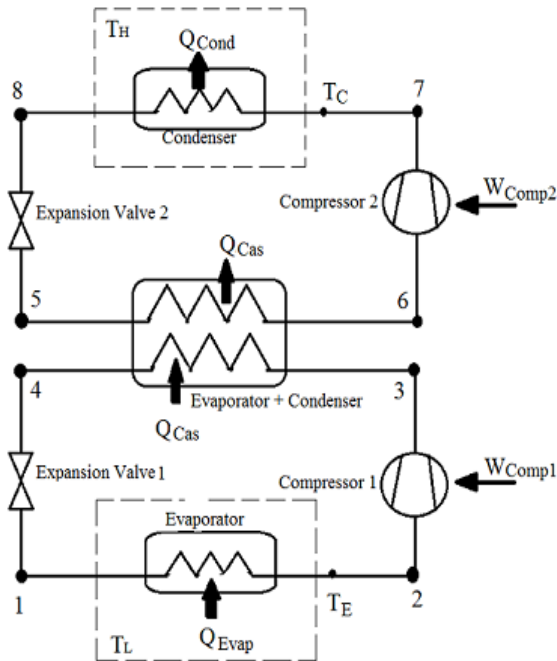

**Figure 1a:** Schematic view of the cascade system

For a given operating condition  $T_E$  and  $T_C$ , the intermediate temperatures can be determined through the use of optimization. Initially, the optimum  $T_{CAS,E}$  ( $T_{OPT,CAS,E}$ ) is computed from the  $T_E$  and  $T_C$ . With such cascade systems, the  $T_E$  range from  $-30$  °C to  $-55$  °C can be achieved. Since cascade systems are more complicated than the single-stage ones, the attention should be paid to the optimization of the operation parameters.

### UTILIZED REFRIGERANTS AND ENVIRONMENTAL ANALYSIS

Synthetic refrigerants are utilized in most industrial refrigeration systems because of their higher cooling properties. Nowadays, as environmental issues have recently gained more importance considering GWPs and ozone depletion potentials (ODPs) natural refrigerants such as  $CO_2$  and various hydrocarbon compounds are proposed to replace synthetic refrigerants in industrial systems (9). This study investigates the effect of the low and high GWP refrigerants in the cascade system using thermodynamic analysis.

In Case 1, one fully and two partially natural refrigerant solutions have been investigated. Fully natural refrigeration solution,  $CO_2$  is the selected refrigerant of LTC and  $NH_3$  is the selected refrigerant of HTC. The partially

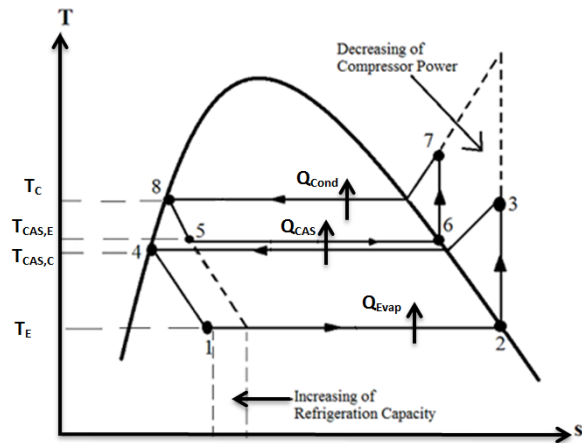

**Figure 1b:** T-s diagram of system

natural refrigerant solutions system uses the  $CO_2$  as the refrigerant of the LTC and the synthetic R152a and R134a as refrigerants of the HTC.  $CO_2$  is one of the most promising and environment-friendly refrigerant solutions due to its superior thermo-physical properties, low ODP and GWP. It is also a non-toxic, non-explosive, easily available refrigerant Pearson (9).  $NH_3$  is another natural refrigerant but it is toxic and flammable with A2 safety class. R152a has approximately same behavior like R134a for temperatures from  $-25$  °C to  $-10$  °C. Therefore, R134a can be replaced with R152a with minimum modification in the existing refrigeration system Cabello (3).

In Case 2, one partially natural refrigerant solution and two synthetic refrigerant solutions are examined. R404A, as a refrigerant with several appropriate properties, has been being widely used in industrial applications in over the world. However, due to several regulations regarding the environmental issues, the restriction of refrigerants (R404A, R134a and R152a) usage with high GWP has started. Main advantages of them are in A1 safety class and non-flammable refrigerants. However, they have high GWP. The advantage of R152a is its low GWP, whereas its disadvantage is its flammability. It is in the safety class A2.

**Table 1.** The physical, environmental and safety properties of refrigerants (10)

Refrigerants	Molecular weight (kg/kmol)	Boiling point (°C)	Critical temperature (°C)	Critical pressure (MPa)	Toxicity	Flammability	GWP
NH3	17.03	-33.3	132.3	11.28	A2	2	0
R152a	66.05	-25.0	113.5	4.52	A1	2	140
R134a	102.3	-26.1	101.1	4.06	A1	1	1370
<b>R404A</b>	<b>97.60</b>	<b>-46.5</b>	<b>72.04</b>	<b>3.72</b>	<b>A1</b>	<b>1</b>	<b>3922</b>
<b>CO<sub>2</sub></b>	<b>44.01</b>	<b>-56.6</b>	<b>31.0</b>	<b>7.38</b>	<b>A1</b>	<b>1</b>	<b>1</b>

TEWI is a GWP measure used to evaluate the direct and indirect global warming effects of the refrigeration systems. The direct effect which occurs as a result of refrigerant is released directly into the atmosphere. The indirect effect of CO<sub>2</sub> emissions released from fossil fuels consumed to produce energy to

drive the refrigeration system from beginning to the end of its lifetime. TEWI comparison provides a clear image of these effects in the service lifetime of the refrigeration system. TEWI values of different system's refrigerant pairs are calculated using the following correlation (11).

$$TEWI = GWP_{Ref} (m_{Ref} \times L_{annual} \times N + m_{Ref} \times (1-\alpha)) + (E_{annual} \times \beta \times N) \quad (1)$$

Where  $GWP_{Ref}$  is the GWP of the refrigerant,  $N$  is the system lifetime,  $m_{Ref}$  is the total refrigerant charge,  $L_{annual}$  is the refrigerant leakage rate,  $\alpha$  is the recycling factor,  $E_{annual}$  is energy consumed per year and  $\beta$  is the electricity regional conversion factor.

## THERMODYNAMIC ANALYSIS

### System Model Equations

The thermodynamic model of the cascade system is developed using the first law of thermodynamics. Considering the schematic and state points of Figures 1a and 1b, the following equations are used for the analysis. The COP and the mass flow ratio of two cycles are computed for various operating conditions (8).

Following assumptions are taken into consideration in the analysis.

- isenthalpic expansion of refrigerants in expansion valves,
- isentropic compressor efficiencies of 0.72 both low and high temperature cycles,
- potential and kinetic energy changes are neglected,
- heat and pressure losses in all components are neglected,
- the subcooling degree ( $\Delta T_{SUB}$ ) and superheat degree ( $\Delta T_{SUP}$ ) are kept constant to be 5 °C and 7 °C respectively.

Numerical calculations are performed using well-known EES software (12). The thermo-physical properties of the refrigerants (CO<sub>2</sub>, NH<sub>3</sub>, R134a, R152a and R404A) specified is obtained using EES. The mathematical model of the cascade system has been developed using the first law of thermodynamics. The derived equations are given below;

The capacity of the evaporator of LTC is defined as

$$\dot{Q}_{Evap} = \dot{m}_L (h_2 - h_1) \quad (2)$$

Compressor power consumption for HTC is given a:

$$\dot{W}_{Comp2} = \dot{m}_H (h_7 - h_6) \quad (3)$$

Similarly, compressor power consumption for LTC is

$$\dot{W}_{Comp1} = \dot{m}_L (h_3 - h_2) \quad (4)$$

The rate of heat transfer in the cascade system is calculated as

$$\dot{Q}_{CAS} = \dot{m}_H (h_6 - h_5) = \dot{m}_L (h_4 - h_3) \quad (5)$$

The mass flow rate ratio of circulating refrigerants in high and low temperature cycles is

$$\frac{\dot{m}_H}{\dot{m}_L} = \frac{(h_4 - h_3)}{(h_6 - h_5)} \quad (6)$$

The rate of heat rejection by the condenser of HTC:

$$\dot{Q}_{Cond} = \dot{m}_H (h_7 - h_8) \quad (7)$$

And finally, the overall COP of the cascade system is determined by:

$$COP = \frac{\dot{Q}_{Evap}}{\dot{W}_{Comp2} + \dot{W}_{Comp1}} = \frac{\dot{m}_L (h_2 - h_1)}{\dot{m}_H (h_7 - h_6) + \dot{m}_L (h_3 - h_2)} \quad (8)$$

## RESULTS AND DISCUSSION

### Optimization

The linear regression method is applied in two-variable optimization calculations using EES software (12). Two correlations are computed for each refrigerant pair from the two operating condition variables  $T_E$  and  $T_C$ . First, the  $T_{OPT,CAS,E}$  is calculated from the given  $T_E$  and  $T_C$ . Then, the  $COP_{max}$  is

calculated from the former  $T_{OPT,CAS,E}$  values. The computed correlations are presented in

Table 2. The unit used in the calculations is Kelvin (K).

**Table 2:** Correlations of the refrigerant pairs calculated for two case studies.

		Case 1	Case 2
R134a/CO <sub>2</sub>	$T_{OPT,CAS,E} = 73.235 + 0.34T_C + 0.365T_E$ $R^2 = 91.77\%$	$T_{OPT,CAS,E} = 15.5357 + 0.4736T_C + 0.4705T_E$ $R^2 = 97.74\%$	
	$COP_{max} = 4.540 - 0.0403T_C + 0.0404T_E$ $R^2 = 97.57\%$	$COP_{max} = 3.881 - 0.0425T_C + 0.0393T_E$ $R^2 = 99.98\%$	
R152a/CO <sub>2</sub>	$T_{OPT,CAS,E} = 51.14 + 0.3208T_C + 0.467T_E$ $R^2 = 99.91\%$	$T_{OPT,CAS,E} = 37.932 + 0.3484T_C + 0.5215T_E$ $R^2 = 97.90\%$	
	$COP_{max} = 3.9747 - 0.039T_C + 0.0418T_E$ $R^2 = 97.67\%$	$COP_{max} = 3.3795 - 0.038T_C + 0.04316T_E$ $R^2 = 95.81\%$	
NH <sub>3</sub> /CO <sub>2</sub>	$T_{OPT,CAS,E} = 85.18 + 0.2172T_C + 0.458T_E$ $R^2 = 99.95\%$	$T_{OPT,CAS,E} = 60.7717 + 0.2876T_C + 0.5045T_E$ $R^2 = 99.99\%$	
	$COP_{max} = 2.022 - 0.0330T_C + 0.0424T_E$ $R^2 = 92.84\%$	$COP_{max} = 3.006 - 0.0371T_C + 0.0436T_E$ $R^2 = 97.75\%$	

**Optimization results**

The proposed correlations are used to estimate the  $T_{OPT,CAS,E}$  and  $COP_{max}$  values from various operating parameters  $T_E$  and  $T_C$ . The estimations for Cases 1 and 2 are illustrated in Table 3.

**Table 3:** Predictions of  $T_{OPT,CAS,E}$  and  $COP_{max}$  for different refrigerant pairs.

		Case 1				Case 2							
		R134a/CO <sub>2</sub>		R152a/CO <sub>2</sub>		NH <sub>3</sub> /CO <sub>2</sub>		R134a/R404A		R152a/R404A		NH <sub>3</sub> /R404A	
T <sub>C</sub> (K)	T <sub>E</sub> (K)	T <sub>OPT</sub> (K)	COP	T <sub>OPT</sub> (K)	COP	T <sub>OPT</sub> (K)	COP	T <sub>OPT</sub> (K)	COP	T <sub>OPT</sub> (K)	COP	T <sub>OPT</sub> (K)	COP
318	253	273.7	2.03	271.3	2.15	270.1	2.26	285.2	2.14	280.6	2.20	279.9	2.24
	248	271.9	1.83	269.0	1.94	267.8	2.04	282.8	1.93	278.0	1.98	277.3	2.02
	243	270.0	1.63	266.6	1.73	265.5	1.83	280.5	1.72	275.5	1.77	274.8	1.81
	238	268.2	1.43	264.3	1.52	263.3	1.62	278.1	1.50	272.8	1.55	272.3	1.59
	233	266.4	1.22	262.0	1.31	260.9	1.41	275.8	1.29	270.2	1.34	269.8	1.37
313	253	272.0	2.23	269.7	2.34	269.0	2.42	282.8	2.34	278.9	2.39	278.4	2.43
	248	270.2	2.03	267.4	2.13	266.8	2.21	280.5	2.13	276.3	2.17	275.9	2.21
	243	268.4	1.83	265.0	1.93	264.5	2.00	278.1	1.91	273.7	1.96	273.4	1.99
	<b>238</b>	<b>266.5</b>	<b>1.63</b>	<b>262.7</b>	<b>1.72</b>	<b>262.2</b>	<b>1.78</b>	<b>275.7</b>	<b>1.70</b>	<b>271.1</b>	<b>1.74</b>	<b>270.9</b>	<b>1.77</b>
	233	264.7	1.42	260.4	1.51	259.9	1.57	273.4	1.49	268.5	1.53	268.3	1.55
308	253	270.3	2.43	268.1	2.54	268.0	2.59	280.5	2.54	277.2	2.58	277.0	2.61
	248	268.5	2.23	265.8	2.33	265.7	2.37	278.1	2.32	274.6	2.36	274.5	2.39
	243	266.6	2.03	263.4	2.12	263.4	2.16	275.7	2.11	272.0	2.15	271.9	2.18
	238	264.8	1.83	261.1	1.91	261.1	1.95	273.4	1.90	269.4	1.93	269.4	1.96
	233	263.0	1.62	258.8	1.70	258.8	1.74	271.0	1.68	266.7	1.72	266.9	1.74
303	253	268.6	2.63	266.5	2.73	266.9	2.75	278.1	2.73	275.5	2.77	275.6	2.80
	248	266.8	2.43	264.2	2.52	264.6	2.54	275.7	2.52	272.8	2.55	273.0	2.58
	243	264.9	2.23	261.8	2.32	262.3	2.33	273.4	2.31	270.2	2.34	270.5	2.36
	238	263.1	2.03	259.5	2.11	260.0	2.11	271.0	2.09	267.6	2.12	268.0	2.14
	233	261.3	1.83	257.2	1.90	257.7	1.90	268.7	1.88	265.0	1.91	265.5	1.93

**Thermodynamic analysis results**

Various pairs of refrigerant such as R134a/CO<sub>2</sub>, R152a/CO<sub>2</sub>, and NH<sub>3</sub>/CO<sub>2</sub> are investigated in Case 1. Similarly, R134a/R404A, R152a/R404A, and NH<sub>3</sub>/R404A are examined in Case 2. The cases were investigated due to the variations in T<sub>E</sub> and T<sub>C</sub>. The other operating parameters were kept constant such as ΔT<sub>CAS</sub>, the subcooling and superheat degrees were assumed as 6 K, 5 K and 7 K respectively.

**The Effect of T<sub>E</sub> on COP<sub>max</sub>**

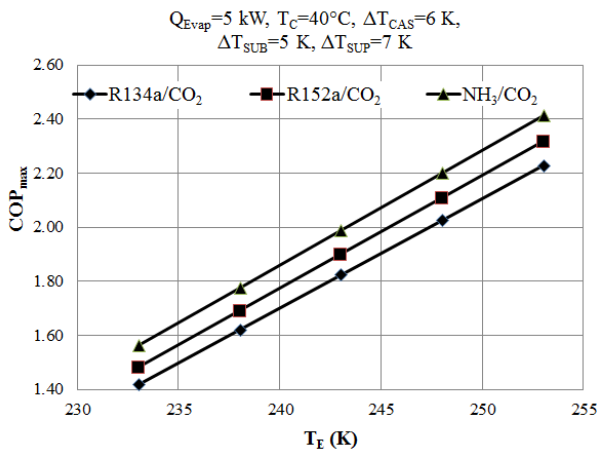

**Figure 2a:** Influence of T<sub>E</sub> on COP<sub>max</sub>(Case 1)

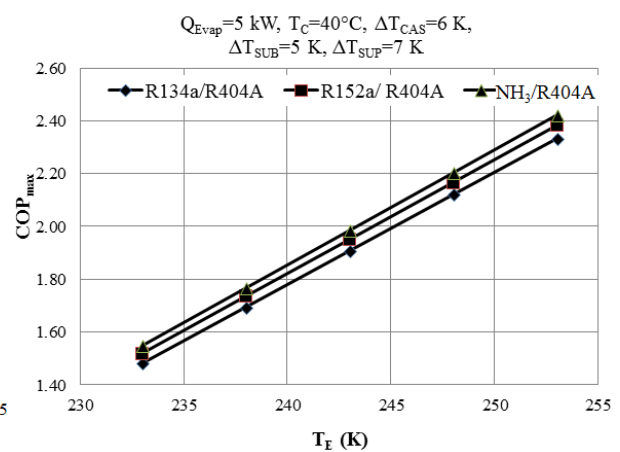
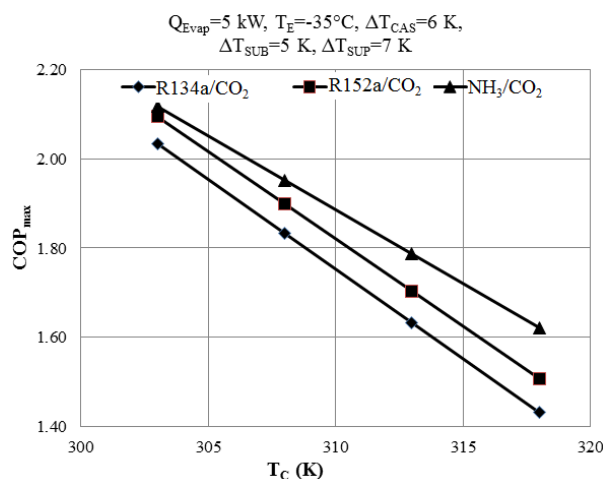

**Figure 2b:** Influence of T<sub>E</sub> on COP<sub>max</sub>(Case 2)

**Effect of T<sub>C</sub> on COP<sub>max</sub>**

The effect of T<sub>C</sub> on COP<sub>max</sub> was investigated. The T<sub>E</sub> was kept constant at -35 °C. The COP<sub>max</sub> values are demonstrated in Figures 3a and 3b for variable T<sub>C</sub> values such as; 45 °C, 40 °C, 35 °C, 30 °C. For all the systems

in Case 1 and Case 2, it is observed that, while the T<sub>C</sub> values increase the COP<sub>max</sub> values decrease. The NH<sub>3</sub>/CO<sub>2</sub> system and the NH<sub>3</sub>/R404A system appear to have minor advantages over the other refrigerant pairs on both cases.



**Figure 3a:** Effect of T<sub>C</sub> on COP<sub>max</sub> (Case 1)

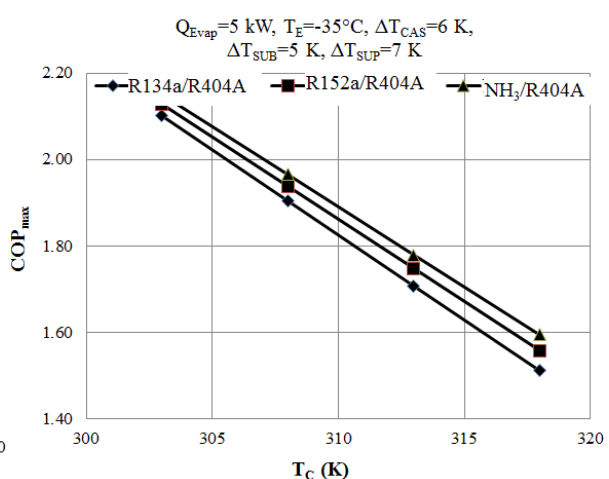

**Figure 3b:** Effect of T<sub>C</sub> on COP<sub>max</sub> (Case 2)

**Effect of T<sub>E</sub> on T<sub>OPT,CAS,E</sub>**

T<sub>OPT,CAS,E</sub> values were calculated for various evaporation temperatures (T<sub>E</sub>). While the T<sub>C</sub> was kept constant at 40 °C, T<sub>E</sub> values were

varied between -40 °C and -20 °C. The variations of T<sub>OPT,CAS,E</sub> values are depicted in Figures 4a and 4b. In Case 1, relatively higher T<sub>OPT,CAS,E</sub> values are calculated for

R134a/CO<sub>2</sub> than the other refrigerant pairs. Similarly, in Case 2, relatively higher T<sub>OPT,CAS,E</sub> values are observed for

R134a/R404A system. The other refrigerant pairs demonstrate similar behavior in both cases.

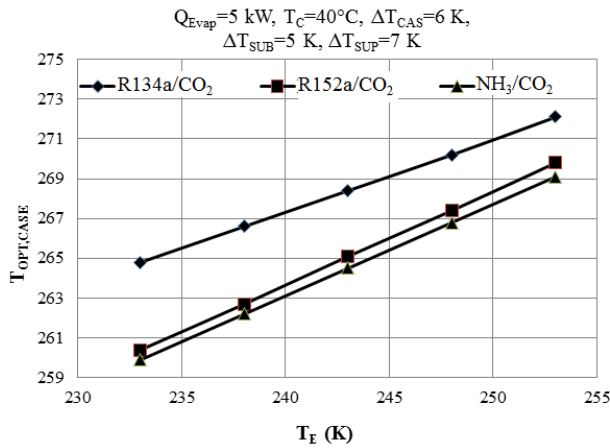

Figure 4a: Effect of T<sub>E</sub> on T<sub>OPT,CASE</sub> (Case 1)

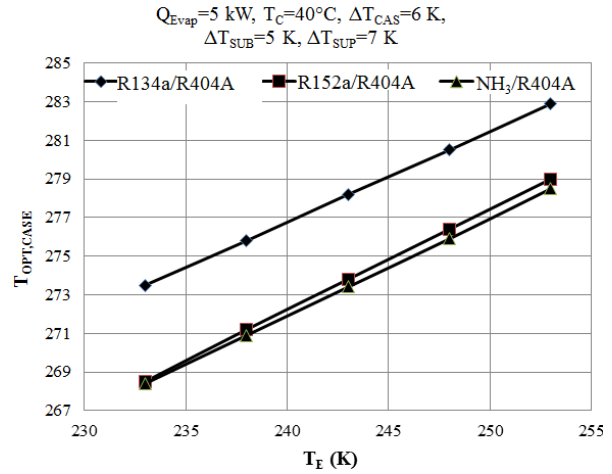

Figure 4b: Effect of T<sub>E</sub> on the T<sub>OPT,CASE</sub> (Case 2)

**Effect of T<sub>C</sub> on T<sub>OPT,CAS,E</sub>**

The T<sub>OPT,CAS,E</sub> values are evaluated for variable T<sub>C</sub> values between 45 °C and 30 °C while T<sub>E</sub> kept constant at -35 °C. Relatively higher T<sub>OPT,CAS,E</sub> values for R134a/CO<sub>2</sub> and

R134a/R404A systems are demonstrated in Figures 5a and 5b. On the other hand, systems with R152a/CO<sub>2</sub> and NH<sub>3</sub>/CO<sub>2</sub> pairs share common T<sub>C</sub> values in each case.

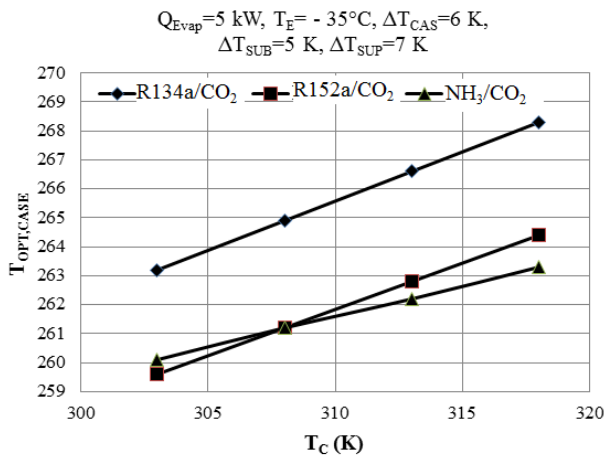

Figure 5a: Effect of T<sub>C</sub> on T<sub>CAS,E</sub> (Case 1).

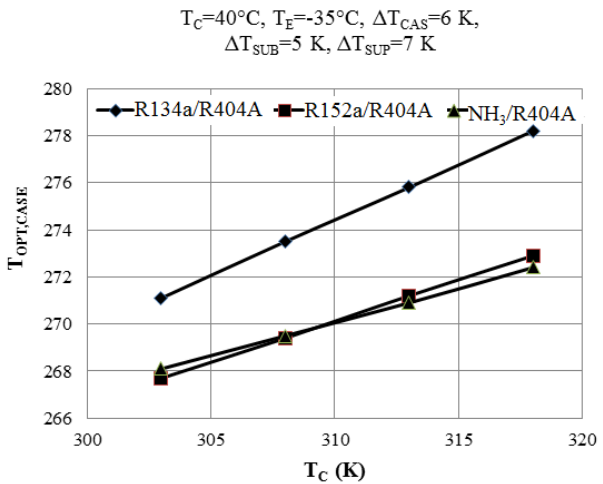

Figure 5b: Effect of T<sub>C</sub> on T<sub>CAS,E</sub> (Case 2).

**Effect of Q<sub>Evap</sub> on mass flow rate of LTC and HTC refrigerants**

Required mass flow rates of refrigerant pairs for different refrigeration capacities are demonstrated in Table 4. It is observed that increasing the refrigeration capacities from 4 kW to 9 kW causes an increase in the mass flow rates of cascade refrigerant pairs. It is found that the mass flow rates of CO<sub>2</sub> are

lower compared to the mass flow rates of R404A. Additionally, for the chosen capacity of 5 kW, the use of CO<sub>2</sub> requires the lowest mass flow rate (0.022 kg/s) whereas using R404A requires the highest mass flow rate (0.038 kg/s) in LTC. The mass flow rates of HTC refrigerants are calculated and the same values are founded in two cases.



**Table 4:** Required mass flow rates of refrigerant pairs for different refrigeration capacities.

$Q_{Evap}$ (kW)	Case 1			Case 2		
	R134a/CO <sub>2</sub> (kg/s)	R152a/CO <sub>2</sub> (kg/s)	NH <sub>3</sub> /CO <sub>2</sub> (kg/s)	R134a/R404A (kg/s)	R152a/R404A (kg/s)	NH <sub>3</sub> /R404A (kg/s)
4	0.039/0.018	0.023/0.018	0.0050/0.018	0.039/0.030	0.023/0.030	0.0050/0.030
<b>5</b>	<b>0.048/0.021</b>	<b>0.028/0.021</b>	<b>0.006/0.021</b>	<b>0.048/0.038</b>	<b>0.028/0.038</b>	<b>0.006/0.038</b>
6	0.057/0.026	0.034/0.026	0.007/0.026	0.057/ 0.045	0.034/0.045	0.007/0.045
7	0.067/0.030	0.039/0.030	0.008/0.030	0.067/ 0.052	0.039/0.052	0.008/0.052
8	0.076/0.034	0.044/0.034	0.009/0.034	0.076/ 0.059	0.044/0.059	0.009/0.059
9	0.085/0.038	0.050/0.038	0.010/0.038	0.085/ 0.066	0.050/0.066	0.010/0.066

In Figure 6, it is observed that the use of R134a requires the highest mass flow rate whereas using NH<sub>3</sub> requires the lowest mass flow rate, due to its high latent heat of vaporization as HTC refrigerants. Mass flow rate values of R152a are between the values of R134a and NH<sub>3</sub> systems for the  $Q_{Evap}$  from 4 kW to 9 kW.

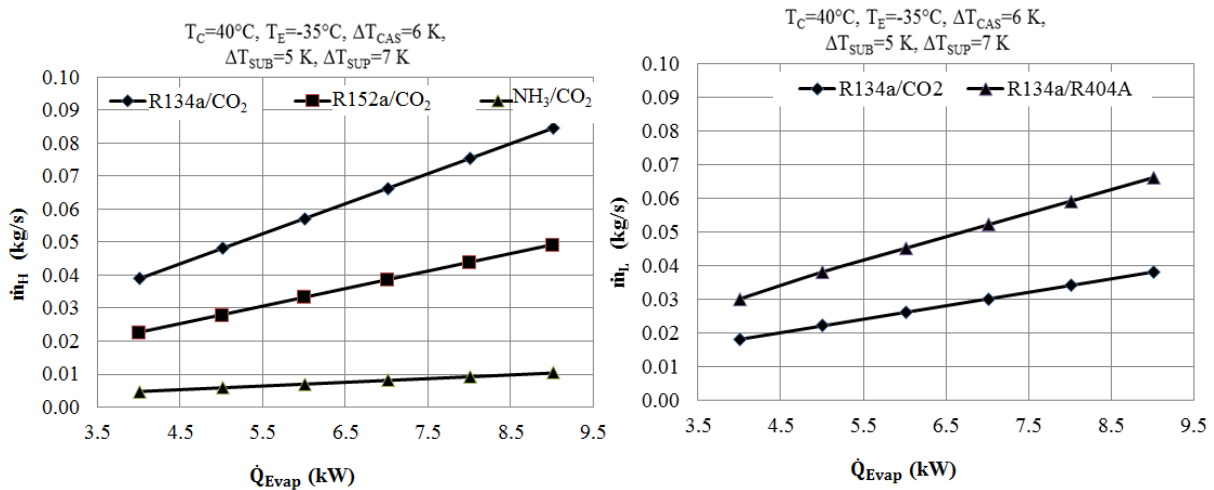

**Figure 6:** Mass flow rates of LTC and HTC refrigerants versus  $Q_{Evap}$ .

**TEWI comparison of the cascade refrigerant pairs**

In order to calculate TEWI values for Cases 1 and 2, model assumptions of the cascade system are determined. The  $T_E$ ,  $T_C$  and  $\Delta T_{CAS}$  values are taken as -35 °C, 40 °C and 6 K respectively. The refrigeration capacity is chosen as 5 kW. According to these assumptions, mass flow rates of HTC refrigerants are calculated as 0.048 kg/s for R134a, 0.028 for R152a and 0.006 kg/s for NH<sub>3</sub>. On the other hand, the mass flow rates of LTC refrigerants are founded as 0.022 kg/s for CO<sub>2</sub> and 0.038 kg/s for R404A. The

calculation of each refrigerant charge is done by using the estimation of  $\dot{m}_{Ref}x(240s)$ . This estimated value is used to size the liquid refrigerant receiver in refrigeration systems. The receiver’s volume is determined by the amount of charged refrigerant of the system (13). In addition, the power consumption of compressors is only taken into account in order to calculate the system energy consumption (Table 4). The power consumption of fans is not taken into account. The TEWI analysis assumptions are summarized in Table 5.

**Table 5:** TEWI analysis assumptions (11).

Parameter	$m_{Ref}^*$ (kg)	$L_{annual}$ (%)	N (years)	$\alpha$ (%)	$\beta^{**}$ (kg.CO <sub>2</sub> /kWh)	System operation (h/year)	$GWP_{Ref}$
Assumed values	$\dot{m}_{Ref}x(240s)$	12.5	15	0.7	$\beta = 0.65$	6570	$GWP_{CO2} = 1$ $GWP_{NH3} = 0$ $GWP_{R134a} = 1370$ $GWP_{R152a} = 140$ $GWP_{R404A} = 3922$

\* Unal (13), \*\*Horton (14)

The GWP values are relatively high for alternative refrigerant pairs in Cases 1 and 2. Therefore, TEWI analysis plays an important role in the selection of the system’s

refrigerant pairs effectively. For comparison between the Cases 1 and 2, the TEWI numbers are calculated from Eq.(1) and



presented in Table 6. Moreover, calculated  $COP_{max}$  values can be seen in Table 6.

**Table 6.** Comparison of TEWI and  $COP_{max}$  values for cascade system in Cases 1 and 2

	Case 1						Case 2					
	NH <sub>3</sub> /CO <sub>2</sub>		R152a/CO <sub>2</sub>		R134a/CO <sub>2</sub>		NH <sub>3</sub> /R404A		R152a/R404A		R134a/R404A	
Refrigerant charge (kg)	1.44	5.04	6.72	5.04	11.52	5.04	1.44	9.12	6.72	9.12	11.52	9.12
Refrigerant Leakage rate (% /year)	0.125		0.125		0.125		0.125		0.125		0.125	
Service life (years)	15		15		15		15		15		15	
Recycling factor	0.7		0.7		0.7		0.7		0.7		0.7	
GWP	1	0	1	140	1	1370	0	3922	140	3922	1370	3922
Direct CO <sub>2</sub> refrigerant's emission (kg CO <sub>2</sub> )	10.96	0	10.96	2,05	10.96	34,328	0	77,797	2,05	77,797	34,328	77,797
<b>Direct CO<sub>2</sub> emission equivalent (kg CO<sub>2</sub>)</b>	<b>10.96</b>		<b>2,057</b>		<b>34,338</b>		<b>77,797</b>		<b>79,843</b>		<b>112,124</b>	
Power consumption (kW)	<b>2.80</b>		<b>2.92</b>		<b>3.06</b>		<b>2.82</b>		<b>2.87</b>		<b>2.94</b>	
Service life (years)	15		15		15		15		15		15	
Operation (h/year)	6570		6570		6570		6570		6570		6570	
CO <sub>2</sub> emission factor	0.65		0.65		0.65		0.65		0.65		0.65	
<b>Indirect CO<sub>2</sub> emission equivalent (kg CO<sub>2</sub>)</b>	<b>179,361</b>		<b>187,048</b>		<b>196,016</b>		<b>180,642</b>		<b>183,845</b>		<b>183,205</b>	
<b>TEWI equivalent CO<sub>2</sub> emission (kg)</b>	<b>179,372</b>		<b>189,105</b>		<b>230,354</b>		<b>258,439</b>		<b>263,688</b>		<b>295,328</b>	
<b>COP<sub>max</sub></b>	<b>1.78</b>		<b>1.72</b>		<b>1.63</b>		<b>1.77</b>		<b>1.74</b>		<b>1.70</b>	

The results of the TEWI analysis are presented in Figure 7. A system with a synthetic refrigerant pair emits considerably higher amounts of greenhouse gases than a system with natural refrigerant pairs during their lifetime (7). Obviously, the direct

(leakage) of high GWP synthetic refrigerants is the reason for such an important difference. Additionally, the indirect part of TEWI might be improved with the low CO<sub>2</sub> emission electricity production.

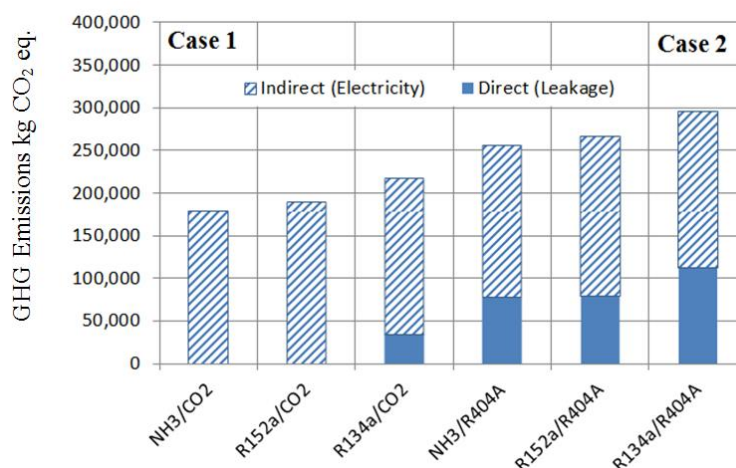

**Figure 7:** TEWI values comparison of systems in Cases 1 and 2

## CONCLUSIONS

A theoretical model is proposed to analyze and determine an energy efficient and environment-friendly cascade system for various refrigerant pairs. Two case studies are proposed. Case 1 has R134a/CO<sub>2</sub>, R152a/CO<sub>2</sub>, and NH<sub>3</sub>/CO<sub>2</sub> systems while Case 2 has R134a/R404A, R152a/R404A and NH<sub>3</sub>/R404A systems. The model is used to optimize the cascade evaporation temperature at given  $T_E$  and  $T_C$  values. After the optimization,  $COP_{max}$  values are calculated for all refrigerant pairs. While these systems are parametrically analyzed, the  $T_E$ ,  $T_C$  and  $Q_{Evap}$  values are taken as -35 °C, 40 °C and 5 kW respectively.

From the results obtained, it is presented that:

- For all the refrigerant pairs, increasing the  $T_E$  of LTC rises to  $COP_{max}$  values. However, increasing the  $T_C$  of HTC reduces to  $COP_{max}$  values for all studied systems.
- For all refrigerant pairs, increasing  $T_E$  and  $T_C$  rises the  $T_{OPT,CAS,E}$ . The  $T_{OPT,CAS,E}$  values of R134a/CO<sub>2</sub> are higher than the other refrigerants pairs in Case 1. Similarly, relatively higher  $T_{OPT,CAS,E}$  values are also observed for R134a/R404A system in Case 2.
- The mass flow rates of the system's refrigerant pairs have been examined in terms of various refrigeration capacities (from 4kW to 9 kW). In LTC, the use of CO<sub>2</sub> requires the lowest mass flow rate (0.022 kg/s), whereas using R404A requires the highest mass flow rate (0.038 kg/s). In HTC, it is also determined that the mass flow rate of NH<sub>3</sub> (0.006 kg/s) is lower to other

refrigerants (R134a and R152a). Therefore, it is concluded that the necessary total refrigerant amount is found less for natural ones.

- In Case 1, R134a/CO<sub>2</sub> pair is found to be the worst option due to resulting in the lowest  $COP_{max}$  (1.63) whereas the NH<sub>3</sub>/CO<sub>2</sub> is found to be the best option due to resulting in the highest  $COP_{max}$  (1.78). In addition, in Case 2, R134a/R404A is found to be the worst option due to resulting in the lowest  $COP_{max}$  (1.70) whereas the NH<sub>3</sub>/R404A is found to be the best option due to resulting in the highest  $COP_{max}$  (1.77).
- The TEWI results suggest that the environmental impact caused by system will decrease by having an efficient system rather than one that employs a refrigerant with a low GWP. According to the TEWI values, R134a/CO<sub>2</sub> and R134a/R404A systems have the highest contribution to CO<sub>2</sub> emission equivalent of indirect effect. These systems also have the lowest COP values. On the other hand, NH<sub>3</sub>/CO<sub>2</sub> and NH<sub>3</sub>/R404A systems have the lowest contribution to CO<sub>2</sub> emission equivalent of indirect effect. In addition, the  $COP_{max}$  values of the systems are calculated as the highest.

## NOMENCLATURE

### Abbreviations

COP	coefficient of performance (-)
GHG	greenhouse gases
GWP	global warming potential
EES	Engineering Equation Solver
HP	high pressure
LP	low pressure
ODP	ozone depletion potential
TEWI	total equivalent warming impact

Greek Letters

$\alpha$	recycling factor (%)
$\beta$	electricity regional conversion factor (kg.CO <sub>2</sub> /kWh)

Latin Letters

$h$	specific enthalpy (kJ/kg)
L	refrigerant leakage rate (% /year)
m	refrigerant charge (kg)
$\dot{m}$	mass flow rate (kg/s)
N	system lifetime (years)
$\dot{Q}$	heat transfer rate (kW)
s	specific entropy (kJ/kg.K)
T	temperature (°C or K)
$\Delta T$	temperature difference (K)
$\dot{W}$	power (kW)

Subscripts

C	condensation
CAS	cascade
Cond	condenser
Comp	compressor
E	evaporation
EV	expansion valve
Evap	evaporator
HTC	high temperature cycle
LTC	low temperature cycle
max	maximum
OPT	optimum
Ref	refrigerant
Sub	subcooling
Sup	superheating

**REFERENCES**

- Llopis, R., Torrella, E., Cabello, R., and Sanchez, D., Performance evaluation of R404A and R507A refrigerant mixtures in an experimental double-stage vapour compression plant, *Appl. Energy*, 87(5), 2010, 1546-53.
- Kilicarslan A., Hosoz M., Energy and irreversibility analysis of a cascade refrigeration system for various refrigerant couples, *Energ. Convers. Manage.*, 51, 2010, 2947-54.
- Cabello R., Sanchez D., Llopis R., Catalan J., Nebot-Andres L., Torella E., Energy evaluation of R152a as drop in replacement for R134a in cascade refrigeration plants, *Appl. Therm. Eng.*, 110, 2017, 972-84.
- Oruc V., Devencioglu A.G., Ender S., Improvement of energy parameters using R442A and R453A in a refrigeration system operating with R404A, *Appl. Therm. Eng.*, 129, 2018, 243-49.
- Baakeem S.S., Orfi J., Alabdulkarem A., Optimization of a multistage vapor-compression refrigeration system for various refrigerants, *Appl. Therm. Eng.*, 136, 2018, 84-96.
- Vaghela J.K., Comparative evaluation of an automobile air-conditioning system using R134a and its alternative refrigerants, *Energy Procedia*, 109, 2017, 153-60.
- Karampour, M., Sawalla, S., State-of-the-art integrated CO<sub>2</sub> refrigeration system for supermarkets: A comparative analysis, *Int. J. Refrig.*, 86, 2018, 239-57.
- Cengel, Y.A., Boles, M.A., *Thermodynamics: An engineering Approach*, McGraw-Hill, Singapore, 2007.
- Pearson, A., Carbon dioxide-new uses for an old refrigerant. *Int. J. Refrig.*, 28, 2005, 1140-48.
- IPCC. *Climate Change 2013: The Physical Science Basis*, Cambridge University Press, Cambridge, United Kingdom and New York, USA, 2013.
- AIRAH, *Methods of Calculating Total Equivalent Warming Impact (TEWI) 2012, Best Practice Guidelines*. The Australian Institute of Refrigeration, Air Conditioning and Heating
- EES., 2017, *Engineering Equation Solver*, Academic Commercial, V10.326, fChart Software Inc.
- Sinar, U., Numerical analysis of a cascade refrigeration system operating at ultra-low temperatures, Marmara University, Master's Thesis, 2018.
- Horton, W.T., Modelling of secondary loop refrigeration systems in supermarket applications, Purdue University, PhD thesis, 2002.

