



POLİTEKNİK DERGİSİ

JOURNAL of POLYTECHNIC

ISSN: 1302-0900 (PRINT), ISSN: 2147-9429 (ONLINE)

URL: <http://dergipark.org.tr/politeknik>



Experimental and statistical analysis of effect of Si modification and grain refinement on tensile properties of A356 alloy

A356 alaşımında Si modifikasyonu ve tane inceltmenin çekme özellikleri üzerine etkisinin deneysel ve istatistiksel analizi

Yazar(lar) (Author(s)): Muhammet ULUDAĞ

ORCID: 0000-0001-9150-3292

Bu makaleye şu şekilde atıfta bulunabilirsiniz(To cite to this article): Uludağ, M., “ Experimental and statistical analysis of effect of Si modification and grain refinement on tensile properties of A356 alloy”, *Politeknik Dergisi*, 24(4): 1409-1417, (2021).

Erişim linki (To link to this article): <http://dergipark.org.tr/politeknik/archive>

DOI: 10.2339/politeknik.707109

Experimental and Statistical Analysis of Effect of Si Modification and Grain Refinement on Tensile Properties of A356 Alloy

Highlights

- ❖ *Sr addition increased UTS in general, however, the average UTS values are low*
- ❖ *There is no negative effect of addition parameters (Ti, Sr and B) on the mechanical properties until the yield point while addition parameters affect mainly the ultimate tensile strength.*
- ❖ *The most stable results for ϵ % was obtained by Ti addition for both before and after degassing*
- ❖ *While Ti is the best addition alloying element for both before and after degassing, Sr is the worst for QT*
- ❖ *The size, distribution, number and orientation of bifilms should be considered to explain the effect of bifilms on the mechanical properties in detail*

Graphical Abstract

Effect of Sr modification and grain refinement on the bifilm index and mechanical properties of A356 alloy were investigated in detail.

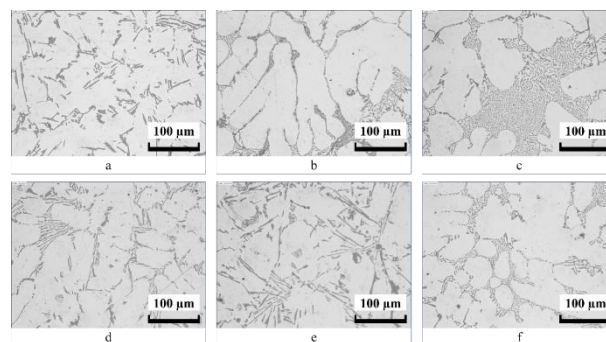

Figure.

Aim

Assess the relationship between mechanical properties and bifilms.

Design & Methodology

The modification and refinement treatments were carried out with three different master alloys: AlSr15, AlTi5B1, and AlB3. The tests were conducted under two conditions: with and without degassing to evaluate the effect of change in melt quality.

Originality

Evaluate the relationship between casting quality and tensile properties of A356 alloy

Findings

There is a good relationship between bifilm index and tensile test results when the bifilm index is divided into three groups, namely: poor, medium and high quality.

Conclusion

While Ti grain refinement addition positively affects the mechanical properties, Sr addition has a negative effect on casting quality.

Declaration of Ethical Standards

The author of this article declares that the materials and methods used in this study do not require ethical committee permission and/or legal-special permission.

Experimental and Statistical Analysis of Effect of Si Modification and Grain Refinement on Tensile Properties of A356 Alloy

Araştırma Makalesi / Research Article

Muhammet ULUDAĞ*

Bursa Technical University, Metallurgical and Materials Engineering, Bursa, 16310, Turkey

(Geliş/Received : 21.03.2020 ; Kabul/Accepted : 01.06.2020 ; Erken Görünüm/Early View : 09.06.2020)

ABSTRACT

The focus point of recent research on light metal castings has been on the effect of casting quality on the material properties and maximizing the quality is the most important factor toward obtaining the best properties from an alloy. Sr additions modify Si morphology while grain refiners such as AlTi_xBy and Ti-free B make dendrite arms smaller in the alloy. Therefore, this study has been performed to evaluate the relationship between casting quality and tensile properties of A356 alloy. The modification and refinement treatments were carried out with three different master alloys: AlSr15, AlTi5B1, and AlB3. The tests were conducted under two conditions: with and without degassing to evaluate the effect of change in melt quality. Results obtained from experimental studies were analyzed statistically. It was concluded that there is a good relationship between bifilm index and tensile test results when the bifilm index is divided into three groups, namely: poor, medium and high quality. It was found that while Ti grain refinement addition positively affects the mechanical properties, Sr addition has a negative effect on casting quality.

Keywords: A356 alloy, modification, grain refinement, Weibull analysis, bifilm index, degassing.

A356 Alaşımında Si Modifikasyonu ve Tane İnceltmenin Çekme Özellikleri Üzerine Etkisinin Deneysel ve İstatistiksel Analizi

ÖZ

Hafif metal dökümleri üzerine yapılan son araştırmaların odak noktası, döküm kalitesinin malzeme özellikleri üzerindeki etkisi ve bir alaşımdan en iyi özellikleri elde etmek için kaliteyi en üst düzeye çıkarmanın en önemli faktör olduğu üzerinedir. Sr ilaveleri, Si morfolojisini değiştirirken, AlTi_xBy ve Ti içermeyen B gibi tane incelticileri alaşımda dendrit kollarını daha küçük hale getirir. Bu nedenle, bu çalışma A356 alaşımının döküm kalitesi ile çekme özellikleri arasındaki ilişkiyi değerlendirmek için yapılmıştır. Modifikasyon ve tane inceltme işlemleri üç farklı master alaşımı ile gerçekleştirilmiştir: AlSr15, AlTi5B1 ve AlB3. Sıvı metal kalitesindeki değişime etkisini incelemek için gaz gidermeli ve gaz gidermesiz olmak üzere, testler iki koşul altında gerçekleştirilmiştir. Deneysel çalışmalardan elde edilen bulgular istatistiksel olarak analiz edilmiştir. Zayıf, orta ve yüksek kalite olarak bifilm indeksi üç gruba ayrıldığında, bifilm indeksi ile çekme testi sonuçları arasında iyi bir ilişki olduğu sonucuna varılmıştır. Ti tane inceltici ilavesi mekanik özellikleri olumlu yönde etkilerken, Sr ilavesinin döküm kalitesi üzerinde olumsuz bir etkiye sahip olduğu görülmüştür.

Anahtar Kelimeler: A356 alaşımı, modifikasyon, tane inceltme, Weibull analizi, bifilm indeksi, gaz giderme.

1. INTRODUCTION

Al-Si alloys are the most preferred alloy in casting operations [1]. A356 alloy is obtained by adding magnesium as an alloying element at the rate of 0,3% into Al-7Si alloy. This alloy has several superior properties such as high wear, corrosion and hot-tearing resistance, good weldability and high strength/density ratio. This alloy is used in several industries such as automotive and aerospace [2, 3]. Mechanical properties of the alloys such as strength and hardness are depended on their microstructure. Therefore, there several studies that have focused on microstructural alterations and their effect on

the mechanical properties [4-7]. However, one of the most crucial parameters is the cleanliness of the melt. Mechanical properties of cast alloys can be enhanced by simply decreasing the defects that may exist in the melt. Porosity is the most hazardous defect that affects the mechanical properties of the alloys negatively. Understanding the mechanism of pore formation is necessary to produce sound castings [8-11]. In this way, the parameters that have a negative effect on the properties of the alloys can be prevented [12, 13]. The porosity formation mechanism had been typically explained with shrinkage and gas porosity [14, 15]. On the other hand, bifilm theory that is claimed by Campbell and Dispınar [16-20] leads to the new approaches for the porosity formation. Several other researchers [11, 21-27] have also reported such results. Bifilms can be classified

* Sorumlu Yazar (Corresponding Author)
e-posta : dr.uludag@gmail.com, muhammet.uludag@btu.edu.tr

as old and young oxides [16]. Young bifilm is referred to the amorphous oxide whereas old bifilms are characterized as the thick and crystalline oxides. It is important to note that turbulence is a critical factor that generates bifilms which are considered as the main reason for porosity formation [28, 29]. To prevent turbulence, it is essential to improve mold design in terms of runner and filling systems [30].

Before casting, the quantification of porosity is a challenge. Dispınar [19, 20] used reduced pressure test (RPT) to quantify the melt cleanliness numerically. Solidification under vacuum enlarges the bifilms; and from the cross-section of RPT samples, the bifilm index was proposed [31] which was given in millimeters as an indication of bifilm content. Bifilm index value measured as the sum of all porosities in RPT samples represented casting and melt quality and Dispınar [19, 20, 31, 32] correlated this index with mechanical properties. Raiszadeh [33] studied the effect of atmospheric and reduced pressure on double oxide films.

Hydrogen that can be dissolved in the melt can trigger the opening of bifilms. For this reason, the removal of hydrogen can only affect the unraveling of bifilms. On the other hand, the degassing process removes bifilms from the melt [32, 34]. Yorulmaz [35] had used a feather/balloon analogy to show this phenomenon. There are many other degassing processes such as vacuum and ultrasonic degassing [28, 36-38]. Bifilms in the melt constitute the porosity and it decreases the mechanical properties of the alloys [16, 39]. It is reported by Tiryakiođlu [40] and Chen [41] that bifilms decrease fatigue properties significantly. Several other reports in the literature reveal similar findings [16, 42]. From this point of view, it is very important to prevent the formation and incorporation of bifilms into the cast part. Bifilms can be affected by the alloying elements present in the alloy [10]. For example, grain refiners such as AlTi5B1 and Al3B can be used for the removal of bifilms [1]. It has been suggested that optimum working amounts of Ti and B for the A356 alloy should be 0.06% Ti-0.01 B and 0.08% Ti-0.02 B [43]. These values are based on the fact that Ti-based intermetallics can be formed in the eutectic region [44]. By incorporating these alloying elements into the structure, finer TiB2 and Al3Ti particles are formed and the material strength is improved. It was presented by Sigworth [45] that TiB2 master alloy acts as a nucleus and nucleus potential is increased with Si. Alloying elements such as Sr have been added into the melt in the form of AlSr15 master alloy to modify Si particles [46]. This modification involves the alteration of the Si phase to finer and fibrous morphology which increases mechanical properties.

The effect of master alloys which is used as grain refiner and modifier on the formation of bifilms in the Al alloys is a different research topic. As mentioned above, it is considered that the bifilms can be cleaned from the melt by adding grain refiners into the melt. Due to its higher density, Ti in the melt moves to the bottom of the crucible

while it takes along bifilms [1]. Some parameters such as the amount of master alloy, temperature and holding time affect this process. It is estimated that the porosity formation will be prevented by removing the bifilms in this way [1, 47, 48]. It is not possible to say the same for Sr [10, 26, 49, 50]. Even if the structure of Si is modified with Sr modification, the formation of bifilms and porosity have been reported to have increased consequently [7, 49, 51]. Sr addition in a small amount has reduced opening the bifilms because Sr heals bifilm and prevents their opening [11]. Statistical analysis is used to evaluate the relationship between bifilms and mechanical properties [32, 52, 53]. It is important to note that all statistical models about fracture are based on the concept that is improved by Griffith [54]. It was presented by Pierce [55] that the largest defect represents the weakest bond. Based on the weakest bond theory, Weibull [56, 57] has initiated a statistical distribution that can be applied to ceramics and metals. Weibull analysis has been used by researchers [40, 58-60].

This present work was carried out in an aim to assess the relationship between mechanical properties and bifilms. Six different casting parameters were selected. Effect of Sr modification and grain refinement on the bifilm index and mechanical properties were investigated in detail. The results of relationship the bifilm index and mechanical properties according to additional parameters and the degassing process were analyzed statistically.

2. MATERIAL and METHOD

A356 alloy was used in the study. The chemical composition is given in Table 1. Chemical composition of three different master alloys (AlTi5B1, AlSr15 and Al3B) that were used as additional parameters for Si modification and grain refinement is given in Table 2.

Ingots were obtained from ETİ ALÜMİNYUM, Turkey as a primary alloy. An electrical furnace that has 5kW power was used to melt the alloy in SiC crucible that has 20 kg capacity for aluminum. Twelve different casting conditions were studied. Five different additions were made for each experiment: AlSr15, AlSr15+AlTi5B1, AlTi5B1, Al3B and AlSr15+Al3B. The amounts of master alloys added to reach the levels of 400 ppm Sr and 100 ppm for AlTi5B1 and Al3B. The sample collection was carried out before and after degassing. Ar was used for degassing for twenty minutes by graphite lance. A list that shows experimental parameters is presented in Table 3. In order to see the direct effect of bifilm on the mechanical properties, the samples were not heat treated. As cast conditions were tested. Secondary Dendrite Arm Spacing (SDAS) of the castings was calculated by SigmaScan image analysis software. Calculations were done with 5 different locations on the microstructure on five different images of each sample. In total, 25 different measurements were carried out for each sample. The average values of these calculations were recorded.

Table 1. Chemical composition of A356 and the tested alloy compositions

Additions	Si	Fe	Cu	Mn	Mg	Zn	Sr	Ti	B	Al
As-received	6.80	0.19	0.003	0.001	0.30	0.011	0	0.008	0	Rem
AlTi5B1	6.84	0.185	0.003	0.001	0.273	0.012	0	0.018	0.001	Rem
AlSr15	6.85	0.195	0.003	0.001	0.276	0.011	0.04	0.009	0	Rem
Al3B	6.72	0.179	0.003	0.001	0.276	0.011	0	0.006	0.01	Rem
AlSr15+AlTi5B1	6.88	0.202	0.003	0.001	0.281	0.011	0.03	0.015	0.001	Rem
AlSr15+Al3B	6.79	0.182	0.003	0.001	0.274	0.011	0.03	0.006	0.01	Rem

Table 2. Chemical composition of the master alloy that was used in the study

Master alloys	Ti	Sr	B	Fe	Si	Ca	Al
AlSr15	-	14	-	≤0.2	≤0.2	≤0.2	Rem.
AlTi5B1	5	-	1	≤0.2	≤0.2	-	Rem.
Al3B	-	-	2.5	0.3	0.2	-	Rem.

Table 3. Experimental parameters

Numbers	Master alloy	Abbreviation	Degassing
1	-	As-received	+
2	-	As-received	-
3	AlSr15	Sr	+
4	AlSr15	Sr	-
5	AlSr15+ AlTi5B1	Sr+Ti	+
6	AlSr15+ AlTi5B1	Sr+Ti	-
7	AlTi5B1	Ti	+
8	AlTi5B1	Ti	-
9	Al3B	B	+
10	Al3B	B	-
11	AlSr15+ Al3B	Sr+B	+
12	AlSr15+ Al3B	Sr+B	-

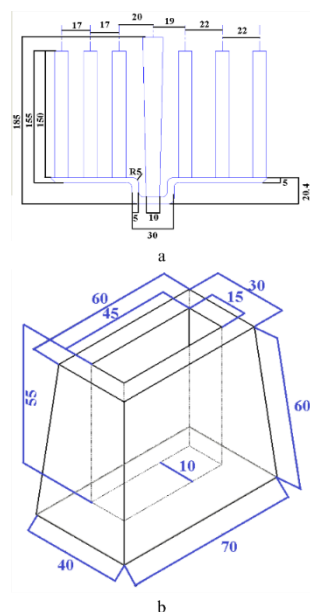
Figure 1. a) Tensile test mold that has six bars and b) RPT mold

Tensile test sand mold that produces six test bars and Reduced Pressure Test (RPT) mold for melt quality are given in Figure 1. Tensile bars have a diameter of 13 mm and a length of 150 mm. These were machined according to the ASTM B557 standard. RPT samples were cut in half subjected to image analysis in order to measure the bifilm index. All data were analyzed statistically using Minitab software to check the reliability and reproducibility. Additionally, scanning electron microscopy (SEM) analysis was carried out on the surface of the fractured samples. Also, Energy-Dispersive X-ray spectroscopy (EDS) analysis was done on microstructure.

5. RESULTS AND DISCUSSION

It is known that the microstructure of A356 alloy consists of α -Al dendrites and Al-Si eutectic phases. Grain refiner and modifier master alloys were added into the liquid metal before casting to alter the microstructure. Two different grain refiners (AlTi5B1 and Al3B) and modifier (AlSr15) were used. The representing images of microstructures obtained from casting experiments are given in Figure 2. SDAS measurements are given in Table 4. It can be seen in Figure 2a that as-received alloy has the typical coarse (thick and long) silicon morphology which is converted to fibrous by Sr modification as seen in Figure 2b, c and f. When the microstructure images of AlTi5B1 and Al3B added castings are considered, it was observed that both additions revealed smaller dendrite arms. More globular grains were found in AlB added castings. Similar findings were reported for Ti-free B master alloy added A356 [61-63]. It is known that Sr addition modifies Si morphology converting from coarse and long structure to fiber and short structure [10, 64]. On the other hand, grain refiner has an effect on dendrite arms in the aluminum alloys [12, 45]. Ti grain refiner such as AlTi_xBy changes dendrite arms from coarse structure to smaller structure, but dendrite arms are formed as columnar [65].

However, Ti-free B grain refiners have a little different effect on microstructure than AlTi_xBy type grain refiners. Although both of them play the same role on dendrite arms in terms to form smaller grains, Ti-free B makes microstructure a more equiaxed and globular structure [66].

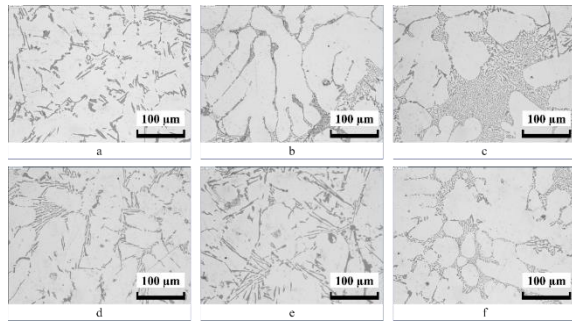

Figure 2. Representative microstructural images of the samples which are produced from casting trials, a) for as-received condition, b) AlSr15 addition condition, c) AlSr15+AlTi5B1 addition condition, d) AlTi5B1 addition condition, e) Al3B addition condition, f) AlSr15+ Al3B addition condition

Table 4. SDAS measurements of casting parameters

Additions	SDAS (µm)
As-Received	44.28
AlTi5B1	40.13
AlSr15	46.19
Al3B	44.44
AlSr15+AlTi5B1	37.07
AlSr15+Al3B	37.88

The mechanical test results are given in Figure 3. As can be seen, it is determined that the degassing process improves the mechanical properties. This effect of degassing shows that the initial metal quality is important for final product quality as Campbell [67] had stated in the first rule of casting: start casting with clean metal.

A slight increase in mechanical properties was observed in all tests for the non-degassed as-received alloy. It can be concluded that the addition of alloying elements has no remarkable effect on the mechanical properties for no degassing conditions. Although additional master alloys modify the microstructure, it is believed that the main mechanism of a slight increase is due to decreased porosity formation [68, 69]. For the results obtained after degassing, it is seen that the additions have a positive effect on the mechanical properties. The addition of Al3B exhibited the highest increase in mechanical properties. On the other hand, AlSr15 both alone and with grain refiners show no significant increase in mechanical properties even after degassing. This situation was explained by the formation of Sr spinel oxide (SrO.Al₂O₃) which decreased the melt quality [47].

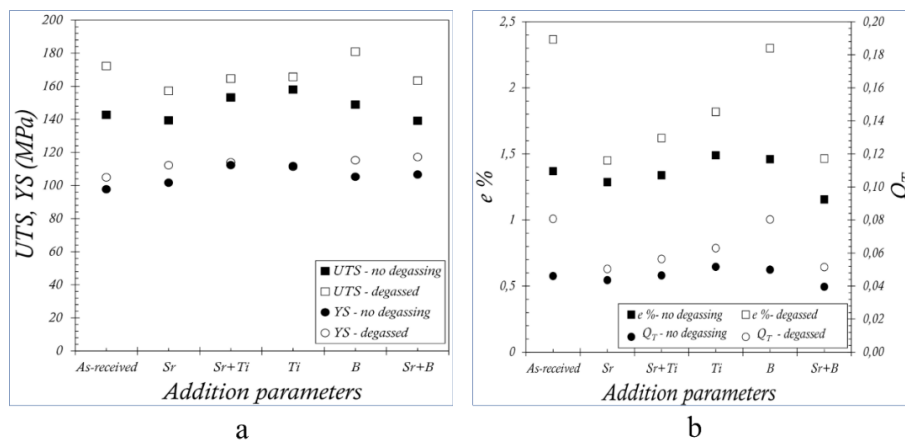

Figure 3. Changes in mechanical properties depending on additional parameters and degassing condition, a) Ultimate tensile strength (UTS) and yield strength (YS), b) Maximum elongation (e%) and quality index (QT)

Statistical analysis techniques were performed to analyze the effect of additional parameters and casting quality on the mechanical properties. Weibull analysis is a preferred technique for such purposes [11, 40, 47, 58, 60]. The Weibull analysis gives a perspective on the reliability and reproducibility of the results. For this reason, The Weibull analysis technique was used to investigate the mechanical test results. UTS, YS, e % and QT were analyzed and the results are given in Figure 4-7. For UTS, it can be seen that the effect of degassing on the Weibull modulus and scale parameter increases with almost every parameter while the effect of degassing on the Weibull distribution occurs with a narrowing range. It was seen in UTS results that when Sr modification and Ti grain refinement process are made together, the results are more stable and reproducible. On the other hand, the best scale parameter result was seen for only Ti-addition

when the melt was not degassed. This was higher for B grain refinement after degassing. The underlying mechanism of achieving a high UTS is defined by the increased melt quality by the removal of bifilms from the melt by Ti sinking [1]. Although UTS increases with Sr addition, the average UTS is recorded to be low. These results indicate that Sr addition decreases the quality of the liquid metal. The negative effect of Sr modification on UTS was seen for all experimental conditions. For YS, Sr + Ti addition gave the best result. While the most stable value for YS results was obtained by Sr modification after degassing, the highest YS result was obtained by Sr + B. Weibull modulus (m) and scale parameters (µ) of YS before degassing give the following results:

$$m_{Ti} > m_{Sr+Ti} > m_{Sr+B} > m_B > m_{Sr} > m_{as-received}$$

$$\mu_{Sr+Ti} > \mu_{Ti} > \mu_{Sr+B} > \mu_B > \mu_{Sr} > \mu_{as-received}$$

The most stable e % result was obtained by Ti addition for both melts before and after degassing (Fig 6). It was found that the highest elongation at fracture was obtained by Ti and B addition before degassing. This shows the cleaning effect of Ti on bifilms before degassing. When

looking at the quality index (Q_T) [70], the effect of additional parameters on the metal quality is clearly seen. Ti addition is the best choice for alloying elements in terms of stability for both casting conditions: before and after degassing. As also seen from the same results, Sr has a negative effect on the alloy quality.

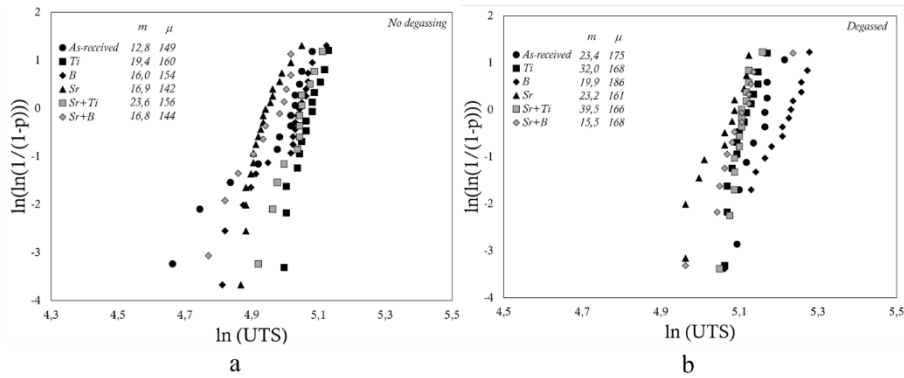

Figure 4. Results of the Weibull analysis and Weibull modulus values for UTS, a) No-degassing condition, b) degassed condition

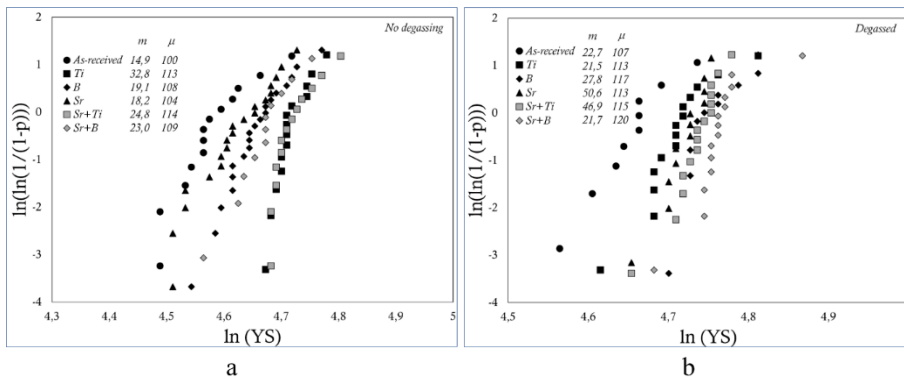

Figure 5. Results of the Weibull analysis and Weibull modulus values for YS, a) No-degassing condition, b) degassed condition

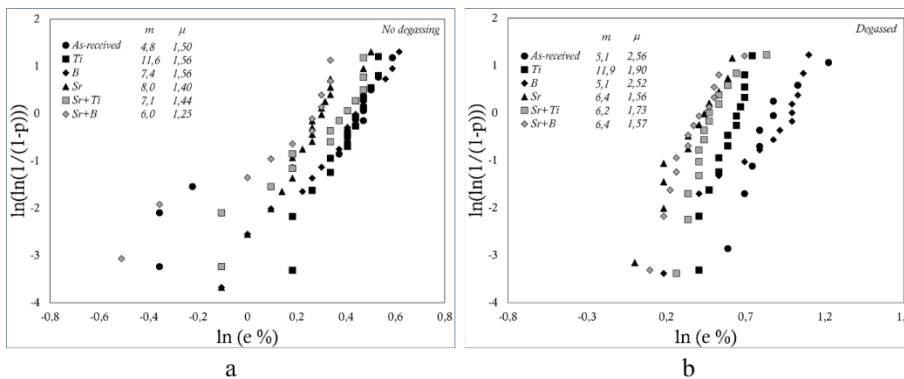

Figure 6. Results of the Weibull analysis and Weibull modulus values for elongation, a) No-degassing condition, b) degassed condition

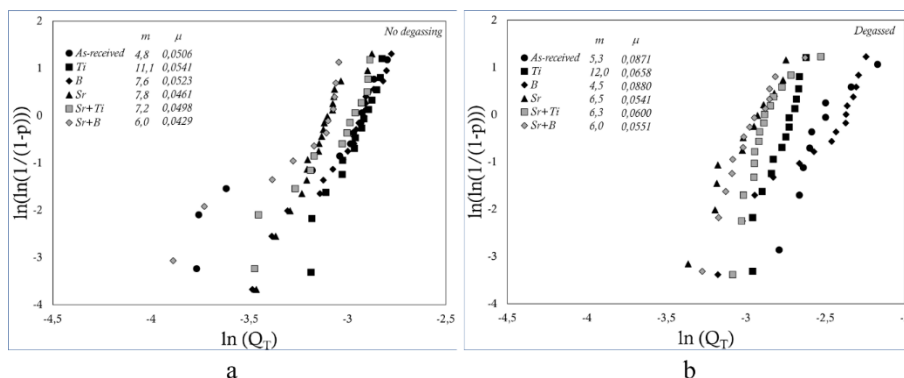

Figure 7. Results of the Weibull analysis and Weibull modulus values for QT, a) No-degassing condition, b) degassed condition

It has been suggested that the main reason for porosity formation is oxide films (bifilms) [1, 19, 20, 31] and the parameters that affect the mechanical properties are also bifilms [68]. Thus, bifilm index measurement of all test conditions was carried out. These results are given in Table 5. Dispinar [19, 20, 31] studied the correlation between bifilm and mechanical properties; and proposed the following levels: $B_I < 25$ mm (very high quality), $25 \text{ mm} < B_I < 50$ mm (good quality) and $50 \text{ mm} < B_I$ (poor quality). When the results given in Table 5 are investigated according to these values, it can be seen that the castings obtained after degassing are in very high quality-group. This positive effect of the degassing process on the casting quality is also seen in the mechanical properties (Figure 3). The relationship between the bifilm index and mechanical properties can be seen clearly in Figure 3. As the bifilm index was increased, the mechanical properties decreased [58, 71-76]. Similar results were reported previously by Caceres [69]. When the bifilm index results of Ti, B and Sr + Ti are considered, it can be seen that they lie in good quality-group, while Sr and Sr + B are in poor quality-group.

Table 5. Bifilm Index of the melts in accordance with test parameters

Casting parameters	Bifilm index (mm)		Change in BI (%)
	No degassing	Degassed	
As-received	83	20	76
Sr	99	12	88
Sr+Ti	36	8	76
Ti	44	7	84
B	31	10	69
Sr+B	57	9	84

The SEM examination of the fracture surface of the tensile test bars was carried out and the presence of bifilms that reduce the mechanical properties was presented in Figure 8. As it is understood clearly from these images, there are many bifilms and intermetallic compounds on the fracture surface of the samples. Bifilms observed on fracture surfaces are in the form of young and old oxides. While young bifilms surrounds the dendrite arms (just like in the form of a stretch film), old bifilms remain in as inclusions in the microstructure.

EDS analyses were performed on the fracture surfaces and the presence of oxides can be seen in Figure 9.

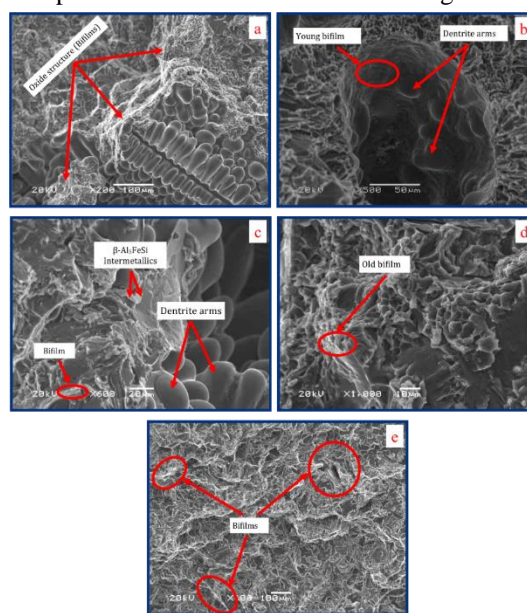

Figure 8. Representative SEM images from the fracture surfaces of the tensile test samples to evidence for bifilms (oxide structures). a) Al3B addition and no degassing condition, b) AlTi5B1 addition and no degassing condition, c) AlSr15+AlTi5B1 addition and degassed condition, d) AlSr15 addition and degassed condition and e) As-received and no degassing condition

All results obtained from the examination of casting quality and mechanical properties were analyzed together and the relationship between bifilms and mechanical properties was presented in Figure 10. It is seen that there is a clear difference between the bifilm index groups in terms of the mechanical properties. However, when the values in each group are evaluated separately, a wide scatter is observed in all groups. This scatter is wider especially for high-quality castings. It can be seen that the minimum value of one group is very close to the maximum value of the other group. In general, it is fair to conclude that as the bifilm index increases, mechanical properties decrease. Indeed, as the casting quality-group (very high, good and poor) improves, mechanical properties improve. The reason for the wide scatter of the

mechanical properties in each group was explained by Uludağ [11, 47]. It was proposed that the bifilm index plays a vital role on the mechanical properties of the casting alloys. It is simple and practical. However, it is recommended that the size, distribution, number and orientation of bifilms should be taken into account to explain the effects of bifilms in detail.

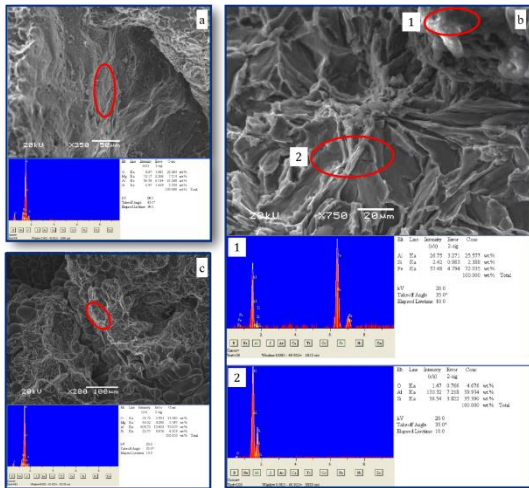

Figure 9. Results of the EDS analyses on the oxide structures from a) As-received and no degassing condition, b) As-received and degassed condition and c) AlSr15+Al3B and degassed condition

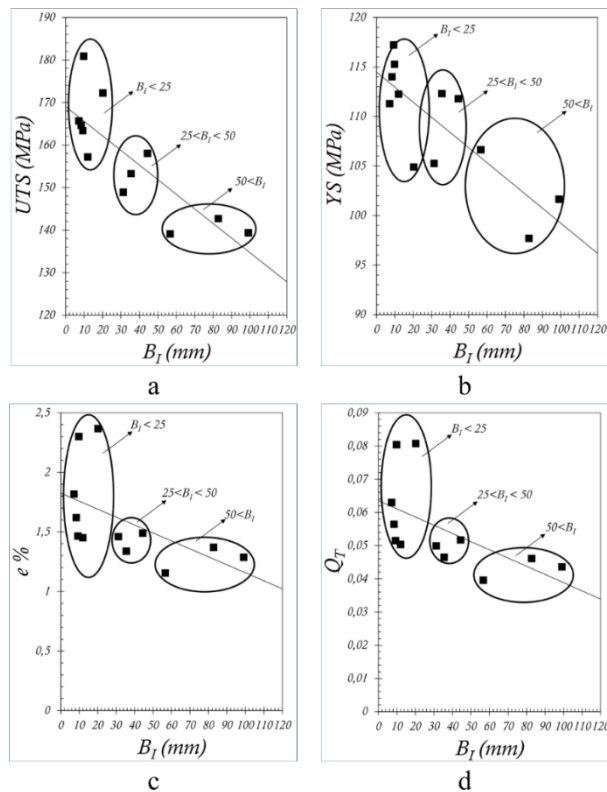

Figure 10. Relationship between bifilm index (B_1) and mechanical properties, a) B_1 vs UTS, b) B_1 vs YS, c) B_1 vs $e\%$, d) B_1 vs Q_r

6. CONCLUSION

The relationship between bifilm index and mechanical properties of A356 alloy by the addition of grain refiner and modifiers were reported in this work. When the degassing process and addition parameters are evaluated together, it can be concluded that the optimum casting condition requires the degassing of as-received alloy. Any modifications such as Ti, Sr or B addition, decreased melt quality. The summary of the findings is as follows:

1. It was seen that UTS results are more stable when Sr modification and Ti grain refinement process are made together. Although Sr addition increased UTS in general, however, the average UTS values are low. These results indicate that Sr addition decreases the quality of liquid metal.

2. It is understood that there is no negative effect of addition parameters (Ti, Sr and B) on the mechanical properties until the yield point while addition parameters affect mainly the ultimate tensile strength.

3. The results of $e\%$ show a similar tendency as UTS. The most stable results for $e\%$ was obtained by Ti addition for both before and after degassing. This shows the cleaning effect of Ti on bifilms before degassing.

4. Q_r results represent the mechanical properties in detail. While Ti is the best addition alloying element for both before and after degassing, Sr is the worst for Q_r .

5. Although it can be said that as the bifilm index increases, mechanical properties decrease; it is proposed that the size, distribution, number and orientation of bifilms should be considered to explain the effect of bifilms on the mechanical properties in detail.

6.

DECLARATION OF ETHICAL STANDARDS

The author of this article declare that the materials and methods used in this study do not require ethical committee permission and/or legal-special permission.

AUTHORS' CONTRIBUTIONS

Muhammet ULUDAĞ: Performed the experiments and analyse the results. Wrote the manuscript.

CONFLICT OF INTEREST

There is no conflict of interest in this study.

REFERENCES

- [1] Campbell, J., Complete casting handbook: metal casting processes, metallurgy, techniques and design, *Butterworth-Heinemann*, (2015).
- [2] Gruzleski, J. and B. Closset, The treatment of liquid aluminum–silicon alloys. *Des Plaines, IL: American Foundrymen’s Society*, Inc. (1990),
- [3] Zhang, L., Y. Jiang, Z. Ma, S. Shan, Y. Jia, C. Fan, and W. Wang, *Journal of materials processing technology*, **207** (1): 107-111, (2008).
- [4] Wang, Q., *Metallurgical and materials Transactions A*, **34** (12): 2887-2899, (2003).
- [5] Wang, Q., D. Apelian, and D. Lados, *Journal of light metals*, **1** (1): 85-97, (2001).
- [6] Taghavi, F., H. Saghafian, and Y.H. Kharrazi, *Materials & Design*, **30** (1): 115-121, (2009).
- [7] Timelli, G., D. Caliarì, and J. Rakhmonov, *Journal of Materials Science & Technology*, **32** (6): 515-523, (2016).
- [8] Uludağ, M., Çetin R., and Dispınar D., *Metallurgical and Materials Transactions A*, **49** (5): 1948-1961, (2018).
- [9] Uludağ, M., Çetin R., Dispınar D., and Tiryakiođlu M., *International Journal of Metalcasting*, **12** (4): 853-860, (2018).
- [10] Uludağ, M., Çetin R., Dispınar D., and Tiryakiođlu M., *Engineering Failure Analysis*, **90**: 90-102, (2018).
- [11] Uludağ, M., Çetin R., Dispınar D., and Tiryakiođlu M., *International Journal of Metalcasting*, **12** (3): 589-594, (2018).
- [12] Conley, J.G., J. Huang, J. Asada, and K. Akiba, *Materials science and Engineering: A*, **285** (1): 49-55, (2000).
- [13] Emadi, D., J. Gruzleski, and J. Toguri, *Metallurgical and Materials Transactions B*, **24** (6): 1055-1063, (1993).
- [14] Huang, J., J.G. Conley, and T. Mori, *Metallurgical and Materials Transactions B*, **29** (6): 1249-1260, (1998).
- [15] Roy, N., A. Samuel, and F. Samuel, *Metallurgical and Materials transactions A*, **27** (2): 415-429, (1996).
- [16] Campbell, J., *Metallurgical and Materials Transactions B*, **37** (6): 857-863, (2006).
- [17] Campbell, J., *Materials science and technology*, **22** (2): 127-145, (2006).
- [18] Campbell, J. The bifilm concept: prospects of defect-free castings, *in World Foundry Congress, Chennai, India*. (2008).
- [19] Dispınar, D. and J. Campbell, *International Journal of Cast Metals Research*, **17** (5): 280-286, (2004).
- [20] Dispınar, D. and J. Campbell, *International Journal of Cast Metals Research*, **17** (5): 287-294, (2004).
- [21] Fiorese, E., F. Bonollo, G. Timelli, L. Arnberg, and E. Gariboldi, *International Journal of Metalcasting*, **9** (1): 55-66, (2015).
- [22] Birol, Y., *International Journal of Cast Metals Research*, **23** (4): 250-255, (2010).
- [23] El-Sayed, M.A. and K. Essa, *Computational and Experimental Studies*, **23**: (2018).
- [24] Yuksel, C., O. Tamer, E. Erzi, U. Aybarc, E. Cubuklusu, O. Topcuoglu, M. Cigdem, and D. Dispınar, *Archives of Foundry Engineering*, **16** (3): 151-156, (2016).
- [25] Tiryakiođlu, M., P. Davami, S.-K. Kim, Y.O. Yoon, G.-Y. Yeom, and N.-S. Kim, *Materials Science and Engineering: A*, **605**: 203-209, (2014).
- [26] Uludağ, M., L. Gemi, M.R. Eryılmaz, and D. Dispınar, *Pamukkale University Journal of Engineering Sciences*, **21** (8): 348-351, (2015).
- [27] Uludağ, M., *International Journal of Engineering Research and Development*, **10** (1): 30-41, (2018)
- [28] Mostafaei, M., M. Ghobadi, M. Uludağ, and M. Tiryakiođlu, *Metallurgical and Materials Transactions B*, **47** (6): 3469-3475, (2016).
- [29] Tunçay, T., S. Tekeli, D. Özyürek, and D. Dispınar, *International Journal of Cast Metals Research*, **30** (1): 20-29, (2017).
- [30] Nayhumwa, C., N. Green, and J. Campbell, *Metallurgical and Materials Transactions A*, **32** (2): 349-358, (2001).
- [31] Dispınar, D. and J. Campbell, *International Journal of Cast Metals Research*, **19** (1): 5-17, (2006).
- [32] Dispınar, D., S. Akhtar, A. Nordmark, M. Di Sabatino, and L. Arnberg, *Materials Science and Engineering: A*, **527** (16): 3719-3725, (2010).
- [33] Raiszadeh, R. and W. Griffiths, *Journal of alloys and compounds*, **491** (1): 575-580, (2010).
- [34] Dispınar, D. and J. Campbell, *Materials Science and Engineering: A*, **528** (10): 3860-3865, (2011).
- [35] Yorulmaz, A., Ç. Yüksel, E. Erzi, and D. Dispınar. Effects of Casting Conditions on End Product Defects in Direct Chill Casted Hot Rolling Ingots, *in Shape Casting: 6th International Symposium*. Springer, (2016).
- [36] Handbook, M., *ASM International*, 238-241, (1988).
- [37] Eastwood, L.W., *Gases in Light Alloys*, **70**: (1946).
- [38] Samuel, A. and F. Samuel, *Journal of Materials Science*, **27** (24): 6533-6563, (1992).
- [39] Tiryakiođlu, M., J. Campbell, and J. Staley, *Scripta materialia*, **49** (9): 873-878, (2003).
- [40] Tiryakiođlu, M. and J. Campbell, *Metallurgical and Materials Transactions A*, **41** (12): 3121-3129, (2010).
- [41] Chen, Y.-J., H.-Y. Teng, and Y.-T. Tsai, *Journal of materials engineering and performance*, **13** (1): 69-77, (2004).
- [42] Campbell, J., Castings, *Butterworth, Heinemann*, Oxford. (1991),
- [43] Zupanič, F., S. Spaić, and A. Krizman, *Materials science and technology*, **14** (12): 1203-1212, (1998).
- [44] Li, H., T. Sritharan, Y. Lam, and N. Leng, *Journal of Materials Processing Technology*, **66** (1-3): 253-257, (1997).

- [45] Sigworth, G. and M. Guzowski, *AFS Transactions*, 93 (172): 907-912, (1985).
- [46] Gruzleski, J.E. and B.M. Closset, *The treatment of liquid aluminum-silicon alloy*, *Amer Foundry Society*, (1990).
- [47] Uludağ, M., R. Çetin, D. Dispınar, and M. Tiryakiođlu, *Metals*, 7 (5): 157, (2017).
- [48] Uludağ, M., L. Gemi, and D. Dispınar, *International journal of scientific and technical research in engineering (IJSTRE)* 1 (8): 21-26, (2016).
- [49] Campbell, J. and M. Tiryakiođlu, *Materials Science and Technology*, 26 (3): 262-268, (2010).
- [50] Samuel, A., H. Doty, S. Valtierra, and F. Samuel, *Materials & Design*, 56: 264-273, (2014).
- [51] Sui, Y., Q. Wang, G. Wang, and T. Liu, *Journal of Alloys and Compounds*, 622: 572-579, (2015).
- [52] El-Sayed, M.A., *Journal of Engineering Technology* (ISSN: 0747-9964), 6 (1): 584-594, (2018).
- [53] Nozari, M.A., R. Taghiabadi, M. Karimzadeh, and M. Ghoncheh, *Metallurgical and Materials Transactions B*, 49 (3): 1236-1245, (2018).
- [54] Griffith, A.A., *Philosophical transactions of the royal society of london, Series A, containing papers of a mathematical or physical character*, 221: 163-198, (1921).
- [55] Pierce F.T., *J. Textile Inst.*, 17, T355-68, (1926).
- [56] Weibull, W., *Journal of applied mechanics*, 103 (730): 293-297, (1951).
- [57] Weibull W., *Proc. Royal Swedish Inst. Eng. Res.*, 151: (1939).
- [58] Davami, P., S. Kim, and M. Tiryakiođlu, *Materials Science and Engineering: A*, 579: 64-70, (2013).
- [59] El-Sayed, M. and W. Griffiths, *International Journal of Cast Metals Research*, 27 (5): 282-287, (2014).
- [60] Tan, E., A. Tarakcilar, and D. Dispınar, *Materialwissenschaft und Werkstofftechnik*, 46 (10): 1005-1013, (2015).
- [61] Dispınar, D., A. Nordmark, J. Voje, and L. Arnberg. Influence of hydrogen content and bi-film index on feeding behaviour of Al-7Si, in *138th TMS Annual Meeting, Shape Casting: 3rd International Symposium, San Francisco, California, USA, (February 2009)*. (2009).
- [62] Mohanty, P. and J. Gruzleski, *Acta Metallurgica et Materialia*, 43 (5): 2001-2012, (1995).
- [63] Guzowski, M., G. Sigworth, and D. Sentner, *Metallurgical and Materials Transactions A*, 18 (4): 603-619, (1987).
- [64] Jung, B., C. Jung, T. Han, and Y. Kim, *Journal of Materials Processing Technology*, 111 (1), 69-73, (2001).
- [65] Timelli, G., G. Camicia, and S. Ferraro, *Journal of materials engineering and performance*, 23 (2): 611-621, (2014).
- [66] Górný, M., G. Sikora, and M. Kawalec, *Archives of Foundry Engineering*, 16: (2016).
- [67] Campbell, J., *Castings practice: the ten rules of castings. Elsevier*, (2004).
- [68] Bozchaloei, G.E., N. Varahram, P. Davami, and S.K. Kim, *Materials Science and Engineering: A*, 548: 99-105, (2012).
- [69] Caceres, C. and B. Selling, *Materials Science and Engineering: A*, 220 (1-2): 109-116, (1996).
- [70] Tiryakiođlu, M. and J. Campbell, *International Journal of Metalcasting*, 8 (3): 39-42, (2014).
- [71] Ludwig, T., M. Di Sabatino, L. Arnberg, and D. Dispınar, *International Journal of Metalcasting*, 6 (2): 41-50, (2012).
- [72] Dispınar, D., A. Kvithyld, and A. Nordmark, *Quality Assesment of Recycled Aluminium, Light Metals*, Springer. p. 731-735, (2011).
- [73] Prasanna, S., C. Ramesh, R. Manivel, and A. Manikandan. Preparation of Al6061-SiC with Neem Leaf Ash in AMMC's by Using Stir Casting Method and Evaluation of Mechanical, Wear Properties and Investigation on Microstructures. in *Applied Mechanics and Materials Trans Tech Publ*, (2017).
- [74] Dispınar, D., S. Akhtar, A. Nordmark, F. Syvertsen, M. Di Sabatino, and L. Arnberg. Correlation between Mechanical Properties and Porosity Distribution of A356 in Gravity Die Casting and Low Pressure Die Casting, *Advanced Materials Research. Trans Tech Publ*, (2012).
- [75] Tiryakiođlu, M., J. Campbell, and N.D. Alexopoulos, *Metallurgical and Materials Transactions B*, 40 (6): 802, (2009).
- [76] Erzi, E., B. Bakirciođlu, L. Gemi, Ş. Yazman, M. Uludağ, and D. Dispınar, *Journal of Testing and Evaluation*, 46 (6): (2018).