

Estimation of Cutting Forces Obtained by Machining AISI 1050 Steel with Cryo-Treated and Untreated Cutting Insert by Using Artificial Neural Network

¹Şehmus Baday  , ²Onur Ersöz 

¹Department of Mechanical and Manufacturing Engineering, Batman University, Turkey

²Institute of Science, Batman University, Turkey

Corresponding author: Şehmus Baday (sehmus.baday@batman.edu.tr).

ABSTRACT Cutting force is one of the most important criteria for evaluating machinability of workpieces. For this purpose, in present study, prediction of the cutting forces obtained by turning AISI 1050 steel with cryo-treated and untreated CVD-coated cutting inserts with artificial neural networks (ANN) was investigated. Machining parameters such as feed rate, cutting speed and conditions of cutting insert were selected. These parameters were used as input parameters while cutting force was used as output parameter. The employed ANN structure was chosen according to network type, training function, adaption learning function and performance function as feed-forward back propagation, TRAINLM, LEARNGD and MSE, respectively. Thus, the estimation values of the cutting forces attained from ANN model during training and experimental values coincide perfectly with the regression lines, which make the $R^2 = 0.99874$ in training. For this reason, cutting force was explained by ANN with an acceptable accuracy in this study.

KEYWORDS: ANN, Cutting force, Cutting insert, Cryogenic heat treatment

1. INTRODUCTION

The ANN has been applied to many areas such as prediction of cutting forces, surface roughness, vibration, tool wear, and tool temperature etc. The cutting force is one of the most important criteria for interpreting machinability of workpieces. Cutting parameters such as depth of cut, cutting speed, feed rate and tool toughness are the most effective parameters on the cutting forces [1-3], which are changed with heat treatment processes that applied cutting insert. Cryogenic heat treatment is one of them for improving cutting tool toughness. Therefore, deep cryogenic heat treatment is applied the CVD-coated cutting inserts. Some studies on cutting forces are given below:

Baday [4] investigated prediction of cutting force, obtained during turning AISI 1050 steel, which is applied heat treatment, by using ANN. In the ANN model, feed-forward back propagation as the network type, TRAINLM, BFGS and SCG as the training function, LEARNGD as the adaption learning function, one hidden layer with 10 to 15 neurons, was selected to obtain the best R2 result. Hanief et al. [5] studied modeling and prediction of cutting force, obtained from turning of red brass, by using ANN and regression analysis. They stated that the regression model is able to estimate the cutting force with high accuracy. Nevertheless, the estimation of ANN structure is much better than that of regression model. Gürbüz et al. [6] investigated the effect of cutting inserts with different chip breaker forms on cutting force and modeled them with mathematical formulizations. They analyzed cutting force with 10 different mathematical models for different chip breaker forms. They mentioned that of the mathematical models, polynomial modeling was obtained with the best result, while with Fourier model, they obtained the worst results. Başak et al. [7] analyzed cutting force and surface roughness with

regression and ANOVA analyses. They observed that feed rate was the most significant parameter on surface roughness according to ANOVA analyses. They attained $R^2 = 94.6, 94.2\%$ values for cutting force and surface roughness, respectively. Yağmur et al. [8] investigated cutting force during milling of carbon fiber reinforced composite materials via mathematical modeling and they evaluated it. They revealed that increasing cutting speed positively affected cutting forces. Furthermore, the effective parameters on cutting forces were analyzed according to the ANOVA. Ulas et al. [9] studied prediction of cutting forces obtained during turning AISI 304 (Austenitic), AISI 420 (Martensitic) and AISI 2205 (Duplex) stainless steels using ANN techniques. They found that prediction of cutting force with ANN and experimental data were very close to each other. Uzun et al. [10] examined the effect of mechanical properties of AISI 5140 steel on cutting forces, obtained during turning workpiece. They observed that when cutting speed increased, generally, cutting forces obviously decreased. Özkan et al. [11] examined the prediction of cutting forces attained from different cutting conditions during turning operation by using ANN model. They determined that the implemented ANN model was in good agreement with estimation of cutting forces. Kurt et al., [12] developed a mathematical model for estimation of cutting forces. Depending on cutting parameters such as depth of cut, feed rate, cutting speed, and rake angle of the chip breaker of cutting insert, they performed estimation of cutting forces by using regression analyses, which is a statistical analysis method. Jeyakumar et al. [13] investigated the impact of machining parameters such as feed rate, depth of cut, spindle speed and nose radius on the cutting force. They predicted cutting forces with response surface method considering machining parameters. They found that predicted and experimental cutting force values were in good agreement with each other. Kara et al. [14] utilized ANN in their study to predict the main cutting forces, which are orthogonally obtained from machining AISI 304 stainless steel. They received input parameters in ANN model such as feed rate, cutting speed and coating type. They found that the prediction of cutting force value with ANN and experimental values were in good agreement with each other. Asiltürk et al. [15] carried out the estimation of cutting forces by using ANN model in turning 4140 steel considering feed rate, cutting speed and depth of cut. They indicated that the implemented ANN model had good performance for prediction of cutting force.

In the view of the literature, many researchers investigated prediction of cutting forces considering cutting parameters using ANN, mathematical model and experimental methods. However, prediction of cutting forces obtained from cryogenically heat-treated CVD-coating cutting insert has not been come across in the literature. For this purpose, in this study, prediction of cutting forces attained from machining AISI 1050 steel with CVD-coating insert by using ANN was investigated.

2. MATERIALS and METHOD

In this study, workpiece material was chosen as AISI 1050 steel bar with a diameter of 60 mm, which was turned 1.5 mm depth of cut for longitudinal turning in this experimental. Cutting insert was selected as CVD coated WNMG with MP, which is medium chip breaker, for using generally medium carbon steel in machining. This cutting insert is given in Figure 1. Machining experiments were carried out on CNC turning machine in accordance with cutting parameters, which were specified depending on the knowledge of manufacturing procedures, which are advised as ideal conditions in medium carbon steel. Therefore, cutting speed was selected as 200, 220 and 240 m/min, and feed rates was selected as 0.1, 0.2 and 0.3 mm/rev. The depth of cut was remained constant as 2 mm in the machining experiments. A new cutting insert was used in each machining experiment to obtain the same cutting condition. Main cutting force was measured using KISTLER Type 5070 dynamometer, which obtains three-component piezoelectric.

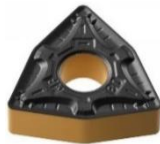

Figure 1. CVD-coated WNMG-MP carbide turning insert

2.1. Deep Cryogenic Heat Treatment

According to literature review, the holding time of cryogenic heat is attained 24 hours in terms of cutting tool wear [16, 17]. In this study, deep cryogenic heat treatment was subjected to CVD coated cutting insert in three stages: In first stage, cutting inserts were cooled down slowly at the temperature, which came down from room temperature to deep cryogenic treatment (-146°C) in 2 hours. In the second stage, inserts were hold at -146°C for soaking time namely for 24 hours and then brought back to room temperatures. Finally, they were tempered at 200°C two times oscillating, which lasted for 2 hours. All stages are shown in Figure 2.

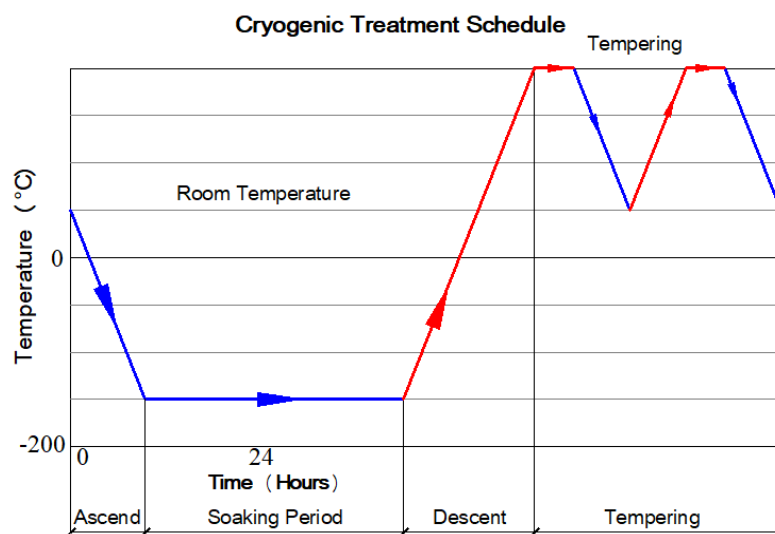

Figure 2. Deep cryogenic treatment cycle

3. ANN MODEL

Because of the fact that the ANN has a capability of solving nonlinear problems, it has been applied numerous fields for predictions used by researchers. Therefore, in present study, the ANN was employed to estimate cutting forces during turning AISI 1050 with cryo-treated and untreated CVD-coated cutting inserts. ANN methods are able to solve complex problems by using layers. Input layers were selected from cutting parameters such as cutting speed, feed rate and heat treatment condition of cutting insert while output layer was selected from cutting forces. Hidden layers received out of cutting speed, feed rate and cutting insert condition data with transfer function, which was selected as logsid transfer function, and balanced with bias weights. These transfer function types are given in Figure 3. Then, hidden layer data was transported to output layers. Finally, the result of cutting forces was computed by hidden layers and transferred to output layer by using transfer function, chosen as purelin transfer function. The created ANN model is shown schematically in Figure 4. Generally, three transfer functions were used in ANN methods. The Created ANN properties are given in Table 1.

Table 1. ANN properties

Network Type	Feed-forward back propagation
Input data	Cutting speed, feed rate, cutting insert condition
Output data	Cutting force
Training function	TRAINLM
Adaption learning function	LEARNGD
Performance function	MSE
Number of layers	3 (1 input, 1 hidden and 1 output layer)

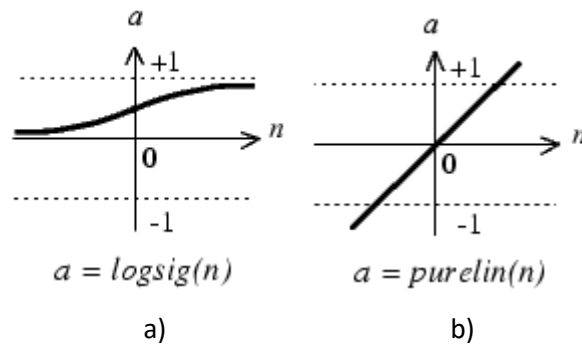

Figure 3. Transfer function a) Logsid b) Purelin

Depending on the input parameters, the output parameter obtained from ANN structures is given in Fig. 4.

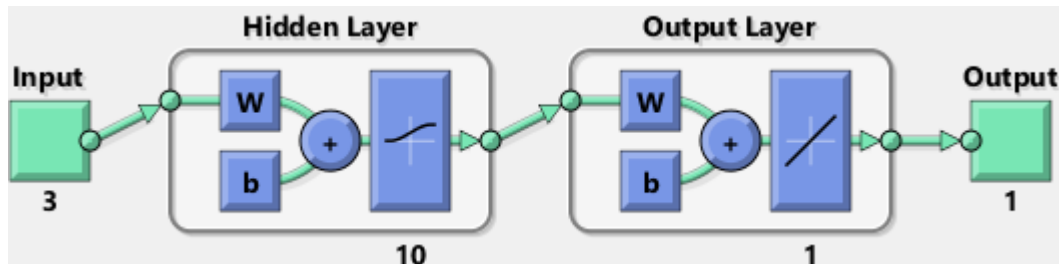

Figure 4. ANN structure

Figure 5 shows the structure of ANN used in this experimental study. Because of the number of input and output parameters, input layer has three neurons and output layer has one neuron. Hidden layers have 10 neurons in ANN structure. Depending upon the selected parameters, the ANN structure was trained, and is given in Figure. 5.

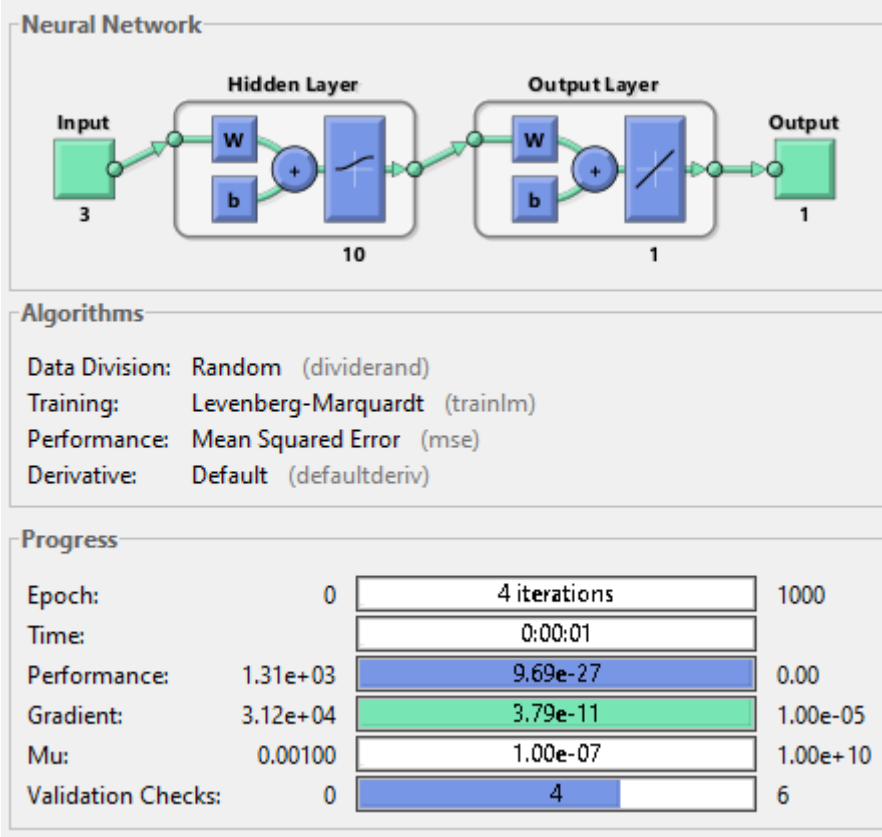

Figure 5. Neural Network Training

4. RESULTS

4.1. Results of Cutting Forces

Figure 6-7 reflect cutting forces of deep cryogenic treated inserts and untreated inserts. It is known that the cutting forces measured during machining of workpiece were increased with increasing feed rate in all cutting inserts, which is shown in Figure 6-7. According to evaluation of cutting forces, cryogenic treated cutting insert is generally lower than untreated cutting insert. This case was clearly happened at high cutting speed. This situation explains that cutting insert, which was subjected to cryogenic heat treatment, improved hardness and toughness. Furthermore, cryogenically heat treatment brings the cutting tool steel in transformation of retained and homogenously carbide distribution at subzero temperature [18, 19].

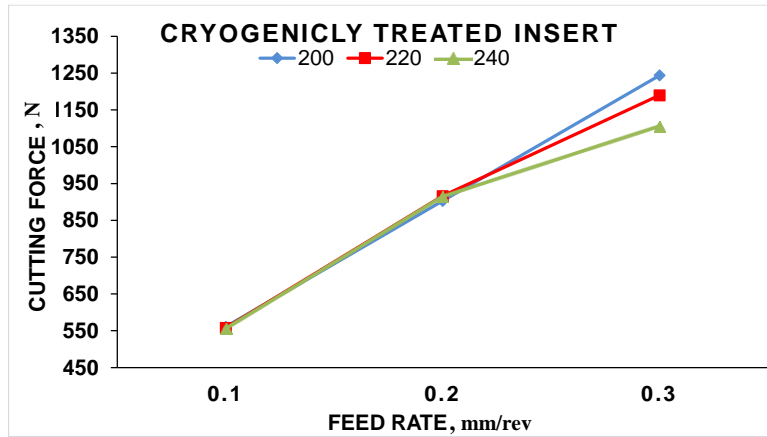

Figure 6. Cutting forces obtained from cryogenically treated insert

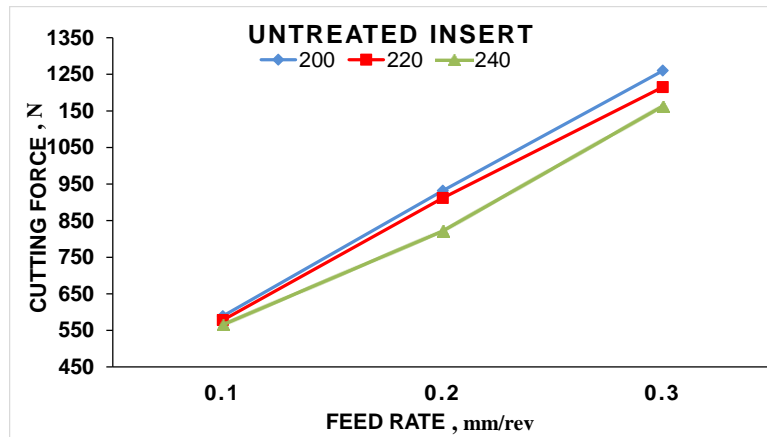

Figure 7. Cutting forces obtained from untreated insert

4.1. Results of ANN

The created ANN structure for predicting cutting forces was trained by Levenberg-Marquardt and evaluated by MSE (Mean Square Error). The result of the ANN structure in the study is shown in Figure 8, 9 and 10.

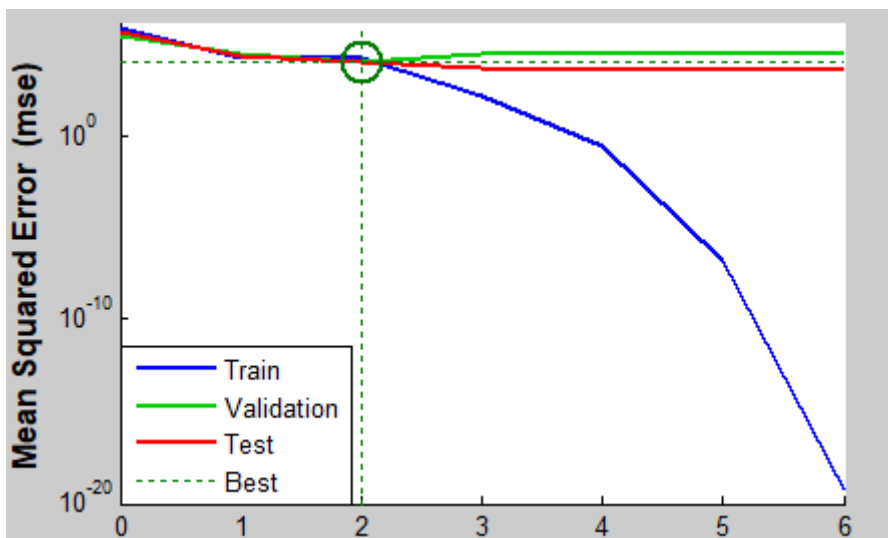

Figure 8. Neural Network Training Performance

Figure 8 shows the performance of ANN structure. The best validation performance is 11752.8556 at epoch 2 in cycling 6 epochs. In prediction capacity of ANN structure, error capacity over passing 2 epochs decreased so that the program ended in 2 epochs. Figure 9 depicts neural network training state for ANN. It shows values of gradient, mu and failure at epoch 6 ANN structure checked for validation at epoch 6. When epoch passed 1, the ANN structure stopped after validation 3.

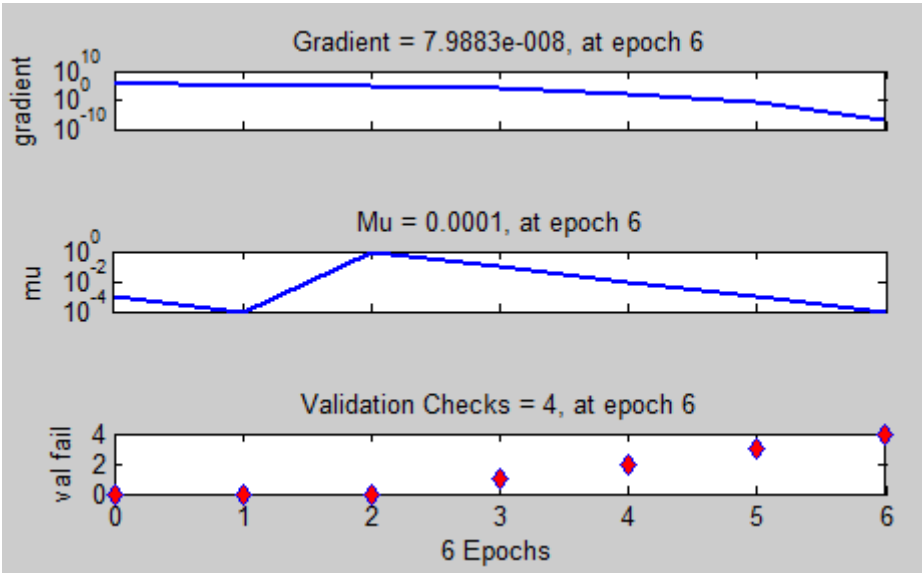

Figure 9. Neural Network Training State

The structure of trained ANN results is presented in Figure 10. It can be clearly seen from Figure 10 that R square of training, validation, test and all values are 0.99874, 0.98489, 0.99995 and 0.99575, respectively. It is said that the ANN structure estimation of all R square is enough to estimate the range from 0.9 to 1. Consequently, the prediction values of cutting forces obtained from ANN structure during training and experimental values coincide completely with the regression lines, which make the $R^2 = 0.99874$ in training. Furthermore, all data were predicted in good agreement with each other. All predicted cutting forces are valid for the ANN structure.



Figure 10. Neural network training regression

5. CONCLUSION

In present paper, the implementation of ANN model for estimating cutting forces was utilized with turning of AISI 1050 steel by using different cutting parameters; and the following results were drawn from this experimental study:

- The implemented ANN structure predicted outcomes of cutting forces, which were highly compatible values.
- Values of R^2 were attained from ANN structure as 0.99874, 0.98489, 0.99995 and 0.99575 for training, validation test and all, respectively.
- The experimental and prediction of cutting forces with ANN were highly consistent with each other.
- When the cutting speed was increased, cutting force decreased. However, when the feed rate was increased, cutting forces increase.

Acknowledgement

This research was supported by Batman University Scientific Research Projects Unit (BTUBAP), project no BTÜBAP-2019-YL-07. Many thanks to BTUBAP for financial support.

REFERENCES

- [1] J. Kratochvíl, J. Petřů, M. Pagáč, J. Holubjak, and J. Mrazik, “Effect of Chip Breakers on The Cutting Force During The Machining of Steel C45.” *Advances in Science and Technology Research Journal*, vol. 11, no. 1, pp. 173-178, 2017.
- [2] B. Yılmaz, Ş. Karabulut, and A. Güllü, “Performance analysis of new external chip breaker for efficient machining of Inconel 718 and optimization of the cutting parameters.” *Journal of Manufacturing Processes*, vol. 32, pp. 553-563, 2018.
- [3] Ş. Baday, H. Bařak, and A. Gural, “Analysis of spheroidized AISI 1050 steel in terms of cutting forces and surface quality.” *Kovove Mater.*, vol. 54, pp. 315-320, 2016.
- [4] Ş. Baday, “Kureselleřtirme ısıl iřlemi uygulanmıř AISI 1050 elięin tornalanmasında esas kesme kuvvetlerinin yapay sinir aęları ile modellenmesi.” *Technological Applied Sciences*, vol. 11, no. 1, pp. 1-9, 2016.
- [5] M. Hanief, M.F. Waniand, and M.S. Charoo, “Modeling and prediction of cutting forces during the turning of red brass (C23000) using ANN and regression analysis.” *Engineering science and technology, an international journal*, vol. 20, no. 3, pp. 1220-1226, 2017.
- [6] H. Gurbuz, F. Sonmez, Ş. BADAY, and U. řeker, “Farklı Talař Kırıcı Formlarının Esas Kesme Kuvvetlerine Etkisinin Matematiksel Modellenmesi.” *Batman niversitesi Yařam Bilimleri Dergisi*, vol. 8, no. 2/2, pp. 13-21, 2018.
- [7] H. Bařak, ve Ş. Baday, “Kureselleřtirilmiř orta karbonlu bir elięin iřlenmesinde, kesme parametrelerinin kesme kuvvetleri ve yuzey puruzlulugune etkilerinin regresyon analizi ile modellenmesi.” *Pamukkale niversitesi Muhendislik Bilimleri Dergisi*, vol. 22, no 4, pp. 253-258, 2016.
- [8] S. Yagmur, A. Kurt, and U. Seker, “Evaluation and mathematical modeling of delamination and cutting forces in milling of carbon fiber reinforced composite (CFRP) materials.” *Journal of the Faculty of Engineering and Architecture of Gazi University*, vol. 35, no. 1, pp. 457-465, 2020.
- [9] H.B. Ulas, and M.T. Ozkan, “Turning processes investigation of materials austenitic, martensitic and duplex stainless steels and prediction of cutting forces using artificial neural network (ANN) techniques.” *Indian Journal of Engineering and Materials Sciences*, vol. 26, no. 2, pp. 93-104, 2019.
- [10] G. Uzun, and . ifti, “ 5140 elięinin mekanik zelliklerinin takım ařınması ve kesme kuvvetlerine etkisinin incelenmesi.” *Politeknik Dergisi*, vol. 15, no. 1, pp. 29-34, 2012.
- [11] A.. zkan, . Sarıtař, and S. Yıldız, “Tornalama řleminde Kesme Kuvvetlerinin ve Takım Ucu Sıcaklıęının Yapay Sinir Aęı ile Tahmin Edilmesi, 5. Uluslararası İleri Teknolojiler Sempozyumu (IATS’09), Karabuk, Turkiye, 2009, pp. 13-15.
- [12] A. Kurt, S. Suruculer, ve A. Kirik, “Kesme Kuvvetlerinin Tahmini İin Matematiksel Bir Model Geliřtirme.” *Politeknik Dergisi*, vol. 13, no. 1, pp. 15-20, 2010.

- [13] S. Jeyakumar, K. Marimuthu, and T. Ramachandran, "Prediction of cutting force, tool wear and surface roughness of Al6061/SiC composite for end milling operations using RSM." *Journal of Mechanical Science and Technology*, vol. 27, no. 9, pp. 2813-2822, 2013.
- [14] F. Kara, K. Aslantas, and A. Çiçek, "ANN and multiple regression method-based modelling of cutting forces in orthogonal machining of AISI 316L stainless steel." *Neural Computing and Applications*, vol. 26, no 1, pp. 237-250, 2015.
- [15] I. Asilturk, H. Kahramanli, H.E. Mounayri, "Prediction of cutting forces and surface roughness using artificial neural network (ANN) and support vector regression (SVR) in turning 4140 steel." *Materials Science and Technology*, vol. 28, no. 8, pp. 980-986, 2012.
- [16] N.A. Özbek, A. Çiçek, M. Gülesin, and O. Özbek, "Investigation of the effects of cryogenic treatment applied at different holding times to cemented carbide inserts on tool wear." *International Journal of Machine Tools and Manufacture*, vol. 86, pp. 34-43, 2014.
- [17] A.D. Shirbhate, N.V. Deshpande, and Y.M. Puri, "Effect of cryogenic treatment on cutting torque and surface finish in drilling operation with AISI M2 high speed steel." *International Journal of Mechanical Engineering Robotics Research*, vol. 1, no. 2, pp. 50-58, 2012.
- [18] D. Candane, N. Alagumurthi, and K. Palaniradja, "Effect of cryogenic treatment on microstructure and wear characteristics of AISI M35 HSS." *International Journal of Materials Science and Applications*, vol 2, no. 2, pp. 56–65, 2013.
- [19] S. Akincioğlu, H. Gökkaya, and İ. Uygur, "A review of cryogenic treatment on cutting tools." *The International Journal of Advanced Manufacturing Technology*, vol. 78, no 9-12, pp. 1609-1627, 2015.