

Electric Wheel Hub Motor for Aircraft Application

Michael Schier*‡, Frank Rinderknecht**, HeribertHellstern*

* Department of Vehicle Energy Concepts, Institute of Vehicle Concepts, German Aerospace Center,
Pfaffenwaldring 38-40, D-70569 Stuttgart, Germany

** Department of Alternative Energy Converters, Institute of Vehicle Concepts, German Aerospace Center,
Pfaffenwaldring 38-40, D-70569 Stuttgart, Germany

‡ Michael Schier, Pfaffenwaldring 38-40, D-70569 Stuttgart, Germany, Tel: +49 711 6862 535, Fax: +49 711 6862 258,
e-mail: michael.schier@dlr.de, frank.rinderknecht@dlr.de, heribert.hellstern@dlr.de

Received:24.08.2011 Accepted:05.10.2011

Abstract-The German Aerospace Centre has dealt with the question of whether it is possible to taxi a passenger aircraft without emissions on the taxiing field. The Institute of Vehicle Concepts has designed and built a prototype of an electric wheel hub motor to use it in the research aircraft Airbus A320 of the German Aerospace Centre. Special requirements to the motor are the torque for break away operation, the static load and the possibility to switch two gear ratios. The project was a part of an overall research project for the integration of fuel cells in aircrafts to reduce fuel consumption and air pollution. A positive side effect is the reduction of the ground-based transport vehicles traffic and thus a reduction in the risk of accidents. The paper describes the development of the electric wheel hub motor.

Keywords-Wheel hub motor, aircraft application, autonomous taxiing, electrical drive, permanent magnet machines, synchronous machines, brushless DC-motors, planetary gear.

1. Introduction

Passenger aircrafts are rolling from the terminal to the start position, often they are pushed back from the terminal with a tractor by using a towbar. After landing, they roll back to the terminal. All taxiing operation is done with running engines while they are not very efficient. An electric drive could save fuel and could reduce the emissions. It also could reduce the ground-based traffic and could make an autonomous taxiing and push back operation possible.

According to the reflections in the automotive branche fuel cells can contribute to future energy supply in aircraft applications. In this project a fuel cell system provides the energy supply for the drive. It is positioned in the rear cargo area and produces only water as an exhaust liquid medium, which could be used for the restrooms. The inertial exhaust gas advantageously is used to fill the tanks of the aircraft. This multifunctional behaviour is the reason to use fuel cells instead of batteries.

The electric machine is operated with an inverter from the automotive sector. The main landing gear with the brakes inside of the wheels provides not enough space for an electric motor. Therefore, the installation space within the rim of the nose landing gear is used.

2. System Requirements

The speed of a passenger aircraft Airbus A320 is at about 25 km/h and the weight of the aircraft is up to 80 t. With a given rolling friction coefficient of 1.5 % and potential slopes of the taxiing field there results a required torque in the order of 5 to 10 kNm and a wheel speed of 170 1/min.

For the design of the drive a weight of 50 tons, a nose wheel load of 5 tons and a maximum speed of 25 km/h were assumed. For the taxiing operation then only a torque of 2.8 kNm is required, for break away operation theoretically four times of this value.

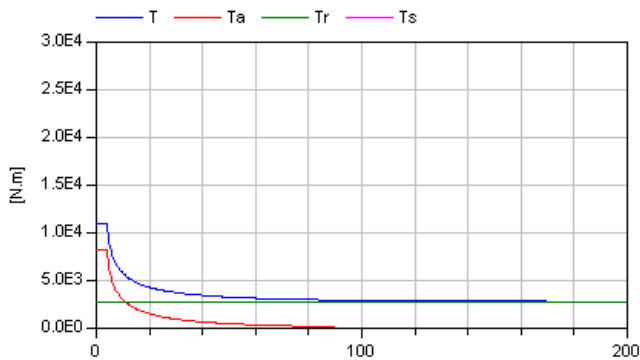

Fig.1. Torque-behaviour of the drive

The behaviour of the drive is simulated as shown in fig. 1, fig 2 and fig 3. In this figures the blue line shows the total value (no index), the red lines stand for acceleration (index a) and the green for rolling (r), while the slope in this case is zero.

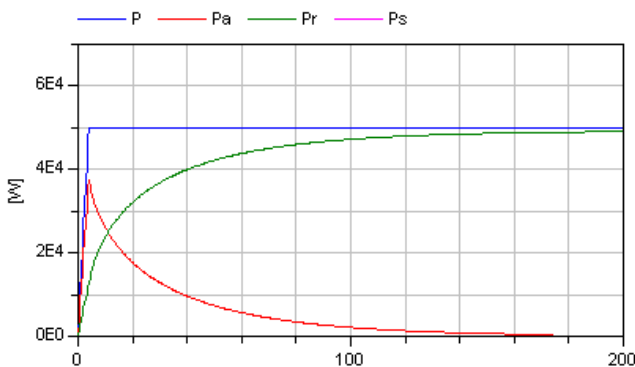

Fig.2. Power-behaviour of the drive

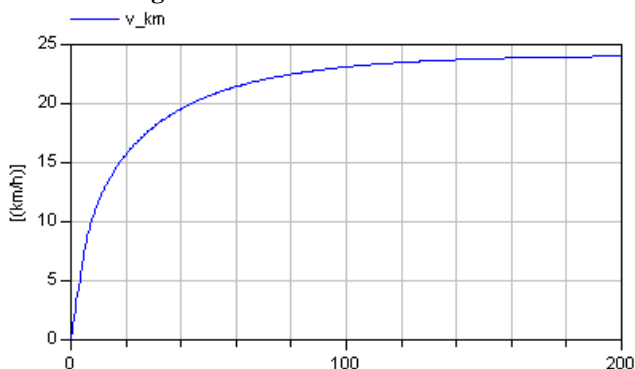

Fig.3. Speed-behaviour of the drive

To consolidate the assumptions towing force measurements were carried out on several planes A319 at the airport. The forces were measured with a load cell that was built into the towbar. The measurements confirmed that an aircraft A319 can be maintained on a plane surface with a towing force of 6 kN (fig. 4). In the figure the towing force at three break away experiments, plotted against time is shown. The difficulty in measurement for the tractor is to start as gently as possible to keep the acceleration force small. The significant negative force peaks are clear brake

controls so that it is easier to see the following break away forces. Regarding the radius of the wheel the equivalent of a torque of about $6 * 0.385 \text{ m} = 2.25 \text{ kNm}$ results. The values are relatively small in comparison to the first assumptions and thus it is seen that the requirements are on the safe side.

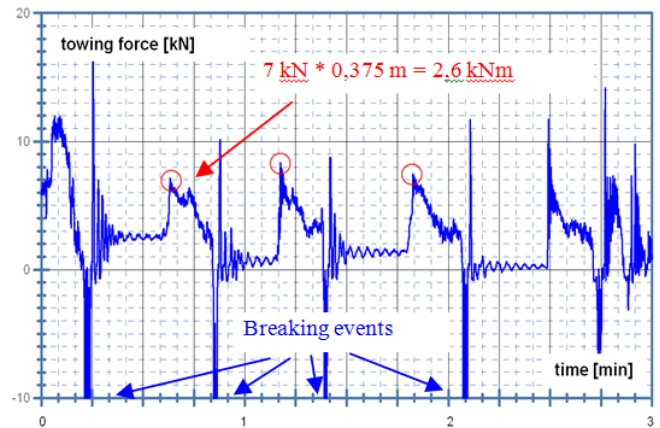

Fig.4. Towing force measurement of an aircraft Airbus A319

The main landing gear with the brakes inside of the wheels provides not enough space for an electric drive. Therefore, the installation space within the rim of the nose landing gear is used.

A wheel of the nose landing gear usually is mounted on a rotatable cylindrical sleeve on the axle which supports the rapid acceleration during landing and which works as a redundancy in a possible bearing failure. Under the condition of making no design changes to the chassis and the landing gear, these sleeves serves as an interface for the drive, see fig 5.

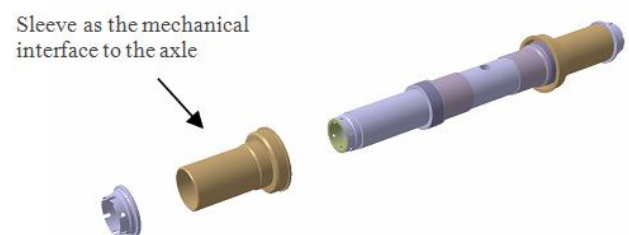

Fig.5. Sleeve as the mechanical interface to the axle of the nose leg gear

So the drive has to be designed to could be mount on this sleeve. The load torque must be linked on the strut of the landing gear with a clamp, see fig. 6. To protect the strut against excessive forces two break points are installed.

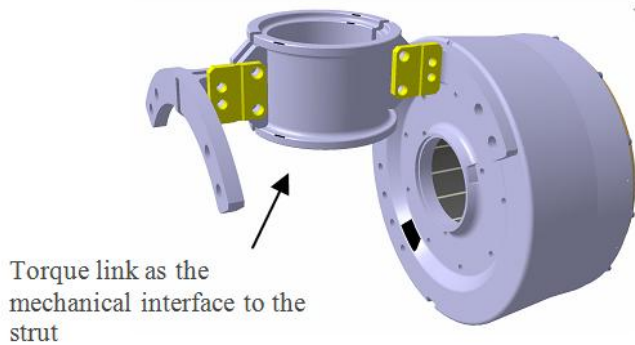

Fig.6. Torque link as the mechanical interface to the strut of the nose leg gear

3. Single Pole wined Synchronous Machine

First, it is important to know whether an electrical machine can produce the required torque in the existing space within the wheel.

The limited space inside of the original wheel does not allow the integration of an electrical machine, judging from liquid-cooled rotary machine specific forces of about 4 N/cm^2 . Therefore, it is necessary to use a gear that is an integral part of the electric machine, of course, on the condition of the low weight. The selected gearbox provides the ability to switch three gear stages, a free wheel function to protect the electric motor with respect to high speeds, a direct translation for acceleration of the wheel on landing speed and a translation stage with a ratio of 1:12 for taxiing on ground. The electric machine and the transmission with three selectable gear stages are placed within the rim. According to the gear ratio and the given torque requirement the torque behaviour of one electric machine is given in fig 7.

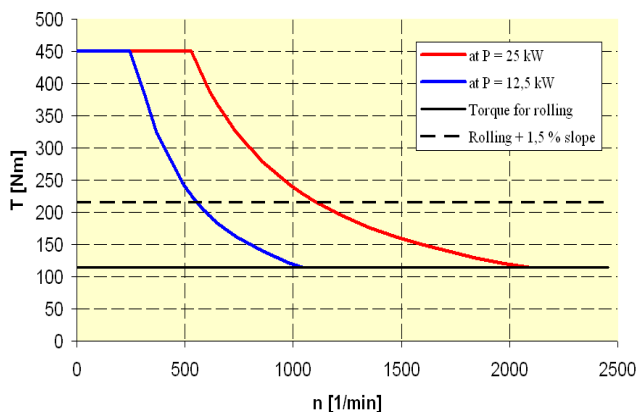

Fig.7. Torque-speed behaviour of one electric machine

The electric machine is a permanent magnet excited synchronous machine [1] with the advantage to provide the excitation field without electrical power dissipation. Compared to asynchronous machines there is the advantage of the large insensibility to the width of the air gap between the stator and the rotor [2]. As in the automotive industry there is a clear trend to electronically commutated motors [3].

For the magnets neodymium iron boron material is used because of its high remanence induction. For the selection of the electromagnetic and electronic geometry several machine types came into account [4]. The number of pole pairs is 8 and depends on the small available space in radial direction of the magnetic yoke within the rotor. The magnets are mounted directly together in the tangential direction to produce a rectangular form of the field in the airgap. Thus a high utilization and the best possible approximation to the field profile of a DC machine is achieved. The magnets are bandaged with a glass fiber reinforced plastic. For the electrical machine a wrapping technique was used in which the three-phase construction of 24 single tooth coils is built out of 8 parallel connected three-phase delta-connected systems. The winding wire is wound once and without interruption through the complete machine and each tooth coil is bound to a power rail system with 3 rails at it is shown in fig. 8.

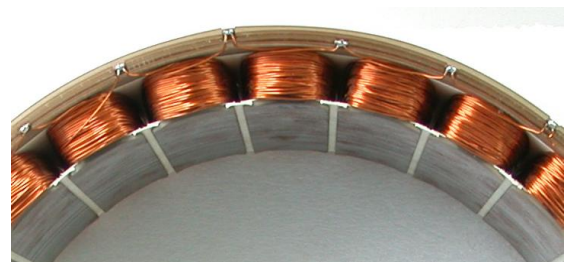

Fig.8. 3phase single tooth winding of the electric machine

The constellation of 24 nuts and 8 pole pairs leads to an electric angle $\alpha = \alpha'$ of 120 degrees between the wires lying in the neighbored nuts because the common divisor of both, nuts and pole pairs, is 8. The electric angles of the electromagnetic forces of the wires lying in the nuts and the interconnections of the wires to coils is shown in fig. 9 and fig 10. One can see the series connection of all following coils, that is a coil of the phase 1 from slot 1 and slot -2, a coil of the phase 2 from slot 2 and slot -3 and so on.

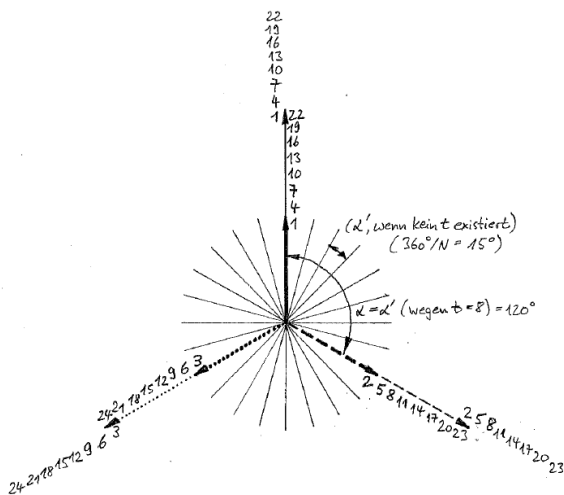

Fig.9. Phase angles of the electromagnetic force of the wires in neighbored nuts

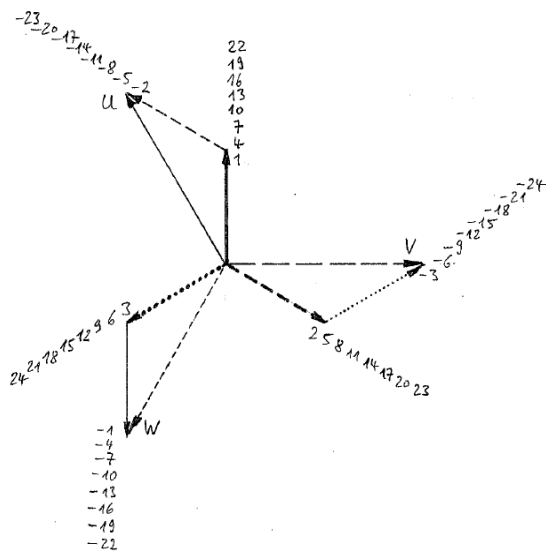

Fig.10. Combination of the electromagnetic forces of the wires in neighbored nuts to the 24 coils of the three phase winding

The coils then are connected to the named 8 parallel three-phase delta-connected systems, see the winding diagram in fig. 11. The winding can be produced in one process, it is wound without interruption and can be connected to the power rail system simultaneously.

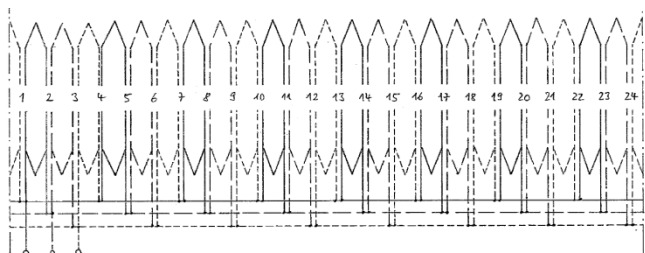

Fig.11. Winding diagram of the three phase winding with 24 nuts and 24 coils, consisting of 8 parallel delta-connected systems

Moreover the winding heads of the single tooth winding are advantageous small. The mechanical design of this machine is particularly compact.

Fig. 12 shows the qualitative rectangular form of the electromagnetic force in dependence of the time with a duration of 120 electrical degrees, which is induced in the 3phase winding and which produces the 60 degrees stair-like form of the short cut current as shown in fig. 13. Such machines have already shown their advantages in the automotive sector as highly dynamic drives [5].

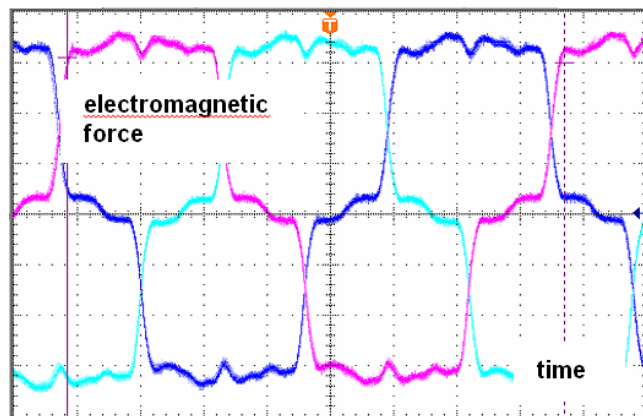

Fig.12. Qualitative diagram of the electromagnetic forces of the three phases

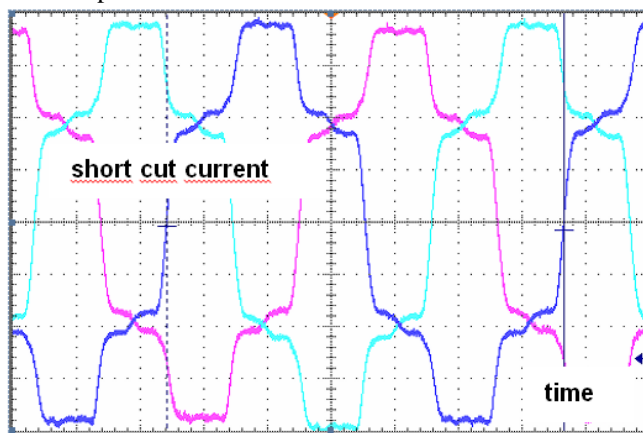

Fig.13. Qualitative diagram of the short cut current of the three phases

The rectangular use of field and current leads to a high utilisation of the active magnetic material and results in a predominantly uniform torque.

4. Two Stage Planetary Gear System

The gear system is integrated between the axle of the strut and the magnetic yoke of the rotor. This type of design allows a large diameter for the electric machine and therefore a high torque. It also uses the space to lead the forces optimal in axial direction from the stator side to the rim side.

It is a two-stage planetary gear system (fig. 14) in which the rotor directly carries the planet gears and in which the two planetary gear systems and the two sun gears each are designed with slightly different diameters and numbers of teeth. The two planetary gear systems are directly connected.

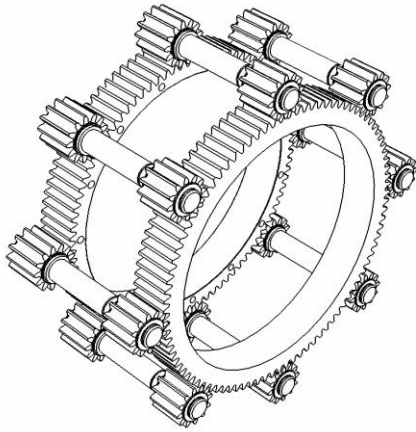

Fig.14. Two-stage planetary gear system

By relative to the environment stationary positioned stator-side sun gear the planet carrier and so the planet gears are moving with the engine speed around the sun gear. This results with

- z_{Ps} number of teeth of the stator-side planet gear,
- z_{Ss} number of teeth of the stator-side sun gear,
- n_M speed of the motor and so of the planet carrier,
- n_p speed of the planet gears

in a speed of the planet gears of

$$n_p = \frac{z_{Ss}}{z_{Ps}} \cdot n_M \quad (1)$$

which have the same rotation direction as the rotor. The rim-side sun gear would rotate at a fixed planet carrier with

- z_{Pf} number of teeth of the rim side planet gear,
- z_{Sf} number of teeth of the rim side sun gear,
- n_R speed of the rim

to

$$n_R = -\frac{z_{Pf}}{z_{Sf}} \cdot n_p \quad (2)$$

in the opposite direction as the rotor. With the in positive direction rotating planet carrier, however the speed of the rotor has to be added:

$$n_R = -\frac{z_{Pf}}{z_{Sf}} \cdot n_p + n_M \quad (3)$$

and by setting equation (1) in (3) it results to

$$\begin{aligned} n_R &= -\frac{z_{Pf}}{z_{Sf}} \cdot \frac{z_{Ss}}{z_{Ps}} \cdot n_M + n_M \\ &= n_M \cdot \left(-\frac{z_{Pf}}{z_{Sf}} \cdot \frac{z_{Ss}}{z_{Ps}} + 1 \right) \end{aligned} \quad (4)$$

or

$$\frac{n_M}{n_R} = \frac{1}{1 - \frac{z_{Pf}}{z_{Sf}} \cdot \frac{z_{Ss}}{z_{Ps}}} \quad (5)$$

5. Clutch Mechanism

In addition to the previously described function of the gear the gear ratio can also be switched to a ratio of 1:1 or a free wheel function.

In the first case, the pink coloured sun gear on the left side in fig. 15, so called stator-sided sun gear, is connected directly with the cyan coloured sun gear to the output side in fig 17, so called rim-sided sun gear, and so it is directly connected to the hub. The stator-sided sun gear is not fixed to the stator. The planet gears in this position can not roll on the sun gears. All rotating parts on the same axle then rotate at the same speed.

For a free wheel function the stator-sided sun gear may not be connected to the fixed stator, as it was necessary for the ration 1:12, and may not be connected to the rim as in the example described before. Therefore bolts can be disconnected between the stator-sided sun gear and the rim-sided sun gear. Thus, all rotating parts inside the rim rotate free against each other.

Fig. 15 shows an assembly with the name intermediate shaft, which can be coupled and decoupled to the stator and to the hub to realize the various gear ratios. They are switched by bolts or screws. The intermediate shaft also carries the bearing of the rotor. It is mounted with two ball bearings on the sleeve. In the event that the intermediate shaft is coupled to the stator, it transmits a part of the torque on the stator, whereas the other and smaller part is directly transferred as a counter-torque of the rotor to the stator.

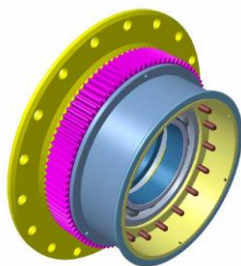

Fig.15. Stator-sided parts of the gear and the clutch, called the intermediate shaft

The rotor creates as the rotating element of the electric machine the torque and forwards as the planet carrier of the gear system the translated torque from the wheel to the stator flange. So it is made of massive iron [6], it is stuck with 384 single rectangular magnets for simplicity and carries the bearings for the planet gears, see fig. 16. The rotor itself is mounted on the intermediate shaft.

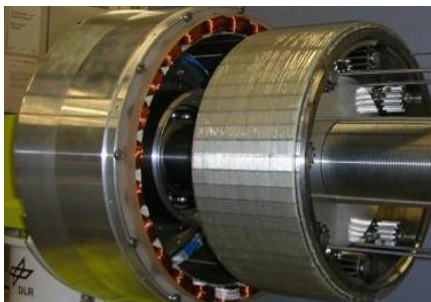

Fig.16. Rotor of the electric machine which carries the permanent magnets and the planet gears

The hub transmits a part of the weight of the airplane to the rim and is therefore mounted by two large roller bearings on the sleeve. The nose wheel load is about 10 % of the aircrafts weight. The rim-side sun gear is attached directly to the hub, see fig. 17. It should be noted that all parts have been designed so that they can be disassembled at any time again, as only a little number of prototypes were produced.

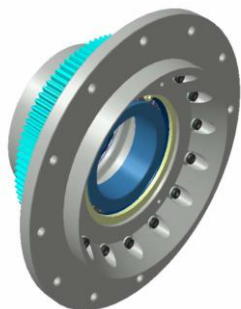

Fig.17. Rim-sided parts of the gear including the hub

6. Test Results

The main features of the drive were measured at the test bench. These are the mechanical strength of the drive and its torque.

The mechanical strength, this means the resistance to the static load, was tested on a large test bench (fig. 18) with a hydraulic actor by pressing one driven wheel against a freely mounted wheel while the deformation of the rim, especially the air gap between the stator and the rim, was monitored. In this test, it was assumed that the nose wheel load has to be taken by only one single wheel. This occurs, for example, during cornering.

The measurements confirmed the previous calculations and showed that the motor including the wheel will withstand the load.

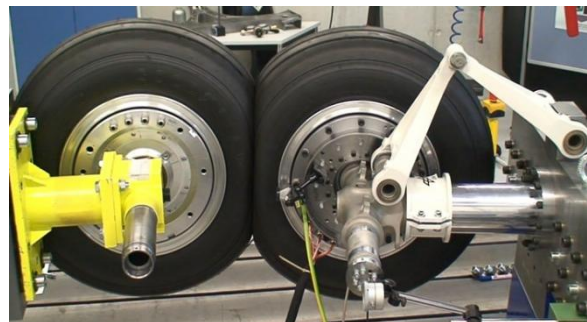

Fig.18. Static load test of the drive by pressing a driven wheel against a freely mounted wheel

In fig. 19 the torque of one motor at a speed of 50 rpm is shown, as it was measured on the motor test bench, working against a second electric load machine. A torque up to 2.5 kNm was reached within the acceptable temperature range and with the given inverter.

The drive was fed by an inverter which was developed for automotive applications. The inverter itself was supplied by a fuel cell system, including DC/DC-converters to transform the voltage of the fuel cell from a DC level of 50 V to a level of 300 V for the test equipment. The motor also may work with a DC-link-voltage up to 600 V which allows the use of inverters which are available from the industrial branch

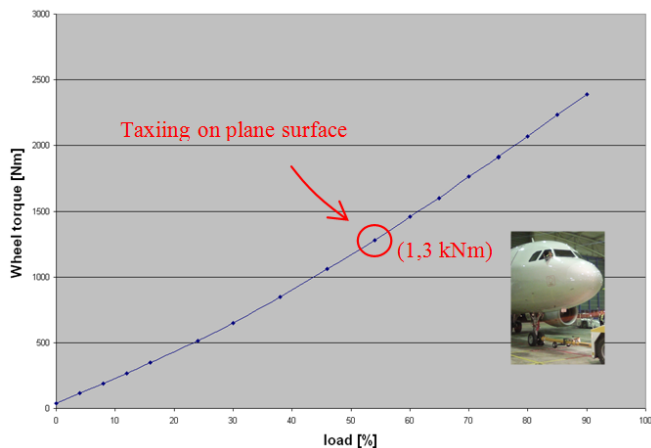

Fig.19. Torque at the rim of one wheel

Fig. 20 is the torque diagram in dependence of the phase current of a single electric machine as the machine works with a gear ratio of 1:1 in short term operation, what means in a time period less than one minute. The engine is so overloaded for a short time. It is seen that there is the capability to produce a torque up to 400 Nm, what means a torque of 5 kNm if the gear ratio is switched to 1:12. This is a total torque of 10 kNm for the complete nose wheel drive existing of two motors. This is enough for a short break away operation and should be demonstrated.

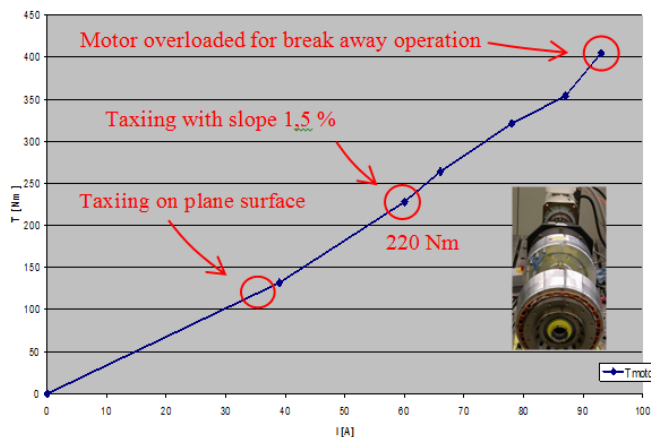

Fig.20. Torque of a single electric machine

7. Conclusion

Starting from the question of whether a passenger aircraft can move independently on the ground, an electric wheel hub motor has been designed which can be mounted easy on the axle of the nose landing gear of an Airbus A320. The purpose of the development was to demonstrate the feasibility of such a drive.

The drive is characterized by its compactness, which was possible because the rotor of the electric machine, which normally forms with its material the magnetic yoke of the permanent magnet excitation, also forms the planet carrier of a two-stage planetary gear. The electric machine has a relatively high number of pole pairs and is designed as a ring machine which provides the space within the rotor for the gear and the clutches.

The two motors of the nose landing gear may brake away the aircraft and may move the aircraft on a taxiing way with a slope up to 1.5 %. Finally a picture of the nose leg gear including the wheel hub motor is shown in fig. 21.



Fig.21. Nose leg gear with the electric wheel hub motor for autonomous taxiing of a passenger aircraft Airbus A320

Acknowledgement

This work was financially supported by the Ministry of Economic Affairs of the Federal Republic of Germany.

A special thanks goes to the companies Airbus, Goldhofer and LufthansaTechnik.



Fig.22. Taxiing test with electric wheel hub motor

References

- [1] T. Bödefeld and H. Sequenz, "Elektrische Maschinen," Springer Verlag, Wien, Germany, 1971.
- [2] A. Lelkes and T. Bertolini, "Energy saving motor to substitute induction motor," AMD&C Nr.5/2000, pp. 24-27.
- [3] H. Schneeweiß, "Using Brushless DC-Motors for Automotive Applications, Performance up to 1000W," International Conference on Fans, pp. 159-167, 9.-11. Nov. 2004, London.
- [4] M. Schier and A. Lelkes, "Low-Noise EC Motor with External Rotor for Automotive Application," 10th International Power Electronics and Motion Control Conference (EPE-PEMC), 9.-11. Sep. 2002, Cavtat& Dubrovnik
- [5] M. Schier and M. Schwaben and S. Münz, "Highly Dynamic Drive for Automotive Application," International Conference on Electrical Drives and Power Electronics (EDPE 2005), 26.-28. Sep. 2005, Dubrovnik & Cavtat
- [6] T. Lu and A. Binder and R. Pfeiffer, "Rotor Losses in Permanent Magnet High-Speed Machines," Proceedings of the International Conference on Electrical Machines (ICEM), p. 608-612, Aug. 2000, Helsinki