

# Interdependence of Electrical Machine and Transmission Control and the Optimal Hybrid Electric Drive Train Configuration

Christiane Bertram<sup>\*‡</sup>, Dominik Buecherl<sup>\*</sup>, Igor Bolvashenkov<sup>\*</sup>, Hans-Georg Herzog<sup>\*</sup>

<sup>\*</sup> Institute of Energy Conversion Technology, Technische Universitaet Muenchen, 80333 Munich, Germany

<sup>‡</sup> Christiane Bertram; Arcisstrasse 21 80333 Munich, Germany, Tel: +49 89289 28368, Fax: +49 89 28928335, e-mail: christiane.bertram@tum.de, dominik.buecherl@tum.de, igor.bolvashenkov@mytum.de, hg.herzog@tum.de

*Received:15.04.2011 Accepted:17.05.2011*

**Abstract-** The optimization of vehicles, results often in the optimization of software components since the cost-benefit calculation is especially good in this case. The best analyzed software component is the control strategy while components like the control of the electrical machine and the shifting strategy were not scrutinized as well. Therefore the potential of a modified machine control and shifting strategy are discussed in detail. Further the results of different measurement combinations are presented. Additionally the influence of those measurements on the optimal drive train configuration, meaning e.g. the optimal size of the electrical machine and the energy storage, is presented.

**Keywords-** Optimization, hybrid electric vehicle (HEV), drive train, transmission control, machine control.

## 1. Introduction

Resulting from the shortage of raw materials and for political reasons the search for the optimal hybrid electric vehicle (HEV) was intensified over the last years. The cheapest possibility of optimization is changing software components like the control strategy. Therefore the control strategy was studied closely and optimized in many cases [1-3]. Another software component which has been optimized in the case of conventional cars but wasn't studied as intensive in the case of parallel HEVs is the shifting strategy. Taking into account that electrical machines show another optimal operating area than combustion engines it would be wise to adapt the shifting strategy to the actual driving mode. Furthermore the control of the machine is often done by a constant voltage to frequency ratio which is not the best way since the efficiency of the machine may be improved by other activations. Other control schemes for induction machines were described in [4]. On the other hand the whole efficiency of the system taking even the inverter into account has to be optimized. Therefore this paper analyzes the

impact of a changed machine control while looking at an optimal efficiency of the electrical machine only and while looking at an optimal efficiency of both the machine and the inverter in combination. Furthermore the impact of a changed shifting strategy and the impact of those measurements on the optimal drive train will be analyzed.

The simulation model used within this paper is a backward-model of a parallel HEV. The used topology is illustrated in Fig. 1. The electrical machine is an induction machine with squirrel cage rotor having a nominal power of  $P_{EM} = 17.3$  kW and the combustion engine has 6 cylinders and a nominal power of  $P_{ICE} = 225$  kW. The automatic transmission consists of 8 gears and the shifting strategy is the same as in a conventional car. Further, the energy storage is a double layer capacitor consisting of 93 cells resulting in a usable energy content of 461 kJ.

The aim of the paper is to analyze the impact of modifications on the control of the electrical machine, the frequency inverter and the automatic transmission's shifting strategy in detail. Further

the focus of this paper lies on a holistic view on the system of a parallel HEV and not on the detailed description of single components. Additionally the impact of those measurements combined in different constellations will be analyzed. Within this

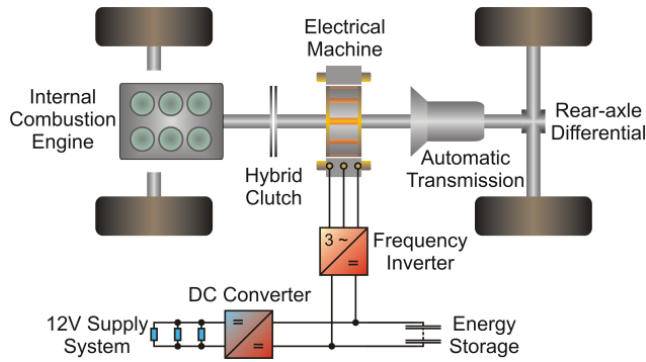

Fig. 1. Topology of the simulation model.

paper it is estimated whether a change of the machine control and the shifting strategy are worth the effort. In the following section the adapted control and the results will be explained.

## 2. Adapted Control of the Electrical Machine

Within this section the impact of an adapted control of the electrical machine on the fuel consumption and the optimal hybridization factor and energy storage size will be analyzed.

### 2.1. Adaption of the Control of the Electrical Machine

In many cases the control of the electrical machine is done by a constant ratio of voltage to frequency. As mentioned before it was proven that the efficiency of the inverter and the electrical machine may be improved due to other control strategies. In order to analyze the potential of a changed control the voltage is varied at each step of the driving cycle simulation from 105 V to 5 V in steps of 1 V and the efficiency of electrical machine and inverter is calculated. Afterwards the voltage resulting in the optimal efficiency of the electrical machine in the first case and the optimal efficiency of electrical machine and converter in the second case is chosen. The impact of this modification

on the vehicles fuel consumption is presented within the following section.

### 2.2. Impact on the Fuel Consumption

While adapting the control of the electrical machine at each step of the simulation to the maximal degree of efficiency of the electrical machine the fuel consumption may be reduced by 10 percentage points as it is illustrated in Fig. 2, from 68 % to 58 % compared to the conventional equivalent car, in the case of the Federal Test Procedure 75 (FTP-75).

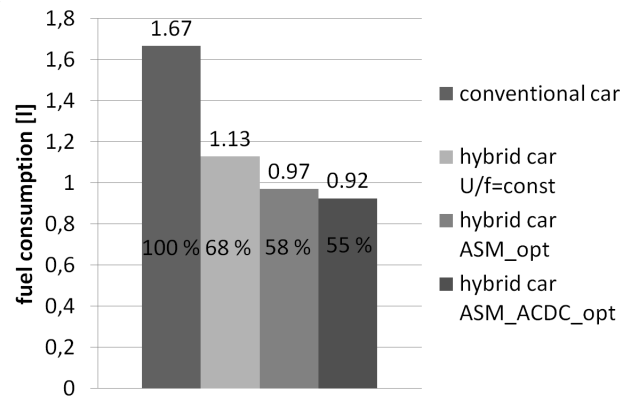
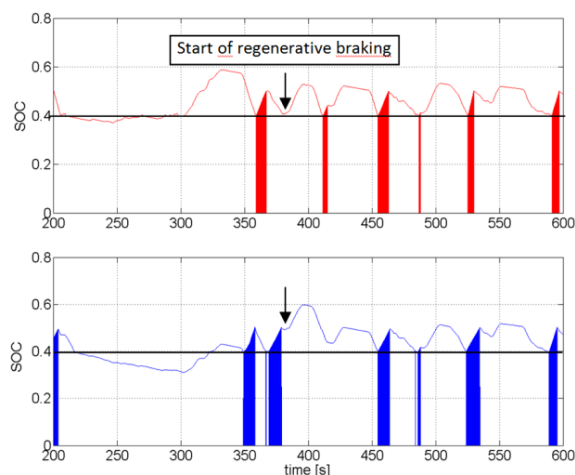

Fig. 2. Impact of the adapted machine control on the fuel consumption in case of FTP-75.

Since the inverter is the second component leading from the stored electrical energy to the needed mechanical energy it seems natural that the holistic efficiency of inverter and machine should be optimized. While doing so the fuel consumption can be reduced by another 3 percentage points. Those results show how important it is to optimize the holistic system of electrical machine and inverter. This enormous improve of the fuel consumption results is not so much reasoned by the higher efficiency of electrical machine and inverter as by the impact of the changed efficiency on the whole system. E.g. the higher efficiency influences the sequence of the different driving modes as a consequence the mode load point increase is much less and at more suitable moments activated while using the optimized control of the electrical machine. Fig. 3 illustrates an example of the shifted driving mode load point increase. In the case of a standard controlled electrical machine (displayed in the lower

diagram) the state of charge (SOC) sinks under the limit of the control strategy at 370 s and the load point increase starts while in the case of an optimized machine control the critical point is not reached. These results show how important it is to look at both the components and the whole system.

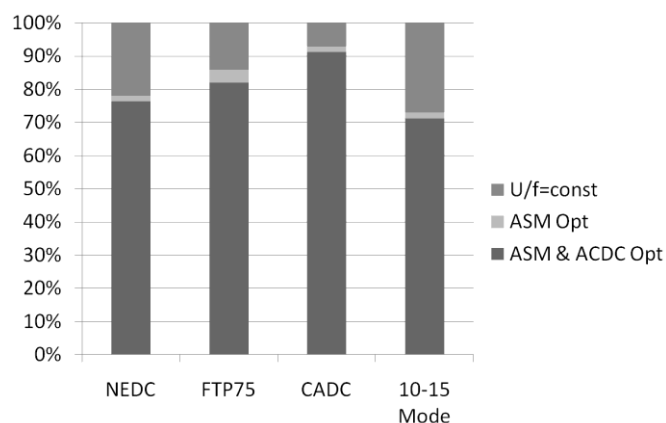

**Fig. 3.** Impact of the adapted machine control on the control strategy and the driving mode *load point increase*. Top: optimized machine control. Bottom: constant voltage to frequency ratio.

This improve of the fuel consumption only by varying the machine control becomes also visible in case of other driving cycles like the New European Driving Cycle (NEDC), 10-15 Mode and the Common ARTEMIS Driving Cycle (CADC). Fig. 4 illustrates how the improvement of fuel consumption depends on the driving cycle. It is clearly visible that in case of the CADC the improvement which may be made lies far beyond the improvement while simulating one of the other driving cycles. Further it is clearly noticeable that the improvement of the fuel consumption is best in case of the 10-15 Mode and the NEDC which may be due to the smoothness and unrealistic self repeating structure of those driving cycles. Since a high improvement of one of the operating points occurring in those driving cycles leads due to the repetition to an high improvement of the total fuel consumption. But also in case of the CADC the improvement of the fuel consumption amounts to 9 % compared to the case of the standard machine control. Therefore it seems to be wise to adapt the machine control in any case.

### 2.3. Impact on the Optimal Drive Train

In order to find the optimal hybrid drive train it has to be analyzed in detail which impact those variations in the control of the components have on the optimal components' size. In order to analyze this impact, the strong interdependency of the optimal components' size has to be considered.



**Fig. 4.** Impact of an adapted machine control on the improvement of fuel consumption during varying driving cycles.

Therefore the two-level optimization method which has been presented in [2] using DIviding RECTangles (DIRECT) as optimization algorithm was carried out on the system using the modified control of the electrical machine. The two-level optimization method illustrated in Fig. 5 enables the user to analyze the interdependency between the parameter on level 1 and level 2. Therefore an especially interesting question in this context is the impact of the modified electrical machine control on the optimal size of the electrical machine and thereby on hybridization factor which has been defined in [6] and is given in equation 1 and the corresponding optimal energy storage size. Both the two-level optimization method and the optimization algorithm DIRECT are explained in detail in [5].

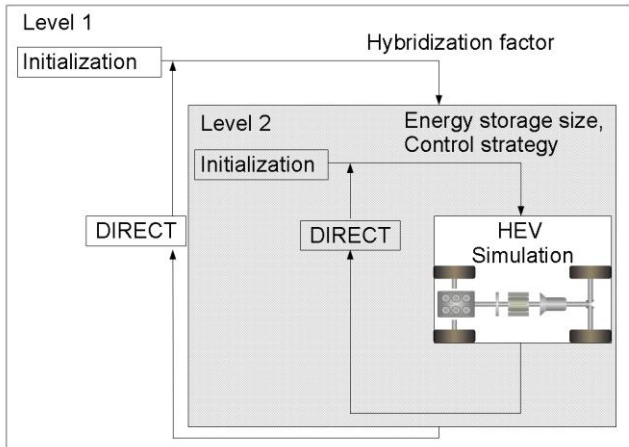

Fig. 5. Two-Level optimization method using DIRECT as optimization algorithm [5].

$$HF = \frac{PEM}{PICE} \quad (1)$$

Due to the drive train optimization the fuel consumption may be reduced by another 2 percentage points to 53 % in case of an optimal machine control. While optimizing the drive train without adapting the machine control the fuel consumption was reduced by 10 percentage points from 68 % to 58 %. The higher reduction potential in case of a standard machine control is due to the fact that while adapting the machine control each machine works more efficient and therefore the selection of the machines size is no longer that decisive. This may be seen in Fig. 6 since the curve of the optimized machine control is much flatter than the one of the standard machine control.

As it is illustrated in Fig. 6 the optimal hybridization factor is more or less the same in case of an optimized machine control and the standard machine control. Also the optimal energy storage size is the same and amounts to a useable energy content of about 496 kJ. Resulting from this the change of the machine control has no or only a small influence on the optimal drive train configuration. The unchanged hybridization factor results from the unchanged demands on the electrical machine since the efficiency of the machine is improved in the working points which leads to the flat line but

since this hybridization factor still meets the holistic demands the best.

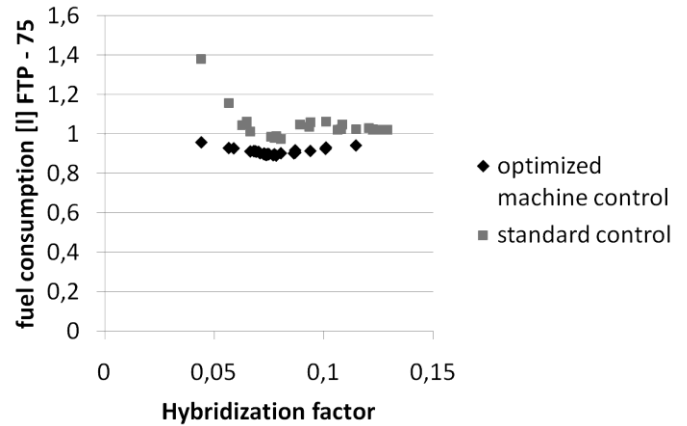

Fig. 6. Impact of an optimal machine control on the optimal drive train configuration during the simulation of FTP-75.

### 3. Adapted Shifting Strategy

Within this section the impact of an adapted shifting control on the fuel consumption and the optimal hybridization factor and energy storage size will be analyzed.

#### 3.1. Impact on the Fuel Consumption

As mentioned before the optimal operating area of electrical machine and combustion engine lie at different torque – speed – pares. Within this paper the electrical machine is placed between the automatic transmission and the combustion engine as it may be seen in Fig. 1. Using this constellation and an asynchronous machine it is especially important to adapt the shifting strategy to the actual driving mode. Within this paper the gear showing the maximal degree of efficiency of either the electrical machine is chosen at each simulation step of a pure electric driving mode, namely electric driving and regenerative braking. While simulating FTP-75 the fuel consumption may be reduced by 11 percentage points, from 68 % to 57 % compared to the conventional equivalent car, only by changing the shifting strategy in pure electric driving modes.

The dependency of the fuel consumption reduction due to a changed shifting strategy on

the chosen driving cycle is even higher than in case of a changed machine control. As it is illustrated in Fig. 7 the fuel consumption would be reduced to 68 % compared to the standard shifting in case of NEDC and to 52 % in case of the 10-15 Mode, while it would only be reduced to 98 % in case of CADC. The extreme improvement in case of NEDC results from the improvement of the electrical machine's efficiency at the phases of constant velocity at the urban parts of the NEDC where it is 63 %, 69 % and 75 % in case of a changed shifting strategy and only 45 %, 64 % and 66 % in case of the standard shifting strategy.

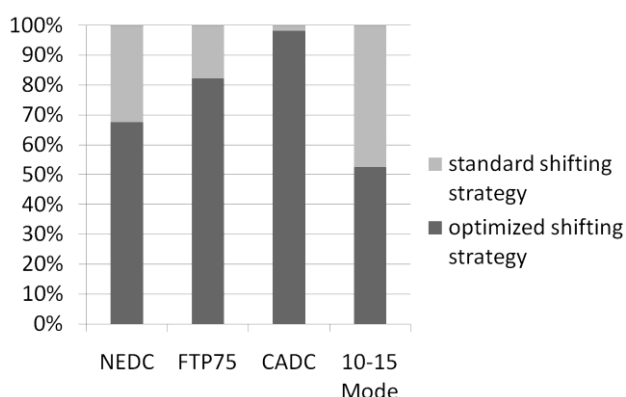

**Fig. 7.** Impact of an adapted shifting strategy on the improvement of fuel consumption during varying driving cycles

### 3.2. Impact on the Optimal Drive Train

As it had been necessary to analyze the impact of the changed machine control on the optimal drive train it is necessary to scrutinize the impact of a changed shifting strategy. Once again this analyzes is done using the methodology which has been presented in [5]. The changed shifting strategy lead to another optimal energy storage size but the hybridization factor once again did not change significantly. The impact of the changed shifting strategy on the optimal drive train is illustrated in Fig. 8. Due to the drive train optimization the fuel consumption can be reduced by another 10 percentage points to 47 % compared to the conventional vehicle. This huge potential of improvement results from the fact that the demand on the electrical machine and thereby on the energy storage changes while adapting the shifting strategy.

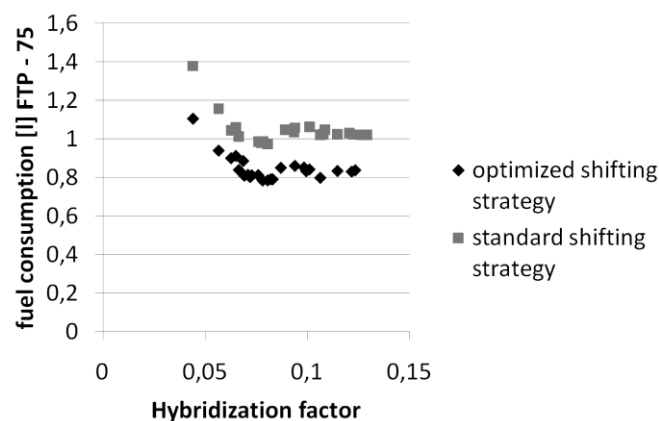

**Fig. 8.** Impact of an adapted shifting strategy on the optimal drive train configuration during the simulation of FTP-75.

The optimal energy content of the energy storage amounts to 595 kJ in case of an adapted shifting strategy. This is due to the improved efficiency during regenerative braking.

## 4. Combination of Optimal Machine Control and Shifting Strategy

Within this section the combined impact of machine control and shifting strategy will be analyzed. The total improvement of fuel consumption amounts to 53 percentage points in case of the FTP-75 compared to the conventional car.

As impact the modification of the machine control and the shifting strategy did depend on the driving cycle so does the combination of those measurements. Fig. 9 illustrates the impact of the driving cycle. It may be seen that the largest improvement may be achieved in case of the 10-15 Mode where the fuel consumption could be reduced to 45 % referred to the fuel consumption of the HEV without any modified control or strategy. This enormous improvement results as mentioned before to some extend from the synthetic structure of the driving cycle. But also in case of the quite realistic CADC the fuel consumption could be improved by 14 % referred to the fuel consumption of the HEV without any modified control or strategy. Therefore it can be said that it is worth the effort of optimizing the shifting strategy and control of the electrical machine.

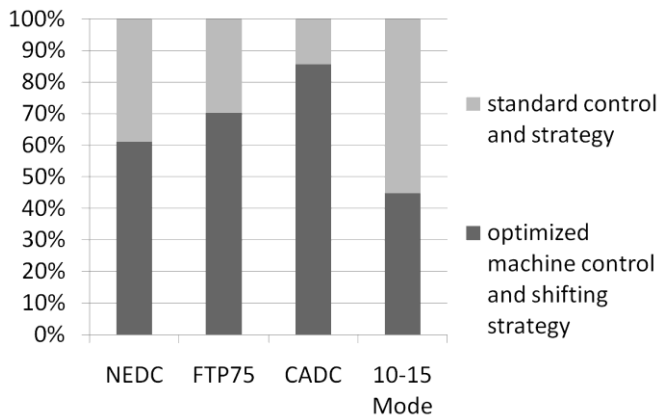

**Fig. 9.** Impact of an adapted shifting strategy and machine control on the improvement of fuel consumption during varying driving cycles.

## 5. Conclusion

The results presented in this paper showed the potential of software modification concerning not the control strategy but the control of the electrical machine and the shifting strategy is quite high. The fuel consumption was reduced by a changed shifting strategy in both cases, while modifying only the shifting strategy and modifying the entire system, significantly.

The improvement of fuel consumption depends highly at the driving cycle as it had been shown in case of the modified machine control and the modified shifting strategy. Further it was shown that the impact of the modifications is higher in case of synthetic driving cycles but also clearly noticeable in case of realistic driving cycles.

Beyond that it was shown that the optimal machine size does not significantly depend on the machine control and the shifting strategy. But nevertheless the drive train optimization led to a further improvement of the fuel consumption.

In future work a method for implementing the measurements presented in this paper, in real-time applications has to be found. Additionally the impact of those measurements on other vehicle topologies like serial HEVs or electrical vehicles has to be analyzed. Beyond that it should be analyzed which impact those measurements have if another less powerful combustion engine is chosen.

## References

- [1] X. Wu, B. Cao, J. Wen, and Y. Bian "Particle swarm optimization for plug-in hybrid electric vehicle control strategy parameter", in Proceedings 4<sup>th</sup> IEEE Vehicle Power and Propulsion Conference, Harbin, China, Sept. 2008
- [2] Y.-B. Yu, W. Qing-Nian, C. Yong-Jiu, H. Chang-Jian, and W. Bo-Shi "Control strategy optimization research using Dynamic Programming method for Synergic Electric System on HEV", in Proceedings Intelligent Vehicles Symposium, pp. 770-774, July 2009.
- [3] Y. Zhang, F. Sun, and H. He, "Control Strategy Optimization for Hybrid Electric Vehicle based on DIRECT Algorithm", in Proceedings 4<sup>th</sup> IEEE Vehicle Power and Propulsion Conference, Harbin, China, Sept. 2008.
- [4] D. Casadei, M. Mengoni, G. Serra, C. Rossi, A. Tani, and L.Zarri, "Robust Control Schemes for Induction Motor Drives for Electric Vehicle Applications," in Proceedings of EVER 2010, Monaco, Mar. 2010.
- [5] C. Bertram, D. Buecherl, T. Kohler, and H.-G. Herzog, "DIRECT as Two-Level Optimization Method for Drive Train Design and Control of Hybrid Electric Vehicles" in Proceedings of the EVS, 25<sup>th</sup> International Battery, Hybrid and Fuel Cell Electric Vehicle Symposium & Exhibition, Nov. 2010.
- [6] I. Bolvashenkov and H.-G. Herzog "System Approach to a Choice of Optimum Factor of Hybridization of the Electric Vehicle," in Proceedings of the EVS, 22<sup>nd</sup> International Battery, Hybrid and Fuel Cell Electric Vehicle Symposium & Exposition, 2006.