



Investigation of Stretch Properties of Different Stitch Types in Garments Made of Elastane Woven Fabrics

Kıvanç GELERİ¹  0000-0003-4425-7396

Ayça GÜRARDA²  0000-0002-7317-8163

Erhan Kenan ÇEVEN²  0000-0003-3283-4117

¹Bursa Uludağ University, Graduate School of Natural and Applied Sciences, Department of Textile Engineering, Bursa, Turkey

²Bursa Uludağ University, Engineering Faculty, Department of Textile Engineering, Bursa, Turkey

Corresponding Author: Ayça Gürarda, aycagur@uludag.edu.tr

ABSTRACT

In recent years, garments made of fabrics with elastane are highly preferred. A garment made of fabric with elastane is able to stretch by about 10-30% and recovery immediately after release. In the apparel industry, sewing should not prevent the fabric from stretching in the garments made from woven fabrics with elastane. The elasticity of the seams of the garments consisting of elastic fabrics is very important. In this study, it is aimed to examine the stretch and permanent elongation properties of different stitch types of garments made of elastane woven fabrics. For this purpose, 5 different stitch types were selected as lockstitch, zig zag stitch, two thread chain stitch, three thread overlock stitch and five thread overlock stitch, and these stitches were sewn at different stitch densities (3 - 4 and 5 stitches / cm), with different sewing threads (spun polyester, core spun (poly / poly), nylon and elastic sewing thread) with different ticket numbers (80 and 120). The stretch and permanent elongation values of the sewn fabric samples were examined.

ARTICLE HISTORY

Received: 04.04.2021

Accepted: 21.08.2021

KEYWORDS

Elastane, stretch, stitch type, sewing thread, stitch density

1. INTRODUCTION

In recent years, the most of the garments are sewn with elastane fabrics. A garment made of elastane fabric can stretch approximately 10-30% and recover immediately after release. Elastane fibers can be used with all other natural and synthetic fibers today. It is sufficient to use a very small amount (2-5%) of this fiber in order to provide the desired comfort in clothes [1]. In the apparel industry, sewing should not prevent the fabric from stretching in the garments made of elastane woven fabrics. The seam appearance and performance affect the aesthetics and performance of the garment and determine its life time. For this reason, the elasticity of the seams of the garments consisting of elastic fabrics is very important.

In men's trousers sewn from elastane woven fabric, while the fabric shows a certain stretch during sitting and standing, the stitches of the trousers should also show enough flexibility. Otherwise, problems such as seam opening or stitch breakage may be encountered. In the women's blouse sewn from elastane woven fabric, while the fabric shows enough elasticity during the movement, the stitches of the blouse should also show enough elasticity. In the studies conducted in this field, the effect of silicon finish applied to cotton/elastane woven fabrics and the fixation temperature on the stretch properties of the fabric and seam performance of polyester/nylon-elastane woven fabrics were investigated [2, 3]. However, stretch and permanent elongation values of the stitched samples were not calculated.

To cite this article: Geleri K, Gürarda A, Çeven EK. 2021. Investigation of stretch properties of different stitch types in garments made of elastane woven fabrics. *Tekstil ve Konfeksiyon* 31(4), 284-294.

Parameters such as stitch type, stitch density, sewing thread type and ticket number and sewing needle number are very important in sewing elastane fabrics. Studies in this field show that not selecting one or more of these sewing parameters appropriately causes sewing problems such as seam grinning, seam opening, seam puckering or seam breakage [1, 4, 5]. It is also very important to determine the most suitable sewing parameters to be applied to these garments, since the majority of both men's and women's garments are sewn from elastane fabrics in the apparel industry.

Sewing threads, seam and stitch types are among the most important parameters affecting the appearance and quality of the garments. Stitches join the pieces of clothing to form the garment suitable for the body. Quality seams increase the performance of the garment. Poor quality stitches spoil the appearance of the garment, even if the fabric of the garment is of good quality. The most important properties of seams in a garment are its strength, elasticity, durability and appearance. These properties must be balanced with the properties of the garment's fabric to create the optimum stitch. Factors such as the weight of the fabric, stitch type, needle type, and stitch density affect the seam performance and quality properly. Quality sewing threads should be selected for the longevity of the seams of the garments. Stitch strength is the most important factor that determines the durability of the seams of the garment. As can be seen in the studies conducted in this field, the structure, ticket number and finishing processes of the sewing threads used in seams affect the seam strength of the garment [1, 6]. Choosing the best stitch type, sewing thread ticket number and sewing thread type suitable for the garment depends on variables such as fabric structure, weight and type of fabric. The wrong selection of one of these causes the formation of faulty stitch lines and leads to undesirable defects on the finished product. Therefore, optimization of seam properties is very important.

As can be seen from the studies conducted in this field, the biggest problem seen in elastane fabrics is the problem of elastane breakage caused by mechanical damage and rupture of the elastane thread during sewing [1]. In order to prevent this problem during sewing the fabric, sewing needle tip shape should be selected with round ball point. In addition, the sewing needle and sewing thread ticket number should also be selected according to the weight of the elastane fabric [7].

In the selection of a sewing thread, the elongation properties of the sewing thread play a major role in obtaining a good stitch flexibility. Sewing threads with high breaking elongation are also preferred in the stitches of clothes made of elastane fabrics. Cotton sewing threads are not flexible enough and show 6-8% elongation. Polyester and nylon sewing threads are generally preferred for flexible stitches used at the fabrics. Medium thickness synthetic sewing threads show 15-20% elongation. In recent years, flexible sewing threads with very high elasticity rates at 40-50% elongation have also been

produced and started to be used in sewing elastane fabrics [8, 12].

The corespun sewing threads are produced by taking into account all the properties required for sewing. Corespun yarns are produced by coating staple fiber polyester on endless fiber polyester (poly / poly) or by coating cotton on continuous fiber polyester (poly / cotton). Corespun threads gain high strength from the continuous fiber polyester in the middle and a natural structure and seam attitude from the staple fiber on the outside. Therefore, they have high strength and appropriate fineness. In addition, the aerodynamic feature of the hairy structure on the outer surface ensures needle cooling and less abrasion of machine parts. It is used for the sewing of blouses and t-shirts, jackets, swimsuits, uniforms and work clothes. Nylon 6.6 sewing thread is 30% stronger than nylon 6 sewing thread. Due to its high strength even in fine counts, it allows the making of fine and strong stitches. Compared to polyester sewing thread, it also has high strength and slightly greater elongation. Its stretching feature is balanced [12,13]. In recent years, flexible sewing threads with high elongation have also been produced for sewing elastic garments containing elastane. Stretch sewing thread is an ideal thread for sportswear and body-fitting garments. These sewing threads have high elongation and seam strength and provides straight seams that can stretch by preventing damages caused by seam stretch in flexible fabrics. It has a variety of fineness and color suitable for all elastic fabric types [12].

Besides sewing thread elongation, other important factors that support stitch elasticity are the correct choice of stitch type and stitch density. Although lockstitch (301), which is the most frequently used, is a stitch type with the least elasticity, sewing elasticity values can be increased with the appropriate stitch density. However, this elasticity is not enough. The elasticity of two thread chain stitch is better compared to lockstitch. The best results can be achieved with 500 group overlock stitch types with high sewing elasticity [1].

Elastic fabrics stretch a certain amount when a load is applied. When this load is removed, the fabric returns to its original state and rotates due to the recovery feature of elastane. However, it cannot be completely restored and permanent elongation occurs. In order to calculate the permanent elongation value, the fabric shrinkage value is calculated after the fabric sample is stretched at the specified elongation and held for a certain period of time. Permanent elongation is tolerable at a maximum of 2% for trousers and dresses. Garments made of elastane woven fabrics with high permanent elongation values have a high tendency against bagging in the elbow and knee areas. As can be seen from the studies conducted, bagging on the garment impairs the quality of the garment [9]. As stated in the standard of TS 6071 "Method of Determining the Strength of Woven Fabrics Against Bagging or Elongation Due to Clothing", it is revealed that as the permanent elongation value increases, the stretched fabric has difficulties in recovery. Permanent elongation of the fabrics

should not be more than 3% after the application of stretching force and 2 hours recovery time. ASTM D 3107-07 "Test Method for Stretch Properties of Woven Fabrics Made of Elastane Yarns" standard also provides a method for evaluating stretching properties of fabrics. [15, 16].

The structure of sewing threads has an important influence on mechanical, especially viscoelastic properties and elastic recovery of a sewing thread after cyclical stretching [17]. It is very important to choose the appropriate stitch and seam type for stitch elasticity. Both lockstitch and chain stitch, if adjusted carefully, will give adequate stretch for elastic fabrics. Chain stitch has higher stretch than lockstitch [18]. Due to flexibility, the sewing thread made from spun yarns has good sewing performance, good dimensional stability, and good stitch forming properties. The core spun yarns also have excellent loop forming characteristics for the high flexibility [19].

In this study, it is aimed to obtain more flexible stitches by optimizing the sewing properties of the garments made of elastane woven fabrics. Thus, the elasticity of the garments will increase even more, and the stitches will contribute to the comfort and fit of the garment and reduce sewing problems. With this study, stretch and permanent elongation values of garments made of elastane woven fabrics with different stitch types were examined and an important gap in the scientific literature was tried to be eliminated. At the same time, with this study, it is expected to provide an economical solution for the apparel industry by optimizing sewing parameters such as stitch type, stitch density, sewing thread type and sewing thread ticket number in the production of garments made of elastane fabrics, and the application of stitches to the garment.

2. MATERIAL AND METHOD

2.1 Material

In this study, woven fabric with elastane for women's dresses was selected and different stitch types were applied to this fabric sample. The structural properties of the fabric used in the experimental study are listed in Table 1.

This fabric sample was sewn with 4 different sewing threads. Each of the sewing thread has two different ticket numbers. The structural properties of the sewing threads used in the study are included in Table 2.

2.2 Method

In this study, the stretch and permanent elongation properties of the stitches applied to the elastane woven fabric were evaluated with the Flexi-Frame (James Heal) "Fabric Stretch and Permanent Elongation Test Device" shown in Figure 1. Five different stitch types as lockstitch (301) (Figure 2), zig zag stitch (304) (Figure 3), two thread chain stitch (401) (Figure 4), three thread overlock stitch (504) (Figure 5) and five thread overlock stitch (516) (Figure 6) were selected, and these stitches were sewn with different densities (3 - 4 and 5 stitches / cm) and different ticket numbers (80 and 120) and different sewing threads (spun polyester, core spun (poly / poly), nylon and elastic sewing thread). These stitches were sewn perpendicular to the weft direction of the fabric. 120 different fabric samples were obtained and their elongation and permanent elongation values were investigated.

Table 1. Structural properties of the fabric used in the experimental study

Fabric Type	Density (thread/cm)		Weight (g/m ²)	Width (cm)	Construction
	Weft	Warp			
Stretch Twill	36	40	260	137	% 93 PES - % 7 EA

Table 2. Structural properties of sewing threads used in experimental study

Sewing Thread	Thread Count (Tex)	Ticket Number	Type	Elongation (%)		Tenacity (cN/tex)
				Min	Max	
1	40	80	Spun Polyester	13	20	35.35
	27	120		13	20	36.66
2	40	80	Corespun (Poly/Poly)	18	24	49.00
	24	120		17	22	49.58
3	35	80	Nylon	15	26	61.71
	24	120		12	25	65.83
4	40	80	Elastic (Eloflex)	55	85	23.00
	27	120		50	70	33.33

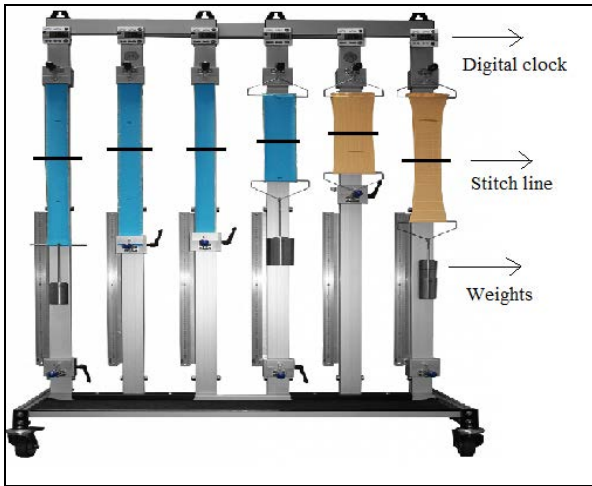

Figure 1. Stretch and recovery instrument (James Heal) [21]

order to test the elastic properties of elastane woven fabrics, TS 6071 "Method of Determination of Strength of Woven Fabrics Against Bagging or Elongation Due to Clothing" standard was used [15]. Stitch types applied to fabric samples were selected from ASTM D 6193 "Standard Practices for Seams and Sewing" standard [14]. For the test, samples those in the direction of the elastane thread were prepared in accordance with the standard TS 6071 (5 cm x 38 cm in size, long edge in the direction of the elastane thread) and cut right into the middle. The stitch types specified in the experiment plan were sewn with superimposed seam type (Figures 2-6) from the place where it was cut. Each fabric sample was conditioned according to ASTM D 1776 for experiments [20].

The 2250 g weight, determined in accordance with the standards, was hung on the samples as seen in the "Fabric Stretch and Permanent Elongation Test Device" shown in Figure 1, and was stretched for the specified periods with the help of the digital clock on the device. Elongation (%) and permanent elongation (%) of the samples were calculated by using Equations (1-2) [15].

Stitch types applied to test samples;

Lockstitch and zig zag stitches were sewn with Singer Scarlet model lockstitch sewing machine, chain stitch was sewn with Siruba model chain sewing machine and overlock stitches were sewn with Juki model overlock sewing machine. In

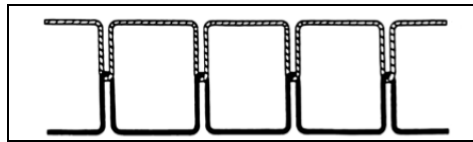

Figure 2. Stitch type 301 (Lockstitch) [14]

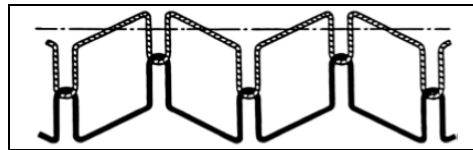

Figure 3. Stitch type 304 (Zig zag stitch) [14]

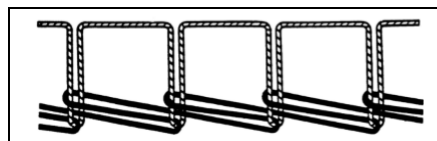

Figure 4. Stitch type 401 (Two thread chain stitch) [14]

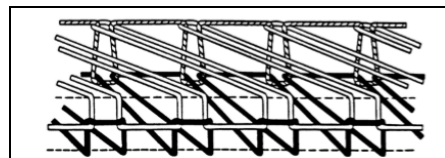

Figure 5. Stitch type 504 (Three thread overlock stitch) [14]

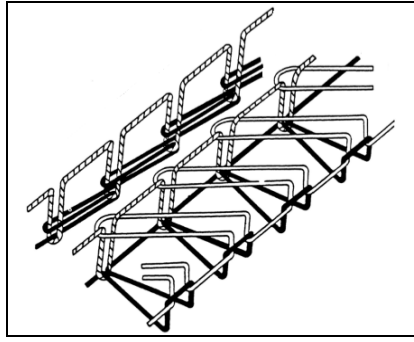

Figure 6. Stitch type 516 (Five thread overlock stitch) [14]

$$\text{Fabric Elongation (\%)} = [(B - A) / A] \times 100 \quad (1)$$

$$\text{Fabric Permanent Elongation (\%)} = [(C - A) / A] \times 100 \quad (2)$$

A: Original length of the fabric sample,

B: Benchmark length of the fabric under load,

C: Benchmark length of the fabric after load release [15]

A length of 25 cm was marked by leaving a distance of 6.5 cm from the edges on the fabric sample prepared with a size of 5 cm x 38 cm (A). Benchmark length of the fabric under load amount was determined while the sample was loaded (B) at the end of 30 minutes load application period. Benchmark length of the fabric after load release amount were determined according to the previously marked 25 cm dimension (C), after 5 minutes, 1 hour and 2 hours. Fabric elongation percentages of fabric samples and fabric permanent elongation percentages were calculated with the formulas in Equation 1 and 2 [15]. SPSS 21.0 statistical program was used to evaluate the test results. ANOVA and Student-Newman-Keuls (SNK) tests were applied to the results.

3. RESULTS AND DISCUSSION

The elongation behavior of elastane fabrics is desired to be between 10% and 30%. If the elongation behavior is lower than 10%, it indicates that the flexibility of the fabric is not good. Stretching and permanent elongation values in elastane fabrics are very important in determining its flexibility. The closer the permanent elongation gets to 0, the better the fabric's elasticity and recovery. As the permanent elongation value increases, it is revealed that the stretched fabric has difficulties in coming back and recovery. Percentage of permanent elongation of the fabrics should not be more than 3% after the application of stretching force and 2 hours withdrawal period [15]. The stitches applied to the elastane fabric should not adversely affect the elasticity and permanent elongation values of the elastane fabric. Table 3 and 4 show the permanent elongation (%) values at different time periods (after 5 minute, 1 hour and 2 hours) for different sewing threads with different stitch densities.

3.1 Statistical Results of Elongation (%) and Permanent Elongation (%) Values of Fabric Samples

The statistical results of the elongation (%) and permanent elongation (%) values (after 2 hours) of the stitched fabric

samples were examined. Table 5 shows the statistical results of the elongation and % permanent elongation values of the samples sewn using different sewing threads. There are significant differences on elongation (%) and permanent elongation (%) values of sewing thread types. It is seen that Eloflex-80, Eloflex-120 and Poly / poly -120 sewing threads have the highest elongation.

Polyester and nylon sewing threads are generally preferred for flexible stitches used at the fabrics. Medium thickness synthetic sewing threads show 15-20% elongation. In recent years, elastic sewing threads with very high elasticity rates at 40-50% elongation have also been produced and started to be used in sewing elastane fabrics [8, 12].

Table 6 shows the statistical results of the elongation (%) and permanent elongation (%) values of the samples sewn using different sewing types. There are significant differences on the elongation (%) and permanent elongation (%) values of the stitch types. It is seen that three thread overlock, five thread overlock and two thread chain stitch have the highest elongation (%), while lockstitch and zig zag stitch types have low elongation (%). Lockstitch (301), which is the most frequently used, is a stitch type with the least elasticity, the sewing elasticity values can be increased with the appropriate stitch density. However, this elasticity is not enough. The elasticity of two thread chain stitch is better compared to lockstitch. The best results can be achieved with 500 group overlock stitch types with high sewing elasticity [1, 18].

Table 7 shows the statistical results of the elongation (%) and permanent elongation (%) values of the samples sewn using different stitch densities. There are significant differences in stitch density on elongation (%) and permanent elongation (%) values. It is seen that stitch types with 3 stitches / cm stitch density have the highest elongation (%), followed by 4 stitches / cm and 5 stitches / cm. As the stitch density increases, the stretch of the stitched sample decreases.

Table 3. Permanent elongation (%) at different time periods (after 5 minute, 1 hour and 2 hours) for different sewing threads with different stitch densities

Stitch Type	Time	Spun PES-80 Stitch/cm			Poly/Poly-80 Stitch/cm			Nylon-80 Stitch/cm			Eloflex-80 Stitch/cm		
		3	4	5	3	4	5	3	4	5	3	4	5
Lock stitch	5 min	2.52	2.00	2.12	1.84	2.12	1.84	2.00	1.60	1.20	2.80	2.92	1.44
	1hour	1.84	1.44	1.72	1.44	1.72	1.32	1.20	0.92	0.80	1.60	1.20	0.80
	2hour	1.44	1.04	0.80	0.92	0.80	0.64	0.64	0.52	0.40	0.80	0.64	0.40
Zig Zag	5 min	2.52	1.60	2.40	3.20	2.40	2.80	2.40	1.84	2.00	2.40	2.24	3.60
	1hour	1.72	1.20	1.72	2.24	1.32	2.00	2.00	1.20	1.44	1.60	1.20	2.40
	2hour	1.20	0.80	1.04	1.60	0.80	1.20	1.44	0.80	0.80	0.64	0.92	1.60
Two Thread	5 min	2.00	1.32	1.44	2.00	2.40	1.84	2.00	1.60	1.44	2.00	1.60	1.60
	1hour	1.60	0.92	0.80	1.60	1.60	1.04	1.60	1.04	1.04	1.60	0.92	0.80
	2hour	0.80	0.52	0.40	1.20	0.80	0.40	1.04	0.40	0.40	0.80	0.52	0.40
Three Thread	5 min	2.00	2.00	2.00	1.72	1.84	1.84	2.52	1.84	1.72	2.24	2.24	2.00
	1hour	1.20	1.04	1.20	1.20	1.20	1.20	2.00	1.32	0.92	1.84	1.84	1.60
	2hour	0.80	0.64	0.52	0.8	0.52	0.40	1.32	0.92	0.40	1.20	1.04	0.92
Overlock	Five	2.00	2.00	2.00	2.00	2.00	1.20	2.00	2.00	1.60	2.00	1.60	1.60
	1hour	1.60	1.44	1.20	1.60	1.60	0.80	1.60	1.20	1.04	1.60	1.04	0.80
	2hour	0.80	0.64	0.52	1.04	1.04	0.40	0.92	0.64	0.40	0.80	0.64	0.40

Table 4. Permanent elongation (%) at different time periods (after 5 minute, 1 hour and 2 hours) for different sewing threads with different stitch densities (3-4-5)

Stitch Type	Time	Spun PES-120 Stitch/cm			Poly/Poly-120 Stitch/cm			Nylon-120 Stitch/cm			Eloflex-120 Stitch/cm		
		3	4	5	3	4	5	3	4	5	3	4	5
Lock stitch	5 min	2.52	2.40	2.40	2.00	1.84	2.00	1.44	1.84	1.20	2.00	1.32	2.00
	1 hour	2.00	1.72	1.60	1.44	0.92	1.32	1.04	1.20	0.80	1.44	0.92	1.20
	2 hour	1.44	1.04	0.92	0.80	0.64	0.52	0.64	0.52	0.40	0.80	0.52	0.40
Zig zag	5 min	2.12	2.40	2.40	1.84	1.72	2.64	2.00	1.84	2.00	1.32	2.24	1.60
	1 hour	1.44	1.60	1.60	1.44	1.04	1.84	1.20	1.20	1.20	0.80	1.44	1.20
	2 hour	1.04	0.80	0.92	1.04	0.52	0.80	0.80	0.64	0.80	0.40	0.64	0.80
Two thread	5 min	2.00	2.00	1.60	2.40	2.00	2.00	2.00	2.00	2.00	2.00	1.44	1.32
	1 hour	1.60	1.20	1.20	1.60	1.60	1.20	1.60	1.20	1.44	1.60	0.92	0.92
	2 hour	0.80	0.64	0.52	1.04	1.20	0.40	1.04	0.80	0.52	0.80	0.52	0.40
3 thread overlock	5 min	1.84	2.40	1.72	3.44	3.32	3.72	3.20	2.92	2.64	2.00	2.80	2.00
	1 hour	1.44	1.20	0.92	2.40	2.24	2.80	2.00	1.20	2.00	1.60	2.00	1.60
	2 hour	1.04	0.80	0.40	2.00	1.84	1.72	1.60	1.32	1.20	1.20	1.04	0.80
5 thread overlock	5 min	2.00	1.84	2.00	2.00	2.00	1.60	2.00	2.52	2.00	2.00	2.00	2.00
	1 hour	1.60	1.04	1.20	1.60	1.60	0.92	1.60	1.72	1.20	1.60	1.20	1.20
	2 hour	0.92	0.64	0.40	1.04	0.80	0.52	0.92	0.80	0.40	1.04	0.80	0.52

Table 5. (ANOVA ve SNK) (Statistical results of elongation (%) and permanent elongation (%) values of samples sewn with different sewing threads (ANOVA and SNK)

Sewing Thread Type	Elongation (%)	Permanent Elongation (%)
Spun PES - 80	16.73 c	0.83 a
Spun PES - 120	16.40 b	0.82 a
Poly/Poly - 80	16.84 c	0.82 a
Poly/Poly - 120	18.20 e	0.97 b
Nylon - 80	16.30 a	0.76 a
Nylon - 120	16.53 b	0.80 a
Eloflex - 80	19.91 f	0.79 a
Eloflex - 120	17.60 d	0.72 a

*: statistically significant ($P < 0.05$)

(a),(b),(c),(d),(e) and (f) represent the statistical difference ranges according to SNK test.

Table 6. Statistical results of elongation (%) and permanent elongation (%) values of samples sewn with different stitch types (ANOVA and SNK)

Stitch Type		Elongation (%)	Permanent Elongation (%)
Lockstitch		15.78 a	0.77 b
Zig zag stitch		16.64 b	0.91 c
Two thread chain stitch	0.00*	18.34 d	0.67 a
Three thread overlock		18.44 d	1.02 d
Five thread overlock		17.34 c	0.71 b

*: statistically significant ($P < 0.05$)

(a),(b),(c) and (d) represent the statistical difference ranges according to SNK test.

Table 7. Statistical results of elongation (%) and permanent elongation (%) values of samples sewn with different stitch density (ANOVA and SNK)

Stitch Density (stitch/cm)		Elongation (%)	Permanent Elongation (%)
3		18.25 c	1.03 c
4	0.00*	17.14 b	0.78 b
5		16.55 a	0.64 a

*: statistically significant ($P < 0.05$)

(a),(b) and (c) represent the statistical difference ranges according to SNK test.

3.2 Elongation (%) and Permanent Elongation (%) Values of Fabric Samples Sewn with Lockstitch

Figure 7 shows the elongation (%) values of the fabric samples sewn with lockstitch and in Figure 8, the permanent elongation (%) values (after 2 hours) are shown on the graphic. The statistical (ANOVA and SNK) results of the values obtained from the experiments are also included in Tables 5, 6 and 7. Table 5 shows the statistical results of the effects of different sewing threads on elongation (%) and permanent elongation (%) values. As can be seen from the results in this table and Figure 7, the highest elongation in lockstitch was obtained in Eloflex-80 and Eloflex-120 sewing threads. In Figure 8, it is seen that the permanent elongation values of the samples sewn with lockstitch are high in Spun Pes-80, Spun-Pes-120, Poly / Poly-80 and Poly / Poly-120 sewing threads.

Table 6 contains the statistical results of the effects of different stitch types (lockstitch, zig zag stitch, two thread chain stitch, three thread overlock stitch and five thread overlock stitch) on elongation (%) and permanent elongation (%) values. As can be seen from the results in this table, lockstitch samples show the least elongation. Permanent elongation values are also low. Among the five types of stitches determined in the experimental study, the stitch with the least stretch property is seen as lockstitch.

Table 7 shows the statistical results of the effects of different stitch densities (3 - 4 and 5 stitches / cm) on elongation (%) and permanent elongation (%) values. As can be seen from the results in this table, it is seen that the lockstitch fabric samples sewn with a stitch frequency of 3 stitches / cm showed the highest elongation (%) and permanent elongation (%), and the fabric samples sewn with 5 stitches / cm showed the lowest elongation (%) and permanent elongation (%) results.

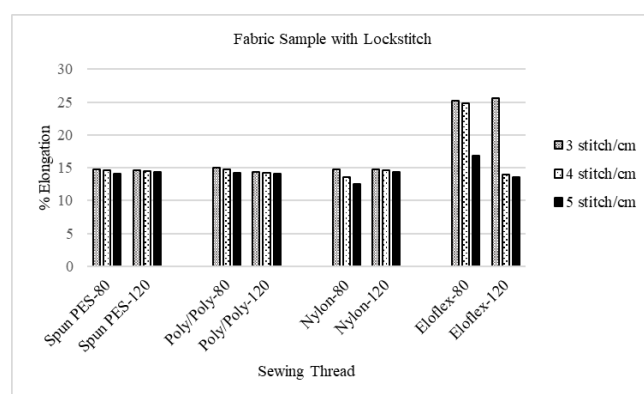

Figure 7. Elongation values (after 30 minutes) of the fabric sample with lockstitch

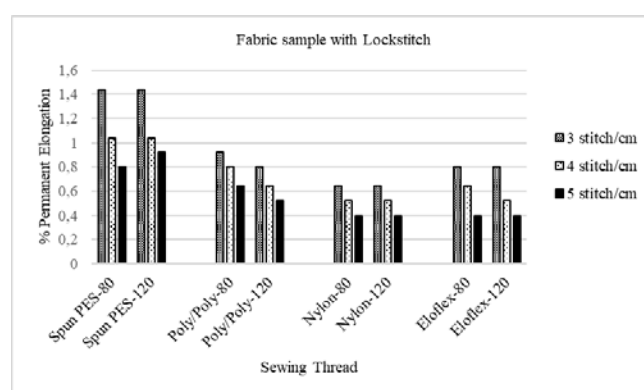

Figure 8. Permanent elongation values (after 2 hours) of the fabric with lockstitch

3.3 Elongation (%) and Permanent Elongation (%) Values of Fabric Samples Sewn with Zig Zag Stitch

Figure 9 shows the elongation (%) values of the fabric samples sewn with zig zag stitch and in Figure 10, the permanent elongation (%) values (after 2 hours) are shown on the graphic. The statistical (ANOVA and SNK) results of the values obtained from these experiments are also

included in Tables 5, 6 and 7. Table 5 shows the statistical results of the effects of different sewing threads on elongation (%) and permanent elongation (%) values. As can be seen from the results in this table and Figure 9, the highest elongation in zig-zag stitch was obtained in Eloflex-80 and Eloflex-120 sewing threads. In Figure 10, it is seen that the permanent elongation values of Spun Pes-80, Spun-Pes-120, Poly / Poly-80 and Poly / Poly-120 sewing threads of the samples sewn with zig zag stitch are high.

Table 6 contains the statistical results of the effects of different stitch types (lockstitch, zig zag stitch, two thread chain stitch, three thread overlock stitch and five thread overlock stitch) on elongation (%) and permanent elongation (%) values. As can be seen from the results in this table, the zig-zag stitched samples show the least elongation after straight stitching. Permanent elongation values are also low. Among the five stitch types determined in the experimental study, the second stitch with the lowest stretch is seen as the zig-zag stitch.

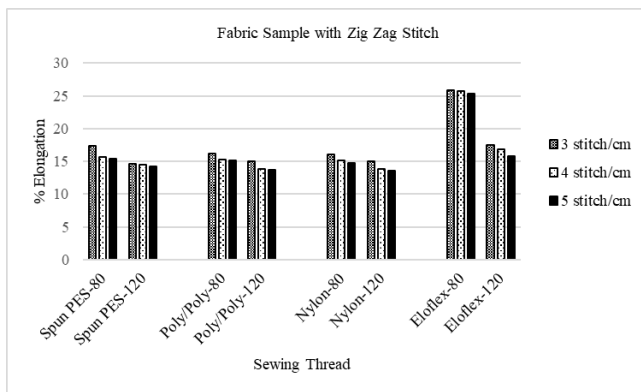

Figure 9. Elongation values (after 30 minutes) of the fabric sample with zig zag stitch

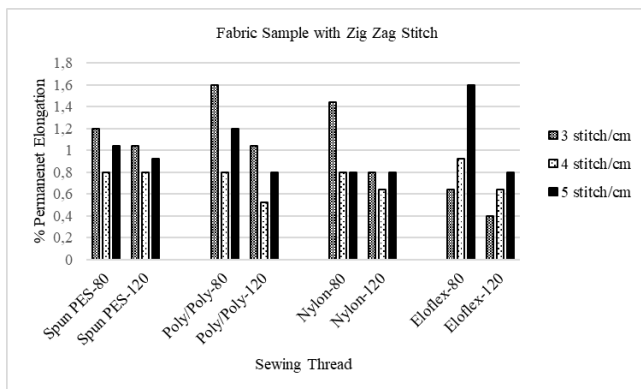

Figure 10. Permanent elongation values (after 2 hours) of the fabric with zig zag stitch

3.4 Elongation (%) and Permanent Elongation (%) Values of Fabric Samples Sewn with Two Thread Chain Stitch

Figure 11 shows the elongation (%) values of fabric samples sewn with two-thread chain stitch and the permanent elongation (%) values (after 2 hours) in Figure 12. The

statistical (ANOVA and SNK) results of the values obtained from these experiments are also included in Tables 5, 6 and 7. Table 5 shows the statistical results of the effects of different sewing threads on elongation (%) and permanent elongation (%) values. As can be seen from the results in this table and Figure 11, the highest elongation in two-thread chain stitch was obtained in Poly / Poly-80 and Poly / Poly-120 sewing threads. In Figure 12, it is seen that the permanent elongation values of Poly / Poly-80 and Nylon-120 sewing threads of the samples sewn with two-thread chain stitch are high.

Table 6 contains the statistical results of the effects of different stitch types (lockstitch, zig zag stitch, two thread chain stitch, three thread overlock stitch and five thread overlock stitch) on elongation (%) and permanent elongation (%) values. As can be seen from the results in this table, samples with two thread chain stitches show the greatest elongation. Permanent elongation values are also low. Among the five stitch types determined in the experimental study, one of the stitches with high stitch stretch is seen as a two-thread chain stitch.

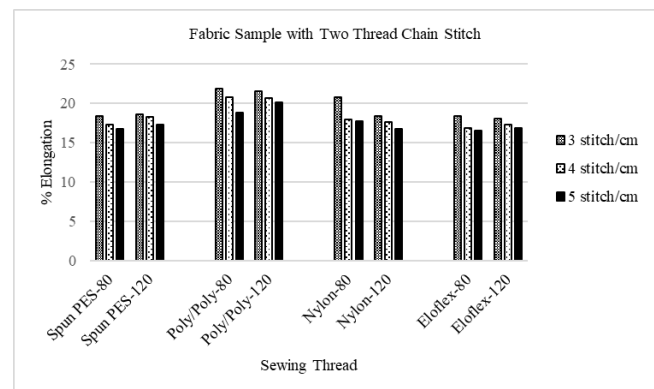

Figure 11. Elongation values (after 30 minutes) of the fabric sample with two thread chain stitch

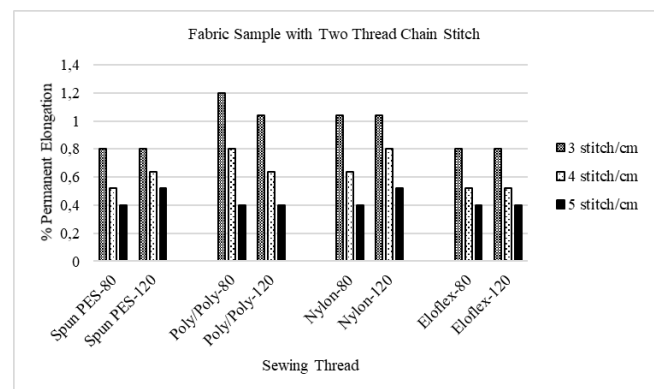

Figure 12. Permanent elongation values (after 2 hours) of the fabric sample with two thread chain stitch

Table 7 shows the statistical results of the effects of different stitch densities (3 - 4 and 5 stitches / cm) on elongation (%) and permanent elongation (%) values. As can be seen from the results in this table, the two thread

chain stitch fabric samples sewn with a stitch frequency of 3 stitches / cm showed the highest elongation (%) and permanent elongation (%), and the fabric samples sewn with 5 stitches / cm showed the lowest elongation (%) and permanent elongation (%) results is seen.

3.5 Elongation (%) and Permanent Elongation (%) Values of Fabric Samples Sewn with Three Thread Overlock Stitch

Figure 13 shows the elongation (%) values of fabric samples sewn with three-thread overlock stitch and the permanent elongation (%) values (after 2 hours) in Figure 14. The statistical (ANOVA and SNK) results of the values obtained from these experiments are also included in Tables 5, 6 and 7. Table 5 shows the statistical results of the effects of different sewing threads on elongation (%) and permanent elongation (%) values. As can be seen from the results in this table and Figure 13, the highest elongation in three-thread overlock stitch was obtained in Poly / Poly-120 and Nylon-120 sewing threads. In Figure 14, it is seen that the permanent elongation values of Poly / Poly-120 and Nylon-120 sewing threads of the samples sewn with three thread overlock stitch are high.

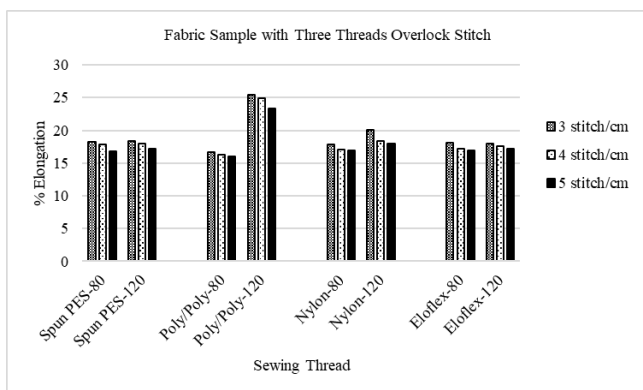

Figure 13. Elongation values (after 30 minutes) of the fabric sample with three thread overlock stitch

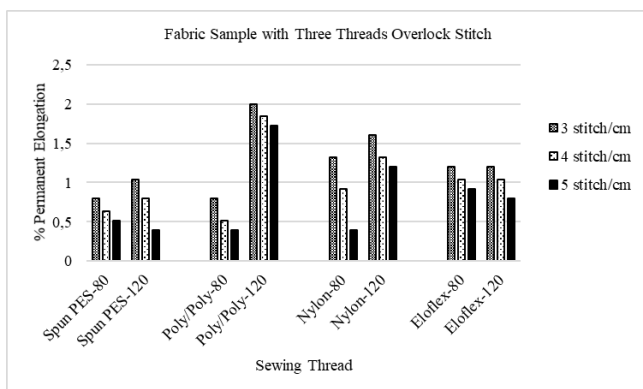

Figure 14. Permanent elongation values (after 2 hours) of the fabric sample with three thread overlock stitch

Table 6 contains the statistical results of the effects of different stitch types (lockstitch, zig zag stitch, two thread chain stitch, three thread overlock stitch and five thread overlock stitch) on elongation (%) and permanent

elongation (%) values. As can be seen from the results in this table, samples with three thread overlock stitches show the greatest elongation. Permanent elongation values are also high. Among the five types of stitches determined in the experimental study, the stitch stretch property is seen as the three thread overlock stitch as the highest.

Table 7 shows the statistical results of the effects of different stitch densities (3 - 4 and 5 stitches / cm) on elongation (%) and permanent elongation (%) values. As can be seen from the results in this table, it is seen that the three thread overlock stitched fabric samples sewn with a stitch frequency of 3 stitches / cm showed the highest elongation (%) and permanent elongation (%), and the fabric samples sewn with 5 stitches / cm stitch frequency showed the lowest elongation (%) and permanent elongation (%) results.

3.6 Elongation (%) and Permanent Elongation (%) Values of Fabric Samples Sewn with Five Thread Overlock Stitch

Figure 15 shows the elongation (%) values of the fabric samples sewn with five-thread overlock stitch and the permanent elongation (%) values (after 2 hours) in Figure 16. The statistical (ANOVA and SNK) results of the values obtained from these experiments are also included in Tables 5, 6 and 7. Table 5 contains the statistical results of the effects of different sewing threads on % elongation and % permanent elongation values. As can be seen from the results in this table and Figure 15, the highest elongation in five-thread overlock stitch was obtained in Eloflex-120, Nylon-120 and Spun Pes-120 sewing threads. In Figure 16, the permanent elongation values of the samples sewn with five-thread overlock stitch are high in Eloflex-120 and Poly / Poly-120 sewing threads.

Table 6 contains the statistical results of the effects of different stitch types (lockstitch, zig zag stitch, two thread chain stitch, three thread overlock stitch and five thread overlock stitch) on elongation (%) and permanent elongation (%) values. As can be seen from the results in this table, the five thread overlock stitched samples show the greatest elongation. Permanent elongation values are also high. Among the five types of stitches determined in the experimental study, it is seen as a five thread overlock stitch with stitch stretching feature in the middle.

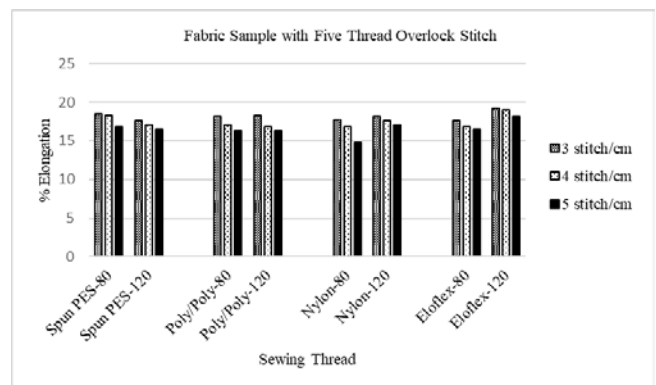

Figure 15. Elongation values (after 30 minutes) of the fabric sample with five thread overlock stitch

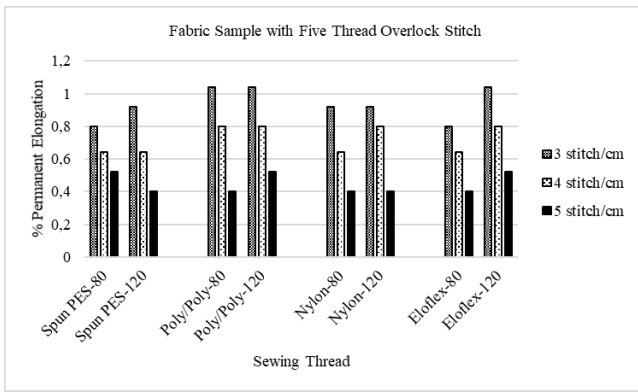

Figure 16. Permanent elongation values (after 2 hours) of the fabric sample with five thread overlock stitch

Table 7 shows the statistical results of the effects of different stitch densities (3 - 4 and 5 stitches / cm) on elongation (%) and permanent elongation (%) values. As can be seen from the results in this table, five thread overlock stitched fabric samples sewn with 3 stitches / cm stitch frequency showed the highest elongation (%) and permanent elongation (%), and fabric samples sewn with 5 stitches / cm stitch frequency showed the lowest elongation (%) and permanent elongation (%) is seen.

4. CONCLUSION

In the apparel industry, stitch should not prevent the fabric from stretching in the garments made of elastane woven fabrics. The elasticity of the stitches of the garments consisting of elastic fabrics is very important. In this study, it is aimed to investigate the elongation and permanent elongation properties of different stitch types of garments made of elastane woven fabrics. For this purpose, 5 different stitch types were selected as lockstitch, zig zag stitch, two thread chain stitch, three thread overlock stitch and five thread overlock stitch and these stitches were sewn at different stitch densities (3 - 4 and 5 stitches / cm) with different sewing threads (spun polyester, core spun (poly / poly), nylon and elastic sewing thread) with two different ticket numbers (80 and 120).

The elongation rate (%) of Eloflex-80 and Eloflex-120 elastic sewing threads and Poly / Poly-120 sewing thread were found to be high and the permanent elongation (%) was also low. Therefore, the elasticity of these sewing threads is evaluated as high. In recent years, elastic sewing threads with high elongation have also been produced for sewing elastic garments. Elastic sewing thread is an ideal thread for sportswear and body-fitting garments. These sewing threads have high elongation and high seam strength and provide stretch seams by preventing damages caused by seam stretch in elastic fabrics.

Besides sewing thread elongation, other important factors that support stitch elasticity are the correct choice of stitch type and stitch density. Although lockstitch (301), which is

the most frequently used stitch type, is a stitch type with the least elasticity, the sewing elasticity values can be increased with the appropriate stitch density. However, this elasticity is not enough. The elasticity of zig zag stitch type 304 is better compared to lockstitch. The best results can be achieved with 500 group overlock stitch types with high sewing elasticity.

The elongation (%) and permanent elongation (%) values of the sewn samples were tested in order to examine the stretch rates of the sewn fabric samples. From the results of the research, it was observed that the elongation rates (%) of three-thread overlock, five-thread overlock and two-thread chain stitches were high, while the elongation rates of lockstitch and zig-zag stitch were low. It has been determined that the permanent elongation values of the three-thread overlock and five-thread overlock stitches are also high. Elasticity of three-thread overlock, five-thread overlock and two-thread chain stitches is higher than lockstitch.

From the results obtained from this study, it was revealed that the stitch density also has an important effect on stitch flexibility. The elongation (%) and permanent elongation (%) values of all stitch types sewn with 3 stitches / cm stitch density were found to be high; The elongation (%) and permanent elongation (%) values of all stitch types sewn with a stitch density of 5 stitches / cm were found to be low. It is desired that the seams of the garments sewn with elastic sewing threads have high stretch properties. However, when the load on the stretched seam is removed, it is desired to be restored. Otherwise, the seam problems may be encountered. Therefore, permanent elongation values in seams are also important. The closer the permanent elongation value is to 0, the fabric does not become loose or bagged, and the stitches do not open or grin, and the sooner it reaches its former state. From the results obtained in this study, it was concluded that the best density value was 4 stitches / cm since the samples sewn with 4 stitches / cm showed an average elongation and permanent elongation values in all stitch types.

From the results obtained from this study, it was observed that the best elasticity was achieved with overlock and two-thread chain stitches, with a stitch density of 4 stitches / cm and elastic sewing threads and corespun (poly / poly) sewing threads applied to garments made of elastane woven fabric.

ACKNOWLEDGMENT

This study was supported by Tübitak 1002 Project with 119M028 number. We would like to express our sincere gratitude to TUBITAK for the support also we would like to thank Savcan Textile Factory, Bursa for fabric supply and Coats Factory, Bursa for sewing threads supply.

REFERENCES

1. Gürarda A. 2005. An investigation for sewing problems of elastic fabrics in clothing industry (doctoral dissertation). Bursa Uludag University, Graduate School of Natural and Applied Sciences, Department of Textile Engineering, Bursa, Turkey.
2. Gürarda A, Meriç B. 2005. The effects of silicone and pre-fixation temperature on the elastic properties of cotton/elastane woven fabrics. *AATCC Review* 9, 53-56.
3. Gürarda A. 2008. Investigation of the seam performance of pet/nylon- elastane woven fabrics. *Textile Research Journal* 78(1), 21-27.
4. Gürarda A, Meriç B. 2010. Slippage and grinning behaviour of lockstitch seams in elastic fabrics under cyclic loading conditions. *Tekstil ve Konfeksiyon* 20(1), 65-69.
5. Rashid MR, Ahmed F, Azad AK. 2012. An investigation about abrasion resistance and seam stretchability properties of weft knitted fabrics made from conventional ring and compact yarn. *International Journal of Scientific and Research Publications* 2(3), 2-6.
6. Akter M, Khan MR. 2015. The effect of stitch types and sewing thread types on seam strength for cotton apparel. *International Journal of Scientific & Engineering Research* 6(7), 198-205.
7. Zeto W, Dhingra RC, Lau KP, Tam H. 1996. Sewing performance of cotton/lycra knitted fabrics. *Textile Research Journal* 66(4), 282-286.
8. Carr H, Latham B. 1998. *The technology of clothing manufacture*, Oxford: BSP Professional Books, , 13-35.
9. Mehta PV. 1992. *An Introduction to quality control for the apparel industry*. Wisconsin: ASQC Quality Press, 80-83.
10. Demir A, Günay M. 1999. *Tekstil Teknolojisi*. İstanbul: Şan Ofset.
11. Wirth E. 2001. Dokuma makinasında elastan iplikle çalışma, *Melliand Türkiye* 3, 72-75.
12. Sewing Threads. 2021. January 10. Retrieved from <https://www.coats.com/tr/Products?type=Threads&type=Threads>.
13. Bubania JE. 2014. *Apparel quality*, England: Fairchild Books, 129-131.
14. ASTM D 6193, Standard Practice for Stitches and Seams, American Society for Testing and Materials, USA, 1990.
15. TS 6071, Dokunmuş Kumaşların Giyim Sebebiyle Torbalanma ve Uzamaya Karşı Mukavemetlerinin Tayini Metodu. Türk Standartları Enstitüsü, Türkiye, 1988.
16. ASTM D 3107-07, Standard Test Method for Stretch Properties of Fabrics Woven from Stretch Yarns, American Society for Testing and Materials, USA, 2015.
17. Gorjanc DS. 2006. Elastic properties of sewing threads after stretching. *Tekstilec* 49(10-12), 218-224.
18. Tylor DJ. 2008. *Carr and Latham's Technology of Clothing Manufacture*, Blackwell Publishing, 129-130.
19. Mandal S, Abraham N. 2010. An overview of sewing threads mechanical properties on seam quality. *Pakistan Textile Journal* 59(1), 40-43.
20. ASTM D 1776, Standard Practice for Conditioning and Testing Textiles, American Society for Testing and Materials, USA, 1990.
21. Flexi-Frame Stretch and Recovery Tester (James Heal). 2021, January 15. Retrieved from <https://www.james-heal.co.uk/instrument/flexiframe/>