

This paper was recommended for publication in revised form by Editor in Chief Ahmet Selim Dalkilic

EXPERIMENTAL PERFORMANCE OF R134a AND R152a USING MICROCHANNEL CONDENSER

*** V. W. Bhatkar**

Research Scholar,
G. H. Raisoni College of Engineering
Nagpur, Maharashtra, India

V. M. Kriplani

Professor, Dept. of Mechanical Engineering
G. H. Raisoni College of Engineering
Nagpur, Maharashtra, India
vilayatrai.kriplani@raisoni.net

G. K. Awari

Principal, Tulsiramji Gaikwad-Patil
College of Engineering &
Technology, Nagpur, India
gkawari@rediffmail.com

Keywords: R134a, R152a, microchannel condenser, coefficient of performance

** Corresponding author: V. W. Bhatkar, Phone: +919011058250 Fax:*

E-mail address: vijaybhatkar2009@gmail.com

ABSTRACT

An experimental performance study on vapour compression refrigeration system with R134a and drop in substitute R152a with aluminium microchannel condenser was carried out for condensation temperature of 48°C while evaporation temperature varied from -10 to 15°C. Refrigerant charge of R152a was reduced by 40% over R134a with the microchannel condenser. Performance parameters like work input to the compressor, coefficient of performance, refrigerating capacity, condenser capacity and the product of the overall heat transfer coefficient & surface area of the condenser are plotted and results are discussed.

INTRODUCTION

Vapour compression refrigeration (VCR) systems are widely used in the world for heating, ventilating, air conditioning and refrigeration (HVACR). The global warming potential (GWP) of R134a is around 1400 and it is quite high considering the environmental standards. Keeping in view the environmental, ecological and health point of view, it is an urgent need to find the alternative refrigerant to R134a. The main problem with the VCR system is the consumption of high

grade energy. The performance of the refrigeration system can be improved by lowering the compressor power consumption, increasing the condenser heat rejection capacity or reducing the difference between condenser and evaporator pressures [1-2]. Heat exchanger with reliable and high performance has been the object of the refrigeration and air conditioning system. In recent years, with increasing demand for lighter weight and rising copper prices, copper substitution is a widespread concern. Microchannel heat exchanger has been extensively researched and applied in the cooling of electronic equipments. Along with the improving of process technology, microchannels can be used in household air conditioning and automotive air conditioning systems. Compared with the conventional heat exchanger, microchannel heat exchanger is different in flow and heat transfer characteristics. The microchannel geometry and size have significant impact on the performance of the heat exchangers [3]. As the diameter of the heat exchanger tube is reduced, the heat transfer coefficient increases but the pressures drop also increases [4]. The pioneering researchers have laid a solid foundation for automotive industry to completely embrace the microchannel condenser technology because of its merits in thermal performance, structural robustness, compactness, weight reduction, corrosion resistance in comparison to

traditional tube and fin heat exchanger technology [5]. In order to improve the performance of VCR system, reducing the refrigerant charge and the costs, conventional round copper tube aluminium plate fin condenser was replaced with aluminium rectangular microchannels with aluminium plate fins with four tube passes in order to control the pressure drop [6 - 7]. Condensation heat transfer in micro/mini channels is of great practical importance in development of next generation ultra compact and high performance two phase flow thermal systems [8]. Microchannels are viewed as being responsible for the mitigation of ozone depletion by enabling the use of smaller amounts of environmentally harmful fluids and also reducing green house gas emissions by improving component and system energy efficiencies [9-11]. The growing energy demand, the need for increased energy efficiency and material savings, space limitations for device packaging, increased functionality and ease of unit handling have created revolutionary challenges for the development of high performance, next-generation heat and mass exchangers [12-14]. When properly designed and utilized, microchannels can distribute the flow precisely among the channels, reduce flow travel length and establish laminar flow in the channels while achieving high heat transfer coefficients, high surface area to volume ratios and reduced overall pressure drop [15-20]. R152a is a HFC refrigerant, mild flammable, GWP as 120 which is below the European Union (EU) standards [21-25]. Thus R152a is considered as a straight drop in substitute to R134a in the designed VCR system and experiments were performed with the microchannel condenser. Figure 1 clearly shows that saturation pressure of R152a closely approaches to that of R134a.

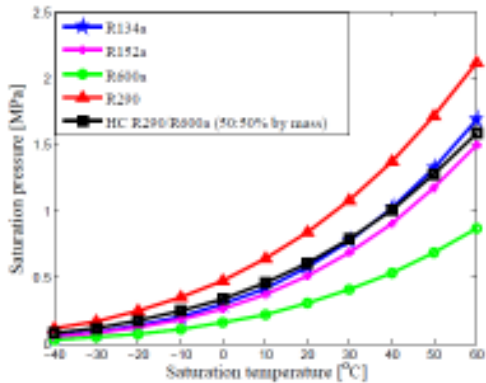

Figure 1. Saturation pressure vs. temperature

EXPERIMENTAL APPARATUS

Experimental setup was fabricated for 1 TR of refrigeration system with the forced convection, air cooled condenser with three air heaters of 2.2 kW capacity each in the condenser compartment to increase the ambient temperature, fan speed regulator to achieve the desired condensation temperature, glycol cooled evaporator with stirrer (12 Watt motor, 60 RPM rotor) and two 2.2 kW capacity water heaters & manually controlled expansion valve. Measuring instruments like

pressure gauges, voltmeter, ammeter, rotameter, thermal sensors (TICs-temperature indicator and controls) for temperature measurement, anemometer and infrared thermometer etc. equipments were used for accurate measurements.

In the experimental setup, condenser pressure was controlled with the help of air heater temperature and multi speed fan regulator. The material for microchannel condenser tubes and fins was aluminium. Each rectangular tube was containing 10 rectangular microchannels. The hydraulic diameter for each rectangular microchannel was 0.914mm. Microchannel condenser was designed with the integral receiver and drier. Evaporator temperature was controlled with the help of manually controlled expansion valve and setting the suction temperature of the refrigerant with the help of proportional, integral and derivative (PID) controller. Ethylene glycol (25% by mass) was mixed with the water in the evaporator in order to reduce the water temperature below 0°C. Temperature and pressure indicators, rotameter, air heaters, expansion valve, drier, accumulator and the positions of the VCR system components were shown in Fig. 2. Figure 3 shows the front view of the experimental setup and Fig. 4 shows the actual photograph of microchannel condenser along with cross section of microchannel.

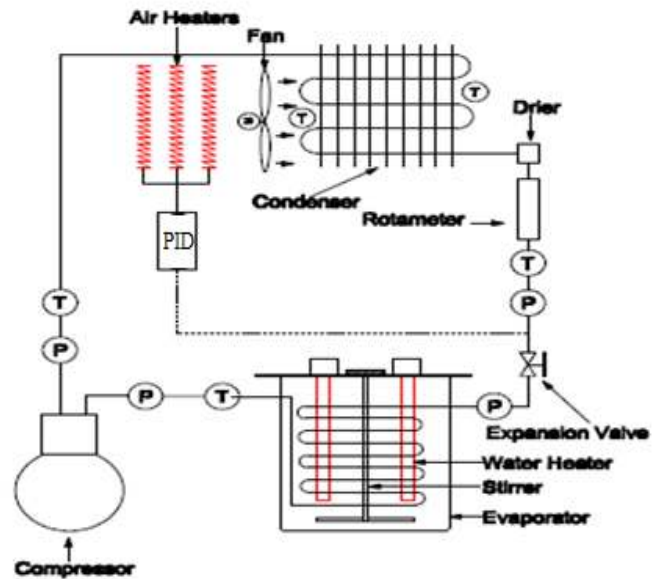

Figure 2. Schematic diagram of experimental setup

EXPERIMENTAL PROCEDURE

The objective of the research was to analyze and compare the performance of the VCR system with R134a and R152a by using aluminium microchannel condenser in terms of refrigerating capacity (RC), compressor energy consumption (Wc), coefficient of performance (COP), condenser capacity and product of overall heat transfer coefficient and area of condenser (UA).



Figure 3. Front view of experimental setup



Figure 4. Microchannel condenser with profile of channel

Experiments were performed for condensation temperature of 48°C and for each condensation temperature; evaporator temperature was varied from -10 to 15°C. Pressure gauges were attached before and after the evaporator and condenser for measuring the pressure drop with an accuracy of ±1 psi. Rotameter was used to measure the rate of flow of refrigerant with an accuracy of ± 0.5 kg/hr. Refrigerant temperatures were recorded at various points such as suction and discharge of compressor, subcooled liquid at the exit of condenser, glycol in the evaporator tank, air flow before and after the condenser with the help of PT-100 temperature sensors with an accuracy of ± 0.1°C. Surface temperatures along the condenser were measured with the help of infrared thermometer with an accuracy of ± 0.5°C. Velocity of air over the condenser was measured with the help of anemometer with an accuracy of ± 0.1m/s. Compressor and heater power consumption in kW was measured separately with the help of digital energy meters with an accuracy of ±

0.01kW. Experimental uncertainties were calculated by using following equations (26).

$$\text{For Addition } (A \pm a) + (B \pm b) \\ w_r = (a^2 + b^2)^{0.5} \quad (1)$$

$$\text{For Substraction } (A \pm a) - (B \pm b) \\ w_r = (a^2 + b^2)^{0.5} \quad (2)$$

$$\text{For Multiplication } (A \pm a) \times (B \pm b) \\ w_r = \left[\left(\frac{a}{A} \right)^2 + \left(\frac{b}{B} \right)^2 \right]^{0.5} \quad (3)$$

$$\text{For Division } (B \pm b) \div (A \pm a) \\ w_r = \frac{B}{A} \left[\left(\frac{a}{A} \right)^2 + \left(\frac{b}{B} \right)^2 \right]^{0.5} \quad (4)$$

Table 1 shows the actual dimensions of Microchannel condenser and Table 2 shows the uncertainties in the measurements.

Table 1 Dimensions of Microchannel condenser

Sr No	Parameters	Dimensions
1	Face area	0.470x0.310 = 0.146 m ²
2	Tube and fin material	Aluminum
3	Overall dimensions	470mmx310mmx15 mm
4	Weight	1.6 kg
5	Fin density	1 fin/mm
6	Fin height	8 mm
7	Fin width	15 mm
8	Fin thickness	0.1 mm
9	Hydraulic diameter	0.9144 mm
10	Air side area	4.066 m ²
11	Refrigerant side area	0.457 m ²
12	No of passes	4(Tubes/pass,14,10,4,3)

Table 2 Uncertainties of various parameters [26]

SN	Parameter	Uncertainty (%)
1	Surface area of condenser	± 1.3
2	Refrigerant mass flow rate	± 2.05
3	Heat rejected by condenser	± 3.5
4	Refrigeration capacity	± 4.5
5	Power consumption	± 1.0
6	COP	± 3.6
7	Heat transfer coefficient	± 10.64
8	Temperature	± 2.8
9	Pressure	± 5

RESULTS AND DISCUSSION

Keeping in view the superior thermodynamic properties of R152a, performance parameters and the major environmental impacts such as ODP, GWP, carbon emission, green house gas emissions, R152a can be used to phase out R134a for small household refrigeration and air conditioning appliances without hazards using mini/micro-channel condenser. During the experimental test, R152a refrigerant was found to be safe. However as R152a is flammable refrigerant, care should be taken while using them. Leak free design of vapour compression system, specially designed compressors for R152a refrigerant, indirect heating or cooling using the secondary heat transfer fluids can be the possible solutions. Also it is pointed out that the results obtained from this research may vary slightly depending upon the refrigerant charge, experimental and the environmental conditions.

Performance parameters of the VCR system such as actual work of compression, coefficient of performance, refrigerating capacity, condenser capacity and the product of experimental UA were analyzed for condensation temperature of 48°C with the microchannel condenser using R134a and R152a while the evaporation temperature varied from -10 to 15°C as follows.

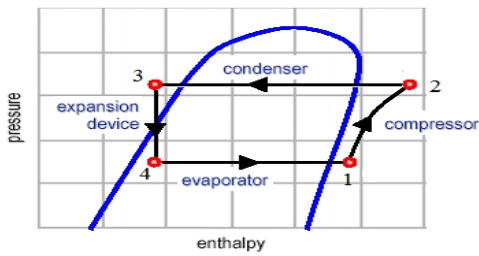

Figure 5. p-h diagram of VCR cycle

Equations used for calculation of performance parameters as follows.

$$\text{Compressor power consumption} = m (h_2 - h_1) \tag{5}$$

$$\text{Refrigeration capacity} = m (h_1 - h_4) \tag{6}$$

$$\text{COP} = \frac{(h_1 - h_4)}{(h_2 - h_1)} \tag{7}$$

$$\text{Overall heat transfer coefficient (U)} = \frac{Q}{A \times \Delta T} \tag{8}$$

Actual work of compressor

As R152a refrigerant charge is less than R134a in the refrigeration system, actual compressor work is smaller than R134a. Microchannel condenser results into 2 to 2.5°C lower

condensation temperature due to its geometrical construction thus it reduces the work of compression. It was seen that for the same condensation temperature, as the evaporation temperature increases, the work of compression increases due to increased mass flow of refrigerant and the refrigeration capacity of the system as seen from Fig. 6. It was pointed out that as the evaporation temperature increases from -10 to 15°C for same condensation temperature, the specific work (kJ/kg) of compressor decreases as the pressure ratio decreases. Compressor work consumption is slightly less for R152a than R134a at all evaporation temperatures thus R152a can be considered as a drop in substitute to R134a. Figure 7 shows the actual work of compression for microchannel and conventional condenser for R134a and R152a at $T_c = 48^\circ\text{C}$ and $T_e = 0^\circ\text{C}$.

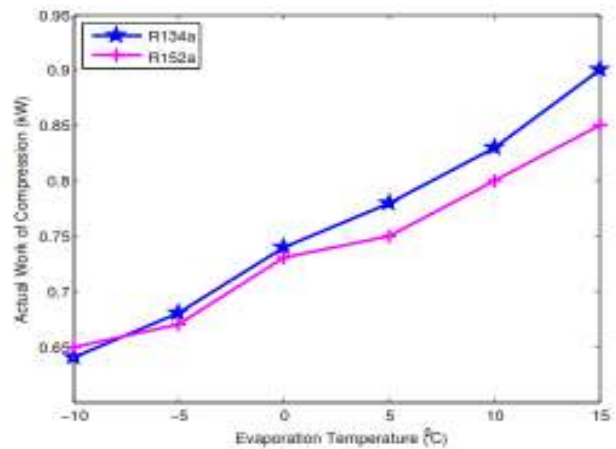

Figure 6. Actual work of compression vs. evaporation temperature at condensation temperature of 48°C

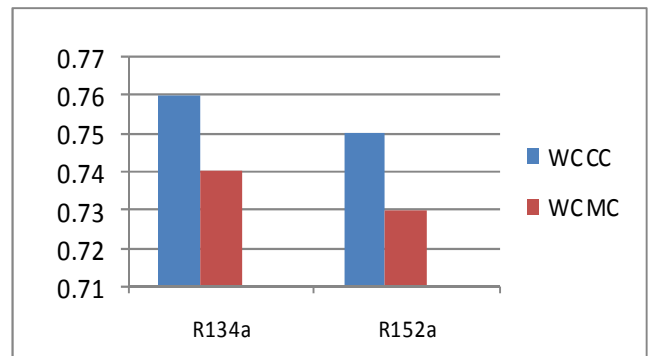

Figure 7. Actual work of compression for R134a and R152a at condensation temperature of 48°C and evaporation temperature of 0°C for conventional and microchannel condenser

Coefficient of Performance (COP)

Figure 8 shows the COP variation with respect to the evaporation temperatures for R152a and R134a. As the pressure ratio between condenser and evaporator reduces by using the

microchannel condenser, the compressor work consumption reduces thus theoretical COP increases. COP of R152a was more than R134a at all the evaporation temperatures. The results show the same trend as obtained by Bolaji [27] and Bhaskran [28]. Figure 9 shows the COP of R134a and R152a with microchannel and conventional condenser.

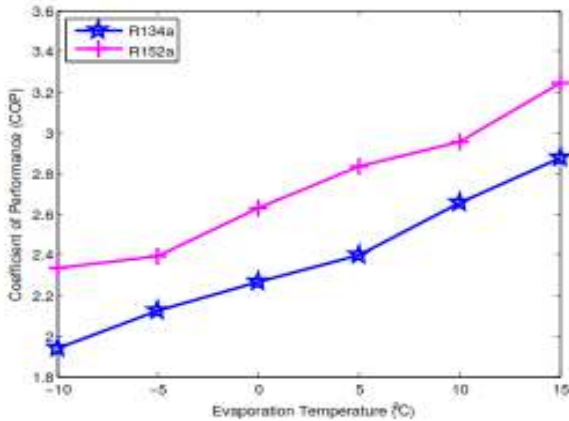

Figure 8. Coefficient of performance vs. evaporation temperature at condensation temperature of 48°C

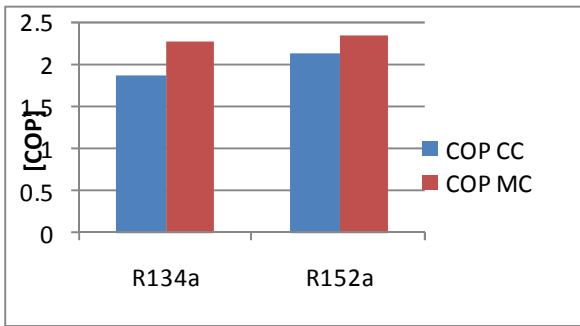

Figure 9. COP for R134a and R152a at condensation temperature of 48°C and evaporation temperature of 0°C for conventional and microchannel condenser

Refrigerating capacity

Figure 10 shows the refrigeration capacity for all the refrigerants considered at 48°C condensation temperature and evaporation temperatures ranging from -10 to 15°C. It was observed that as the evaporation temperature increases, refrigeration capacity increases. It is seen that the refrigerating capacity of R152a is more than R134a. Also it was observed that the cooling was fast in case of R152a due to higher latent heat than R134a. The results show the same trend as Bolaji [27] and Bhaskran [28]. Figure 11 shows the refrigerating capacity for R134a and R152a at condensation temperature of 48°C and evaporation temperature of 0°C for conventional and microchannel condenser.

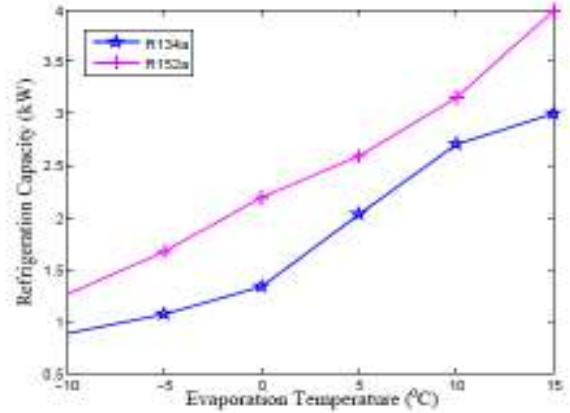

Figure 10. Refrigeration capacity vs. evaporation temperature at condensation temperature of 48°C

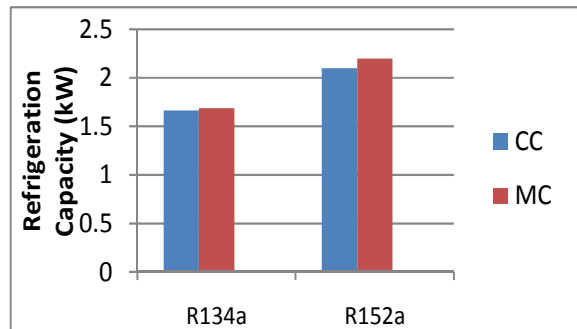

Figure 11. Refrigerating capacity for R134a and R152a at condensation temperature of 48°C and evaporation temperature of 0°C for conventional and microchannel condenser

Condenser capacity

Low viscosities of liquid and vapour phases, high liquid specific heat, high thermal conductivities of liquid and vapour phases, high latent heat are important properties for refrigerant selection. Figure 12 shows the condenser capacity of R134 and R152a at condensation temperature of 48°C while evaporation temperature varying from -10 to 15°C. As the latent heat of R152a is more than R134a, condenser capacity is more for R152a. The discharge temperature influences the stability of lubricants and compressor components. It was observed that the discharge temperature of R152a was more by 6 to 10°C than R134a, as studied by Bolaji [27] and Bhaskran [28]. Figure 13 shows the condenser capacity for R134a and R152a at condensation temperature of 48°C and evaporation temperature of 0°C for conventional and microchannel condenser.

Product of overall heat transfer coefficient and surface area of condenser (UA)

Figure 14 shows the plot of UA versus the evaporation temperature for microchannel condenser. Product of overall

heat transfer coefficient (U) and surface area of condenser (A) represents the heat exchanger capacity per degree of mean temperature difference which is used for comparing the performance of heat exchangers. LMTD was calculated

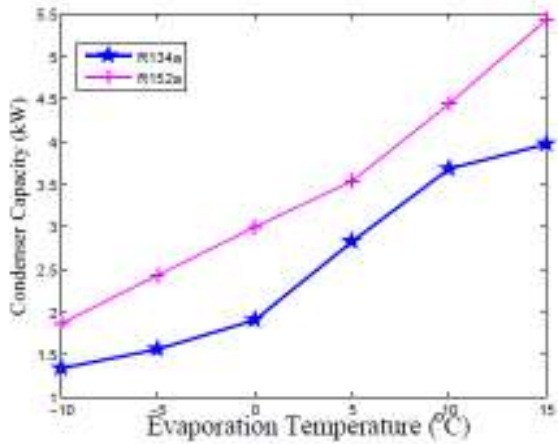

Figure 12. Condenser capacity vs. evaporation temperature at condensation temperature of 48°C

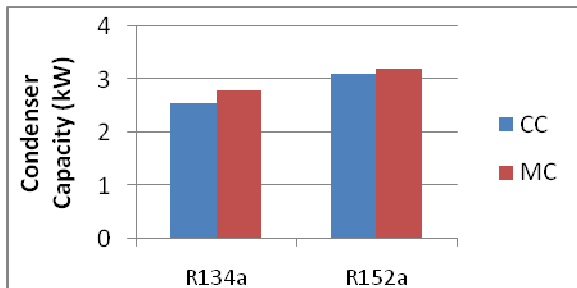

Figure 13. Condenser capacity for R134a and R152a at condensation temperature of 48°C and evaporation temperature of 0°C for conventional and microchannel condenser

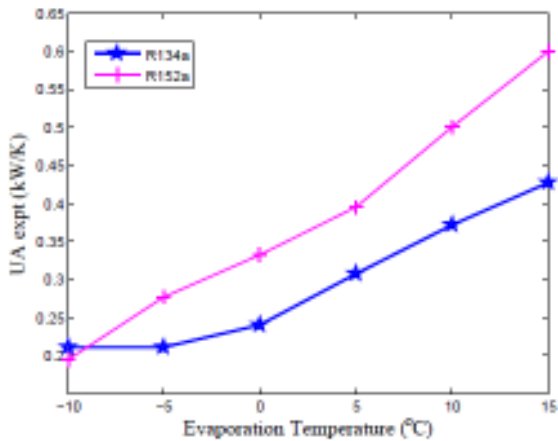

Figure 14. UA experimental vs. evaporation temperature at condensation temperature of 48°C

knowing the temperature of air before and after the condenser at specific condensation temperature. It was observed that microchannel condenser works effectively at higher ambient conditions as the condensation temperature drops by 2 to 2.5°C. The product of overall heat transfer coefficient and surface area (UA) was more for R152a than R134a at all evaporation temperatures.

Pressure drop across the condenser

Figure 15 shows the actual pressure drop measured across the condenser with the pressure gauges attached before and after the condenser. It was found that for all condensation temperatures, the pressure drop with the microchannel condenser was less than conventional condenser due to the special construction of microchannel condenser.

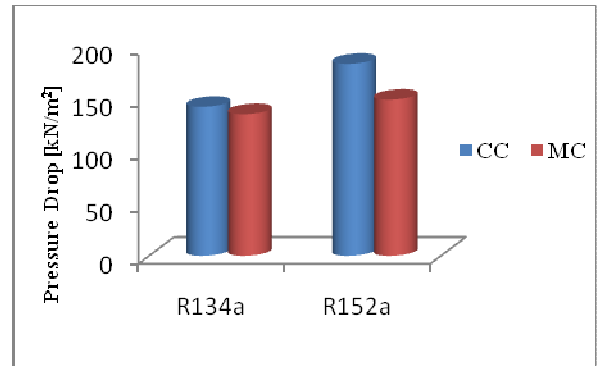

Figure 15. Actual pressure drop for conventional and microchannel condenser

CONCLUSIONS

Following conclusions were drawn.

- Refrigerant charge was reduced by 40% with the use of microchannel condenser over the conventional condenser.
- R152a is soluble with polyolester (POE) as applicable to R134a.
- Discharge temperature of R152a was more than R134a by around 6 to 10°C.
- The condensation temperature drops by 2 to 2.5°C by using microchannel condenser over the conventional condenser for same ambient temperature.
- The compressor energy consumed by R152a is slightly less than R134a from -10 to 15°C.
- COP with R152a refrigerant was more than R134a for all evaporator temperatures.
- Volumetric refrigerating capacities of R134a and R 152a are 2200kJ/m³ and 2173kJ/m³ respectively at condensation temperature of 48°C and evaporation temperature of 6°C which needs to be considered while selecting the compressor.
- Condenser capacity for R152a was higher than R134a because of large latent heat.

- The two phase heat transfer coefficient of R152a was more than R134a.
- Average heat transfer coefficient shows a descending trend with increasing saturation temperature. It was seen that the condensation heat transfer coefficients of R152a were 200-300% more than R134a at all condensing temperatures.
- The product of overall heat transfer coefficient and surface area of the condenser (UA) were more for microchannel condenser than conventional condenser.
- It was found that the pressure drop was less in microchannel condenser than conventional condenser by around 0.1 to 0.5 bar. Also it was found that with the increasing saturation temperature shows a significant effect on decreasing the pressure drop.

NOMENCLATURE

A	surface area of condenser with fins (m ²), constant
a, b, B	constants
CC	conventional condenser
h	enthalpy (kJ/kg)
MC	microchannel condenser
m _r	mass flow rate of refrigerant (kg/s)
Q	heat rejected by condenser (kW)
T _c	condensation temperature (K)
T _e	evaporation temperature (K)
U	overall heat transfer coefficient (W/m ² K)
WC	work of compression (kW)
w _r	uncertainty
ΔT	log mean temperature difference (K)

ACKNOWLEDGMENTS

The authors acknowledge the financial support from the Board of Colleges and University Development (BCUD), University of Pune, India under Grant No 11ENG000264. Authors express their gratitude towards Mr. Shivprasad kalluraya, Cosmic Refrigeration Private Limited, Pune, India for providing the guidance and adequate facilities for experimentation.

REFERENCES

[1] Dalkilic A. S., Wongwises S., 2010, "A performance comparison of vapour compression refrigeration system using various alternative refrigerants," *International Communication in Heat and Mass Transfer* 37, 1340-1349.

[2] Elsayed A. O., Hariri A. S., 2011, "Effect of condenser air flow on the performance of split air conditioner," *World Renewable Energy Congress, Sweden*, 2134-2141.

[3] Yanhui H., Yan L., Ming L. J., 2011, 2nd International Conference on Advances in Energy Engineering (ICAEE2011), Elsevier, *Energy procedia*, 14, 148-153.

[4] Copetti J. B., Macagnan M.H., Figueiredo C.O., 2009, "Design and optimization of minichannel parallel flow condensers," *Seventh International Conference on Enhanced, Compact and Ultra-Compact Heat Exchangers: From Micro scale Phenomena to Industrial Applications*.

[5] Liang Y., Tonga M., Wei L., Zeng X., 2009, "Design and analysis of multiple parallel pass condensers," *International Journal of Refrigeration* 32, 1153-1161.

[6] Koyama S., Kuwahara K., Nakashita K., Yamamoto K., 2003, "An experimental study on condensation of refrigerant R134a in a multi-port extruded tube," *International Journal of Refrigeration* 24, 425-432.

[7] Fernando P., Palm B., Ameel T., Lundqvist P., Granryd E., 2008, "A minichannel aluminium tube heat exchanger-Part-III, condenser performance with propane," *International Journal of Refrigeration* 31, 696-708.

[8] Ebrahim A., Shooshtari A. H., Dessiatoun S., Ohadi M. M., 2013, "Performance characterization of R134a and R245fa in a high aspect ratio microchannel condenser," *International Journal of Refrigeration* 36, 588-600.

[9] Kandlikar S., Garimella S., Li D., Colin S., King M. R., 2006, "Heat transfer and fluid flow in minichannels and microchannels, First edition, Elsevier Publication, U.K.

[10] Matkovic M., Cavallini A., Col D. D., Rossetto L., 2009, "Experimental study on condensation heat transfer inside single circular minichannel," *International Journal of Heat and Mass Transfer* 52, 2311-2323.

[11] Wei L., Wu Z., 2010, "A general criterion for evaporative heat transfer in micro/mini-channels," *International Journal of Heat and Mass Transfer* 53, 1967-1976.

[12] Jwo C. S., Ting C. C., Wang W. R., 2009, "Efficiency analysis of home refrigerators by replacing hydrocarbon refrigerants," *Measurement* 42, 697-701.

[13] Bhatkar V. W., Kriplani V. M., Awari G. K., 2013, "Alternative refrigerants in vapour compression refrigeration cycle for sustainable environment: a review of recent research," *International Journal of Environmental Science and Technology*, 10, 871-880.

[14] Bhatkar V. W., Kriplani V. M., Awari G. K., 2013, "Numerical simulations of a aluminium microchannel condenser for household air conditioner," *International Review of Mechanical Engineering*, 7, 183-190.

[15] Yun R., Heo J. H., Kim Y., 2006, "Evaporative heat transfer and pressure drop of R410A in microchannels," *International Journal of Refrigeration* 29, 92-100.

[16] Chang Y.S., Kim M.S., Ro S.T., 2000, "Performance and heat transfer characteristics of hydrocarbon refrigerants in a heat pump system," *International Journal of Refrigeration* 23, 232-242.

[17] Ohadi M., Choo K., Dessiatoun S., Cetegen E., 2013, "Next generation microchannel heat exchangers," *springer briefs in thermal engineering and applied science*, vol. 7.

- [18] Park H.S., Punch J., 2008, "Friction factor and heat transfer in multiple microchannels with uniform flow distribution," *International Journal of Heat and Mass Transfer* 51, 4535-4543.
- [19] Kim S.M., Mudawar I., 2013, "Universal approach to predicting heat transfer coefficients for condensing mini/micro-channel flow" *International Journal of Heat and Mass Transfer* 56,238-250.
- [20] Palm B., 2007, "Refrigeration systems with minimum charge of refrigerant," *Applied Thermal Engineering* 27, 1693-1701.
- [21] Palm B., 2008, "Hydrocarbon as refrigerants in small heat pump and refrigeration systems- a review," *International Journal of Refrigeration* 31, 552-563.
- [22] Poggi F., Macchi-Tejedaa H., Leducqa D., Bontempsb A., 2008, "Refrigerant charge in refrigerating systems and strategies of charge reduction," *International Journal of Refrigeration* 31, 353-370.
- [23] Agarwal A., Bandhauer T. M., Garimella S., 2010, "Measurement and modeling of condensation heat transfer in non-circular microchannels," *International Journal of Refrigeration* 33, 1169-1179.
- [24] Zhao Z.Y., Chen J., 2010, "Performance enhancement study of mobile air conditioning system using microchannel heat exchangers," *International Journal of Refrigeration* 33, 301-312.
- [25] Lu X., Nnanna A. G., 2008, "Experimental study of fluid flow in microchannel" ASME International Mechanical Engineering Congress and Exposition, Boston, Massachusetts, USA.
- [26] ASHRAE Guidelines 2, 1986, "Engineering Analysis of Experimental Data," pp. 1-20.
- [27] Bolaji B. O., Akintunde M. A., Falade T. O., 2011, "Comparative analysis of performance of three ozone friendly refrigerants in a vapour compression refrigerator," *Journal of Sustainable Energy and Environment*, 2, 61-64.
- [28] Bhaskaran A. Koshy Mathews P., 2012, "A performance comparison of vapour compression refrigeration system using eco-friendly refrigerants of low global warming potential," *International Jou. Of Scientific and Research Publications*, 2 (9) 1-8.