



Research Article

DESIGNING A FUZZY LOGIC CONTROLLER FOR A SINGLE INTERSECTION: A CASE STUDY IN GAZIANTEP

Türkay DERELİ^{1,2}, Cihan ÇETİNKAYA³, Nazmiye ÇELİK*⁴

¹Gaziantep University, Department of Industrial Engineering, GAZIANTEP; ORCID:0000-0002-2130-5503

²Iskenderun Technical University, Office of the President, Iskenderun-HATAY; ORCID:0000-0002-2130-5503

³Adana Science and Technology University, Department of Management Information Systems, ADANA; ORCID:0000-0002-5899-8438

⁴Gaziantep University, Department of Industrial Engineering, GAZIANTEP; ORCID:0000-0001-6354-8215

Received: 27.02.2018 Revised: 23.05.2018 Accepted: 30.07.2018

ABSTRACT

The traffic problem is a multidimensional problem and traffic lights are the key points to solving this problem. Thus, optimum green light duration helps reduce the traffic congestion. “Queue length during red light” and “remaining vehicles in line after green light” are important parameters for the determination of the green light duration. In this paper, a single intersection is taken into account with mentioned two inputs of fuzzy logic controller considering each intersection approach one by one. The output variables are chosen as “phase selection” and “extend of green light duration”. Unlike many other studies, these output variables are combined into one system based on modal distinction. Each approach is normalized according to the number of lanes to calculate a membership function value: because of different capacities of intersection approaches. The model is solved using MATLAB fuzzy inference system. The delay parameter is considered as performance measurement. Accordingly, proposed model is compared with various traditional models in literature. Finally, the model is evaluated using ANN (artificial neural network modeling) and ANFIS (adaptive neuro-fuzzy inference system) and then the consistency of the results is checked. Results show that the fuzzy controller can effectively minimize total delay and it is superior to compared methods.

Keywords: Adaptive neuro-fuzzy, artificial neural network, fuzzy logic controller, Gaziantep, single intersection, traffic light.

1. INTRODUCTION

Traffic congestion is one of the major problems of city life. If the traffic flow is desired to be under control, the capacity of roads must be met due to the increasing demand. Effective signal control at intersections is influential over traffic flow.

In the literature, various fuzzy logic traffic signal control methods based on coordinated and isolated intersections were proposed. Chiu and Chand [1,2] proposed a distributed approach for light control at coordinated intersections. Niittymaki et al. [3] improved a fuzzy control technique (ITCARI) for arterial roads supported by previous FUSICO (fuzzy logic signal group control) project. Chou and Teng [4] handled coordinated intersections, vehicle length, road length, and

* Corresponding Author: e-mail: nazmiye@gantep.edu.r, tel: (342) 316 26 33

several lanes. The proposed controller was performed by distinctive inputs, diminished control rules and less inference density- unlike other systems. Li and Fan [5] employed a novel signal controller that utilized fuzzy logic and weighting factors. The weighting module was produced to replace the connection among intersections.

Many fuzzy logic control systems for isolated intersections have also been proposed. Isolated signalization system works independently from other signalization systems that are constructed at near intersections. Important studies based on two-stage fuzzy logic controller have been developed for isolated intersections. These stages indicate phase selection and optimization of green light duration to adjust traffic signals [6-15]. Another study conducted by Zaiied and Othman [16] that considered two two-way streets and gave better results in terms of waiting duration, queue length and moving duration. Teo et al. [17] proposed a movable fuzzy logic controller for Malaysia. The Petri Net tool was conducted to model traffic flow. Alam and Pandey [18] implemented an intelligent signal system benefiting from sensors. The system was simulated via MATLAB software and experiments indicated that better results were provided. Homaei et al. [19] developed a novel traffic light controller base on fuzzy logic for an entirely isolated junction including priority of emergency vehicles with turning motions. Nadia Postorino and Versaci [20] proposed a model to relieve traffic flows and diminish delay at road-signalized intersections using real-time methods and traffic lights adaptation. Rao and Zakaria [21] developed a traffic light control system based on fuzzy inference system (FIS). The system can be performed to provide a smooth traffic flow without long queues and delays. Shirvani and Maleki [22] proposed fuzzy control model based on traffic actuated control for isolated intersection. The studies mentioned have all reported good performance of the fuzzy logic controllers.

Many attempts have been done for implementing artificial intelligence techniques to increase the performance of the traffic light controlling. Nakatsuji and Kaku [23] introduced a multilayer neural network model to understand self-organizing traffic control model. Model includes split lengths of signal phases as inputs to minimize queue lengths. Results of model were promising. Araghi et al. [24] applied machine learning techniques including neural networks to determine green times in an isolated intersection. According to the results, implemented of method was reduced the total delay.

Araghi et al. [25] applied adaptive neuro-fuzzy inference system for optimizing green times and minimizing travel delay time. Their ANFIS technique was compared to fuzzy logic-based genetic algorithm, fixed fuzzy logic controller and fixed time traffic controller. Lai et al. [26] generated data based on fuzzy rules, and then developed traffic signal controller using ANFIS. According to the study, performance of ANFIS is better than fuzzy and traditional controllers. Udofia et al. [27] proposed a traffic light phase sequencing using ANFIS for a single intersection. Seesara and Gadit [28] developed ANFIS based traffic control system and made comparisons with fuzzy logic vs. fixed-time controllers.

In the above-mentioned models, fuzzy logic was used and compared with one or several techniques or compared with one or several methods using the ANFIS or neural network models. In the proposed study, all methods of mentioned are shown together. The aim of this paper is to design a Fuzzy Logic Controller for a Single Intersection in Gaziantep (FLCSIG) to adjust green light duration and minimize total delay while reducing the number of waiting vehicles. FLCSIG is introduced and solved using MATLAB fuzzy inference system. Later, proposed model is compared with traditional Webster model, a new model performed with regression analysis and an existing mathematical model that is solved by GAMS (The General Algebraic Modeling System). Accordingly, other artificial intelligence techniques like ANN and ANFIS are used to assess performance of fuzzy inference system among other techniques that consider uncertainties.

The paper is organized as follows; section 2 describes methodology and assumptions of FLCSIG and comparison with traditional techniques, and then evaluates the results. Section 3 describes comparison of fuzzy logic controller with ANN and ANFIS. Finally last section presents the conclusion.

2. MATERIALS AND METHODS

On Gaziantep University Boulevard, a 4-phase intersection which is free to turn left is considered. The view for 4 approaches (A, B, C and D) is shown in Figure 1-a, 1-b. Approach is group of lanes at an intersection. It is also called as arm.

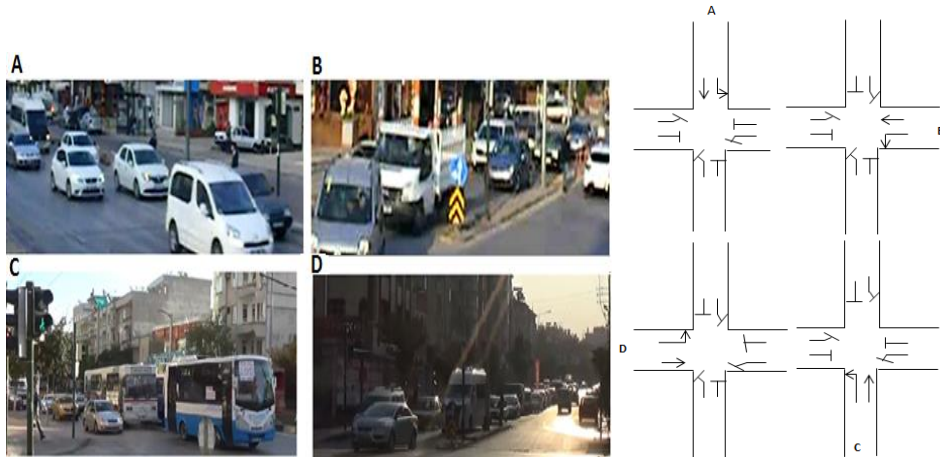

Figure 1-a. Four-phased isolated intersection

Figure 1-b. Intersection Diagram

2.1. Fuzzy Logic

Fuzzy idea was introduced first by Zadeh [29] in 1965. Zadeh described fuzzy set as a group of items with a process of membership degree. Each item in the set is rated by membership function varying between zero and one. According to the classical sets, an object either belongs to that set or not. A fuzzy inference system is needed to design a fuzzy logic controller. As it is seen in the Figure 2, a fuzzy inference system is based on fuzzification process, rule base, inference engine (decision-making module) and defuzzification process.

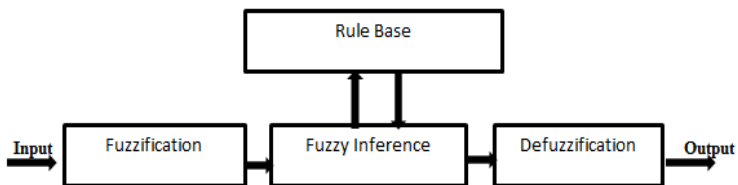

Figure 2. Four-phased isolated intersection

Crisp values are converted to fuzzy sets in fuzzification process. Inference engine is a system of transforming input variables into output variables. Rule base is formed under IF-THEN rules decided via fuzzy logic controller. Defuzzification is an operator of converting the fuzzy values to crisp values. Membership functions are used in the fuzzification and defuzzification process of fuzzy logic system, to map the crisp input values to fuzzy linguistic variables. Linguistic variables whose values are words used to express inputs and outputs. Structure of linguistic variables is centered on the utilization of information extensively put in practices of fuzzy logic.

2.2. Steps of FLCSIG

The study is conducted through the following steps:

- Real data is collected in the morning and evening peak hours (crowd hours-07:30am-08:30am and 17:30pm-18:30pm) through five days via video shooting at an isolated intersection.
- All vehicles have been converted to automobile equivalents unit to standardize the effect of vehicles on the intersection. The effect of each vehicle on the intersection is different. The size differences within the automobiles themselves can be ignored, but the area covered by a bus or motorcycle at the intersection is very different from the automobile. For this, each vehicle is considered to be an automobile. Minibus and services are taken equivalent as the 1.27 automobiles, van is taken equivalent as the 1.75 automobiles, bus is taken equivalent as the 2.25 automobiles and motorcycle is taken equivalent as the 0.33 automobiles [30].
- All data is statistically analyzed.
- A cycle is total sequences of signal marks and analyses are done using 227 cycles (18.160 seconds) for the morning hours and 160 cycles (14.400 seconds) for the evening hours.
- The attributes related to the data set and the statistical values of these attributes for morning times are shown on the Table 1.
- FLCSIG is evaluated using fuzzy inference system through MATLAB environment.
- ‘Number of vehicles waiting at red light’, ‘number of vehicles passing through at green light’, ‘evacuation times of these vehicles’ and ‘number of remaining vehicles in a line after green light’ is determined for each approach through analysis period.

Table 1. Data set attributes

	Morning Queue Length			Morning Remaining Vehicles			Morning Extension of Green Light Duration		
Number of Data Points	917			917			917		
Min Data Value	0.165			-3.98			-12.4		
Max Data Value	13.3			6.38			19.5		
Mean	6.9			0.414			0.869		
Std Dev.	2.57			1.66			4.49		
Expression	EXPO (6.9)			-4 + EXPO (6.9)			-13 + EXPO (6.9)		
Square Error	0.029852			0.029852			0.029852		
Membership Function	Low	Medium	High	Low	Medium	High	Low	Medium	High
	[0	[1.76	[6.90	[5.64	[0.414	[3.73	-	[0.869	[5.359
	2.17	5.62	10.7	-1.79	2.90	5.89	14.49	12.424	12.424
	4.33	9.47]	14.61	2.07]	5.39]	8.04]	-5	5.359	5
]]				4.49]	9.849]	19.49]	

Membership functions are determined using statistical analysis and expert opinion. Negative values for the number of remaining vehicles indicate that during that time more vehicles can pass the intersection, but there are no vehicles at the intersection. This shows that the length of lights at the intersection approaches are sometimes too long because they are not operated according to the traffic load at the intersection. Statistical analysis is suitable for exponential distribution (EXPO). The membership functions in the fuzzy logic are determined by taking into account the statistical analysis (combination of minimum data, maximum data, standard deviation and mean) results and

expert opinion. Membership function values are in seconds. Linguistic variables are defined according to the membership functions as low, medium and high.

2.3. Assumptions of FLCSIG

- Yellow light duration is incorporated into the green light duration (Yellow light duration equals to 2 seconds).
- Pedestrians and cyclists are not taken into account in proposed model. (Due to the excessive vehicle flow at the intersection and the fact that too many pedestrians' especially elderly people and children do not use the intersection despite of the peak hours is the reason why pedestrians not considered in the model).
- The number of trucks is neglected for being too little.
- Right turnings are ignored for each approach because of being very few.
- Number of vehicles in each approach is counted for data analysis when each cycle time is completed. A cycle time refers to required time for a signal to finish one cycle.
- Initial queue is considered zero while calculating the aggregate delay.

2.4. Structure of FLCSIG

As shown in Figure 3, structure of FLCSIG consists of eight inputs and eight outputs. Fuzzy input variables handled in the proposed controller are: 'queue length during red light for all approaches' (Aqueue, Bqueue, Cqueue, Dqueue) and 'remaining vehicles in line after green light for all approaches' (Aremain, Bremain, Cremain, Dremain) to response traffic flow and fuzzy output variables handled in the model are: 'phase selection for all approaches' (Agreen, Bgreen, Cgreen, Dgreen) as well 'extend of green light duration for all approaches' (Aextend, Bextend, Cextend, Dextend) to select and direct green phase.

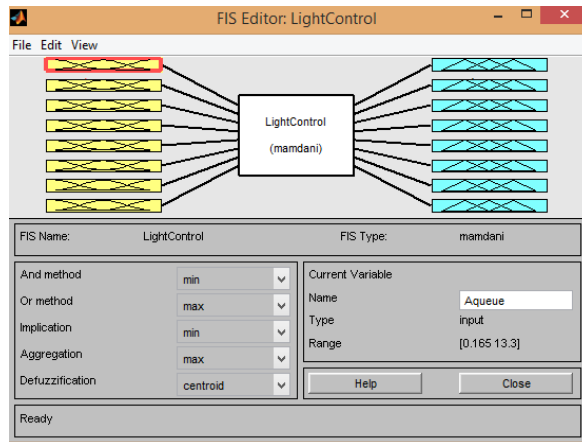

Figure 3. Structure of FLCSIG

Mamdani method [31], triangular membership function, center of gravity and bisector defuzzification methods are used in proposed controller as techniques. Mamdani method is adaptive technique that used to customize the membership function and it has widespread acceptance. Triangular membership function includes number of three linguistic variables. Center of gravity method is most commonly used technique as defuzzification method. The total area of the membership function distribution is divided into a number of sub-areas.

2.4.1. FLCSIG for Morning Peak Times

First of all, 917 test data (signal cycle piece) is used for analysis with all approaches covered by 227 cycles. Each test data refers to a phase that the signal cycle piece distributed to any integration of traffic activity with one or more periods in a cycle. That means; the observation made for each phase is a data. 917 phases are examined. The data is normalized taking into account the number of lanes in all approaches because of the different capacity of each approach. All data is divided into lane number of respective approach for example, data of approach A is divided into 4, data of approach B is divided into 2, data of approach C is divided into 3 and data of approach D is divided into 2 to normalize capacity of lanes for computing values of membership functions.

Normally, 243 rules can be defined in system in the form of 81x3 that refers to a combination of input and output variables. By reducing some of the ineffective rules among queue rules, numbers of 147 rules is formed in the FLCSIG for morning peak times. In this way, both system complexities are reduced and the proposed model performance is increased. System rules are created in the form of 49 X 3. When the system is simulated for 147 rules instead of 243 rules based on center of gravity method, 8.45% improvement in total delay and 8.19% improvement in total time are provided.

Some examples of fuzzy rules are shown as follows that are created to specify the system.

- If (Aqueue is medium) and (Bqueue is high) and (Cqueue is high) and (Dqueue is high) and (Dremain is low) then (Dgreen is green)(Dextend is low)
- If (Aqueue is low) and (Bqueue is medium) and (Cqueue is high) and (Dqueue is low) and (Cremain is low) then (Cgreen is green)(Cextend is low)

Membership functions of the eight input/output variables are shown in Figure 4 that Aqueue, Bqueue, Cqueue, Dqueue, Aremain, Bremain, Cremain, Dremain, Aextend, Bextend, Cextend and Dextend have three membership functions called as low, medium, and high. Agree, Bgreen, Cgreen and Dgreen have one membership function called as green. While demonstrating the selection of phase as output variable, time interval is determined between 5 and 30 seconds. Membership function values are calculated taking into account data distributions especially sample means and sample standard deviations besides expert opinions through MATLAB inference system. Membership functions of queue length for all approaches can be defined in Equations (1)-(3).

$$\text{Low_queue}(x) = \begin{cases} 0, & \text{if } x \leq 0 \text{ or } x \geq 4.34 \\ \frac{x-0}{2.17}, & \text{if } 0 < x < 2.17 \\ \frac{4.34-x}{2.17}, & \text{if } 2.17 \leq x < 4.34 \end{cases} \quad (1)$$

$$\text{Medium_queue}(x) = \begin{cases} 0, & \text{if } x \leq 1.76 \text{ or } x \geq 9.47 \\ \frac{x-1.76}{3.86}, & \text{if } 1.76 < x < 5.62 \\ \frac{9.47-x}{3.86}, & \text{if } 5.62 \leq x < 9.47 \end{cases} \quad (2)$$

$$\text{High_queue}(x) = \begin{cases} 0, & \text{if } x \leq 6.9 \text{ or } x \geq 14.61 \\ \frac{x-6.9}{3.85}, & \text{if } 6.9 < x < 10.7 \\ \frac{14.61-x}{3.85}, & \text{if } 10.7 \leq x < 14.61 \end{cases} \quad (3)$$

In the same way as calculating of queue membership functions, other inputs and outputs membership functions can be calculated. Membership function represents for the fuzzy logic the degree of truth.

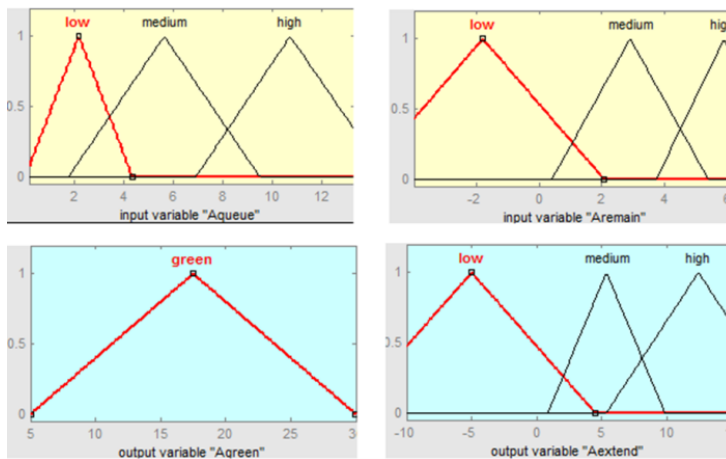

Figure 4. Structure of FLC SIG

After determining all membership functions, system is run for 46 continuous cycles including both center of gravity and bisector defuzzification methods.

2.4.1.1. Comparison to other traditional signal control methods

Arikan Ozturk [32] made analysis on more than one intersection to draw a conclusion that can be applied to all intersections. Inspired by this work, one intersection is considered with five-day analysis. Cycle times are determined with regression equation using 917 observation data. In order to determine cycle time model, multiple linear regression analysis has been performed, including evacuation time of measurement approach of intersection as dependent variable, the total number of vehicles converted to the automobile equivalent unit passing through the intersection approaches, and the hourly traffic load as independent variables. Following regression equation shows result of the study: Equation (4).

$$E=0.4863m-0.00025M+10.1413 \tag{4}$$

E=Evacuation time of measurement approach of intersection (second)

m= the number of vehicles converted to equivalent units automobiles during the evacuation time for each approach

M=Traffic load of intersection for per hour.

Regression coefficient R^2 is determined as 0.8475.

Webster’s delay formula is also used for comparing with proposed controller that is the most common model among fixed-time methods [33].

An existing mathematical model [34] is also used for indicating the performance of system against proposed fuzzy controller. It is solved by GAMS. A cycle time constraint is added to the model limited between 80 and 95 seconds. Model results are seen as locally optimal.

Among traditional models regression model has provided the best performance.

2.4.1.2. Results of Proposed Methods for Morning Peak Times

All comparisons are done using Equation (5);

$$\text{Total delay} = \text{Number of vehicles waiting at red light} * \text{Red light duration} \tag{5}$$

As seen in Figure 5, FLCSIG with center of gravity defuzzification method provides best performance with 14.24% improvement compared to observations in terms of aggregate delay. While FLCSIG with bisector method provides 8.97% improvement, regression equation provides 7.27% better performance than observations. Result of GAMS model achieves only 2.098% good performance compared to observations. It is seen that Webster model is not suitable for studied intersection. Poor results are obtained by this method with -12.37% rates. At the same time, it is seen that center of gravity method is the better than bisector method with 5.79% improvement.

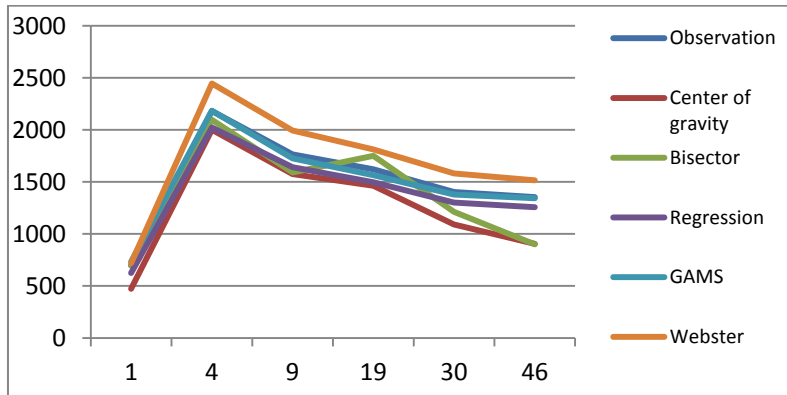

Figure 5. Comparison of different methods based on total delay for morning peak times

Figure 6 shows that cycle times of different methods.

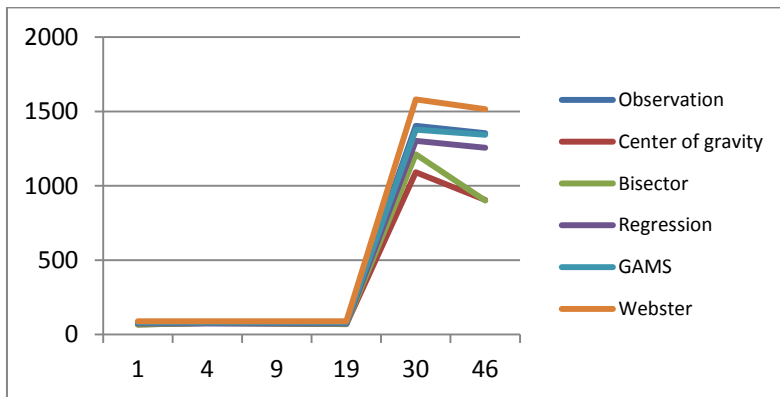

Figure 6. Comparison of different methods based on cycle time for morning peak times

When total of 46 cycles (3680 seconds) are considered, time is reduced 13.06% by FLCSIG with center of gravity method while reducing 10.88% with bisector method. While regression equation decreases cycle time in proportion as 7.22%, there is no change for GAMS mathematical model. As in the total delay, Webster model also provides poor performance with -11.85% rates. All studies are also done for the evening peak times.

3. COMPARISON OF FUZZY LOGIC CONTROLLER WITH ARTIFICIAL NEURAL NETWORKS (ANN) MODEL AND ADAPTIVE-NEURO FUZZY INFERENCE SYSTEM (ANFIS)

Fuzzy logic controller has been evaluated via traditional techniques that do not consider uncertainties. Therefore, neural network model (ANN) and adaptive neuro-fuzzy inference system (ANFIS) is also used for comparison with fuzzy logic controller because of considering uncertainties.

3.1. Artificial Neural Networks Model (ANN)

Artificial neural networks are computing systems that simulate the biological neuron networks process. These models bring solution to real world problems which interrelate between a set of given input patterns and set of known target output [35]. Structure of an ordinary neural network model is shown in Figure 7. The model is formed by using MATLAB neural network tool. The following steps have been implemented:

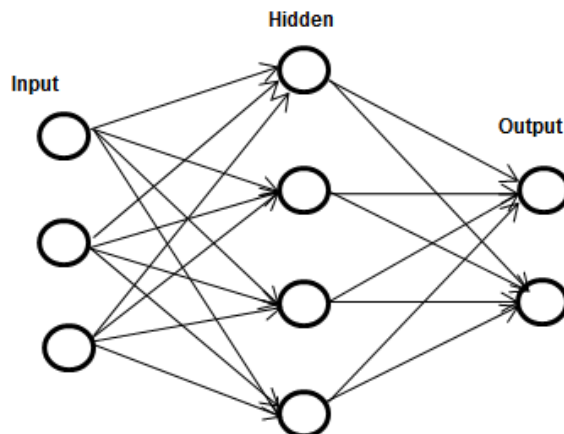

Figure 7. Structure of an ordinary neural network model

- While 227 samples (phases) are used for training set in the morning time, 160 training samples are used in the evening time.
- 46 test samples (cycles) are used for the morning time and 40 test samples are used for the evening time.
- Number of epochs (iteration of the training process) is chosen 100 and max-fail (used for validation) is estimated as 6.
- 2 layers and 8 neurons are used for this model. (There is no mathematical test for calculating how many neurons to find most effectively in the hidden layer, and the best decision must be made by trial and error method).
- Tansig (tangent hyperbolic activation) function is benefitted as transfer function because of negative values and feed-forward backprop is used as network type. The output values vary between -1 and 1 for the tansig function.
- Inputs and outputs are chosen as in the fuzzy logic controller.
- ANN is evaluated through MATLAB environment.

For the each approach, R values are found approximately 0.99 in regression analysis within neural network model. All regression results and best validation values can be seen in Table 2.

Table 2. ANN regression results and best validation values

		Morning Time				Evening Time			
		A	B	C	D	A	B	C	D
	Best Validation Performance / Epoch number	0.014/0	0.033/19	0.047/4	0.116/29	0.043/8	0.006/8	0.009/32	0.07/6
Regression	Training	0.999	0.999	0.998	0.999	0.999	0.999	0.999	0.99
	Validation	0.998	0.998	0.995	0.997	0.998	0.998	0.999	0.99
	Test	0.999	0.998	0.997	0.995	0.998	0.995	0.997	0.99

For example; for the intersection approach A in the morning time, best validation performance is provided in epoch zero. The regression values show that the model works well. Good results are provided by ANN rather than traditional techniques except traditional regression technique. But, it is not good as fuzzy logic controller. Results can be seen in Figure 9.

3.2. Adaptive neuro-fuzzy inference system (ANFIS)

Artificial Intelligence (AI) techniques that have the learning ability and decision making capability are effective to deal with traffic congestion at an intersection [36]. Adaptive neuro-fuzzy inference system is an artificial intelligence technique which is a combination of fuzzy inference systems and neural networks. It is a hybrid intelligent technique. The primary reason for a combining fuzzy system with a neural network is related providing the learning capability of neural network [37]. Structure of an ordinary ANFIS model is shown in Figure 8.

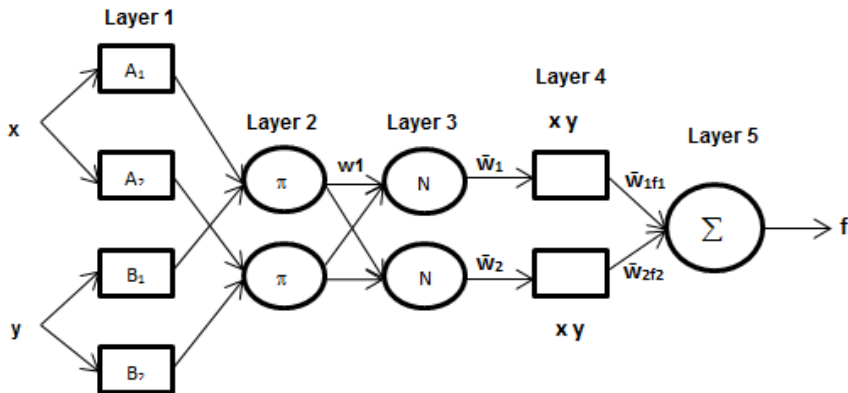

Figure 8. Structure of an ordinary ANFIS model

But it combines neural network and fuzzy logic approaches. Unlike the fuzzy inference system, it has also a normalization layer for training. The model is implemented using same rules in fuzzy inference system and using triangular membership function. It has provided good results according to ANN in terms of total delay. However, ANN achieves good performance in terms of

total cycle time. Despite the close results for all artificial techniques, the fuzzy inference system has provided best results among them. Results on the graphic for artificial intelligence techniques in the morning times can be seen in figure 9. It represents comparison of artificial neural network, adaptive neuro-fuzzy inference system and fuzzy logic controller in terms of delay. For a first-order Sugeno fuzzy model a typical rule set with two fuzzy if-then rules can be expressed as [38]:

Rule (1): If x is A1 and y is B1, then $f1 = m1 x + n1y + q1$,

Rule (2): If x is A2 and y is B2, then $f2 = m2 x + n2y + q2$.

Where: x, y are inputs, f is output, m1, n1, q1 and m2, n2, q2 are the output function parameters.

For all approaches, all the errors shown for training and test data in ANFIS can be seen in Table 3.

Table 3. ANFIS errors

	Error of Training Data	Average Testing Error
A approach for morning time	0.19688	0.19597
B approach for morning time	0.36118	0.36095
C approach for morning time	0.3044	0.303
D approach for morning time	0.8604	0.85854
A approach for evening time	0.13202	0.13141
B approach for evening time	0.2478	0.24654
C approach for evening time	0.27106	0.27059
D approach for evening time	0.22449	0.22363

Although the error values are small, the error obtained for the D approach in the morning time is relatively more than the other errors. This has caused a decrease in the performance of the model in terms of total delay and cycle time. The point of mean square error being very small (close to zero) means that the expected outputs and the ANN's outputs for the training set have become very close to each other.

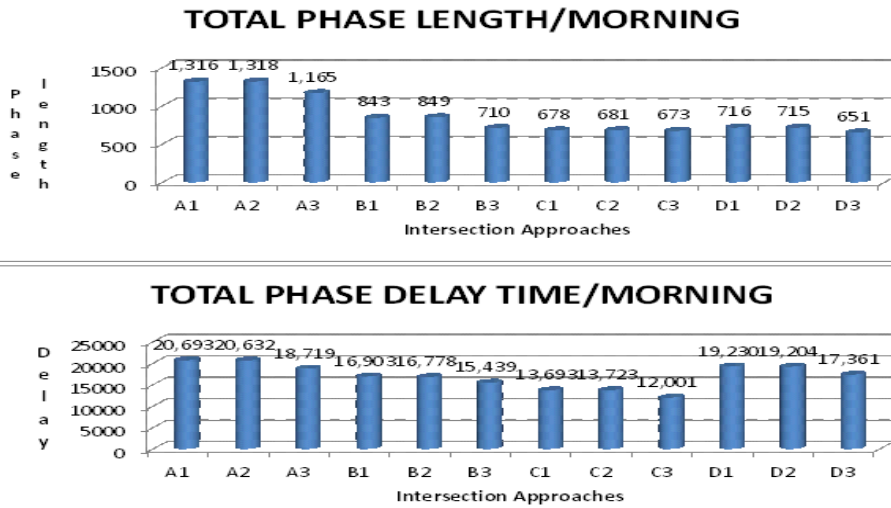

Figure 9. Comparison of artificial intelligence methods (ANFIS, ANN, Fuzzy logic)

A1, B1, C, D1: Respectively, Approaches for A, B, C, D for the artificial neural network application

A2, B2, C2, D2: Respectively, Approaches A, B, C, D for the adaptive neuro-fuzzy inference system

A3, B3, C3, D3: Respectively, Approaches A, B, C, D for the fuzzy logic centroid defuzzification method

Total phase length and total phase delay is given in seconds.

All techniques used in study are shown in table 4.

Table 4. All techniques used in study

(Second)	Observation	Center of gravity	Bisector	Regression	Webster	GAMS	ANN	ANFIS
Delay(morning)	74073.0	63520.4	67425.3	68687.3	83237.9	72518.44	70518.9	70336.8
Total time(morning)	3680.0	3199.2	3207.8	3413.2	4116.1	3680.04	3553.5	3563.3
Delay(evening)	83473.3	72760.8	73958.7	79719.3	91755.9	73254.02	76209.7	80198.9
Total time(evening)	3600.0	3176.9	3202.3	3437.3	4000.0	3600	3317.5	3471.04

As seen in the table, fuzzy inference system with different defuzzification methods is the best technique among other intelligent techniques for the proposed study. Fuzzy logic allows making exact decisions based on unclear or ambiguous data; it is also benefitted from expert opinions. ANN includes learning process and based on coming information. ANFIS is combination of these two techniques. Because of taking into account expert opinions inside fuzzy logic controller and composing of predefined rules, fuzzy inference system causes better performance. With 7 different techniques, traffic light length and delays in the intersection are discussed. Proposed fuzzy logic controller is more suitable than the other techniques at the intersection. A good analysis of the data and the creation of effective rules are important for this result.

4. CONCLUSION

In this paper, a fuzzy logic controller for a single intersection in Gaziantep (FLCSIG) based on modal distinction is proposed with two different models including morning and evening peak times based on center of gravity and bisector defuzzification methods.

FLCSIG is solved using fuzzy inference system through MATLAB environment and run for 46 continuous cycles (3680 seconds) for the morning model and 40 continuous cycles (3600 seconds) for the evening model. The proposed models are compared with various traditional methods to understand effects on traffic flow. The methods suggested in morning and evening peak times are provided different results. Webster model is not suitable for studied intersection. Poor results are obtained by this method. The regression model is shown good results compared with observations both morning and evening peak times. The best results are obtained by proposed fuzzy controller based on center of gravity methods. FLCSIG with bisector defuzzification method shows close performance to center of gravity method but not better.

Neural network model (ANN) and adaptive neuro-fuzzy inference system (ANFIS) is also used for comparison with fuzzy logic controller because of considering uncertainties. In some situations, some traditional methods may have a good performance but these methods do not consider unpredictable situations. Although artificial intelligence techniques yield good results, they are not as good fuzzy logic controller.

All of the models are worked on the test data. Fuzzy logic model validation accomplished with the ANFIS Editor using the testing data set. Checking data set is also used for model validation in ANFIS. Fuzzy inference system model is chosen to have parameters related with the minimum error of checking data model. In addition to using the ANFIS, different defuzzification methods can be used to test the fuzzy logic model. Center of gravity and bisector methods are used to test the model and good results are provided.

System would be implemented if low-cost microcontroller-based traffic signals put into practice. A microcontroller can respond to proposed model inputs with own functions. In a circuit diagram of microcontroller, traffic light can be controlled.

This intersection is considered suitable for study because it is in a crowded place and influences traffic at other intersections on the university boulevard. In addition, the roads to the main arteries of the city passing on this intersection are reason for selecting it. This real application model can be applied in similar intersections if the necessary data is collected. As future work, multi-intersection network case is planned. Condition of neighbor intersections should be considered for planning the network system. A new algorithm related pedestrian control logic can be developed in the future studies.

REFERENCES

- [1] Chiu S., Chand S., (1993a) Adaptive Traffic Signal Control Using Fuzzy Logic. Fuzzy Systems, *Second IEEE International Conference*, 1371-1376, San Francisco, CA.
- [2] Chiu S., Chand S.,(1993b) Self-Organizing Traffic Control via Fuzzy Logic. *32nd IEEE Conference on Decision and Control*, 1371-1376, San Antonio, TX.
- [3] Niittymäki J., Kosonen T.; Nevala R., (2001) Fuzzy Traffic Signal Control in Major Arterials, *IEEE Intelligent Transportation Systems Conference*, 346-351, Oakland (CA), USA.
- [4] Chou CH., Teng JC., (2002) Fuzzy Logic Controller for Traffic Junction Signals. *Information Sciences*. 143,73-97.
- [5] Li Y., Fan X.,(2003) Design of Signal Controllers for Urban Intersections Based on Fuzzy Logic and Weightings, *IEEE Intelligent Transportation Systems*. 1, 867-871.
- [6] Pappis, CP., Mamdani EH., (1977) A Fuzzy Logic Controller for a Traffic Junction. *IEEE Transactions on Systems, Man, and Cybernetics*. 7, 707-717.

- [7] Baez GB., Morales ER., Marrero EL.,(1997) A Fuzzy Logic Based Phase Controller for Traffic Control, *Sixth IEEE International Conference on Fuzzy Systems*, 1533–1539, Barcelona,
- [8] Trabia MB., Kaseko MS., Ande M., (1999) A Two-Stage Fuzzy Logic Controller for Traffic Signals, *Transportation Research Part C*, 7, 353–367.
- [9] Niittymaki J., Pursula M., (2000) Signal Control Using Fuzzy Logic, *Fuzzy Sets and Systems*, 116, 11–22.
- [10] Niittymaki J.,(2001) General Fuzzy Rule Base for Isolated Traffic Signal Control-Rule Formulation, *Transportation Planning and Technol*, 24,227–247.
- [11] Murat YS., Gedizlioglu E., (2005) A Fuzzy Logic Multi-Phased Signal Control Model for Isolated Junctions, *Transportation Research Part C*, 13,19–36.
- [12] Yang Z., Xiyue H., Du C., Tang M., Yang F., (2008) Hierarchical Fuzzy Logic Traffic Control for Urban Signalized Intersections, *7th World Congress on Intelligent Control and Automation*, 5203–5207, Chongqing, China.
- [13] Junqiang L., Yuqin F.,(2009) Research on the Fuzzy Control and Simulation for Intersection Based on the Phase Sequence Optimization, *International Conference on Measuring Technology and Mechatronics Automation*, 578–581.
- [14] Gong YJ., Zhang J., Liu O., Liu Y., (2011) A Novel Fuzzy Model for the Traffic Signal Control of Modern Roundabouts, *Systems, Man and Cybernetics (SMC), IEEE International Conference on Anchorage*, 1777–1782, AK.
- [15] Zhu M., (2012) Fuzzy Logic Signal Controller Based on Competition for Isolated Intersection, *4th International Conference on Intelligent Human-Machine Systems and Cybernetics*, 116–118, Nanchang, Jiangxi.
- [16] Zaied ANH., Othman WA., (2011) Development of a Fuzzy Logic Traffic System for Isolated Signalized Intersections in the State of Kuwait, *Expert Systems with Applications*. 38,9434–9441.
- [17] Teo KTK., Yeo KB., Tan SE., Siew ZW., Lim KG., (2013) Design and Development of Portable Fuzzy Logic Based Traffic Optimizer, *IEEE ICCE-China Workshop*, 7–12, Shenzhen, China.
- [18] Alam J., Pandey MK., (2014) Development of Intelligent Traffic Light System Based on Congestion Estimation Using Fuzzy Logic, *IOSR Journal of Computer Engineering (IOSR-JCE)*, 16, 36–44.
- [19] Homaei H., Hejazi SR., Dehghan AAM., (2015) A New Traffic Light Controller Using Fuzzy Logic for a Full Single Junction Involving Emergency Vehicle Preemption, *Journal of Uncertain Systems*, 9, 49–61.
- [20] Nadia Postorino M., Versaci M., (2015) Upgrading Urban Traffic Flow by a Demand-Responsive Fuzzy-Based Traffic Lights Model, *International Journal of Modelling and Simulation*, 2, 102-109.
- [21] Rao DRJB., Zakaria A., (2016) Improved Traffic Light Controller Based on Fuzzy Inference System, *Proceedings of International Conference on Advanced Processes and Systems in Manufacturing*, 55-56, Putrajaya, Malaysia.
- [22] Shirvani MJ., Maleki, HR., (2017) Maximum Green Times Settings for Traffic Actuated Signal Control at Isolated Intersections Using Fuzzy Logic, *Int.J. Fuzzy Syst.*, 19, 247-256.
- [23] Nakatsuji T., Kaku T., (2016) Development of a Self-Organizing Traffic Control System Using Neural Network Models, *Transportation Research Record*, 1324, 137-145.
- [24] Araghi S., Khosravi A., Johnstone M., Creighton D., (2013) Intelligent Traffic Light Control of Isolated Intersections Using Machine Learning Methods, *IEEE International Conference on Systems, Man, and Cybernetics*, 3621-3626.

- [25] Araghi S., Khosravi A., Creighton D., (2014) ANFIS Traffic Signal Controller for an Isolated Intersection, *Proceedings of the International Conference on Fuzzy Computation Theory and Applications*, 175-180, Portugal.
- [26] Lai GR., Che Soh A, Sarkan HMD., Abdul Rahman RZ., Hassan MK., (2015) Controlling Traffic Flow in Multilane-Isolated Intersection Using ANFIS Approach Techniques, *Journal of Engineering Science and Technology*, 10, 1009-1034.
- [27] Udofia KM., Emagbetere JO., Edeko FO.,(2014) Dynamic Traffic Signal Phase Sequencing for an Isolated Intersection Using ANFIS, *Automation, Control and Intelligent Systems*, 2, 21-26.
- [28] Seesara S., Gadit J., (2015) Smart Traffic Control Using Adaptive Neuro-Fuzzy Inference System(ANFIS), *International Journal of Advance Engineering and Research Development*, 295-302.
- [29] Zadeh LA., (1965) Fuzzy sets. *Information and Control*, 8, 338–353
- [30] Turkish Standards Institute., (1989) Automobile Equivalence in Urban Areas (Turkish Standards TS6407), Ankara (in Turkish).
- [31] Mamdani, E., H., (1974) Application of fuzzy algorithms for control of simple dynamic plant, *Proceedings of the Institution of Electrical Engineers Control & Science*, 121, 1585–1588.
- [32] Arıkan Öztürk E., (2004) Modeling of cycle time for signalized intersections in urban areas: Ankara case study. Ph.D Thesis. *Gazi University, Institute of Science and Technology*.
- [33] Webster FV.,(1958) Traffic Signal Settings. *Road Research Technical Paper*, No 39, London, UK: Road Research Laboratory, Her Majesty Stationary Office.
- [34] Mulbay Z., Cay E., Binici M., Macit O., Doruk H., (2001) Trafik Sinyalizasyon Sürelerinin Değiştirilmesi ile Trafik Akışının İyileştirilmesi: Isparta örneği. *18. Endüstri Mühendisleri Öğrenci Sempozyumu*.
- [35] Rafiq MY., Bugmann G., Easterbrook DJ., (2001) Neural Network Design for Engineering Applications, *Computers and Structures*, 1541-1552.
- [36] Araghi S.,Khosravi A., Creighton D., (2015) Design of an Optimal ANFIS Traffic Signal Controller by using Cuckoo Search for an Isolated Intersection, *IEEE International Conference on Systems, Man, and Cybernetics*.
- [37] Mashrei MA., (2012) Neural Network and Adaptive Neuro-Fuzzy Inference System Applied to Civil Engineering Problems, *Fuzzy Inference System - Theory and Applications*.
- [38] Jang S., (1993) Adaptive Network-Based Fuzzy Inference System. *IEEE Journal*, 23, 665-685.