







Determination of precipitation-quality relationship by different statistical methods in bread wheat (*Triticum aestivum* L.)

Murat OLGUN¹, Savaş BELEN², Yaşar KARADUMAN³, Metin TURAN⁴,
Zekiye BUDAK BAŞÇİFTÇİ¹, Nazife Gözde AYTER ARPACIOĞLU^{1*}

¹Field Crop Department, Agricultural Faculty, Eskişehir Osmangazi University, Eskişehir, Turkey

²Transitional Zone Agricultural Research Institute, Eskişehir, Turkey

³Department of Food Engineering, Faculty of Agriculture, Eskişehir Osmangazi University, Eskişehir, Turkey

⁴Department of Genetics and Bioengineering, Yeditepe University, Istanbul, Turkey

*Corresponding Author Email: gayter@ogu.edu.tr

Abstract

In this study, monthly precipitations between 2007-2018 in Eskişehir, Konya, Afyonkarahisar, Uşak and Kütahya provinces were examined and their effects on protein content, zeleny sedimentation (MSDS), thousand seed weight and test weight, constituting of the quality components in wheat, were revealed. Monthly precipitations affecting these quality components were determined by using correlation analysis, principle component analysis (PCA), stepwise regression analysis, path analysis and decision tree analysis. In the research; the effects of precipitations falling in September, October, November, March, April, May and June and total precipitation on the quality components (protein content, zeleny sedimentation (MSDS), thousand seed weight and test weight) in Eskişehir, Konya, Afyonkarahisar, Uşak and Kütahya were determined. It is also aimed to determine effective monthly precipitations on the quality components by determining different analysis programs. As a result; March precipitation, April precipitation, June precipitation, October precipitation and total precipitation were determined as significant precipitations affecting the quality components (protein content, macro sedimentation (MSDS), thousand seed weight and test weight) in bread wheat. Increasing June precipitation, October precipitation and total precipitation affect the quality of bread wheat increase seed weight and test weight, while it causes a relative decrease in protein content and MSDS. Uşak and Kütahya provinces were found to be superior regions for thousand seed weight and test weight, whereas, Eskişehir and Konya provinces were determined as better provinces for zeleny sedimentation (MSDS) and protein content.

Keywords: Bread wheat, quality, rainfall, monthly rainfall, protein content, zeleny sedimentation (MSDS), thousand seed weight and test weight, statistical methods

Introduction

Wheat is known as one of the most cultivated crop with the largest acreage and production in the world. The highest production is done in Asia, Europe and America, and wheat cultivation is mostly done in the northern hemisphere (Feldman, 2001; Shewry; 2009). On the other hand, due to its wide adaptability, wheat could be grown anywhere in the world without any problems except the poles. Moreover, wheat, as an important crop for nutrition industry and trade of

countries in the world, has been occupying an important place in the nutrition of the future (Slafer et. al, 1996; Shewry; 2009). Since there is no possibility to add any hectare to the existing cultivation areas in the world, to meet the need of food the increasing population in the future; only one possibility is to increase the yield obtained from the unit area. This is only possible with the application of optimum cultivation techniques and the use of high yielding and quality genotypes.

Cite this article as:

Olgun, M., Belen, S., Karaduman, Y., Turan, M., Budak-Basciftci, Z., Ayter-Arpacioglu, N.G. (2021). Determination of precipitation-quality relationship by different statistical methods in bread wheat (*Triticum aestivum* L.). Int. J. Agric. For. Life Sci., 5(2): 171-183.

ORCID and Mail:

Olgun, M.: 0000-0001-6981-4545 (molgun@ogu.edu.tr); Belen, S.: 0000-0001-7357-8127 (savas.belen@tarim.gov.tr); Karaduman, Y.: 0000-0003-1306-3572 (yasar.karaduman@ogu.edu.tr); Turan, M.: 0000-0002-4849-7680 (metin.turan@yeditepe.edu.tr); Budak-Basciftci, Z.: 0000-0002-4034-2537 (zbudak@ogu.edu.tr); Ayter-Arpacioglu, N.G.: 0000-0002-5121-4303 (gayter@ogu.edu.tr).

Received: 08.11.2021 Accepted: 22.12.2021 Published: 25.12.2021

Year: 2021 Volume: 5 Issue: 2 (December)

Available online at: <http://dergipark.gov.tr/ijafols>

Copyright © 2021 International Journal of Agriculture Forestry and Life Sciences (Int. J. Agric. For. Life Sci.)

This is an open access article distributed under the terms of the Creative Commons Attribution 4.0 International (CC-by 4.0) License



Registered genotype refers to a genotype that is high yielding and quality, resistant to biotic and abiotic stresses and stable in terms of these characteristics (Calderini et al. 1997; Tiwari, and Lal, 2014; Fasahat et al., 2015; Jaruchai et al., 2018). Wheat meets a very important part of the daily calorie required in human nutrition and constitutes the main food of the country as many carbohydrates and proteins in the world. High adaptability, easy storability, long-term preservation of quality, easy cultivation and high yield and quality are the indicators of why wheat is used more in the world (Peterson et al., 1992; Curic et al. 2001). Yield and quality in wheat are under the threat of biotic and abiotic stresses as well as genetic potential. Therefore, yield and quality are shaped under the influence of genotype x environment interaction. The external biotic and abiotic stresses, that wheat is exposed to during the growing period, affect the quality as well as the yield. It has been revealed by many researchers that the quality of wheat is affected by at least 50 percent of external factors such as biotic and abiotic stresses (Wang et al., 2004; Wang et al. 2014; Baraki et al., 2014; Spaldon et al., 2017). In wheat breeding, the quality concept consists of protein content, zeleny sedimentation (MSDS), thousand seed weight and test weight, and genotypes with high values for these components are accepted as quality varieties (Tipples et al. 1981; Leibinger and Reiners 2001). Since the concept of quality is affected by environmental conditions as well as genotypic effect, it is greatly affected by the prevailing precipitation. (Burnett and Clarke 2002), excess/insufficient rainfall during the growing period significantly determines the amount of protein content, zeleny sedimentation (MSDS), thousand seed weight and test weight in wheat. In the researches, it was determined that with increasing rainfall, test weight and thousand seed weight increase while relative decrease occur in protein content and

MSDS (Zwingelberg, 1961; Panozzo and Eagles 2000). This shows that the amount of precipitation significantly affects wheat quality. In addition to this, monthly precipitations in certain months are effective during the season in wheat, they determine the quality level to be obtained for protein content, zeleny sedimentation (MSDS), thousand seed weight and test weight. In this study, monthly precipitations between 2007-2018 in Eskişehir, Konya, Afyonkarahisar, Uşak and Kütahya provinces were examined and their effects on protein content, zeleny sedimentation (MSDS), thousand seed weight and test weight were revealed by using correlation analysis, principle component analysis (PCA), stepwise regression analysis, path analysis and decision tree analysis.

Materials and Methods

In this study, the effects of precipitations in September, October, November, March, April, May and June, (these months are known as plant growing period) and total precipitations between 2007-2018 in Eskişehir, Konya, Afyonkarahisar, Uşak and Kütahya provinces on quality components (protein content, zeleny sedimentation (MSDS), thousand seed weight and test weight) were determined, and the effective monthly precipitations were revealed by different analysis programs. Monthly and total precipitations of provinces were taken from Eskişehir 3rd Regional Directorate of Meteorology (2007-2018). Data for quality components (protein content, zeleny sedimentation (MSDS), thousand seed weight and test weight) that were the average values, obtained from the Regional Yield Trials, carried out in five provinces between 2007-2018. The monthly and annual precipitation values of the examined locations and the maximum, minimum and average values of the quality components are given in Table 1.

Table 1. Monthly and annual precipitation values of the examined locations and maximum, minimum and average values of quality components.

Variable	Mean	Minimum	Maximum	Variable	Mean	Minimum	Maximum
March	41,37±18,97	9,41	91,26	November	37,04±21,25	0,10	125,00
April	42,33±23,25	6,13	104,98	Total Ra.	471,42±95,43	225,9	885,3
May	52,32±27,39	5,76	124,21	Test We.	77,04±1,86	70,64	82,11
June	45,83±38,45	1,94	170,56	Zel.Sed. (MSDS)	39,11±8,11	18,34	51,75
September	25,79±32,38	0,21	134,57	Thou. Seed We.	34,71±2,62	21,42	41,57
October	46,23±27,79	0,45	105,93	Protein	12,44±0,97	7,93	17,01

Total annual precipitation average in the region was determined as 471,42±95,43 mm. The precipitations of March, April, May, June, September, October and November are respectively; 41,37±18,97, 42,33±23,25, 52,32±27,39, 45,83±38,45, 25,79±32,38, 46,23±27,79 and 37,04±21,25, respectively. Again, average test weight, zeleny sedimentation (MSDS), thousand seed weight and protein content values was determined as; 77,04±1,86, 39,11±8,11, 34,71±2,62 and 12,44±0,97, respectively.

Results and Discussion

Quality is a phenomenon that has been increasing its importance in wheat production in recent years; the need for high quality genotypes and their use is increasing. So, it is no longer important how much wheat is produced, but also how much high quality wheat seeds are produced. By addressing

the issue in this way, the society's need for quality products is also answered. Therefore, a product rich in protein is obtained and presented to the society. Since, the quality criterion is highly influenced by the environment, genotypes having different quality levels could be obtained from year to year, from region to region, so quality has to be considered as a variable concept. While saying this, it is impossible to say that the quality is affected by the environment and the quality characteristics of the varieties should not be taken into account. Although it is affected by the environment and the quality varies between certain values, the use of high quality varieties is important in terms of increasing the quality (Guarda et al., 2004); therefore, quality has to be considered as a variable concept. While saying this, it is impossible to say that the quality is affected by the environment and the quality characteristics of the genotypes should not be taken into

account. Therefore, while developing high-yielding and high-quality varieties, it should be taken into account that they are less affected by biotic and abiotic stresses as much as possible. In this context, it is important to determine the effects of environmental effects on quality and to consider them while developing high yielding and quality genotypes accordingly to increase breeding success (Burnett and Clarke 2002). In this study, by taking into account the distribution of precipitation, which is one of the important climatic factors, in five different

locations, the effect of precipitation on quality was revealed by different statistical methods.

Correlation analysis is important in terms of revealing the result and direction of the relationship between the examined components. Therefore, it is the coefficient showing the positive or negative strength of the relationship between the two components examined in this analysis (Armitage et al., 2002).

Table 2. The correlation between the monthly and annual precipitation values of the locations and the quality components (protein content, MSDS, test weight, thousand seed weight).

	March	April	May	June	September	October
April	-0,025ns					
May	0,040ns	0,166ns				
June	0,061ns	0,015ns	0,403**			
September	0,102ns	-0,009ns	-0,025ns	0,070ns		
October	-0,190ns	0,279*	0,127ns	0,325**	0,072ns	
November	0,178ns	-0,112ns	-0,191ns	-0,294*	-0,019ns	-0,343**
Total Ra.	0,307*	0,457**	0,466**	0,445**	0,176ns	0,368**
Test We.	-0,254*	0,266*	0,003ns	-0,06ns	0,012ns	-0,256*
MSDS	-0,035ns	-0,141ns	-0,136ns	-0,087ns	-0,013ns	-0,027ns
Thou. Seed Ve.	-0,061ns	0,153ns	0,053ns	-0,059ns	-0,025ns	-0,271*
Protein Con.	-0,140ns	-0,341**	-0,262*	-0,106ns	-0,013ns	-0,039ns
	November	Total Ra.	Test We.	MSDS	Thou. Seed Ve.	
Total Ra.	0,098ns					
Test We.	-0,258*	-0,033ns				
MSDS	0,126ns	-0,306*	-0,326**			
Thou. Seed Ve.	-0,055ns	-0,002ns	0,674**	-0,300*		
Protein Con.	0,298*	-0,351**	-0,447**	0,649**	-0,385**	

Correlation coefficient takes a value between -1 and +1; the positive coefficient indicates the positive relationship between the two relationships, and the negative coefficient indicates the inverse relationship between the two relationships (Sing and Chaudhary 1977; Sheskin, 2011). The correlation relationship between the climatic factors and protein content, MSDS, test weight and thousand seed weight examined in our study is given in Table 2. Here, the months of September, October, November, March, April, May, June and the annual total precipitation are taken into account. Considering the table, a positive and significant relationship was determined between the protein content and the month of November and June. Again, a negative relationship was determined between protein and precipitation in April, precipitation in May and total precipitation. While determining the positive and significant relationship between protein content and MSDS; a negative and significant relationship was determined between protein content and test weight and thousand seed weight. While determining the negative and significant relationship between MSDS and total precipitation, thousand seed weight and test weight; a positive and significant relationship was determined between MSDS and protein content. While a negative and significant relationship was determined between thousand seed weight and October precipitation, MSDS and protein content; a positive and significant relationship was found between thousand seed weight and test weight. While a negative and significant relationship was determined between test weight and March precipitation, October precipitation, November precipitation, MSDS and protein content; a positive and significant relationship was determined between test weight and April precipitation.

Here, the relationship between protein, MSDS and test weight, thousand seed weight was reversed. This means that, depending on the increasing amount of precipitation, there is a decrease in the protein content and MSDS ratio, while an increase in thousand seed weight and test weight occurs. This means that with increasing precipitation, there is an increase in plant growth and, accordingly, in dry matter production and carbohydrate production, and this increase rate is higher than protein accumulation and related MSDS accumulation. Therefore, the accumulation of protein and MSDS gives the appearance of decreasing relative to the increasing precipitation, that is, it does not increase, but decreases depending on the precipitation. This situation clearly shows the increasing or decreasing relationship between precipitation and quality components. As a matter of fact, it has been determined in studies that nitrogen does not increase that much in wheat compared to increased carbohydrate accumulation and it decreases relatively (Plenet and Lemaire, 2000). Depending on the increase in yield and carbohydrate accumulation due to falling precipitation, although thousand seed and test weights increase, protein and MSDS increase. As a result of the correlation analysis, it was determined that the precipitation in October, April, May and the total precipitation had a negative effect on the protein content and MSDS, while it caused a significant increase in terms of thousand seed weight and test weight. Therefore, the precipitations in October, April, May and the total precipitation were determined as the precipitations that had a significant impact on the quality.

Principle Component (PCA) analysis is an effective form of analysis in defining, classifying and evaluating data, and it is

a method that reduces the large number of data sets and enables to reveal the active elements without losing their properties. The basic logic of PCA analysis is to evaluate the multidimensional data set in terms of basic features and to express it by transforming it into fewer factors (Armitage et al., 2002; Caussin et al., 2003; Poudel et al. 2017). In our study, the PCA analysis showing the interaction between monthly and annual precipitation and quality components and the biplot graph accordingly are given in Table 3. As could be seen in Table 3, the explicability of the interaction between monthly precipitation values and quality components was revealed at the PC5 level. As a result of the analysis, protein content, MSDS, test weight and thousand seed weight were determined as important factors such as March precipitation, April precipitation, June precipitation, September precipitation, October precipitation, and November precipitation. In addition, when the biplot graph is examined, it is possible to reach the following results. There is a positive relationship between the total precipitation in April, May, June and the thousand and test weight, that is, the increase in the total precipitation in these months creates an increase in both quality components. Uşak and Kütahya provinces give better results in terms of thousand seed and test weight. In addition, protein content and MSDS decrease with increasing precipitation. The provinces of Eskişehir and Konya, which receive less precipitation, are the provinces with better results in terms of higher protein and MSDS. In addition, the rains falling in November allow better protein and MSDS values to be obtained. As a result of PCA and biplot analysis, April, May, June and annual total precipitation lead to better thousand seed and test weights, and the decrease in precipitation in these months causes protein and MSDS to decrease. While Uşak and Kütahya provinces are superior regions

in terms of thousand seed weight and test weight, Eskişehir and Konya provinces are provinces with better MSDS and protein contents. In addition, March precipitation, April precipitation, June precipitation, September precipitation, October precipitation, and November precipitation were determined as important factors on protein content, MSDS, test weight and thousand seed weight. While the strength of the relationship between the two components is correlation, the shape of the relationship is expressed as regression. Therefore, the relationship between the two components can be positive or negative, linear, polynomial, logarithmic; Regression analysis is a successful method that explains the relationship between the components examined. While applying the regression analysis, the process of choosing the most appropriate variables among the independent variables that are effective on the determined dependent variable is called stepwise regression.

In other words, in this analysis, the most suitable components among all independent variables are selected, and this method is called stepwise regression analysis, since this selection is made step by step (Tibshirani, 1996; Buhlmann and Yu, 2003; Efron et al., 2004; Chen et al., 2011). In this analysis, unnecessary elements are removed from the model, the removed elements are added to the model again, and this time both processes are applied together and the result is reached. This uncomplicated and simple system is used as an effective form of analysis for regression analysis. The stepwise regression analysis showing the effect of monthly and total precipitation on the protein content, one of the quality component, is given in Table 4, considering the protein content, one of the quality components examined in the study, as the dependent variable.

Table 3. PCA analysis and biplot plot showing the interaction between monthly and annual precipitation and quality factors.

	PC ₁	PC ₂	PC ₃	PC ₄	PC ₅		PC ₁	PC ₂	PC ₃	PC ₄	PC ₅
Eigenvalue	2,940		2,211		1,523		1,078		1,021		
Proportion	0,245		0,184		0,127		0,09		0,085		
Cumulative	0,245		0,429		0,556		0,646		0,731		
Variable	PC1	PC2	PC3	PC4	PC5	Variable	PC1	PC2	PC3	PC4	PC5
March	0,025	-0,155	-0,616	0,165	-0,059	November	-0,237	0,028	-0,539	-0,272	0,184
April	0,323	-0,049	0,022	-0,665	0,164	Total Ra.	0,368	-0,359	-0,303	-0,187	0,05
May	0,297	-0,247	-0,021	0,337	0,302	Test We.	0,306	0,466	0,138	-0,023	-0,094
June	0,239	-0,368	0,122	0,439	-0,024	MSDS	-0,381	-0,15	0,146	-0,079	0,044
September	0,051	-0,107	-0,133	-0,07	-0,907	Thou.Seed We.	0,267	0,448	-0,063	0,076	-0,004
October	0,158	-0,415	0,384	-0,31	-0,082	Protein Con.	-0,469	-0,152	0,116	-0,043	0,01

Table 4. Stepwise regression analysis showing the effect of monthly and total precipitation on the protein content of the quality components by considering the protein content as the dependent variable in the quality components examined.

Model		Sum of Squares	df	Mean Square	F	Significance
1	Regression	20,722	1	20,722	8,881	0,004 ^b
	Residual	147,008	63	2,333		
	Total	167,731	64			
2	Regression	39,438	2	19,719	9,530	0,000 ^c
	Residual	128,293	62	2,069		
	Total	167,731	64			
3	Regression	50,516	3	16,839	8,763	0,000 ^d
	Residual	117,215	61	1,922		
	Total	167,731	64			

a: Dependent component, Protein content, b. Predictors: (Constant), Total rainfall, c. Predictors: (Constant), Total rainfall, April rainfall, d. Predictors: (Constant), Total rainfall, April rainfall, October rainfall

Model		Unstandardized Coef.		Standardized Coef.		Significance
		B	Standard Er.	Beta	t	
1 R ² : 0,351	(Constant)	14,120	0,691		20,445	0,000
	Total rainfall	-0,004	0,001	-0,351	-2,980	0,004
2 R ² : 0,485	(Constant)	13,567	0,676		20,074	0,000
	Total rain.	-0,005	0,001	-0,384	-3,443	0,001
	April rain.	0,020	0,007	0,336	3,007	0,004
3 R ² : 0,549	(Constant)	13,190	0,670		19,685	0,000
	Total rainfall	-0,006	0,001	-0,507	-4,258	0,000
	April rain.	0,027	0,007	0,451	3,830	0,000
	October rain.	0,018	0,007	0,303	2,401	0,019

a. Dependent component: Protein

As can be seen from the table, when the parameters affect the quality are considered step by step; especially the three effective parameters, total precipitation, April rain and October precipitations are effective on protein content, and their effects are so negative and significant.

While the total precipitation on protein content was approximately 35%, the effects of April and October

precipitations were approximately 13% and 16%. Therefore, the effect of all three components on protein was determined as 54,9% in total. The stepwise regression analysis showing the effect of monthly and total precipitation on the MSDS, which is one of the quality components, is given in Table 5.

Table 5. Stepwise regression analysis showing the effect of monthly and total precipitation on the MSDS, one of the quality components, by considering the MSDS as the dependent variable.

Model		Sum of Squares	df	Mean Square	F	Significance
1	Regression	419,812	1	419,812	6,492	,013 ^b
	Residual	4073,950	63	64,666		
	Total	4493,762	64			

a: Dependent component, MSDS., b. Predictors: (Constant), Total rainfall,

Model		Unstandardized Coef.		Standardized Coef.		Significance
		B	Standard Er.	Beta	t	
1 R ² :0,306	(Constant)	44,706	3,636		12,296	0,000
	Total rainfall	-0,019	0,007	-0,306	-2,548	0,013

a. Dependent component: MSDS

As seen from the table, the total precipitation has a significant negative effect on the MSDS and the degree of this effect is 30,6%. The stepwise regression analysis showing the

effect of monthly and total precipitation on thousand seed weight, one of the quality components, is given in Table 6.

Table 6. Stepwise regression analysis showing the effect of monthly and total precipitation on thousand seed weight, one of the quality components, by considering the thousand seed weight as the dependent variable.

Model		Sum of Squares	df	Mean Square	F	Significance
1	Regression	44,521	1	44,521	4,997	0,029 ^b
	Residual	561,293	63	8,909		
	Total	605,814	64			
2	Regression	78,953	2	39,476	4,646	0,013 ^c
	Residual	526,861	62	8,498		
	Total	605,814	64			

a: Dependent component, Thousand seed weight., **b.** Predictors: (Constant), October rainfall, **c.** Predictors: (Constant), October rainfall, April rainfall

		Unstandardized Coef.		Standardized Coef.		t	Significance
		B	Standard Er.	Beta			
1 R ² : 0,271	(Constant)	36,450	0,722			50,456	0,000
	October rain.	-0,030	0,013		0,271	2,235	0,029
2 R ² : 0,361	(Constant)	35,414	0,873			40,548	0,000
	October rain.	-0,038	0,014		0,340	2,760	0,008
	April rain.	0,033	0,016		0,248	2,013	0,048

a. Dependent component: Thousand seed weight

In the analysis, the October precipitation and the April precipitation positively contributed to the thousand seed weight. Monthly precipitations caused an increase in thousand seed weight in contrast to protein and MSDS. While the effect degree of October on the thousand seed weight was determined as approximately 27%, the effect degree of the precipitation in April was determined as approximately 9%. The total effect of both months was determined as 36,1.

Therefore, it has been determined that the precipitations that are effective on the thousand seed weight are the precipitations of October and April. The stepwise regression analysis showing the effect of monthly and total precipitation on test weight, one of the quality components, by considering test

weight as a dependent variable, is given in Table 7. As can be seen from the table, monthly precipitations that have a significant effect on the test weight are revealed as precipitation in April, precipitation in October, precipitation in November and precipitation in March. The precipitation falling in these months has a positive effect on the test weight. With increasing precipitation, the test weight also increases. The highest contribution to the increase in test weight was determined as April with approximately 26%, October precipitation with approximately 15%, November precipitation with approximately 12%, and March precipitation with approximately 6%.

Table 6. Stepwise regression analysis showing the effect of monthly and total precipitation on test weight, one of the quality components, by considering test weight as a dependent variable.

Model		Sum of Squares	df	Mean Square	F	Significance
1	Regression	20,605	1	20,605	4,807	0,032 ^b
	Residual	270,069	63	4,287		
	Total	290,674	64			
2	Regression	49,429	2	24,714	6,352	0,003 ^c
	Residual	241,245	62	3,891		
	Total	290,674	64			
3	Regression	85,428	3	28,476	8,463	0,000 ^d
	Residual	205,245	61	3,365		
	Total	290,674	64			
4	Regression	106,829	4	26,707	8,716	0,000 ^e
	Residual	183,845	60	3,064		
	Total	290,674	64			

a: Dependent component, Test weight, **b.** Predictors: (Constant), April rainfall, **c.** Predictors: (Constant), April rainfall, October rainfall, **d.** Predictors: (Constant), April rainfall, October rainfall, November rainfall, **e.** Predictors: (Constant), April rainfall, October rainfall, November rainfall, March rainfall

		Unstandardized Coef.		Standardized Coef.		t	Significance
		B	Standard Er.	Beta			
1 R ² : 0,266	(Constant)	77,963	0,537			145,254	0,000
	April rain.	0,024	0,011	0,266		2,192	0,032
2 R ² : 0,412	(Constant)	78,770	0,591			133,282	0,000
	April rain.	0,033	0,011	0,358		2,970	0,004
	October rain.	-0,025	0,009	0,328		2,722	0,008
3 R ² : 0,542	(Constant)	80,327	0,727			110,461	0,000
	April rain.	0,032	0,010	0,351		3,134	0,003
	October rain.	-0,035	0,009	0,454		3,834	0,000
	November rain.	-0,029	0,009	0,375		3,271	0,002
4 R ² : 0,606	(Constant)	81,641	0,854			95,652	0,000
	Total rainfall	0,033	0,010	0,360		3,367	0,001
	April rain.	-0,038	0,009	0,498		4,353	0,000
	November rain.	-0,026	0,009	0,339		3,076	0,003
	March rain.	-0,031	0,012	0,279		2,643	0,010

a. Dependent component: Test weight

Therefore, the main actors of the high test weight are the precipitation in April and October. The effect degree of the test weight of the precipitation received in all four months was determined as 60.6%. As a result of the stepwise analysis, the precipitation in April, the precipitation in October and the total precipitation were effective on the quality. The rainfall in these months causes a significant decrease in protein content and MSDS, while increasing the of thousand seed weight and test weight.

Path analysis has been successfully used to determine the relationship hierarchy among the examined components. Path analysis is successfully used in terms of revealing the direct and indirect effects (effect percentages) of other independent

components on the dependent component determined between the components (Scheiner et al., 2000; Kashif and Khaliq, 2004; Anwarmalik et al., 1997; Dalkani et al., 2011). Path analysis is also useful in explaining the variation of the independent components on the dependent, as it effectively shows the direct and indirect effects of the independent components on the dependent. In the path analysis, which can be expressed as the interaction of the correlation relations of the selected independent components with each other and with the dependent component and shown directly and indirectly, the direct effect of each component on each dependent component and the indirect effects on the others are shown, and the effects of the independent components on the dependent component could be successfully

demonstrated (Dewey and Lu, 1959). In this study, the path analysis showing the effects of monthly precipitation and total precipitation on protein content, MSDS, thousand and test weight is given in Figure 1.

The months with the greatest effect on the protein content were determined as April, September, October precipitation and total precipitation. Likewise, the factors that have a significant impact on the MSDS were determined as total precipitation and October precipitation. It has been revealed that the total precipitation and precipitation in March, April, September, October and November have a significant effect on the thousand seed weight. Likewise, it was determined that the total precipitation, October, November, March and April precipitations had a significant effect on the test weight. As a result of the path analysis, total precipitation, autumn September and October precipitation, and spring April precipitation decreased the protein content and MSDS. On the other hand, total precipitation, March, April, May precipitation and September, October and November precipitation had a significant effect. It has been revealed that with increasing precipitation amount and an increase in thousand seed and test weights.

Decision tree, which is one of the analysis methods that has been put forward in recent years and its use is becoming more and more widespread, is an important analysis in terms of revealing the effect hierarchy of the components in question. In this analysis, the main factor in the form of tree branches and sub-factors are determined according to the values of the main factor, and the value of the dependent variable at each factor point is determined theoretically. The decision tree is widely used in the analysis of multiple components and shows the effect of other factors on the determined dependent variable in a hierarchical manner. This method, both visually and scientifically, shows the effect values of the main factors and the side factors under them by affecting the dependent variable and the value that the dependent variable will take in terms of these values (Smith, 1989; Call and Miller, 1990; Pal and Mather, 2003; Danielson et al., 2007; Nie et al., 2009; Phadatare et al., 2014). In our study, although protein content, MSDS, thousand seed and test weight are considered as dependent variables, the effects of monthly precipitation and annual total precipitation on protein content, MSDS, thousand seed and test weight, which are considered as

dependent variables, are given in Figure 2. As seen in the figure, the main factor affecting the protein content is the total precipitation, but the protein content was determined as 12,562% when the total precipitation was below 551,250 mm, and 11,124% when the precipitation was higher than 551,250 mm. June precipitation is effective when precipitation is more than 551,250 mm. Protein content is 12,406% when the June precipitation is less than 21,250 mm, and 10,666% when the precipitation is higher than 21,250 mm. Again, if the June precipitation is less than 221,250 mm, the October precipitation is effective. Protein content is determined as 9,527% when the October precipitation is less than 48,595 mm, and 11,121% when it is higher than 48.595 mm. According to the decision tree analysis, total precipitation, June and October oils have a significant effect on the protein content ($R^2:0,717$). It was determined that the main factor on the MSDS was total precipitation. It has been revealed that the MSDS is 37,870 ml when the total precipitation is less than 551,250 mm, and 30,781 ml when the total precipitation is higher than 551,250 mm. If the total precipitation is less than 551,250 mm, the October precipitation is effective, when the October precipitation is less than 2.8 mm, the MSDS is 32.317 ml, and when it is higher than 2.8 mm, the MSDS is 40.058 ml. Again, when the October precipitation is less than 2.8 mm, the May precipitation is effective, when the May precipitation is less than 40,250 mm, the MSDS is 23,043 ml, and when the May precipitation is higher than 40,250 mm, the MSDS is 35,980 ml. Here, total precipitation and precipitation in October and May are determined as effective on MSDS ($R^2:0.669$).

Figure 1. Path analysis showing the effects of monthly precipitations and total precipitation of the locations on protein content, MSDS, thousand seed weight and test weight.

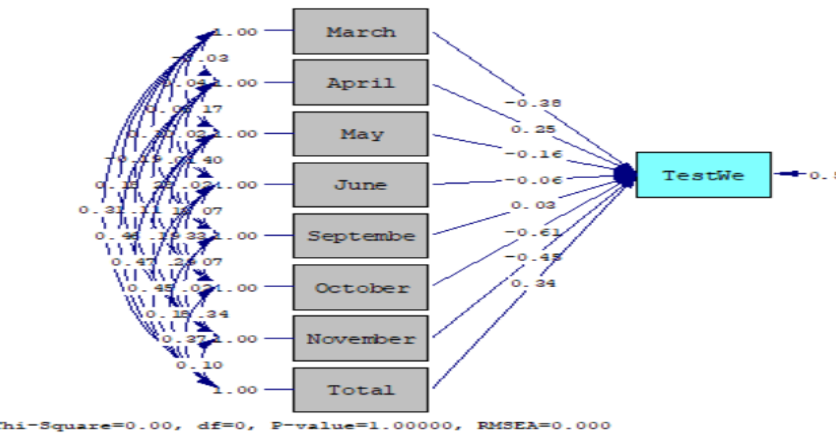
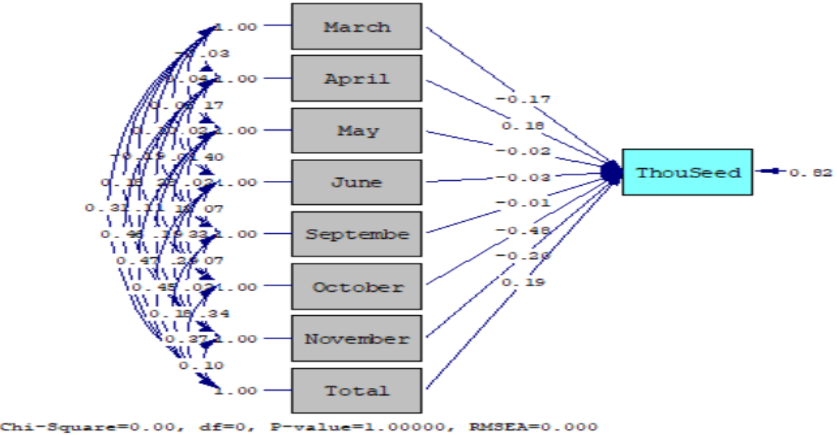
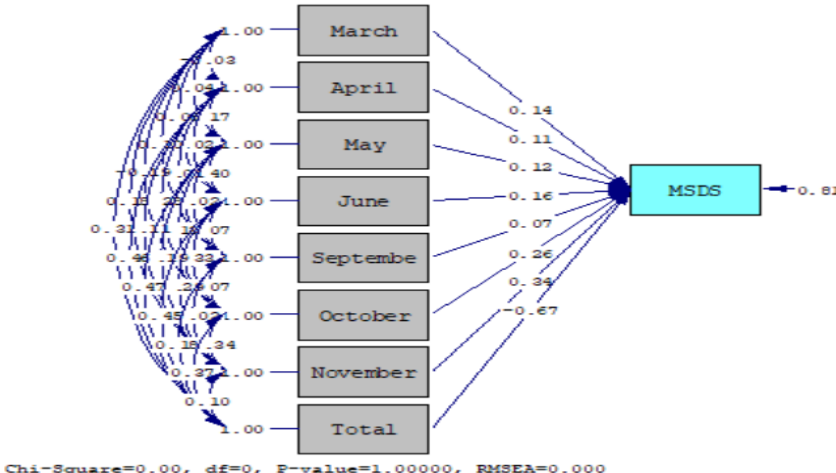
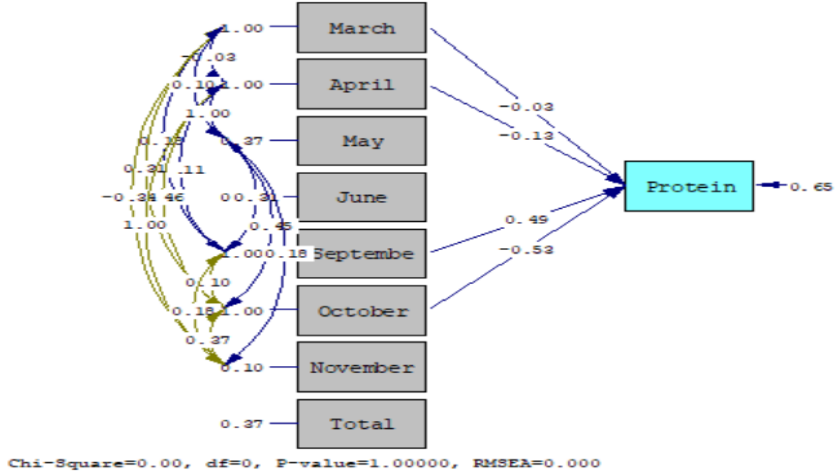

October precipitation mainly affects the thousand seed weight. When the October precipitation is less than 33,750 mm, the thousand seed weight is 36,568 g. If it is more than 33,750 mm, thousand seed weight is 34,183 g. If the October precipitation is less than 33,750 mm, the June precipitation is effective. When the precipitation in June is less than 4,700 mm, a thousand seed weight is 33,197 g. In the case where the precipitation in June is above 4,700 mm, the weight of a thousand seeds is 37,049 g. In the case of April less than 30,150 mm, the thousand seed weight is 34,782 g, and in the case of April precipitation higher than 30,150 mm, the thousand-seed weight is 28,443 gr. October precipitation is effective when April is less than 30,150 mm. When the precipitation in October is less than 25,300 mm, a thousand seed weight is 34,751 g. If the precipitation in October is more than 25,300 mm, thousand seeds weight is 37,585 g. June precipitation is effective when the precipitation in October is less than 25,300 mm.

When the June precipitation is less than 17,250 mm, the thousand seed weight is 36,030 g. In case the June precipitation is more than 17,200 mm, the of a thousand seed weight becomes 33,805 g. If the precipitation in October is more than 33,750 mm, November precipitation is effective. When the precipitation in November is less than 62,150 mm, the thousand seed weight is 37,409 g. In case the November precipitation is more than 62,150 mm, the thousand seed weight is 30,313 gr. If the November precipitation is less than 62,150 mm, the April precipitation comes into play. When the precipitation in April is less than 52,100 mm, the thousand seed weight is 33,789 g, and when it is higher than 52,100 mm, it is 35,688 g ($R^2: 0.543$). Here, the precipitations affecting the thousand seed weight were determined as April, June, October, and November precipitations.

The main precipitation affecting the test weight appears as the precipitation of March. In the case where the precipitation in March is less than 84 mm, the test weight is 79,196 kg/hl, and when precipitation in March is above 84,000 mm, it becomes 72,210 kg/hl. If the precipitation in March is less than 84 mm, the November precipitation comes into play.

When the November precipitation is less than 89,550 mm, the test weight is 79,343 kg/hl, and when November precipitation is more than 89,550 mm, test weight is 76.267 kg/hl. October precipitation is effective when November precipitation is less than 87,550 mm, test weight is determined as 80,142 kg/hl when October precipitation is less than 33,750 mm, and test weight is determined as 78,280 kg / hl when October precipitation is higher than 33,750 mm.

Figure 2. Decision tree analysis showing the effects of monthly precipitations and annual total precipitation on protein content, MSDS, thousand seed and test weight.

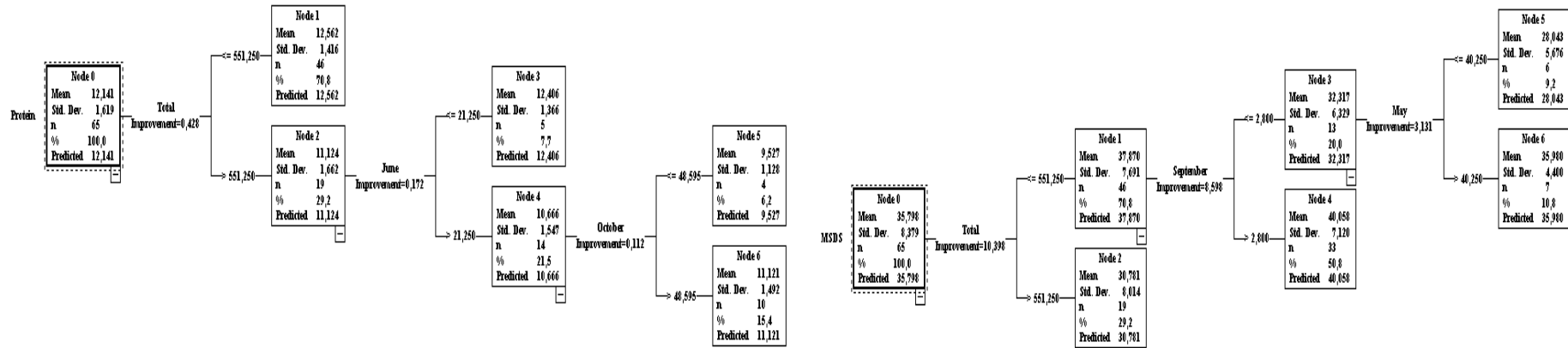

Protein Content, R²: Risk Estimation/δ²:1,881/2,62: 0,717

MSDS, R²: 47,007/70,205: 0,669

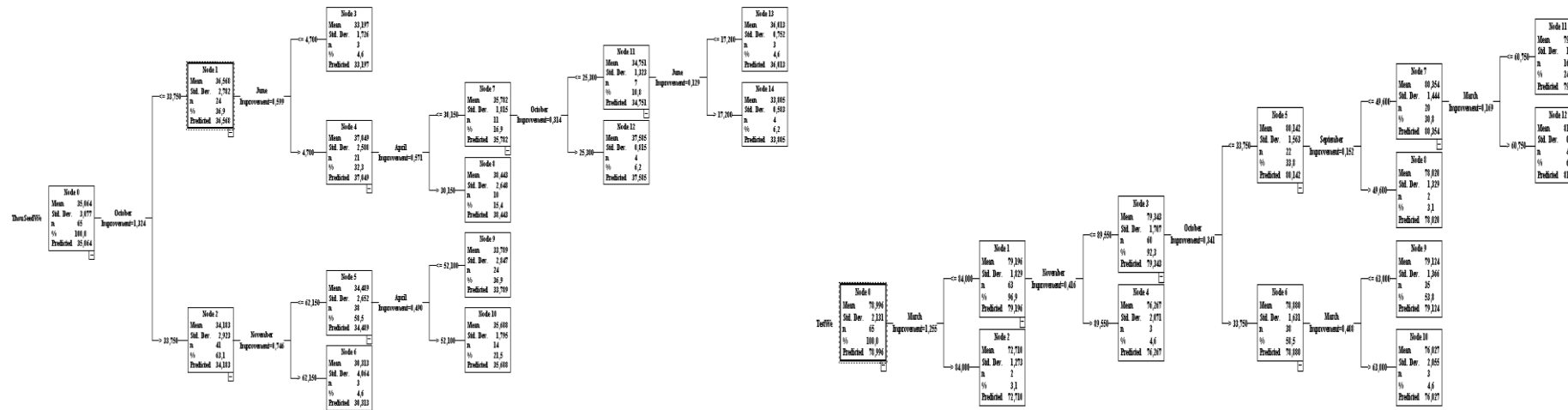

Thousand Kernel Weight, R²: 5,147/9,471: 0,543

Test Weight, R²: 1,731/4,541: 0,381

September precipitation is effective when October precipitation is less than 33,750 mm. If the September precipitation is less than 49,650 mm, the test weight is 80,350 kg/hl, and when the September precipitation is more than 49,600 mm, the test weight is 79,007 kg/hl. When the September precipitation is less than 49,600 mm, the March precipitation comes into play. When the March precipitation is less than 60,750 mm, the test weight is 79,984 kg/hl, and when the March precipitation is more than 60,750 mm, it is 87,835 kg/hl. When the October precipitation is higher than 30,750 mm, the March precipitation comes into play (R^2 : 0,281). Here, the precipitations that affect the test weight are the precipitations of March, September, October and November. Here, the test weight is mainly affected by the autumn precipitation. As a result of the decision tree analysis, rainfalls in March, April, May, June and October, September, November and total precipitation were determined as effective precipitation on quality.

The quality concept, including the protein content of precipitation, MSDS, thousand seed weight and test weight in bread wheat, is highly affected by the precipitation regime which is, one of the environmental factors. Therefore, although quality is affected at different rates by environmental factors including precipitation; The aim of breeding studies is to develop high yielding and quality, stable genotypes versus biotic and abiotic stresses (Panozzo and Eagles, 2000; Guarda et al., 2004; Anwarmalik et al. 2007). As a result; March precipitation, April precipitation, June precipitation, October precipitation and total precipitation were determined as significant factors affecting the quality (protein content, MSDS, thousand kernel weight and test weight) in bread wheat. Increasing precipitation, June precipitation, October precipitation and total precipitation cause increase in protein content and MSDS, while they cause a relative decrease in protein content and MSDS. Uşak and Kütahya provinces are superior regions in terms of test weight, thousand seed weight, Eskişehir and Konya provinces were determined as better provinces for MSDS and protein content.

Acknowledgement

This study was supported by Eskişehir Osmangazi University

Author Contributions

Murat OLGUN: Field work, laboratory work, article writing, Savaş BELEN: Field work, article writing, Yaşar KARADUMAN Field work, article writing, Zekiye BUDAK BAŞÇİFTÇİ: Field work, laboratory work, article writing, Nazife Gözde AYTER ARPACIOĞLU: Field work, laboratory work, article writing.

Conflict of Interest

The authors are declared that they have no conflict for this research article.

References

- Anwarmalik, M. F. Ashraf, M. Qureshi, A. S. and Ghafoor, A. (2007). Assessment of Genetic Variability, Correlation and Path Analyses for Yield and its Components in Soybean, *Pak. J. Bot.*, 39 (2), p. 405-413
- Armitage P. Berry G. (2002). *Matthews JNS. Statistical Methods in Medical Research* (4th edition). Oxford: Blackwell Science.
- Baraki, F. Tsehaye, Y. Abay, F. (2014). AMMI Analysis of Genotype \times Environment interaction and stability of sesame genotypes in northern Ethiopia. *Asian J. Plant Sci.* 13, 178.
- Buhlmann, P. and Yu, B. (2003). Boosting with the L2 loss: regression and classification. *J. Amer. Statist. Assoc.* 98, 324-339.
- Burnett, V. and Clarke S. (2002). *Organic farming: Wheat production and marketing. Agriculture Notes. AG1075. ISSN 1329-8062.*
- Calderini D.F. Dreccer, M.F. Slafer, G.A. (1997). Consequences of breeding on biomass, radiation interception and radiation-use efficiency in wheat, *Field Crops Research*, vol. 52 (pg. 271-281).
- Call, H. and Miller, W. (1990). "A Comparison of Approaches and Implementations for Automating decision analysis," *Reliability Engineering and Systems Safety*, 30, 115-162.
- Causinus H. Fekri M. Hakam S. Ruiz-Gazen A. (2003). A monitoring display of multivariate outliers, *Computational Statistics and Data Analysis*, vol. 44, num. 1-2, p. 237-252.
- Chen, R. B. Ing, C.K. and Lai T.L. (2011). An efficient pathwise variable selection criterion in weakly sparse regression models. *Tech. Report, Dept. Statistics, Stanford Univ.*
- Curic, D. Karlovic, D. Tusak, D. Petrovic, B. Dugum, J. (2001). Gluten as a Standart of Wheat Flour Quality, *Food Tech. Biotechnol.*, 39(4) : 353-361.
- Dalkani, M. Darvishzadeh, R. and Hassani, A. (2011). Correlation and sequential path analysis in Ajowan (*Carum copticum L.*), *Journal of Medicinal Plants Research*, 5 (2), p. 211-216.
- Danielson, M. Ekenberg, L. Larsson, A. (2007). Distribution of expected utility in decision trees. *Int. J. Approx. Reason.* 46, 387-407.
- Dewey, D.R. Lu, K.H. (1959). A Correlation and pathcoefficient analysis of components of crested wheatgrass seed production. *Agronomy Journal*, 51: 515-518.
- Efron, B. Hastie, T. Johnstone, I. and Tibshirani, R. (2004). Least angle regression (with discussion). *Ann. Statist.* 32, 407-499.
- Fasahat, P. Rajabi, A. Mahmoudi, S. Noghabi, M. A. and Rad, J. M. (2015). An overview on the use of stability parameters in plant breeding. *Biom. Biostat. Int. J.* 2, 00043.
- Feldman M. (2001). Origin of cultivated wheat. In: Bonjean AP, Angus WJ, eds. *The world wheat book: a history of wheat breeding*. Paris, France: Lavoisier Publishing, 3-56.
- Guarda, G., S. Padovan and G. Delogu. (2004). Seed yield, nitrogen-use efficiency and baking quality

- of old and modern Italian bread-wheat cultivars grown at different nitrogen levels. *Europ. J. Agronomy*, 21:181-192.
- Jaruchai, W. Monkham, T. Chankaew, S. Suriharn, B. And Sanitchon, J. (2018). Evaluation of stability and yield potential of upland rice genotypes in north and northeast Thailand. *J. Integr. Agric.* 17, 28–36.
- Kashif, M. and Khaliq, I. (2004). Heritability, correlation and path coefficient analysis for some metric traits in wheat, *International Journal of Agriculture & Biology*, 6, p. 138-142.
- Leibinger, T. and Reiners E. (2001). Demands of sector bodies for organic plant breeding. Language: German. Original title: Anliegen der Öko-Verbande. *Züchtungsforschung, Pflanzenzüchtung und Ökologischer Landbau, Quedlinburg, Germany*, 22-23 Nov. 2001. Beitrag zur Züchtungsforschung–Budesanstalt–für Züchtungsforschung an Kulturpflanzen, 8 (1): 199-23. (abstract)
- Nie, G. Zhang, L. Liu, Y. Zheng, X. Shi, Y. (2009). Decision analysis of data mining project based on Bayesian risk. *Expert Syst. Appl.* 36, 4589–4594.
- Pal M. and Mather P.M. (2003). An assessment of the effectiveness of decision tree methods for land cover classification. *Remote Sensing of Environment*, 86, pp. 554–56.
- Panozzo, J.F. and Eagles H.A. (2000). Cultivar and environmental effects on quality characters in wheat. II. Protein. *Aust. J. Agric. Res.*, 51: 629-636.
- Peterson, C.J. Graybosch, R.A. Baenziger, P.S. and Grombacher. A.W. (1992). Genotype and Environment Effects on Quality Characteristics of Hard Red Winter Wheat. *Crop Sci.*, 32: 98-103.
- Phadatare, M.M. Nandgaonkar, S.S. (2014). Uncertain data mining using decision tree and bagging technique. *Int. J. Comput. Sci. Inf. Technol.* 5, 3069–3073.
- Plenet D. and Lemaire G. (2000). Relationships between dynamics of nitrogen uptake and dry matter accumulation in maize crops. Determination of critical N concentration”, *Plant Soil*. 216: 65–82.
- Poudel, A. Thapa D. B. and Sapkota M. (2017). Assessment of genetic diversity of bread wheat (*Triticum aestivum* L.) genotypes through cluster and principal component analysis. *Int. J. Exp. Res. Rev.*, 11: 1-9.
- Scheiner, S.M. Mitchell, R.J. and Callahan, H.S. (2000). Using path analysis to measure natural selection, *J. Evol. Biol.*, 13, p. 423-433.
- Sheskin D. (2011). *Handbook of Parametric and Nonparametric Statistical Procedures Test*, Chapman and Hall/CRC, Fifth Edition, 2011, S.800
- Shewry; P.R. (2009). Wheat. *Darwin Review, Journal of Experimental Botany*, Vol. 60, No. 6, pp. 1537–1553.
- Singh K.B. and Chaudhary B.D. (1977). *Biometrical methods in quantitative genetic analysis*. Kalyani Publishers New Delhi-India. 304 p
- Slafer, G.A. Calderini, D.F. Miralles, D.J. (1996). Generation of yield components and compensation in wheat: opportunities for further. increasing yield potential. In: Reynolds, M. Ed., *Increasing Yield Potential in Wheat: Breaking the Barriers*. CIMMYT Int. Symp., CIANO, Cd. Obregon, Mexico. CIMMYT, Mexico, D.F., pp. 101–133.
- Smith, J. (1989). “Influence Diagrams for Bayesian Decision Analysis,” *European Journal of Operational Research*, 40, 363-376.
- Spaldon, S. Samnotra, R. Dolkar, R. Choudhary, D. (2017). Stability analysis and genotype x environment interaction of quality traits in tomato (*Solanum lycopersicum* L.). *Int. J. Curr. Microbiol. App. Sci*6, 1506–1515.
- Tibshirani, R. (1996). Regression shrinkage and selection via the Lasso. *J. Roy. Statist. Soc. B* 58, 267-288.
- Tipples, K.H. Kilborn, R.H. and Preston, K.R. (1981). Bread Wheat Quality Defined. A Dough Height Tracker and its Potential Application to the Study of Dough Characteristics. *Cereal Chemistry* 58 : 198-201.
- Tiwari, A. K. and Lal, G. (2014). Genotype–environment interaction and stability analysis in tomato (*Solanum lycopersicum* L.). *Indian J. Hill Farming* 27, 16–18.
- Wang, W. Vinocur, B. Shoseyov, O. and Altman, A. (2004). Role of plant heatshock proteins and molecular chaperones in the abiotic stress response, *Trends in Plant Science*, 9(5), 244-252.
- Wang, X. Vignjevic, M. Jiang, D. Jacobsen, S. and Wollenweber, B. (2014). Improved Tolerance to Drought Stress After Anthesis due to Priming Before Anthesis in Wheat (*Triticum aestivum* L.) var. Vinjett. *Journal of Experimental Botany*, 65(22), 6441-6456.
- Zwingelberg, H. (1961). Beziehungen zwischen gnantzkomasohage halt, Mehlassneghalt und mehlfarbe bei weizensorten. *Getreide meh.* 10:117-119.