

**DAMAGE DETECTION IN SIMULATED SPACE FRAMES USING GENETIC ALGORITHMS**

**Musa ARTAR\*<sup>1</sup>, Ayşe T. DALOĞLU<sup>2</sup>**

<sup>1</sup>*Department of Civil Engineering, Bayburt University, BAYBURT*

<sup>2</sup>*Department of Civil Engineering, Karadeniz Technical University, TRABZON*

Received/Geliş: 05.12.2014 Revised/Düzeltilme: 22.02.2015 Accepted/Kabul: 13.04.2015

**ABSTRACT**

Genetic algorithms (GA) based finite element model updating are applied to predict damage location and severity in space frames. The changes in natural frequencies are used as dynamic indicators to describe damaged members. Objective functions including dynamic data provide minimization of dynamic differences between numerical model and simulated damaged model. The presence of damages in structural elements is identified by stiffness reduction as a reduction in modulus of elasticity. Reproduction, double-point crossover and mutation operators are used in GA optimization procedures. In this paper, different simulated examples having various damage scenarios are modelled in SAP2000 software to obtain the experimental dynamic data. In the last example, noise effect is taken into account in simulated damaged data. A program is developed in MATLAB software for numerical model updating based on all genetic algorithm procedures. Thus, the size and extent of simulated damages are determined by updated numerical model. Results obtained from examples show that GA optimization is a convenient method for damage identification.

**Keywords:** FEM, genetic algorithm, dynamic analysis, damage detection.

**SİMÜLE EDİLMİŞ UZAY ÇERÇEVE SİSTEMLERDE GENETİK ALGORİTMA YÖNTEMİ İLE HASAR TESPİTİ**

**ÖZET**

Sonlu eleman modeli güncellenmesine dayalı genetik algoritma yöntemi, uzay çerçevelerde hasar yerinin ve hasarın şiddetinin belirlenmesinde kullanılmıştır. Yapıya ait doğal frekanslardaki değişiklikler, hasarlı elemanların belirlenmesinde dinamik belirleyiciler olarak kullanılmaktadır. Dinamik verileri içeren amaç fonksiyonları nümerik model ile simüle edilmiş hasarlı model arasında dinamik farklılığı minimize etmeyi sağlamaktadır. Yapı elemanlarındaki hasarın varlığı, elastisite modülünde ve dolayısıyla rijitlik matrisindeki azalma olarak tanımlanmaktadır. Genetik algoritmada üreme, çift noktalı çaprazlama ve mutasyon operatörleri kullanılmaktadır. Bu çalışmada çeşitli hasar senaryolarına sahip farklı simüle edilmiş örneklerin dinamik verileri Sap2000 programı yardımı ile elde edilmiştir. Son örnekte gürültü etkisi dinamik verilerin elde edilmesinde hesaba katılmıştır. Bu çalışmada tüm genetik algoritma işlemlerini esas alan nümerik model güncellemesi için MATLAB’da bir program geliştirilmiştir. Böylece simüle edilmiş hasarların büyüklüğü güncellenmiş nümerik model ile belirlenebilmektedir. Örneklerden elde edilen sonuçlar GA ile optimizasyonun hasar tespiti için uygun bir yöntem olduğunu göstermiştir.

**Anahtar Sözcükler:** FEM, genetik algoritma, dinamik analiz, hasar tespiti.

\* Corresponding Author/Sorumlu Yazar: e-mail/e-ileti: martar@bayburt.edu.tr, tel: (458) 211 11 53 / 3269

## 1. INTRODUCTION

Structures can have damages due to manufacturing faults or external impacts such as earthquakes etc. Also some damages that can not be visible from outside are not identified directly. Therefore, damage detection is very important for public safety and this subject has been studied by many researches.

Mares [1] focused on an application of genetic algorithms to identify damage in elastic structures. Chou and Ghaboussi [2] examined genetic algorithm in structural damage detection. Dutta and Talukdar [3] investigated damage detection in bridges using accurate modal parameters. They studied a simulated simply supported bridge. Ananda Rao et al. [4] focused on damage detection by using genetic algorithms. They studied plane systems such as plane truss, cantilever beam and portal frame systems with damaged cases. Jaishi and Ren [5] examined damage detection by finite element model updating using modal flexibility residual. They performed a simulated simply supported beam. Perera and Torres [6] researched structural damage detection based on the changes in frequencies and mode shapes of vibration of a structural system. They used GA and performed a simply supported beam used for the simulation with various damage scenarios. Gomes and Silva [7] performed a comparative study for damage detection on structures using GAs and modal sensitivity method. They simulated some damage cases for simple supported beam and portal plane frame systems. Esfandiari et al. [8] focused on a method using the frequency response function (FRF) and natural frequencies data for finite element model updating. They used simulated data of a plane truss system with damage cases. Liu et al. [9] examined structural damage detection with multi-objective function using GAs. They simulated a simple beam with various damage cases numerically by MATLAB software to obtain experimental dynamic data. Sim et al. [10] investigated a multimetric approach based on the damage locating vector method and studied numerical simulations to verify the efficiency of the proposed approach. Khoshnoudian and Esfandiari [11] investigated structural damage diagnosis using modal data. They studied numerical examples such as planer truss and frame systems with simulated damage cases. Nejad et al. [12] investigated damage detection of skeletal structures using particle swarm optimizer with passive congregation (PSOPC) algorithm via incomplete modal data. They studied some numerical simulations such as a cantilever beam, four-bay plane truss and two-bay two-story plane frame with different scenarios. Majumdar et al. [13] focused on damage assessment of truss structures from changes in natural frequencies using ant colony optimization. Asnaashari and Sinha [14] studied crack detection in structures using deviation from normal distribution of measured vibration responses. They simulated some examples such as cantilever beam and simply supported beam systems. Tang and Xie [15] studied a virtual flexibility matrix (VFM) technique based on changes in structural frequencies and mode shapes to detect damage locations and severity. They focused on simulated plane truss and simply supported beam models with various damages scenarios. They used simulated data obtained from the finite element method (FEM) package ANSYS and numerical results obtained from routines developed in the MATLAB.

Numerical model is updated continuously to approach simulated damaged model by reducing elastic modulus of structural elements. Thus, the location and severity of simulated damage is predicted by GA minimization based finite element model updating. In this study, four different examples are examined by using natural frequencies. The natural frequencies data of simulated damaged model in example 1 is taken from literature and also verified by MATLAB [16] and SAP2000 [17] softwares. The natural frequencies data of the other simulated examples are obtained from SAP2000 software. In the last example, simulated damaged data with noise are used in GA.

Most of the studies in the literature focused on the damage detection in truss and plane frame systems. The aim of this study is to determine the damage detection in simulated space frames using GAs based finite element model updating.

**2. THEORETICAL BACKGROUND: GENETIC ALGORITHM, OBJECTIVE FUNCTION AND NATURAL FREQUENCIES**

Several numerical optimization methods such as genetic algorithm, harmony search algorithm, ant colony optimization algorithm, particle swarm optimization (PSO) and virtual flexibility matrix algorithm etc., have been implemented by many researchers in literature. Genetic Algorithm (GA) one of these methods was proposed by Goldberg and Holland [18] and conducts natural biological procedures such as reproduction, crossover and mutation. Determination of damages are carried out by using reduction factors in GA analyses. Each reduction factors are represented by codes. In this study, binary encoding system is used in Genetic Algorithm. The code chain length in GA depends on the number of reduction factors for elastic modulus and the number of structural members. Table 1 shows four different reduction factors and their binary encoding in GA. For example, each individual in a population is occurred from 40(20\*2)-digit code chain for a 20-bar structural system. A reduction factor indicates damage severity in structural element. For example, reduction factors such as 0.25, 0.50, 0.75 and 1.00 (shown in Table 1) refer to 0.75, 0.50, 0.25 and 0 (undamaged), respectively.

**Table 1.** Reduction factors and binary encoding in GA

Reduction factors	Binary encoding in GA
0.25	00
0.50	01
0.75	10
1.00	11

Natural frequencies of simulated damaged model, reduction factors and geometric and material properties of the structural systems are entered as input data. GA analysis is then started with random initial population. The code chains of individuals in population are solved and suitable reduction factors are assigned to elastic modulus of elements in structure. Local stiffness (k), mass (m) and transformation (T) matrices of each element are determined. Thus, global stiffness (K) and mass (M) of structural system are defined and natural frequencies of numerical model are calculated from Eqs. (1) and (2) [19, 20].

$$([\mathbf{K}] - \lambda_i [\mathbf{M}])[\Phi_i] = 0 \quad i=1, \dots, n \tag{1}$$

$$\sqrt{\lambda_i} = \omega_i \quad f_i = \frac{\omega_i}{2\pi} \tag{2}$$

where K and M are the global stiffness and mass matrices, respectively.  $\omega_1$  is angular vibration frequency of structure (rad/s),  $\Phi_1$  is eigenvector (mode shape),  $\lambda_1$  is eigenvalue and n is total number of mode shapes.  $f_i$  is vibration per second (Hz).

In the next step, the objective function value of each individual in population (generation) for each *i*th mode is calculated from Eqs. (3) and Eq. (4) [19, 21];

$$F_{\text{frequencies},i} = \left| \frac{f_i^D - f_i^N}{f_i^D} \right| \quad i = 1, \dots, m \tag{3}$$

where  $m$  is total number of available mode shapes.

$$F_{t,i} = \sum_{\text{frequencies},i} F \tag{4}$$

The values of  $F_{\text{frequencies},i}$  for  $i$  th mode are between 0 and 1, so the total objective function value,  $F_{t,i}$  changes between 0 and  $1 * m$ . All steps of GA are repeated until the total objective function value is equal to zero. When the total objective function value is equal to zero, the difference between updated numerical model and simulated damaged model is minimized by GA and thus, these two models are the same. In the next step, GA operators (reproduction, double-point crossover and mutation) are applied to generation [22-25]. In the reproduction operator, the individuals having the best values (close to zero) of the objective function remain in the population and the individuals with the worst value are removed from population and then, the best individuals are copied instead of the worst individuals. Thus, the number of individuals in the population remains the same.

After crossover operator applied to the population, mutation operator are applied to all individuals with a prescribed probability. Randomly selected individual codes are changed from 0 to 1 or from 1 to 0. Finally, next population is obtained as better than previous population. All steps of GA are repeated until the objective function value is equal to zero. In this study, a computer program is coded in MATLAB to use GA based FEM updating. Accordingly, Fig. 1 shows the flowchart of GA optimization.

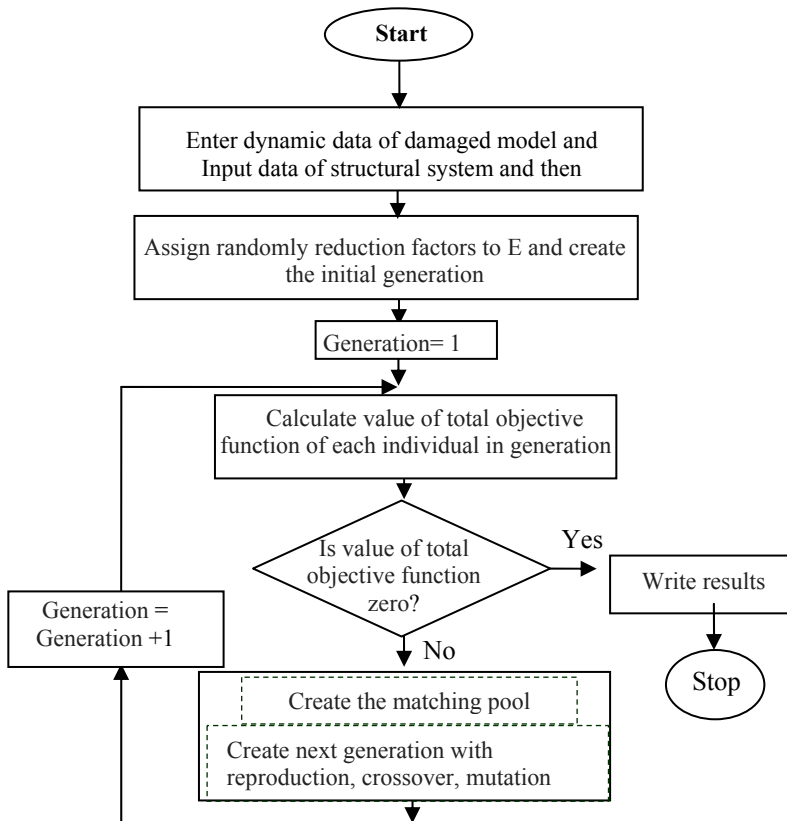

**Figure 1.** GA flowchart

3. NUMERICAL EXAMPLES

3.1. Verification of Dynamic Analyses

A continuous beam is divided into 30 elements as shown in Fig. 2. The dynamic analysis of this simulated continuous beam was previously carried out by Ren and Roeck [26]. The parameters are elastic modulus  $E=3200 \text{ kN/cm}^2$ , and material density  $\rho=2.50 \text{ ton/m}^3$ .

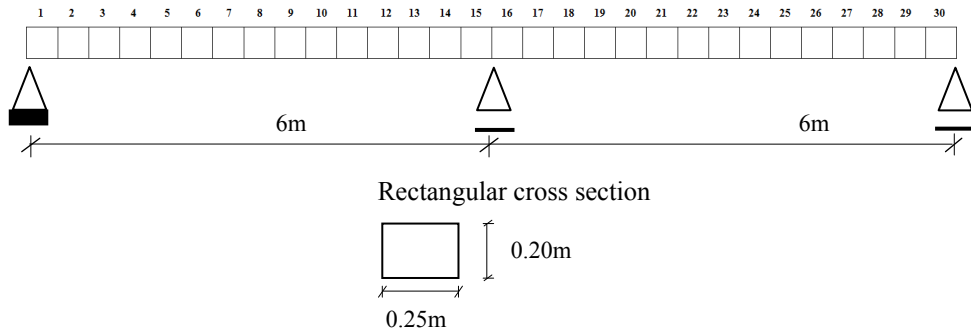

Figure 2. 30-element simulated continuous beam

This example aims to verify the results of MATLAB and SAP2000 softwares. Table 2 shows that the first four natural frequencies calculated from Ren and Roeck [26] and present study. The results of the dynamic analysis carried out by MATLAB and SAP2000 softwares in this study are verified by comparison with previous study.

Table 2. Natural frequencies of undamaged continuous beam

Natural Frequencies (Hz)	1	2	3	4	
Previous study (Ren and Roeck [26])	9.0087	14.072	35.986	45.539	
Present study	MATLAB	9.012	14.079	36.051	45.626
	SAP2000	9.0	14.024	35.844	45.158

3.2. Damage Detection Using Simulated Damaged Data Without Noise

3.2.1. 15-Element Cantilever Beam

Fig. 3 shows a 15-element cantilever beam which is previously studied by Aktaşoğlu [27] for undamaged and damaged cases. Its design parameters are the cross section  $0.025 \times 0.05 (h \times b) \text{ m}^2$ , elastic modulus  $E=20600 \text{ kN/cm}^2$  and material density  $\rho= 7.827 \text{ ton/m}^3$ . In the damaged case, the element number 3 has 40% damage. Eight different reduction factors such as 0.05, 0.20, 0.35, 0.50, 0.60, 0.70, 0.85 and 1.00 are considered in GA analysis. The population size, crossover probability and mutation are selected as 20, 0.90 and 0.05, respectively. Table 3 shows the values of the first six natural frequencies obtained from MATLAB and SAP2000 softwares for undamage and damage cases in addition to ones available in Aktaşoğlu [27].

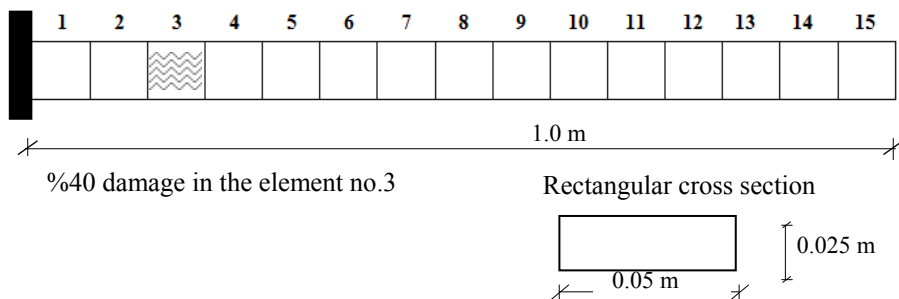

**Figure 3.** 15-element cantilever beam

**Table 3.** Natural frequencies (Hz) obtained from SAP2000 and MATLAB softwares

Mode	Literature Study Aktaşoğlu [27] Finite Element Analysis		This Study (undamaged case)		This Study (damaged case)	Relative error% $\left  \frac{a-b}{a} \right  * 100$
	Undamaged	damaged	Sap2000 a	MATLAB b	Sap2000	
1	20.67	19.66	20.669	20.676	19.656	0.0338
2	128.58	127.98	128.6	128.927	128.0	0.254
3	357.09	355.27	357.23	359.372	355.41	0.599
4	692.69	677.92	693.17	700.935	678.4	1.120
5	1131.27	1100.14	1132.5	1153.1	1101.3	1.819
6	-	-	1282.0	1282.0	1231.5	0

As it is observed from Table 3 that the results of natural frequencies in damaged and undamaged cases are very close to the results obtained by Aktaşoğlu [27]. Aktaşoğlu [27] defines damage definition as a percentage reduction of elastic modulus of an element in the 15-element beam. Also Aktaşoğlu [27] tried some different damage severities in FEM which are from 10% to 70% by %10 increments. Namely, 7 different damage severities on 15 element cantilever beam are applied in many damage scenarios in the algorithm based FEM to find real damaged element.

Figs. 4 and 5 present the results for one damaged case. The first six natural frequencies are sufficient to define one damaged case. As seen from Fig. 4, the total objective function is equal to zero after 40th iteration. It means that the difference between updated numerical model and simulated damaged model is minimized by GA optimization. Fig. 5 shows the reduction factors according to element number and individual number in the last population. In this figure, it is observed that the reduction factor of element number 3 in the individual no. 1 is 0.60 and it refers the element has 40% damage. The reduction factors of the other elements in this individual are 1.00. So, they are undamaged elements. This situation is also valid for the most of other individuals as shown in Fig. 5.

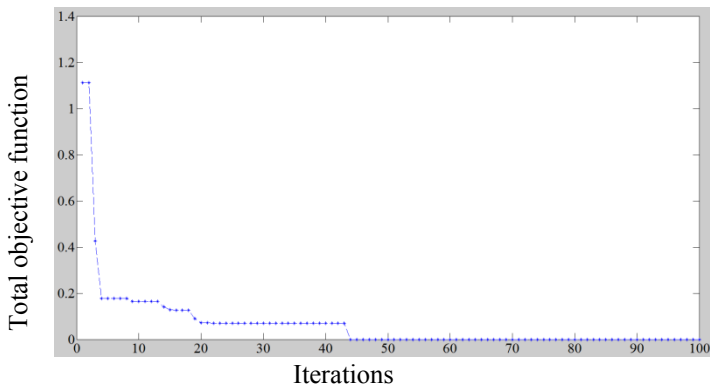

Figure 4. The variation of the total objective function with iterations for one damaged case

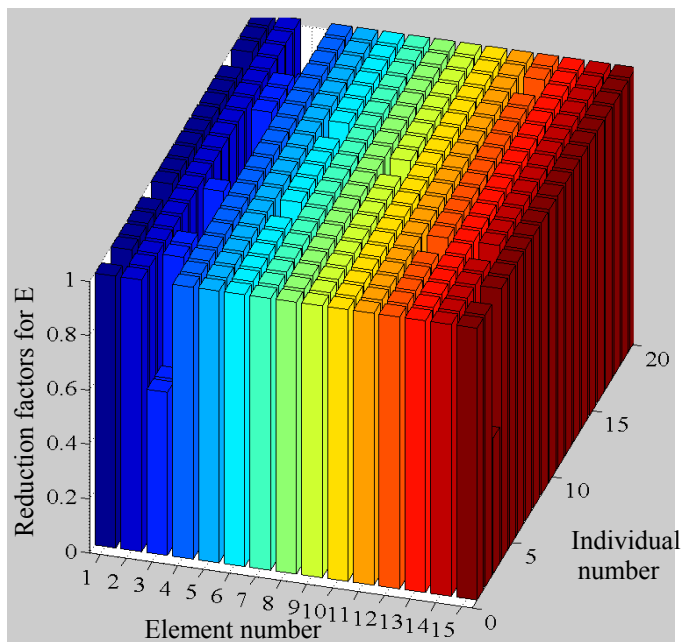
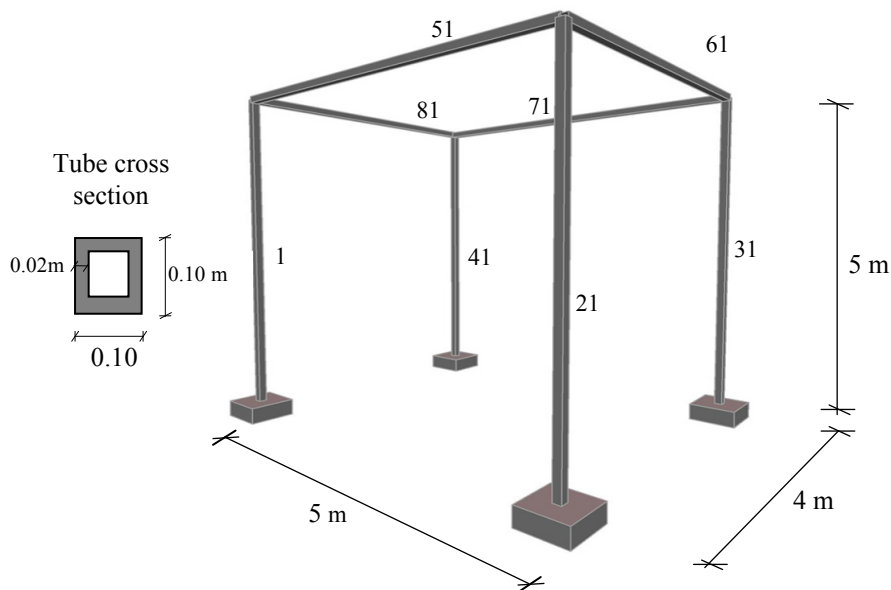

Figure 5. Reduction factors according to element number and individual number in the last population for the damaged case

### 3.2.2. 8-Bar Space Frame System

An 8-bar space frame system is shown in Fig. 6. The design parameters are the elastic modulus  $E=21000 \text{ kN/cm}^2$ , shear modulus  $G=8100 \text{ kN/cm}^2$  and material density  $\rho= 7.85 \text{ ton/m}^3$ . Tube cross section shown in Fig. 6 is selected for all members and its parameters are  $A=64 \cdot 10^{-4} \text{ m}^2$ ,  $I_z=7.253 \cdot 10^{-6} \text{ m}^4$ ,  $I_y= 7.253 \cdot 10^{-6} \text{ m}^4$  and torsional constant  $J=1.024 \cdot 10^{-5} \text{ m}^4$ . Four reduction factors such as 0.25, 0.50, 0.75 and 1.00 are taken into account in GA analysis. Three different damage scenarios are performed. The element number 6 has 75% damage in Case 1. In Case 2, the element numbers 2 and 6 have 25% and 75% damages, respectively. In Case 3, the element

numbers 1, 2 and 6 have 50%, 25% and 75% damages, respectively. The population size is 30, crossover probability is taken as 0.90 and 0.05 is used for mutation in GA. Table 4 shows the values of the first eight natural frequencies obtained from MATLAB and SAP2000 softwares. As seen in Table 4, the frequency results of MATLAB are quite close to the frequency results of SAP2000 for undamaged case. The required values of the damaged natural frequencies are obtained from SAP2000 software for each damaged case.



**Figure 6.** 8-bar space frame system

**Table 4.** Natural frequencies (Hz) obtained from SAP2000 and MATLAB softwares

Mode	Undamaged case (Hz) (a)	SAP2000			MATLAB Undamaged case(Hz) (b)	Relative error % $  (a-b)/a   *100$
		One damaged case (Hz)	Two damaged case (Hz)	Three damaged case (Hz)		
1	2.712	2.471	2.3843	2.2947	2.714	0.103
2	2.786	2.712	2.6383	2.4098	2.789	0.122
3	3.002	2.945	2.9159	2.7206	3.006	0.123
4	6.154	5.247	5.2154	5.127	6.162	0.128
5	139.15	110.04	110.04	98.444	139.143	0.005
6	139.18	139.15	120.54	110.04	139.173	0.005
7	139.2	-	139.16	120.54	139.194	0.004
8	139.25	-	139.18	139.17	139.238	0.009



3.2.1.1. One Damaged Case

Figs. 7 and 8 present the results for one damaged case. The first six natural frequencies are sufficient to define one damaged case. As seen from Fig. 7, the total objective function is equal to zero at the 13th iteration. It means that the difference between updated numerical model and simulated damaged model is minimized by GA optimization. Fig. 8 shows the reduction factors according to element number and individual number in the last population. In this figure, it is observed that the reduction factor of element number 6 in the individual No. 30 is 0.25 and it refers the element has 75% damage. The reduction factors of the other elements in this individual are 1.00. So, they are undamaged elements. This situation is also valid for the most of other individuals as shown in Fig. 8.

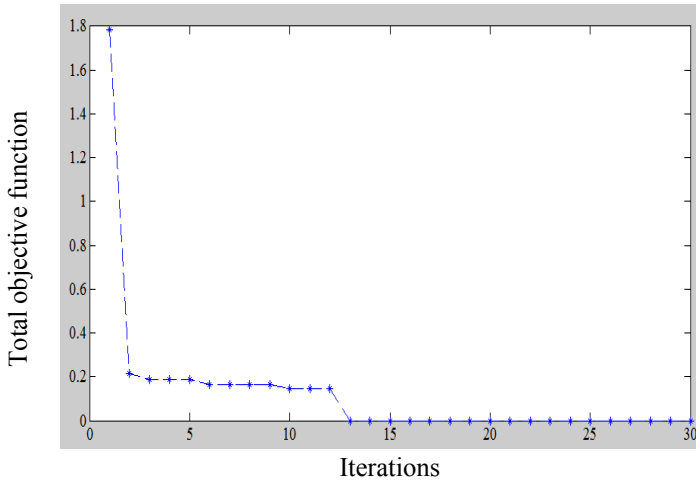

Figure 7. The variation of the total objective function with iterations for one damaged case

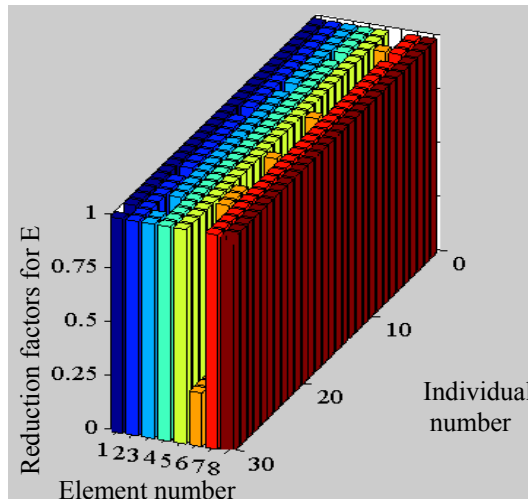
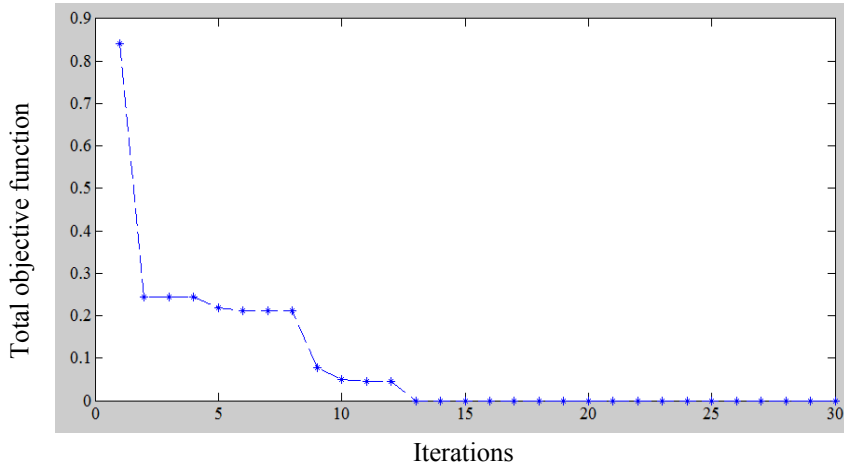

Figure 8. Reduction factors according to element number and individual number in the last population for one damaged case

**3.2.1.2. Two Damaged Case**

The total objective function is equal to zero at the 13th iteration as seen from Fig. 9. It indicates that the damages are probably predicted by the updated numerical model. Fig. 10 shows the reduction factors in the last population. It is observed in this figure that the reduction factors of element numbers 2 and 6 in the individual No. 1 are 0.75 and 0.25, and therefore the elements have 25% and 75% damages, respectively. The reduction factors of the other elements in this individual are 1.00 which refer undamaged elements. Also, as shown in Fig. 10 this situation is valid for the most of other individuals.



**Figure 9.** The variation of the total objective function with iterations for two damaged case

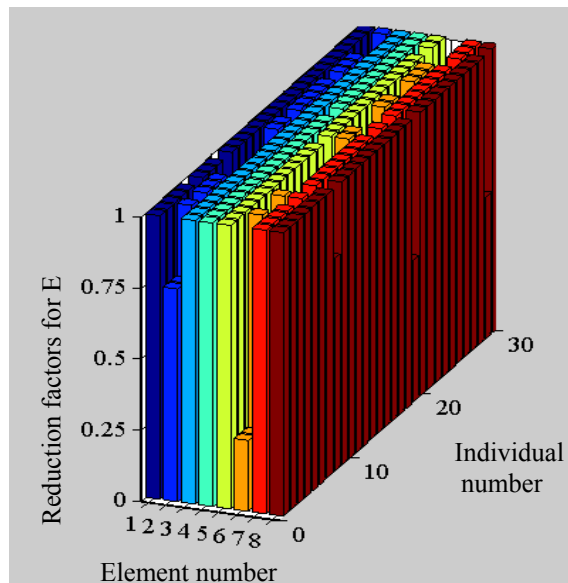

**Figure 10.** Reduction factors according to element number and individual number in the last population for two damaged case

### 3.2.1.3. Three Damaged Case

It is observed from Fig. 11 that three damages cause an increase in the number of iterations and the total objective function is equal to zero at the 88th iteration. In this iteration, the difference between updated numerical model and simulated damaged model is minimized by GA optimization. As seen from Fig. 12, the reduction factors of element numbers 1, 2 and 6 in the individual No. 1 are 0.50, 0.75 and 0.25, respectively. It means that these elements have 50%, 25% and 75% damages, respectively. This situation is also valid for the most of other individuals shown in the figure.

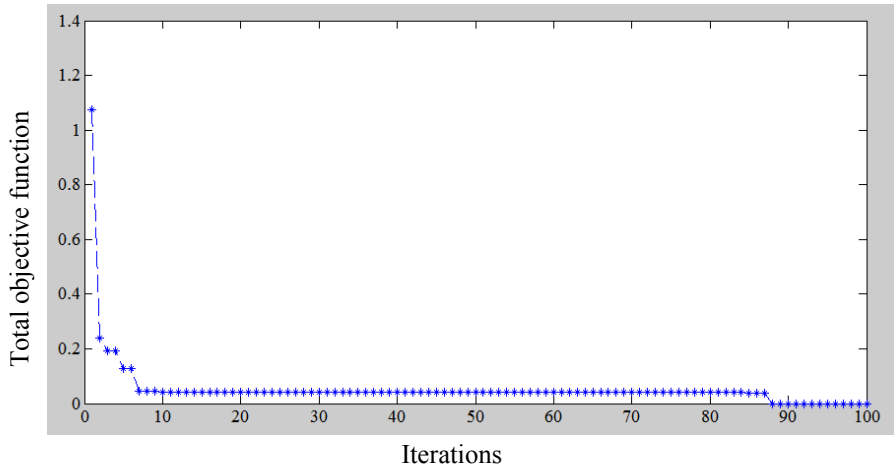
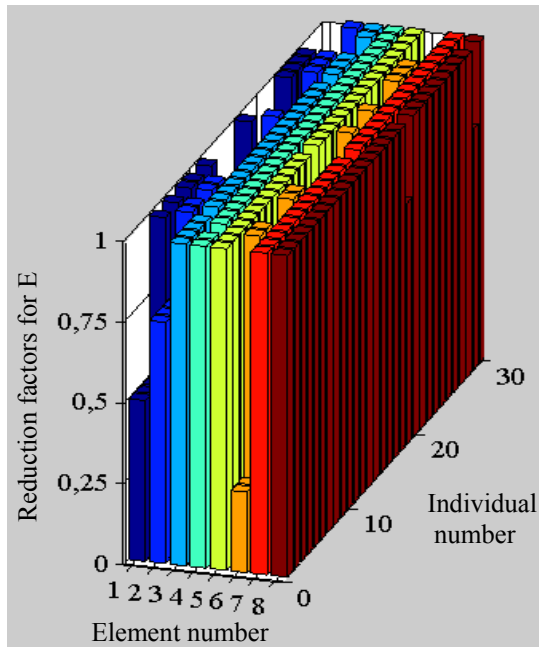

Figure 11. The variation of the total objective function with iterations for three damaged case



**Figure 12.** Reduction factors according to element number and individual number in the last population for three damaged case

### 3.2.2. 24-Bar Space Frame System

A 24-bar space frame system is shown in Fig. 13. The section and material properties are the same as the 8-bar space frame system and four reduction factors such as 0.25, 0.50, 0.75 and 1.00 are taken into account in GA analysis. Three different damage scenarios are performed. In Case 1, the element number 11 has 75% damage. In Case 2, the element numbers 5 and 11 have 50% and 75% damages, respectively. In Case 3, the element numbers 5, 11 and 17 have 50%, 75% and 50% damages, respectively. Crossover probability is taken as 0.90 and 0.05 is used for mutation with a population size of 30 (for Case 1 and Case 2) and 50 (for Case3). Table 5 shows the values of the first eight natural frequencies obtained from MATLAB and SAP2000 softwares. As seen in Table 5, the frequency results of MATLAB are confirmed by the frequency results of SAP2000 for undamaged case. Also, there are the natural frequencies of the damaged cases simulated by SAP2000.

**Table 5.** Natural frequencies (Hz) obtained from SAP2000 and MATLAB softwares

Mode	SAP2000				MATLAB	Relative error %
	Undamaged case (Hz) (a)	One damaged case (Hz)	Two damaged case (Hz)	Three damaged case (Hz)	Undamaged case(Hz) (b)	$\left  \frac{a-b}{a} \right  * 100$
1	0.90483	0.875	0.83401	0.83053	0.9057	0.096
2	0.9523	0.915	0.9135	0.91055	0.9535	0.126
3	1.0693	1.036	1.0204	1.0135	1.0706	0.122
4	2.8321	2.803	2.7905	2.7092	2.8349	0.099
5	2.9304	2.898	2.8975	2.8096	2.9339	0.119
6	3.1962	3.162	3.1557	3.0631	3.1999	0.116
7	4.7152	4.268	4.2663	4.2489	4,72	0.102
8	4.7636	4.4037	4.3943	4.3043	4.7687	0.107

**3.2.2.1. One Damaged Case**

The number of iterations increases according to the previous example and the total objective function is equal to zero at the 24th iteration as seen from Fig. 14. The damage is determined by the updated numerical model. Fig. 15 shows the reduction factors according to element number and individual number in the last population. It is observed in this figure that the reduction factors of element number 11 in the individual No. 1 is 0.25, and therefore the element has 75% damage. The reduction factors of the other elements in this individual are 1.00 representing undamaged elements. This situation is also valid for the most of other individuals shown in Fig. 15.

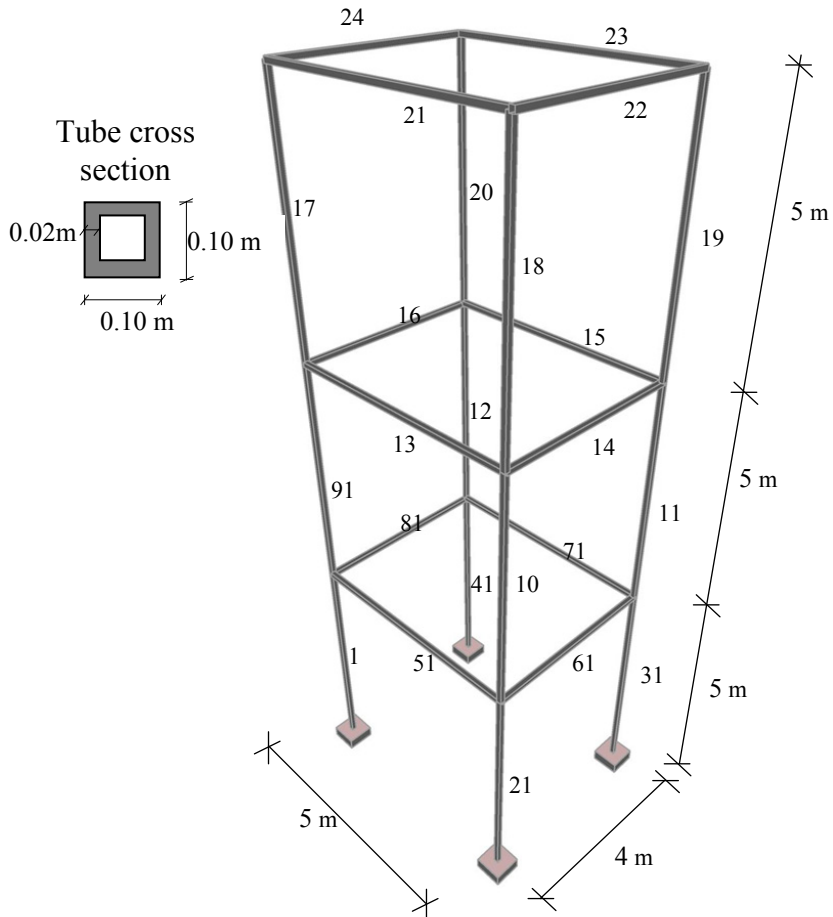

Figure 13. 24-bar space frame system

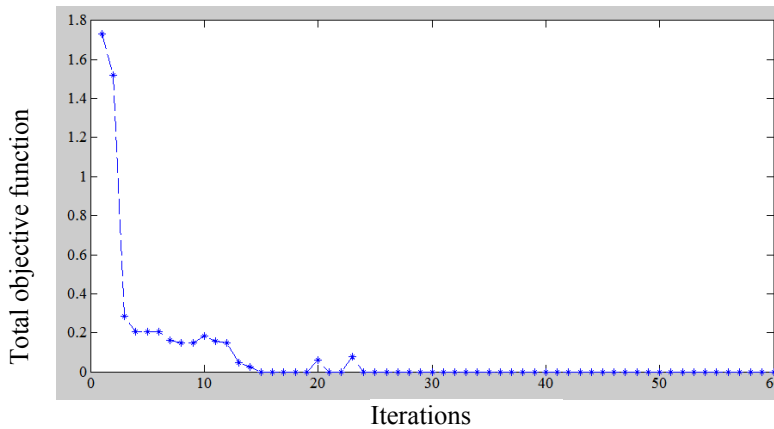
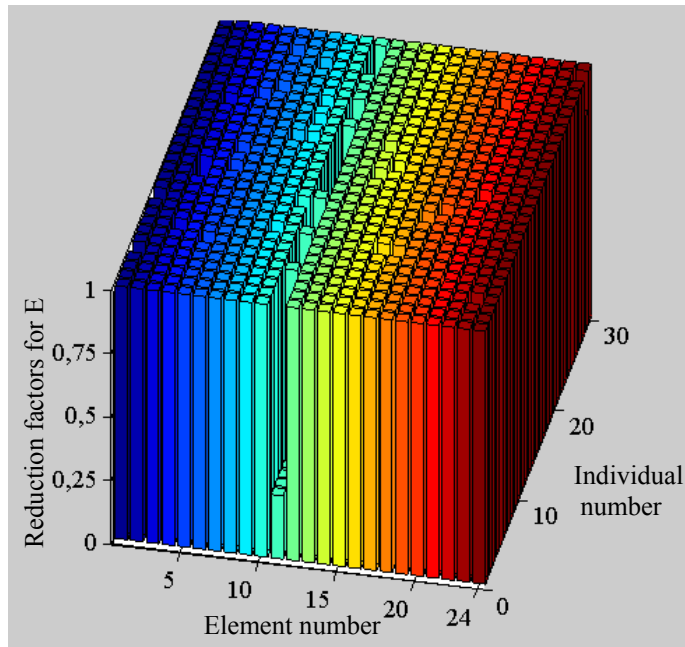

Figure 14. The variation of the total objective function with iterations for one damaged case



**Figure 15.** Reduction factors according to element number and individual number in the last population for one damaged case

### 3.2.2.2. Two Damaged Case

The total objective function is equal to zero at the 60th iteration as shown in Fig. 16, and the time required increases accordingly. the difference between updated numerical model and simulated damaged model is minimized by GA optimization after 60 iteration. As seen from Fig. 17, the reduction factors of element numbers 5 and 11 in the individual No. 1 are 0.50 and 0.25, respectively. It indicates that these elements have 50% and 75% damages like most of other individuals as shown in this Fig. 17.

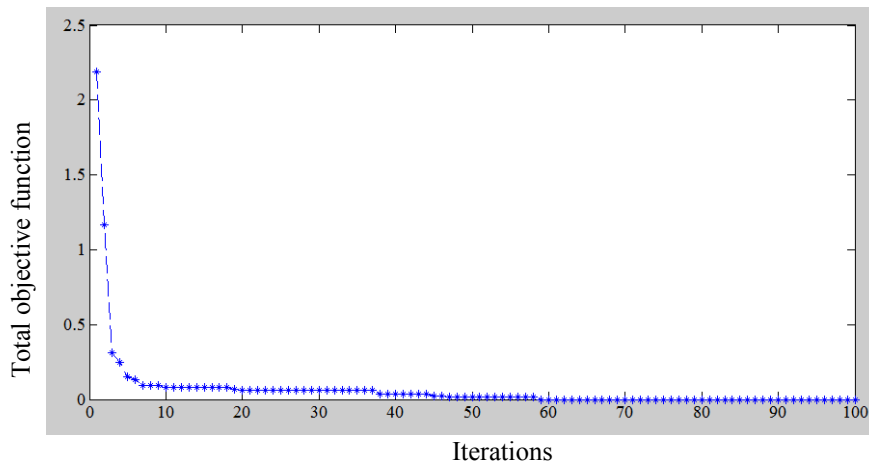

**Figure 16.** The variation of the total objective function with iterations for two damaged case

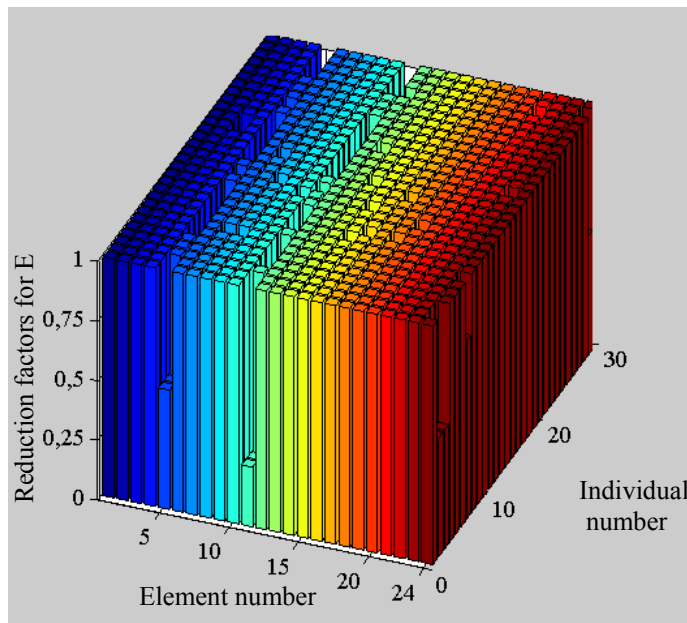

**Figure 17.** Reduction factors according to element number and individual number in the last population for two damaged case

**3.2.2.3. Three Damaged Case**

Although the number of individuals in the generation is 50, three damaged elements in the 24-bar space frame cause a significant increase in the number of iterations as seen from Fig. 18. Therefore, the total objective function is equal to zero after 180 iterations. The damage detection is performed successfully. As seen from Fig. 19, the reduction factors of element numbers 5, 11 and 17 in the individual No. 1 are 0.50, 0.25 and 0.50, respectively. It indicates that these



elements have 50%, 75% and 50% damages, respectively, which is also valid for the most of other individuals as shown in Fig. 19.

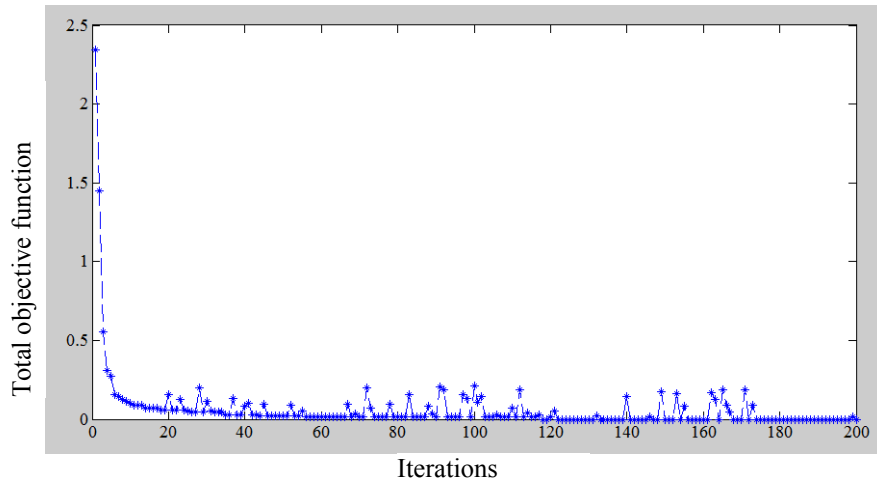

Figure 18. The variation of the total objective function with iterations for three damaged case

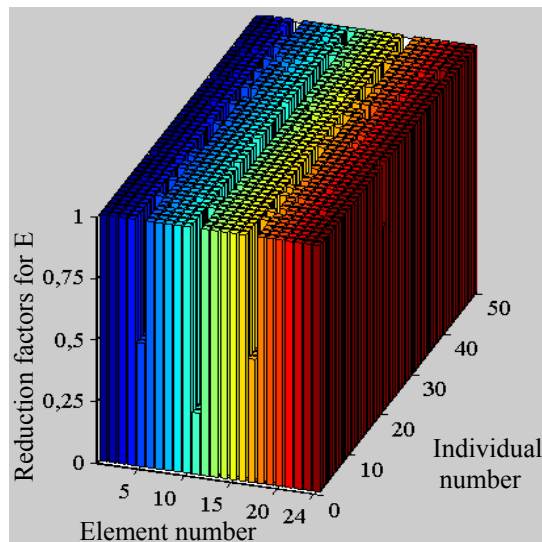

Figure 19. Reduction factors according to element number and individual number in the last population for three damaged case

### 3.3. Damage Detection Using Simulated Damaged Data with Noise

#### 3.3.1. 32-Bar Space Frame System

A 32-bar space frame system is shown in Fig. 20. The design parameters are the elastic modulus  $E=21000 \text{ kN/cm}^2$ , shear modulus  $G=8100 \text{ kN/cm}^2$  and material density  $\rho= 7.85 \text{ ton/m}^3$ . The

cross section profile of all columns is HE300A and its parameters are  $A=113 \times 10^{-4} \text{ m}^2$ ,  $I_z=1.826 \times 10^{-4} \text{ m}^4$ ,  $I_y=6.31 \times 10^{-5} \text{ m}^4$  and torsional constant  $J=8.78 \times 10^{-7} \text{ m}^4$ . Also, the cross section profile of all beams is IPE240 and its parameters are  $A=39.1 \times 10^{-4} \text{ m}^2$ ,  $I_z=3.892 \times 10^{-5} \text{ m}^4$ ,  $I_y=2.84 \times 10^{-6} \text{ m}^4$  and torsional constant  $J=1.3 \times 10^{-7} \text{ m}^4$ . Four reduction factors such as 0.25, 0.50, 0.75 and 1.00 are taken into account in GA analysis. A scenario with three damages are carried out. The element numbers 1, 5 and 9 have 50%, 25% and 75% damages, respectively. The parameters used in GA are; population size=30, crossover probability=0.90 and mutation=0.05.

In reality, natural frequencies obtained from experimental measurements include measurement noises which cause random error. In order to see the applicability of genetic algorithm based finite element model updating, some random noise should be artificially added to natural frequencies. In this example, noise effect is taken into account in the calculation of simulated damaged frequencies as determined in Eq. 5 [6, 12]. 1% random error [13] are added to these values obtained from SAP2000 and the relative errors with noise are shown in Table 6.

$$f_i^{\text{noisy}} = f_i (1 + \eta \xi) \quad i=1, \dots, n \tag{5}$$

where  $\eta$  is degrees of noise and  $\xi = \text{rand}(-1,1)$ .

**Table 6.** Natural frequencies (Hz) obtained from SAP2000 and MATLAB softwares

Mode	SAP2000			MATLAB	Relative error %  (a-b)/a  *100
	Noise free data Undamaged case (Hz)	noisy data		Undamaged case (Hz) (b)	
		Undamaged case (Hz) (a)	Three damaged case (Hz)		
1	1.583	1.587	1.413	1.601	0.87
2	1.864	1.871	1.803	1.900	1.48
3	2.030	2.037	1.998	2.078	2.02
4	3.430	3.444	3.368	3.450	0.38
5	5.130	5.153	4.893	5.180	0.51
6	5.572	5.589	5.454	5.624	0.61
7	7.021	7.036	6.838	7.196	2.27
8	7.309	7.337	7.227	7.474	1.86

It is observed from Fig. 21 that a large number of iterations are needed for identification of three damaged case with noise in the 32-bar space frame system. The convergence is obtained after 440 iterations and the difference between updated numerical model and simulated damaged model is minimized by GA. As seen from Fig. 22, the reduction factors of element numbers 1, 5 and 9 in the individual No. 30 are 0.50, 0.25 and 0.75, respectively. It means that these elements have 50%, 75% and 25% damages, respectively. This situation is also valid for most of other individuals shown in this figure.

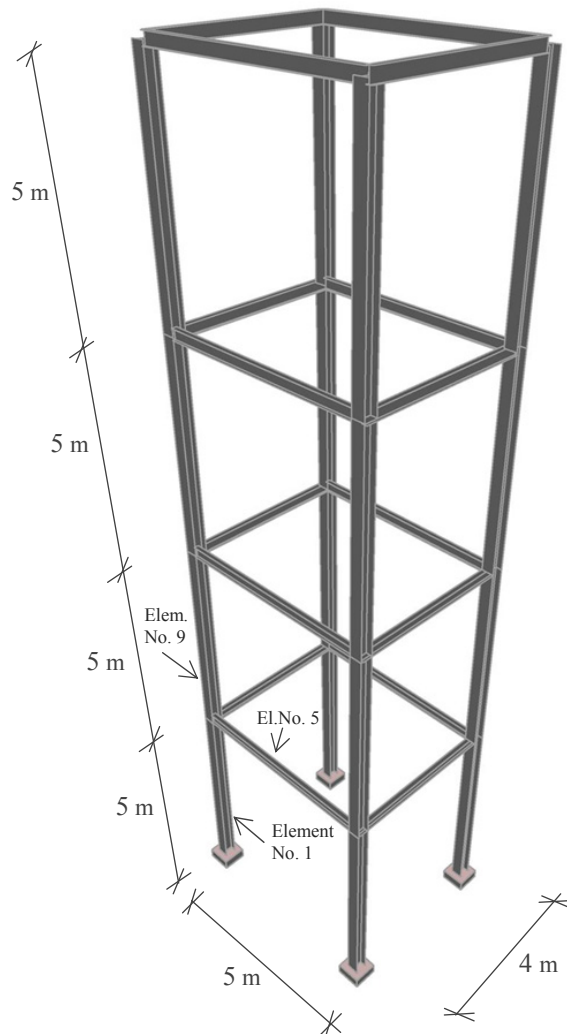
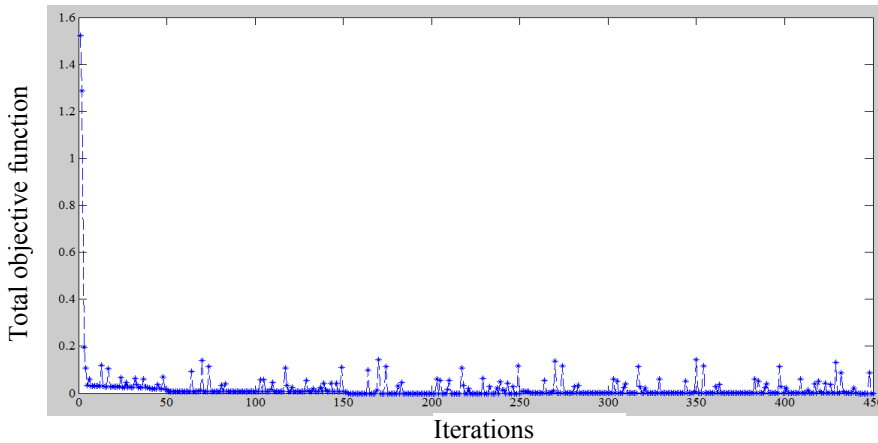
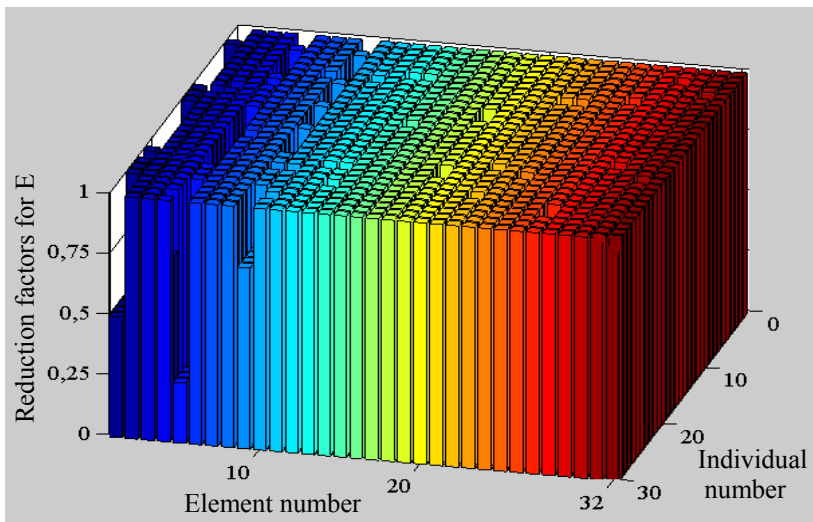

Figure 20. 32-bar space frame system



**Figure 21.** The variation of the total objective function with iterations



**Figure 22.** Reduction factors according to element number and individual number in the last population

**4. CONCLUSIONS**

Finite element model updating is used in Genetic Algorithm process to investigate the determination of simulated damages of space frames. In order to present the suitability of this method, various examples from simple to complex are carried out for several damaged cases. Also, the noise effect is taken into consideration. The results of Genetic Algorithm analyses are shown in two and three dimensional graphical formats. The results obtained from this study which show genetic algorithm method based finite element model updating is an appropriate method to determine damage location and severity, are briefly summarized below:

- The natural frequencies of a 30-element simulated continuous beam are determined by MATLAB and SAP2000 softwares. The results obtained from this study are verified by the results available in literature.
- A cantilever beam studied by Aktaşoğlu [27] previously is researched for one damaged case. Damaged element in 15-element beam are successfully detected at 40th iteration. Also, natural frequencies for damaged and undamaged cases in this study are very close to the results obtained by Aktaşoğlu [27].
- While one damage detection in the 8-bar space frame system is carried out with 13th iteration, three damage detection is obtained after 88 iterations. This situation is also observed in the other examples.
- In the last example, noise effect is considered and it is added to natural frequencies of the simulated space frame. So, determination of damages is carried out after 440 iterations.

## REFERENCES / KAYNAKLAR

- [1] C. Mares, C. Surace, An application of genetic algorithms to identify damage in elastic structures, *J. Sound Vib.* 195, 195-215, 1996.
- [2] J.-H. Chou, J. Ghaboussi, Genetic algorithm in structural damage detection, *Comput. Struct.* 79, 1335-1353, 2001.
- [3] A. Dutta, S. Talukdar, Damage detection in bridges using accurate modal parameters, *Finite Elem. Anal. Des.* 40, 287-304, 2004.
- [4] M. A. Rao, J. Srinivas, B.S.N. Murthy, Damage detection in vibrating bodies using genetic algorithms, *Comput. Struct.* 82, 963-968, 2004.
- [5] B. Jaishi, W.-Xin Ren, Damage detection by finite element model updating using modal flexibility residual, *J. Sound Vib.* 290, 369-387, 2006.
- [6] R. Perera, R. Torres, Structural damage detection via modal data with genetic algorithms, *J. Struct. Eng.* ASCE 132, 1491-1501, 2006.
- [7] H.M. Gomes, N.R.S. Silva, Some comparisons for damage detection on structures using genetic algorithms and modal sensitivity method, *Appl. Math. Model.* 32,2216-2232, 2008.
- [8] A. Esfandiari, F. Bakhtiari-Nejad, A. Rahai, M. Sanayei, Structural model updating using frequency response function and quasi-linear sensitivity equation, *J.Sound Vib.* 326,557-573, 2009.
- [9] H. Liu, K. Xin, Q. Qi, Study of structural damage detection with multi-objective function genetic algorithms, *Procedia Engineering* 12,80-86, 2011.
- [10] S. H. Sim, B. F. Spencer Jr., T. Nagayama, Multimetric sensing for structural damage detection, *J. Eng. Mech.*ASCE 137, 22-30, 2011.
- [11] F. Khoshnoudian, A. Esfandiari, Structural damage diagnosis using modal data, *Scientia Iranica A* 18, 853-860, 2011.
- [12] S.M. Pourhoseini Nejad, Gh. R. Ghodrati Amiri, A. Asadi, E. Afshari, Z. Tabrizian, Damage detection of skeletal structures using particle swarm optimizer with passive congregation (PSOPC) algorithm via incomplete modal data, *Comp. Meth. Civil Eng.* 3, 1-13, 2012.
- [13] A. Majumdar, D. K. Maiti, D. Maity, Damage assessment of truss structures from changes in natural frequencies using ant colony optimization, *Appl. Math. Comput.* 218, 9759-9772, 2012.
- [14] E. Asnaashari, J. K. Sinha, Crack detection in structures using deviation from normal distribution of measured vibration responses, *J. Sound Vib.* 333, 4139-4151, 2014.
- [15] T. Tang, X. Xie, Structural damage identification using virtual flexibility matrix I: simulation verification, *Solids and Structures (SAS)*, 3, 1-8, 2014.

- [16] MATLAB, The language of technical computing, The Mathworks Inc., Natick, USA, 2009.
- [17] SAP2000, Integrated software for structural analysis and design, Computers and Structures Inc., Berkeley, CA, USA, 2008.
- [18] D. E. Goldberg, J. H. Holland, Genetic algorithms and machine learning, Kluwer Academic Publishers, Machine Learning 3, 95-99, 1988.
- [19] Y.S. Erdogan, Damage detection and parameter identification by finite element model updating using genetic algorithms, Master Thesis, Istanbul Technical University, Istanbul, 2007.
- [20] A. Topcu, Computer aided numerical analysis lecture notes, Eskişehir Osmangazi University, 2013.
- [21] B.A. Zarate, J.M. Caicedo, Finite element model updating: Multiple alternatives, Eng. Struct. 30, 3724-3730, 2008.
- [22] M. Armutçu, Optimum design of plane frames using genetic algorithm, Master Thesis, Karadeniz Technical University, Trabzon, 1997.
- [23] Z. Aydın, Minimum weighted optimization of plane trusses with genetic algorithm, Graduation Thesis, Karadeniz Technical University, Trabzon, 1997.
- [24] A. Daloğlu, Z.Aydın, Optimum design of trusses for practical applications, Pamukkale University Journal of Engineering Sciences 5, 951-957, 1999.
- [25] S. Bekiroğlu, Optimum design of steel frame with genetic algorithm, Master Thesis, Karadeniz Technical University, Trabzon, 2003.
- [26] W.-X. Ren, G. D. Roeck, Structural damage identification using modal data. I: Simulation Verification, J. Struct. Eng. ASCE 128,87-95, 2002.
- [27] S. Aktaşoğlu, Damage detection in beam-like structures via combined genetic algorithm and non-linear optimisation, Master Thesis, Middle East Technical University, Ankara, 2012.