

INFLUENCE OF THE FABRIC PROPERTIES ON FABRIC STIFFNESS FOR THE INDUSTRIAL FABRICS

Mehmet Emin YÜKSEKKAYA

Uşak Uni.

Textile Engineering Department, Turkey

e-mail:mehmetemin.yukkekaya@usak.edu.tr

Thomas HOWARD

Auburn Uni.

College of Engineering, USA

Sabit ADANUR

Auburn Uni.

College of Engineering, USA

ABSTRACT

Flexural rigidity of a fabric is among the important properties, especially for industrial applications of high performance fabrics. The relationships between various fabric properties and fabric stiffness were analyzed. Several monofilament fabrics were tested in the warp direction for this purpose. It was found that there were close relationships between fabric stiffness and warp diameter, filling diameter, fabric modulus and fabric density. As yarn diameters and fabric modulus increase, the stiffness of fabric also increases. It was evident that fabric design has also an effect on fabric stiffness for the tested fabrics. The measured fabric stiffness values were compared with theoretical calculations that showed good agreement.

Key Words: Flexural rigidity, Stiffness, Industrial fabric

Received: 31.12.2007

Accepted: 29.08.2008

1. INTRODUCTION

The Flexural rigidity of fabric's bending stiffness is important for both consumer and industrial applications of fabrics. While fabric stiffness may not be wanted too high for a good drape in apparel and garment fabrics, it may be an important requirement especially for industrial fabrics to be used widely in heavy duty applications such as geotextiles and forming fabrics. For example, a forming fabric that easily bends under load and its own weight between the drive rolls may cause poor sheet formation during process.

Stiffness is one of the most widely used parameters to judge bending rigidity and fabric handling. Fabric stiffness and handling is an important decision factor for the end users. The degree of fabric stiffness is related to its properties such as fiber material, yarn and fabric structure. In this work, the effects of several fabric structural parameters on fabric stiffness were investigated.

Measurements of fabric handling and its reflection on the sensation felt by the user were originally done by Peirce (1). In his paper, Peirce described the stiffness and hardness of a cotton cloth. Later, Guthrie *et al.* (2) studied the bending and torsional rigidity of fibers with static and dynamic methods because the stiffness of a fabric is directly dependent on the stiffness of fibers. Cooper (3) gave analytical and

experimental results about the stiffness of fibers, yarn, and woven fabrics. His paper was based on the fundamental works done by Peirce and Guthrie.

Fabric stiffness influences the fabric deformation and sheds light on the mechanism of fabric deformation. The stiffness of fabrics is commonly measured along the warp and filling directions in a woven structure; however, it can be measured along any other direction as well. In the present work, fabric stiffness is measured in the warp direction which is the working direction of the fabric on most of the cases.

2. ANALYTICAL

When a straight beam is bent either under its own weight or by an external load, the initial straight longitudinal axis is deformed and this curve is called the deflection curve of the beam. When a beam (fiber bundle or fabric) is subjected to bending, the fibers on one side elongate, while the fibers on the other side shorten. These changes in length cause the beam to deflect. All points on the beam except those outside the supports fall below their original position as shown in the Figure 1. The general equation for the deflection curve of a beam was analyzed by Gere *et al.* (4), Nash (5), and Tuma (6). For linearly elastic materials, the deflection curve is also called elastic curve, which is

the curve taken by neutral axis. A beam bent to a circular curve of constant radius has a constant bending moment.

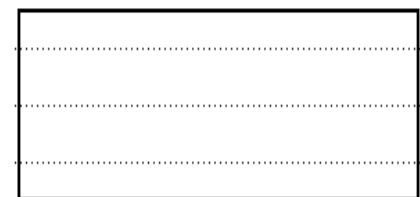

a) Straight

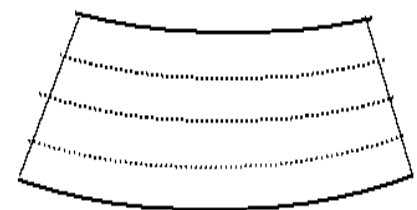

b) Bended

Figure 1. Schematic representation of a bending beam

In this work, deflection of fabrics under their own weight is analyzed both theoretically and experimentally. Considering Figure 2, the deflection, u , of the beam at any point m_1 at distance x from the origin is the displacement of that point in the y direction, measured from the x axis to the point to the deflection curve. On the other hand, the

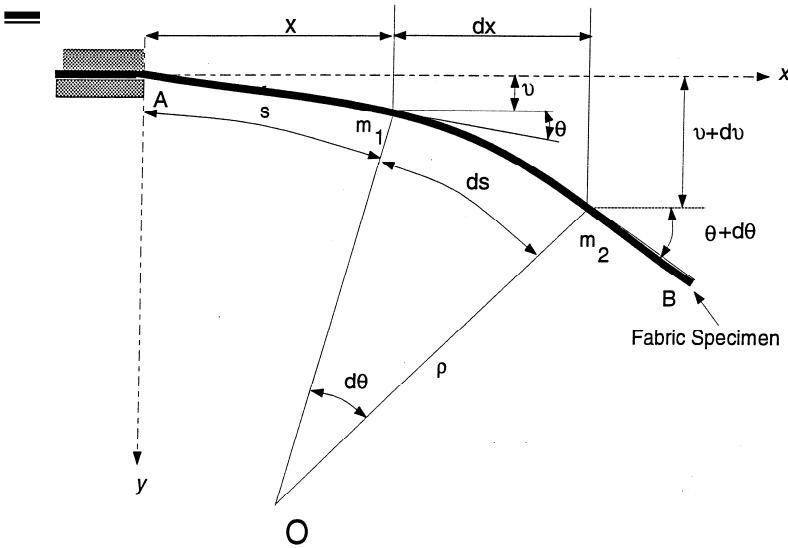

Figure 2. Graphical representation of fabric bending

angle of rotation θ of the fabric beam at the point m_1 is the angle between the x-axis and the tangent to the deflection curve. The second point on the fabric beam curve m_2 is located at a small distance ds further along the curve and at distance $x+dx$ and the angle of rotation, $\theta+d\theta$. The slope of the deflection curve is given by

$$\frac{dv}{dx} = \tan \theta \quad (1)$$

Equation 1 is based on the geometric considerations, and it can be applied to a beam of any material. The center of the beam is O , and the radius of curvature is ρ . The relationship between the rotation angle, θ , and the length of the beam is called curvature and is given by

$$\kappa = \frac{1}{\rho} = \frac{d\theta}{ds} \quad (2)$$

i.e., the curvature is the rate at which the angle θ is changing with respect to the length of arc s . Beams made of very stiff materials undergo only very small rotations; therefore, their deflection curves are very flat with extremely small curvatures. For very small rotation angle, $ds = dx$ may be accepted since for small angles $\cos \theta \approx 1$. Therefore, Equation 2 may be rewritten as follows:

$$\kappa = \frac{d\theta}{dx} \quad (3).$$

However, for most textile materials, the value of the rotation is very high. For that reason, Equation 3 is not valid for those textile materials whose beams are highly flexible. If the material of beam is linearly elastic and follows Hooke's law, the curvature is given by

$$\kappa = \frac{1}{\rho} = -\frac{M}{EI} \quad (4)$$

where M is the bending moment, E is the modulus of the material, and I is the moment of inertia. A bending moment that bends a beam convex upward (compression stress on bottom fiber) is negative. For the purpose of the present analysis, it is assumed that fabrics, which are made of high tenacity stiff polyester monofilament, are homogeneous and obey Hooke's law. To find the angle of rotation, θ , or the deflection, v , provided that the bending moment M known. The following differential equation of the deflection curve can be used:

$$\frac{d\theta}{dx} = \frac{d^2v}{dx^2} = -\frac{M}{EI} \quad (5).$$

The term EI is known as the bending rigidity of the material. The slope, θ , at the free end B of the cantilever beam with constant EI and loaded with its own weight can be determined as follows:

$$\theta = -\int_0^L \frac{M}{EI} dx = -\int_0^L \frac{qx^2}{2EI} dx = -\frac{qL^3}{6EI} \quad (6)$$

where L is the length of the beam and q is the intensity of the load. The deflection, v , is given by

$$v = -\int_0^L \frac{Mx}{EI} dx = -\int_0^L \frac{qx^3}{2EI} dx = -\frac{qL^4}{8EI} \quad (7)$$

3. EXPERIMENTAL

The flexural rigidity is related to the tensile modulus for a simple body, as in the case of a single fiber; however, this relationship is not so straightforward in the case of a fabric. To measure the fabric stiffness, the cantilever method is widely used in practice. The bending rigidity of a fabric is given by

$$G = wc^3 \quad (8)$$

where w is the fabric weight per unit area and c is the half of the fabric bending length. The fabric bending length is measured by using cantilever stiffness measurement equipment developed by Shirley Institute. As shown in Figure 3, a piece of fabric whose width is 25.4 mm is placed on top of the cantilever. Then, it is moved slowly until the edge of the fabric reaches the inclined plane. The angle of the inclined plane is 41.5° . The stiffer the fabric, the greater is the length necessary to ensure sufficient bending. Furthermore, the density of the material, the bending modulus, and the thickness affect the stiffness of the fabric. The bending rigidity for an isotropic material is given by

$$G = EI \quad (9)$$

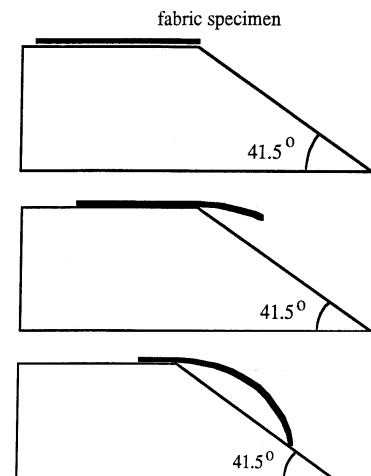

Figure 3. Schematic representation of stiffness tester

Table 1. Physical properties of the industrial fabrics

Sample Number	Warp Density (1/cm)	Warp Diameter (mm)	Warp Linear Density (Tex)	Weft Density (1/cm)	Weft Diameter (mm)	Weft Linear Density (Tex)	Weight of Fabric (gr/m ²)	Flexural Rigidity (mg.cm) x10 ⁻⁴	Modulus of Fabric (N/m)
1	40	0.112	13.68	35	0.140	21.38	132	0.575	4.42
2	39	0.112	13.68	37	0.112	13.68	104	0.825	5.57
3	40	0.140	21.38	36	0.180	35.33	216	1.150	5.63
4	39	0.140	21.38	31	0.205	45.83	228	1.150	6.04
5	38	0.154	25.86	25	0.164	29.33	174	1.050	6.18
6	38	0.154	25.86	27	0.150	24.58	165	1.100	6.36
7	39	0.154	25.86	25	0.164	29.33	175	2.650	6.17
8	37	0.171	31.89	27	0.180	35.33	215	1.400	6.29
9	36	0.171	31.89	27	0.230	57.69	271	1.650	6.74
10	35	0.171	31.89	21	0.205	45.83	209	2.550	7.20
11	37	0.171	31.89	19	0.170	31.52	178	2.950	9.58
12	35	0.205	45.83	18	0.309	104.13	345	4.050	10.42
13	34	0.205	45.83	19	0.309	104.13	353	4.250	9.72
14	35	0.205	45.83	18	0.250	68.16	282	4.800	10.26
15	32	0.245	65.46	17	0.300	98.15	374	4.950	9.24
16	33	0.245	65.46	17	0.320	116.67	410	5.250	9.41
17	31	0.261	74.29	16	0.333	120.93	420	5.100	9.79
18	31	0.261	74.29	15	0.309	104.13	385	6.000	9.17

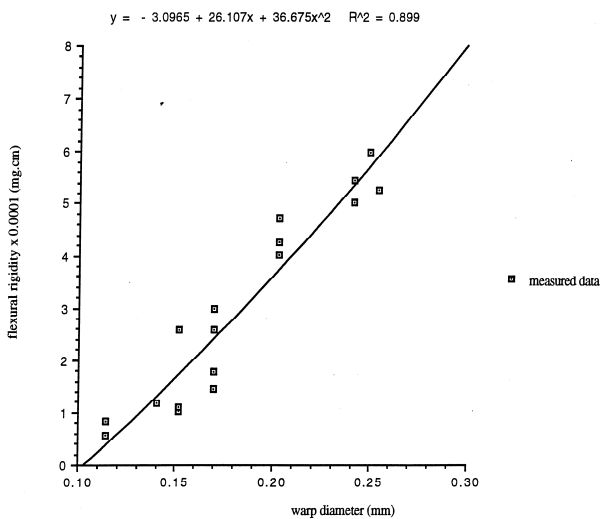

Figure 4. Effects of warp diameter on the flexural rigidity

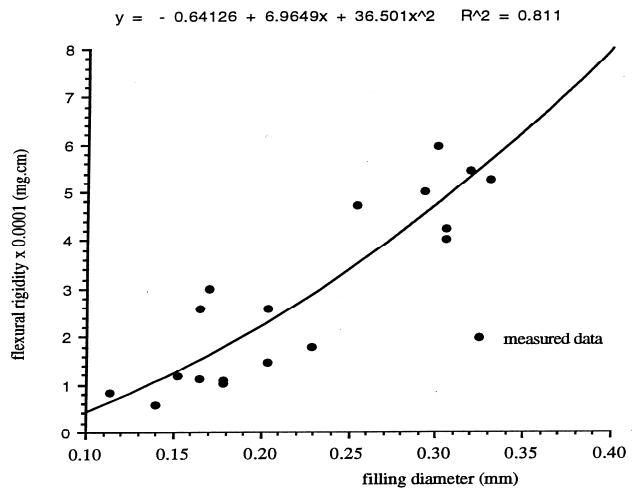

Figure 5. Effects of weft diameter on the flexural rigidity

Eighteen different industrial fabric types were used in the stiffness measurement whose properties are given in Table 1. The fabrics were made of stiff polyester monofilament yarns and heatset to relieve the internal stresses. The modulus of the fabrics was supplied by the manufacturer. To calculate the flexural rigidity of the fabric in the warp direction, the standard ASTM (7) test method D-1388 was used. Bending rigidity was measured on both sides of fabrics and the average was taken to be the bending rigidity of the fabric. The rotation angle, θ , and the deflection, u , were measured for every 25, 50, 75, 100, 125, 150, 175, 200,

225, and 250 mm overhang length of the fabric. The deflection, u , was also calculated using Equation 7. The agreement between the theory and experiment was reasonably good to ensure that ASTM test method D-1388 is valid for thick fabrics that were tested.

To investigate the relationship between the properties of fabrics and their flexural rigidity, warp diameter, filling diameter, number of warp yarns per unit length, number of filling yarns per unit length, total number of yarns per unit area, and modulus of fabric versus the measured flexural rigidity

are plotted. These graphs are given Figures 4 through 9. A curve is fitted to each data set and the corresponding mathematical equation was determined using the least square method to identify the relationship (8). The correlation for each function is also computed.

4. RESULTS AND DISCUSSION

As shown in Figures and statistical analysis, there is a good agreement between analytical and experimental results. These figures show the deflection versus overhang length of the specimens.

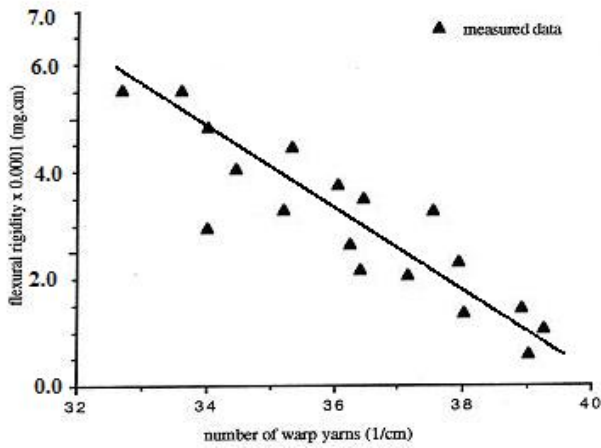

Figure 6. Effects of warp density on the flexural rigidity

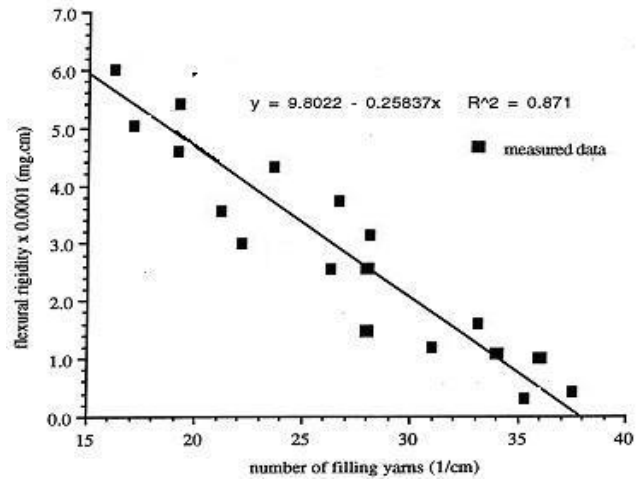

Figure 7. Effects of weft density on the flexural rigidity

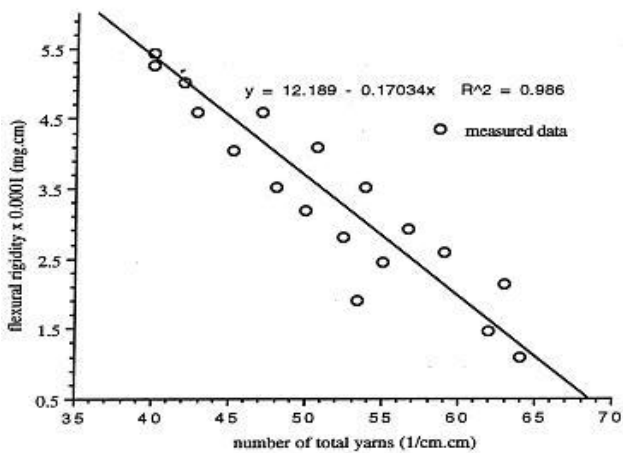

Figure 8. Effects of total yarn density on the flexural rigidity

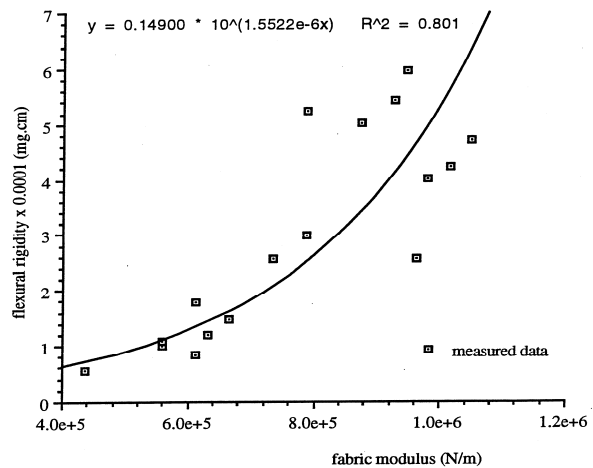

Figure 9. Effects of fabric modulus on the flexural rigidity

Figure 4 shows the relationship between the diameter of warp yarn and the flexural rigidity of the fabric from measurements. Since the flexural rigidity of a fabric depends on the yarn properties, the diameter of the yarn should have a significant effect on the flexural rigidity of the fabric. A second-degree relation was found between these two quantities by using the linear regression analysis method. The coefficient of determination, R^2 , was found 0.899, which means that there is a good functional relation between the warp diameter and the flexural rigidity. It should be noted that the flexural rigidity of the specimen was measured in the warp direction.

A similar effect was noted between the filling diameter and fabric stiffness: as the filling diameter is increased, the fabric flexural rigidity is increased as shown in Figure 5. This is because, as the filling diameter is increased, more crimp is given to the warp yarn in the plane perpendicular to the fabric surface. This increased the stiffness of the fabric structure as a whole. The coefficient of determination was again high.

The number of warp and filling yarns had an inverse relationship with the forming fabric flexural rigidity as shown in Figures 6 and 7. This is expected

because, due to the nature of the monofilament forming fabric design, as the number of warp and filling yarns are increased, their diameters have to be decreased in order to maintain an equivalent percent open area (and therefore air permeability) which is the most important property of forming fabrics in paper making. In Figure 6, the filling yarn diameter was kept constant and the warp diameter was decreased as the number of warp yarns per unit length was increased. If the numbers of warps per unit length were increased without decreasing the warp diameter, then the fabric stiffness would increase. Similarly, in Figure 7,

the warp diameter was kept constant and the filling yarn diameter was decreases as the number of filling yarns per unit length was increased. The relation between the number of filling yarns and fabric flexural rigidity could be represented by a straight line reasonably well while an interpolation had to be done to find a curve for the relation between number of warp yarns and fabric flexural rigidity. Figure 8 shows the flexural rigidity versus total number of warp and filling yarns per unit area of fabric. Because of the lower diameter yarns used, the flexural rigidity decreases as the number of yarns is increased.

A monofilament strand is stiffer (has higher flexural rigidity) than a staple yarns or continuous filament of the same linear density. Therefore, a fabric made of monofilament strand is stiffer than a fabric made of staple or continuous filament yarns of the same count. If a monofilament yarn is divided into portions, then the stiffness of the assembly will be reduced. It is the smallness of diameter of the individual fiber that gives flexibility to textile materials. This is because relative movement of fibers in the yarn affects the shear characteristics that result in reducing the total bending stiffness. Freedom of movement of fibers in the yarn or fabric reduces stiffness and increases flexibility. Therefore, to increase stiffness or reduce flexibility,

the amount of shear energy that can be transmitted from one fiber to its neighbor should be increased; i.e. the fibers should not be able to slip over one another (9). In textile materials, the fibers are held together by frictional forces arising from the disposition of the components in the structure. Therefore, a high twist yarn is stiffer than a low twist yarn and a sized yarn is stiffer than an unsized yarn. Consequently, a fabric made of sized yarns is much stiffer than a fabric made of unsized yarns. Similarly, highly twisted yarns will make a fabric stiffer than a fabric made of low twist yarns. A monofilament yarn can be considered to be like a continuous filament yarn in which all the fibers are glued together with no relative movement or sliding. That is why a monofilament fabric is very stiff compared to fabrics made of staple or continuous filament yarns even if they are highly twisted or sized.

In a fabric structure, yarns exert forces on each other at the knuckle points. A tight fabric structure in which considerable yarn tensions are involved becomes stiff. A loosely woven structure is usually flexible and soft. It allows yarns to move more easily over one another at the crossovers that make shear deformation easier.

Another observation was that the running attitude of the fabric also affects its bending behavior. As mentioned

earlier, all the specimens were tested in the warp direction. For the long warp knuckles being on the up or down side of the fabric during the tests made a difference in flexural rigidity. The "front" of the fabric is the side on which the long warp knuckle is located. When the long warp knuckle was down, the fabric was easier to bend resulting in low flexural rigidity. When the long warp knuckle was up, fabrics exhibited larger flexural stiffness. The differences in some samples were drastic up to 600 percent.

5. CONCLUSIONS

Bending stiffness characteristics of fabrics arise from the structure of the fabric itself as well as from the structure of the constituent yarns. A stiff yarn like a wire makes a fabric stiff regardless of the weave. However, using flexible strands, one can produce fabrics with a wide range of stiffness, depending on the fabric structure. In this study, analytical relations have been found between fabric stiffness (or flexural rigidity) and various fabric structural parameters. Yarn (or fiber) diameter is the most important structural property of a fabric to affect its stiffness. As the fiber or yarn diameter is increased, the fabric stiffness increases.

REFERENCES

1. Peirce, F. T., 1930, "The Handle of Cloth as a Measurable Quantity", *J. Text. Int.* T377-T416.
2. Guthrie, J. C., Morton, D. H., and Oliver, P. H., 1954, "An Investigation Into Bending and Torsional Rigidities of Some Fibers", *J. Text. Int.* T912-T928.
3. Cooper, D. N. E., 1965, "The Stiffness of Woven Textiles", *J. Text. Inst.* T317-T335.
4. Gere, J. M., 2003 *Mechanics of Materials*, 5nd Edition, PWS Engineering, Boston, Massachusetts.
5. Nash, W. A., 1972, *Strength of Materials*, 2nd Edition, McGraw-Hill, New York.
6. Tuma, J. J., 1993, *Structural Analysis*, McGraw-Hill, New York.
7. Standard Test Methods for Stiffness of Fabrics, D1388, *American Society for Testing and Materials (ASTM) Book of Standards*, Section 7, Vol 07.01, Philadelphia, 1993.
8. Montgomery, D. C., 2005, *Design and Analysis of Experiments*, 6th Edition, John Wiley & Sons, New York.
9. Lord, P. R. and Mohamed, M. H., 1982, *Weaving: Conversion of Yarn to Fabric*, Merrow Technical Library.

Bu araştırma, Bilim Kurulumuz tarafından incelendikten sonra, oylama ile saptanan iki hakemin görüşüne sunulmuştur. Her iki hakem yaptıkları incelemeler sonucunda araştırmanın bilimselliği ve sunumu olarak "Hakem Onaylı Araştırma" vasfıyla yayımlanabileceğine karar vermişlerdir.
