



Usak University

Journal of Engineering Sciences

An international e-journal published by the University of Usak

Journal homepage: dergipark.gov.tr/uujes



Research article

EVALUATION OF THE SEISMIC BEHAVIOR OF THE HISTORIC CLANDRAS BRIDGE

Soner Şeker*, Hakkı Şahin

Department of Civil Engineering, Uşak University, Uşak, Türkiye

Received: 10 January 2022

Revised: 19 January 2022

Accepted: 25 January 2022

Online available: 30 June 2022

Handling Editor: Jülide Öner

Abstract

Historical masonry arch bridges are one of the most important structures that convey the cultural heritage of past civilizations to the present. Historical masonry arch bridges were one of the most important elements of transportation and architecture in the past. These structures can be damaged by many natural disasters such as earthquakes, floods, etc. from the past to the present. It is necessary to carry out the necessary studies in order to protect these bridges as they were built and to transfer them safely to future generations. It is clear that determining the earthquake behavior of these bridges, which are exposed to different geometrical properties, materials and loading conditions, will increase the effectiveness of the strengthening works to be done. In this study, the seismic behavior of the Uşak Clandras Bridge, which is a historical masonry arch bridge, was investigated by linear and non-linear time history analysis. Firstly, the 3D model of the masonry bridge was created with the Abaqus program. To simulate the more real behavior of the structure, a detailed survey was carried out. For the characteristic features of the materials used in the bridge, studies in the literature were taken into consideration. Acceleration records of 1999 Kocaeli Earthquake were used in dynamic analyses.

Keywords: Historical Masonry Arch Bridge; linear and non-linear time history; seismic behavior.

©2022 Usak University all rights reserved.

1. Introduction

Historical masonry structures are the cultural heritage of states. One of the most important legacies is undoubtedly the bridges. Arch bridges of the masonry type are found in many of the ancient civilizations. It is seen that masonry arch bridges were used extensively in the 18th and 19th centuries, when engineering was not developed compared to today. In our country, there are many historical masonry bridges that were built in different periods

*Corresponding author: Soner ŞEKER

E-mail: soner.seker@usak.edu.tr (ORCID: 0000-0002-7632-9713)

DOI: <https://doi.org/10.47137/uujes.1055725>

©2022 Usak University all rights reserved.

and have reached the present day. The construction of arch-type masonry bridges in Anatolia started especially in the Ottoman period. The stone arch bridges that have survived until today have been under the effects that can cause physical damage at different times. Bridges are partially or completely damaged under natural or man-made effects such as earthquakes, landslides and floods. Earthquake is the most important factor that damages historical structures. The reason for this is that there are many active faults in our country. In the literature, there are many studies on the seismic behavior of historical bridges. In the study conducted by Bayraktar et al. [1], the dynamical characteristics of a highway bridge in Trabzon Of district were determined theoretically and experimentally by finite element analysis and Operational Modal Analysis (OMA) method. By changing the material properties, the differences between the theoretical and experimentally determined dynamic characteristics are eliminated. The 3D model of the Kömürhan Bridge on the Malatya-Elazığ highway was created by Bayraktar et al. [2] in the SAP2000 program and its analytical analysis was carried out. It was seen that the frequency values obtained as a result of analytical and experimental modal analyzes of the bridge were close to each other and the first fourteen frequencies were in the range of 0-14Hz. Coşandere (Kınalı) bridge located in Maçka district of Trabzon was modeled in 3D by Ural [3] in the SAP 2000 structural analysis program and FE analysis was performed. As a result of the analysis, it was seen that the stresses are concentrated in the apex of the arch bridge under dynamic loads. Türker et al. [4] experimentally determined the dynamic behavior of a 1/10 scale model of a stone bridge, which is frequently encountered in practice, in a laboratory environment. In addition, the dynamic behavior of the bridge was determined theoretically by performing modal analysis on the 3D model of the bridge in the SAP2000 program. As a result of the analysis, it was predicted that the differences between the theoretical results and the experimental results were caused by the material properties and boundary conditions. Özmen and Sayin [5] carried out linear dynamic analysis of a historical masonry arch bridge with ANSYS finite element program and investigated the behavior of the bridge under the influence of earthquakes. The displacements of the bridge and the maximum and minimum principal stresses were obtained from the analyzes and the seismic responses of the bridge were evaluated. Korkmaz et al. [6] modeled the Timisvat historical bridge with the finite element method and performed dynamic analyzes in the time history with earthquake acceleration records on the model. As a result of the analyses made in the time history, the displacement and stress values of each earthquake record were found. As a result of the analysis, it has been determined that the greatest stresses occur in the big arch. In this study, 3-dimensional finite element models of the single-arch historical Şenyuva Bridge was created and the double-span historical Ottoman Bridge using the ANSYS program and obtained the theoretical dynamic characteristics. As a result of the analysis, it was concluded that the OMA method can be used safely in the finite element model improvement process [7]. Ercan and Nuhoğlu [8] investigated the seismic behavior of a historical three-span bridge using destructive and non-destructive methods and theoretical analysis. As a result of the analyzes, it was determined that in a severe earthquake that may occur in the direction perpendicular to the bridge length, damage in the form of cracks may occur in the middle arch, which has the largest opening, in the direction perpendicular to the deck. Luca Pelà et al. [9] evaluated the seismic performance of existing masonry arch bridges using nonlinear static analysis as recommended by several modern standards such as UNI ENV 1998-1 2003, OPGM 3274 2004 and FEMA 440 2005. As a result of the evaluations, it was concluded that the typical upper node of the structure is not suitable for defining the seismic capacity of the bridge. G.D. Hatzigeorgiou et al. [10] presented a finite element method for the analysis of historical masonry structures exhibiting linear elastic or inelastic material behavior under static or dynamic loading. This method was used to analyze the response of the historic Arta bridge to static and seismic loads under planar

stress conditions. From the various analyses one can conclude that the probable ground subsidence at one or more pier supports and the seismic excitation stress the bridge considerably creating damage at critical areas. Hökelekli and Yilmaz [11] investigated the in-plane and out-of-plane non-linear structural responses of the walls of a historical stone arch bridge built in 1787 in Bartın, Turkey. As a result of the analysis, cohesive interface behavior was found to significantly affect the spandrel wall response under in-plane and out-of-plane seismic forces. Çoruhlu et al. [12] aimed to determine the theoretical dynamic characteristics of historical stone arch bridges and to develop an empirical formula for the calculation of their natural frequencies using the FE Method. They concluded that the developed formula for the frequency calculation of stone arch bridges could be used to obtain a reference. Altıok and Demir [13] Altıok and Demir, the seismic behavior of the historical Lala Mehmet Pasha minaret was investigated by considering the Soil-Structure Interaction (SSI). The initial finite element (FE) model was updated according to the data obtained from the operational modal analysis (OMA) method. Embedded and SSI models are generated by Abaqus, then linear (LTH) and nonlinear time history (NLTH) analyses were performed. The effects of linear and nonlinear analyzes on structural behavior were also investigated. The results show that the soil media has an important effect on damage situations, displacements, and stress distributions. Nohutcu et al. [14] investigated the earthquake damage and collapse mechanism of the historical stone masonry minaret "Hafsa Sultan" built in 1522. Numerical and experimental dynamic analyses of the minaret were carried out. Linear time history (LTH) and nonlinear time history (NLTH) analyses were carried out using two different ground motions. Concrete Damage Plasticity (CDP) model was selected for non-linear analyses. As a result of the analyses, it was determined that the existing damage was compatible with the nonlinear analyses results. Demir et al. [15] investigated the effects of model calibration on the seismic behavior of the historic masonry Hafsa Sultan mosque. Seismic analyses of calibrated and noncalibrated numeric models were carried out by using acceleration records of Kocaeli earthquake in 1999. The results of the analyses show that the damage status of the structure can be determined more accurately as a result of calibrating the dynamic characteristics of the structure with OMA. Demir and Altıok [16] investigated the seismic behavior of the concrete Selimiye minaret, which was damaged in the 30 October 2020 Izmir (Seferihisar-Samos) Earthquake. The nonlinear finite element model was created using the Concrete Damage Plasticity failure model. As a result of the analysis, the damages in the transition section of the minaret were confirmed by the finite element method. In this study, Hökelekli et al. [17] examined the damage model by updating the finite element models (FEM) of the historical Alaca minaret under different ground motions, depending on the operational modal analysis (OMA) test. Concrete Damage Plasticity model was taken into account in non-linear seismic analyses. As a result of the analyses, it was seen that the linear analysis results were not as realistic as the non-linear analysis results.

The aim of this study is to determine the seismic behavior of the historical stone arch Clandras Bridge by analytical methods and to simulate the damage distribution that will occur on the bridge. As a result of the analysis, plastic deformations, damage distributions and relative displacements in the model were obtained.

2. History of Clandras Bridge

Clandras Bridge is a historical bridge from the Phrygian period, located in the Karahallı district of Uşak province. The bridge was built on the Banaz Stream about 2500 years ago. The two ends of the bridge sit on the half of the mountain rocks. The bridge is also known as Cılandras in official sources. The original of the bridge is an aqueduct. It is located at the beginning of the canals carrying water to the city of Pepeuze, which is approximately 1 km

away. The bridge has been repaired with concrete in recent years and has lost its originality. Clandras Bridge is shown in Figure 1.



Fig.1 Bridge of Clandras

3. Geometric Properties of Clandras Bridge

The 3D model of the Clandras Bridge was prepared according to the General Directorate of Highways Restoration Project. The restoration project and 3D model of the bridge are shown in Figure 2.

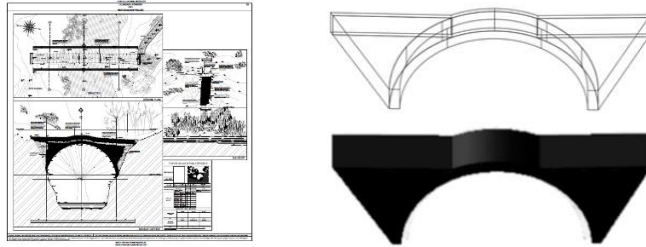

Fig.2 Restoration Project and 3D Model

The length of the bridge is 21.70 meters, its depth is 17 meters, and its width is 1.96 meters. The arch of the bridge is in the form of a pulley. Arch radius is 6.37 m. The arch thickness is 0.71 m. In Figure 3, the bridge drawings are shown together with the dimensions.

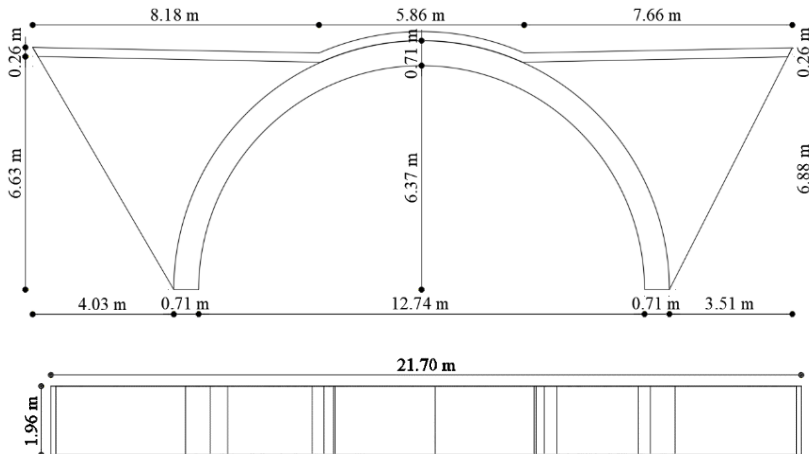

Fig.3 Bridge Drawings

4. Material Properties

Clandras Bridge is a historic stone arch bridge. The faces of the stones were engraved with pencils and the large stones of the arches were firmly clamped together with a mortise. The bridge was built with the embarkment technique on a fixed rock consisting of two main bodies, which are called elephant feet. Since destructive tests are not allowed on the bridge, the mechanical properties of the materials were taken from the studies conducted by Hökelekli and Al-Helwani [18], Altıok [19] and Şahin [20]. The mechanical properties of the materials are presented in Table 1.

Table 1 Mechanical Properties of Material

Material	Weight Per Unit Volume (kg/m ³)	Modulus Of Elasticity (MPa)	Poisson Ratio (ν)	Compressive Strength (MPa)	Tensile Strength (MPa)
Stone	1900	4400	0.15	7.42	0.74

The Concrete Damage Plasticity (CDP) model is a continuous damage model based on plasticity. The CDP model is based on two major damage mechanisms. These damage mechanisms are tensile cracking and pressure breakage in concrete. The CDP model is a model developed for dynamic and repetitive loads. In particular, it is suitable under loading and unloading conditions and for applications where the material is damaged and therefore for dynamic analysis [18]. As shown in Figure 4, a different inelastic behavior can be demonstrated in tension and compression [21]. The CDP model can also be used for the nonlinear behavior of masonry construction provided that appropriate parameters are used. The material properties used in the concrete damage plasticity model are presented in Table 2 and Table 3. [18]

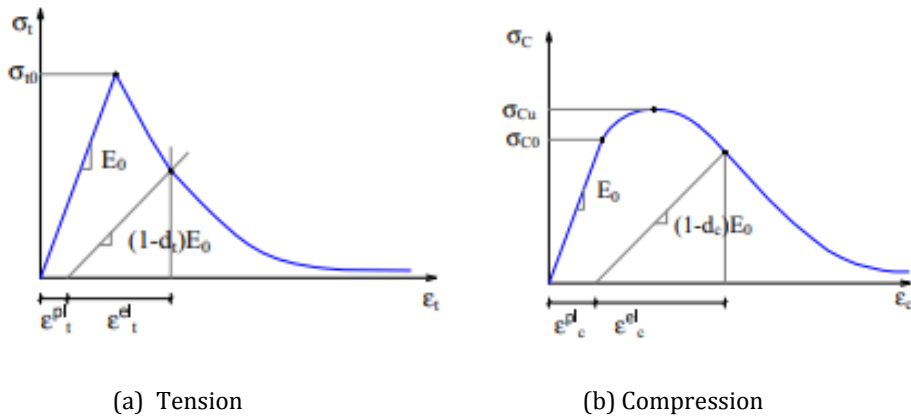

Fig. 4 CDP Tension and Compression Graphs

Table 2 Concrete Damage Plasticity Parameters (CDP) [18]

Dilation angle	Eccentricity	σ _{bo} /σ _{co}	K	Viscosity
10	0.1	1.166	0.666	0.001

Table 3 Stress and Inelastic Strain Values Used in the Concrete Failure Plasticity Model for Masonry [18]

Compression		Tension	
σ_c (MPa)	Plastic Strain	σ_t (MPa)	Plastic Strain
2	0	0.2	0
2	0.0015	0.02	0.0025
0.2	0.005	0.02	0.01
Damage in Compression		Damage in Tension	
d_c	Plastic Strain	d_t	Plastic Strain
0	0	0	0
0.95	0.005	0.95	0.005

5. The Strong Ground Motion

Within the scope of time-history analysis of the minaret, considering the possibility of an earthquake with a magnitude of $M_w=7.0$ in Uşak; Acceleration records of 1999 Kocaeli ($M_w: 7.4$) earthquake were used. The peak ground acceleration value of the 1999 Kocaeli Earthquake is about 0.4g. 1999 Kocaeli Earthquake acceleration-time, velocity-time and displacement-time graphs are presented in Figure 5.

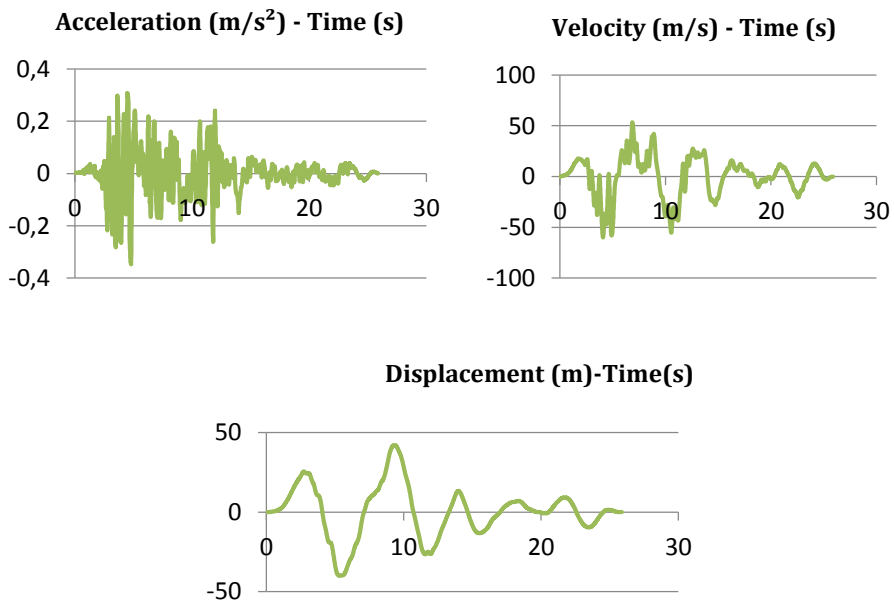

Fig. 5 Kocaeli Earthquake Acceleration-Time, Velocity-Time and Displacement-Time Graphs

6. FE Model

3D finite element model of Clандras Bridge was prepared in AutoCAD [22] program. The 3D model was prepared according to the restoration project of the bridge so that the analyses are realistic. The FE analysis of the bridge was carried out by transferring the "sat" file of the prepared model to the Abaqus v6.14 [23] program. In the finite element model, 46978 nodes and 30901 tetrahedral, C3D10 type elements are used. The C3D10 element is a general purpose tetrahedral element (4 integration points). Before the FE analysis, first the optimal mesh size is determined. Analyzes were carried out from 0.60 m mesh size to 0.10 m mesh size with a difference of 0.10 m. As a result of the analysis, the optimum mesh size was chosen as 0.30 m. The results obtained after the analysis are presented in Table 4.

Table 4 Mesh Values, Number of Elements, and Mode 1 Frequency Values

Mesh Size (m)	Number of Elements	Mode 1 Frequency Values
0.6	4146	11.046
0.5	7203	11.042
0.4	13469	11.038
0.3	30901	11.036
0.2	93547	11.034
0.1	363116	11.030

Using the values in Table 6.1, the convergence analysis results are presented in Figure 6.

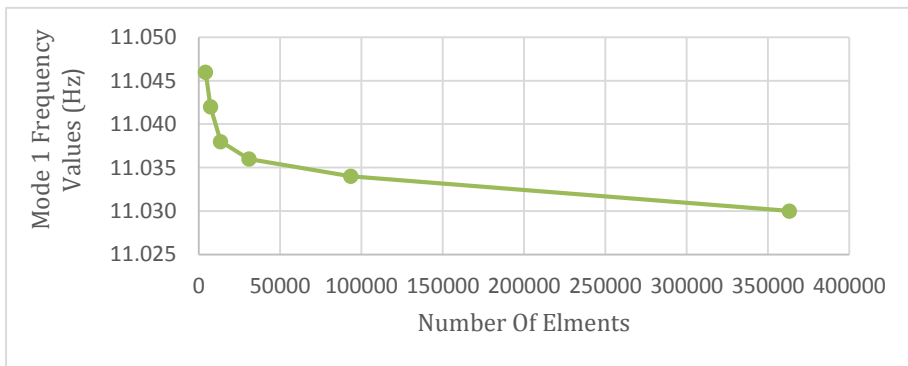

Fig. 6 Convergence Analysis

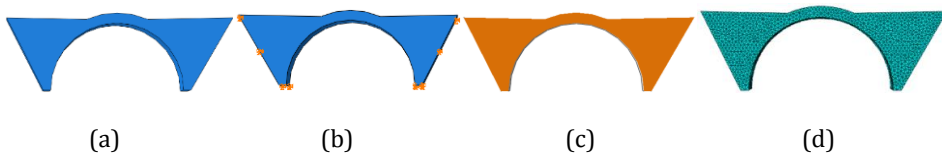

Fig. 7 a) Solid Model, b) Support Conditions, c) Cross Section View, d) Mesh View

In Figure 7, there are some pictures of the finite element model of the bridge. As can be seen in Figure 7[a], displacement is restricted in the x, y and z directions on the surfaces of the bridge resting between two rocks. The first five numerical frequency values of the bridge are presented in Table 5 and the mode shapes are presented in Figure 8.

Table 5 Modal Analyses Results

Modes	1.	2.	3.	4.	5.
Frequency (Hz)	11.036	21.749	24.737	30.317	34.494

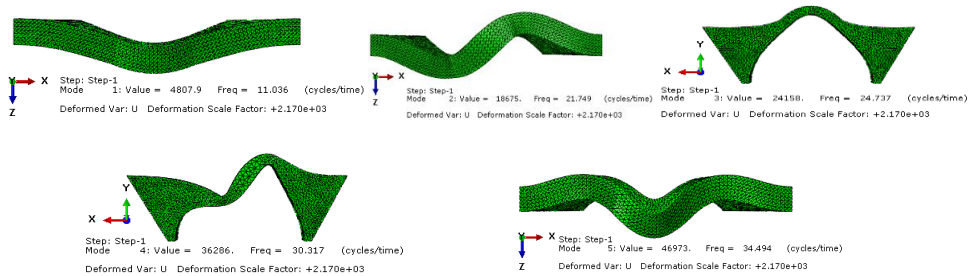

Fig. 8 First 5 Mode and Frequency Values

7. Nonlinear Analysis Results FE Model

Seismic damage and failure mechanism were investigated by non-linear analysis on the FE model of the bridge. The Concrete Damage Plasticity (CDP) model has been adapted to masonry structures with appropriate parameters. The material parameters to be used in the analysis to examine the nonlinear behavior of the bridge in the time history are presented in Table 3. In order to understand the results, the sections of the arch bridge are shown in Figure 9.

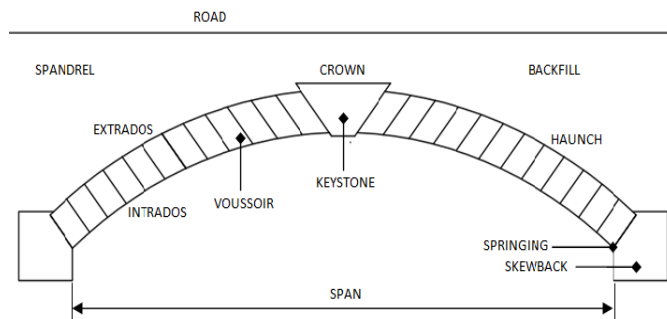

Fig.9 Sections of Masonry Arch Bridge [24]

The maximum displacement occurred in the filler area close to the support. Maximum displacement occurred at 21.78 cm 3.035 s. The displacement at the peak acceleration is 21.68 cm.

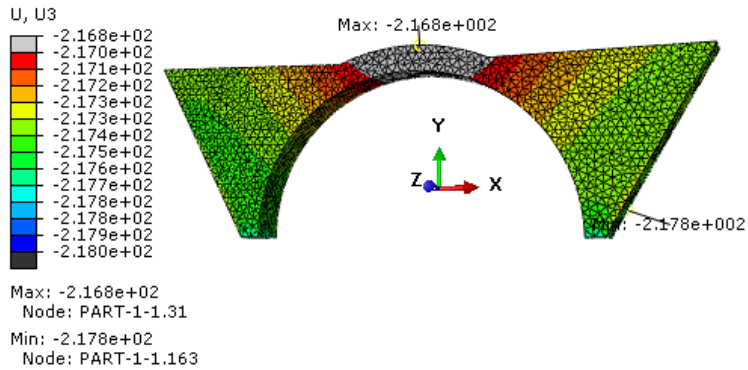

Fig. 10 The Max Displacement at 3.035 s

Table 6 Principal Stress Values

S_{max} (Tensile) (Mpa)	S_{min} (Compressive) (MPa)
0.8957	5.645

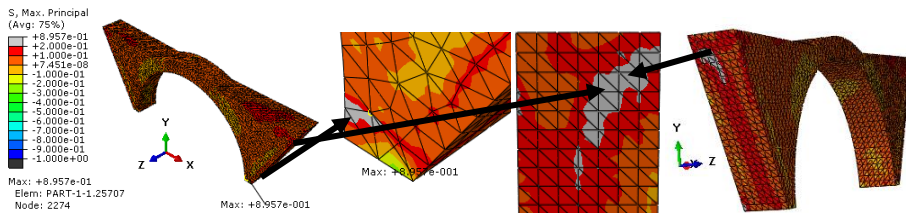

Fig. 11 S_{max} Principal Stress Values Abaqus Analysis Result

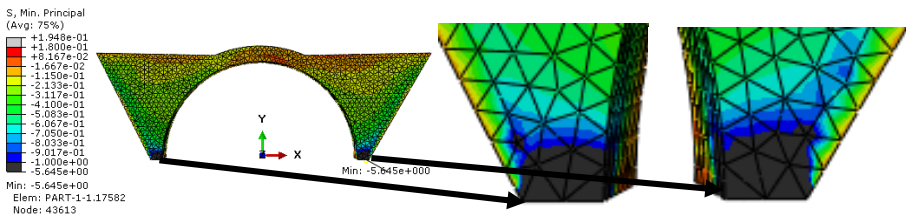

Fig. 12 S_{min} Principal Stress Values Abaqus Analysis Result

As seen in Figure 11, the tensile stresses are concentrated in the infill walls close to the supports. The maximum stress due to tension occurred in 5.49 s. As can be seen in Figure 12, the stresses caused by the compressive are also concentrated in the same parts of the bridge. However, the stress value due to compression is 6 times the stress value due to tension, as seen in Table 6.

Damaget is the type of damage that occurs due to tensile stress in the structure. Damaget is the type of damage that occurs due to compressive stress in the structure. As can be seen in Figure 13 and Figure 14, tensile and compressive damages are concentrated at the edges of the infill wall. Considering the assumptions in Table 3 and looking at Table 7, the bridge

infill walls were damaged due to compressive. According to the results, 555 elements are damaged due to compressive.

Table 7 Damage^c and Damage^t Values

Number of Elements Exceeded 0.95	Damage^c
	555
Number of Elements Exceeded 0.95	Damage^t
	0

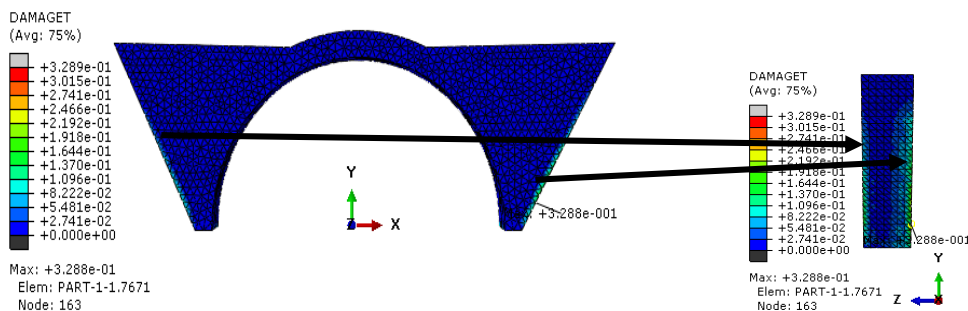

Fig. 13 Damage^t Analysis Results

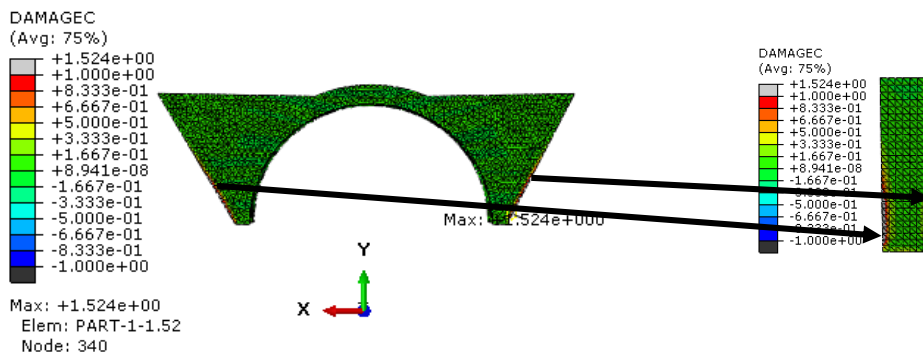

Fig. 14 Damage^c Analysis Results

8. Conclusion

The seismic damage estimation of historic masonry stone arch bridge was investigated with a FE model. Begin with, 5 modes were obtained as a result of the frequency analysis of the bridge. From the obtained mode shapes, the 1st and 2nd mode shapes were formed in the transverse direction, and the 3rd and 4th mode shapes were formed in the vertical direction. The 5th mode was found to be torsion. The displacement in the direction of acceleration was found to be 21.78 cm. NLTH analysis was carried out with the ground motion, CDP material model, which occurred in Kocaeli Earthquake (1999). For CDP analyses, behaviors of masonry under compression and tensile stresses were investigated in detail and determined. It has been determined that the compressive and tensile stresses are concentrated near the points where haunches of an arch are supported by the rocks. It has been determined that the compressive stress value is 6 times greater than the tensile

stress value. Damages are concentrated at the edges of the infill wall. If the value obtained in these regions where the compressive and tensile stresses are maximum exceeds the material strength of the bridge, it can be expected that potential damages will occur in these regions first.

References

1. Bayraktar A, Altunışık AC, Türker T, Sevim B, Ateş Ş. Karayolu Köprülerinin Sonlu Eleman Modellerinin Operasyonel Modal Analiz Yöntemiyle İyileştirilmesi. 1. Köprü ve Viyadükler Sempozyumu; 2007, p. 355-364.
2. Bayraktar A, Altunışık AC, Sevim B, Türker T. Kömürhan Köprüsünün Sonlu Eleman Model İyileştirilmesi. İMO Teknik Dergi, 2009;307: 4675-4700.
3. Ural A. Tarihi Kemer Köprülerin Sonlu Eleman Metoduyla Analizi. Deprem Sempozyumu; 2005, p. 408-413.
4. Türker T, Bayraktar A, Kocaman İ, Çoruhlu B. Ölçekli Yığma Taş Kemer Köprü Modelinin Dinamik Davranışının Deneysel Ve Analitik Olarak İncelenmesi. 5. Tarihi Eserlerin Güçlendirilmesi ve Geleceğe Güvenle Devredilmesi Sempozyumu; 2015. p. 1-3.
5. Özmen A, Sayin E. Tarihi Yığma Bir Köprünün Deprem Davranışının Değerlendirilmesi. NOHU J. Eng. Sci., 2020; 9(2): 956-965.
6. Korkmaz K.A., Zabin P, Çarhoğlu A.İ., Nuhoglu A. Taş Kemer Köprülerin Deprem Davranışlarının Değerlendirilmesi: Timisvat Köprüsü Örneği, İleri Teknoloji Bilimleri Dergisi, 2013;2(1):66-75.
7. Birinci F. Taş kemer köprülerin sonlu eleman modellerinin operasyonel modal analiz yöntemiyle iyileştirilmesi (Doctoral dissertation, Karadeniz Teknik Üniversitesi/Fen Bilimleri Enstitüsü), 2010.
8. Ercan E, Nuhoglu A. Üç Açıklıklı Tarihi Yığma Kemer Köprünün Yapısal Davranışının Belirlenmesi. 3.Köprüler Viyadükler Sempozyumu: 2015 Mayıs 8-10: İnşaat Mühendisleri Odası, Bursa Şubesi.
9. Pelà L, Aprile A, Benedetti, A. Seismic Assessment Of Masonry Arch Bridges. Engineering Structures, 2009;31(8):1777-1788.
10. Hatzigeorgiou GD, Beskos DE, Teodorakopoulos DD, Sfakianakis M. Static and dynamic analysis of the Arta bridge by finite elements, Architecture & Civil Engineering, 1999;2(1):4-51.
11. Hokelekli E, Yilmaz, BN. Effect of cohesive contact of backfill with arch and spandrel walls of a historical masonry arch bridge on seismic response, Periodica Polytechnica Civil Engineering, 2019;63(3):926-937.
12. Çoruhlu B, Türker T, Yanık Y, Bayraktar A. Tarihi Taş Kemer Köprülerin Modal Davranışlarının Köprü Boyutlarına Bağlı Olarak Tahmin Edilmesi. Uluslararası Katılımlı 6. Tarihi Yapıların Korunması ve Güçlendirilmesi Sempozyumu: 2017 Kasım 2-4.
13. Altiok T. Y, Demir A. Collapse mechanism estimation of a historical masonry minaret considered soil-structure interaction. Earthquakes and Structures, 2021;21(2): 61-172.
14. Nohutcu H, Hokelekli E, Ercan E, Demir A, Altintas G. Collapse mechanism estimation of a historical slender minaret. Structural Engineering and Mechanics, 2017;64(5):653-660.
15. Demir A, Nohutcu H, Ercan E, Hokelekli E, Altintas G. Effect of model calibration on seismic behaviour of a historical mosque. Structural Engineering and Mechanics. 2016;60(5):749-760.

16. Demir A, Altıok T. Y, Numerical assessment of a slender structure damaged during October 30, 2020, İzmir earthquake in Turkey..Bulletin of Earthquake Engineering, 2021;19(14):5871-5896.
17. Hökelekli E, Demir A, Ercan E, Nohutçu H, Karabulut A. Seismic Assessment in a Historical Masonry Minaret by Linear and Non-linear Seismic Analyses. Periodica Polytechnica Civil Engineering, 2020;64(2):438-448.
18. Hökelekli E, Al-Helwani A. Effect Of Soil Properties On The Seismic Damage Assessment Of Historical Masonry Minaret–Soil İnteraction Systems, The Structural Design Of Tall And Special Buildings, 2020;29(2):e1694.
19. Altıok TY. Tarihi Minarelerin Dinamik Özelliklerinin Deneysel Ve Nümerik Yöntemler İle Araştırılması (Master's Thesis, Fen Bilimleri Enstitüsü).2019.
20. Mutlu Ö, Şahin A. Investigating the effect of modeling approaches on earthquake behavior of historical masonry minarets-Bursa Grand Mosque case study, Sigma, 2016;7(2):123-136.
21. Öztürk H. Betonarme Kısa Kirişlerde Kesme Dayanımının Çapraz Kesme Donatıları İle İyileştirilmesi (Doctoral dissertation, Doktora Tezi).2016.
22. <https://autodesk.com.tr/products/autocad>
23. ABAQUS, Simulia Inc. Version 6.12. Providence, Rhode Island, USA. (2012)
24. Tanrıverdi M, Gürel MA. Geçmişten Günümüze Kemer Köprüler. Harran Üniversitesi Mühendislik Dergisi, 2019; 4(3):156-167.