



Research Article

Design and development of a novel multichannel data acquisition system using labview for an automobile air conditioning application

Sandeep SHALGAR^{1*}, Rupa BINDU²

^{1,2}Department of Mechanical Engineering, Dr. D. Y. Patil Institute of Technology, S.P. Pune University, India.

ARTICLE INFO

Article history

Received: 14 February 2021

Accepted: 16 September 2021

Keywords:

Multi Channel Data Acquisition System, Error Analysis, LabVIEW, Automobile Air-Conditioning System, Triggering Circuit

ABSTRACT

To sustain in the ever-changing environment and to combat the atmospheric effect, development of a highly efficient and an environment friendly air conditioning system which can run in parallel or as an alternative to an existing vapor compression system is the need of the hour and such novel hybrid air conditioning system are under development today. For the parameters attribution mapping of such novel hybrid air conditioning system, today's commercially available data acquisition systems (DAS) need to be customized to the requirements of addition of sensor nodes and their integration with triggering mechanism for actuation of devices for its programmed operation. Therefore, this paper describes the design and development of novel multichannel data acquisition system (NMDAS) for automobile air conditioning application. The details of the hardware design, software design, error analysis and testing of the NMDAS are presented. The proposed NMDAS uses PLC module DVP16SP configured with analog reader DVP 04TC for temperature measurement at 32 nodes and DVP04AD for pressure or humidity measurements at 8 nodes. The triggering circuit for activation of the relay is enabled using NI LabVIEW user interface and PLC data. The output of the NMDAS is integrated with processor by RS 232 port for data storage and processing. The error analysis of temperature, pressure and humidity measurements are done by comparing with reference calibration standards. The average thermal stability of the temperature sensors over the operating range of -5°C to 150°C is 0.0015°C . The average accuracy of pressure transmitters for operating range of pressure 0 to 40bar is estimated 98.219%. The minimum error in the output current is 0.375% and maximum error is 7.125% over relative humidity span of 0%RH to 100% RH respectively. The proposed NMDAS is used for testing of the novel hybrid air conditioning system of automobile during development stage and is found expedient.

Cite this article as: Sandeep S, Rupa B. Design and development of a novel multichannel data acquisition system using labview for an automobile air conditioning application. J Ther Eng 2022;8(1):14–28.

*Corresponding author.

*E-mail address: shalgarss@gmail.com

This paper was recommended for publication in revised form by
Hafiz Muhammed Ali



INTRODUCTION

For sustainable development of a country depends on growth in its energy utilization and efficient energy recovery. The attribute of energy consumption is governed by the fuel consumption of the country [1]. The increased fuel consumption leads to increase in greenhouse gas emissions and pollutants [2]. Coronary artery disease and chronic pulmonary diseases are now evidential human health issues arising due to pollutants [3]. Researchers study widely exposed that human utility and appliances are responsible for global climatic change. However, to sustain in the ever-changing environment and to combat the atmospheric effect, new types of air conditioning system other than traditional vapor compression system have been developed and are in use today. For cooling in automobiles; vapor compression refrigeration is being extensively used as shown in figure 1. Compressor of the AC system is driven by engine and consumes 10% to 15% of total generated power thus reduces the fuel economy by 10% to 15%. Therefore, AC compressor is one of the main sources of power consumption leading to increased CO₂ emission [4-5]. Also, R134a is most commonly used refrigerant in vapor compression cycle and has great potential to cause global warming. Therefore, the development of a highly efficient and environment friendly

air conditioning system which can run parallel or as an alternative to the existing vapor compression system is need of the hour and such novel hybrid air conditioning system are in use today. For the parameters attribution mapping of such novel air conditioning system today's commercially available data acquisition system (DAS) need to developed further and customized.

The important parameters those need to be mapped by DAS are: enhanced performance, reduced sizing, and cost. Current vapor compression refrigeration combined with other alternative cooling techniques are also in research for which multiple parameters are to be mapped for long time duration. Afzal et al. [6] investigated thermal comfort inside car cabins using phase change material (oil) combined with vapor compression. USB data loggers for temperature and humidity were used in experimentation. The variations in cabin air temperature and humidity were studied. It was observed that using PCM temperature drop achieved was 13°C and relative humidity increased by 8.6%. Muthuraman et al [7] investigated evaporative-VCR combined system for hot and dry climatic condition and found energy saving in range of 27.3% to 64.1% as per outside air temperature. For parameter mapping and analysis of the proposed innovative air conditioning system extensive experimentation is

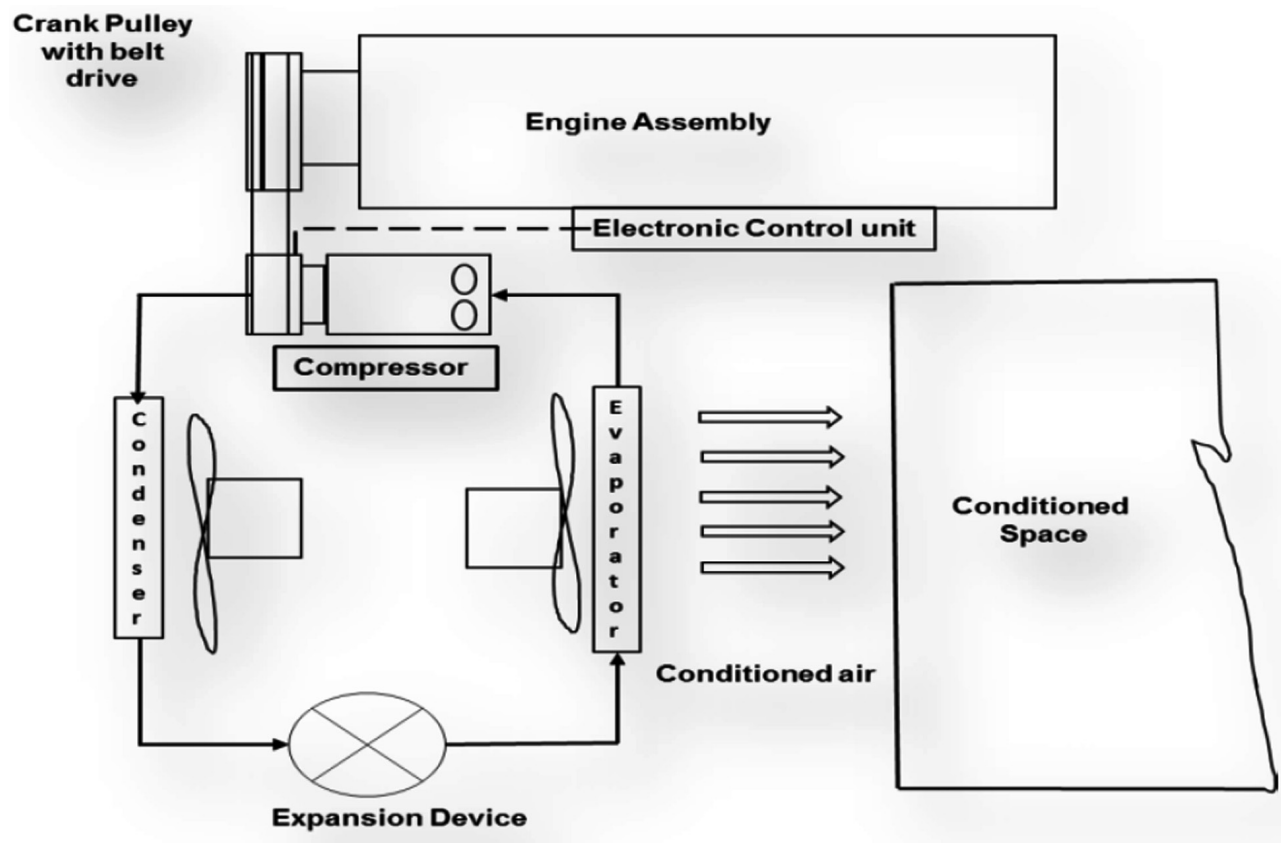

Figure 1. Automobile air conditioning system.

required in the static and dynamic vehicle condition. In the vehicle static experimentation, the independent air conditioning system is evaluated in a standstill environment against comfort parameters. In a dynamic air conditioning system along with other dependent aggregates are validated. Even though the comfort measures are the same in both the conditions, the test environment is different. In dynamic testing, vibrations, engine power managements, wind forces and vehicular integration are taken into account. Ünal [8] studied experimentally the comfort condition in a moving bus. K type sensors, hygrometer and anemometer for air velocity measurement were used with required accuracy. Cooling load, humidity, conditioned air temperature was observed for 120 minutes of travel duration till steady state was achieved. The mapped data was analyzed and behavior patterns against the expected results were checked in the view of confirming the design standard meeting the human comfort requirement. Results show that cabins comfort temperature of 25°C was achieved after 60 minutes from start of the test. Such multiple parameters mapping are recommended using a continuous data acquisition system.

Today's data acquisition system has shown integration of multiple combinations of software and hardware for variety of applications. Carrera et al. [9] developed low cost data logger using Arduino microcontroller for testing indoor air quality and environment. This has various sensors for air temperature, humidity, CO₂ concentration, air velocity, sound level, light intensity, occupant presence etc. fitted in compact space and it proved to be very much usefulness for indoor environment quality evaluation. Santoro et al. [10] has used open-source hardware platform and MDSplus software combined with Python along with Arduino microcontroller along with proximity sensor for distance measurement in fusion experiments. Wu et al. [11] developed a general-purpose data acquisition system with 16 channel digital pulse processor with CERN framework and tested in LINUX platform for nuclear research work. Pixie 16-microsized trigger controller with I/O programmed module has been used. User friendly GUI is created for monitoring and variation of experimental parameters. Fuentes et al. [12] developed the Arduino based data acquisition for monitoring PV system along with MCP3424 microchip of ADC. SD card of 2GB was used for data storage. Open source C/C++ language was the programming language and customized for user interface as per requirement. Kandadai et al. [13] developed a data acquisition system with embedded software to control, monitor and communication with ethernet network. The statuses of appliances were mapped using analogue inputs which were converted to digital using ADC convertor and were controlled by Field Programmable Gate Array controller (FPGA). Ambrož [14] presented the DAS for finding human comfort in riding bicycle using Raspberry pi model. BCM 2835 processor was used with ARM11 CPU.

AD convertor MCP3208 was used with SD card for memory storage. Raspberry model was found to be suitable and more flexible. Samal et al. [15] presented data logging system for green house application using NI cDAQ 9178 PCBs integrated with thermocouple module (NI 9219) for temperature mapping. Whereas NI-ELVIS-II+ were used for pH mapping. NI-cDAQ and NI-ELVIS-II+ are coupled to a processor via USB-2 port. On testing the DAS was found suitable for wide applications.

Refer to Table 1, commercially available data loggers are comprehensively mapped for flexibility and adoptability of parameter as per application requirement. The literature review available till today has found lack of application use of DAS for automobile air conditioning system. Also, the use of universally available DELTA modules and its built-in programming, multiple relay-based switching control, multi-source power input capability were not been considered in complex multichannel DAS development.

The LabVIEW platform provides special tools for to solve particular applications ranging from equipment operation, identifying potential energy efficiency upgrades, confirmations of energy savings, and contributes in meeting accuracy requirements. Mitra et al. [16] developed the data logger for suspension comfort of car rig integrated with NI LabVIEW. RPM sensor, accelerations and ultrasonic sensors were used in DOE. Patel et al. [17] developed data acquisition system to measure and control neutral pressure of cathode ionization process which was interfaced with LabVIEW with inbuilt display monitor. Jianjun et al. [18] developed LabVIEW based data logging system for torsion angle and torque measurement of torsion spring. The generated data could be processed and analyzed in PC based on users input parameter. Liao et al. [19] article was based on data acquisition system development for liquid drop fingerprints using LabVIEW GUI. Capacitance and optical signals were mapped and graphically represented. The data logger results were found matching with the theoretical results. Wang et al. [20] developed a prototype data logger using NI LabVIEW integrated with the HP34970 for temperature, pressure and flow measurement in absorption refrigeration circuit. It was noted that the correctness of parameters like baud rate, stop bits and parity of COM port is equally important along with sensors calibration. Martin et al. [21] compared NI USB logger with open-source DAS. The common library of python and LabVIEW was used to customize I/O programming. Rohit et al. [22] and Ahmed et al. [23] presented a real time data logger using LabVIEW for PV panels efficiency estimation also Mehta et al. [24] used LabVIEW in patient monitoring. DAS modules and LabVIEW was integrated to PC. The DAS system logged the air temperature, humidity, pressure, flow rate and air speed parameters and generated the PV characteristics. The main gap of use of LabVIEW interface in development of DAS for automobile hybrid air conditioning system has been found in reviewed literatures. The LabVIEW assisted

triggering circuit for automation and control of the process parameters of air conditioning is found lacking.

MOTIVATION

Researchers have been implemented data loggers in numerous applications and for different parameters mapping but are limited to the specific process requirements. However, there is no research reported in literature till date on developing data acquisition system with LabVIEW as an interface which is capable of multi triggering the application circuit as per required instant of time. The data acquisition system should be designed in such a way that it should adopt itself to different input source voltages and the available literature review has shown lack of multisource power input capability. The existing DAS for automobile air conditioning application uses vehicle batteries as its power source but are not built robust enough for protection against surge voltage. With the further advent of novel hybrid air conditioning system for the modern vehicles there is need of complex DAS which can map and analyses large number of system parameters (40+ measuring nodes). Also the DAS

for modern vehicle air conditioning system required features like logical relay-based switching control and valve actuation through LabVIEW interface which have not been used for so far in any DAS reported in the literature. The error analysis in DAS development which plays important role in accurate measurement of parameters has not been covered in the literatures.

To fulfill these research gaps, the 40-channel data acquisition system with LabVIEW as an interface, capable of triggering the application circuit as and when required to control process parameters has been developed and presented in this paper. This multichannel DAS system is specifically designed for multi parameters mapping, analysis and control of the novel hybrid air conditioning system of modern vehicles. The paper also present error analysis of the various system parameters.

A NOVEL HYBRID AIR CONDITIONING SYSTEM FOR AUTOMOBILES

Adsorption refrigeration technique is found to be suitable in automobile applications due to its main feature of flexibility in size and capacity. Evaporation cooling is also

Table 1. Commercial data loggers comparison with NMDAS configurations, Suzdalenko et al. [25]

Firm	Omega Engineering	Pico Technology	Geosignal Instruments	Omega engineering	DAS with MSP430	NMDAS with Delta Cards
Model	OM-CP-OCTOPRO-CRSS	USBTC-08	Data logger F848	OM-DAS PRO-5300	Multiple IC	Delta Card DVP04TC DVP16SP DVP04AD
Channel	8	8	8	8	8+4	40++
Resolution	16 bits	20 bits	12 bits	16 bits	12 bits	16 bits
Analogue Values	±30mA	-270 + 1820	4 to 20mA/0 to 10V	-270 + 1822	4 to 20mA/0 to 10V	4 to 20mA/0 to 10V
Periods	1s–12h	>0.1s	1/128s till 12days	1s	1/4s–1h	1/4s–72h
Averaging (Periods)	-	-	-	-	1-60ms	1–200ms
Threshold parameter Triggering	-	-	-	-	yes, 1 channel	Yes, 8 channel
Self-Diagnose	-	-	-	-	-	Yes
Memory Capacity	16383	100000	5000000	512000	9437184	9437184
Data Format	µA, mA, A	°C	mA, A, V, °C	µA, mA, A, mV, mV, °C, Ω	mV, mA, V	°C, Mpa, %RH, Universal Ports
Interface	USB, RS-232	USB	USB	USB	USB	USB, RS-232
Power Supply	9V	USB	2 × 1.5V AAA	7. 2V, 9–12V adpoter	3V, 5–60V adpoter	12V, 24V, 220V power switch mode
Power Surge protection	-	-	-	-	-	Yes
Vibration Resilience	-	-	-	-	-	Yes
Dimension	38×111×89 mm	201×104×34 mm	200×95×35 mm	128×100×28 mm	90×82×22.5 mm	180×450×180 mm
Price(INR)	67593	18418	41217	73047	11176	119000

found to be energy efficient, economical and environment friendly solution for air cooling. Figure 2 shows schematics diagram of novel hybrid air conditioning system which is combination of adsorption and evaporation cooling techniques. The system has three fluid forced circuits consisting of refrigerant lines, exhaust gas lines and coolant lines which exchange heat in adsorber bed (B1 and B2) as per adsorption and desorption process. This system is driven using exhaust gas thermal energy of engine combined with latent heat energy of evaporative pads. Unlike in vapor compression cycle, LP line and HP lines carries refrigerant for air cooling in tube-fin evaporator which conditions the air and supplied to Space cooling. The Valves V1, V2, V3, V4 and V5 are used to control the flow of fluid pumped using P1, P2 and P3 to achieve required cooling effect.

The heat and mass transfer result in the refrigeration effect and is a function of temperature, pressure, and flow of fluids across the application circuit. The governing equation of coefficient of performance (COP) of refrigeration system is given below [5].

$$\text{System COP} = \frac{\text{Refrigerating Effect}(kW)}{\text{Work Supplied}(kW)} \quad (1)$$

The efficiency of the system depends on the quality and correctness of energy and mass transfer across the heat exchangers. For the experimentation of novel hybrid air conditioning system of modern vehicles various parameters are expected to be mapped and analyzed for design conformance to desired thermal comfort. The proposed novel multichannel DAS is designed for multi parameters mapping, analysis and control of 32 nodes of temperature, 6 nodes of pressure and 2 nodes of humidity for the novel hybrid air conditioning system.

METHODOLOGY

Figure 3 below explains the design methodology used for novel multichannel data acquisition system (NMDAS).

Design of Hardware

Figure 4. below represents the block diagram of multi-channel DAS. The input parameters are temperatures, pressures and humidity which are converted to analogue signals using Delta modules powered by 24V DC source.

The 32 nodes of K type sensors are used for temperature measurement, while 6 numbers of Baumer make CTX

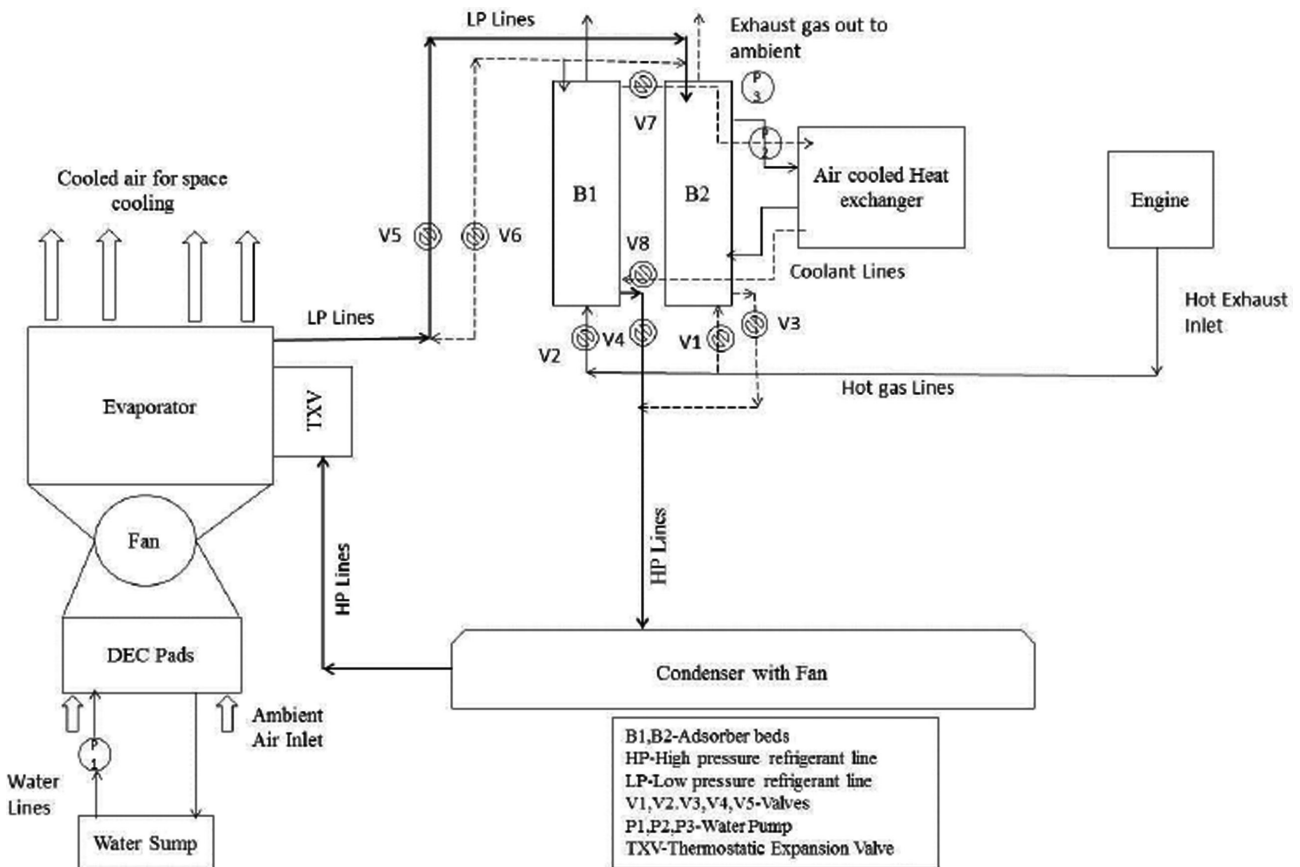

Figure 2. Novel hybrid Air conditioning system.

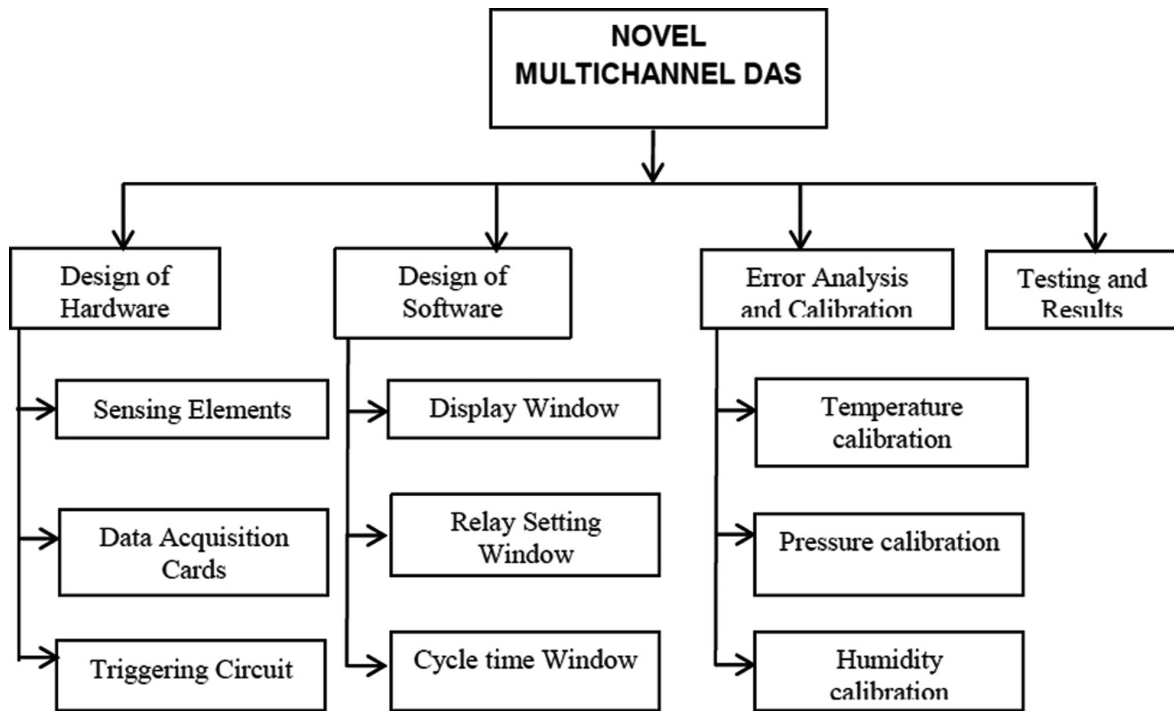

Figure 3. Design methodology of multichannel DAS.

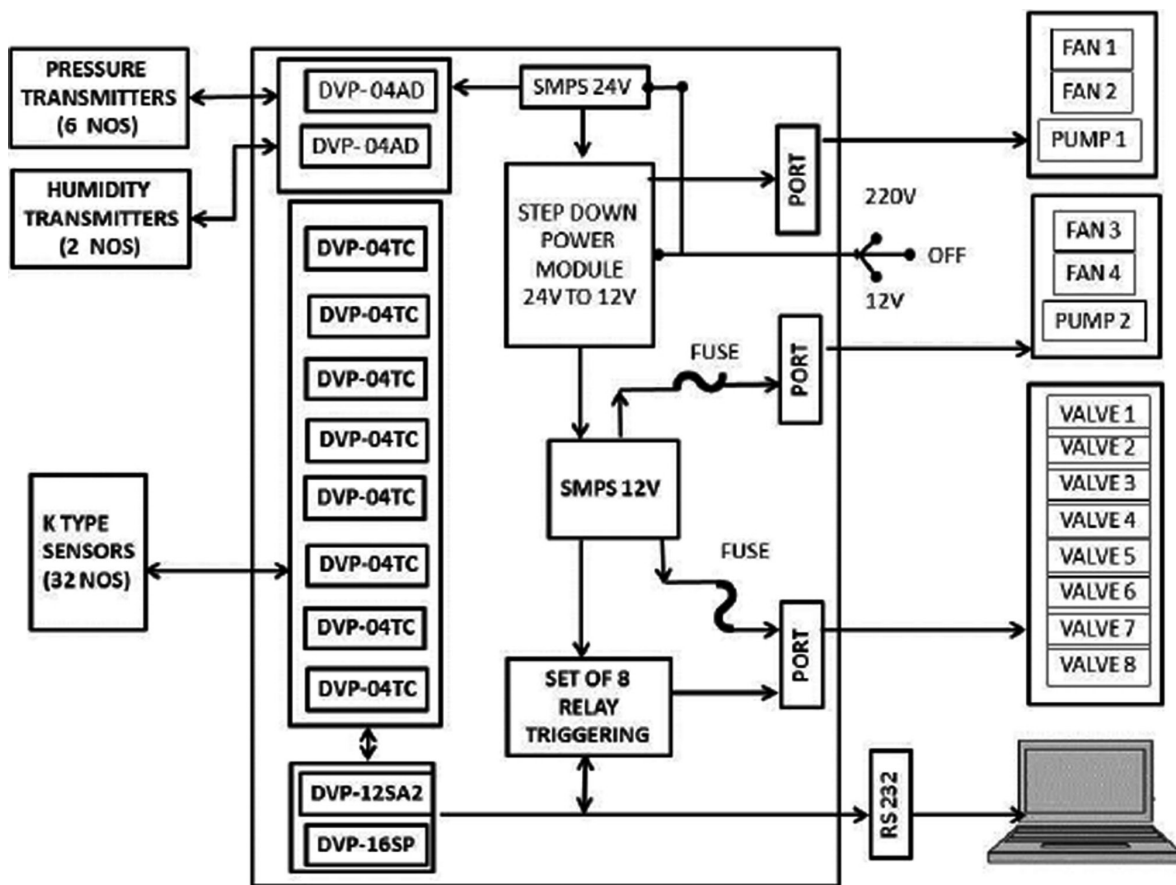

Figure 4. Block diagram of NMDAS.

sensor for pressure measurement and 2 numbers of 947 series humidity sensors are used for humidity measurement. DVP-04TC modules are used for temperatures mapping and DVP-04AD pressure as well as humidity mapping. The CPU is Delta DVP-12SA2 which processes acquired data with DVP16 SP I/O communications. A step-down voltage module is used to power the 8 nodes relay triggering circuit. The relays are triggered based on feedback signals from the sensors and these activate fans, pumps and solenoid valves of the novel hybrid air conditioning system. The surge voltage protection fuses are incorporated in the hardware circuit. The multisource power input capability is assured by providing a selector switch. RS232 interface is used for displaying data on laptop. The user interface of controlling this triggering circuit is done through Lab VIEW programs.

Figure 5 indicates the interfacing of the sensors to the NMDAS. Connection ports for temperature, pressure, and humidity can be seen. The outer shell of multichannel DAS is made up of 1.2mm thick sheet metal powder coating. 3mm thick isolator pads are placed between modules and outer shell for vibration damping during vehicle running conditions. The internal wiring layout is firmly guided with channels and channel cover. Based on power source availability the selector switch enables the system activation in either 12V or 220V. These voltage lines are separated to avoid electromagnetic emission during working.

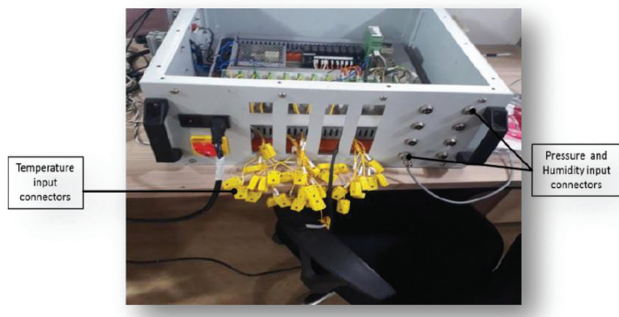

Figure 5. Interfacing of sensors with NMDAS.

Sensing elements

The fluid temperatures at 32 nodes, pressure at 6 nodes and humidity at 2 nodes are required to be mapped. For sensing of these parameters sensors specifications are mentioned in Table 2 are considered for its uncertainties.

Data acquisition cards

Below are the data acquisition cards used to map and process required fluid parameters. Figure 6 provides an insight into the construction layout of hardware of NMDAS.

Temperature measurement using DVP 04TC

DVP 04TC module allows the connection of four thermocouple sensors which can be of types J/ K/R/S/T. This device is capable of reading and writing programs into the microprocessor in every 10 μ S. It has a default capacity to measure temperatures either in Centigrade or in Fahrenheit. The temperatures at 32 nodes of novel hybrid air conditioning system are to be mapped. The Calibration correction factor based on the accuracy of the sensors can be applied in inbuilt programs of module referring Delta datasheet [27].

Pressure and humidity measurement using DVP 04AD

According to the DVP 04AD manual, the analog input module is used to receive the external analog signal which is a 4-point signal, as an input. This signal is then transformed

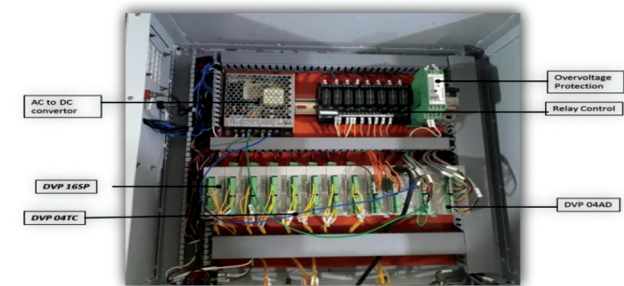

Figure 6. Construction layout of hardware in NMDAS.

Table 2. Sensor specifications and uncertainties

SSr. No.	Parameters	No of Nodes	Operating Range	Sensor specifications
11	Temperature	32 Nos	1°C to 450°C	All 3m bare wire length, on surface mounted, K type sensor of class 2 with accuracy $\pm 1.5\%$ C.
22	Humidity	2 Nos	10% RH to 95% RH	2m length, in air fitment. 942 series with a range from 0%RH to 100% RH, accuracy of $\pm 3\%$ RH, output signal is 4 to 20mA
33	Pressure	6 Nos	1 bar to 40 bar	Refrigerant gas pressure The Baumer make CTX medium steel body sensors with $\pm 0.5\%$ Full Span Range of 0 to 40bar, output signal is 4 to 20mA [26]

into a 14 bits digital signal. This analog module can read and write assembly-level programs directly into the micro-processor of the system. This is used to map the humidity at 2 nodes and pressures at 6 nodes of the novel hybrid air-conditioning system referring Delta datasheet [28].

PLC Processor-DVP-12SA2 with DVP -16SP I/O module

DVP12SA2 is 32bit CPU with the execution speed of 35µS. This has built in RS232 port and hence does not require any additional batteries. This card supports both side DVP-S series modules which helps in space utilization by placing modules in series as per work of González et al. [29]. Step-down transformer LRS 100–24 will be used to bring down 220V to 24 V to energize the cards. This will make the system more efficient and promote lesser power consumption as per LRS datasheet [30].

Triggering Circuit

In the novel hybrid system, the solenoid valve plays a major role as its actuation ensures the fluid flows of refrigerant, exhaust gas and coolant across the circuit at a defined time interval. To reduce power consumption of the devices instead of independently transmitting power to them, a user-defined relaying technology is used. For this purpose, joint relay point's selection and signal allocation scheme are used referring Zhou et al. [31] and Vardhe et al. [32]. It is ensured that as compared to direct contact user-defined relays with optimal configurations provide substantial energy gain as per Su [33]. The electrical interfaces between the Delta modules and the relay are mapped at common cluster and fetched for triggering as per required set values referring to Agrawal et al. [34].

Relay controlled Solenoid valves of the system are labeled as R1 to R8 as mentioned in Table 3. The air conditioning process includes adsorption-heating-desorption-cooling for defined process time as 600 seconds to each commuting to 2400 seconds of cyclic intervals. OMRON relays which consist of semiconductors allow operations with high frequency and speed as mentioned by Liu et al. [35]. Here, they are used to control 12V solenoid valves and pumps. The voltage surge protection for the protection of multichannel DAS from generated spikes (when connected to the vehicle battery) is shown to the right side in Figure 6.

Design of Software

National Instruments LabVIEW provides a user-friendly application development environment particularly for engineers and scientists for experimentation and analysis as presented by Mahzan et al. [36]. The Lab VIEW domain provides distinct application modules to support in the designing signal processing and conditioning algorithms with graphical block diagrams [30, 31]. Using these block diagrams user interface is customized for novel hybrid air conditioning systems of automobiles.

The main Lab-VIEW window

Figure 7 shows a display window for temperatures, humidity, and pressures. The data acquisition system parameters and their description for displaying can be modified in the Lab VIEW module as per the required applications. The window enables COM port selection to connect laptop to NMDAS indicating connection status to the left side. To the right-side active relay is indicated. The start and exit tab help to start the recording and exit the

Table 3. Relay triggering logic for solenoid valves

Operation cycle		Cycle Times in Seconds			
		0 to 600s	601s to 1200s	1201s to 1800s	1801s to 2400s
Relay Nodes	Process	Bed B1 Adsorption	Bed B1 Heating	Bed B1 Desorption	Bed B1 Cooling
		Bed B2 Cooling	Bed B2 Adsorption	Bed B2 Heating	Bed B2 Desorption
R1 -Exhaust Solenoid Valve 1		ON	OFF	OFF	OFF
R2-Exhaust Solenoid Valve 2		OFF	OFF	ON	OFF
R3-B1 Solenoid Valve inlet		OFF	OFF	OFF	ON
R4-B1 Solenoid Valve Outlet		OFF	ON	OFF	OFF
R5-B2 Solenoid Valve inlet		OFF	ON	OFF	OFF
R6-B2 Solenoid Valve Outlet		OFF	OFF	OFF	ON
R7-Coolant Solenoid Valve 1		OFF	OFF	ON	OFF
R8-Coolant Solenoid Valve 2		ON	OFF	OFF	OFF

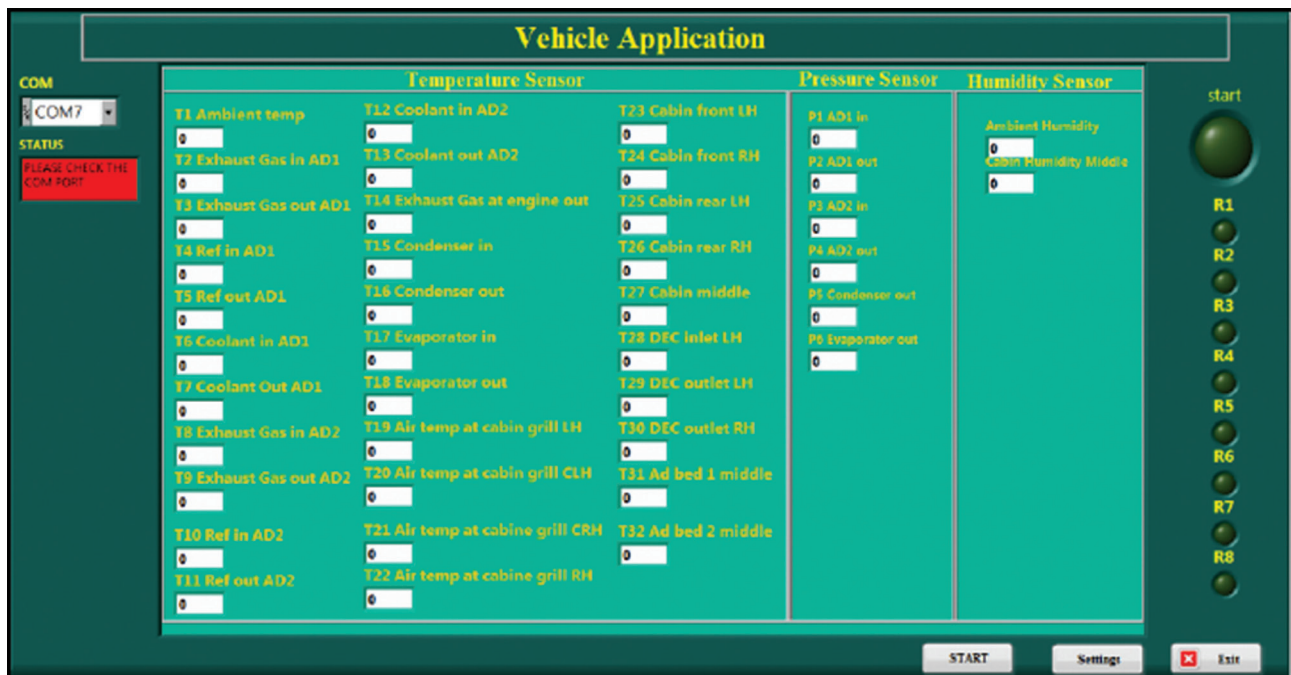

Figure 7. Main Lab VIEW window of novel hybrid air-conditioning system.

window by stopping all functions. The setting tab at the bottom is used to set the triggering parameter for the actuation of the solenoid valve to control the flow of fluids required in the air conditioning system.

The relay setting window

The triggered node points of the relay are set from the programming to actuate the required solenoid devices. The triggering setting has been divided into two stages based on dependent and independent parameters referring to Ljungblad et al. [37] and Matsuoka et al. [38]. The relay actuation based on temperatures and pressures are mentioned in Figure 8 for optimization of cycle time.

Error Analysis and Calibration

NMDAS is integrated with the novel hybrid air-conditioning system in automobile. The temperature, pressure and humidity sensors along with NMDAS are calibrated and are used in measurement of air conditioning system parameters.

Temperature calibration

The K Type thermo sensors are used in the test setup. As the major output of the system is apprehended via temperature parameter, in situation calibration is done with FLUKE make calibrated tester. The stability of sensors is tested in a water bath maintained at 20°C with the uniformity ($\pm 0.003^\circ\text{C}$) and thermal firmness ($\pm 0.0015^\circ\text{C}$) for -5°C to

150°C. Refer to the graph in Figure 10, the maximum variation of 0.002°C and minimum variation of 0.001°C is found for 20 minutes of temperature stability curve.

Pressure calibration

Pressure transmitters are used for refrigerant pressure measurement placed in bench calibration set up with PLC display. The transmitter errors are mapped and the calibration correction factor is observed by finding resistance deviation with respect to reference sensors of bench set up referring to Goulao et al. [39]. The output signal of transmitter is directly displayed in the form of 4 to 20 mA against applied compressor pressure for range 0 bar to 40 bar pressure. The output current in mA with pressure interval of 4 bar is mapped in Table 4.

Refer to the graph in Figure 11, step rise of pressure with 10% of pressure span (that is 4bar) is applied using compressor in forward and reverse pressure feed and graph of error over pressure span is plotted. As in forwarding feed pressure (0 bar to 40bar) increases the percentage error over operating span also increases and found maximum at 20 bar to 28bar is 0.281 bar.

In reverse pressure feed (40bar to 0 bar) maximum percentage error over the span is 0.219 bar. Average forward feed errors -0.209bar and average reverse feed error are 0.181 bar are evaluated. The accuracy at 100% is found 99.906%. This error factors are taken into account in LabVIEW programming.

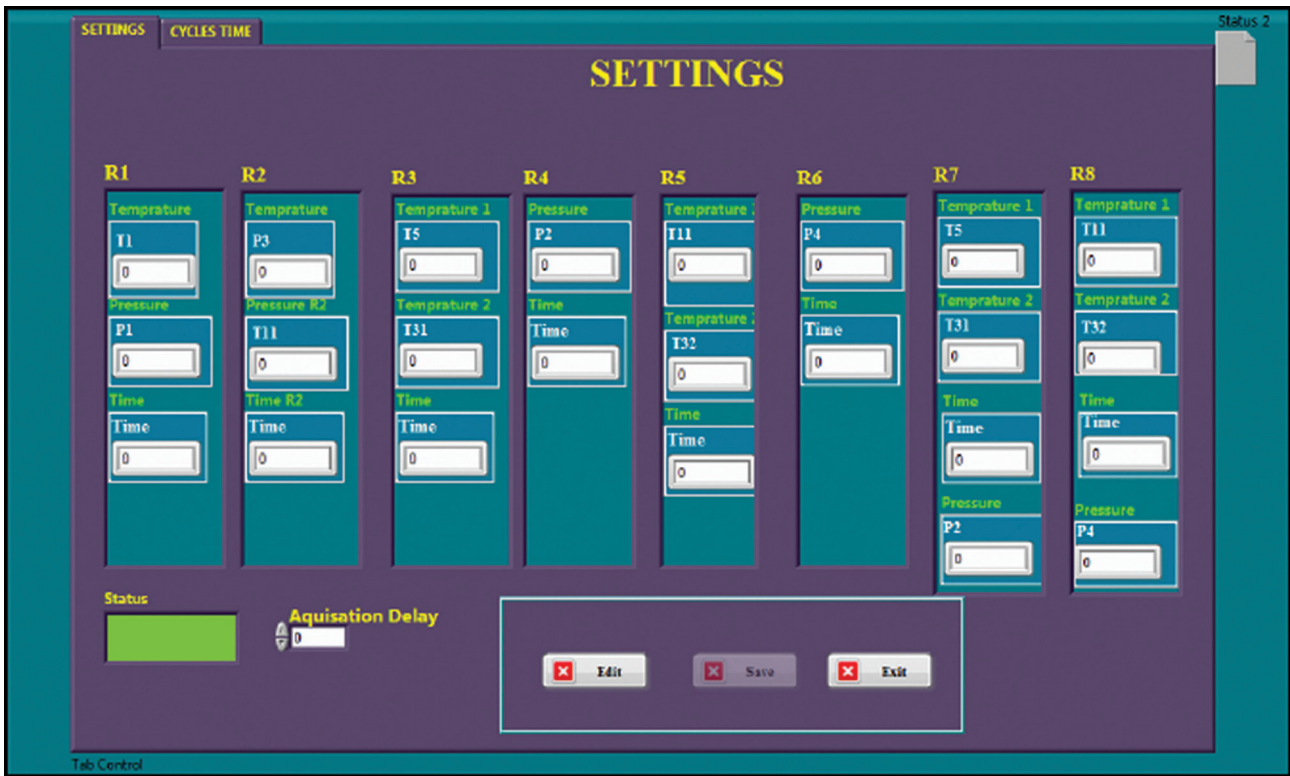

Figure 8. Triggering parameter setting for Relay actuation.

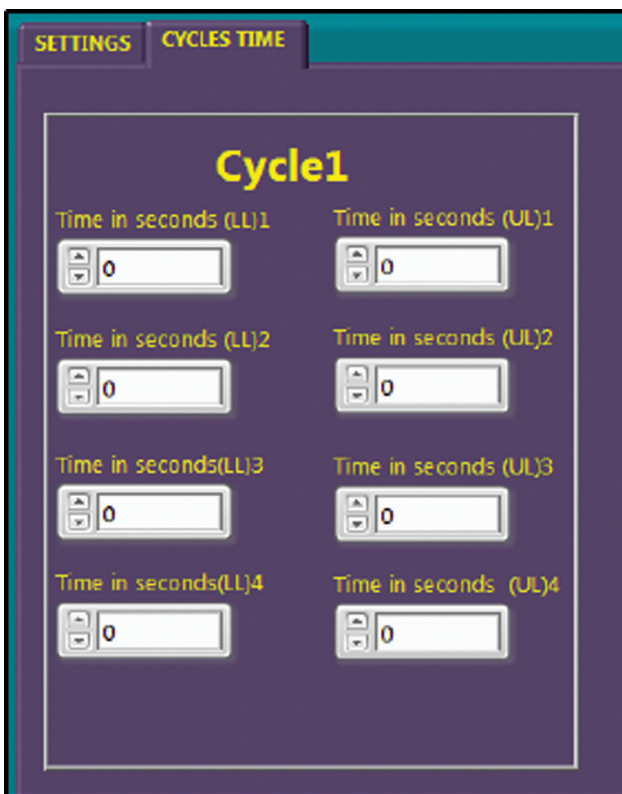

Figure 9. Relay actuation cycle time setting.

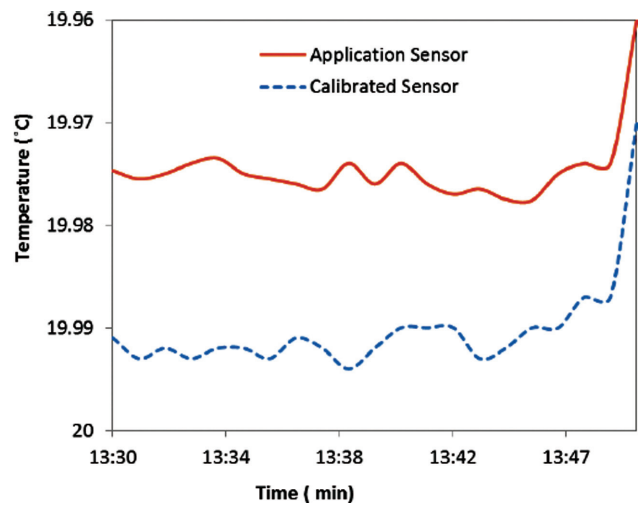

Figure 10. Stability of temperature sensors at 20°C.

Humidity calibration

The humidity chamber installed with multi meter and humidity indicator is used to compare humidity transmitter with master sensor. Refer to graph in Figure 12, humidity transmitter error and current output error (4 to 20mA) is plotted on Y axis against 0 to 100 %RH with humidity rise of 10% over humidity span on X-axis.

Table 4. Pressure calibration and error analysis

Measurement Feed	Percentage of range	Input Pressure (Bar)	Output Current (mA) (Ideal)	Output Current (mA) (Measured)	Error (Percentage of span)
Forward Feed 0 bar to 40 bar	0%	0	4.00	3.98	-0.125
	10%	4	5.60	5.59	-0.062
	20%	8	7.20	7.17	-0.187
	30%	12	8.80	8.76	-0.250
	40%	16	10.40	10.36	-0.250
	50%	20	12.00	11.955	-0.281
	60%	24	13.60	13.565	-0.219
	70%	28	15.20	15.155	-0.281
	80%	32	16.80	16.765	-0.219
	90%	36	18.40	18.365	-0.219
Reverse Feed 40 bar to 0 bar	100%	40	20.00	19.985	-0.094
	90%	36	18.40	18.415	0.094
	80%	32	16.80	16.835	0.219
	70%	28	15.20	15.235	0.219
	60%	24	13.60	13.625	0.156
	50%	20	12.00	12.025	0.156
	40%	16	10.40	10.435	0.219
	30%	12	8.80	8.835	0.219
	20%	8	7.20	7.225	0.156
	10%	4	5.60	5.635	0.219
0%	0	4.00	4.025	0.156	

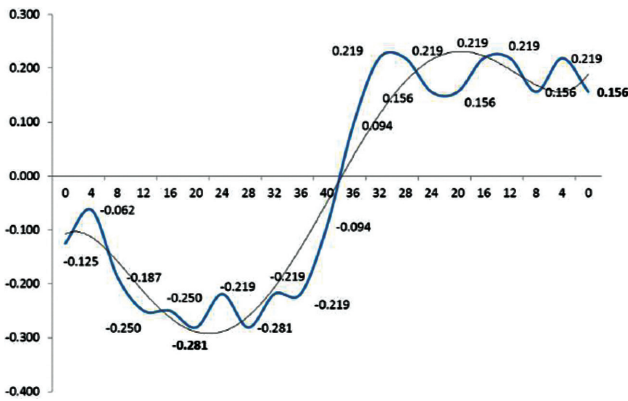

Figure 11. Pressure calibration and error analysis over pressure Span.

The maximum error in output current is 7.125% and minimum error of 0.375 % over the humidity span. The percentage error increases as the RH value increases but found within 1% of relative humidity value. In LabVIEW programming, calibration correction factors are applied against each module referring Kumar et al. [40] and Benasulin et al. [41].

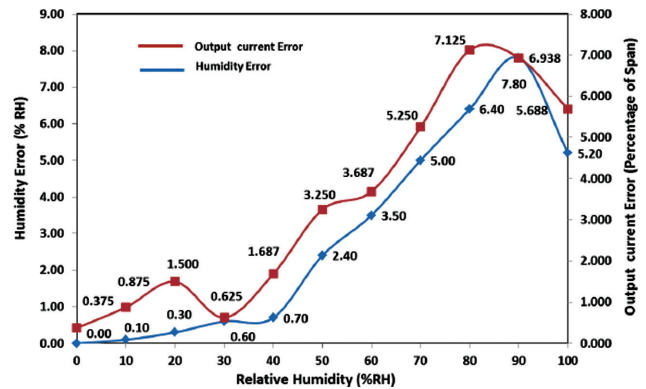

Figure 12. Humidity calibration and error analysis over operating span.

TESTING AND RESULTS

The NMDAS is placed inside the vehicle and its temperature and humidity sensors are placed at roof while pressure sensors are placed refrigerant pipes. The effect of novel hybrid air conditioning system on cabin air quality for change in dry bulb temperature (DBT) and relative humidity are experimentally mapped [6-8].



Figure 13. Instrumentation of NMDAS in vehicle.

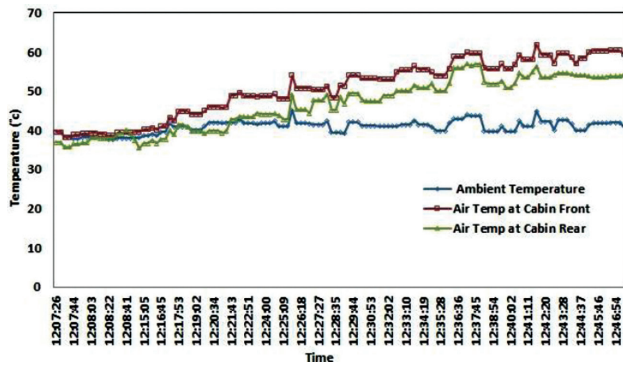

Figure 15. Cabin temperature mapping using NMDAS.

The trial for data logger functionality was conducted on 04th and 05th June 2020 to find the dry bulb temperature (DBT), wet bulb temperature (WBT) and relative humidity (RH) from morning 11 am to afternoon 4 pm.

Figure 14 represents the average month-wise temperature mapped for 12 months with a period of 2 hours intervals in the day. Temperature mapping for month and days high temperature starting from 6 am to 6 pm are mapped as per Amer et.al. [42]. From this graph, 12 noon to 2 pm is the peak temperature period; hence novel hybrid air conditioning system’s testing planned at this period. Figure 15 and 16 shows the effect of ambient solar load on cabin air temperature and relative humidity.

The refrigerant raises its pressure when it is heated up at constant volume adsorbed by activated carbon of the adsorber beds. The engine exhaust gas controlled at average temperature of 170 °C is used as heat source and directed through adsorber bed. Figure 17 represents refrigerant pressure rise in 22 minutes attaining to 12bar required to work as compressed refrigerant in novel hybrid air conditioning system.

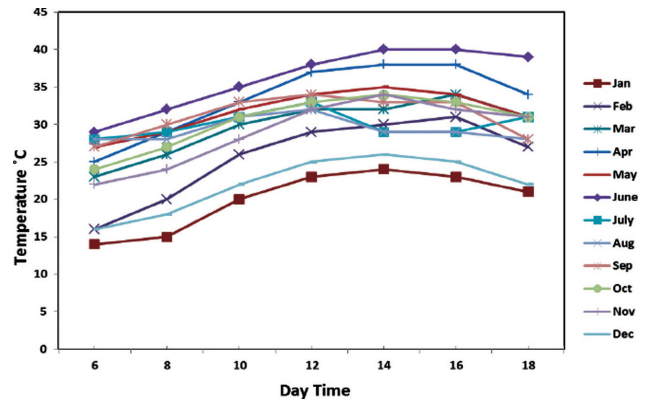

Figure 14. Temperature mapping for month and days high temperature.

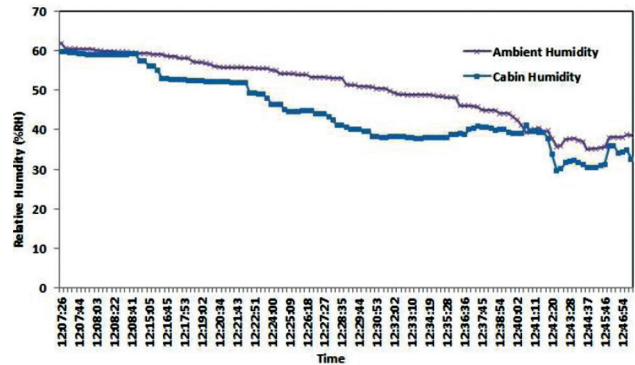

Figure 16. Cabin relative humidity mapping using NMDAS.

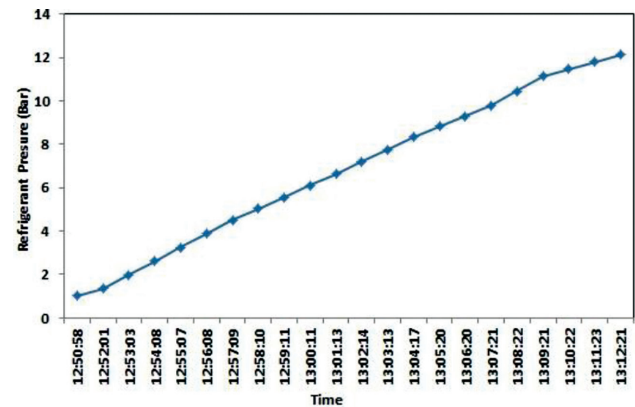

Figure 17. Refrigerant pressure mapping using NMDAS.

CONCLUSION

This research paper deals with the design and development of novel multichannel data acquisition system for continuous mapping of parameters of a novel hybrid

automobile air conditioning system in development stage. The NMDAS is found scalable in increasing number of mapping nodes by easy integration of data modules and portable enough to carry in mobile air-conditioning for highway trials. The NMDAS is flexible enough for the measurements of temperature, pressure and humidity of a variety of application circuits and also is capable of triggering the devices at any set values of the process parameters or time. It has universal sensor ports and can be adapted to multiple power sources either in an automobile or in any laboratory testing. This wide switching voltage range from 12/24 Volts in automobiles to 240 volts in lab experimentation makes this data logger unique and robust.

- The design of hardware with Delta temperature, pressure and humidity modules shows flexibility for increasing number of measurement nodes as per air conditioning system requirements.
- The accuracy of pressure transmitters for operating pressure range of 0 to 40bar is found to be 99.906% when calibrated with standard reference.
- The minimum error in output current is estimated as 0.375 % and maximum error is 7.125% over the relative humidity range of 0% RH to 100%RH.
- The percentage error increases as the RH value increases but found within 1% of relative humidity value. The analysed errors are mapped in LabVIEW programming and verified during experimentations.
- The response time for temperature change was found more at the experimental setup and lag was around 2 seconds which can be improved with the higher class of thermo sensors.
- The acquired data of NMDAS with relay triggering interfaced with LabVIEW mends the automation in hybrid air conditioning system and supports in optimization of system parameters.

With little modifications in the front end as per requirements, NMDAS can easily deployed for any application circuits.

ACKNOWLEDGMENT

The authors would like to acknowledge and thanks to All India Council for Technical Education (AICTE), New Delhi, India for support for the research project funding No.8-62/RIFD/RPS in the field of air conditioning for automobiles.

AUTHORSHIP CONTRIBUTIONS

Authors equally contributed to this work.

DATA AVAILABILITY STATEMENT

The authors confirm that the data that supports the findings of this study are available within the article. Raw

data that support the finding of this study are available from the corresponding author, upon reasonable request.

CONFLICT OF INTEREST

The author declared no potential conflicts of interest with respect to the research, authorship, and/or publication of this article.

ETHICS

There are no ethical issues with the publication of this manuscript.

REFERENCES

- [1] Johnson VH. Heat-generated cooling opportunities in vehicles. SAE Technical Paper; 2002 Jun 3. [\[CrossRef\]](#)
- [2] Atan R. Heat recovery equipment (generator) in an automobile for an absorption air-conditioning system. SAE Technical Paper; 1998 Feb 1. [\[CrossRef\]](#)
- [3] Toure S, Faggianelli A, Muselli M, Cristofari C. Air Conditioning Using Thermal Solar Collectors Coupled with an Absorption Chiller in Corsica. In 2012 Asia-Pacific Power and Energy Engineering Conference 2012 Mar 27 (pp. 1-4). IEEE. [\[CrossRef\]](#)
- [4] Mei VC, Chen FC, Sullivan RA. Analysis of non-CFC automotive air conditioning. Oak Ridge National Lab., TN (United States); 1991 Jan 1.
- [5] Best R, Rivera W. A review of thermal cooling systems. *Appl Therm Eng* 2015;75:1162-1175. [\[CrossRef\]](#)
- [6] Afzal A, Saleel CA, Badruddin IA, Khan TY, Kamangar S, Mallick Z, Samuel OD, Soudagar ME. Human thermal comfort in passenger vehicles using an organic phase change material—an experimental investigation, neural network modelling, and optimization. *Build Environ* 2020;180:107012. [\[CrossRef\]](#)
- [7] Muthuraman S, Sivaraj M. Analysis of vapour compression refrigeration (VCR) Based air conditioning (AC) system for hot and dry climatic conditions in Oman. *J Therm Eng* 2018;4:1926-1938. [\[CrossRef\]](#)
- [8] Ünal Ş. An experimental study on a bus air conditioner to determine its conformity to design and comfort conditions. *J Therm Eng* 2017;3:1089-1101. [\[CrossRef\]](#)
- [9] Carre A, Williamson T. Design and validation of a low cost indoor environment quality data logger. *Energy Build* 2018;158:1751-1761. [\[CrossRef\]](#)
- [10] Santoro F, Stillerman J, Lane-Walsh S, Fredian T. Exploring MDSplus data-acquisition software and custom devices. *Fusion Eng Des* 2020;155:111534. [\[CrossRef\]](#)
- [11] Wu HY, Li ZH, Tan H, Hua H, Li J, Hennig W, Warburton WK, et al. A general-purpose digital data

- acquisition system (GDDAQ) at Peking University. Nuclear Instruments and Methods in Physics Research Section A 2020;975:164200. [CrossRef]
- [12] Fuentes M, Vivar M, Burgos JM, Aguilera J, Vacas JA. Design of an accurate, low-cost autonomous data logger for PV system monitoring using Arduino™ that complies with IEC standards. Solar Energy Materials and Solar Cells. 2014;130:529-543. [CrossRef]
- [13] Kandadai V, Sridharan M, Parvathy SM, Pitchaimuthu R. A comprehensive embedded solution for data acquisition and communication using FPGA. J Appl Res Technol 2017;15:45-53. [CrossRef]
- [14] Ambrož M. Raspberry Pi as a low-cost data acquisition system for human powered vehicles. Measurement 2017;100:7-18. [CrossRef]
- [15] Samal N, Pati UC. Multi-channel data acquisition and data logging for Green House application. In 2014 IEEE Students' Conference on Electrical, Electronics and Computer Science 2014 Mar 1 (pp. 1-5). IEEE. [CrossRef]
- [16] Mitra AC, Soni T, Kiranchand GR, Khan S, Banerjee N. Experimental design and optimization of vehicle suspension system. Mater Today: Proc 2015;2:2453-2462. [CrossRef]
- [17] Patel K, Jadeja KA, Joshi HC, Ghosh J. The data acquisition and control system for the operation of ASDEX pressure gauge for the measurement of neutral pressure in ADITYA Tokamak. Fusion Eng Des 2019;148:111256. [CrossRef]
- [18] Jianjun D, Chao S. Design of multi-channel signal acquisition system of the torsion spring based on LabVIEW. Procedia Eng 2011;15:426-430. [CrossRef]
- [19] Liao HQ, Qiu ZR, Feng GH. The design of LDF data acquisition system based on LabVIEW. Procedia Environ Sci 2011;10:1188-1192. [CrossRef]
- [20] Wang L, Tan YY, Cui XL. The application of LabVIEW in data acquisition system of solar absorption refrigerator. Energy Procedia 2012;16:1496-1502. [CrossRef]
- [21] Martín FF, Llopis MV, Rodríguez JC, González JB, Blanco JM. Low-cost open-source multifunction data acquisition system for accurate measurements. Measurement 2014;55:265-71. [CrossRef]
- [22] Rohit AK, Tomar A, Kumar A, Rangnekar S. Virtual lab based real-time data acquisition, measurement and monitoring platform for solar photovoltaic module. Resource-Efficient Technologies 2017;3:446-451. [CrossRef]
- [23] Ahmed CB, Kassas M, Ahmed SE. LabVIEW based PV panel online characteristics and parameters estimation. Procedia Comput Sci 2015;52:876-882. [CrossRef]
- [24] Mehta B, Rengarajan D, Prasad A. Real time patient tele-monitoring system using LabVIEW. Int J Sci Eng Res 2012;3:1.
- [25] Suzdalenko A, Lazdans A, Galkin I. Development of multi-channel analogue signal data logger based on MSP430. In 2012 5th European DSP Education and Research Conference (EDERC) 2012 (pp. 40-43). IEEE. [CrossRef]
- [26] Baumer. Available at https://www.baumer.com/medias/secure/Baumer_CTX_EN_20190709_DS.pdf?mediaPK=8945626251294. Accessed on 11 Jan, 2022.
- [27] Delta Electronics Inc DVP04TC-S. DVP-S I/O MODULE, 4AI THERMOCOUP Available at: <https://www.datasheetarchive.com/DVP-04TC-datasheet.html>. Accessed on 11 Jan, 2022.
- [28] DVP-04AD. Available at: <https://www.datasheetarchive.com/DVP-04AD-datasheet.html> Accessed on 11 Jan, 2022.
- [29] González A, Olazagoitia JL, Vinolas J. A low-cost data acquisition system for automobile dynamics applications. Sensors 2018;18:366. [CrossRef]
- [30] LRS-100 series. 100W Single Output Switching Power Supply Available at: <https://www.meanwell.com/Upload/PDF/LRS-100/LRS-100-SPEC.PDF> Accessed on 11 Jan, 2022.
- [31] Zhou Z, Zhou S, Cui JH, Cui S. Energy-efficient cooperative communication based on power control and selective single-relay in wireless sensor networks. IEEE Trans Wirel Commun 2008;7:3066-3078. [CrossRef]
- [32] Vardhe K, Reynolds D, Woerner BD. Joint power allocation and relay selection for multiuser cooperative communication. IEEE Transactions on Wireless Communications. 2010;9:1255-1260. [CrossRef]
- [33] Zhong Su, Research and Implementation of New Type Multi-Channel Data Acquisition System, Journal of Physics Conference Series, Vol-1, pp.117-123, 2010.
- [34] Agrawal S, Kumar V, Anand N, Agarwal VK, Islam A. Development of data acquisition system and data analysis technique for automotive applications. In 2016 World Conference on Futuristic Trends in Research and Innovation for Social Welfare (Startup Conclave) 2016 (pp. 1-4). IEEE. [CrossRef]
- [35] Feng H, Liu F, Xu Y. Functional testing system based on LabVIEW for gas-fueled automobile engine ECU. In 2011 3rd International Conference on Advanced Computer Control 2011 Jan 18 (pp. 357-361). IEEE.
- [36] Mahzan NN, Omar AM, Rimón L, Noor SM, Rosselan MZ. Design and development of an arduino based data logger for photovoltaic monitoring system. Int J Simul Syst Sci Technol 2017;17:15. [CrossRef]
- [37] Ljungblad S, Josefson LE, Holmsten M. Method for effective calibration of temperature loggers with automated data sampling and evaluation. Int J Thermophysics 2011;32:2495-2503. [CrossRef]

- [38] Matsuoka Y, Yamamoto Y, Tobita T, Shimada S, Yasukawa A. Designing method for sensing body mechanism of differential pressure transmitter using silicon diaphragm type pressure sensor. InConference Proceedings. 10th Anniversary. IMTC/94. Advanced Technologies in I & M. 1994 IEEE Instrumentation and Measurement Technolgy Conference (Cat. No. 94CH3424-9) 1994 May 10 (pp. 1229-1232). IEEE.
- [39] Goulao V, Paulo R, Salvado J, Martins G, Granjeia A. A new monitoring and data logger system for industrial cooling equipment applications. In2011 IEEE EUROCON-International Conference on Computer as a Tool 2011 Apr 27 (pp. 1-3). IEEE. [\[CrossRef\]](#)
- [40] Kumar A, Singh IP, Sud SK. Energy efficient air quality monitoring system. InSENSORS, 2011 IEEE 2011 Oct 28 (pp. 1562-1566). IEEE. [\[CrossRef\]](#)
- [41] Benasulin D, Modesti M, Conte D. Low cost multichannel expandable data logger. In2015 XVI Workshop on Information Processing and Control (RPIC) 2015 Oct 6 (pp. 1-6). IEEE. [\[CrossRef\]](#)
- [42] Amer O, Boukhanouf R, Ibrahim HG. A review of evaporative cooling technologies. *Int J Envir Sci Dev* 2015;6:111. [\[CrossRef\]](#)