



A review of friction stir welding parameters, process and application fields

Emre Kaygusuz*¹, Filiz Karaömerlioğlu^{2,3}, Serhat Akıncı³

¹Bingol University, Pilot University of Central Coordination Unit, Türkiye

²Mersin University, Engineering Faculty, Electrical Electronics Engineering, Türkiye

³Mersin University, Nanotechnology and Advanced Materials, Türkiye

Keywords

Friction Stir Welding
FSW
Application
Welding Al Alloys

Review Article

DOI: 10.31127/tuje.1107210

Received: 21.04.2022

Revised: 25.10.2022

Accepted: 21.11.2022

Published: 27.02.2023



Abstract

It is important to join materials for systems that require high-performance and to minimize the defects that may occur during this joining. Welding is the most common way for joining materials but for lightweight and similar/ dissimilar materials, Friction Stir Welding preferable for its high-performance joining properties. Lightweight and durable materials such as aluminum alloys are widely used in sectors such as defense industry, aerospace industry, automotive industry, and high-speed train manufacturing. Some of these materials cannot be welded by conventional methods due to their high thermal conductivity and low melting point. In welding processes, material properties are expected to be as close as possible to base material. Friction stir welding (FSW) is a joining method that provides welding below the melting point of materials that cannot be welded by conventional methods or where the welding process causes the mechanical structure of the material to deteriorate. In this study, Friction Stir Welding process, advantages and disadvantages and application fields of Friction Stir Welding were examined.

1. Introduction

The industrial revolution has been an important turning point in the history of humanity, where new materials have been developed. New materials have played a major role in the development of technology used in land, air, sea and space studies due to their low cost and durability. The 20th century has witnessed the growth in engineering works and development of the materials [1]. While this expansion in the material range allows engineers to design specific parts and equipment, it has also created new situations where different materials are used in the construction. Combining parts made of different materials in terms of chemical, thermal, physical and mechanical properties also created difficulties. Mechanical joining has been a suitable method for many of the different materials. However, the need for high-performance construction has paved the way for welded joints to replace mechanical joints such as rivets and bolts. The use of welding construction has gained great importance especially in the realization of structures where lightness comes to the fore [2].

Welding is the metallurgical joining process of two metal parts to produce a single piece. This joining is the leading way of obtaining monolithic structures and is often accomplished with the use of heat and/or pressure. According to the chemical composition of the main material, fusion welding or solid-state welding is used in welded joining. In fusion welding method, which is based on melting the base metal parts to be welded in the welded area using heat, filler metal is added to the molten area to increase the strength in the joint. Electric arc, electric current or gas mixtures are used in the melting process in the welding zone of the parts to be joined. If the melting process in the welded joint is carried out with an electric arc, it is expressed as arc welding. The heat released from the resistance of the parts held together under pressure against the electric current passing through the contact surfaces, and the bonding provided by the melting process formed on the contact surface constitute the source of resistance [3].

If the hot flame required to melt the metal parts to be joined and the filling material, if used, is provided by combustible gas and oxygen, it is called a gas source. In

* Corresponding Author

(emre_kygsz@windowslive.com) ORCID ID 0000-0001-9356-2149
(filizkrm@mersin.edu.tr) ORCID ID 0000-0002-4677-4365
(serhatakinci1903@gmail.com) ORCID ID 0000-0002-8597-6189

Cite this article

Kaygusuz, E., Karaömerlioğlu, F., & Akıncı, S. (2023). A review of friction stir welding parameters, process and application fields. Turkish Journal of Engineering, 7(4), 286-295

recent years, electron beam and laser are also used for melting in the weld zone in welded joints. If melting in the welding zone is carried out using an electron beam, it is referred to as electron source, if melting using laser, it is expressed as laser source. In welded joining, electron welding and laser welding are superior to other fusion welding methods by forming a small melt pool and narrower heat affected zone (HAZ). Fusion welding methods are most widely used in welded joining of metallic materials. However, welded joining of metallic materials with high thermal and electrical conductivity coefficients, such as copper and aluminum, by fusion welding methods, is carried out under special conditions. In joining, welding methods in which only pressure or pressure and heat are applied together without melting are called solid state welding. When the two-part surfaces are pressed together under high temperature below the melting temperature, the parts are combined by solid state diffusion. This source in solid state is called diffusion welding. The parts are placed on top of each other and moderate pressure is applied, and the jointing, which uses high frequency sound waves to create vibration motion parallel to the part contact surfaces, is called ultrasonic welding method. Welded joining of parts with the help of heat released from friction between two surfaces is expressed as friction welding. Solid state welding methods are used successfully in welded joining of many metallic materials, especially copper and aluminum, which are problematic to be joined by fusion welding methods. Numerous scientific studies have been conducted using solid-state welding methods for welded joining of the same type of materials. In recent years, welded joining of different types of metallic materials has been carried out with the friction stir welding method, which is one of the solid-state welding techniques.

Solid state welding methods include one of the oldest welding methods in the world, such as forging [4]. The katana swords used by the ancient Japanese Samurai were also produced with forging welding (forged steel) [5]. Pressure and/or heat are used in solid state welds, but the effect of heat does not melt the parts and softens them [6].

The FSW method can be applied for the similar or dissimilar materials, materials which have different melting points and non-ferrous materials [7].

Singh et. al. [8] studied microstructure and mechanical behavior of friction-stir-welded magnesium alloys: as-welded and post weld heat treated conditions. The tensile strength, elongation and efficiency improved by 8.8%, 32.4%, and 3.8% after post weld heat treatment at the stir zone. Hardness of the stir zone reduced by 12.95% after heat treatment [8]. 1400 r/min tool rotation speed and 25 mm/min tool traverse feed rate were found suitable for FSW of dissimilar magnesium alloys.

Singh et. al. [9] studied investigation on the microstructure and mechanical properties of a dissimilar friction stir welded joint of magnesium alloys.

Cakan et. al. [10] applied FSW method to dissimilar pure copper and the aluminum alloy AA7075-T6 plates. A maximum tensile strength of 224 MPa obtained at 660

rpm tool rotation speed and, 32 mm/min traverse speed with same tool geometry.

Singh et. al. [11] studied influence of post welding heat treatment on the microstructure and mechanical properties of friction stir welding joint of AZ31 Mg alloy. Tensile strength and elongation of FSW joint were 145.4 ± 4.9 MPa and $9.5 \pm 0.9\%$, in their study. Tensile strength and elongation of the joint were improved by 4.74% and 15.78% after PWHT [11].

Wang et. al. [12] studied FSW and heat treatment of 7050 Aluminum Alloy. With T74 heat treatment after welding, the tensile strength of weld increased by over 12% [12].

Prasad et. al. [13] investigated mechanical properties of AA6061T6 and AA6351T6 plates joined by friction stir welding. They used vertical milling machine for FSW and 5 mm thickness Al plates. FSW process applied with different pin geometries, tool rotational speed and traverse speeds. 167.95 MPa ultimate tensile strength and 92 RHN maximum microhardness value obtained [13].

Singh et. al. [14] investigated the influence of holding time on the characteristics of friction stir welded dissimilar magnesium alloy joints during PWHT (post welding heat treatment). They applied post weld heat treatment after FSW to magnesium alloys AZ31 and AZ91 to improve characteristics and performance of welded joints. For microhardness performance, at 60 min PWHT holding time, researchers got smoother microhardness profile. PWHT joints had the highest impact energy of 4.2 J for 30 min [14].

Su et. al. [15] applied double sided(DS) FSW (compared with single sided (SD)) to 6063-T6 aluminum alloy with thickness of 10mm . 92 MPa fatigue strength obtained at DS FSW, and 76 MPa fatigue strength obtained at SS FSW [15].

Singh et. al. [16] studied influence of PWHT on FSW joint of AZ61 Mg alloy. After PWHT, the microhardness in the stirring zone was reduced approximately 16% and the percentage elongation of the weld joint was increased by 18.5%. The microstructure of the welded zone improved [16].

Hunt et. al. [17] studied a generalized Method for In-Process Defect Detection in Friction Stir Welding. In their study, it is mentioned that the welding speed is expected to be faster for FSW method, in the industry. The challenging part of the faster welding speed at FSW method, is to produce defect-free welded zone. In their study, when FSW applied to aluminum blanks at 1500 to 3000 mm/min traverse speed, their methodology succeed to detect defects and lower the cost of NDE (non-destructive evaluation) in the industry [17].

In this study, FSW application, advantages and disadvantages and usage areas of friction stir welding were examined.

2. Principle of FSW

In the FSW process, the temperature is generated by the friction between the rotating tool and the material surface, as shown in Figure 1. Materials softening along the welding line are mixed and combined with each other by giving the rotating tool a forward movement along the

material surface [19]. During this process, parameters such as the rotational speed of the rotating tool, the traverse speed, the geometry of the tool, the tilt angle of the tool, the force applied by the tool to the material and the fixation of the material affect the structure of the weld. In addition, the direction of rotation of the rotating tool (determines the advancing side and retreating side of the weld shown in Figure 1) is an effective parameter for the FSW process. Tool shoulder geometries used for friction stir welding shown in Figure 2. Examples of tools with different pin geometries are shown in Figure 3.

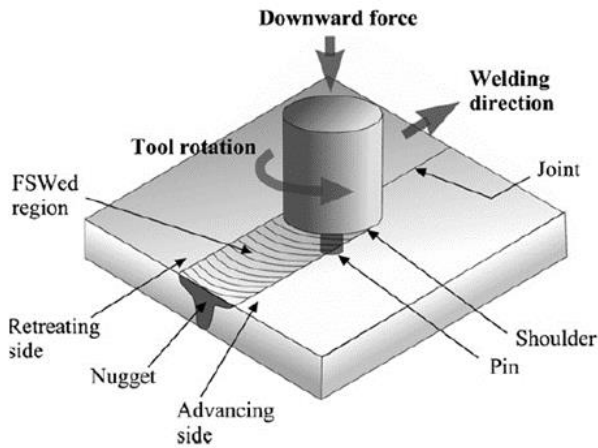

Figure 1. Schematic representation of the Friction Stir Welding process [18]

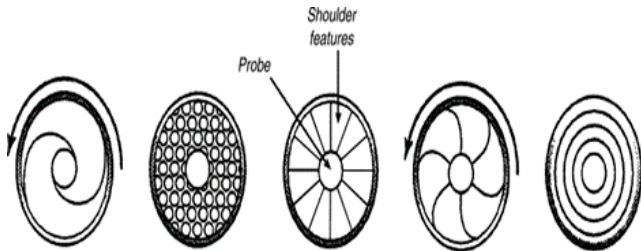

Figure 2. Tool shoulder geometries, viewed from underneath the shoulder (Copyright© 2001, TWI Ltd) (after Thomas et al. [20])



Figure 3. Examples of tools with different pin geometries [21]

2.1. Parameters of friction stir welding

The parameters that are effective in the FSW process are divided into three groups as indicated in Figure 4, these are:

- a) Tool geometry: Shoulder profile, pin profile, shoulder and pin diameter, shoulder and pin material.
- b) Welding parameters: traverse speed, rotational speed, tilt angle, etc.
- c) Other parameters: Workpiece properties, tool size, workpiece size, tool material [22]

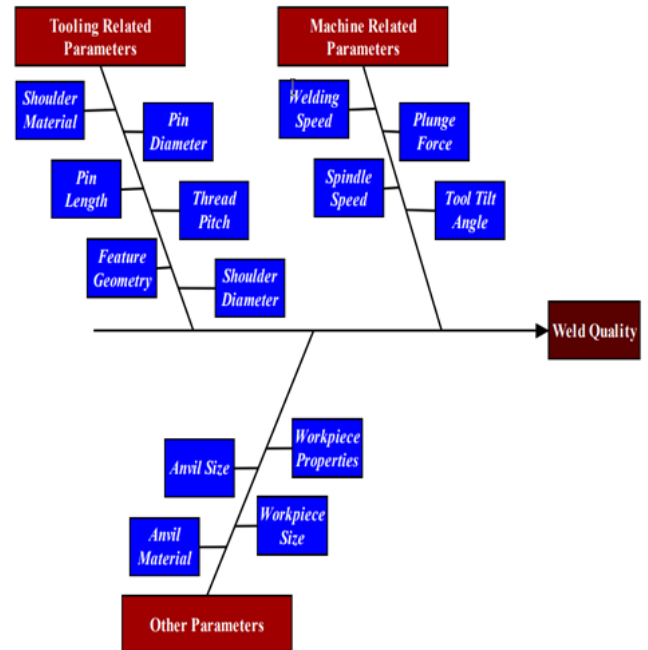

Figure 4. Parameters in the friction stir welding process [22]

2.2. Tool geometry

Tool geometry is one of the important factors to consider when joining using the FSW method. As seen in Figure 5, the tool with different geometries performs many functions such as generating heat, mixing, cutting the joint line, breaking the oxide layers, creating forging pressure and adding material to the joint. At the same time, the geometry of the tool must be able to meet the force and torque values that occur during the joining process and must be compatible with the plunge depth [23].

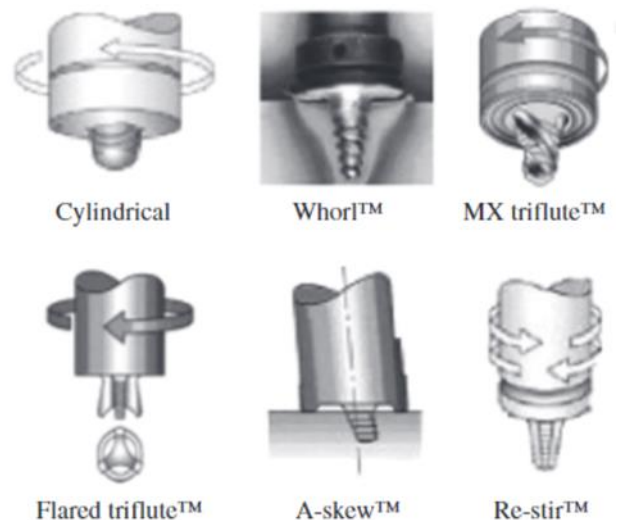

Figure 5. Tools used in the FSW method [24]

Whereas older tool designs consisted of straight, featureless shoulders and cylindrical or threaded pins, some of the earliest design innovations today were developed by Thomas et al. [20]. These innovations were the Flared-Triflute™ and Skew-Stir™ sets, indicated in Figure 5, designs aimed at increasing the degradation of the interfacial oxide layer and increasing the ITAB width especially in thrust welds [20, 23]. The Welding Institute (TWI) designed the Trivex™ tool shown in Figure 6, which can reduce process forces and are relatively easy to manufacture [23]. Studies on tool design and development focused on welded joining of many materials, especially in the welding of aluminum alloys, continues increasingly [23].



Figure 6. Trivex tool, designed by TWI [25]

Zhao et al. [26] investigated the effects of pin geometry on material flow in AA2014 butt welding. Elangovan and Balasubramanian [27] investigated the effects of AA2219 butt welds of straight cylindrical, conical cylindrical, toothed cylindrical, square and triangular profile pins on microstructure, tensile strength and microhardness. Scialpi et al. [28] investigated the effect of shoulder geometry on microstructure, strength and microhardness in butt welds of AA6082 material. The shoulder part of the tool usually includes geometries consisting of a cavity and a corner. Liu et al. [29] investigated the effects of varying shoulder and pin sizes on the microstructure and mechanical properties of 6061-T651 butt welds. It was stated that cracks formed in the low hardness region of the weld, an increase in the tensile strength of the weld area was observed with the increase in the feed rate, and the changes in the tool dimensions did not affect the welding performance.

Sorensen and Nielsen [30] designed a convex hollow shoulder assembly with spiral pins, which offers lower process forces and the ability to work with zero degree tilt angle. Longhurst [31] used a straight screw shoulder design shown in Figure 7. He stated that the shoulder design, which allows 0° axis angle, minimizes burr formation. He emphasized that the choice of pin geometry is also extremely important, along with the shoulder design, to strengthen the mix of the workpiece.

Muthu and Jayabalan [32], studied the effects of helical, flat conical and flat conical screw pin profiles on

plates joined by FSW method. They reported that they obtained better mechanical properties with the use of flat conical pin profile in the study using AA1100 series aluminum and pure copper.

Hassanifard et al. [33] employed various Friction Stir Welding (FSW) tools to investigate mechanical properties of Al 6061-T6 joints. Tensile properties of aluminum joint samples were improved as cone angle increased from 0° to 20° through different welding tools [33].

In the FSW process, the rotation speed, the traverse speed, the tool plunge force on the workpiece and the tilt angle between the tool and the workpiece constitute the welding parameters. With the rotation of the tool, the mixed material moves from the front to the back of the pin. It is extremely important for the welded joint to rotate the tool at the appropriate speed, to advance the rotating tool along the welding line at the appropriate speed, to contact the shoulder of the rotating tool to the welded parts to generate heat.



Figure 7. Tool with hollow spherical shoulder and cylindrical threaded pin [23]

The tool, which rotates faster than expected, generates more heat than necessary in the weld area, causing turbulent flow in the weld seam area. This creates micro-scale voids in the mixing zone, resulting in a decrease in strength. The low rotational speed causes not enough heat to be produced to ensure the bond, which produces a weak bond and low strength value [34–36]. Suresha et al. [37] stated that tool rotation speed is the most effective parameter on the mechanical properties of the weld when joining AA7075 aluminum alloy plates using the FSW method [22].

3. Advantages and disadvantages of friction stir welding

Advantages of friction stir welding:

- Good material mixing and seamless bonding around the interfaces [38].
- A non-consumable tool is used in the joining process performed with the FSW method [20].
- FSW can be applied as fully automatic welding process [39].
- Shielding gas and filler wire are not using at FSW method [40].
- Welding of alloys such as light and durable Aluminum 7075-T6 series, which are known as non-weldable, can be welded with FSW [41].
- Dissimilar materials can be welded [42].

- Performing the welding process at low temperature prevents welding defects such as porosity, wormholes and crack formation [43].
- FSW is a solid-state welding process [44].
- FSW is environmentally friendly [45].
- Lightweight materials such as titanium, magnesium and composite materials can be welded [46–48].
- FSW can be applied as a portable joining process [49].

The disadvantages of FSW are:

- High cost robotic systems are needed in complex geometry joints [39].

- Initial investment cost is higher than some of conventional methods [50].
- Additional apparatus is required for fixing process [51].
- Since the joining of materials with the FSW method is a solid state welding process, abrasions may occur on the rotating tool and pin during the joining of the material [52].

According to Table 1, for Al 6082 T6 alloy, mechanical properties of MIG, TIG and FS welded materials shows close values. For pure copper plates, FS welded materials shows better mechanical properties than TIG welding and mechanical properties closer to BM values.

Table 1. Comparison of material properties of FS welded, TIG and MIG Welded Materials (BM: Base Material, TS: Tensile Strength, UTS: Ultimate Tensile Strength)

Material	Yield Strength (MPa)	UTS/ TS (MPa)	Elongation (%)	References
Al 6082 T6 (BM)	291	317 (TS)	11.3	[53]
Al 6082 T6 MIG-pulse	147	221 (TS)	5.2	[53]
Al 6082 T6 TIG	145	219 (TS)	5.4	[53]
Al 6082 T6 FSW (low traverse speed)	150	245 (TS)	5.7	[53]
Pure Copper (BM)	68	212 (UTS)	28.1	[54]
Pure Copper TIG	53	168 (UTS)	12.3	[54]
Pure Copper FSW	70	194 (UTS)	22.8	[54]

4. Friction stir welding applications

4.1. Defense industry

The FSW method is used in the defense industry, in the manufacture of armored boxes, turrets and structural parts. FSW method is used for joining materials like Al 7075-T651 rolled sheet metal for structural applications in defensive areas like military [55].

Defense industry applications using the FSW method:

- FSW method can be used in light military tanks manufactured using high strength aluminum alloys.
- Military bridges and amphibious personnel carriers.
- Titanium light field howitzers [56].

There is wide interest in the defense industry in using aluminum alloys for survivability related applications. Aluminum alloys have a low density compared to existing solutions and Al alloys are relatively cost-effective compared to other light armor materials such as titanium. FSW method is preferred for welding defense industry lightweight materials, as it has nearly similar properties to the base material and provides higher strength. tank body prototype manufactured by the FSW method are shown in Figure 9.

4.2. Aerospace industry

In 1995, NASA had to use light and durable aluminum-lithium alloy material in the external fuel tank of the spacecraft. However, since these materials are difficult to weld, the fuel tanks are combined with the

FSW method [58]. The NASA SLS launch rocket produced by the FSW method is shown in Figure 10.



Figure 9. A prototype of a tank body manufactured with the FSW method [57]



Figure 10. NASA SLS launch rocket produced by the FSW method [61]

Aluminum alloys are frequently used in the aero plane industry as well as in the aerospace industry.

Parts of the fuselage structure of the Eclipse 500 private plane welded by the FSW method is shown in Figure 11 [59]. In the outer panel design of aircraft fuselages, beams riveted to the outer panel surface are used. This leads to sealing problems. FSW technology is applied to the outer panel designs of airframes, increasing the production speed and optimizing the stress, fatigue and corrosion values of the structure [60].

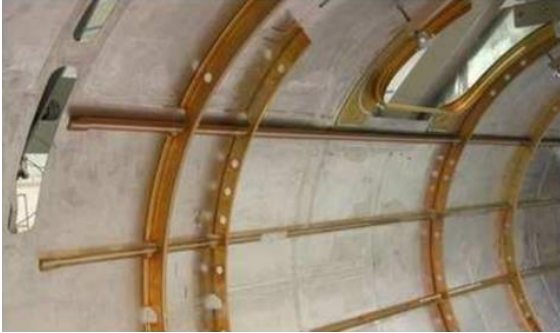

Figure 11. Demonstration of joined parts of the fuselage structure of Eclipse 500 private plane using FSW method [62]

4.3. Marine industry

Aluminum panels formed by aluminum extrusion are used in the shipbuilding industry in the shipbuilding industry, honeycomb panels, decks, helipads and some ship partitions are manufactured with FSW technology. With FSW method, modular manufacturing of ships is possible, the assembly process is accelerated, weight savings are achieved and maintenance needs are reduced [63]. FBFSW (Floating Bobbin Friction Stir Welding) technology developed for shipbuilding can be combined with a portable apparatus developed for FSW process [64]. Portable friction stir welding devices for marine applications are shown in Figure 12 and Figure 13. Portable friction stir welding (PFSW) devices can be used for repairing ships and manufacturing parts in field.

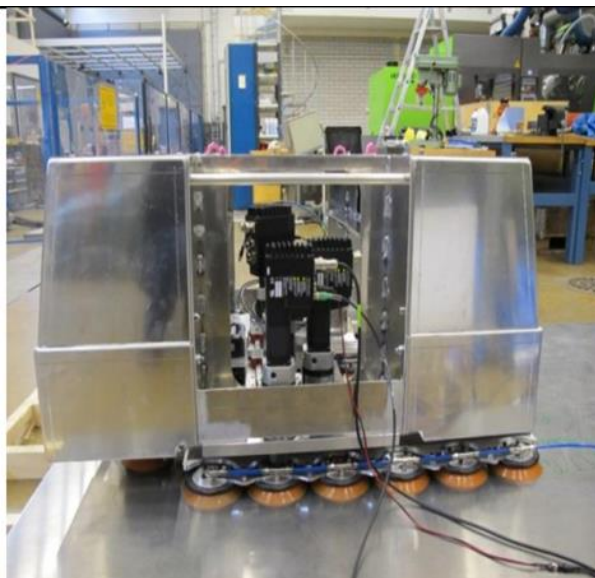

Figure 12. Portable friction stir welding device named Mobi-weld system [64]

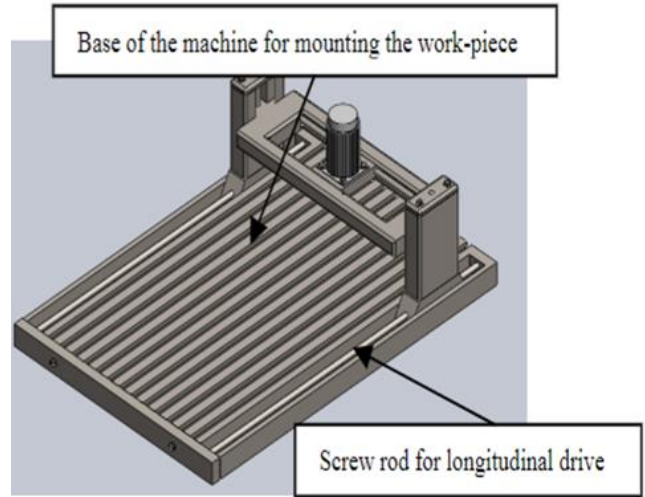

Figure 13. Portable Friction Stir Welding Device design [65]

4.4. Automotive industry

FSW and FSSW (Friction Stir Spot Welding) technology are used by manufacturers and suppliers in the automotive industry. Lightweight structures is using in Automobile components for fuel economy and meeting reduction in emissions regulation [66]. Automobile components joined with FSW are shown in Figure 14. Nowadays, aluminum is used in the cooling components of electric vehicles due to its being light weight and its thermal performance, and with the FSW method, which is the most ideal joining method for aluminum parts, is used in these parts.

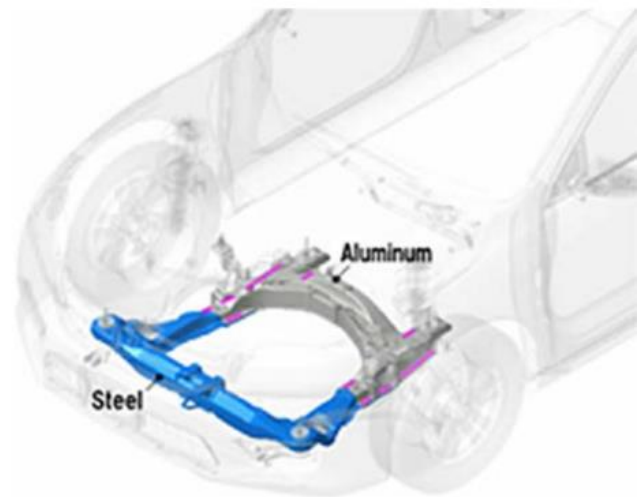

Figure 14. Friction stir spot welded dissimilar aluminum and steel sub-frame Honda Accord 2003 [67]

4.5. Railway industry

In railway industry lightweight materials can be joined with FSW method. FSW robot system for high-speed trains is shown in Figure 15.

5. Conclusion

In recent years, space travel has been on the agenda, high-speed trains have become widespread, electric

vehicles have begun to replace internal combustion engines, and developments in the field of maritime have increased the demand for light, high-strength and fast-manufacturable parts. The main materials for these fields are Aluminum 2xxx, 5xxx, 6xxx and 7xxx series materials, which are difficult or impossible to combine with conventional methods. The FSW method was a method for joining aluminum materials, but can now be used for steel, titanium and titanium alloys that need to be joined at higher temperatures.

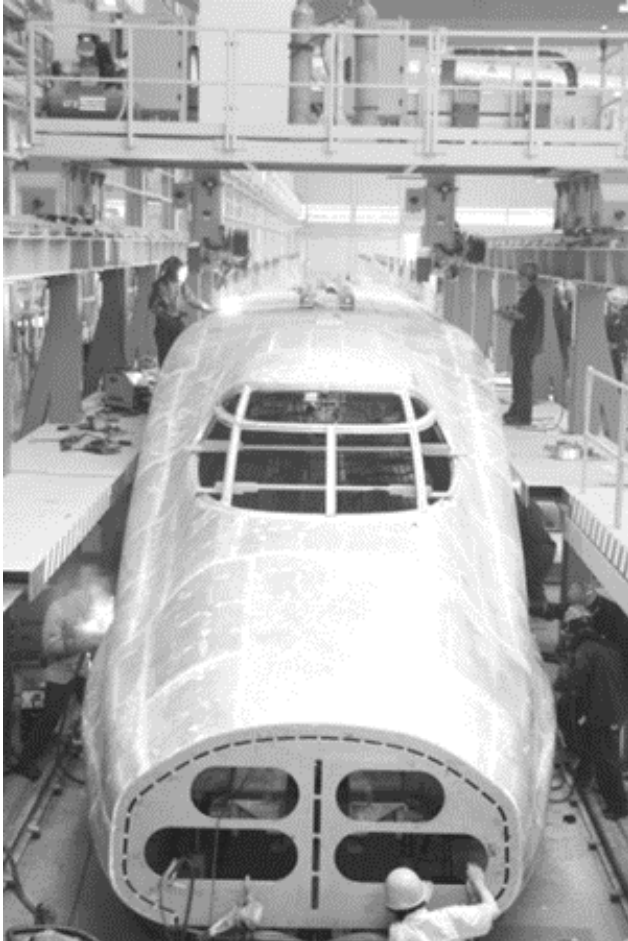

Figure 15. FSW robot system for high speed trains [68]

Friction Stir Welding method has a cost advantage besides its features such as preventing welding defects and enabling the possibility of welding, eliminating the need for filler material and being able to be applied faster. With increasing production amount, the FSW method is less costly than a conventional welding method such as MIG [69].

One of the advantages of friction stir welding over laser welding, which can be considered as an alternative, is that its parameters (rotational speed, welding traverse speed, tilt angle, axial force, probe and shoulder profile [70] are easy to apply, the laser source needs cooling and it is difficult to provide a stable energy flow. FSW technology is becoming widespread with the spread of robotic systems (for welding complex geometries), decreasing in initial investment costs, the widespread use of portable systems in repair and manufacturing, minimizing welding defects and the increasing need for lightly different materials. Additionally, FSW method is the most suitable method for combining the cooling

systems and battery systems of electric vehicles and hybrid cars. Welding dissimilar materials, plastics, ceramics, composite materials as well as steel with the FSW method is possible with the studies carried out today. The FSW method stands out as a strategic technology that is becoming widespread nowadays.

Author contributions

Emre Kaygusuz: Methodology, Writing-Reviewing, Writing-Original draft preparation. **Filiz Karaömerlioğlu and Serhat Akinci:** Writing-Reviewing and Editing.

Conflicts of interest

The authors declare no conflicts of interest.

References

1. Kutz, M. (2006). *Materials and Mechanical Design*. John Wiley & Sons.
2. Kumar, N., Mishra, R. S., & Yuan, W. (2015). *Friction stir welding of dissimilar alloys and materials*. Butterworth-Heinemann.
3. Norrish, J. (1992). *Advanced welding processes*. Springer Science & Business Media. <https://doi.org/10.1533/9781845691707.218>
4. Cooper, D. R., & Allwood, J. M. (2014). The influence of deformation conditions in solid-state aluminium weld strength. *Journal of Materials Processing Technology*, 214(11), 2576-2592. <https://doi.org/10.1016/j.jmatprotec.2014.04.018>
5. Duarte, A., Queirós, G. W., Sanchez, L. G., de Salazar, J. M. G., & Portal, A. J. C. (2018). Welding by Hot Forging of Two Carbon Steels for the Manufacture of Spanish and Japanese Weapons. *Journal of Material Sciences & Engineering*, 7(446), 2169-0022.
6. Djurdjanovic, M. B., Mijajlovic, M. M., Milcic, D. S., & Stamenkovic, D. S. (2009). Heat generation during friction stir welding process. *Tribology in industry*, 31(1&2), 8.
7. Verma, S., Kumar, V., Kumar, R., & Sidhu, R. S. (2022). Exploring the application domain of friction stir welding in aluminum and other alloys. *Materials Today: Proceedings*, 50, 1032-1042. <https://doi.org/10.1016/j.matpr.2021.07.449>
8. Singh, K., Singh, G., & Singh, H. (2019). Microstructure and mechanical behaviour of friction-stir-welded magnesium alloys: As-Welded and post weld heat treated. *Materials Today Communications*, 20, 100600. <https://doi.org/10.1016/j.mtcomm.2019.100600>
9. Singh, K., Singh, G., & Singh, H. (2019). Investigation on the microstructure and mechanical properties of a dissimilar friction stir welded joint of magnesium alloys. *Proceedings of the Institution of Mechanical Engineers, Part L: Journal of Materials: Design and*

- Applications, 233(12), 2444–2454. <https://doi.org/10.1177/1464420719865292>
10. Cakan, A., Ugurlu, M., & Kaygusuz, E. (2019). Effect of weld parameters on the microstructure and mechanical properties of dissimilar friction stir joints between pure copper and the aluminum alloy AA7075-T6, 61(2), 142–148. <https://doi.org/10.3139/120.111297>
11. Singh, K., Singh, G., & Singh, H. (2021). Influence of post welding heat treatment on the microstructure and mechanical properties of friction stir welding joint of AZ31 Mg alloy. *Proceedings of the Institution of Mechanical Engineers, Part E: Journal of Process Mechanical Engineering*, 235(5), 1375–1382. <https://doi.org/10.1177/0954408921997626>
12. Wang, T., Feng, Z., & Wang, R. (2022). Study on Friction Stir Welding and Heat Treatment of 7050 Aluminum Alloy. In B. Duan, K. Umeda, & C. Kim (Eds.), *Proceedings of the Eighth Asia International Symposium on Mechatronics* (pp. 196–202). Singapore: Springer Nature Singapore.
13. Prasad, K. A., Chand, A. A., Kumar, N. M., Narayan, S., & Mamun, K. A. (2022). A Critical Review of Power Take-Off Wave Energy Technology Leading to the Conceptual Design of a Novel Wave-Plus-Photon Energy Harvester for Island/Coastal Communities' Energy Needs. *Sustainability*, 14(4), 2354. <https://doi.org/10.3390/su14042354>
14. Singh, K., Singh, G., & Singh, H. (2022). The influence of holding time on the characteristics of friction stir welded dissimilar magnesium alloy joints during post welding heat treatment. *Proceedings of the Institution of Mechanical Engineers, Part L: Journal of Materials: Design and Applications*, 14644207221106576. <https://doi.org/10.1177/14644207221106576>
15. Su, M., Qi, X., Xu, L., Feng, Q., Han, Y., & Zhao, L. (2022). Microstructural and mechanical analysis of 6063-T6 aluminum alloy joints bonded by friction stir welding. *Journal of Materials Science*, 57(31), 15078–15093. <https://doi.org/10.1007/s10853-022-07541-w>
16. Singh, K., Sehgal, A. K., Singh, G., & Singh, H. (2022). Influence of PWHT on FSW joint of AZ61 Mg alloy. *International Conference on Latest Developments in Materials & Manufacturing*, 60, 2217–2221. <https://doi.org/10.1016/j.matpr.2022.03.117>
17. Hunt, J. B., Mazzeo, B. A., Sorensen, C. D., & Hovanski, Y. (2022). A Generalized Method for In-Process Defect Detection in Friction Stir Welding. *Journal of Manufacturing and Materials Processing*, 6(4), 80. <https://doi.org/10.3390/jmmp6040080>
18. Elatharasan, G., & V.S., S. kumar. (2013). An Experimental Analysis and Optimization of Process Parameter on Friction Stir Welding of AA 6061-T6 Aluminum Alloy using RSM. *Procedia Engineering*, 64. <https://doi.org/10.1016/j.proeng.2013.09.202>
19. Khalaf, H. I., Al-Sabur, R., Abdullah, M. E., Kubit, A., & Derazkola, H. A. (2022). Effects of Underwater Friction Stir Welding Heat Generation on Residual Stress of AA6068-T6 Aluminum Alloy. *Materials*, 15(6), 2223. <https://doi.org/10.3390/ma15062223>
20. Thomas, W. M., Johnson, K. I., & Wiesner, C. S. (2003). Friction Stir Welding – Recent Developments in Tool and Process Technologies. *Advanced Engineering Materials*, 5(7), 485–490. <https://doi.org/10.1002/adem.200300355>
21. Ahmadi, H., Arab, N. B. M., Ghasemi, F. A., & Farsani, R. E. (2012). Influence of Pin Profile on Quality of Friction Stir Lap Welds in Carbon Fiber Reinforced Polypropylene Composite. *International Journal of Mechanics and Applications*, 2(3), 24–28. <https://doi.org/10.5923/j.mechanics.20120203.01>
22. Verma, S., Gupta, M., & Misra, J. P. (2016). Friction Stir Welding of Aerospace Materials: A State of Art Review. In B. Katalinic (Ed.), *DAAAM International Scientific Book* (1st ed., Vol. 15, pp. 135–150). DAAAM International Vienna. <https://doi.org/10.2507/daaam.scibook.2016.13>
23. Gibson, B. T., Lammlein, D. H., Prater, T. J., Longhurst, W. R., Cox, C. D., Ballun, M. C., ... Strauss, A. M. (2014). Friction stir welding: Process, automation, and control. *Journal of Manufacturing Processes*, 16(1), 56–73. <https://doi.org/10.1016/j.jmapro.2013.04.002>
24. He, X., Gu, F., & Ball, A. (2014). A review of numerical analysis of friction stir welding. *Progress in Materials Science*, 65, 1–66. <https://doi.org/10.1016/j.pmatsci.2014.03.003>
25. Bhardwaj, N., Narayanan, R. G., Dixit, U. S., & Hashmi, M. S. J. (2019). Recent developments in friction stir welding and resulting industrial practices. *Advances in Materials and Processing Technologies*, 5(3), 461–496. <https://doi.org/10.1080/2374068X.2019.1631065>
26. Zhao, Y. H., Lin, S. B., Qu, F. X., & Wu, L. (2006). Influence of pin geometry on material flow in friction stir welding process. *Materials science and technology*, 22(1), 45–50. <https://doi.org/10.1179/174328406X78424>
27. Elangovan, K., & Balasubramanian, V. (2008). Influences of tool pin profile and welding speed on the formation of friction stir processing zone in AA2219 aluminium alloy. *Journal of Materials Processing Technology*, 200(1–3), 163–175. <https://doi.org/10.1016/j.jmatprotec.2007.09.019>
28. Scialpi, A., De Filippis, L. A. C., & Cavaliere, P. (2007). Influence of shoulder geometry on microstructure and mechanical properties of friction stir welded 6082 aluminium alloy. *Materials and Design*, 28(4), 1124–1129. <https://doi.org/10.1016/j.matdes.2006.01.031>
29. Liu, F. C., & Ma, Z. Y. (2008). Influence of tool dimension and welding parameters on microstructure and mechanical properties of friction-stir-welded 6061-T651 aluminum alloy. *Metallurgical and Materials Transactions A: Physical Metallurgy and Materials Science*, 39(10), 2378–2388. <https://doi.org/10.1007/s11661-008-9586-2>
30. Sorensen, C., & Nielsen, B. (2009). Exploring Geometry Effects for Convex Scrolled Shoulder, Step Spiral Probe FSW Tools. In *The Materials Society Annual Meeting* (pp. 85–92).

31. Longhurst, W. R. (2009). Force Control of Friction Stir Welding, 229.
32. Muthu, M. F. X., & Jayabalan, V. (2016). Effect of pin profile and process parameters on microstructure and mechanical properties of friction stir welded Al-Cu joints. *Transactions of Nonferrous Metals Society of China*, 26(4), 984-993. [https://doi.org/10.1016/S1003-6326\(16\)64195-X](https://doi.org/10.1016/S1003-6326(16)64195-X)
33. Hassanifard, S., Ghiasvand, A., Hashemi, S. M., & Varvani-Farahani, A. (2022). The effect of the friction stir welding tool shape on tensile properties of welded Al 6061-T6 joints. *Materials Today Communications*, 31, 103457. <https://doi.org/10.1016/j.mtcomm.2022.103457>
34. Azimzadegan, T., & Serajzadeh, S. (2010). An investigation into microstructures and mechanical properties of AA7075-T6 during friction stir welding at relatively high rotational speeds. *Journal of Materials Engineering and Performance*, 19(9), 1256-1263. <https://doi.org/10.1007/s11665-010-9625-1>
35. Dinaharan, I., & Murugan, N. (2012). Optimization of friction stir welding process to maximize tensile strength of AA6061/ZrB 2 in-situ composite butt joints. *Metals and Materials International*, 18(1), 135-142. <https://doi.org/10.1007/s12540-012-0016-z>
36. Heidarzadeh, A., Khodaverdizadeh, H., Mahmoudi, A., & Nazari, E. (2012). Tensile behavior of friction stir welded AA 6061-T4 aluminum alloy joints. *Materials and Design*, 37, 166-173. <https://doi.org/10.1016/j.matdes.2011.12.022>
37. Suresha, C. N., Rajaprakash, B. M., & Upadhy, S. (2011). A Study of the Effect of Tool Pin Profiles on Tensile Strength of Welded Joints Produced Using Friction Stir Welding Process. *Materials and Manufacturing Processes*, 26(9), 1111-1116. <https://doi.org/10.1080/10426914.2010.532527>
38. Guo, J., Gougeon, P., & Chen, X. G. (2012). Microstructure evolution and mechanical properties of dissimilar friction stir welded joints between AA1100-B4C MMC and AA6063 alloy. *Materials Science and Engineering: A*, 553, 149-156. <https://doi.org/10.1016/j.msea.2012.06.004>
39. Mendes, N., Neto, P., Simão, M. A., Loureiro, A., & Pires, J. N. (2016). A novel friction stir welding robotic platform: welding polymeric materials. *The International Journal of Advanced Manufacturing Technology*, 85(1), 37-46. <https://doi.org/10.1007/s00170-014-6024-z>
40. Shah, S., & Tosunoglu, S. (2012). Friction Stir Welding: Current State of the Art and Future Prospects, 7.
41. Goloborodko, A., Ito, T., Yun, X., Motohashi, Y., & Itoh, G. (2004). Friction Stir Welding of a Commercial 7075-T6 Aluminum Alloy: Grain Refinement, Thermal Stability and Tensile Properties. *Materials Transactions*, 45, 2503-2508. <https://doi.org/10.2320/matertrans.45.2503>
42. Murr, L. E. (2010). A Review of FSW Research on Dissimilar Metal and Alloy Systems. *Journal of Materials Engineering and Performance*, 19(8), 1071-1089. <https://doi.org/10.1007/s11665-010-9598-0>
43. Albannai, A. I. (2020). Review the common defects in friction stir welding. *International Journal of Scientific & Technology Research*, 9(11), 318-329.
44. Mahoney, M. W., Rhodes, C. G., Flintoff, J. G., Bingel, W. H., & Spurling, R. A. (1998). Properties of friction-stir-welded 7075 T651 aluminum. *Metallurgical and Materials Transactions A*, 29(7), 1955-1964. <https://doi.org/10.1007/s11661-998-0021-5>
45. Swarnkar, A., Kumar, R., Suri, A., & Saha, A. (2016, December). A review on Friction Stir Welding: An environment friendly welding technique. In *2016 IEEE Region 10 Humanitarian Technology Conference (R10-HTC)* (pp. 1-4). IEEE. <https://doi.org/10.1109/R10-HTC.2016.7906807>
46. Liu, H. J., Zhou, L., Huang, Y. X., & Liu, Q. W. (2010). Study of the key issues of friction stir welding of titanium alloy. In *Materials Science Forum* (Vol. 638, pp. 1185-1190). Trans Tech Publications Ltd. <https://doi.org/10.4028/www.scientific.net/MSF.638-642.1185>
47. Singh, K., Singh, G., & Singh, H. (2018). Review on friction stir welding of magnesium alloys. *Journal of Magnesium and Alloys*, 6(4), 399-416. <https://doi.org/10.1016/j.jma.2018.06.001>
48. Kumar, N., Das, A., & Prasad, S. B. (2020). An analysis of friction stir welding (FSW) of metal matrix composites (MMCs). *Materials Today: Proceedings*, 26, 2650-2656. <https://doi.org/10.1016/j.matpr.2020.02.558>
49. Dos Santos, J. F., Staron, P., Fischer, T., Robson, J. D., Kostka, A., Colegrove, P., ... & Schreyer, A. (2018). Understanding precipitate evolution during friction stir welding of Al-Zn-Mg-Cu alloy through in-situ measurement coupled with simulation. *Acta Materialia*, 148, 163-172. <https://doi.org/10.1016/j.actamat.2018.01.020>
50. Strand, S. (2003, September). Joining plastics-can friction stir welding compete?. In *Proceedings: Electrical Insulation Conference and Electrical Manufacturing and Coil Winding Technology Conference (Cat. No. 03CH37480)* (pp. 321-326). IEEE. <https://doi.org/10.1109/EICEMC.2003.1247904>
51. Doos, Q. M., & Wahab, B. A. (2012). Experimental study of friction stir welding of 6061-T6 aluminum pipe. *International Journal of Mechanical Engineering and Robotics Research*, 1(3), 143-156.
52. Campanelli, S., Casalino, G., Casavola, C., & Moramarco, V. (2013). Analysis and Comparison of Friction Stir Welding and Laser Assisted Friction Stir Welding of Aluminum Alloy. *Materials*, 6(12), 5923-5941. <https://doi.org/10.3390/ma6125923>
53. Taban, E., & Kaluç, E. (2007). Comparison between microstructure characteristics and joint performance of 5086-H32 aluminium alloy welded by MIG, TIG and friction stir welding processes. *Kovove Materialy*, 45, 241-248.
54. Lin, J. W., Chang, H. C., & Wu, M. H. (2014). Comparison of mechanical properties of pure copper welded using friction stir welding and tungsten inert gas welding. *Journal of Manufacturing Processes*, 16(2), 296-304. <https://doi.org/10.1016/j.jmappro.2013.09.006>

55. Ikumapayi, O. M., & Akinlabi, E. T. (2019). Efficacy of α - β grade titanium alloy powder (Ti-6Al-2Sn-2Zr-2Mo-2Cr-0.25Si) in surface modification and corrosion mitigation in 3.5% NaCl on friction stir processed armour grade 7075-T651 aluminum alloys—insight in defence applications. *Materials Research Express*, 6(7), 076546. <https://doi.org/10.1088/2053-1591/ab1566>
56. Wells, M., Roopchand, B., Montgomery, J., & Gooch, W. (1998). Titanium Applications and R&D for Army Ground Systems TMS Non-Aerospace Applications of Titanium.
57. Burgess, V., & Rickert, R. (2019). Investigation in Friction Stir Welded Aluminum Alloy 2139-T8 for Hull Structure Applications, 27.
58. Ding, J., Carter, B., Lawless, K., Nunes, A., Russell, C., Suites, M., & Schneider, J. (2006). A Decade of Friction Stir Welding R and D at NASA's Marshall Space Flight Center and a Glance into the Future. NTRS - NASA Technical Reports Server, (20080009619).
59. Sergeeva, E. V. (2013). Friction stir welding in aerospace industry. *The Paton Welding Journal*, 5, 56-60.
60. Srubar, M. (2021). Application of friction stir welding in aircraft structures.
61. Ding, J., Michael, F., & Sowards, J. W. (2020). To the Moon, Mars, and Beyond: NASA's Space Launch System. *Welding Journal*, 60.
62. Leon, J. S., Bharathiraja, G., & Jayakumar, V. (2020). A review on Friction Stir Welding in Aluminium Alloys. *IOP Conference Series: Materials Science and Engineering*, 954(1), 012007. <https://doi.org/10.1088/1757-899x/954/1/012007>
63. Singh, P., Biswas, P., & Kore, S. D. (2019). Influence of Traverse Speed in Self-Reacting FSW of AA6061-T6. *Journal of Ship Production and Design*.
64. Martin, J., & Wei, S. (2015). Friction Stir Welding Technology for Marine Applications (pp. 217-226). <https://doi.org/10.1002/9781119093343.ch24>
65. Renish, R. R., Pranesh, M. A., & Logesh, K. (2018). Design and analysis of a portable friction stir welding machine. *Materials Today: Proceedings*, 5(9, Part 3), 19340-19348. <https://doi.org/10.1016/j.matpr.2018.06.293>
66. Kayode, O., & Akinlabi, E. T. (2019). An overview on joining of aluminium and magnesium alloys using friction stir welding (FSW) for automotive lightweight applications (Vol. 6). IOP Publishing. Retrieved from <https://doi.org/10.1088/2053-1591/ab3262>
67. Kusuda, Y. (2013). Honda develops robotized FSW technology to weld steel and aluminum and applied it to a mass-production vehicle. *Industrial Robot: An International Journal*, 40(3), 208-212. <https://doi.org/10.1108/01439911311309889>
68. Lee, S. C. (2013). Technologies for Robotized Welding of Big Aluminium Structures with Tolerances for High Speed Trains. *Journal of the Korean Welding and Joining Society*, 31(1), 33-37. <https://doi.org/10.5781/KWJS.2013.31.1.33>
69. Mononen, J., Sirén, M., & Hänninen, H. (2003). Cost Comparison of FSW and MIG Welded Aluminium Panels. *Welding in the World*, 47(11-12), 32-35. <https://doi.org/10.1007/BF03266406>
70. Gite, R. A., Loharkar, P. K., & Shimpi, R. (2019). Friction stir welding parameters and application: A review. *Materials Today: Proceedings*, 19, 361-365. <https://doi.org/10.1016/j.matpr.2019.07.613>



© Author(s) 2023. This work is distributed under <https://creativecommons.org/licenses/by-sa/4.0/>