

# Investigation of Metallurgical Characterization and Mechanical Behaviour for Submerged Flux Cored Arc Welding Process

Erhan ÖZKAN<sup>1</sup> 

<sup>1</sup>Bornova, 35040 Izmir, Turkey

*Received:* 25/05/2023

*Accepted:* 07/08/2023

*Published Online:* 05/09/2023

## Abstract

In this study, the mechanical and metallurgical properties of the welding materials obtained from the combination of submerged arc welding powder and flux cored wire were discussed in detail for the first time in the sector. Chemical analysis of flux cored wire and submerged arc welding powder combination was carried out on the St-52 (S355) quality 300x180x20 mm sized low carbon steel materials. For mechanical tests, a gap of 16 mm was left between the materials and 10 mm thick S355 quality metal base was placed under the parts. Combining welding operations were 29 Volt voltage, 460 Ampere current, 450 mm/min welding speed, 1.75 kJ/mm heat input and 30 mm free wire length. Microstructural properties were determined by metallographic methods and confirmed by mechanical properties. As a result of the evaluation of all the data obtained, the synergistic effect of the high efficiency of the flux cored wire method and the high energy input of the submerged arc welding method was observed, and the results were conveyed to the readers in detail.

## Key Words

*Submerged Arc Welding, Flux Cored Wire, Mechanical and Metallurgical Properties.*

# Tozaltı Özlü Ark Kaynağı Prosesinin Metalurjik Karakterizasyon ve Mekanik Davranışlarının İncelenmesi

## Öz

Bu çalışmada sektörde ilk kez tozaltı kaynak tozu ile özlü telin birleşiminden elde edilen kaynak malzemelerinin mekanik ve metalurjik özellikleri detaylı olarak ele alınmıştır. Özlü tel ve tozaltı kaynak tozu kombinasyonunun kimyasal analizleri St-52 (S355) kalite 300x180x20 mm ebadında düşük karbonlu çelik malzemeler üzerinde yapılmıştır. Mekanik testler için malzemeler arasında 16 mm boşluk bırakılmış ve parçaların altına 10 mm kalınlığında S355 kalite metal altlık yerleştirilmiştir. Kombine kaynak işlemleri 29 Volt gerilim, 460 Amper akım, 450 mm/dk kaynak hızı, 1,75 kJ/mm ısı girdisi ve 30 mm serbest tel uzunluğu altında gerçekleştirilmiştir. Mikroyapısal özellikler metalografik yöntemlerle belirlenmiş ve mekanik özelliklerle doğrulanmıştır. Elde edilen tüm verilerin değerlendirilmesi sonucunda özlü tel yönteminin yüksek verimi ile tozaltı kaynak yönteminin yüksek enerji girdisinin sinerjistik etkisi gözlemlenmiş ve sonuçlar detaylı olarak okuyuculara aktarılmıştır.

## Anahtar Kelimeler

*Tozaltı Ark Kaynağı, Özlü Tel Kaynağı, Mekanik ve Metalurjik Özellikler.*

\*Sorumlu Yazar: [erhanozkan81@icloud.com](mailto:erhanozkan81@icloud.com)

To cite this article: Erhan ÖZKAN., Investigation of Metallurgical Characterization and Mechanical Behaviour for Submerged Flux Cored Arc Welding Process, Journal of Steel Research and Development, 4(1), 1-9.



## 1. Introduction

Low carbon non-alloy steels for industrial applications are one of the indispensable material groups (Wang et al., 2020). Their low cost, easy availability, suitability for various operations is among the main reasons why these materials are popular (Meng et al., 2021). The welding method is an excellent option for production activities such as production, repair, maintenance and joining of these steel types (Oliviera et al., 2020, and Yang et al., 2021)

Welding procedures are covered in two main groups as melting and solid state (phase) welding. In fusion welding, the base metal is melted by using heat (Kumar et al., 2020). Most smelting molten bath to facilitate the process and increase the strength of the joint by adding filler metal. Submerged arc welding is commonly preferred for large and thick pieces (Karayel and Bozkurt, 2020). It is a method that does not require a welder's talent, is partially prone to automation, and has very good mechanical properties due to high heat input. While the advantage of the method is very high efficiency due to the recycle of the powder in mass production, the difficulties in single production of complex shaped and thin parts constitute its disadvantage (Elsheikh, 2023). From the temperature of the arc formed between the welding wire and the workpiece, wire, powder, and base metal some of them melt and provide the desired union. The arc is constantly under a pile of flux (Archerjee, 2020). The combustion of this method has caused to be called submerged arc welding. Submerged arc welding powder funnel called head, wire advancing mechanism and adjustment control group, special mounted on a trolley that moves on rails and pallets car speed resource it is kept constant throughout the process, otherwise the seam will not be homogeneous (Fan et al., 2021). Welding speed and car speed are not standalone parameters, a good weld link setting them together is obtained as a result. Although it has high melting power and welding speed, it can be used in various types of steels (Pandya et al., 2021). This method, which is also very suitable for welding, with the production of boilers, profiles, vessels and pressure vessels. It is used extensively in fill welding processes (Shen et al., 2020). The main application areas of submerged arc welding are: welding automation systems, steel constructions, shipbuilding, boiler, warehouse, tank (internal and external sources), open and closed profiles, heavy machinery manufacturing, pipe welds (round, longitudinal, internal, external, spiral pipe welds), bridge, crane, metal plating, filling welds (Wang and Wang, 2019). The advantages of submerged arc welding can be presented under the following headings: high welding power and welding speed, deep penetration, energy economy, electrode economy, smooth appearance (aesthetic) weld seam, the welder does not affect the weld seam quality as a factor, high arc stability, no need for special protective equipment, continuous welding, multiple welding processes welding with wire (Zhou et al., 2022).

Flux cored wire welding method, mainly MIG/MAG with normal solid electrode instead of solid wire as in welding, inside, covered electrodes called "core" gas metal arc using tubular electrodes filled with minerals acting as a cover is the welding method. In welding applications with cored wire electrode, the arc created between the part provides the heat required for welding ionized gas traveling the current in the environment creates an arc (Bembenek et al., 2022). Molten metal in the weld area or from outside resulting from a protective gas cover applied or the composition of the essence protected by a shielding gas atmosphere. Here the essence describes the role of the cover on the covered electrode undertakes. The molten electrode metal is carried by the arc into the weld pool and solidified a slag layer is formed on the bath, which can be easily cleaned (Tembach et al., 2021).

Core wire electrodes are made of various powdered components placed in their interiors. Versatile use thanks to the fact that the components of the essence can be changed according to the purpose have features (Xing et al., 2020). Today, various core electrodes have been developed for different welding methods and different materials application. Advantages of cored wires that, they have a high melting rate, therefore at higher welding speeds they can be used, can be welded in any position using fine-diameter electrodes, some types of cored electrodes do not require shielding gas, which makes the equipment allows for simplification, has all the advantages of implicit electrodes, however, loss of core there are no limitations such as time loss for electrode replacement (Park et al., 2021). Despite all these advantages, the main disadvantage of cored electrode welding is only used in iron-based materials and nickel-based alloys. The slag that needs to be cleaned requires separate treatment and causes corrosion and must be removed before painting to prevent welding equipment and electrode prices are expensive. As a result, the increase in productivity, depending on the increase in production capacity, provides the price balance (Zhao et al., 2020).

The main purpose of this article is to optimize the manufacturing of submerged arc flux and flux cored wire combination by considering the mechanical properties of weld metals with investigating its metallurgical properties. In this direction welding tests were carried out on low carbon steel surfaces with the combination of submerged arc welding and flux cored wire. Tensile and notch impact strength tests of welded materials were carried out, and metallurgical properties such as microstructure, chemical analysis, and diffusible hydrogen were explained in detail. As a result, the combination of submerged arc welding powder and flux cored wire showed a higher result than either method alone.

## 2. Material and Method

The production of flux cored welding wires and submerged powders was carried out in Oerlikon Kaynak Elektrodları ve Sanayi A.Ş. Flux cored wire, submerged arc welding powder and combinations of these two were carried out with fillings of mechanical and metallurgical tests. Kocaer St-52 (S355) quality 300x180x20 mm sized low carbon steel materials were used for this purpose. Eldor 300x180x20 mm joint welding was made with materials; tensile, notch impact, microstructure and welding chemical composition properties of the metal were investigated. In welding processes, MagmaWeld GKG 350 welding machine for cored wires, submerged arc welding Oerlikon SG 100 three-unit and Solid-State LT submerged arc welding tractor for welding were used, respectively.

Characterization processes were carried out in Ege University, Dokuz Eylül University, and Oerlikon quality laboratories. Chemical composition of base material and weld seams ARL 4460 Optical Measured with Emission Device. Agglomeration analyses, cored wire dry mix analyses and oxide in weld metal analyses were determined with the Tescom ARL ADVANTX XRF Device. Agglomeration and sieve analysis of cored wire dry mix Kaltest Aryom AG070 brand determined with a motorized sieve analyser. Carbon and sulphur values of the same inputs have been characterized by the METLAB C-S DIKKAN DETERMINATOR device. Macro pictures of weld deposits by Nikon SMZ DEU 1000 and micro images have been taken by Nikon LV ITU 150 devices. Dry mix and weld metal moisture values detected by Sortorus MA EGE 30 Moisture Analyzer.

The amounts of diffusible hydrogen were detected in accordance with the EN ISO 3690 standard. The powders to be tested before the diffusible hydrogen test was dried at 350 °C for 2 hours. Triple test pieces have been prepared as specified in EN ISO 3690 and boiled. During the welding process, the welding speed was set on the centre of the test pieces. Stacked weld metal weight ~4 gr. was set to fulfil the requirements. Then diffusible hydrogen determination was carried out with BRUKER G4 PHOENIX Analyses device. Tensile samples were prepared according to EN ISO 5178 standard. Notch impact samples were 55x10x10 mm in size regarding to EN ISO 9016. The samples were prepared by processing on lathe and milling machines. In Figure 1, drawing from the weld metal and a schematic representation of the preparation of notch impact samples was given.

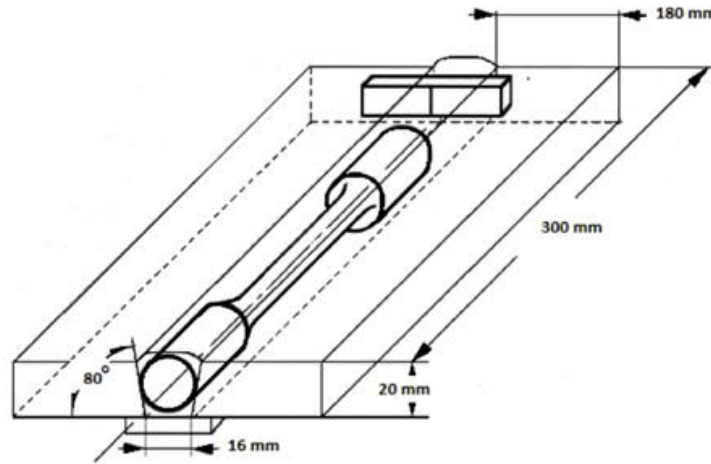

**Figure 1.** Schematic Representation of Preparation of Tensile and Notch Impact Specimens (Keehan, 2006).

After filling the welds with the parameters specified in the standard, the processes of butt weld samples were started. The actual photos of the process and test sample are shown in the Figure 2.

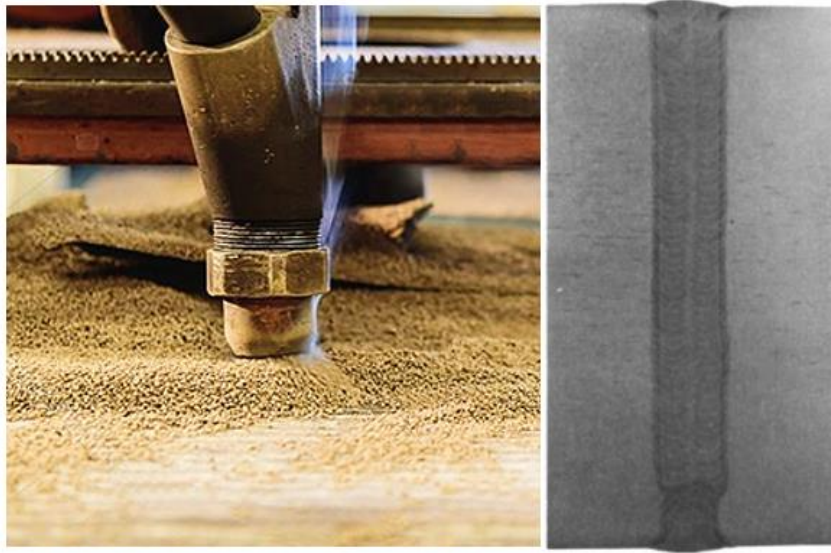

**Figure 2.** Actual Photos of the Process and Test Piece.

Notch impact tests were carried out by using OTTO WOLPERT WERKE PW 30/15 device at  $-20^{\circ}\text{C}$  temperature. Moreover, tensile tests were done with the brand OTTO WOLPERT U-40 type traction device at room temperature.

The microstructure samples were prepared with polyester moulded samples by STRUERS Tegrapol-21 brand sanding and polishing device and 600 grades SiC sandpaper  $90^{\circ}$  each time with 220 grade  $9\ \mu\text{m}$ ,  $3\ \mu\text{m}$  and  $1\ \mu\text{m}$  felt and diamond pastes, respectively. The have been sanded and polished by rotating degrees and were ready for the etching process. The microstructure samples were etched with 3% Nital solution. The microstructure examination was done with NIKON ECLIPSE LV 150 brand optical microscope. In these investigations, ferrite-perlite ratios, inclusion amounts, and average grain size of each sample were examined.

### 3. Results

Alumina basic character submerged arc welding powder and  $\text{Ø}1.20\ \text{mm}$  diameter unalloyed cored wire and weight percent chemical analyses of the weld metal performed with unalloyed solid wire are shown in Table 1.

**Table 1.** Weld Deposits Chemical Analyses (%Weight)

%Element	C	Si	Mn	P	S	Cu	Al	Ti	B
Flux Cored	0.07	0.55	1.25	0.007	0.006	0.04	0.0001	0.0050	0.0030
Submerged	0.07	0.65	1.30	0.008	0.007	0.03	0.0002	0.0040	0.0020
Combination	0.07	0.60	1.20	0.006	0.005	0.03	0.0001	0.0030	0.0025

The current values during the welding procedure of the flux cored submerged arc and the combination of both are given in the Table 2.

**Table 2.** Current Values of the Weld Materials

Type	Flux Cored	Submerged	Combination
Minimum Current (Ampere)	80	110	50
Maximum Current (Ampere)	130	190	250

The microstructure of the submerged arc weld and flux cored reinforced submerged arc welding deposits were illustrated in the Figure 3.

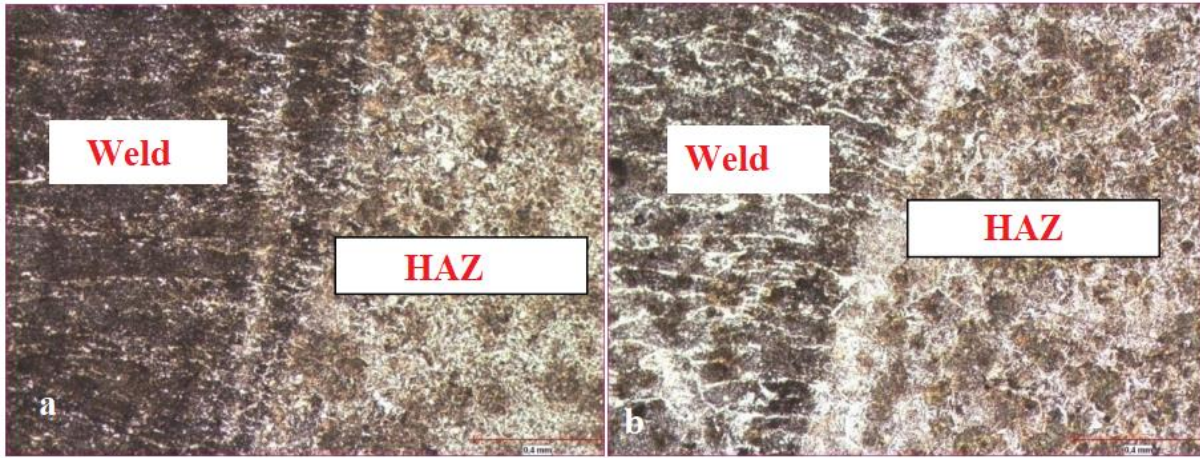

**Figure 3.** Weld Metal Macrostructure of Submerged Arc (a), Flux Cored Wire Reinforced Submerged Arc (b).

One of the important features of submerged arc welding powder is the number of cycles, which means reuse. The higher the number of cycles, the greater the savings. Sieve analyses were selected from 0 to 1750 microns in the range where the particle sizes would increase by 250 microns and the cycle numbers were calculated according to this range. There is no defined sample weight value for welding powder sieve analysis in the literature. In order to obtain the correct data, sieve analyses were carried out from one kilogram of submerged welding powder. Calculations were made according to the weight percent of the range in microns of a kilogram of submerged welding powder. The sieve analyses of the flux cored reinforced flux with zero and five cycles are shown in Table 3.

**Table 3.** Sieve Analysis of Welding Powder at the End of 0 Cycles and 5 Cycles.

Sieve (µm)	0 Cycle	5 Cycles
1750-1500	5	15
1500-1250	10	20
1250-1000	20	35
1000-750	35	15
750-500	15	10
500-250	10	5
250-0	5	0

The change in powder particle size after 0 cycles and 5 cycles is shown in the Figure 4.

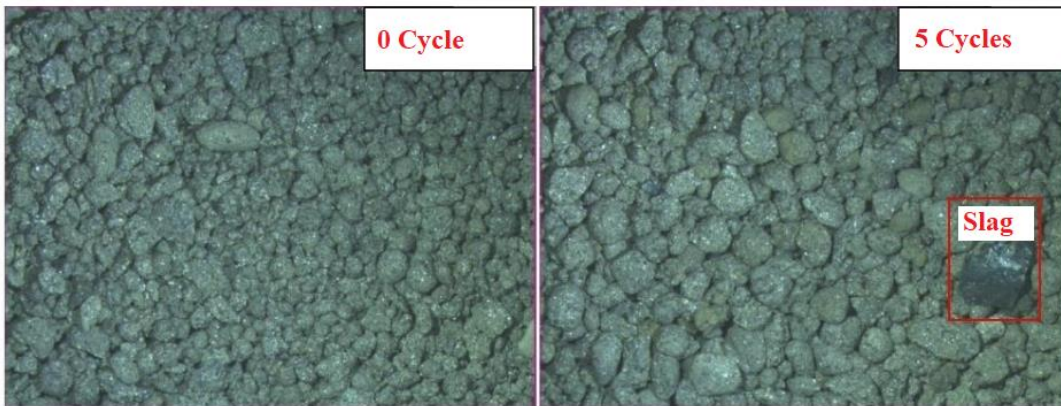

**Figure 4.** Comparison Image of the 0 and 5 Cycles of the Reinforced System Flux.

A single tensile and three notch impact test samples were prepared according to EN ISO 5178 and EN ISO 9016 standards, respectively. Charpy impact test results were evaluated by taking the average values of three test samples, in case of deviation greater than ten percent, it was suggested to repeat the test, but the standard deviation of the three impact test results was determined as  $\pm 5$  joules in each trial. The effect of the grain size to the mechanical properties is given in Table 4. Yield strength, tensile strength at the room temperature, and the Charpy notch impact test values at  $-20\text{ }^{\circ}\text{C}$  were defined for the submerged arc welding and flux cored wire combination.

**Table 4.** Effect of Grain Size on the Mechanical Behaviours.

Grain Size ( $\mu\text{m}$ )	Yield Strength ( $\text{N}/\text{mm}^2$ )	Tensile Strength ( $\text{N}/\text{mm}^2$ )	Charpy Impact Test (Joule)
10	492	578	60 (62-59-61)
50	495	577	57 (54-59-58)
100	493	581	66 (68-65-64)
250	496	575	59 (61-58-59)
350	494	576	61 (59-62-61)

Diffusible hydrogen values against the changing particle size on the submerged arc welding and reinforced submerged arc welding are shown in Table 5.

**Table 5.** Measured Diffusive Hydrogen Values Depending on Particle Size.

Particle Size ( $\mu\text{m}$ )	Diffusible Hydrogen (ml/100 gr)	
	Submerged Arc Welding	Combination
1750-1500	8.00	5.91
1500-1250	7.09	4.59
1250-1000	5.87	4.01
1000-750	4.35	3.47
750-500	4.29	3.16
500-250	4.11	3.03
250-0	3.97	2.81

The microstructure of the changing particle size on the weld deposits is pointed (Figure 5).

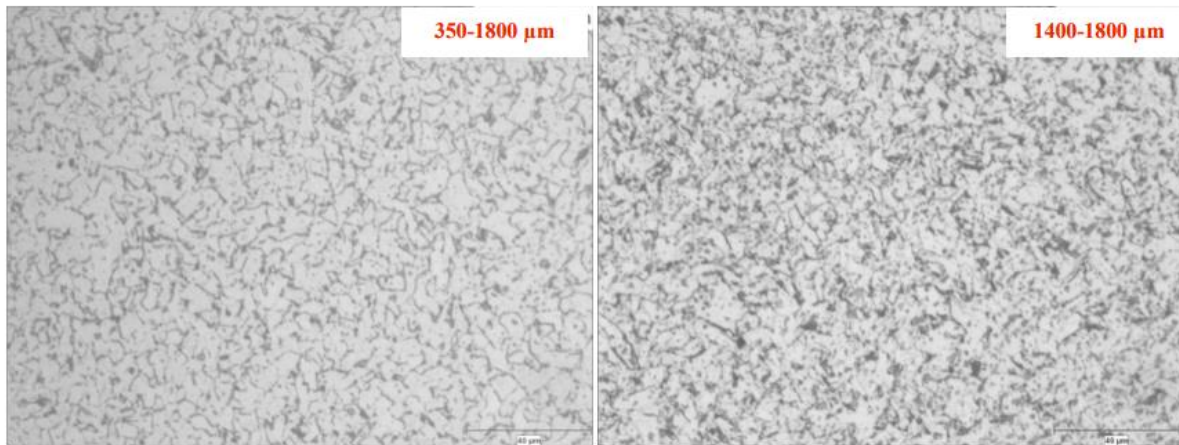

**Figure 5.** Microstructure Image of Weld Metal with Coarse (Left) and Fine (Right) Particles.

The ferrite / perlite ratio measured in the weld seam, the number of inclusions and average grain sizes are shown in the Table 6.

**Table 6.** Microstructure Evaluation for ASTM.

Particle Size ( $\mu\text{m}$ )	Ferrite / Perlite (Ratio)	Inclusion (%)	Grain Size ( $\mu\text{m}$ )	ASTM No (Number)
350 – 1800	85/15	0.56	13	9.5
1400 – 1800	85/15	0.77	13	9.5

The surface quality of the AFM images for the submerged arc welding wire is given in the Figure 6.

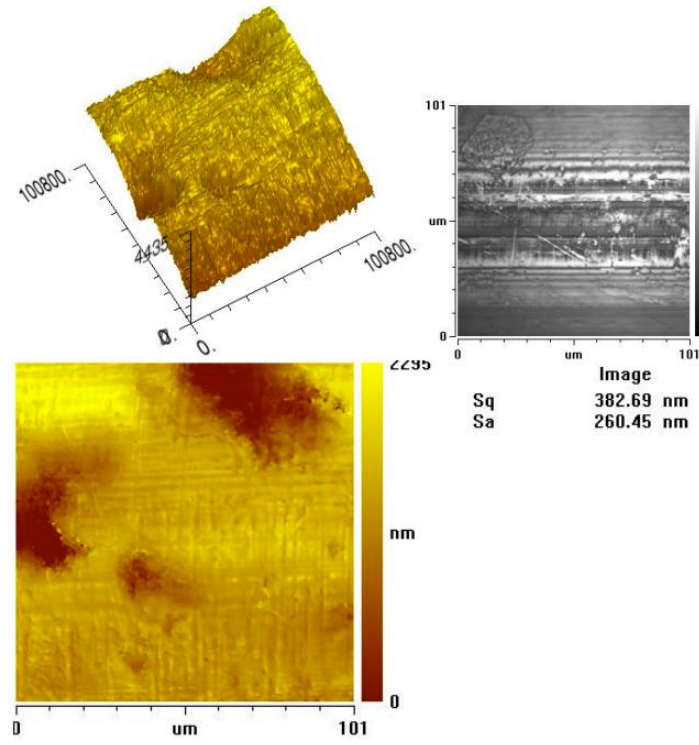

**Figure 6.** AFM Image of Submerged Arc Welding Wire.

The flux cored and submerged arc welding wire combination surface roughness and morphology is shown in Figure 7.

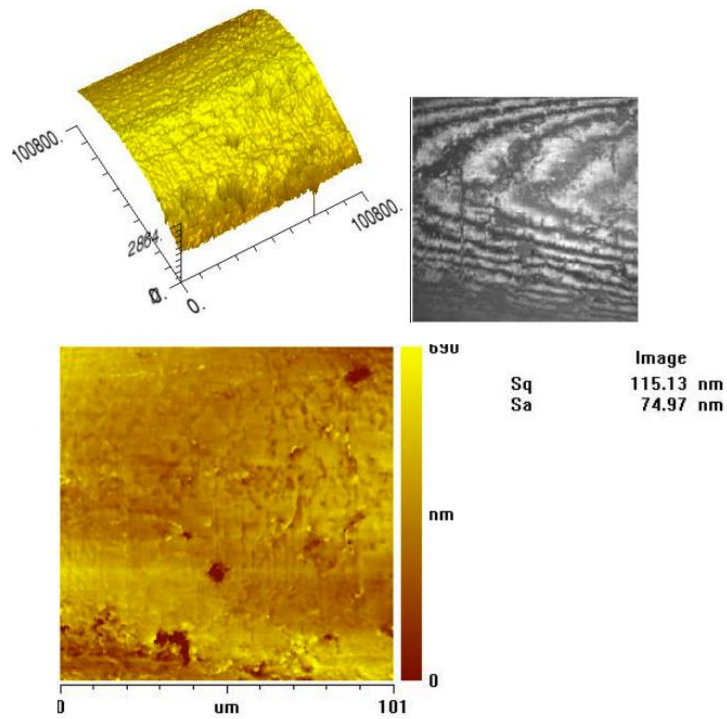

**Figure 7.** AFM Image of Combination Wire.

#### **4. Conclusion**

At the end of this study, welding materials were produced with the combination of flux cored wire and submerged arc welding powder, and the findings were evaluated. In this direction,

1. Yield and tensile strength decrease with increasing particle size with increasing as the range increases. Likewise, in the particle size distribution, coarse grains as the percentage increases, the percentage elongation decreases.
2. Notch impact values increase in fine-particle powders and as the particles get coarser, is decreasing.
3. The % inclusion amount of weld metal increases with increasing particle size.
4. The amount of diffusible hydrogen varies in direct proportion to the particle size range shows.
5. No change in powder analysis up to 5 cycles in submerged arc welding powders particle sizes due to the reaction of fine particle powders first. The resulting increase negatively affects the resource capability.

Finally, with the combination of the flux cored wire and submerged arc welding the properties of the submerged arc welding have increased effectively. As the hardness of the products increases, their abrasion resistance also increases. It has been clearly determined that it directly affects the microstructures. Low efficiency in cored wire and alloying problems in submerged arc welding solved by the method. The fact that welding powders for submerged arc welding products are produced using a waste slag infrastructure, it allows the production of welding powders for hard facing coating, which reduces the damage to the environment and economically provided.



## References

- Acherjee, Bappa. "Laser transmission welding of polymers—a review on process fundamentals, material attributes, weldability, and welding techniques." *Journal of Manufacturing Processes* 60 (2020): 227-246.
- Bembenek, Michał, et al. "Microstructure and Wear Characterization of the Fe-Mo-BC-Based Hardfacing Alloys Deposited by Flux-Cored Arc Welding." *Materials* 15.14 (2022): 5074.
- Elsheikh, Ammar H. "Applications of machine learning in friction stir welding: Prediction of joint properties, real-time control and tool failure diagnosis." *Engineering Applications of Artificial Intelligence* 121 (2023): 105961.
- Fan, Xi'an, et al. "Research and prospect of welding monitoring technology based on machine vision." *The International Journal of Advanced Manufacturing Technology* 115 (2021): 3365-3391.
- Karayel, Elif, and Yahya Bozkurt. "Additive manufacturing method and different welding applications." *Journal of Materials Research and Technology* 9.5 (2020): 11424-11438.
- Keehan, Enda. *Effect of microstructure on mechanical properties of high strength steel weld metals*. Diss. Chalmers University of Technology and Göteborg University, 2004.
- Kumar Rajak, Dipen, et al. "Friction-based welding processes: friction welding and friction stir welding." *Journal of Adhesion Science and Technology* 34.24 (2020): 2613-2637.
- Meng, Xiangchen, et al. "Recent progress on control strategies for inherent issues in friction stir welding." *Progress in Materials Science* 115 (2021): 100706.
- Oliveira, J. P., T. G. Santos, and R. M. Miranda. "Revisiting fundamental welding concepts to improve additive manufacturing: from theory to practice." *Progress in Materials Science* 107 (2020): 100590.
- Pandya, Dipali, Amarish Badgujar, and Nilesh Ghetiya. "A novel perception toward welding of stainless steel by activated TIG welding: a review." *Materials and Manufacturing Processes* 36.8 (2021): 877-903.
- Park, Hanji, et al. "Microstructural aspects of hydrogen stress cracking in seawater for low carbon steel welds produced by flux-cored arc welding." *Materials Science and Engineering: A* 820 (2021): 141568.
- Shen, Zhikang, Yuquan Ding, and Adrian P. Gerlich. "Advances in friction stir spot welding." *Critical Reviews in Solid State and Materials Sciences* 45.6 (2020): 457-534.
- Trembach, Bohdan, et al. "Application of Taguchi method and ANOVA analysis for optimization of process parameters and exothermic addition (CuO-Al) introduction in the core filler during self-shielded flux-cored arc welding." *The International Journal of Advanced Manufacturing Technology* 114.3-4 (2021): 1099-1118.
- Wang, Baicun, et al. "Intelligent welding system technologies: State-of-the-art review and perspectives." *Journal of Manufacturing Systems* 56 (2020): 373-391.
- Wang, Huimin, and Yuliang Wang. "High-velocity impact welding process: A review." *Metals* 9.2 (2019): 144.
- Xing, Changjian, et al. "Numerical analysis of the metal transfer and welding arc behaviors in underwater flux-cored arc welding." *International Journal of Heat and Mass Transfer* 153 (2020): 119570.
- Yang, Lei, et al. "An automatic welding defect location algorithm based on deep learning." *Ndt & E International* 120 (2021): 102435.
- Zhao, Bo, et al. "Numerical simulation of bubble and arc dynamics during underwater wet flux-cored arc welding." *Journal of Manufacturing Processes* 59 (2020): 167-185.
- Zhou, Baifan, et al. "Machine learning with domain knowledge for predictive quality monitoring in resistance spot welding." *Journal of Intelligent Manufacturing* 33.4 (2022): 1139-1163.