

A MODIFIED SALP SWARM OPTIMIZATION ALGORITHM BASED ON THE LOAD FREQUENCY CONTROL OF MULTIPLE-SOURCE POWER SYSTEM

Anas Mahdi AL-ZUBAIDI^{1*}, Galip CANSEVER²

¹Department of Electrical And Computer Engineering, Altınbaş University, İstanbul, Türkiye
anas.alzubaidi@ogr.altinbas.edu.tr (ID <https://orcid.org/0000-0002-7034-8980>)

²Department of Electrical and Electronic Engineering, Altınbaş University, İstanbul, Türkiye
galip.cansever@altinbas.edu.tr (ID <https://orcid.org/0000-0003-2294-4259>)

Received: 14.04.2022

Research Article

Accepted: 12.06.2023

*Corresponding author

Abstract

This work proposes a modified Salp Swarm Optimization Algorithm (SSA) for addressing a multi-source power state's Load Frequency Control (LFC). A controller parameter tuning of the SSA method and its application to the LFC of a multi-source power system with several power generating sources. Derive to the controller parameters, a single area telecommunications device that permits two power system with integrated controlles according to each unit is considered first, and the SSA approach is used. The tuned SSA algorithm is used to optimize the integral (I), proportional integral (PI), and proportional integral derivative (PID) parameters. The research is expanded to include a multi-area multi-source power system, as well as an HVDC link is proposed for connectivity of two regions in addition to the current AC point of intersection. This same tuned SSA method is used to improve the parameters of the Integral (I), Proportional Integral (PI), and Proportional - integral - derivative Derivative (PID). Consequently, the suggested system is shown to be resilient and unaffected by changes of the loading situation, system parameters, or SLP size.

Keywords: salp swarm algorithm (SSA), Load Frequency Control (LFC), Multi Source Power System, Integral Absolute Error (IAE).

ÇOK KAYNAKLI GÜÇ SİSTEMİNİN YÜK FREKANS KONTROLÜNE DAYALI MODİFİYE SALP SÜRÜ OPTİMİZASYON ALGORİTMASI

Öz

Bu çalışma, çok kaynaklı bir güç durumunun Yük Frekansı Kontrolünü (LFC) ele almak için değiştirilmiş bir Salp Sürü Optimizasyon Algoritması (SSA) önermektedir. SSA yönteminin bir kontrolör parametre ayarı ve birkaç güç üreten kaynağa sahip çok kaynaklı bir güç sisteminin LFC'sine uygulanması. Kontrolör parametrelerine göre, ilk önce her birime göre entegre kontrollere sahip iki güç sistemine izin veren tek alanlı bir telekomünikasyon cihazı düşünülmüş ve SSA yaklaşımı kullanılmıştır. Ayarlı SSA algoritması, integral (I), orantılı integral (PI) ve orantılı integral türev (PID) parametrelerini optimize etmek için kullanılır. Araştırma, çok alanlı çok kaynaklı bir güç sistemini içerecek şekilde genişletildi ve mevcut AC kesişme noktasına ek olarak iki bölgenin bağlantısı için bir HVDC bağlantısı önerildi. Bu aynı ayarlı SSA yöntemi, İntegral (I), Orantılı İntegral (PI) ve Orantılı - integral - türev Türevinin (PID) parametrelerini geliştirmek için kullanılır. Sonuç olarak, önerilen sistemin esnek olduğu ve yükleme durumu, sistem parametreleri veya SLP boyutundaki değişikliklerden etkilenmediği gösterilmiştir

Anahtar Kelimeler: salp sürü algoritması (SSA), Yük Frekansı Kontrolü (LFC), Çok Kaynaklı Güç Sistemi, İntegral Mutlak Hata (IAE).

1. Introduction

Loading Frequency (Frequency of Loading) The challenge of keeping producing unit real electricity consumption within prescribed limits throughout response to variations in system frequency and connector power exchange is referred to as control (LFC). It really is commonly considered part of automated generation control (AGC) and plays a critical role in power system operation and management Kundur, 1994; Elgerd, 1983).. Control zones or areas

reflecting cohesive groupings of generators are common in large-scale power networks."Thermal, hydro, gas, nuclear renewable, and other energy sources may be used in the control area (Hassan, 2009). Thermal, hydro nuclear, and gas power sources are routinely combined in a properly integrated power system. Due to their tremendous efficiency, nuclear power facilities, on the other hand, are typically kept at base load. Gas-fired power generation is well-suited to changing load demand and is frequently utilized to satisfy peak demands. In light of today's power situation", LFC research might profit from a combination of number of co generation units in the some type of quarantine zone alongside their appropriate participation elements.Different load fluctuations in terms of several linked power networks were studied in this study. Two parameters, namely (k_p , k_i), are tuned using different optimization algorithms, but the problem remains unsolved. For PI controller tuning in parallel linked power systems, numerous optimization techniques have been widely used.(Mohanty, Panda and Hota, 2014). One of them techniques is the Salp Swarm Algorithm (SSA), which was introduced by Mirjalili in 2017. The Salp Swarm algorithm has been proposed as a strong way for dealing with a variety of complex issues, but it has yet to be implemented to the CTSP. As a result, the performance of SSA in solving the LEC is explored in this research. SSA, despite its favorable properties and effective application to a variety of problems, nonetheless suffers from a sluggish convergence difficulty, particularly when dealing with constraint problems like the LFC. This issue is due to the fact that SSA is good at exploring the search space but not so good at utilizing it. To compensate for the SSA's deficit in enslavement, the SSA is paired with something like a single-based metaheuristic algorithm, Hill-Climbing (HC), which is known for its effective capacity to leverage the search space.All power and energy systems therefore have monitoring system is also responsible for offering fast and safe processes that have the potential to create electricity and provide customers with higher-quality energy. The automated generation control (AGC), which consists of a number of parts that govern various quantities, is the most important portion of the power system control. Voltage, frequency, and interline power transmission are examples (Mirjalili et al., 2017). The fractional derivative parameters and optimal outcome of the planned fractional order proportional–integral–derivative (FOPID) monitoring will be found using SSA in this study. FOPID is considered as a solution towards the load on programming problem that exists between two linked points: a multi-source switching regulator and battery management system.

2. Control Design and Proposed Controller

During the first occurrence, "a single-area system with hydro gas components, thermal engine reheat turbine, and hydro is studied for the system's controller design. As illustrated in Fig 1, numerical solution models of governorship, reheat turbines, and hydro turbines are employed for simulation and LFC analysis of something like the power supply". As a result, any unit does indeed have a regulatory parameter and a participation factor that determines the amount of notional load it may give. Each control's overall encountered a problem must've been close to one.Throughout the petrochemical industry,"the proportional integral derivative controller (PID) is the most often utilized feedback controller. It's a reliable, easy-to-understand controller that can deliver good control performance notwithstanding the the process plant's diverse dynamic characteristics. The approximately equal, integral, and derivative modes are the three primary modes of the PID algorithm, as both the name implies". The rising time is reduced using a proportional controller, but even then the steady-state inaccuracy is never eliminated. While integrated control minimizes steady-state error, then it might worsen the abrupt reaction. By increasing system

stability, reducing overshoot, and lowering overshoot, a proportional controller enhances the transient responsiveness. “Proportional integral (PI) controllers have always been the most popular in today's company. A control with derivative (D) approach is used when a rapid response of the system is not required, large disturbances and noises are present throughout the process operation, and the system has freight forwarders delays”. Derivative mode enhances system stability by allowing proportional gain to be increased while integral gain is decreased, resulting in faster controller response. Because once stability and quick reaction are required, a PID controller is frequently utilized. In light of the foregoing, this work considers I, PI, and PID structured controllers. The two-area power systems and designed controller are simulated in MATLAB program (Simulink/Code) for our information.

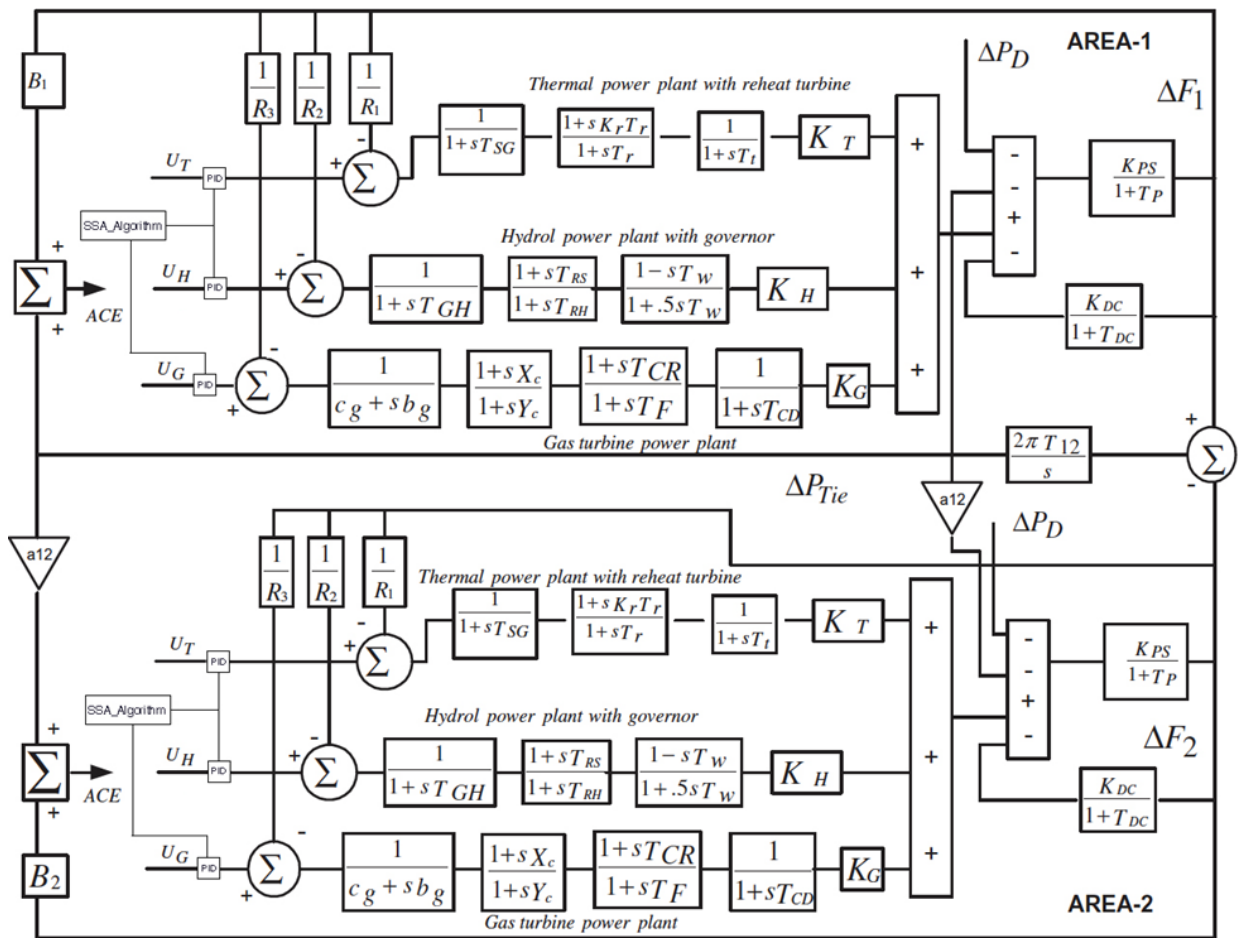

Figure 1. Transfer function model with SSA

3. Salp Swarm Algorithm

A central database has now cataloged over 1.2 million different sorts of aquatic animals (McCauley et al., 2015). The majority of these categories share comparable behaviors and characteristics, including as communication strategies, locomotor performance, and food seeking. The Salp is one of a kind of marine organism that belongs to the Salpidae family (Abualigah, 1990) Their own membranes are similar to jellyfishes, and they move similarly. To move ahead, water is pushed through their bodies as propulsion. (Shehab, Khader and Al Betar, 2016). Fig . 1

illustrates a single chain and a salps chain (swarm) (Rizk Allah et al, 2019). As previously stated, marine species exhibit several behaviors in common, such as swarming. For example, a school of fish is known as a school of fish, but a salp chain is known as a salp chain (see Figure 2), which depicts the form of a salp and salps chain (Abusnaina et al., 2018). Biological experts believe that this activity helps salps achieve greater movement and foraging, despite the fact that their dwelling areas are tough to access (Abbassi et al, 2019).

The salp swarm algorithm (SSA) is one of a novel meta-heuristic algorithm that does global optimization by mimicking the behaviors of salps while traveling and foraging in seas.. Everything was recommended in 2017 by Mirjalili (Anderson, and Bone 1980). It is a cutting-edge, nature-inspired optimization method that has shown to be effective in handling a variety of optimization issues (Anderson and Nival, 1986).

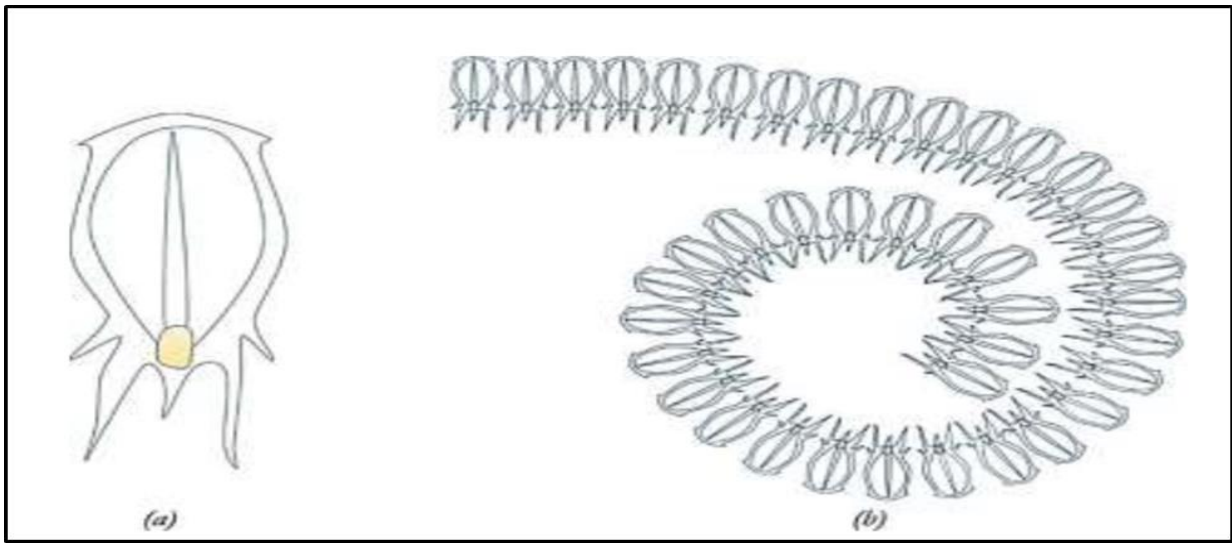

Figure 2. (a) Single salp b) Swarm of salps

SSA's goal is to create a population-based optimizer by imitating salp swarm behavior in nature. (Honschke, 2015).

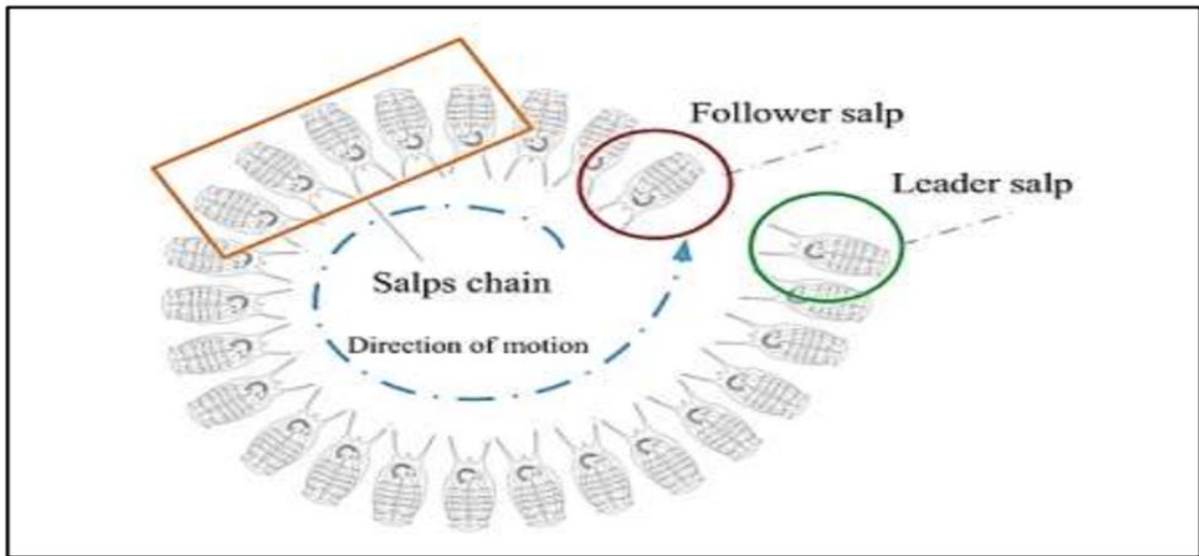

Figure 3. Salp's chain and the concept of leader and follower

The salps exhibit a wide range of behaviors. Their swarming activity is one of the most fascinating aspects of it. These salps are grouped in a chain configuration known as a salp chain, which aids movement during foraging (Honschke, 2015). Figure 2 depicts this chain (b). Although the exact explanation of this activity is unknown, some experts believe it is carried out in order to achieve greater movement by rapid coordinated alterations and feeding. (Mirjalili, 2019). To statistically characterize swarming tendencies (Shehab, Khader and Laouchedi, 2018). and salp population (İbrahim et al. 2019), only a few numbers are available for study. Also, “whereas swarms of ants, bees, and fishes have become widely studied and used to solve optimization issues”, there appears to be no physical phenomena of salp swarms for addressing combinatorial optimization problems. To mathematically represent salp chains (salp's occupants), which were originally separated into two groups: "leaders" and "following" (Abusnaina et al., 2018). The scenario is depicted in Figure 2. “The salp at the top of the chain is known as the leader, while the others are known as followers”:As the name of these salps indicates, the leading directors swarm and thus the followers following each other (Achelia, 2018). Salps' dynamic motions boost the SSA's searching capabilities, allowing it to avoid global optimization problems and immature convergence limitations. It also preserves the elite salp identified so far to lead additional swarm members to effectively feature space locations (Abbassi, 2019). Salps' location namely an the n-dimensional search space, where the n is the variable number of a problem assumed. “As a result, the positions of all salps are stored in x, a two-dimensional matrix. It's also possible that there's a food source called F in the search space that's the swarm's target” (Mirjalili, 2017).

The following expression is presented to update the leader's location:

$$X_j^1 = \begin{cases} F_j + C1((ub_j - lb_j) c_2 + lb_j) c_3 \geq 0 \\ F_j - C1((ub_j - lb_j) c_2 + lb_j) c_3 < 0 \end{cases} \quad (1)$$

Where x_j^1 represents the leader's position in the j th dimension. F_j is the position of the food supply in the j th dimension, ub_j is the upper bound of the j th dimension, lb_j is the lower bound of the j th dimension, and c_1 , c_2 , and c_3 are random values [5]. As indicated in Equation, the leader simply shifts its location in regard to the food supply (1). Because it balances objective functions, the component c_1 is the most important parameter in SSA. It is possible to define it as follows”:

$$c_1 = 2e^{-\left(\frac{4l}{L}\right)^2} \quad (2)$$

The modern incarnation is l , and the number of generations is L . The parameters c_2 and c_3 are two uniformly produced random values in the range $[0, 1]$. In fact, they specify whether the next location in the j th dimension should be positive or negative infinity, as well as the step size (Mirjalili, 2017). The following equation (Abbassi, 2019). (Newton's law of motion) is presented to update the location of the subordinates”:

$$x_j^i = \frac{1}{2}at^2 + v_0t \quad (3)$$

Where $i > 2$ denotes the position of the i th follower salp in the j th dimension, t denotes the time, v_0 is the starting speed, and a is determined as follows:

$$a = \frac{v_{final}}{v_0} \quad \text{where } v = \frac{x - x_0}{t} \quad (4)$$

“Because the time optimization is iteration, the differences between iteration is equal to 1 and considering $v_0 = 0$, this equation should become as following form”:

$$x_j^i = \frac{1}{2}(x_j^i + x_j^{i-1}) \quad (5)$$

Where $i > 2$, shows the location of i th follower salp in j th dimension. With equation 1 and 5, the salp chains can be simulated.

Then, the pseudo code of the SSA algorithm is illustrated below in the algorithm 1

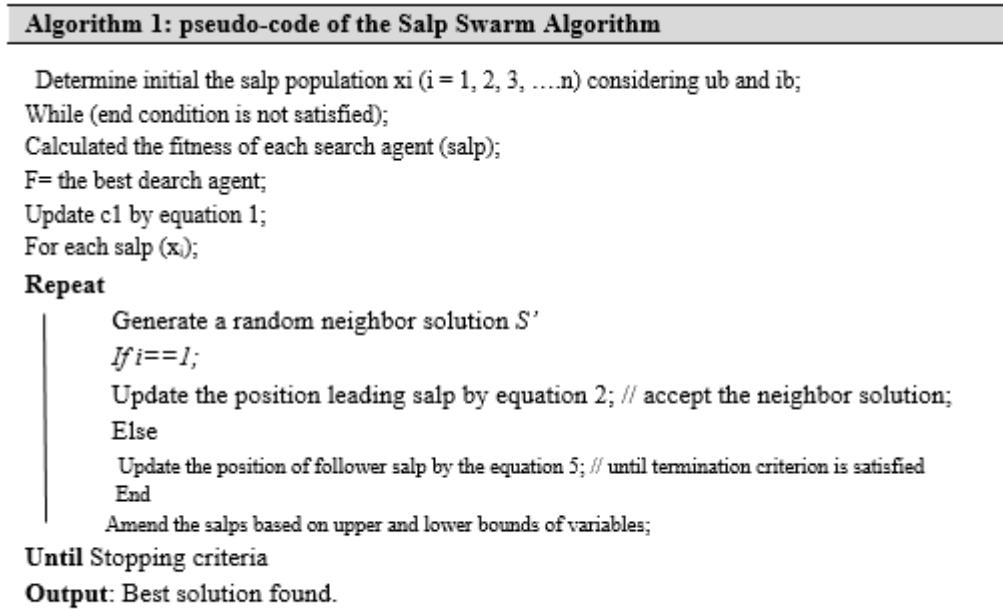

Figure 4. Pseudo-code of the Salp Swarm Algorithm

The SSA technique involves randomly placing several salps in order to approach the global optimum, then computing the efficiency of all salps, identifying the salp with the greatest fitness, and assigning its position to the variable F which as the source of food for the salp chain to follow. Equation 1 changes the coefficient c_1 for each dimension, equation 2 changes the location of the leading salp, and equation 5 changes the placement of the follower salps. If any of the salps leaves the search space, it will be brought back to the boundaries by equation 5. Except for startup, all of the aforementioned processes are repeated until the best results are obtained (Mirjalili, 2017). It's worth

mentioning that as a result of optimization, the food supply will change. This is because the salp chain is quite likely to discover a better solution by exploring and exploiting the area around it. Simulations reveal that the modeled salp chain is capable of pursuing a moving supply of food, as previously claimed. As a result, the salp chain can transmit towards a global optimum that evolves through time. Some observations are presented below to demonstrate how the proposed salp chain model and SSA method function in optimization problems” (Mirjalili, 2017).

- “SSA saves the best answer so far and assigns it to the source variable's food, ensuring that it is never lost, even if the entire population is corrupt”.
- “SSA moves the leader's location based solely on the availability of food, which is the best approach so far, ensuring that the leader always investigates and exploits the environment around it”.
- “SSA adjusts the positions of followers in relation to one another, allowing them to progressively send information to the leader”.
- Follower actions are gradual, preventing the SSA algorithm from becoming stuck in local optima.
- Over the course of iterations, parameter $c1$ is adaptively lowered, allowing the SSA to first explore and subsequently exploit the search space.
- There is just one significant regulating parameter in SSA ($c1$).
- “SSA is simple and straightforward to implement”.

Finally, “the literatures provided by many researchers concluded that not all of nature inspired metaheuristics are efficient, a few algorithms have proved to be very efficient and thus have become popular tools for solving real-world problems. Some algorithms are insufficiently studied. Accordingly, the purpose of this thesis is to investigate the performance of SSA in solving the LFC in two area power systems.

4. Result and Discussion

In this section, describe the result in two parts. The first one for the implementation the SSA algorithm based on optimal load frequency control (LFC), for parallel two area power system. Then, the second parts describe the multi-source single area power system.

4.1. Implementation of SSA

The salp swarm method is an efficient population-based metaheuristic algorithm inspired by nature. The swarming behavior of salps when traveling and feeding in seas is the fundamental inspiration for SSA. The implementation of SSA necessitates the resolution of a few basic challenges. To use SSA to address the LFC problem, which is a highly constrained problem, the SSA components must be properly developed. Swarm startup, fitness evaluation, and updating the salp's location steps are the primary SSA components that change from one task to the next. Figure 5 depicts the SSA stages.

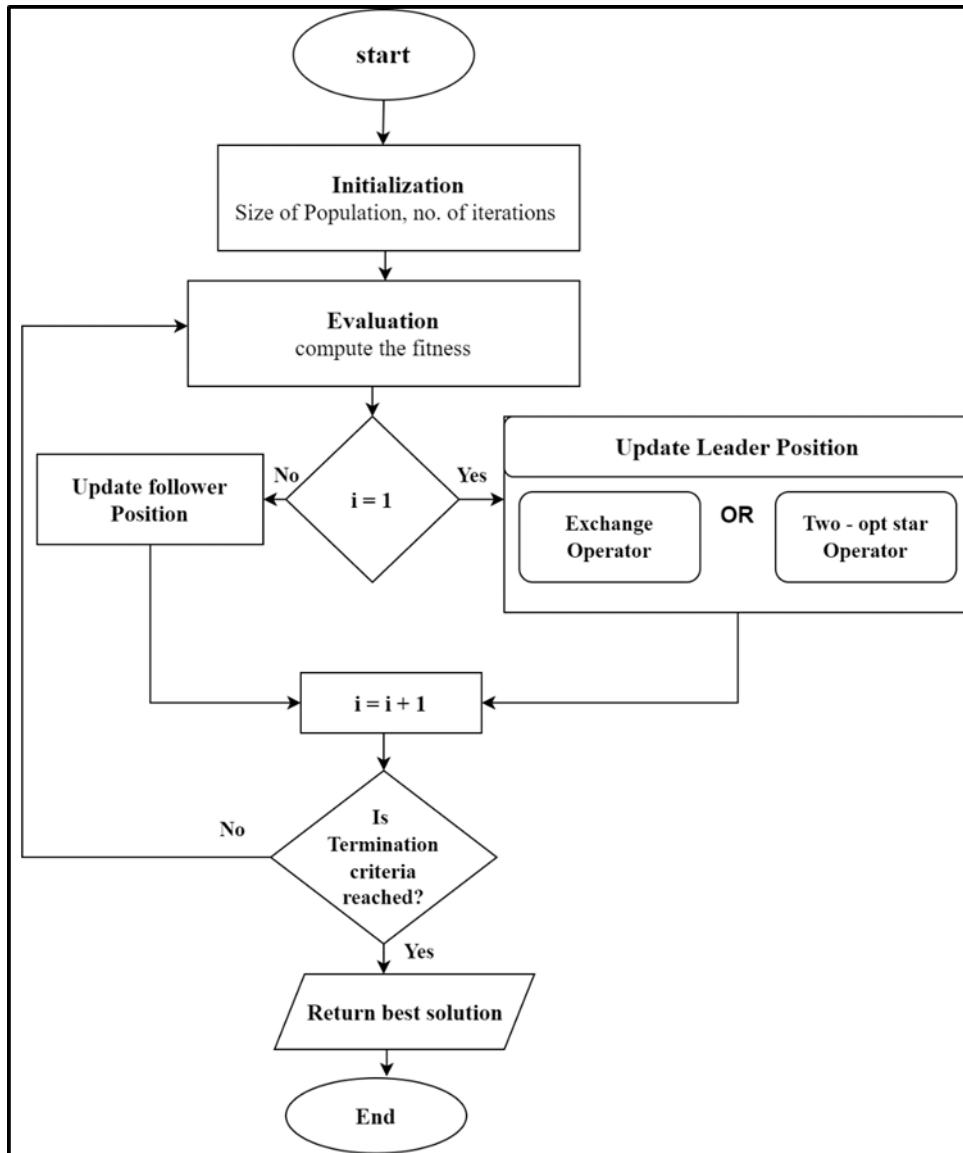

Figure 5. Flowchart SSA for LFC.

4.2. Power System with Many Sources for a Single Location

Using SSA optimization controllers, 1 percent step load perturbation (SLP) is applied at $t = 0$ s to analyze a system's transient characteristics, and the frequency and phase responsiveness is obtained. The SSA optimized integral controller advised has a better dynamic response than the ideal controller, with less peak overshoot and a faster setup time (see Figure 5).“Figures 5 and 6 show the dynamic frequency deviation responses of a system with or without an AC line during a 1% step load perturbation (SLP) in area 1 at $t = 0$ s in area 1”. Furthermore, as compared to the ideal output closed loop system, the f_1 and f_2 are enhanced by 20.35 and 10.78 percent, respectively.

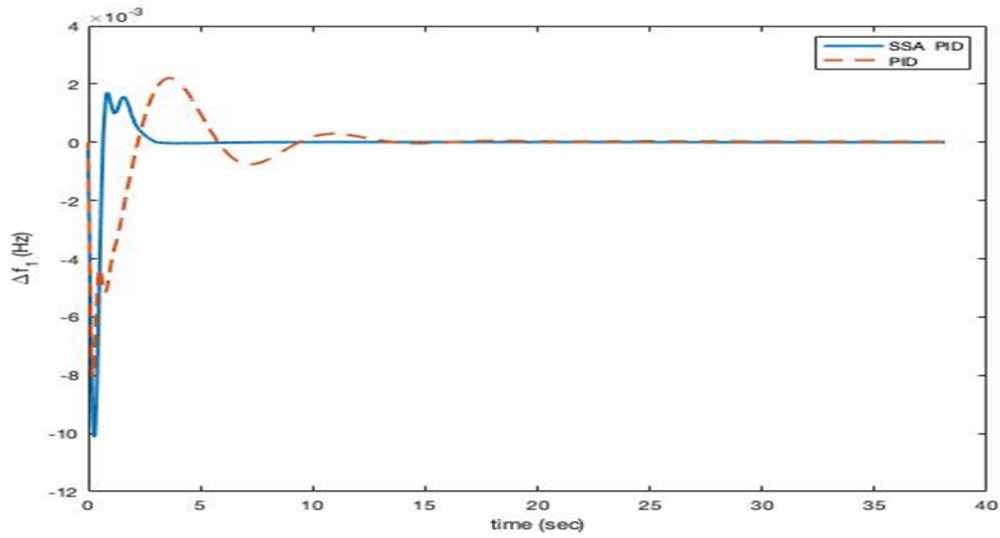

Figure 5. shows the change in frequency of area -1 with AC-DC parallel tie lines for a 1% change in area -1”

Show the is tie-line power variation with time under the same SLP in Figure 6, where it can be shown that the suggested SSA optimized PID controller improves both overshoot and undershoot by 88.33 percent and 32.85 percent, respectively.

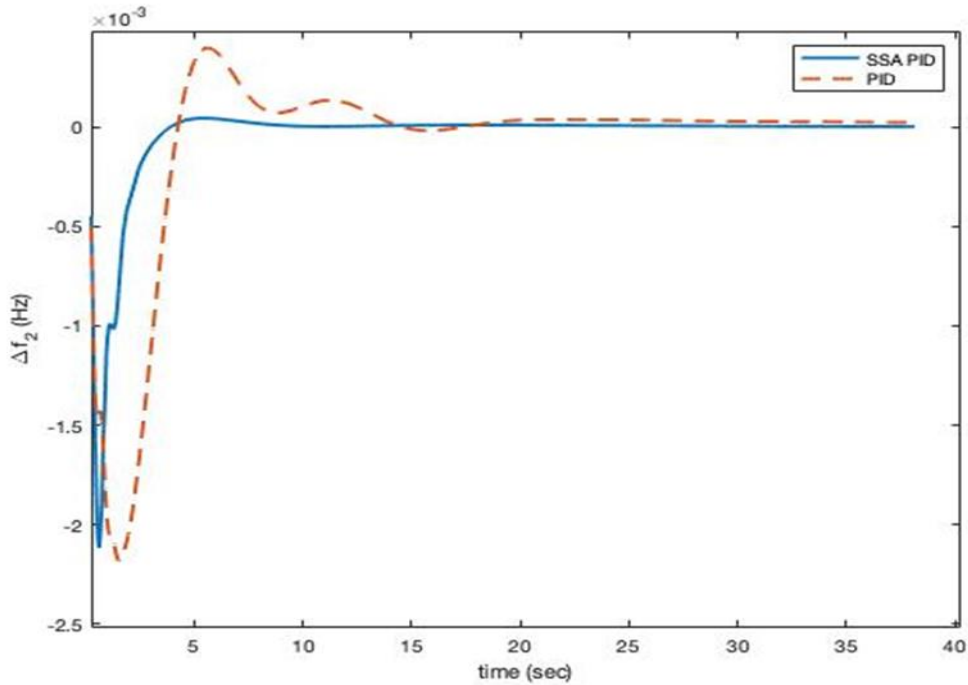

Figure 6. With AC-DC parallel tie lines, the frequency of area -2 changes for every 1% change in area -1

The suggested SSA designed to work PID/ PI/ I, controller's tie line power deviations are shown in figure 7, and the results have been compared to the optimal output feedback controller for a comparable system. PID, PI, and I controllers all improved their settling times by 66.46 percent, 65.23 percent, and 12.5 percent, respectively.

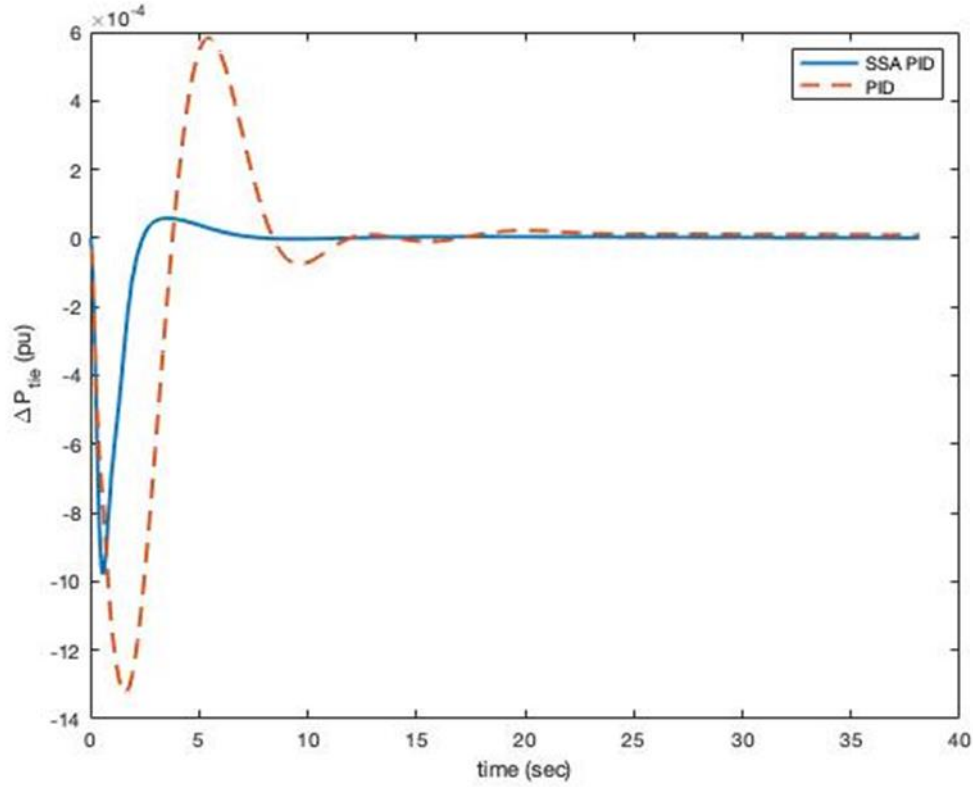

Figure 7. With AC-DC parallel tie lines, change in tie line power of area -1 for a 1-3 % shift in area -1”

5. Conclusion

This study discusses load frequency control (LFC) in multi-unit source power systems with various power generating sources such as thermal, hydro, and gas power plants. “The SSA optimization approach is used to optimize the controller settings. Initially, a single-area power system with numerous energy sources is studied, and the SSA method's control parameters are fine-tuned”, by running the algorithm many times for each control parameter modification

References

- Kundur P. Power system stability and control. New York: Mc-Graw Hill; 1994.
- Elgerd OI. Electric energy systems theory an introduction. New Delhi: Tata McGraw-Hill; 1983.
- Hassan B. Robust power system frequency control. New York: Springer; 2009.

- Mohanty, B., Panda, S., & Hota, P. K. (2014). Controller parameters tuning of differential evolution algorithm and its application to load frequency control of multi-source power system. *International journal of electrical power & energy systems*, 54, 77-85.
- Mirjalili, S., Gandomi, A. H., Mirjalili, S. Z., Saremi, S., Faris, H., & Mirjalili, S. M. (2017). Salp Swarm Algorithm: A bio-inspired optimizer for engineering design problems. *Advances in engineering software*, 114, 163-191.
- McCauley, D. J., Pinsky, M. L., Palumbi, S. R., Estes, J. A., Joyce, F. H., & Warner, R. R. (2015). Marine defaunation: Animal loss in the global ocean. *Science*, 347(6219), 1255641
- Abualigah L., Shehab M., Mohammad Al Shinwan, H. M. A. (2019). „salp swarm algorithm comprehensive survey. *Neural Computing and Applications*. 8 - M. L., Aspects of jet propulsion in salps.,*Can J Zool* 68765–77., 1990
- Shehab, M., Khader, A. T., & Al-Betar, M. (2016). New selection schemes for particle swarm optimization. *IEEE Transactions on Electronics, Information and Systems*, 136(12), 1706-1711
- Rizk-Allah, R. M., Hassanien, A. E., Elhoseny, M., & Gunasekaran, M. (2019). A new binary salp swarm algorithm: development and application for optimization tasks. *Neural Computing and Applications*, 31, 1641-1663
- Abusnaina M., Ahmed A. Ahmad, Sobhi Jarrar, Radi Mafarja, “Training neural networks using Salp Swarm Algorithm for pattern classification, ACM, Int. Conf. Proceeding Ser., 2018.
- Abbassi, R., Abbassi, A., Heidari, A. A., & Mirjalili, S. (2019). An efficient salp swarm-inspired algorithm for parameters identification of photovoltaic cell models. *Energy conversion and management*, 179, 362-372.
- Anderson, P. A. V., & Bone, Q. (1980). Communication between individuals in salp chains. II. Physiology. *Proceedings of the Royal Society of London. Series B. Biological Sciences*, 210(1181), 559-574.
- Andersen, V., & Nival, P. (1986). A model of the population dynamics of salps in coastal waters of the Ligurian Sea. *Journal of plankton research*, 8(6), 1091-1110.
- Henschke, N., Smith, J. A., Everett, J. D., & Suthers, I. M. (2015). Population drivers of a *Thalia democratica* swarm: insights from population modelling. *Journal of Plankton Research*, 37(5), 1074-1087.
- Mirjalili, H. F. (2019) Salp Swarm Algorithm: Theory, Literature Review, and Application in Extreme Learning Machines ,*Nature-Inspired Optim.* pp 185-199.
- Shehab, M., Khader, A. T., & Laouchedi, M. (2018). Modified cuckoo search algorithm for solving global optimization problems. In *Recent Trends in Information and Communication Technology: Proceedings of the 2nd International Conference of Reliable Information and Communication Technology (IRICT 2017)* (pp. 561-570). Springer International Publishing.
- Ibrahim, R. A., Ewees, A. A., Oliva, D., Abd Elaziz, M., & Lu, S. (2019). Improved salp swarm algorithm based on particle swarm optimization for feature selection. *Journal of Ambient Intelligence and Humanized Computing*, 10, 3155-3169.
- Abusnaina, A. A., Ahmad, S., Jarrar, R., & Mafarja, M. (2018, June). Training neural networks using salp swarm algorithm for pattern classification. In *Proceedings of the 2nd international conference on future networks and distributed systems* (pp. 1-6).
- Achelia, D. (2018, November). A chaotic binary salp swarm algorithm for solving the graph coloring problem. In *Modelling and Implementation of Complex Systems: Proceedings of the 5th International Symposium, MISC 2018, December 16-18, 2018, Laghouat, Algeria* (Vol. 64, p. 106). Springer

Abbasi, R., Abbasi, A., Heidari, A. A., & Mirjalili, S. (2019). An efficient salp swarm-inspired algorithm for parameters identification of photovoltaic cell models. *Energy conversion and management*, 179, 362-372.