

ELECTRONIC MEASUREMENT OF WEATHER CONDITIONS FOR AN ENGINE TEST ROOM

B. Dogru^{1,*}, M. Murat Ozdemir²

ABSTRACT

Frequently used internal combustion engines for driving highway vehicles are often tested to adjust performance outputs and exhaust emissions, with consideration for the production standardization and regulations of motor vehicles. In this work, a mini air station was designed and produced using the Arduino micro-controller to test the performance of an internal combustion engine. Instantaneous ambient temperature, pressure and relative humidity during engine operation are measured. At this time, the engine is subjected to steady state and transient regime tests and the performance data are reduced by a power correction factor to sea level conditions. The real-time weather data coming from the sensors over a 6-hour period every half-hour is continuously transmitted to the micro-controller. The microcontroller also continuously processes the measured data on an Excel page with the help of the environmental software of the microcontroller. According to the measurement results, the pressure and temperature results can be accepted at the tolerable interval. However, the relative humidity in the mini-station is considerably lower than the reference stations, and the room air is quite dry as a result of the atmospheric temperature rising and the large heat transfer between the engine and the environment. In the tests of the heavy duty diesel test engine, where the power correction factors are calculated thanks to the developed mini air station, the effective motor power has increased by 1.9% to 4.7%. The effect of the correction factor on brake specific fuel consumption varies between 1.9 and 4.5% for 2100 rpm and 1200 rpm engine rpm respectively.

Keywords: *Internal Combustion Engines, Real-Time Weather Data, Arduino Microcontroller, Correction Factor*

INTRODUCTION

The weather differs from climate in terms of meaning because it defines short-term conditions in a certain area. The weather statistics, measured by temperature, humidity, atmospheric pressure, wind etc. changes over a long period of time, are called climate. The climate of a location is affected by its latitude, terrain and altitude, as well as nearby water bodies and their currents. Weather is the state of the atmosphere, to the degree that it is hot or cold, wet or dry, calm or stormy, clear or cloudy. It is driven by air pressure, temperature and moisture differences between one place and another. Climate is not only interested with average weather data but also deviation, variation and extreme values.

Weather station is a facility with instruments and equipment to observe the physical condition of the atmosphere at a location or region at a given moment or in the short-term periods without intervention of humans [1]. Some are called automatic air stations and are used to measure air data by sensors and wirelessly transmit them to the main weather station for display and recording. Sensors, micro-controllers and transmitter unit are located in a remote weather station. Because the station is far away, it is mostly powered by solar energy. It is equipped with sensors that measure the temperatures of the earth, the temperature, the amount of precipitation, the wind speed, wind direction, atmosphere pressure and so on.

Most low-cost air measuring devices (mini-weather stations) are often portable and are suitable for scientific projects. The sophisticated ones are more complex and data communication is continuously carried out in real time whereas mini weather devices measure instantaneous data [2]. Both types of applications are found in a variety of fields such as agriculture and environment monitoring, climate change, weather forecasting, coal mining, biogas production centers, power plant production, home automation, industrial and security. Compared to conventional weather devices, weather stations have advantages such as measurement consistency, high acquisition frequency and operate in all weather conditions.

This paper was recommended for publication in revised form by Regional Editor Derya Burcu Özkan

¹Engineering Faculty, Mechanical Engineering Department, Halic University, Istanbul, TURKEY

²Vocational High School, Electronic Technology Department, Halic University, Istanbul, TURKEY

*E-mail address: b.dogru@soton.ac.uk

Manuscript Received 14 June 2016, Accepted 22 January 2017

A microcontroller-based remote terminal unit for the mini-air station model capable of collecting data on temperature and wind speed sensors was presented by Khomitah et al. [1]. A prototype weather station was developed to measure weather data and display by means of a graphical user interface [2]. An embedded system containing pair of sensors such as temperature, gas and humidity to design a weather monitoring system which enables the monitoring of weather parameters in a plant was practiced in which the microcontroller sends the sensor data into the LabVIEW by using the serial communication [3]. A five years hourly wind data for twenty-nine meteorological stations were analyzed by S.AL-Yahyai et al [4]. In a recent study, the weather station selection frame was extensively investigated for estimating electrical load [5]. An attempt has been made to design and implement the wireless portable weather monitoring station [6].

In this study, an Arduino micro-controller based mini air station was designed, produced and engineered for the internal combustion diesel engine test room. The main objective is to reduce the engine performance output to sea level conditions in order to measure instantaneous ambient temperature, pressure and relative humidity during engine operation and to achieve steady state and transient regime tests.

IMPORTANCE FOR ENGINE TESTING OF WEATHER CONDITIONS

A classical experimental setup includes an internal combustion test engine, dynamometer counter and air flow intake, fuel consumption, as well as various engine temperature measurement systems. The load control of the motors is provided by a dyno fitted to the engine crankshaft.

In order to obtain more precise results and to make a high comparison, all outputs should be calculated as expected with a power correction factor at sea level. The power correction factor is the coefficient to determine the engine power under atmospheric reference conditions [7]. This factor can be used for any type of engine and cylinder configuration. Atmospheric conditions (air temperature, pressure and humidity) affect the performance of internal combustion engines. The effect of atmospheric conditions on the performance of an engine can be observed, particularly with changes in vehicle acceleration time and fuel consumption. The power correction factor plays an important role in the repeatability, comparability and reliability of an engine test.

Many of the institutional regulations, such as DIN 70020, SAE J 1349, JIS D 1001 and ISO 1585, often lead to different results when the recommended atmospheric conditions are taken into consideration. At different atmospheric conditions, the main performance parameters can be determined using one of these correction factors. The ISO 1585 standard is also adapted by the European Commission Regulation (EC) No 80/1269 / EEC of the same correction factor (for a naturally aspirated or overcharged positive ignition engine):

$$\alpha_a = (99/p_d)^{1,2} \times (T/298)^{0,6} \quad (1)$$

T : Absolute temperature in Kelvins (K),

p_d : Total dry atmospheric pressure in kilopascals (kPa)

$$p_d = p - p_v \quad (2)$$

p_v : Water vapor partial pressure (kPa),

p : Atmospheric pressure (kPa)

The correction factor is shown at the correlation below for a Diesel engine :

$$\alpha_d = (f_a)^{f_m} \quad (3)$$

f_a : Atmospheric factor , f_m : Engine factor

The atmospheric factor depends on environment parameters such as pressure temperature and humidity. In turbo-charging with intercooler Diesel engines, that can be formulated written below:

$$f_a = (99/p_d)^{0,7} \times (T/298)^{1,5} \quad (4)$$

The engine factor should be combined of the injected fuel flow rate per a cycle in one liter volume (q) and the ratio of compressor-out pressure to compressor-in pressure (r) :

$$q_c = q/r \quad (5)$$

$$f_m = 0,036 \times q_c - 1,14 \quad (6)$$

Corrected engine performance outputs are calculated by the multiplication of raw data and correcting factor.

$$P_0 = P \times \alpha \quad (7)$$

α : Power correction factor, P_0 : Reduced engine power (HP),
 P : Measured engine power (HP)

$$T_0 = T \times \alpha \quad (8)$$

T_0 : Reduced engine torque (Nm), T : Engine torque (Nm)

$$b_{e-0} = b_e/\alpha \quad (9)$$

b_{e-0} : Reduced brake specific fuel consumption (g/kWh),
 b_e : Brake specific fuel consumption (g/kWh)

$$\eta_{th-0} = \eta_{th} \times \alpha \quad (10)$$

η_{th-0} : Reduced total engine efficiency,
 η_{th} : Total engine efficiency

The reference ambient conditions are $p_0=1.0$ bar and $T_0=298$ K. The correction factor is recommended for utilization in the range from 0.8 to 1.1 bar and from 288 to 308 K.

Higher atmospheric pressures increase the air density and therefore, augment the intake air charge to the engine. A higher intake charge improves the engine volumetric efficiency, and more power is delivered [8]. Brake torque and specific fuel consumption vary directly proportional to atmospheric pressure.

The ambient temperature is found to affect the flame speed, the combustion reaction rate, the uniformity of the fuel-air mixture, the volumetric efficiency and the heat transfer rate through the cylinder walls [9]. Higher intake air temperatures increase the occurrence of engine knock and decrease the volumetric efficiency [8]. Higher intake air temperatures can also contribute to stratified evaporation of the fuel components in the chamber. Each fuel component evaporates at a specific temperature, causing cycle-to-cycle combustion variations. On the other hand, for lower temperatures, only a small part of the injected fuel is vaporized, causing nonhomogeneity. As a result, lower flame speeds, higher unburned mixture, higher hydrocarbons and carbon monoxide emissions, and loss of power are observed [10].

High air humidity decreases the thermal efficiency and thus, reduces the engine mean effective pressure [11]. Also, increasing air humidity diminishes the flame speed and slowing down combustion. High air humidity is beneficial to the engine at high cylinder temperatures, as it prevents the occurrence of knocking by heat absorption during the dissociation process of water molecules [10]. The presence of water in the intake air can also reduce oxides of nitrogen and carbon monoxide emissions [12].

ELECTRONIC MEASUREMENT UNIT

A monitoring mini weather station was designed and applied to the diesel test engine at Istanbul Technical University Motor Laboratory. The main objective was to improve the raw performance data of the engine and reduce all of them to sea level conditions.

The real-time weather data from the sensors is continuously transmitted to the micro-controller. The sensor signal is processed and converted into digital if necessary. The basic components of the system are a microcontroller, various weather sensors, a signal processing circuit, an LCD panel and a logger PC (Figure 1). The microcontroller can also load the measured data into an Excel page with the help of the environmental software of the microcontroller. The PC is connected to the microcontroller via a USB cable. Because the test chamber is dark many times a day, the microcontroller is powered by an external supply or USB connection instead of a solar energy panel. Alternatively, a 9V battery is installed in the system. BMP 180 and LM35 analog sensors are used

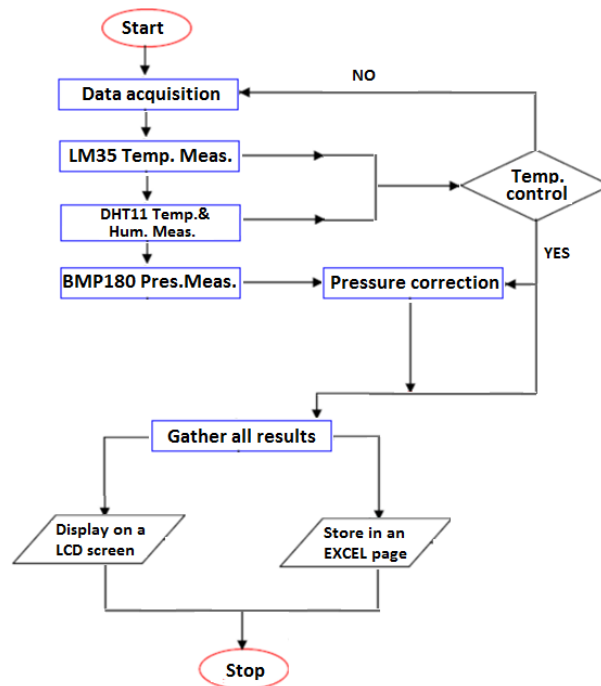

Figure 1. Software flowchart

to measure the environmental pressure and temperature, respectively. The DHT 11 digital sensor can monitor not only the temperature but also the relative humidity.

Microcontroller (Arduino Uno ATmega 328)

Arduino is a physical programming platform that has its own microprocessor and analog and digital I / O pins and also encodes a development environment similar to the C # language. Since the microprocessor has a written bootloader program, no external programming is required. The Arduino Integrated Development Environment (IDE) includes a text editor for writing code, a message area, a text console, a toolbar with buttons for common functions, and a series of menus. The user's code may be loaded into the microprocessor 328 with 8-bit memory. Arduino is a low cost, open source programmable and adaptable all electronic circuit component.

The Arduino Uno's microprocessor provides 8-bit resolution and 32 KB of integrated flash memory; Which is 0.5 KB used by the boot loader. The board has 6 analog I / O pins and 14 digital I / O pins. It works at 5V. The analog-to-digital signal conversion (ADC) is performed by the microprocessor.

Sensors

The LM35 is an integrated semiconductor analog circuit sensor that can measure temperature with a voltage output proportional to the temperature difference. The scale factor is $10\text{mV}/^\circ\text{C}$. It provides a sensitivity of $\pm 0.5^\circ\text{C}$ and a measurement range of -55°C to 150°C . This sensor is used to check the measurement accuracy of the DHT 11 sensor. The voltage data from the LM 35 sensor is transferred to the microprocessor and is calculated as the temperature unit taking into account the conversion. The signal conditioning is amplifying type.

Digital sensors have own microprocessors. The square-wave signal is transmitted to the Arduino microprocessor and displayed without any amplifying. Because of this reason, an analog sensor is more stable in spite of a digital one is more accurate and reliable. DHT 11 temperature and humidity sensor gives the output in digital form. It operates with 8 bit microprocessor and reacts rapidly. It maintains a temperature accuracy of 2°C and humidity accuracy of $\%5$ RH. The measurement range varies between $0^\circ\text{C} - 2^\circ\text{C}$ and $\%20 - \%90$ for temperature and relative humidity, respectively. Relative humidity largely depends on temperature. Although temperature compensation technology is used to ensure accurate measurement of relative humidity, it is still strongly advised to keep the humidity and temperature sensors working under the same temperature. When MCU (Micro-Computer Unit) sends a start signal, DHT11 changes from the low-power-consumption mode to the running-mode, waiting for MCU completing the start signal. Once it is completed, DHT11 sends a response signal of 40-bit data that include the relative humidity and temperature information to MCU.

BMP 180 Bosch analog sensor is used to measure the environmental pressure with a high-precision, low power consumption barometer. It maintains a sensitivity of ± 0.02 hPa and a measurement range of 300 hPa to 1100 hPa. The BMP180 is based on piezo-resistive technology, high accuracy and linearity as well as long term stability. The default pressure is set at the height of the laboratory (82 meters) where the test room is located via the IDE. Pressure measurement is affected not only from altitude but also from existing temperature and humidity. For this reason, the standard atmospheric sea level pressure may be higher than 1013.25 hPa (Figure 2).

LCD Display and Logger PC

To monitor the measured weather, the digital pins of the Arduino board are connected with a high-resolution modular LCD display panel. In addition, an LED lamp fixed to the digital input of the board is also activated to warn the user in case of a pressure drop of more than 4hPa. A sudden pressure drop is damaging the repeatability and reliability of the engine test.

The direct data from digital sensor and the transduced data from analog sensors are evaluated in the microprocessor. The measurement results are displayed and logged in an Excel page via a short additional code written into Arduino IDE. The board key holds itself in the "Sleep Mode" to provide a power economy, unlike the measurement process.

Simulation of the Signal Circuit

It is important to check that the signal conditioning system is functioning properly to avoid spending time and tangling components before connecting the entire circuit system. All wiring circuit has been tested while the microcontroller, sensors, LCD display and breadboard are unconnected and only IDE is online (Figure 3). The hardware design and software accuracy have been achieved by Fritzing and Proteus, respectively.



Figure 2. The mini weather station

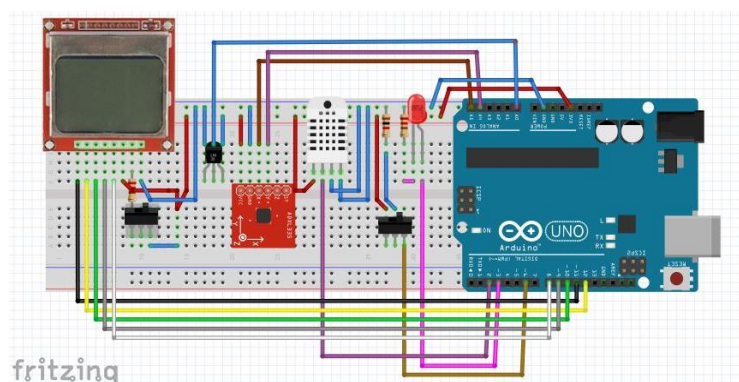

Figure 3. Fritzing wiring schematic

EXPERIMENT

In the first phase of experiments; temperature, pressure and relative humidity measurements were performed with the results shown in Figures 5-6-7, respectively, for a period of 6 hours every half hour. The results are presented as a comparison with the weather data obtained from other local sources.

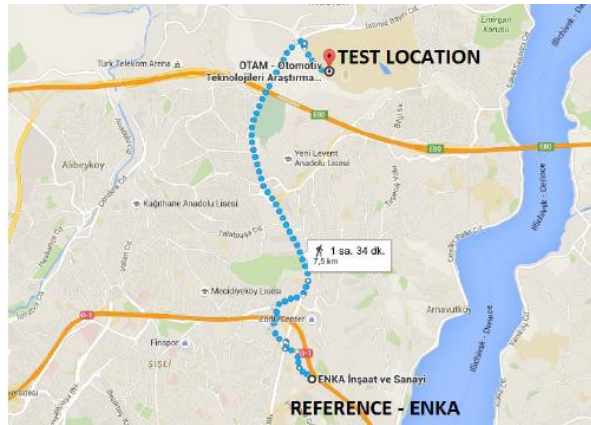

Figure 4. Test and reference stations

It was observed that the mini weather station results measured in the test room environment are compatible with the two other local weather stations. One of them is world's most popular weather forecast service (accuweather.com) and the other one is a local weather station (Enka building) located 107 meters high and 8 kilometers away. (Figure 4)

According to the measurements, pressure and temperature results can be accepted in tolerable gaps. On

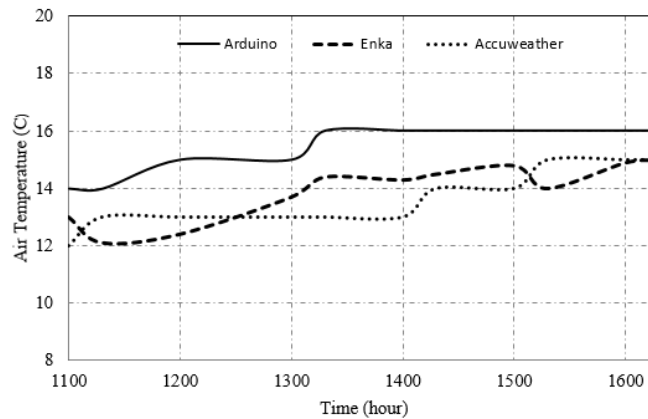

Figure 5. Comparison of air temperature measurements

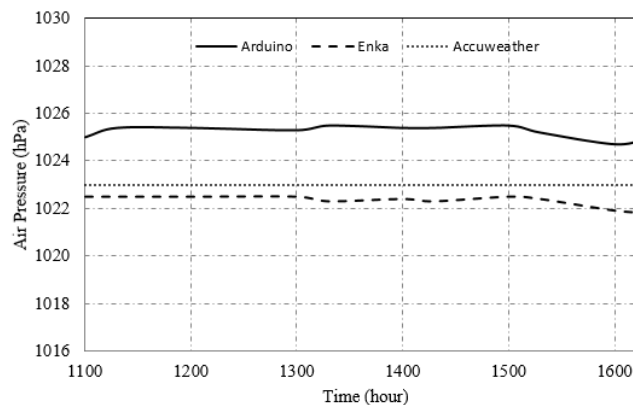

Figure 6. Comparison of air pressure measurements

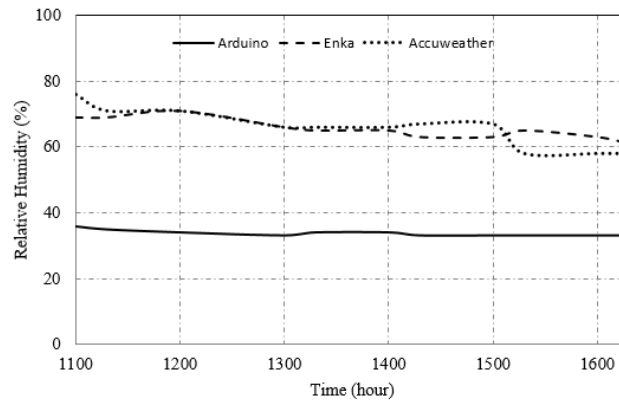

Figure 7. Comparison of relative humidity measurements

the contrary, the relative humidity results in mini station are much lower than the reference stations. Despite the sufficient amount of air circulation in the test room, as a result of major heat transfer from engine to the environment and rising of atmosphere temperature, the room air became dry considerably. This difference is the cause of the engine running

The relative humidity data was collected outside of the test room corresponded to other local stations. However, the in-room results are compared on Figure 7 to follow the actual conditions. The air temperature was 1°C - 2 °C higher than the local stations. The heat conduction causes this difference. The high temperature range in the exhaust pipe (ranging from 412 °C and 442 °C) clarifies the talk of temperature increase. No significant difference in pressure was recorded.

The test room where the developed mini weather station is applied in, is located in Istanbul Technical University Maslak Campus, Engines Laboratory. The mini weather station was attempted to obtain the necessary weather data to reduce the raw performance outputs of a Common-Rail heavy duty with Turbo-Intercooler Diesel engine (Figure 8) under full load conditions. The basic technical characteristics of test engine are given in Table 1.

Performance measurements should be taken at a sufficient number of engine speeds to ensure the power curve completely between the lowest and the highest engine speeds recommended by the manufacturer. This range of speeds includes the speed at which the engine produces its maximum power. For each speed, the average of at least two stabilized measurements is to be determined. To define the power curve; at four engine speed ranges, the engine was operated.

At each measuring point, the fuel regulator arm was fixed at the maximum position and maintained the position during the test. With the setting of the loading potentiometer, the engine speed rose from 1200 rpm to 1500 rpm, to 1800 rpm and finally to 2100 rpm, rising from the first measuring point.

During the test process; engine speed, force on the load cell, fuel flow rate, exhaust gas temperature, compressor-out pressure, cooling water in&out temperatures and intercooler unit in&out temperatures were measured to calculate the raw performance values such as engine power, torque, brake specific fuel consumption,

Table 1. Test engine specifications

Model	Ford Ecotorq 300PS
Cylinder volume	7.33 liters
Number of cylinders	6
Bore and Stroke	112/124 mm
Compression ratio	17.4:1
Weight	708 kg
Engine power	221 kW
Max. engine torque	1100 Nm (1400rpm-1800 rpm)
Max. revolution	2400 rpm



Figure 8. Ford Ecotorq diesel engine

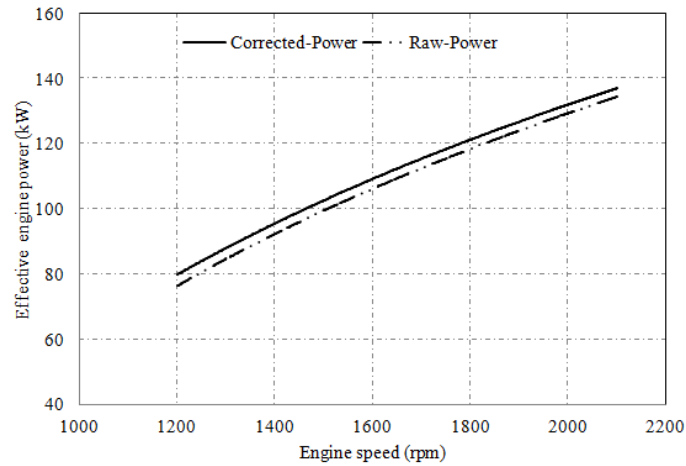

Figure 9. Effect of correction factor on engine power

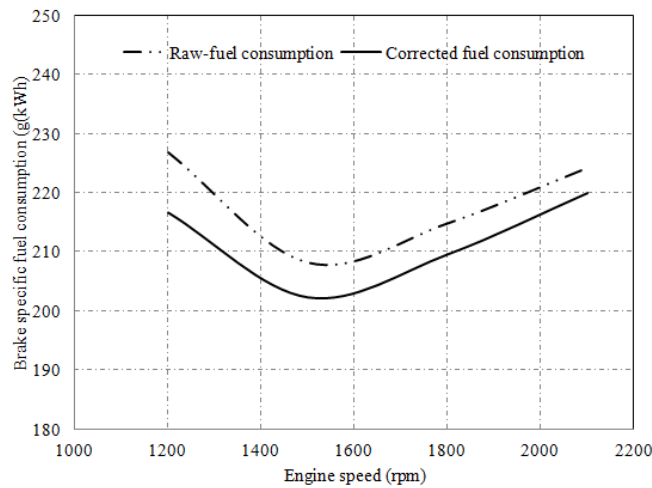

Figure 10. Effect of correction factor on fuel consumption

total engine efficiency and also air pollutants from exhaust pipe such as nitrogen oxide and soot particles. In order to obtain more accurate results, all outputs have been calculated to be reduced to sea level according to the standard test conditions of the European Commission Regulations 80/1269 / EEC. At this point, ambient temperature, atmospheric pressure and relative humidity are important on the test day.

The effect of correction factor on engine performance is shown in Figure 9. Since the four test points have a correction factor greater than 1, the corrected motor power (actual engine power) rises clearly. The diesel engine factor ranges from 1.02 to 1.05. This corresponds to a significant increase of between 1.9 and 4.7% for effective engine power.

The effect of the correction factor on brake specific fuel consumption is shown in Figure 10. All the raw fuel consumption data are higher than the reduced ones. The reduction in fuel consumption ranges between 1.9% and 4.5% for 2100 rpm and 1200 rpm respectively.

CONCLUSION

Engine research and development is a very expensive, time consuming and complex business. The influence of the atmospheric conditions (air temperature, pressure and humidity) on the performance of an engine can be observed especially with variations in vehicle acceleration time and fuel consumption. The power correction factor plays an important role in the repeatability, comparability and reliability of the engine test.

There are various complex and expensive weather stations on the market for agriculture and environmental monitoring, climate change, weather forecasting, coal mining, biogas production centers, power plant production, home automation, industrial and security markets. However, it is more important to develop as a part of laboratory facilities, hand-made, specific to the engine tests and with software flexibility mini weather station equipped a microcontroller, various weather sensors, signal processing circuit, LCD panel and a logger PC.

For the future work of this study, additional security functions for dyno cooling water flow rate, engine cooling water temperature and flow rate will be integrated into the present system. PTC sensor whose resistance is dependent on temperature, is favorable for the temperature limitation and a buzzer sends a warning sound. If the flow rate of engine or dyno cooling water is going down, a Hall-effect flow control sensor and a buzzer will interfere in together. Besides, a gas sensor with high sensitivity to propane, methane, butane, LPG and natural gas and also a simple O_2 sensor in order to detect the sufficient oxygen content into the engine can be mounted onto the microcontroller unit. After controlling the measurement accuracy of all these sensors, the station will be converted to a wireless and automatic remote weather station via a GSM or Ethernet module.

ACKNOWLEDGEMENTS

The authors would like to thank all the staff of the Istanbul Technical University Laboratory for technical support during the development of the study.

NOMENCLATURE

rpm	rounds per minute
DIN	Deutsches Institut für Normung
SAE	Society of Automotive Engineers
JIS	Japanese Industrial Standard
ISO	International Organization for Standardization
T	Absolute temperature
p_d	Total dry atmospheric pressure
p_v	Water vapor partial pressure
p	Atmospheric pressure
f_a	Atmospheric factor
f_m	Engine factor
α_a	SI engine power correction factor
α_d	Diesel engine power correction factor
q	Fuel flow rate per a cycle in one liter volume
r	The ratio of compressor-out pressure to compressor-in pressure
P_0	Reduced engine power
P	Measured engine power
T_0	Reduced engine torque
T	Engine torque
b_{e-0}	Reduced brake specific fuel consumption
b_e	Brake specific fuel consumption
η_{th-0}	Reduced total engine efficiency
η_{th}	Total engine efficiency
K	Kelvin
C	Centigrade
MCU	Micro-Computer Unit
LCD	Liquid Crystal Display

PC Personal Computer
USB Universal Serial Bus
V Volt
I/O Input/Output
KB Kilobyte
IDE Integrated Development Environment
ADC Analog-to-digital signal conversion
hPa Hectopascal
RH Relative Humidity
LED Light Emitting Diode
kg Kilogram
kW Kilowatt
EEC European Economic Community
PTC Positive Temperature Coefficient
LPG Liquid Petroleum Gas
GSM Global System for Mobile Communications

REFERENCES

- [1] P. Husnul Khotimah, D. Krisnandi and B. Sugiarto, "Design and Implementation of Remote Terminal Unit On Mini Monitoring Weather Station Based on Microcontroller", The 6th International Conference on Telecommunication Systems, Services and Applications, 2011, pp.186-190.
- [2] S. Roneel V., "Development of a Remote Automatic Weather Station with a PC based Data Logger", International Journal of Hybrid Information Technology Vol.7, No.1, pp.233-240, 2014.
- [3] P.Susmitha, G.Sowmyabala, "Design and Implementation of Weather Monitoring and Controlling System", International Journal of Computer Applications (0975 – 8887) Volume 97– No.3, July 2014.
- [4] S. AL-Yahyai, Y. Charabi,, A. Gastli and S.Al-Alawi, "Assesment of wind energy potential locations in Oman using data from existing weather stations", Renewable and Sustainable Energy Reviews 14, pp: 1428-1436, 2010.
- [5] T. Hong, P. Wang and L. White "Weather Station selection for electric load forecasting", International Journal of Forecasting 31, pp : 286-295, 2015.
- [6] J.T.Devaraju, K.R.Suhas, K.H.Mohana and V.A.Patil "Wireless Portable microcontroller based weather monitoring station", Measurement 76, pp:189-200, 2015.
- [7] European Council, "Council Directive Relating to Engine Power of Motor Vehicles" ec.europa.eu/enterprise/sectors/automotive/documents/directives/directive-80-1269eec_en.htm, Last access date: 30.11.2016
- [8] Heywood, J.B., "Internal Combustion Engine Fundamentals", McGraw-Hill Book Co., 1989.
- [9] Pulkrabek, W.W., "Engineering Fundamentals of the Internal Combustion Engine", Prentice Hall, Inc, 1997.
- [10] Giacosa, D.,"Motori Endotermici" 2 ed., Ulrico Hoepli Editore S.p.A., Milan, 1986.
- [11] Taylor, C.F., "The Internal Combustion Engine in Theory and Practice", The MIT Press, Vol. 1, Second Edition, Revised, USA, 574 p., 1992.
- [12] Tsao, K., Wang, C., and Miller, E. "Performance of Gasoline-Water Fuel in a Modified SI Engine", SAE Technical Paper Series, SAE 841399, SAE, Inc., 1984.