

# Enhancement of Long Term Evolution Advanced Performance using Distributed Antenna Systems

Ayodeji Oluwadamilola Ajayi\*, Jide Julius Popoola\*<sup>‡</sup>

\*Department of Electrical and Electronics Engineering, School of Engineering and Engineering Technology, Federal University of Technology, P.M.B. 704, Akure, Ondo State Nigeria

(silverdammy@gmail.com, jide.j.popoola@gmail.com)

<sup>‡</sup>Corresponding Author; Jide Julius Popoola, P.M.B. 704, Akure, Ondo State, Nigeria, jide.j.popoola@gmail.com

*Received: 01.09.2017 Accepted:25.09.2017*

**Abstract-** Over the past decades, wireless cellular networks have experienced tremendous evolutionary growth. However, providing sufficient coverage and capacity for indoor users has always been a major challenge for mobile network providers. Despite the fact that Long Term Evolution-Advanced (LTE-A) systems facilitate high speed data services, poor indoor coverage and interference still diminish the quality of real-time data services as well as the throughput performance of LTE-A in indoor scenarios. In solving this problem, the study presented in this paper investigates the efficiency of Distributed Antenna System (DAS) in overcoming mobile signal reduction in indoor environment. This was achieved by developing two algorithms with and without DAS using tree topology deployment of active DAS. The developed algorithms were then evaluated using some wireless communication performance indices. The performance evaluation result shows that the algorithm with DAS outperforms the one without DAS with improved Bit Error Rate (BER) performance. In addition, the overall performance evaluation result obtained shows that the DAS technologies effectively improve the performance of LTE-A both indoor and outdoor environments.

**Keywords** Wireless cellular networks evolution, long term-advanced, distributed antenna system, heterogeneous networks.

## 1. Introduction

Over the past few years, wireless cellular systems or networks have been undergoing astonishing evolutionary growth. In about one and half decade ago, in Nigeria as well as some other developing nations of the world, mobile phones were mostly used for making calls and sending text messages via short message service (SMS). However, as cellular system is developing at an extraordinary fast rate, it has experienced tremendous evolutionary growth. For instance, one of the limitations of the first generation (1G) of wireless networks, which was basically analog when first, conceived and designed, was the fact that it was purely for voice calls without any consideration for data services. Another limitation of the 1G network as reported in [1] is that it has no capacity for encryption. In addition, as reported by [1], the sound quality of it was generally poor with a transfer speed of only 9.6 kbps. On the other hand, when the fully digitalized second generation (2G) cellular, which was based on the global system for mobile communications (GSM) standard began by introducing the idea of digital modulation, which converts the voice into digital code some limitations of 1G such as privacy

and sound quality were greatly reduced. The 2G wireless cellular system was a giant success because of its revolutionary services and applications it brought to the end users. Apart from the high quality speech services it offers, the mobility capacity it added was a convincing and strong reason for end users to procure 2G terminals.

Moreover, as the use of 2G phones started to grow rapidly and people all over the world began to use mobile phones instead of fixed line telephones; it was obvious that demand for data services, such as internet access, was a necessity. Thus, the evolution from 2G to third generation (3G) of wireless systems ushered in faster and higher capacity data transmission with the introduction of universal serial bus (USB) modem or dongles for accessing internet on computer. The primary technological difference that differentiates the 3G cellular mobile technology from 2G of wireless cellular technology is the use of a hybrid circuit switching and packet switching instead of only circuit switching employed for data transmission in 2G. This switching method enhanced 3G quality of services and coverage. According to [2], 3G also brought into existence significant features that support much higher data transmission rates of up to 2 Mbps, which makes

the 3G suitable for high-speed data applications and services as well as for the traditional voice calls which support global roaming. A successor to 3G cellular systems is the fourth generation (4G). According to [1], in 2008, International Telecommunication Union Radiocommunication Sector (ITU-R) specified the International Mobile Telecommunications Advanced (IMT-Advanced) for 4G standard with setting speed requirements at 100 Mbps for high mobility communication such as cars and trains and 1 Gbps for low mobility communication such as pedestrians and stationary users. As reported in [3], upon this completion of 3G family of standards, the Third Generation Partnership Project (3GPP) started working on Long Term Evolution (LTE) system during the Release 8 (Rel-8) of the standards.

LTE as reported in [4] is defined by 3GPP as a highly flexible radio interface. It is the first cellular system based on Orthogonal Frequency Division Multiple Access, which represented a major breakthrough in terms of achieving peak data rates of 300 Mbps in the downlink and significant increase in spectral efficiency when compared to previous wireless cellular systems. Despite these merits, LTE Rel-8 and Release 9 (Rel-9) specification could not meet the IMT-Advanced requirements set by the ITU-R for 4G cellular systems. This brought about the birth of Long Term Evolution-Advanced (LTE-A), which is the first accepted 4G cellular system whose standardizations, according to [4], was initiated in Release 10 (Rel-10) by 3GPP in efforts to meet the IMT-Advanced requirements. With this success, it is obvious that LTE-A is the evolved version of LTE developed by 3GPP with the intentions of bridging the gap between 3G and 4G standards in IMT-Advanced. One of the benefits these intensions have brought is the provision of high-speed data for mobile phones and data terminals [5]. Another benefit the intensions for LTE-A development has brought, as reported in [5] is to enhance peak data rates of 100 Mbps and 1 Gbps respectively for high mobility and low mobility in the downlink and 500 Mbps in the uplink according to [3]. Other features that make LTE-A popular among operators are its efficient interference management and reduced operational costs [6]. Similarly, LTE-A overall network management, capacity and quality of service management are other attributes that account for its best performance.

Despite these achievements, observation shows that wireless coverage for high data rates and improving the indoor data capacity is still a challenge. For instance, [7] observed that network congestion often occurs inside buildings where the local traffic need exceeds the capacity offered by the traditional outdoor macro sites, causing call drop or low service quality. Similarly, as reported in [8], recent studies showed that between 70 and 80% of the traffic is generated from indoor users. This shows that there is need to provide dedicated indoor solutions to indoor users to meet their network demands instead of depending on the coverage of outdoor macro sites. In achieving this in recent high data mobile generation, two indoor solutions are widely employed. The first of these two solutions, according to [9], is usage of Femto cell while the second solution is usage of distributed antenna system (DAS). While Femto cells, according to [8], are a group of very small independent base stations each with a single antenna installed by the user in the indoor

environment and connected to each other using a data backbone, DAS is defined in [10] as a group of antennas spatially separated and connected to the same base station or radio cabinet. In addition, while each antenna in a Femto indoor solution is an individual cell that has its own resources and transmitting power, all the antennas in DAS are connected to the same cell using a network of cable and power splitters. Thus, in DAS power transmitted from the base station is divided on the antenna and same wireless resource is shared among all the antennas [8]. Therefore, the received power at any user location is the summation of all the powers received by all the DAS antennas since the data they are sending is the same.

Basically, the concept of the DAS is not new. However, it has been recently seen as a good solution for providing higher capacity and coverage by the operators in indoor environments such as homes and offices. It is a technology, which enhances network capacity and coverage in hot and dead zones while eliminating the need for additional base stations (BSs) for such zones. Thus, in DAS, some of the antennas are collocated at the central base station (CBS) and other antennas are distributed throughout the cells, which according to [11], are known as radio remote units (RRUs). Generally, RRUs are usually connected to the CBS via high-bandwidth low-latency dedicated connections such as fiber optics [12]. In contrast to co-located antenna system (CAS), DAS reduces users access distance, this in turns reduces interference by minimizing the transmit power while channel quality is maintained. According to [12, 13], DAS mitigates path-loss and shadowing effects, provides uniform coverage, reduces outage on the downlink, and enhance capacity and area spectral efficiency. Furthermore, DAS also helps in reducing inter-cell interference and significantly improves capacity, especially for users who are located close to the cell edges [15]. With these benefits and merits of DAS in mind, the study presented in this paper was embarked upon with the aim of investigating how DAS can enhance the performance of LTE-A.

In achieving this aim, an algorithm for LTE-A network involving DAS with the adoption of the WINNER channel model was developed. Detailed information on the development of the algorithm for LTE-A network involving DAS was presented in this paper. In order to enhance the paper logical presentation, the rest parts of the paper is organized as follows. In Section 2, brief review on heterogeneous networks (HetNets) and DAS are presented. Section 3 is devoted to the development of the simulation model in achieving the aim of this study. The results obtained were presented and discussed in Section 4 while the paper is concluded in Section 5.

## 2. Brief Review on Heterogeneous Networks and DAS

Heterogeneous networks (HetNets) as defined in [16] are a power solution to handle the rapidly increasing demand for mobile bandwidth. Similarly, an heterogeneous network was defined in [17] as a network topology composed by deploying multiple HetNets under the coverage of macro cells with a

view of improving network throughput, extends cell coverage and offloads the network traffic for mobile communication network. It consists of mixture of radio technologies and various cell types working together seamlessly. It consists of small cells embedded in a macrocellular network, which enable flexible and scalable capacity enhancements. Basically, in HetNets, low power nodes are strategically placed through out the macro cell area with a mosaic of Picos, Relays, Femtos and remotes radio heads (RRHs). This goal is to bring the communication network closer to the user in order to improve the signal quality and boosting the network capacity further. According to [18], the choice of a small cell is determined by number of factors. Some of these factors are

availability of backhaul capacity, number of users to be served and cell-site location to mention but a few. Basically, in HetNet, low power nodes, which can be micro enhanced Node-Bs (NBs) where evolved Node-Bs (eNBs) is synonymous to base station in 3GPP, Pico eNBs, home eNBs, relays, and DASs [19]. The primary merit of the deployments of these low power nodes is that it enhances optimization of network performance at relatively low cost. The various types of heterogeneous deployments as summarized in Fig.1are purposely to extend indoor coverage from indoor base stations.

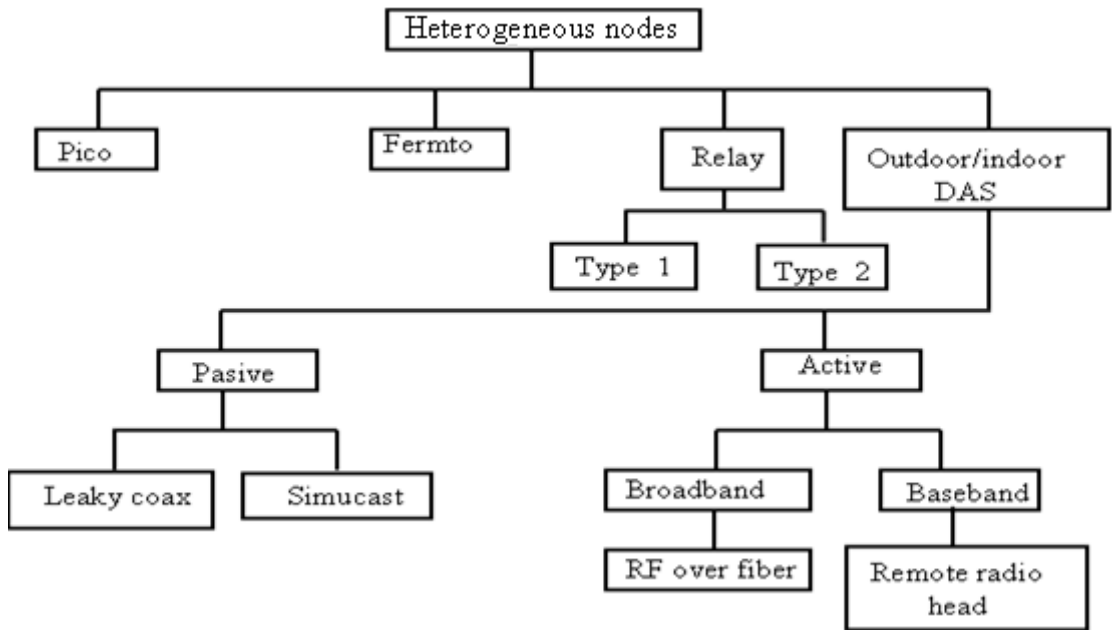

Fig. 1. Heterogeneous deployment classification [19].

As shown in Fig. 1, different techniques are normally used to extend indoor coverage. For instance, while Picocells, according to [20] are usually deployed in a centralized way to serve few tens of users within a radio range of 300 m or less, Femtocells are user-deployed access point (AP) designs to serve a dozen of active users in homes or enterprises. Relays, on the other hand, are usually operator deployed access points that route data from the macro base station to end user and vice versa [20]. However, DASs as another technique of extending indoor coverage consist of distributed remotes antenna or AP connected to a central controller by cable or fiber-optic [7]. It is defined in [21] is a group of spatially separated antennas connected to a common signal source, which provides wireless service within a geographical area or structure.

Basically, DAS does not provide signal processing capability at the point of access. However, the same downlink signal is broadcast on all the antennas. Thus, the elements in DAS are only utilized to connect all the users within a given transmission range. The DAS is thus controlled by a centralized processing entity through analog transmissions over optical fibers as shown in Fig. 2. According to [22], the

use of an optical fiber connection between the DAS and the centralized processing entity is enabled by the radio over fiber technology. The usage of the optical fiber technology in DAS as a HetNet indeed provides divers advantages. One of them is long distances covering without fear of performance degradation due to low-loss nature of optical fiber. The flexibility of reconfiguring or upgrading the wireless access technology in DAS systems without changes in the fiber medium also enhances DAS system as a HetNet. Other advantages of DAS as a HetNet, according to [22], include ease of deployment, advanced transmission scheme, ease of coordination and energy conservation. These advantages of DAS over other traditional centralized macro-cell/micro-cell, such as Pico-cells, Femto-cells and relays, as a new paradigm shift in HetNet for providing a significant network performance leap also necessitates the investigation on DAS enhancement study presented in this paper.

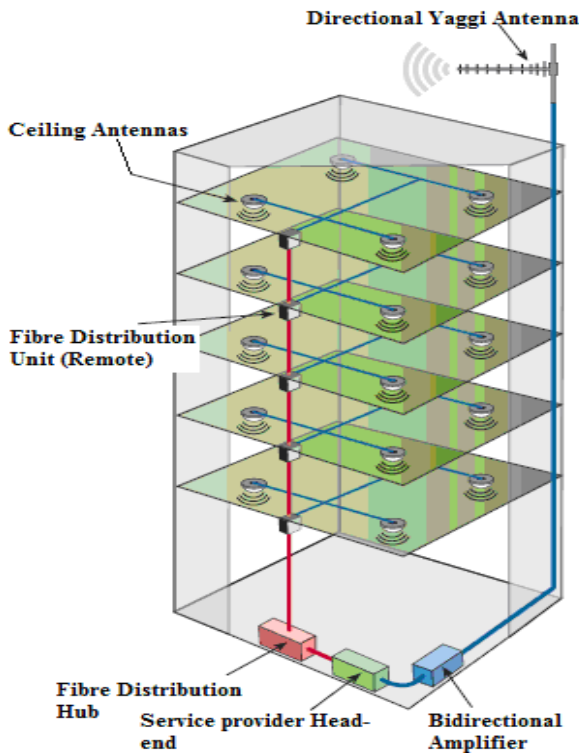

Fig. 2. In-door DAS architecture [23].

There are lots of studies on DAS as a HetNet to improve the performance of LTE-A [7, 14, 15, 24]. For instance, [7] investigated different ways of extending wireless coverage for high data rates and improving the data capacity in a building. The results of the study showed the robustness of DAS and conditions for multi-Femtocell deployment. Similarly, it was demonstrated in [24] the fact that HetNets using DASs have emerged as a promising technology for future wireless cellular networks. Similarly, in the study presented in [12], where the rate loss due to limited feedback in LTE-A DASs was investigated, the results revealed the robustness of DAS over centralized antenna system. In all these surveyed studies, the positions of the user equipment (UE) and the DAS were not specified. In addition, all the surveyed literature did not mention the channel employed. These observed limitations were inculcated in this study in order to effectively evaluate DAS capability in enhancing LTE-A performance. The channel and simulation model employed in this study is presented in next section.

### 3. Channel and Simulation Model Development

In carrying out this study, the layout scenarios on B3 and B4 stated in [25] by WINNER were modified by considering the topology of typical classroom/office building layout in our School/Faculty building as shown in Fig. 3. As shown in Fig. 3, the building consists of three floors, each floor with a height of 3.4 meters with two corridors of 1.84 by 53.0 meters. Each

typical room has the size of 3.4 by 3.5 meters while typical classroom has 9.1 by 9.3 meters. The distributed antennas were installed on the wall of the two corridors of each floor at a distance of about 22 meters apart. Also, the height of the UE or mobile terminal relative to the floor is about 1.8 meters. The conceptual DAS in Fig. 4 and Fig. 3 were used for the development of the simulation model for the study.



Fig. 3. Outline of developed DASs (Adapted from [21]).

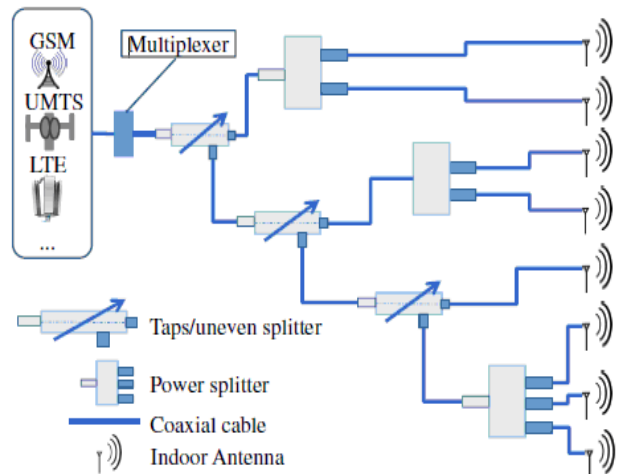

Fig. 4. Conceptualization of the developed DASs [26].

For the channel model development, three different scenarios were considered as three channel models or equations were developed for each scenario. In the first scenario, when the UE and the DAS were located along the same corridor on the same floor as shown in Fig. 3, the path loss, ( $PL$ ), model developed was classified as line of sight (LOS) model. The developed  $PL$  model based on adaptation made on generalized expression in [25] is expressed in (1) as;

$$PL(dB) = 13.9 \log_{10} d + 64.4 + 20 \log_{10} \left( \frac{f_c}{5} \right) \quad (1)$$

where  $d$  is the distance between the distributed antennas and  $f_c$  is the carrier frequency in GHz. Similarly, in the second

scenario, when the when both UE and the DAS were deployed on the same corridor on the same floor but the UE is placed in either room(s)/classroom(s), the *PL* model developed in this scenario was classified as non-line of sight (NLOS) model as shown in Fig. 3. Thus, the developed model based on adaptation made on generalized expression in [25] for this NLOS scenario is expressed in (2) as;

$$PL(dB) = 37.8 \log_{10} d + 36.5 + 23 \log_{10} \left( \frac{f_c}{5} \right) + WL(n_w - 1) \quad (2)$$

where  $WL(n_w - 1)$  is the wall penetration loss in dB, which its value depends on different materials for the wall. Finally, the third scenario is when the UE and the distributed antennas were located on different floors. In this case, the propagation path between them was also viewed as NLOS. Thus, the employed model according to [25] for this NLOS scenario is expressed in (3) as;

$$PL(dB) = 20 \log_{10} d + 46.4 + 20 \log_{10} \left( \frac{f_c}{5} \right) + WL(n_w - 1) + 4(n_f - 1) \quad (3)$$

where  $n_w$  and  $n_f$  in equations (2) and (3) denote the number of walls and floor on the path between the receiver and the transmitter respectively.

On the other hand, another model was developed for an outdoor to indoor scenario where the UE antenna height was assumed to be  $3(n_{fl} - 1) + 1.5$  in meter and base station antenna height at 10 meter. The developed LOS *PL* model for this scenario is given as;

$$PL(dB) = \left[ \begin{array}{l} 40 \log_{10} d + 9.45 - \\ 17.3 \log_{10} h_{BS} - \\ 17.3 \log_{10} h_{MS} + \\ 2.7 \log_{10} \left( \frac{f_c}{5} \right) (d_{out} + d_{in}) \end{array} \right] + [14 + 15(1 - \cos \theta^2)] + 0.5d_{in} \quad (4)$$

where  $h_{BS}$  is the height of the base station,  $h_{MS}$  is the height of the mobile station or UE while  $d_{out}$  and  $d_{in}$  are the outdoor and indoor distances respectively.

After the successful development of the four modeled equations, equations (1)-(4), the developed or modeled equations were used to model two different algorithms; one with DAS and the other without DAS. The effectiveness of DAS in enhancing the LTE-A scenarios was evaluated using the signal-to-noise ratio (SNR) and bit error rate (BER) for the two algorithms. The results obtained for both the indoor and outdoor scenarios were presented and discussed in the Section 4.

#### 4. Simulation Results and Discussion

For the indoor hotspot LOS and outdoor to indoor LOS scenarios the obtained graphical results obtained when SNR was plotted against BER are presented in Fig. 5(a) and Fig. 5(b) respectively. Similarly, for the indoor hotspot NLOS and outdoor to indoor NLOS scenarios, the graphical results obtained when SNR was plotted against BER are presented in Fig. 6(a) and Fig. 6(b) respectively. From Fig. 5(a), at the same SNR value of 5 dB, for instance, while the value of BER for the algorithm with DAS is less than  $10^{-2}$ , the corresponding BER value for the algorithm without DAS is approximately  $10^{-1}$ . The overall results show that the algorithms with DAS outperform the algorithms without DAS. The obtained result also shows that there is a significant improvement in LOS transmission scenarios compare to NLOS transmission scenarios. The results also show that signal reduction in the indoor environment is much greater than the outside environment. These results buttress the inference made by [16] that HetNet provides solution for managing continuously increasing wireless traffic. In addition, the results of this study has shown it clearly that deployment of DAS can boost capacity of wireless cellular systems in congested locations as well as enhancing coverage of wireless cellular systems in areas where macrocells cannot reach perfectly. Furthermore, the results of this study has equally buttress the finding in [26] that bringing radio access closer to the end users is a promising solution for enhancing both the coverage and capacity for indoor mobile or wireless broadband systems.

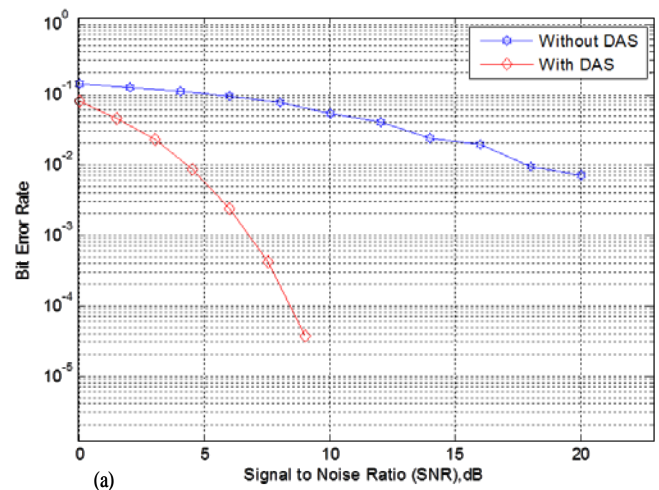
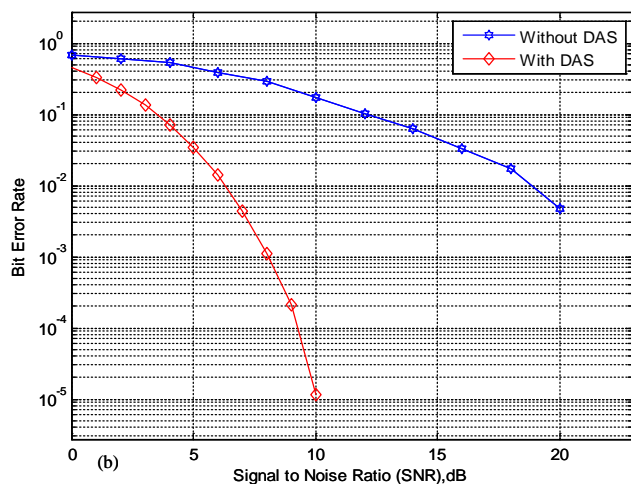
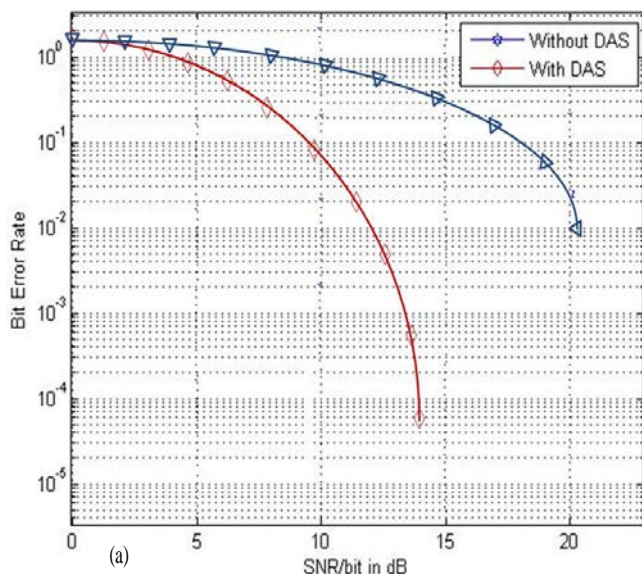

Fig. 5(a). DAS enhancement of BER against SNR under LOS scenario for indoor-hotspot environment.



**Fig. 5(b).** DAS enhancement of BER against SNR under LOS scenario for outdoor-indoor environment.



**Fig. 6(a).** DAS enhancement of BER against SNR under NLOS scenario for indoor-hotspot environment.

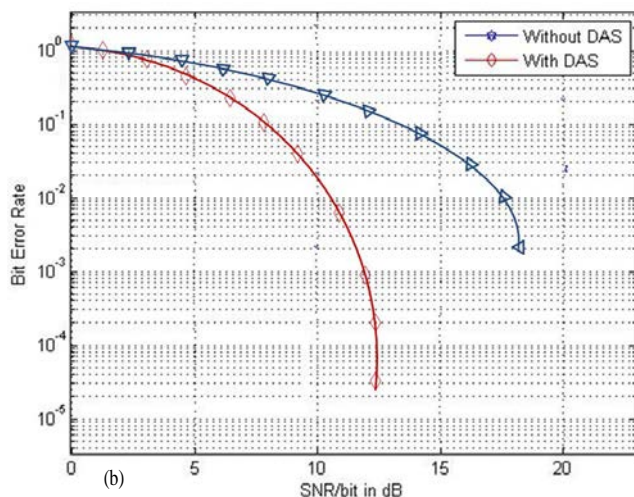

**Fig. 6(b).** DAS enhancement of BER against SNR under NLOS scenario for outdoor-indoor environment.

### 5. Conclusion

This study explored the feasibility of deploying a DAS into a current LTE model to extend its support for the LTE-Advanced. WINNER II channel model has been used as the LTE channel model for this study. This channel was used to create four different scenarios where DAS is involved as a medium of transmitting signal to the UE. Two different algorithms to investigate the efficiency and effectiveness of DAS from the WINNER II model were developed. The performance of the two algorithms was evaluated using the SNR and BER relationship as performance indices for both indoor and outdoor environments. The results of the study show that the algorithms with DAS for the two environments outperform those without DAS. The result of this study also shows that the algorithms developed for this study performs favorably well with results obtained from other studies in the surveyed literature. Finally, the results of this study have demonstrated it clearly that solution provides by mathematical modelling of a real problem is capable of providing optimal and reasonable solutions towards overcoming practical relevant challenge.

### References

- [1] S. Jaswal, A. Kumar, and N. Kumari, "Development of wireless communication networks: From 1G to 5G", *International Journal of Engineering and Computer Science*, Vol. 3, No. 5, pp. 6053-6056, 2014.
- [2] J. Agrawal, R. Patel, P. Mor, P. Dubey, and J.M. Keller, "Evolution of mobile communication network: From 1G to 4G", *International Journal of Multidisciplinary and Current Research*, Vol. 3, No. Nov. /Dec., pp. 1100-1103, 2015.
- [3] I.F. Akyildiz, D.M. Gutierrez-Esteviz, R. Balakrishnan, and E. Chavarria-Reyes, "LTE-Advanced and the evolution to beyond 4G (B4G) systems", *Physical Communication*, Vol. 10, pp. 31-60, 2014.
- [4] D. Astely, E. Dahlman, A. Furuskar, Y. Jading, M. Lindstrom, and S. Parkvall, "LTE: The evolution of mobile broadband", *IEEE Communications Magazine*, Vol. 47, No. 4, pp. 44-51, 2009.
- [5] M. Prasad, R. Manoharan, and P. Suriya, "An effective resource allocation scheme in relay enhanced LTE-A", *Proceedings of International Conference in Communication, Network, and Computing*, pp. 173-178, 2013.
- [6] S. Kanchi, S. Sandilya, S.D. Bhosale, A. Pitkar, and M. Gondhalekar, "Overview of LTE-A Technology", *International Journal of Scientific and Technology Research*, Vol. 2, No. 11, pp. 138-143, 2013.
- [7] Z. Liu, T. Sørensen, J. Wigard, J. Petri, T. Kolding, and P. Mogensen, "A site-specific study of in-building wireless solutions", *71st IEEE Vehicular Technology Conference*, Taipei, Taiwan, pp. 1-5, 16-19 May 2010.
- [8] R. Atawia, M. Ashour, T.E. Shabrawy, and H. Hamed, "Optimized transmitted antenna power indoor planning

- using distributed antenna systems”, 9th IEEE Wireless Communications and Mobile Computing Conference, Cagliari, Sardinia-Italy, pp. 993-1000, 1-5 July 2013.
- [9] V. Chandrasekhar, J. Andrews, and A. Gatherer, “Femtocell networks: A survey”, IEEE Communications Magazine, Vol. 46, No. 9, pp. 59-67.
- [10] A.A.M. Saleh, A.J. Rustako, and R.S. Roman, “distributed antennas for indoor radio communications”, IEEE Transaction on Wireless Communication, Vol. 35, No. 12, pp. 1245-1251.
- [11] E. Park, S.-R. Lee, and I. Lee, “Antenna placement optimization for distributed antenna systems”, IEEE Transaction on Wireless Communication, Vol. 11, No. 7, pp. 2468-2477.
- [12] M. Behjati, R. Nordin, and M. Ismail, “Investigation of rate-loss due to limited feedback LTE-Advanced distributed antenna systems”, 2nd International Symposium on Telecommunication Technologies, Langkawi, Malaysia, pp. 6-10, 24-26 November 2014.
- [13] R.W. Heath, T. Wu, Y.H. Kwon, and A.C. Song, “Multiuser MIMO in distributed antenna systems with out-of-cell interface”, IEEE Transaction on Signal Processing, Vol. 59, No. 10, pp. 4885-4899.
- [14] R.W. Heath, S.W. Peters, Y. Wang, and J. Zhang, “A current perspective on distributed antenna systems for the downlink of cellular systems”, IEEE Communications Magazine, Vol. 51, No. 4, pp. 161-167.
- [15] W. Choi, and J.G. Andrews, “Downlink performance and capacity of distributed antenna systems in a multicell environment”, IEEE Transaction on Wireless Communication, Vol. 6, No. 1, pp. 69-73.
- [16] O. Stanze, and A. Weber, “Heterogeneous networks with LTE-Advanced Technologies”, Bell Labs Technical Journal, Vol. 18, No. 1, pp. 41-58.
- [17] C.-H. Lee, S.-H. Lee, K.-M. Oh, J.S. J.-H. Kim, “Mobile small cells for further enhanced 5G heterogeneous networks”, Electronics and Telecommunication Research Institute Journal, Vol. 37, No. 5, pp. 856-866.
- [18] S.N.S. Kshatriya, S. Kaimalettu, SW.R. Yerrapareddy, K. Milleth, and N. Akhtar, “On interface management based on subframe blanking in heterogeneous LTE networks”, 5th IEEE International Conference on Communication Systems and Networks, Bangalore, India, pp. 1-7, 7-10 January 2013.
- [19] A. Ghosh, R. Ratasuk, B. Mondal, N. Mangalvedhe, and T. Thomas, “LTE-Advanced: Next generation wireless broadband technology”, IEEE Wireless Communications, Vol. 17, No. 3, pp. 10-22.
- [20] D. Lopez-Perez, I. Guvenc, G. de la Roche, M. Kountouris, T.QS. Quek, and J. Zhang, “Enhanced inter-cell interference coordination challenges in heterogeneous networks”, IEEE Wireless Communications, Vol. 18, No. 3, pp. 22-30.
- [21] N. Lux, X. Zhu, F. Yang, and Q. Bi, “Downlink MIMO performance evaluation for LTE/LTE-A indoor distributed antenna systems”, 1st IEEE International Conference on Communications in China: Wireless Networking and Applications, Beijing, China pp. 781-785, 15-18 August 2012.
- [22] A. Attar, H. Li, and V.C.M. Leung, “Applications of fibre-connected distributed antenna systems in broadband wireless access”, 1st IEEE International Conference on Computing and Communications, Maui, HI, USA, pp. 623-627, 30 January- 2 February 2012.
- [23] L-Com®, “What is a distributed antenna systems (DAS)?”, Global connectivity. Online [Available]: <http://www/l-com.com/what-is-a-distributed-antenna-system-das>. Retrieved 23, 2017.
- [24] M. Kurras, K. Borner, L. Thiele, and T. Haustein, “Achievable system performance gains using distributed antenna deployments”, 23rd Annual IEEE International Symposium on Personal, Indoor and Mobile Radio Communications, Sydney, NSW, Australia, pp. 143-148, 9-12 September 2012.
- [25] P. Kyosti, J. Meinila, X. Zhao, T. Jamsa, C. Schneider, M. Narandzic, M. Milojevic, A. Hong, J. Ylitalo, V.-M. Holappa, M. Alatossava, R. Bultitude, Y. de Jong, and T. Rautianinen, “1<sup>ST</sup> -4-027756 WINNER II D1.1.1 V1.1 WINNER II Channel Models”, pp. 1-82. Online [Available]: <http://projects.celtic-initiative.org/winner+/WINNER2-Deliverables/D1.12v.1.pdf>. Retrieved 23, 2017.
- [26] L. Chen, and D. Yuan, “Mathematical modelling for optimal design of in-building distributed antenna systems”, Computer Networks, Vol. 57, No. 17, pp. 3428-3445.