Araştırma Makalesi / Research Article

A Design Software Based on The Placement of Bolts for Bolted Joints

Kadir SARI^{1*}, Hakan DİLİPAK²

¹ Gazi University, Institute of Science, Department of Manufacturing Engineering, Ankara, TÜRKİYE

² Gazi University, Faculty of Technology, Department of Manufacturing Engineering, Ankara, TÜRKİYE
kadirсарion@gmail.com, hdilipak@gazi.edu.tr

Received/Geliş Tarihi: 01.11.2023

Accepted/Kabul Tarihi: 08.12.2023

Abstract: Bolted joints are one of the basic detachable mechanical joint methods designed to hold parts securely together. The design of bolted joints is critical in terms of safety and strength. The calculation of the number of bolts, placement and location of bolts constitutes a complex and time-consuming design process. In this study, a design study was carried out for the optimization of bolted joints under lateral load. For this purpose, a software with a graphical user interface was developed using C# programming language in Visual Studio environment. The user-friendly graphical interface guides the user accurately and facilitates the use with its visual structure. Design outputs are calculated automatically by the software with few user inputs. The study is based on the principle of bolt placement. In the software, bolt diameter, number of tours in row and column are taken as input. In line with the inputs, the software gives the minimum and maximum values of the plate width and length, the distances between the bolts, the distances of the bolts to the edges and creates a design range for the design of the joint. The calculated design parameters are reflected to the designer with a visualization. With the developed software, the design of bolted joints is realized for very few user inputs. As a result, user workload in design processes is minimized and time is saved. By comparing the results obtained with the software and the theoretical solutions, the developed software was found to be 100% reliable.

Keywords: Bolted joint, Design, Optimization, Placement, Software

Cıvatalı Bağlantılar için Cıvataların Yerleşim Düzenini Esas Alan Bir Tasarım Yazılımı

Özet: Cıvatalı bağlantılar, parçaları güvenli bir şekilde bir arada tutmak için tasarlanan temel sökülebilir mekanik bağlantı yöntemlerinden biridir. Cıvatalı bağlantıların tasarımı, güvenlik ve dayanım yönünden oldukça kritiktir. Cıvataların sayısı, yerleşim düzeni ve konumlarının hesabı karmaşık ve zaman alan bir tasarım süreci meydana getirmektedir. Bu çalışmada, yanal yük altındaki cıvatalı bağlantıların optimizasyonuna yönelik bir tasarım çalışması gerçekleştirilmiştir. Bu amaçla Visual Studio ortamında C# programlama dili kullanılarak grafik kullanıcı arayüzüne sahip bir yazılım geliştirilmiştir. Kullanıcı dostu grafik arayüz, kullanıcıyı doğru bir şekilde yönlendirmekte ve kullanımı görsel yapısıyla kolaylaştırmaktadır. Tasarım çıktıları, az sayıda kullanıcı girdisi ile yazılım tarafından otomatik hesaplanmaktadır. Çalışma, cıvataların yerleşim düzeni prensibini esas almaktadır. Yazılımda, cıvata çapı, satır ve sütundaki tur sayıları girdi olarak alınmaktadır. Yazılım, girdiler doğrultusunda bağlantının tasarımı için, plaka en ve boy uzunluklarının, cıvatalar arası mesafelerin, cıvataların kenarlara olan uzaklıklarının en az ve en çok olarak değerlerini vermekte ve bir tasarım aralığı oluşturmaktadır. Hesaplanan tasarım parametreleri, tasarımcıya bir görsel ile birlikte yansıtılmaktadır. Geliştirilen yazılım ile cıvatalı bağlantıların tasarımı çok az sayıda kullanıcı girdisi için gerçekleştirilmektedir. Sonuç olarak tasarım süreçlerinde kullanıcı iş yükü en aza indirilmiştir ve zamanda kazanç sağlanmıştır. Yazılım ile elde edilen sonuçlar ve teorik çözümler karşılaştırılarak geliştirilen yazılım %100 güvenilir bulunmuştur.

Anahtar Kelimeler: Cıvatalı bağlantı, Tasarım, Optimizasyon, Yerleşim, Yazılım

1. Introduction

There are various joining methods in today's engineering and industrial applications. One of these methods, bolted joints, is one of the basic methods used in industry. These mechanical joints, which offer a simple but effective structure, have superior functionality in joining elements. Bolted joints, which have been preferred in many areas for centuries, are of great importance in today's world. In many industries and fields, strong and reliable systems and structures are created using bolted joints. Therefore, the design, analysis, optimization, element selection, correct sizing and assembly processes of bolted joints are critical to the success of systems and structures.

Bolted joints are one of the basic mechanical jointing methods designed and used to hold parts together and connect them securely. These joints consist of machine elements such as bolts, nuts and washers, providing strong and reliable systems.

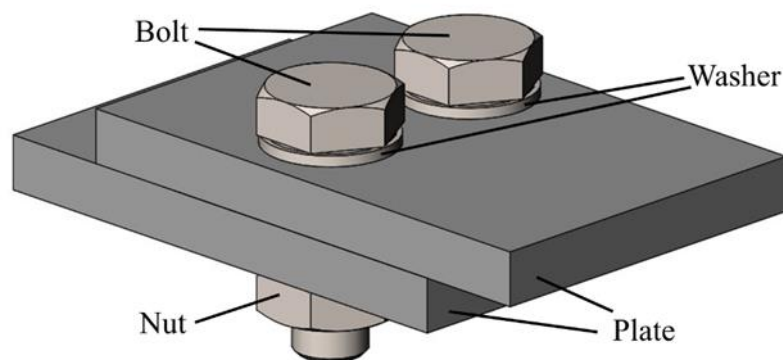

Figure 1. Bolted joint example

Bolts are produced in different sizes and materials. In this way, they can be used for various applications and areas. Bolted joints are widely preferred in industry and application areas such as machinery, automotive, aviation. Correct assembly process and regular control of joints are important to ensure safe and robust connections. Bolted joints, which are a basic joint method for the engineering field, are effective and efficient when they are applied correctly.

The design process of bolted joints is of vital importance for application areas such as structures, machines, etc. systems. Due to their simple structure and easy handling, they save material and labor. Optimization of the joint is achieved by determining the most appropriate dimensioning, material selection and assembly process for a particular application, and this process ensures efficient performance. It can fulfil various application requirements. They ensure compliance with safety, durability and quality standards. Assembly and disassembly processes are easy and thus the probability of error is low. Enables fast production. It facilitates regular control and maintenance of the joint. For these reasons, the design process of bolted joints should be carried out carefully and according to the principles.

There are many studies on bolted joints in the literature. The effects of step spacing, row spacing, end spacing and bolt diameter on multiple composite joints were investigated (Chutima and Blackie, 1996). MSC. Patran finite element software was used and a plug-in called BOLJAT was developed to facilitate the modelling process of composite bolted joints (Padhi et al, 2002). A design software with a graphical interface for riveted and bolted joints subjected to compound loads was presented (Bogis et al, 2004). The use of optimization technology in the improvement of bolted joint design was presented. Finite element analysis and design of a bolted joint using ANSYS Workbench was studied. The aim of the study is to minimize the bolted joint deformation to optimize the joint (Piscan et al, 2012). In order to prevent failures in bolted joints and to ensure fire resistance at high

temperature, the effect of end spacing and number of bolts on the bearing strength of the bolted joint was investigated using experimental results (Yang et al, 2013). In order to ensure uniform distribution of the loads on bolted joints, a multi-objective optimization model for the position of the bolts used in the joint is presented in Nastran finite element software (SAE, 2013). The behavior of elongated end plate joints with circular bolt pattern was investigated under static and cyclic loads. They were compared with joints with square bolt pattern. The effects of various bolt diameters and end plate thicknesses on the bolt force distribution of each bolt pattern were investigated (Kiamanesh et al, 2013). The reliability of bolt spacing in bolted steel structural joints was investigated by monte carlo simulation method (Öztekin, 2015). The effect of the pitch difference in bolt-nut joints on anti-loosening performance and fatigue life was investigated (Noda et al, 2016). The effects of end spacing on thin sheet steel (TSS) bolted joints were investigated experimentally. The joint specimens were of two types: single shear and double shear. Different bolt diameters and plate thicknesses were used in the joint types (Cai and Young, 2019). A methodology for optimizing the design of bolted joints in horizontal plates and pressure vessels under tensile and shear loading is presented (Palacios et al, 2020). The focus was on the influence of geometrical parameters such as bolt positioning, joint length on the static behavior of the joint and mechanical properties such as stiffness and strength (Romanov et al, 2021). An approach to optimize the number and location of fasteners in bolted joints and to optimize the shape and topology of these bolted joints is presented (Rakotondrainibe et al, 2022). The effect of hole tolerance and bolt tightening torque on the joint strength of bolted single lap joints was investigated theoretically and by finite element analysis (Saraç, 2022). It is aimed to improve the EF7 engine flywheel bolted joint design with theoretical and experimental investigations (Asadi Taheri, 2022).

Studies in the literature have addressed the effect of geometrical properties and different parameters, bolt spacing, modelling processes, lateral, compound, etc. loads on the strength of joints of different types and materials. Theoretical, experimental and numerical studies were carried out and design and analysis software were developed. In addition, finite element analysis and optimization techniques were used to improve the performance of bolted joints. Previous research contributes to the development of different methods to optimize bolted joints, increase their durability and ensure their reliability.

In this study, bolted joints under lateral loads were studied. For this purpose, a software called "BJD SOFT" was developed to calculate bolt placements and plate dimensions including width and length parameters for joint designs with different bolt diameters and bolt numbers. For each joint type, minimum and maximum results are produced according to the user inputs and thus the design of bolted joints can be optimized. A graphical user interface was designed for the developed software and a clear and easy to use interface was presented to the user.

With this study, more flexible designs for bolted joints are realized compared to the limited systems and designs in the literature. For minimum user input, possible design options are automatically reflected to the user instantly and optimization is performed. A visual and interactive structure is obtained with the use of a graphical user interface, which is rare in the literature.

2. Placement of Bolts

For bolted joints, the placement of the bolts and the distances between the bolts are calculated using the formulations given for the spacings transferred in the standards. One of these standards is TS648 standard. Using this standard, the distances between the bolts, the distances of the bolts to the edges and the width and length of the plate can be determined by means of these parameters. A joint visualization offering a sample layout for the placement of bolt holes is given in Figure 2 below. The

TS648 standard in question is taken as basis and formulations (Eqs. 1 – 11) are given for each parameter on the given figure (TSE, 1980).

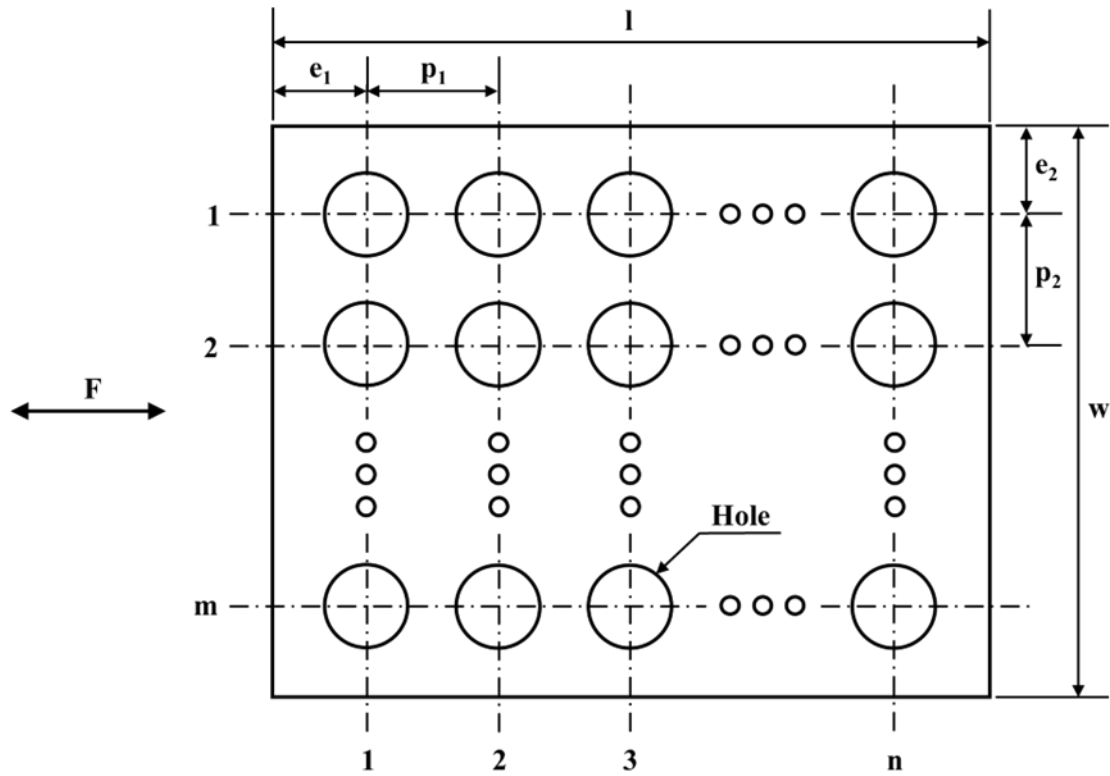

Figure 2. Placement layout for bolt holes

$$d_h = d * 0,85 \quad (1)$$

$$p_{1min} = p_{2min} = 3 * d_h \quad (2)$$

$$p_{1max} = p_{2max} = 8 * d_h \quad (3)$$

$$e_{1min} = 2 * d_h \quad (4)$$

$$e_{1max} = 3 * d_h \quad (5)$$

$$e_{2min} = 1,5 * d_h \quad (6)$$

$$e_{2max} = 3 * d_h \quad (7)$$

$$w_{min} = 2 * e_{2min} + (m - 1) * p_{2min} \quad (8)$$

$$w_{max} = 2 * e_{2max} + (m - 1) * p_{2max} \quad (9)$$

$$l_{min} = 2 * e_{1min} + (n - 1) * p_{1min} \quad (10)$$

$$l_{max} = 2 * e_{1max} + (n - 1) * p_{1max} \quad (11)$$

d : Bolt nominal diameter (mm)

d_h : Hole diameter (mm)

p_1, p_2 : Distance between bolt holes (mm)

e_1 : Distance of the bolts to the edges in the direction of impact (mm)

e_2 : Distance of the bolts to the edges in the direction perpendicular to the impact (mm)

l : Plate length (mm)

w : Plate width (mm)

3. Developed Software

In this study, a design software called "BJD SOFT" was developed for bolted joints. A graphical user interface was designed for the software developed in Visual Studio environment. The software is used to design bolted joints based on the principle of bolt placement.

The software consists of input, design area and result sections. In the input section, the diameter of the bolt to be used in the joint and the number of bolts tours in each row and column are taken from the user. Design area is the area where the bolted joint layout is given visually. In the result section, the placement positions of the bolts and plate dimensions are given as output. The results are run by clicking the Calculate button.

According to the user inputs, the width and length of the plates, the distances between the bolts and the distances of the bolts to the edges are automatically calculated in the software background. These design parameters are reflected to the user in detail in the result section in relation to the visual in the design area. These parameters include minimum and maximum values that can be used for the joint and these values form a range. The user can realize the design by staying within this range.

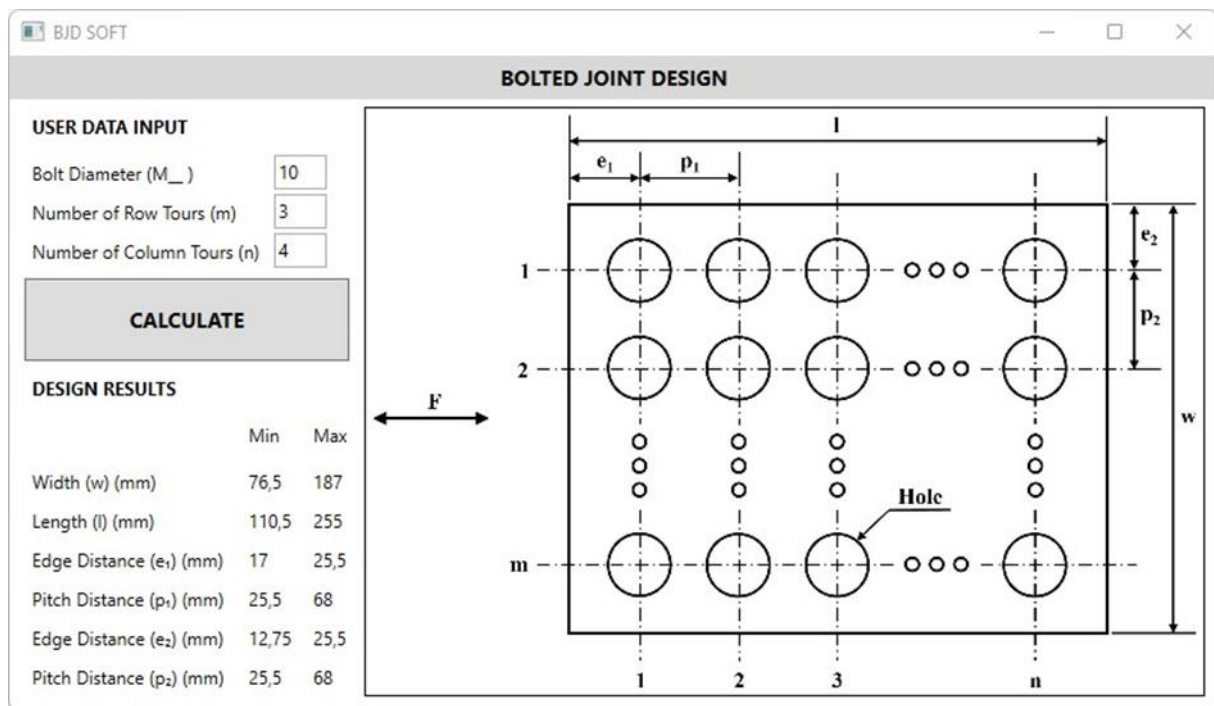

Figure 3. Software interface

3.1. Example Applications

In this section, sample studies were carried out on the developed software. Comparisons were made with the theoretical solutions for the software outputs and the accuracy of the developed software was ensured.

In the verification process, two bolted joint problems were used as examples.

3.1.1. Example Application - 1

In the first example problem, the number of bolts used in the bolted joint under lateral load is 12. The number of bolts tours in the row is given as 3 and the number of bolts tours in the column is given as 4. The plates were joined using M10 bolts. In this direction, it was requested to calculate the placement of the bolts and to determine the width and length values of the plates.

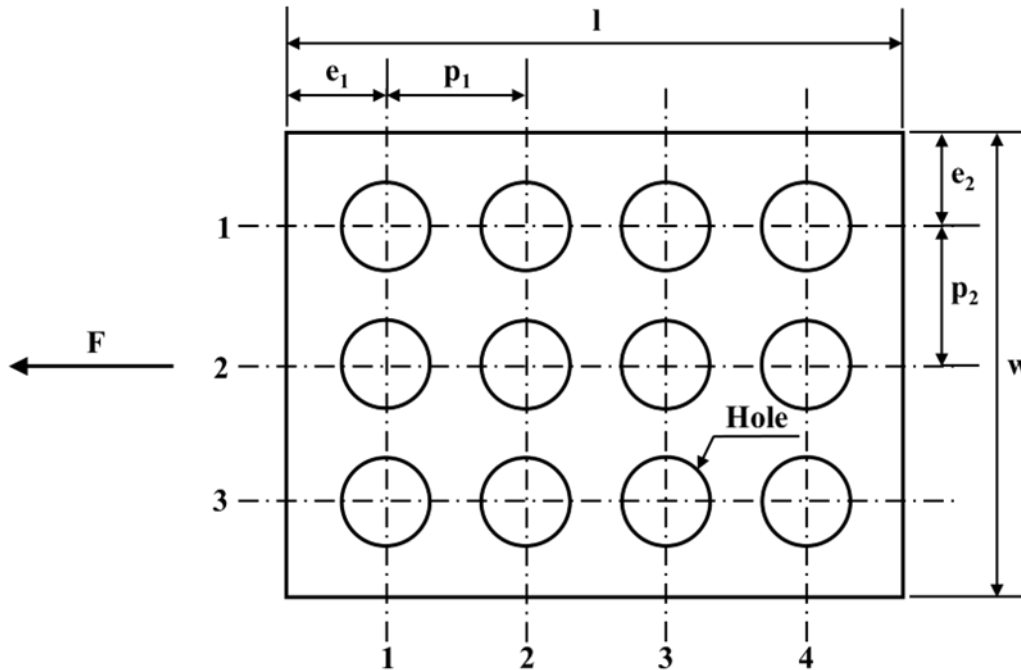

Figure 4. Example problem for bolted joint under lateral load – 1

According to these data, with the help of the bolt placement formulation, the placement of the bolts and the plate dimensions are found. The distances between the bolts (p_1 and p_2), the distances of the bolts to the edges (e_1 and e_2) were calculated. According to these calculated values, plate width (w) and length (l) values were found. The minimum and maximum values of all these design parameters are given below.

Firstly, the unknown hole diameter (d_h) in the formula was found using the bolt diameter.

$$d_h = d * 0,85 = 10 * 0,85 = 8,5 \text{ mm} \quad (8)$$

This value was then substituted in the formulae below and the design parameters were calculated.

$$p_{1_{min}} = p_{2_{min}} = 3 * d_h = 3 * 8,5 = 25,5 \text{ mm} \quad (9)$$

$$p_{1_{max}} = p_{2_{max}} = 8 * d_h = 8 * 8,5 = 68 \text{ mm} \quad (10)$$

$$e_{1_{min}} = 2 * d_h = 2 * 8,5 = 17 \text{ mm} \quad (11)$$

$$e_{1_{max}} = 3 * d_h = 3 * 8,5 = 25,5 \text{ mm} \quad (12)$$

$$e_{2_{min}} = 1,5 * d_h = 1,5 * 8,5 = 12,75 \text{ mm} \quad (13)$$

$$e_{2_{max}} = 3 * d_h = 3 * 8,5 = 25,5 \text{ mm} \quad (14)$$

Using these values, the minimum and maximum values of the plate width (w) and length (l) were calculated.

$$w_{min} = 2 * e_{2_{min}} + 2 * p_{2_{min}} = 2 * 12,75 + 2 * 25,5 = 76,5 \text{ mm} \quad (15)$$

$$w_{max} = 2 * e_{2_{max}} + 2 * p_{2_{max}} = 2 * 25,5 + 2 * 68 = 187 \text{ mm} \quad (16)$$

$$l_{min} = 2 * e_{1_{min}} + 3 * p_{1_{min}} = 2 * 17 + 3 * 25,5 = 110,5 \text{ mm} \quad (17)$$

$$l_{max} = 2 * e_{1_{max}} + 3 * p_{1_{max}} = 2 * 25,5 + 3 * 68 = 255 \text{ mm} \quad (18)$$

After the procedures, this sample problem was applied to the developed software and the software was verified by making comparisons. In the user input field on the software interface, the bolt diameter was entered as 10, the number of rows tours as 3 and the number of columns tours as 4. The calculation process for the example problem was carried out automatically by clicking the Calculate button. In the design results section, the plate width (w) and length (l), the distances of the bolts to the edges (e_1 and e_2) and the distances between the bolts (p_1 and p_2) were given as minimum and maximum.

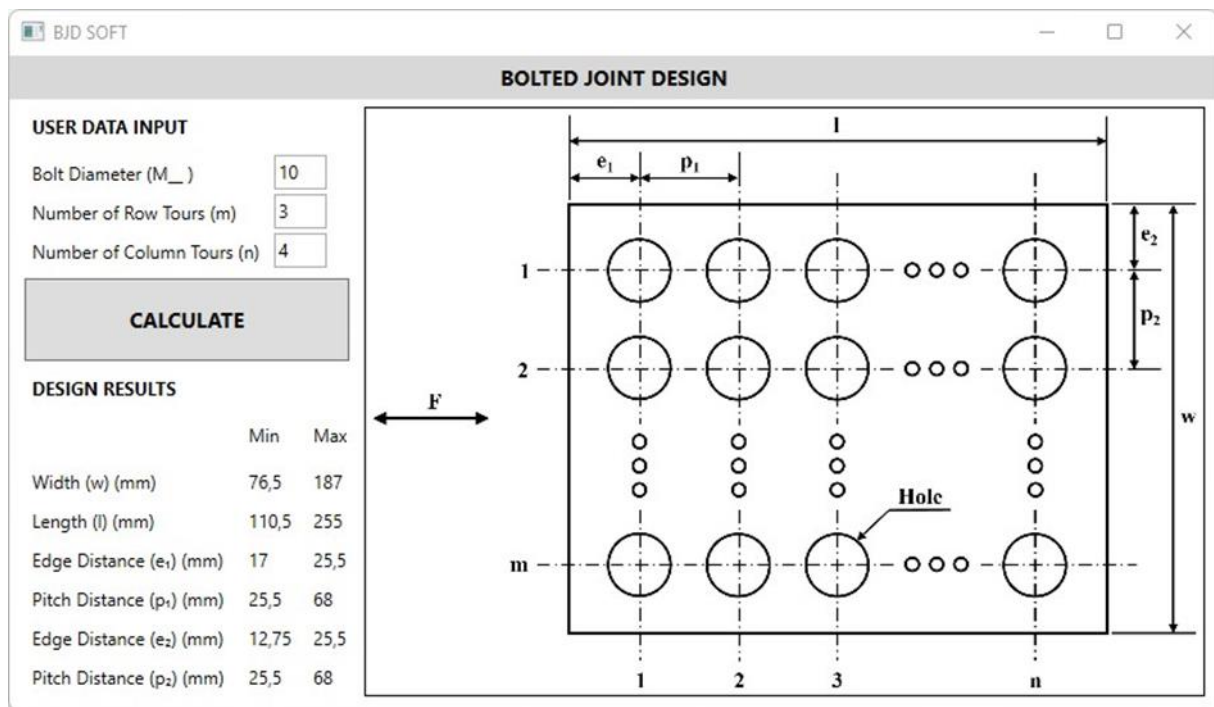

Figure 5. Example application - 1

In the developed software, the values calculated in the design results section were compared with the values found in the theoretical solutions. As a result of this comparison, it was seen that the outputs were compatible with each other.

3.1.2. Example Application - 2

In the bolted joint subjected to lateral load in the second example problem, 6 bolts are used. In the layout, the number of bolt tours in the row was arranged as 2 and the number of bolt tours in the column was arranged as 3. The plates were joined with M12 bolts. According to these data, it was requested to determine the bolt layout for the joint and to calculate the width and length values of the plates.

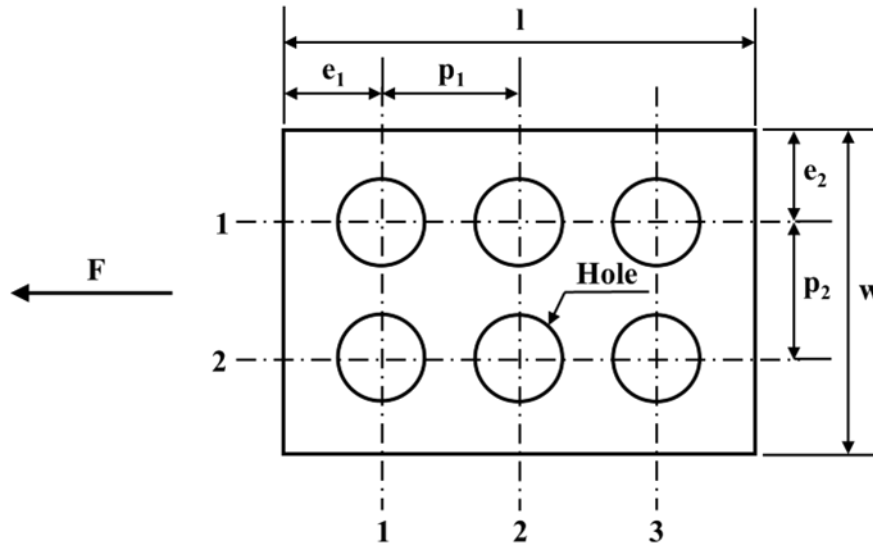

Figure 6. Example problem for bolted joint under lateral load - 2

For this data, the principle of bolt placement is used to calculate the placement of the bolts and the dimensioning calculations for the plates. The distances between the bolts (p_1 and p_2) and the distances of the bolts to the edges (e_1 and e_2) were calculated. For these values, plate width (w) and length (l) values were calculated. The process of calculating the minimum and maximum values for these design parameters is explained below.

Firstly, the unknown hole diameter (d_h) parameter was calculated with the help of the bolt diameter given in the example.

$$d_h = d * 0,85 = 12 * 0,85 = 10,2 \text{ mm} \quad (19)$$

This value was substituted in the following formulae and the design parameters for the placement of the bolts were calculated.

$$p_{1_{min}} = p_{2_{min}} = 3 * d_h = 3 * 10,2 = 30,6 \text{ mm} \quad (20)$$

$$p_{1_{max}} = p_{2_{max}} = 8 * d_h = 8 * 10,2 = 81,6 \text{ mm} \quad (21)$$

$$e_{1_{min}} = 2 * d_h = 2 * 10,2 = 20,4 \text{ mm} \quad (22)$$

$$e_{1_{max}} = 3 * d_h = 3 * 10,2 = 30,6 \text{ mm} \quad (23)$$

$$e_{2_{min}} = 1,5 * d_h = 1,5 * 10,2 = 15,3 \text{ mm} \quad (24)$$

$$e_{2_{max}} = 3 * d_h = 3 * 10,2 = 30,6 \text{ mm} \quad (25)$$

Using these design parameters, the minimum and maximum values of plate width (w) and length (l) were found.

$$w_{min} = 2 * e_{2_{min}} + 1 * p_{2_{min}} = 2 * 15,3 + 1 * 30,6 = 61,2 \text{ mm} \quad (26)$$

$$w_{max} = 2 * e_{2_{max}} + 1 * p_{2_{max}} = 2 * 30,6 + 1 * 81,6 = 142,8 \text{ mm} \quad (27)$$

$$l_{min} = 2 * e_{1_{min}} + 2 * p_{1_{min}} = 2 * 20,4 + 2 * 30,6 = 102 \text{ mm} \quad (28)$$

$$l_{max} = 2 * e_{1_{max}} + 2 * p_{1_{max}} = 2 * 30,6 + 2 * 81,6 = 224,4 \text{ mm} \quad (29)$$

After these procedures, the example problem in question was also implemented in the developed software. Verification was provided by comparing the outputs. In the user input field on the interface, the bolt diameter was entered as 12, the number of row tours was entered as 2 and the number of column tours was entered as 3. The Calculate button was clicked. Accordingly, the calculation process was performed automatically. In the design results section of the interface, the minimum and maximum values for the plate width (w) and length (l), the distances of the bolts to the edges (e_1 and e_2) and the distances between the bolts (p_1 and p_2) were reflected to the user.

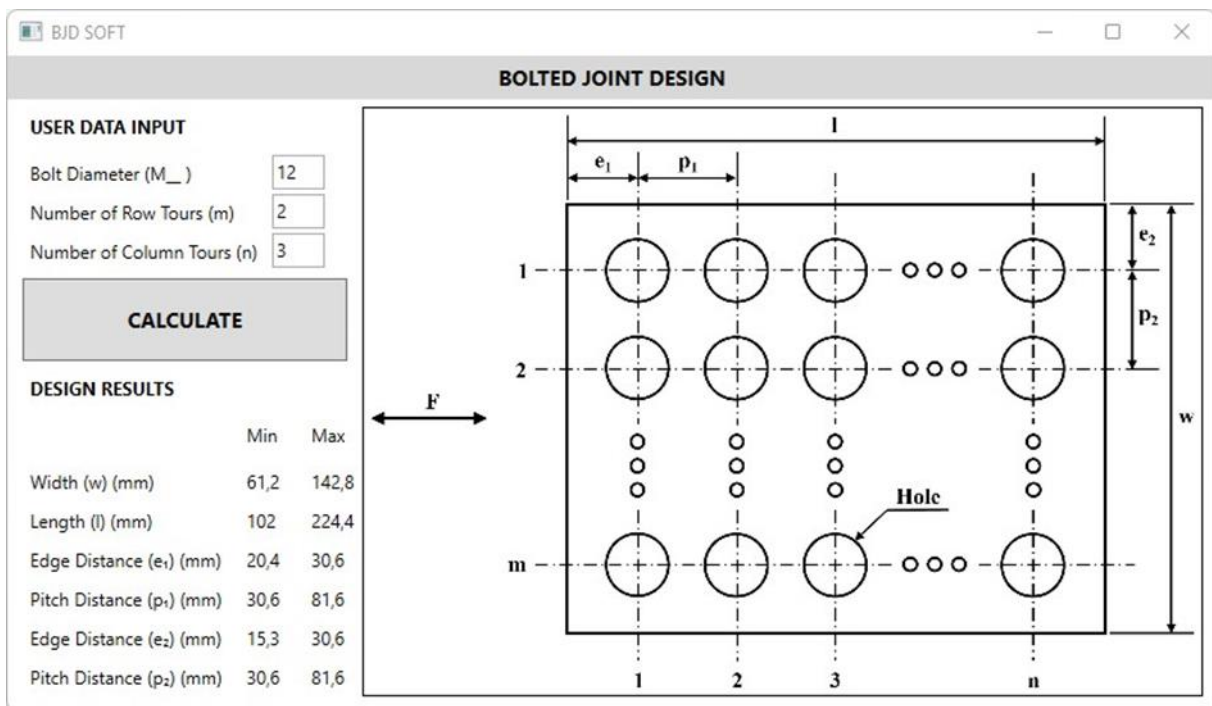

Figure 7. Example application - 2

The values calculated in the developed software and the values obtained from the theoretical solutions were compared. At the end of the comparison process, the outputs were found to be compatible.

4. Conclusions and Suggestions

In this study, a software was developed to automate and facilitate the design and optimization of bolted joints. A minimum number of inputs are received from the user and as a result, design options for the bolted joint are given as output. In this context, the principle of the placement of the bolts was taken as a basis. The results output by the software were compared with the results obtained with the theoretical solutions and it was concluded that they were compatible with each other.

In today's industry, labor and time losses occur in the design process, which is undesirable. In the present study, the user provides a small number of inputs for the design conditions and obtains design ranges for the optimum bolted joint by means of the software. Design calculations were performed instantaneously and results were generated. Different design options can be easily and quickly given as input to the software. Within the scope of the software, the principle of placement of fasteners for bolted joints was taken as a subject and a result-oriented structure was obtained with the software. The designed graphical user interface was easy to use with its clear and visual structure. According to these results, losses in the design process were prevented. By reaching the result with an easy and fast process, a significant amount of total time and labor saving was achieved. The design software developed effectively and efficiently performs the design and optimization of bolted joints for different placement layouts.

In line with this study, various studies can be carried out in the future. Studies can be carried out for different joint types such as riveted joints. The scope can be expanded with the applied forces and material properties of the elements used. Other loading conditions can be added. Joints with different geometries can be included. Artificial intelligence techniques such as machine learning can be applied.

Conflict of Interest

There is no conflict of interest between the authors.

References

- Asadi Taheri, M., Hajiali Mohammadi, A. & Alizadehnia, S. (2022). EF7 Engine Flywheel Bolted Joint Design Improvement By Theoretical and Experimental Investigations. *Engine Research.*, 48(48), 27-40.
- Bogis, H. A., Abou Ezz, A., Aljinaidi, A. A. & Akyurt, M. (2004). Computer-Aided Design of Riveted and Bolted Joints Under Compound Loading. Mechanical Engineering Department of King Abdulaziz University notes, Jeddah, Saudi Arabia, https://www.kau.edu.sa/files/320/researches/35125_20.pdf
- Cai, Y. & Young, B. (2019). Effects of End Distance on Thin Sheet Steel Bolted Connections. *Engineering Structures*, 196, 109331. <https://doi.org/10.1016/j.engstruct.2019.109331>
- Chutima, S. & Blackie, A. P. (1996). Effect of Pitch Distance, Row Spacing, End Distance and Bolt Diameter on Multi-Fastened Composite Joints. *Composites Part A: Applied Science And Manufacturing*, 27(2), 105-110. [https://doi.org/10.1016/1359-835X\(95\)00020-3](https://doi.org/10.1016/1359-835X(95)00020-3)
- Kiamanesh, R., Abolmaali, A. & Razavi, M. (2013). Effect of Circular Bolt Pattern on Behavior of Extended End-Plate Connection. *Journal of Structural Engineering*, 139(11), 1833-1841. [https://doi.org/10.1061/\(ASCE\)ST.1943-541X.0000765](https://doi.org/10.1061/(ASCE)ST.1943-541X.0000765)
- Noda, N. A., Chen, X., Sano, Y., Wahab, M. A., Maruyama, H., Fujisawa, R. & Takase, Y. (2016). Effect of Pitch Difference Between The Bolt–Nut Connections Upon The Anti-Loosening Performance And Fatigue Life. *Materials & Design*, 96, 476-489. <https://doi.org/10.1016/j.matdes.2016.01.128>
- Öztekin, E. Ö. (2015). Investigation of Reliabilities of Bolt Distances For Bolted Structural Steel Connections By Monte Carlo Simulation Method. *Pamukkale Üniversitesi Mühendislik Bilimleri Dergisi*, 21(6), 213-223.
- Padhi, G. S., McCarthy, M. A. & McCarthy, C. T. (2002). BOLJAT: A Tool For Designing Composite Bolted Joints Using Three-Dimensional Finite Element Analysis. *Composites Part A: Applied Science and Manufacturing*, 33(11), 1573-1584. [https://doi.org/10.1016/S1359-835X\(02\)00113-6](https://doi.org/10.1016/S1359-835X(02)00113-6)

- Palacios, C. G., Mansilla, D. T. & Arteaga, A. M. (2020). A Methodology For Optimizing Bolted Joint Design. *Investigación Tecnológica IST Central Técnico*, 2(1), 13-13.
- Piscan, I., Predinca, N. & Pop, N. (2012). Finite Element Analysis and Design Exploration of a Bolted Joint. *Advanced Materials Research*, 463, 1601-1604. <https://doi.org/10.4028/www.scientific.net/AMR.463-464.1601>
- Rakotondrainibe, L., Desai, J., Orval, P. & Allaire, G. (2022). Coupled Topology Optimization of Structure and Connections For Bolted Mechanical Systems. *European Journal of Mechanics-A/Solids*, 93, 104499. <https://doi.org/10.1016/j.euromechsol.2021.104499>
- Romanov, V. S., Heidari-Rarani, M. & Lessard, L. (2021). A Parametric Study on Static Behavior and Load Sharing Of Multi-Bolt Hybrid Bonded/Bolted Composite Joints. *Composites Part B: Engineering*, 217, 108897. <https://doi.org/10.1016/j.compositesb.2021.108897>
- Yang, K. C., Hsu, R. J. & Hsu, C. F. (2013). Effect of end distance and bolt number on bearing strength of bolted connections at elevated temperature. *International Journal of Steel Structures*, 13, 635-644. <https://doi.org/10.1007/s13296-013-4005-y>
- SAE Technical Paper. (2013). Multi-Objectives Optimization of Fastener Location in a Bolted Joint (No. 2013-01-0966). <https://doi.org/10.4271/2013-01-0966>
- Saraç, İ. (2022). Cıvatalı Bağlantılarda Delik Toleransı ve Cıvata Sıkma Torku Değişiminin Bağlantı Dayanımına Etkilerinin Sayısal Olarak İncelenmesi. *Gazi Üniversitesi Mühendislik Mimarlık Fakültesi Dergisi*, 37(2), 685-696. <https://doi.org/10.17341/gazimmfd.761996>
- TSE. (1980). Çelik Yapıların Hesap ve Yapım Kuralları. Ankara, Türkiye, 648.