DEPENDENCE OF THE GAIN IN HfBi-EDFA ON THE PUMPING CONFIGURATION AND ACTIVE FIBER LENGTH

Aşkınnur AŞKIN * 

Fırat Ertaç DURAK * 

Şerif Ali SADIK ** 

Mukul Chandra PAUL *** 

Nur Farhanah ZULKIPLI **** 

Sulaiman Wadi HARUN **** 

Ahmet ALTUNCU ***** 

Received: 19.12.2023; revised: 08.04.2024; accepted: 09.09.2024

Abstract: In this study, gain dependence in Hafnium-Bismuth-Erbium co-doped fiber amplifier (HfBi-EDFA) on pumping configuration and active fiber length were analyzed experimentally. Gain and signal output power characteristics of the heavily co-doped HfBi-EDFA pumped with a 980 nm pump laser were experimentally obtained for different pumping methods (forward, backward and bidirectional) as functions of pump power, signal input power, and wavelength. During the study, 0.3 m and 1.1 m long HfBi-EDF and a signal input power of -30 dBm at 1550 nm were used, and the pump power was increased from 60 mW to 204 mW. A moderate gain of over 11 dB was obtained in forward and backward pumping configurations but the gain has remained at around 7 dB in the bidirectional pumping configuration. The spectral gain measurements were realized across a 1520 nm - 1605 nm wavelength range, and the forward and backward pumping configurations resulted in the best gain values at 1532 nm with a gain of around 17 dB. It was also shown that when the HfBi-EDF length is 0.3 m, optical amplification in the C band is achieved. For the fiber length of 1.1 m, the gain spectrum shifts towards the L band.

Keywords: Erbium Doped Fiber Amplifiers, Hafnium-Bismuth-Erbium Co-Doped Fiber, HfBi-EDFA, Gain Performance, Broadband Fiber Optical Communication

* Kütahya Dumlupınar Üniversitesi, Mühendislik Fakültesi, Elektrik-Elektronik Mühendisliği Bölümü, 43100, Kütahya, Türkiye

** Kütahya Dumlupınar Üniversitesi, Mühendislik Fakültesi, Yazılım Mühendisliği Bölümü, 43100, Kütahya, Türkiye

*** CSIR-Central Glass and Ceramic Research Institute, 700032, West Bengal, India

**** University of Malaya, Faculty of Engineering, Department of Electrical Engineering, 50603, Kuala Lumpur, Malaysia

***** Afyon Kocatepe Üniversitesi, Teknoloji Fakültesi, Elektrik-Elektronik Mühendisliği Bölümü, 03200, Afyonkarahisar, Türkiye

İletişim yazarı: Ahmet ALTUNCU (aaltuncu@aku.edu.tr)

This paper is an expanded version of the paper entitled 'Hafnium-Bismut-Erbium Coefficient Fiber Amplifier (HfBi-EDFA) Gain Performance Dependence on Pumping Method', which was presented orally at the ELECO'2022 Symposium and was invited by the symposium executive board to be evaluated in the Uludağ University Journal of the Faculty of Engineering.

HfBi-EDFA Yükselteç Kazanç Performansının Pompalama Konfigürasyonu Ve Aktif Fiber Uzunluğuna Bağlılığı

Öz: Bu çalışmada, Hafniyum-Bizmut-Erbiyum ortak katkılı fiber yükselteçte (HfBi-EDFA) kazancın pompalama konfigürasyonuna ve aktif fiber uzunluğuna bağlılığı deneysel olarak analiz edilmiştir. 980 nm pompa lazeri ile pompalanan, yoğun katkılı HfBi-EDFA'nın üç farklı pompalama konfigürasyonu için (ileri, geri ve çift yönlü pompalamalı) kazanç ve sinyal çıkış gücü performansı, pompa gücü, sinyal giriş gücü ve dalga boyunun fonksiyonu olarak analiz edilmiştir. Deneysel çalışmada, aktif kazanç ortamı olarak 0,3 m ve 1.1 m uzunluklarında yoğun katkılı HfBi-EDF kullanılmış; sinyal giriş gücü 1550 nm dalgaboyunda -30 dBm'de sabit tutularak, pompa gücü 60 mW-204 mW aralığında değiştirilmiştir. İleri ve geri yönlü pompalamalı HfBi-EDFA için 11 dB'in üzerinde orta düzeyde bir kazanç elde edilirken, çift yönlü pompalamalı HfBi-EDFA için kazanç seviyesi 7 dB civarında kalmıştır. Üç farklı pompalama konfigürasyonu için kazanç spektrumu ölçümleri 1520 nm - 1605 nm dalga boyu aralığında gerçekleştirilmiş, ileri ve geri pompalamalı HfBi-EDFA konfigürasyonları için 1532 nm'de 17 dB civarında en iyi kazanç değeri elde edilmiştir. Bu çalışmada ayrıca, HfBi-EDF uzunluğu 0,3 m olduğunda C bandında optik amplifikasyonun sağlandığı gösterilmiştir. 1,1 m'lik aktif fiber uzunluğu için ise kazanç spektrumu L bandına doğru kaymaktadır.

Anahtar Kelimeler: Erbiyum Katkılı Fiber Yükselteçler, Hafniyum-Bizmut-Erbiyum Ortak Katkılı Fiber, HfBi-EDFA, Kazanç Performansı, Geniş Band Fiber Optik Haberleşme

1. INTRODUCTION

In recent years, studies have been carried out to make the fiber optical devices used in fiber optical communication networks more compact with the aim of being more user-friendly and low-cost (Renaudier, 2022) (Konyshev, 2023). For this purpose, increasing the doping concentration of the active fiber used in the gain medium has been one of the suggested solutions to make compact fiber optical amplifiers and fiber lasers (Chen, 2023) (Al-Azzawi A. A., et al., 2018). In long-distance fiber optical communication systems, the use of erbium-doped fiber amplifiers (EDFA) has become widespread as the most effective method known to amplify the weak optical signals in C (1530-1565 nm) and L (1570-1605 nm) bands (Giles & Desurvire, 1991). In modern fiber optical communication systems, by directly optically amplifying the optical signals with the use of fiber optical amplifiers, system complexities has decreased and transmission capacities have increased significantly. Increasing the Er^{3+} doping concentration will allow shortening the active fiber length, hence the development of more compact optical amplifiers. However, studies show that increasing the concentration of Er^{3+} ions increases the clustering effect between Er^{3+} ions, thus reducing the gain efficiency of the optical amplifier (Almukhtar A. A., et al., 2019). In order to further increase the Er^{3+} doping concentration in active fibers, it is recommended to use co-dopant materials such as bismuth, zirconium and hafnium (Al-Azzawi A. A., et al., 2019a) (Al-Azzawi A. A., et al., 2019b).

In recent years, a group of researchers has focused their interests on the type of HfBi co-doped EDFA (HfBi-EDFA), which is formed by the co-doping of Er^{3+} with Hf and Bi ions. It has been observed that co-doping of the active fiber with Hf and Bi alongside Er^{3+} significantly reduces the clustering effect in the active fiber (Almukhtar A. A., et al., 2019). Thus, active fiber can be doped with Er^{3+} more densely and homogeneously, and a shorter length of active fiber can be sufficient to build a compact optical amplifier module. Theoretically, the gain spectrum of classical EDFA can cover the wavelength range of 1530 nm to 1610 nm. However, it is not possible to make a single amplifier that provides sufficient gain across the C+L band. A short length of EDF is sufficient to provide high gain in the C band. On the other hand, in order to obtain a sufficient gain in the L band, a longer length of active fiber must be used (Altuncu & Basgumus, 2005). In addition, all-optical gain clamping and gain flattening operation in L-Band

EDFAs can be achieved using a lasing-controlled structure with an FBG pair (Durak & Altuncu, 2018). In a different study, sufficient gain levels have been demonstrated in the C+L band with a HfBi-EDFA with a triple-pass amplifier configuration (Almukhtar A. A., et al., 2020).

Interestingly, (Al-Azzawi A. A., et al., 2018) have also compared the amplified spontaneous emission (ASE) spectra of a forward pumped HfBi-EDFA with the gain and noise figure (NF) spectra for three different active fiber lengths. The results have shown that the highest gain in C band was obtained with the active fiber length of 0.5 m. When the length of the active fiber increases the gain spectra shifts to the L band region. In 2022, the researchers have developed a wide-band ASE source that can operate in all of the S+C+L bands using both parallel and serial configurations with a total length of 2 m HfBi-EDF as the gain medium. They have proven that the serial HfBi-EDFA configuration has provided an output ASE spectrum with a slightly wider bandwidth, higher output power, higher efficiency and lower complexity (Al-Azzawi A. A., et al., 2022). In a different study, the performance of the optical amplifier utilizing 0.5 m HfBi-EDF and 4 m Zr-EDF as the gain medium have been examined and the performances of backward and forward pumping configurations have been compared. The results have shown that the backward pumping configuration provides a relatively better performance than the forward pumping configuration (Al-Azzawi A. A., et al., 2019b).

HfBi-EDF active fibers have also been used to study compact tunable HfBi-EDF fiber ring lasers (Zakaria, et al., 2018). In this study, wavelength tunable output signal spectra of both forward and backward pumped HfBi-EDF ring laser configurations were investigated and they observed that backward pumping configuration has achieved better results in terms of threshold pump power and slope efficiency in fiber ring laser output signal. In a different study, the experimental operation of a Brillouin fiber laser designed using a 0.5 m long HfBi-EDF as the gain medium has been demonstrated (Ahmad, et al., 2018). In this study, 0.5 m length of HfBi-EDF used to make a Brillouin fiber laser could not provide sufficient gain in the L band due to insufficient population inversion level. As a result of the studies presented in recent literature and summarised above, it was seen that fiber optical amplifiers based on co-doping of Er^{3+} in active fiber with different elements such as hafnium, bismuth, zirconium are a hot topic among optical amplifier studies. Furthermore, it is seen that there is still a room to study on compact optical amplifier designs by optimizing the critical parameters such as pumping configuration, active fiber length and pumping power.

In this study, gain dependence of the heavily doped HfBi-EDFA on the pumping configuration and active fiber length were analyzed experimentally. Firstly, a HfBi-EDF with a length of 0.3 m was used as the active gain medium and the gain performance of the optical amplifier was analyzed for three different pumping configurations as forward, backward and bidirectional pumping, respectively. Secondly, the gain performance of the HfBi-EDFA with backward pumping configuration was analyzed for two different active fiber lengths of 0.3 m and 1.1 m. The results have shown that HfBi-EDFA with forward and backward pumping configurations have the best gain performance among the three pumping configurations. In addition, the longer length of HfBi-EDF (1.1 m) has resulted in a better gain performance in the L band. The results presented in this study have provided a more comprehensive analysis on HfBi-EDFA regarding the gain dependence of pumping configuration and active fiber length and a clear perspective than the limited results previously presented in the literature.

2. EXPERIMENTAL SETUP

In the experimental study, firstly the effect of pumping configuration on the HfBi-EDFA gain performance was investigated. HfBi-EDFA configurations with forward, backward and bidirectional pumping schemes used in the experiments are shown in Figure 1, respectively. The pump laser wavelength preferred in the setup is 980 nm, although commercially available 1480 nm pump lasers could be used with additional thermoelectric coolers and temperature

controllers. The reason is that uncooled type high-power pump laser diodes along with high pump-gain conversion efficiencies operating at 980 nm can be commercially provided. Pump wavelengths of 520 nm, 650 nm, and 830 nm, which are among the absorption bands of erbium ions, are not preferred in practice because they are inefficient pump wavelengths.

C band input signal to be amplified was generated using a broadband tunable laser source (TLS - Goumax TLS-1000) and the input signal power was adjusted with an optical variable attenuator (OVA). C band input signal and pump signal were combined in WDM couplers and were injected to the HfBi-EDF. The HfBi-EDF used had a length of 0.3 m and an Er^{+3} ion density of 12500 wt.ppm. Its maximum absorption at 980 nm is 100 dB/m, the cutoff wavelength is 1050 nm, the core diameter is 3.71 μm , and the cladding diameter is 123.94 μm (Zulkipli, et al., 2021). Two isolators were used at the input and output ports of the HfBi-EDFA to prevent unwanted back reflections and oscillations caused by the FC/PC connectors. For the gain characterization measurements of HfBi-EDFA, an optical spectrum analyzer (OSA - Anritsu MS9710B) was used.

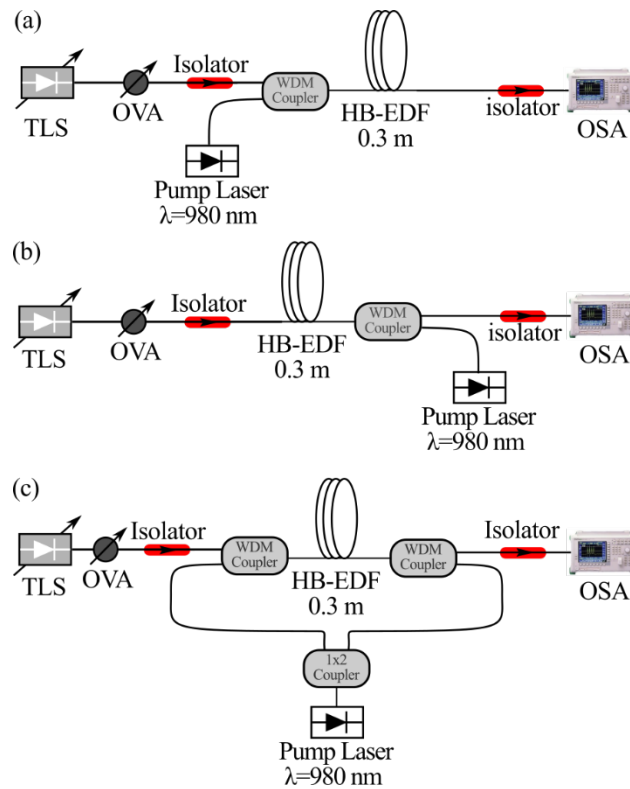

Figure 1:
HfBi-EDFA experimental setup for (a) forward, (b) backward and (c) bidirectional pumping configurations

In the second experiment, backward pumping configuration was used to analyze the gain performance of HfBi-EDFA with two different lengths of active fiber. The experimental setup used in this configuration is given in Figure 2. The HfBi-EDF lengths used in the experiments were 0.3 m and 1.1 m.

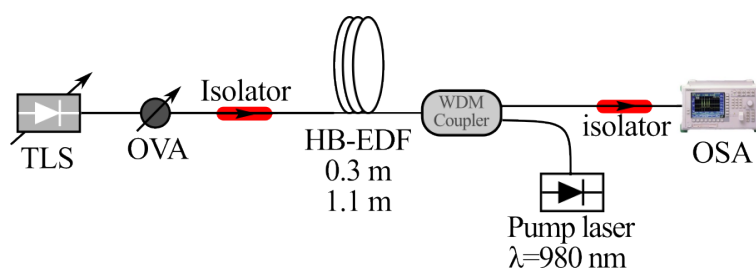

Figure 2:
HfBi-EDFA experimental setup with 0.3m and 1.1m active fiber

3. EXPERIMENTAL RESULTS

In this study, firstly, an input signal power of -30 dBm at 1550 nm was applied to the HfBi-EDFA and the pump power was increased from 65 mW to 204 mW for three different pumping configurations shown in Figure 1. The gain and signal output power of HfBi-EDFA were measured as a function of pumping power. Figure 3 shows the measured gain and signal output power as a function of the pumping power for forward, backward and bidirectional pumping configurations. In Fig.3, it is seen that the HfBi-EDFA gain begin to saturate at a pump power value of approximately 170 mW so that the gain increase above 170 mW was limited to 0.5 dB. When the three pumping configurations are compared for a pump power of 204 mW, it is seen that the gain measured in forward pumping configuration is 0.05 dB and 3.67 dB higher than that of backward and bidirectional pumping configurations, respectively. When the variation of signal output power with increasing pump power is examined, it is seen that with the forward pumping configuration, the signal output power is 0.18 dB and 3.66 dB higher than the obtained in the backward and bidirectional pumping configurations, respectively. It was concluded that there exists small differences in gain and signal output power values for forward and backward pumping configurations caused mainly by measurement errors. However, it was thought that the lower gain and signal output power obtained in the bidirectional pumping configuration was due to the insertion loss of 1x2 pump splitter and WDM couplers and also the losses arising from the increased number of fusion splices. Since the gain advantage of bidirectional pumping was less than the losses mentioned above; the net gain of this configuration was 3.7 dB lower than the other two configurations.

Figure 4 shows the dependence of the gain and signal output power as a function of the signal input power for three different pumping configurations. In this experiment, the signal input power at 1550 nm was increased from -30 dBm to 6 dBm, and the gain and signal output power of the amplifier was measured. It can be seen in Fig.4.a that for the signal input powers less than -10 dBm where the gain has not reached saturation yet, the gain was almost the same in forward and backward pumping configurations. However, it is clearly seen that the gain becomes higher in forward pumping configuration for the saturating signal input powers of higher than -10 dBm. Moreover, the gain obtained in the bidirectional pumping configuration was lower than the obtained in the other configurations due to extra insertion losses. It is also seen that the gain difference between the bidirectional pumping and other configurations have decreased in the saturation region.

In the last step of the first experiment, the gain spectra of HfBi-EDFA were measured in the range of 1520 - 1605 nm for three different pumping configurations. During the measurement, the pump power was kept constant at 204 mW and the signal input power was -30 dBm and active fiber length was 0.3 m. HfBi-EDFA gain spectra obtained for three different pumping configurations are given in Figure 5. As can be seen from Fig.5, the HfBi-EDFA gain varies with the signal wavelength as it is common for classical EDFA gain spectrum and takes its maximum value at 1530 nm region. It is also seen in Fig.5 that the gain spectra variation of the

forward and backward pumping configurations were almost the same, but approximately 5.7 dB lower gain variation was measured at the bidirectional pumping configuration. Although the HfBi-EDF used in this experiment was short (0.3 m), it is very promising to observe that it also provides a positive gain in the L band region of the spectrum. As a result of this experiment, it has been seen that a compact C band optical fiber amplifier with high gain can be designed using a very short length of HfBi-EDF less than 1 m, and an L band optical fiber amplifier with sufficient gain can be designed using a relatively longer HfBi-EDF around 2 m. In addition, the methods recommended in the literature to increase pump conversion efficiency in L band can be utilized.

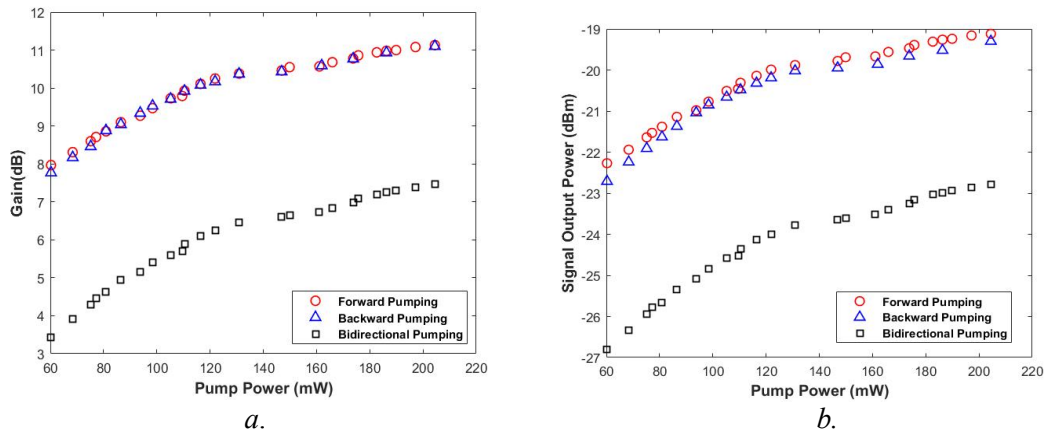

Figure 3: HfBi-EDFA (a) gain and (b) signal output power variation with pump power for forward, backward and bidirectional pumping configurations

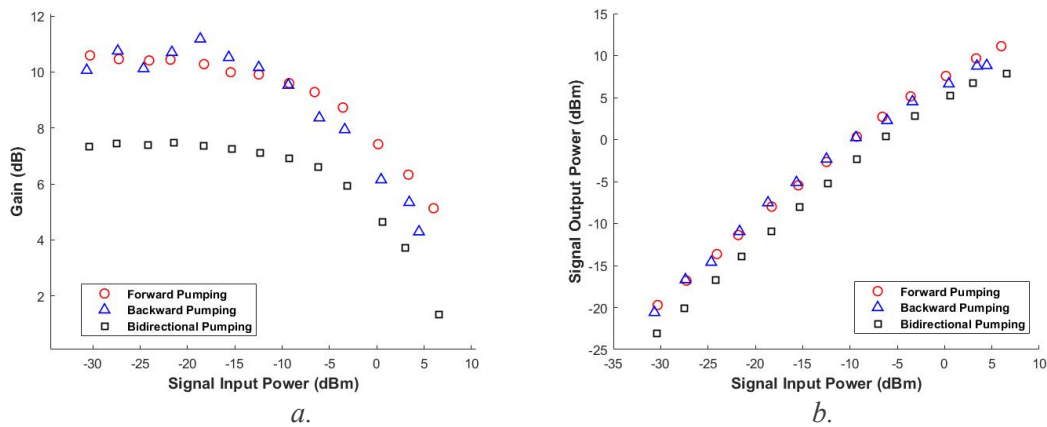

Figure 4: HfBi-EDFA (a) gain and (b) signal output power variation with signal input power for forward, backward and bidirectional pumping configurations

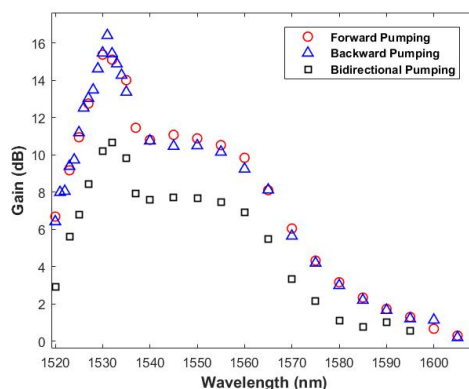

Figure 5:

Gain spectra of HfBi-EDFA with forward, backward and bidirectional pumping configurations.

In the second step of this study, the gain and signal output power performance characterization was performed by changing the length of HfBi-EDF as 0.3 m and 1.1 m. The experimental setup used in this step is shown in Fig.2. For the spectral gain measurements using two different lengths of HfBi-EDF, signal input power was -30 dBm for the wavelength range of 1520 - 1605 nm and the pump power was kept constant at 204 mW. Figure 6 shows the measured gain spectra of HfBi-EDFA for two different active fiber lengths : 0.3 m and 1.1 m. As it can be seen in Fig.6, the highest gain was measured as 19.06 dB at 1560 nm with the HfBi-EDFA having 1.1 m active fiber. For the HfBi-EDFA having 0.3 m active fiber operating at the C band, a peak gain of 16.4 dB was measured at 1532 nm. This fully reflects the emission spectrum characteristics of erbium ions that are heavily doped in the active fiber. When the gain spectra of both configurations are compared, it is seen that high gain is obtained in the C band for 0.3 m HfBi-EDF, but the gain spectrum shifts towards the L band as the length of the active fiber increases to 1.1 m. The gain spectra of HfBi-EDF with lengths of 0.5 m, 1.1 m, and 1.3 m were previously presented in (Zulkipli, et al., 2021) and coincide with our results presented in this study. As described in (Zulkipli, et al., 2021), a C band gain spectrum is obtained when the HfBi-EDF length is approximately less than 1 m. For HfBi-EDF lengths over 1 m, the gain spectrum shifts towards the L band. In this study, the active fiber length was chosen as 0.3 m because a gain spectrum at the C band was aimed for a compact amplifier structure having as short active fiber as possible. Using an active fiber length less than 0.3 m is not sufficient to achieve a gain peak for the pump power provided in the setup.

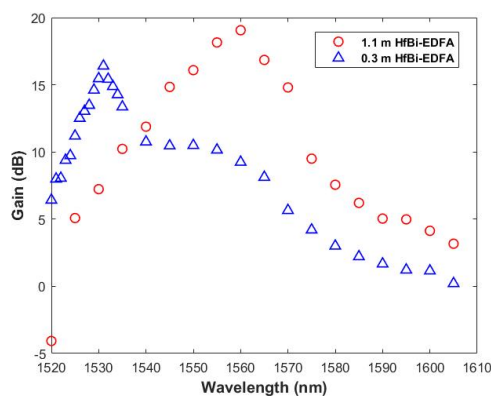

Figure 6:

Gain spectra of HfBi-EDFA for two different active fiber lengths : 0.3m and 1.1m

Figure 7 shows the gain performance of the HfBi-EDFA as a function of the signal input power at 1550 nm for two different lengths of active fiber: 0.3 m and 1.1 m. It can be seen in Fig.7 that up to 7 dB higher gain was obtained with the HfBi-EDFA configuration using 1.1 m active fiber for the signal input power less than -10 dBm in which the gain has not reach the saturation level. However, the gain values obtained for two different lengths approach to each other for the saturating signal input powers higher than -10 dBm due to gain saturation. Gain saturation for the signal input powers higher than 0 dBm is more detrimental for 1.1 m active fiber case.

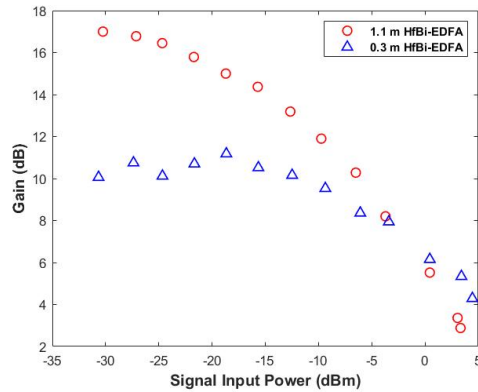

Figure 7:
HfBi-EDFA gain variation as a function of signal input power at 1550 nm for two different active fiber lengths : 0.3m and 1.1m

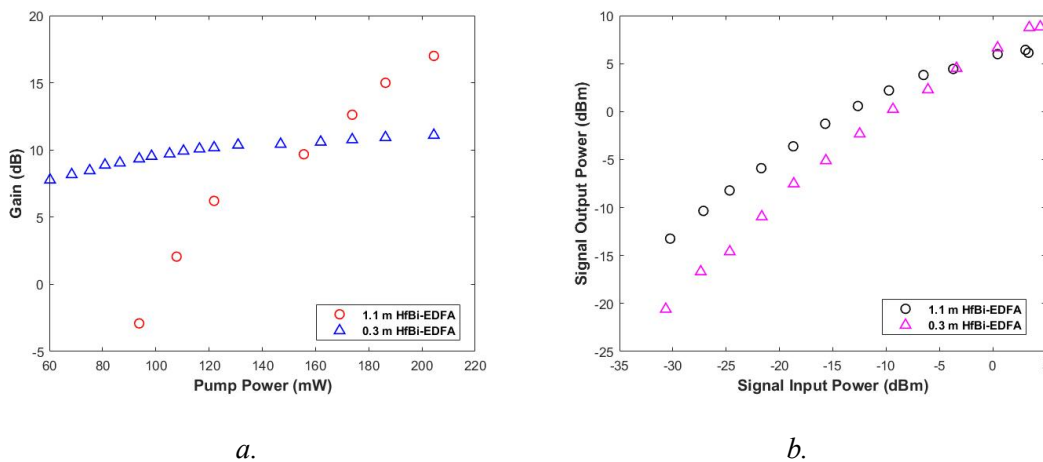

Figure 8:
In HfBi-EDFA (a) gain variation as a function of pump power and (b) signal output power variation as a function of signal input power at 1550 nm, for the active fiber lengths : 0.3m and 1.1m

Finally, the gain performance of HfBi-EDFA as a function of pump power was analyzed for a signal input power of -30 dBm at 1550 nm signal wavelength for two different active fiber lengths, 0.3 m and 1.1 m. As can be seen in Figure 8.a, despite the pump power increase from 90 to 210 mW in the setup for 0.3 m active fiber, it was observed that the gain has slightly increased from 8 dB to 11 dB. However, when 1.1 m active fiber was used, it is seen that a significantly higher gain was obtained, specifically for the pump powers higher than 170 mW, and the gain rises up to 19 dB at 230 mW pump power. Figure 8.b also shows the signal output

power variation as a function of the signal input power for 0.3 m and 1.1 m active fiber lengths. The pump power was kept at 204.46 mW in this measurement. The gain saturation effect is less detrimental in the case of 0.3 m long active fiber as it is noticed in the Fig.8b.

5. CONCLUSION

In this study, a heavily doped HfBi-EDF (Er^{+3} ion density of 12500 wt.ppm) was used for a compact optical amplifier design and, its gain and signal output power performance was analyzed for three different pumping configurations (forward, backward and bidirectional) and for two different active fiber lengths (0.3 m and 1.1 m). It was observed that a sufficient gain was obtained in the C band for only 0.3 m long active fiber, in the L band for only 1.1 long active fiber. For three different pumping configurations, pump power, signal input power and signal wavelength dependence of the gain and signal output power in HfBi-EDFA were investigated. The gain performance in forward pumping configuration was almost same with the backward pumping configuration, on the other hand, it was significantly higher than the bidirectional pumping configuration. It has been observed that the additional insertion losses caused by the 1x2 pump splitter and the second WDM coupler used in the bidirectional pumping configuration reduce the gain efficiency. Therefore, the use of a short length active fiber in the bidirectional pumping method is not advantageous.

The spectral gain performance of the HfBi-EDFA is also strongly dependent on the active fiber length. Therefore, active fiber length used in a certain type of doped fiber amplifier must be carefully optimized with considering the other parameters such as pumping power, pumping wavelength, active fiber doping density, doped materials etc. It can be generally concluded that, when the HfBi-EDF length is approximately less than 1 m, optical amplification in the C band is achieved. For active fiber lengths longer than 1 m, the gain spectrum shifts towards the L band. In this study, the HfBi-EDF length was chosen as 0.3 m for C band operation and 1.1 m for L band operation since a compact amplifier structure having as short active fiber as possible was aimed. In conclusion, it has been understood that compact fiber optical amplifiers operating in C and L bands can be realized and involved in new generation broadband fiber optical communication systems using very short length, highly doped HfBi-EDF active fibers.

CONFLICTS OF INTEREST

The authors approve that to the best of their knowledge, there is not any conflict of interest or common interest with an institution/organization or a person.

AUTHORS CONTRIBUTIONS

Aşkınnur Aşkın, Determining the concept and/or design process of the research, data collection, data analysis and interpretation of the results, preparation of the manuscript, critical analysis of the intellectual content, final approval and full responsibility.

Fırat Ertaç Durak, Determining the concept and/or design process of the research, data collection, data analysis and interpretation of the results, preparation of the manuscript, critical analysis of the intellectual content, final approval and full responsibility.

Şerif Ali Sadık, Determining the concept and/or design process of the research, data collection, data analysis and interpretation of the results, preparation of the manuscript, critical analysis of the intellectual content, final approval and full responsibility.

Mukul Chandra Paul, Data collection, critical analysis of the intellectual content, final approval and full responsibility.

Nur Farhanah Zulkipli, Data collection, critical analysis of the intellectual content, final approval and full responsibility.

Sulaiman Wadi Harun, Management of the concept and/or design process of the research, critical analysis of the intellectual content, final approval and full responsibility.

Ahmet Altuncu, Management of the concept and/or design process of the research, critical analysis of the intellectual content, final approval and full responsibility.

REFERENCES

1. Ahmad, A., Cheng, X., Paul, M., Dhar, A., Das, S., Ahmad, H., & Harun, S. (2018). Investigation of the Brillouin Effect in Highly Nonlinear Hafnium Bismuth Erbium Doped Fiber. *Microwave and Optical Technology Letters*, 61(1), 173-177. doi:https://doi.org/10.1002/mop.31522
2. Al-Azzawi, A. A., Almukhtar, A., Hamida, B., Das, S., Dhar, A., Paul, M., . . . Harun, S. (2019b). Wideband and Flat Gain Series Erbium Doped Fiber Amplifier Using Hybrid Active Fiber with Backward Pumping Distribution Technique. *Results in Physics*, 13(102186). doi:https://doi.org/10.1016/j.rinp.2019.102186
3. Al-Azzawi, A. A., Almukhtar, A., Hmood, J., Das, S., Dhar, A., Paul, M., & Harun, S. (2022). Broadband ASE Source for S + C + L Bands Using Hafnia-Bismuth Based Erbium Co-Doped Fibers. *Optik*, 255(168723). doi:https://doi.org/10.1016/j.ijleo.2022.168723
4. Al-Azzawi, A. A., Almukhtar, A., Reddy, P., Dutta, D., Das, S., Dhar, A., . . . Harun, S. (2018). Compact and Flat Gain Fiber Optical Amplifier With Hafnia-Bismuth-Erbium Co-Doped Fiber. *Optik*, 170, 56-60. doi:https://doi.org/10.1016/j.ijleo.2018.05.104
5. Al-Azzawi, A. A., Almukhtar, A., Reddy, P., Dutta, D., Das, S., Dhar, A., . . . Harun, S. (2019a). Wide-Band Flat-Gain Optical Amplifier Using Hafnia And Zirconia Erbium Co-Doped Fibres in Double Pass Parallel Configuration. *Journal of Modern Optics*, 66(16), 1711-1716. doi:https://doi.org/10.1080/09500340.2019.1660813
6. Almukhtar, A. A., Al-Azzawi, A., Cheng, X., Reddy, P., Dhar, A., Paul, M., . . . Harun, S. (2020). Enhanced Triple-Pass Hybrid Erbium Doped Fiber Amplifier Using Distribution Pumping Scheme in a Dual-Stage Configuration. *Optik*, 204(164191). doi:https://doi.org/10.1016/j.ijleo.2020.164191
7. Almukhtar, A. A., Al-Azzawi, A., Jusoh, Z., Razak, N., Reddy, P., Dutta, D., . . . Harun, S. (2019). Flat-Gain Optical Amplification Within 70 nm Wavelength Band Using 199 cm Long Hybrid Erbium Fibers. *Optoelectronics and Advanced Materials-Rapid Communications*, 13(7-8), 391-395.
8. Altuncu, A., & Basgumus, A. (2005). Gain enhancement in L-band loop EDFA through C-band signal injection. *Photonics Technology Letters*, 17(7), 1402-1404. doi:https://doi.org/10.1109/LPT.2005.848565
9. Chen, X. Y. (2023). Functional fibers and functional fiber-based components for high-power lasers. *Advanced Fiber Materials*, 5(1), 59-106. doi:https://doi.org/10.1007/s42765-022-00219-7
10. Durak, F. E., & Altuncu, A. (2018). All-optical Gain Clamping and Flattening in L-Band EDFAs Using Lasing-Controlled Structure With FBG. *Optical Fiber Technology*, 45, 217-222. doi:https://doi.org/10.1016/j.yofte.2018.07.014

11. Giles, C., & Desurvire, E. (1991). Modeling erbium-doped fiber amplifiers. *Journal of Lightwave Technology*, 9(2), 271-283. doi:<https://doi.org/10.1109/50.65886>
12. Konyshov, V. A. (2023). Trends of and Prospects for the Development of Fiber-Optic Communication Systems. *Bulletin of the Lebedev Physics Institute*, 50(4), S435-S450. doi:<https://doi.org/10.3103/S1068335623160078>
13. Renaudier, J. N. (2022). Devices and fibers for ultrawideband optical communications. *Proceedings of the IEEE*, 110(11), 1742-1759. doi:10.1109/JPROC.2022.3203215
14. Zakaria, U., Harun, S., Reddy, P., Dutta, D., Das, D., Das, S., . . . Yasin, M. (2018). Compact Tunable Hafnia Bismuth Erbium Co-Doped Fiber Laser. *Journal of Non-Oxide Glasses*, 10(3), 77-81. doi:<https://doi.org/10.1016/j.ijleo.2022.168723>
15. Zulkipli, N., Sadik, S., Durak, F., Paul, M., Altuncu, A., & Harun, S. (2021). Gain Clamping Performance of Hafnia-Bismuth-Erbium Co-doped Fibre Amplifier Using Lasing Controlled Structure with FBG. *Journal of Modern Optics*, 68(8), 457-462. doi:<https://doi.org/10.1080/09500340.2021.1912424>

