

## The Impact of Dissolved Salts on the Erosion of Physically Purified Compacted Bentonite

Süleyman BÜLBÜL<sup>1\*</sup> , Akın DUVAN<sup>1</sup> 

### ABSTRACT

Compressed bentonite is an appropriate cushion material for getting rid of spent nuclear waste below the surface storage. The contact of compressed bentonite with water, its immersion in water and subsequently its swelling into the neighboring gaps are the principal processes for the development of colloid fines. In this study, to examine the impact of ionic strength on the erosion of compacted bentonite, only the ionic power values of the water contacting the bentonite were changed by keeping the flow rates constant. Sodium chloride was used to change the ionic power of the water contacting the bentonite throughout the experiment. Turbidity meter (TM) was used to determine the amount of eroded particles. An experimentation methodology is introduced. The implemented flow rates were 0.06 ml/min and 0.22 ml/min, and the selected waters were distilled water and 0.05 M NaCl ionic strength water. The dry densities of the compressed bentonite samples used were 1.67 g/cm<sup>3</sup>, 1.72 g/cm<sup>3</sup>, 1.72 g/cm<sup>3</sup> and 1.72 g/cm<sup>3</sup>. With distilled water, the total erosion value measured at the end of the 24th day using a flow rate of 0.06 ml/min was 1002.7 mg, whereas the final erosion value measured at the end of the 24th day using water containing 0.05 M NaCl salt was 31.13 mg. In the case of distilled water, the total erosion value measured at the end of the 24th day using a flow rate of 0.22 ml/min was 1774.85 mg, while the total erosion value measured at the end of the 24th day using water containing 0.05 M NaCl salt was 73.6 mg. This demonstrates that the influence of the ionic strength of the water on erosion is too important to be neglected.

### Çözünmüş Tuzların Fiziksel Olarak Saflaştırılmış Sıkıştırılmış Bentonitin Erozyonu Üzerindeki Etkisi

#### ÖZET

Sıkıştırılmış bentonit, kullanılan nükleer atıkların yüzey altı depolanması için uygun bir yastık malzemesidir. Sıkıştırılmış bentonitin su ile teması, suya daldırılması ve ardından komşu boşluklara doğru şişmesi, kolloid ince tanelerin gelişimi için temel süreçlerdir. Bu çalışmada, iyonik gücün sıkıştırılmış bentonitin erozyonu üzerindeki etkisini incelemek için, akış hızları sabit tutularak sadece bentonitle temas eden suyun iyonik güç değerleri değiştirilmiştir. Deney boyunca bentonite temas eden suyun iyonik gücünü değiştirmek için sodyum klorür kullanılmıştır. Aşınan parçacık miktarını belirlemek için bulanıklık ölçer (TM) kullanılmıştır. Bir

#### Article Info

\*Corresponding author:

e-mail:

suleymanbulbul@kmu.edu.tr

**Institution:** <sup>1</sup> Karamanoğlu Mehmetbey University

#### Article history

Received: 18/01/2024

Accepted: February 25/03/2024

Available online: 30/04/2024

#### Anahtar Kelimeler:

Bentonit, Tampon, Erozyon, Nükleer atık bertarafı

#### Keywords:

Bentonite, Buffer, Erosion, Nuclear-waste disposal

**How to Cite:** S. Bülbül, A. Duvan

"The Impact of Dissolved Salts on the Erosion of Physically Purified Compacted Bentonite", *Environmental Toxicology and Ecology*, c. 4, sayı. 1, ss. 38-58, 2024.

DOI: 10.59838/etoxec.1422258

deney metodolojisi tanıtılmıştır. Uygulanan akış hızları 0,06 ml/dak ve 0,22 ml/dak, seçilen sular ise damıtılmış su ve 0,05 M NaCl iyonik dayanımlı su olmuştur. Kullanılan sıkıştırılmış bentonit numunelerinin kuru yoğunlukları  $1,67 \text{ g/cm}^3$ ,  $1,72 \text{ g/cm}^3$ ,  $1,72 \text{ g/cm}^3$  ve  $1,72 \text{ g/cm}^3$ 'tür. Damıtılmış su ile, 0,06 ml/dak akış hızı kullanılarak 24. günün sonunda ölçülen toplam erozyon değeri 1002,7 mg iken, 0,05 M NaCl tuzu içeren su kullanılarak 24. günün sonunda ölçülen nihai erozyon değeri 31,13 mg'dır. Damıtılmış su durumunda, 0,22 ml/dak akış hızı kullanılarak 24. günün sonunda ölçülen toplam erozyon değeri 1774,85 mg iken, 0,05 M NaCl tuzu içeren su kullanılarak 24. günün sonunda ölçülen toplam erozyon değeri 73,6 mg'dır. Bu da suyun iyonik kuvvetinin erozyon üzerindeki etkisinin ihmal edilemeyecek kadar önemli olduğunu göstermektedir.

## 1. INTRODUCTION

Compressed clay is utilized in numerous deep bedrock reservoirs to enclose the long-lived containers that contain used radioactive energy. Bentonite is preferred for its swelling performance and elasticity because of its high smectite ingredient (up to 80%). The strong adsorption potential of radioactive nuclides in bentonite is also highly beneficial, because in the event of a canister breakdown, the released radioactive nuclides will be significantly contained by absorption in the clay material [1]. The possibility of water-bearing cracks on the surface of the bentonite buffer cannot be ruled out, although the zones selected for storage in the bedrock have the smallest possible incidence of cracks [2]. As watered smectite is a mixed system itself in the mixture, particles can be produced and dispersed circumstances. It is known that the constancy of fine smectite particles is highly dependent on the subsurface water chemistry with pH and dissolved salt in water being predominant drivers. Nano-sized montmorillonite particles are more determined in water with little salt dissolved [3,4]. If colloid formation at the interface is important and circumstances are favorable to colloidal determination, montmorillonite can be removed from the buffer. If bentonite erosion continues, the expected performance of bentonite will not be met. Based on the bumper breakdown standard of SKB (Swedish Nuclear Fuel and Waste Management), an erosion of more than 5 percent of the bentonite mass is unsuitable [5]. Not only the loss of fine clay particles, but also the carrying of radioactive nuclides inside in bentonite with bentonite brings environmental concerns [6]. After an ice age, glacial meltwater with low salinity can enter the depth of storage with flows high enough not to mix with older and more saline groundwater. This possibility has attracted interest in the Scandinavian nations because a glacial period is predicted within a 10,000-year period [7,8].

Rheological properties of bentonite (mostly Na-bentonite) have been examined by many researchers [9-12]. The dissolution of bentonite fines by a block of flowing subsurface water at the contacting place of pressurized bentonite and cracked igneous rock has been experimentally examined by several investigators under a variety of geochemical circumstances [13-15]. According to the findings of the researchers, it was observed that the eroded particles increased with the rise in the flow rate.

The size and shape of colloids emitted from a natural bentonite into a low-mineral subsurface water are studied employing different colloid characterization approaches. In this study, a turbidity meter was used to measure the influence of dissolved salts on erosion. The purpose of this research is to evaluate the effect of the dissolved salts of the water contacting the bentonite during the prescribed water influx on the amount of erosion of compacted bentonite used for spent nuclear fuel deposition.

In the experimental results, when the ionic strength of the water acting on the system was increased, the amount of erosion obtained decreased significantly. In this series of experiments, not only the effect of the flow rate and the ionic strength of the water acting on the system separately, but also the effect of these two factors on the erosion of compacted bentonite was investigated by increasing them together.

## 2. MATERIALS AND METHODS

In this section, the properties of the material used, the method of obtaining physically purified bentonite, the experimental setup, the ionic strength of the water acting on the system and how the amount of eroded bentonite particles was determined are presented. All experiments were carried out at room temperature (26 °C).

### 2.1. Raw Bentonite

Bentonite utilized in these experimental studies called Voclay was acquired by Amcol firm in 2018. The composition of the materials of Voclay clay are presented in Table 1.

**Table 1.** Mineral ingredient of Voclay bentonite used in these experimental studies.

Assets	Percentage
Clay friction (%)	56
Smectite content (%)	86,8
Accessory minerals (%)	13,2
Quartz	3,9
Plagioclase	5,6
K-feldspar	0,9
Pyrite	0,2
Gypsum	trace
Compositions (%)	SiO <sub>2</sub> = 62.30, Al <sub>2</sub> O <sub>3</sub> = 19.13, Fe <sub>2</sub> O <sub>3</sub> = 10.31, CaO = 3.70, K <sub>2</sub> O = 1.39, MgO =1.52, P <sub>2</sub> O <sub>5</sub> = 0.38, TiO <sub>2</sub> = 0.39
Water content (%)	11,8
Liquid limit (%)	435
Plastic limit (%)	51,9
Specific gravity	2,73
External surface area (m <sup>2</sup> /g)	19,98
Total surface area(m <sup>2</sup> /g)	527
CEC (meq/100g)	93,9
Exchangeable cations (meq/100g)	Na <sup>+</sup> =55,9, Ca <sup>2+</sup> =30,1, Mg <sup>2+</sup> = 6,9, K <sup>+</sup> =1.1

As shown in Table 1, the percentages of replaceable cations in the intermediate layer of bentonite are sodium 55.9% and calcium 30.1%. This shows that the bentonite we have is sodium bentonite. The liquid limit and plastic limit are in accordance with the values found in the literature for sodium bentonite.

## 2.2. Bentonite with Increased Smectite Content

Even if it is obtained from the same quarry, the percentage of the components of bentonite material as a mineral may vary. In order not to be affected by these changes in bentonite during the experiment, a physical purification process was applied to bentonite. Gong et al., (2016) presented a simple technique comprising cracking, splitting and segregation to raise the montmorillonite ingredient of low-quality bentonite from Zhejiang, China [16]. Smectite content (mainly montmorillonite) was increased from 44% to 96.5 % in their experimental studies. The protocol for enhancing the smectite ingredient is as described below:

- 3 g minced bentonite was blended with 36 g deionised water to which 0.06 g sodium hexametaphosphate ( $\text{NaPO}_3$ )<sub>6</sub> was admixed.
- Stirred for a day. At the end of one day of mixing, it is followed by the removal of the remaining part at the top of the polypropylene tube.
- The top part of the admixture was separated by centrifugation in a constant condition for two minutes. Bentonite with elevated smectite ingredient was formed following centrifugation at 4500 r/min for two minutes.
- After removal of the tip from the polypropylene tube, the top of the solution was collected in a glass tube and transferred to an oven for drying.

The change in the composition of the clay after physical purification is presented in Table 2.

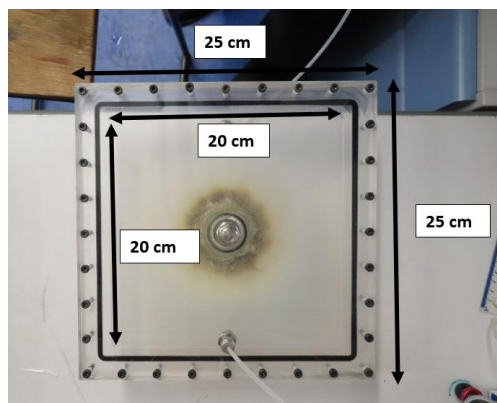
**Table 2.** The change in the composition of the bentonite after physical purification in terms of element.

Ingredients	Raw bentonite	Bentonite with increased smectite content
Quartz	3,9	0,5
Plagioclase	5,6	trace
K-feldspar	0,9	0
Pyrite	0,2	0
Gypsum	trace	0
Opal-C	2,6	2,7
Smectite (Di)	86,8	96,8
Kaolinite	0	trace

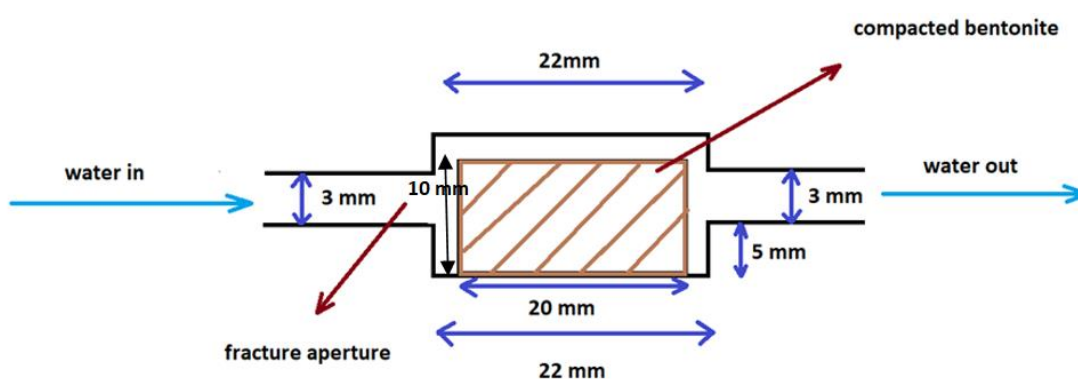
The new water content value obtained after the operations was found to be 8.11 per cent. Cylindrical pressed bentonite specimens with a height of 1 cm and a radius of 1 cm were produced.

## 2.3. Empirical Setup and 0.05 Molar Sodium Chloride Water

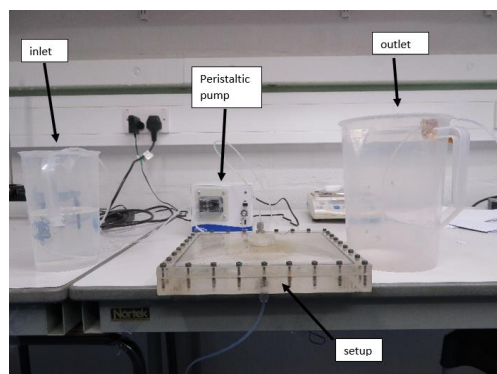
Perspex, a clear glassy and robust material, was utilized to mimic the possible ingress of liquid into the spent nuclear fuel store beneath the surface. Figure 1 displays the width and length of the test equipment with 3 mm aperture.



**Figure 1.** The width and length of the test equipment (top view)



**Figure 2.** Cross-section of experimental apparatus

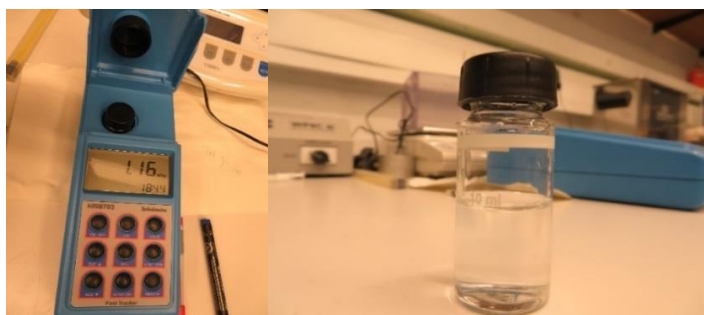


**Figure 3.** General view of experimental setup

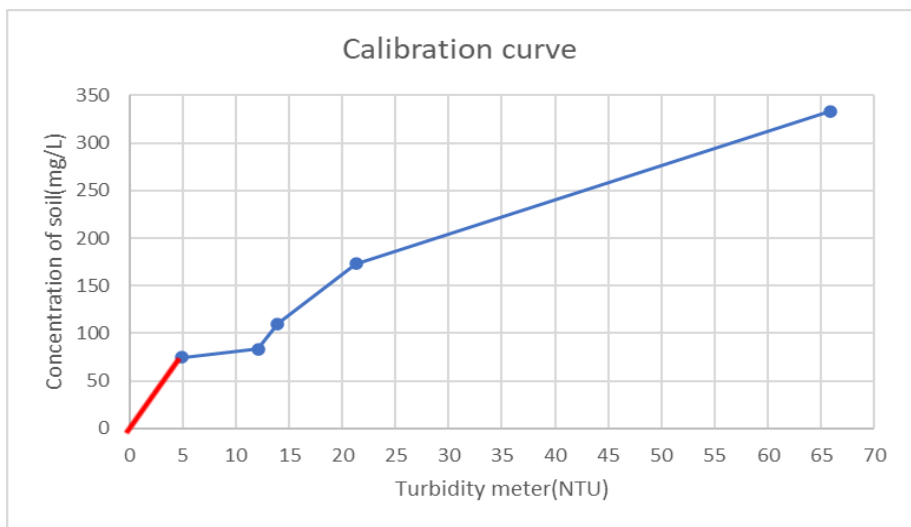
Figure 3 shows the peristaltic pump, inlet, outlet and perspex containing bentonite.

#### 2.4. Determination of the Weight of Eroded Compacted Bentonite

The Nephelometric Turbidity Unit (NTU) measures turbidity. A turbidimeter is used to measure the density of luminous dispersed at a perpendicular angle as the light travels across a sample of water. The HI98703 device is with a precision of per cent  $\pm 2$  data plus 0.02 NTU. Readings range from zero to one thousand NTU. Effluent water samples were collected on a day-to-day basis for twenty-four days and charted utilizing a turbidity meter. Following the collection of discharge water, the effluent was placed in glass tubes for turbidity meter measurements. In Figure 4, turbidity meter and glass tube were shown.

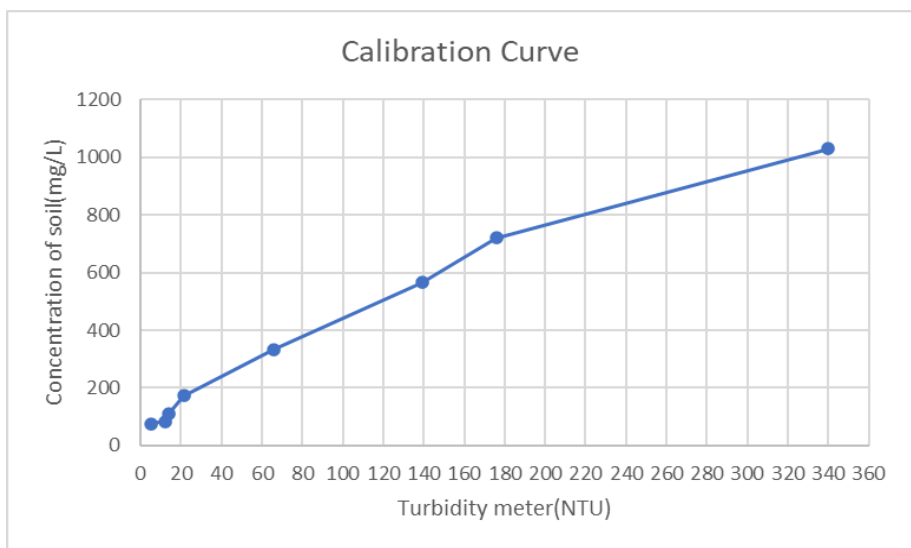


**Figure 4.** Turbidity meter and glass tube



**Figure 5.** The relationship between The NTU vales and particle concentration

The weight of eroded bentonite material is determined from the calibration curve in Figure 6 if the NTU readings are above these numbers.



**Figure 6:** The relationship between The NTU values and particle concentration

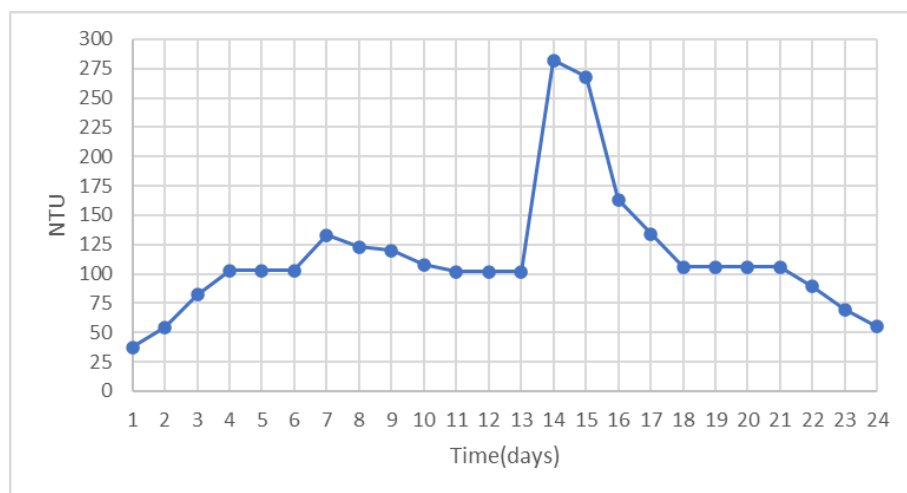
Although erosion was seen in some instances throughout the tests, because NTU values were under 5, the value of 5 in Figure 5 was combined with the value of 0 and considered linear. The red line in Figure 4 shows this situation. Since no visible erosion was observed in the experiments with ionic force, this was neglected. In this case, NTU readings were used to compare tests conducted within the same conditions but with different ionic strength. The Nephelometric Turbidity Unit readings quantified along the tests are utilized in the measurement curve and the accumulation of abraded particles respective to the measured NTU value is determined. Considering the daily measured effluent volumes, this value is converted to the effluent volume of that day and erosion is obtained.

### 3. RESULTS AND DISCUSSION

Both distilled water and water containing 0.05 M NaCl ionic strength were applied to the system under different flow rates and the results are shown separately. The results obtained were compared.

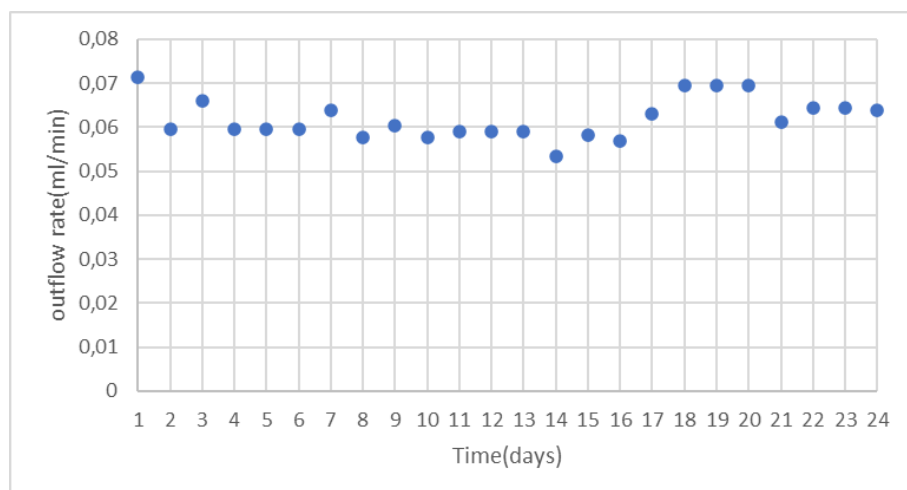
#### 3.1.5.75 Grams Compacted Bentonite with Dry Density 1.67 g/cm<sup>3</sup> Under 0.061 ml/min Flow Rate (Distilled Water)

Compressed bentonite with a dry density of 1.67% is exposed to distilled water with a flow rate of 0.061 ml/min for 24 days. During this time, daily NTU values and effluent volumes are recorded. Figure 7 shows the daily NTU values obtained. During the 24-day experiment, the NTU values ranged between 25 and 150 NTU values, except for the 14th, 15th, and 16th days. The average daily NTU value is 137.8.



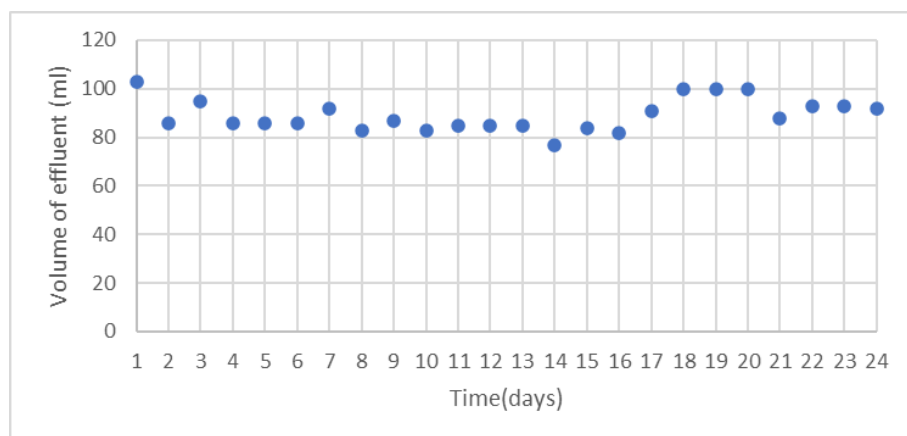
**Figure 7.** NTU values and time relationship per day

Figure 8 shows the daily outflow rate throughout the test. Average daily flow rate is 0.061 ml/min.



**Figure 8.** Outflow rate and time relationship per day

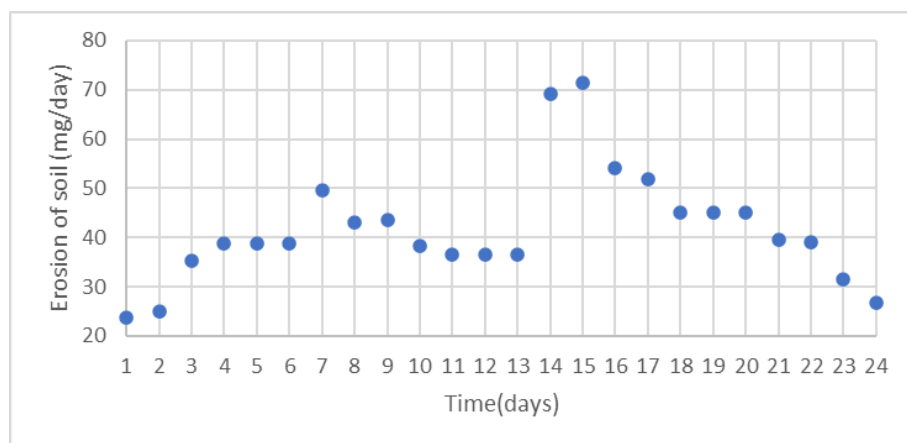
Figure 9 shows the daily volume of effluent throughout the test. The total eluted volume is 2142 ml. Average daily volume of effluent is 89.25 ml.



**Figure 9.** Volume of effluent and time relationship per day

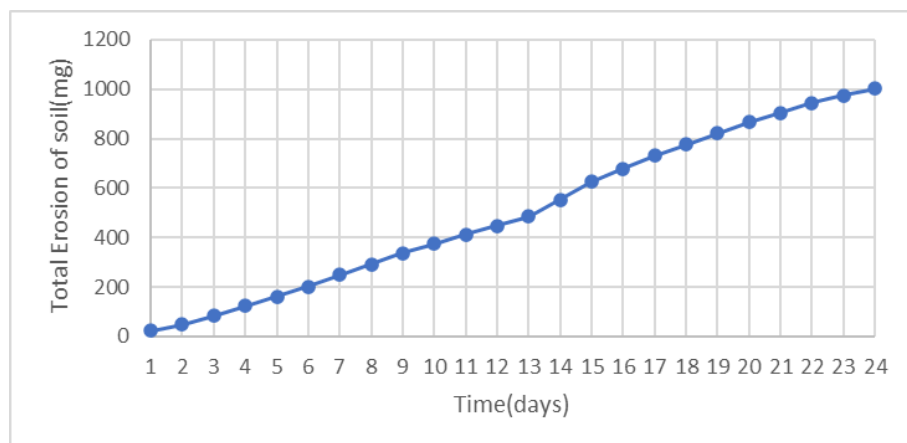
Figure 10 shows the daily erosion rate throughout the test. Average daily erosion is 41.77 mg. During the 24 days of the test, approximately 1 g of the original 5.27 g of dry mass of bentonite initially employed was eroded, i.e., 18.97% of the initial sample mass.





**Figure 10.** Erosion of soil and time relationship per day.

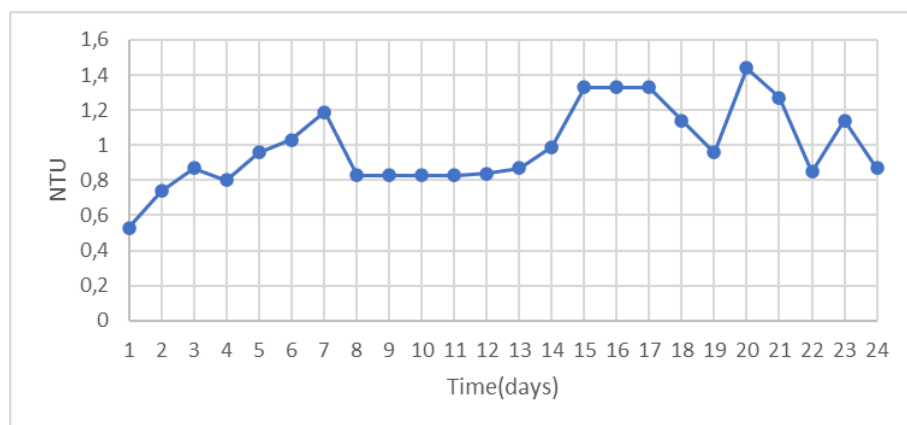
Figure 11 shows total erosion of soil throughout the test. During the 24 days of the test, 1002.61 mg bentonite was eroded.



**Figure 11.** Total erosion of soil over time

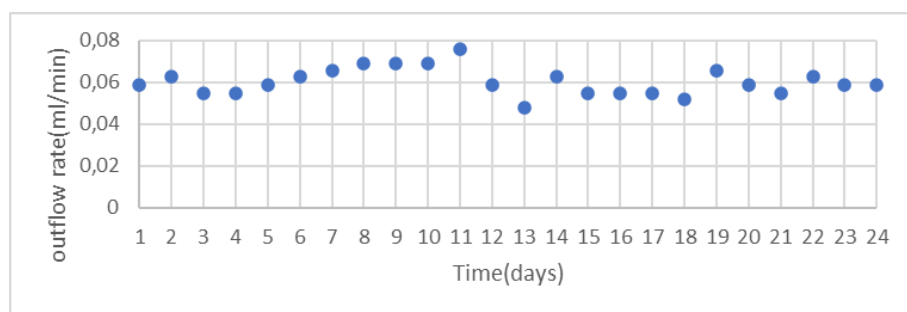
### 3.2. 5.906 Grams Compacted Bentonite with Dry Density 1.72 g/cm<sup>3</sup> Under 0.061 ml/min Flow Rate (0.05 M NaCl Water)

Compressed bentonite with a dry density of 1.72% is exposed to 0.05 M NaCl ionic strength water with a flow rate of 0.061 ml/min for 24 days. During this time, daily NTU values and effluent volumes are recorded. Figure 12 shows the daily NTU values obtained. NTU values ranged from 0.4 to 1.6 NTU during the 24-day experiment. The average daily NTU value is 0.99.



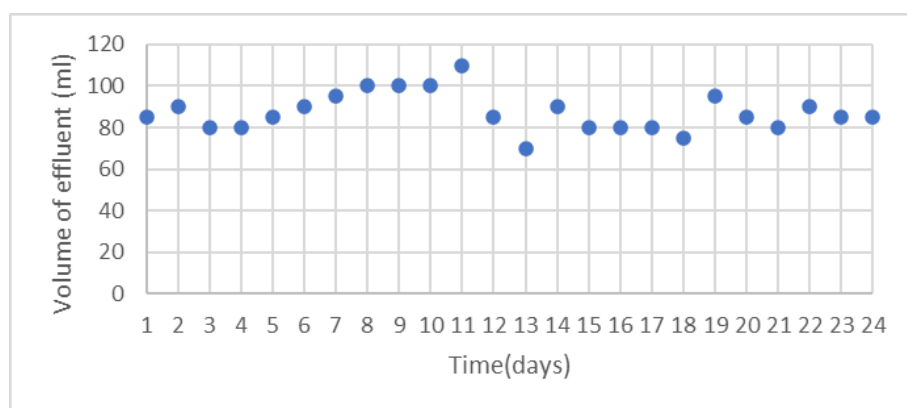
**Figure 12.** NTU values and time relationship per day

Figure 13 shows the daily outflow rate throughout the test. Average daily flow rate is 0.06 ml/min.



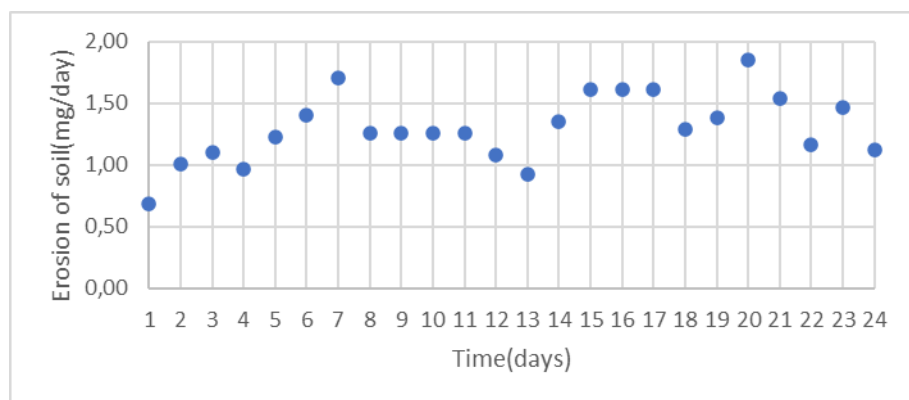
**Figure 13.** Outflow rate and time relationship per day

Figure 14 shows the daily volume of effluent throughout the test. The total eluted volume is 2095 ml. Average daily volume of effluent is 87.29 ml.



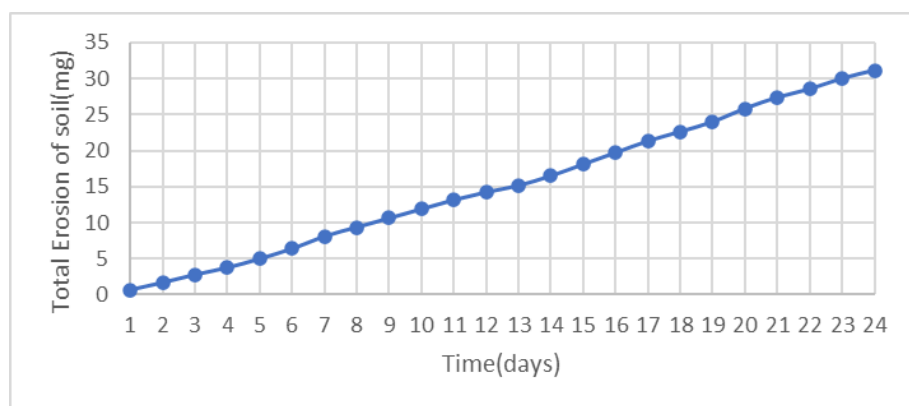
**Figure 14.** Volume of effluent and time relationship per day

Figure 15 shows the daily erosion rate throughout the test. Average daily erosion is 1.29 mg. During the 24 days of the test, approximately 30 mg of the original 5.42 g of dry mass of bentonite initially employed was eroded, i.e., 0.55% of the initial sample mass.



**Figure 15.** Erosion of soil and time relationship per day

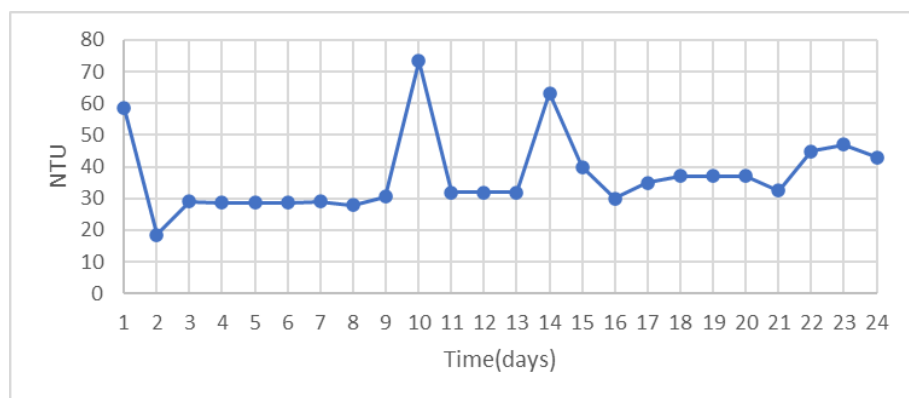
Figure 16 shows total erosion of soil throughout the test. During the 24 days of the test, 31.13 mg bentonite was eroded.



**Figure 16.** Total erosion of soil over time

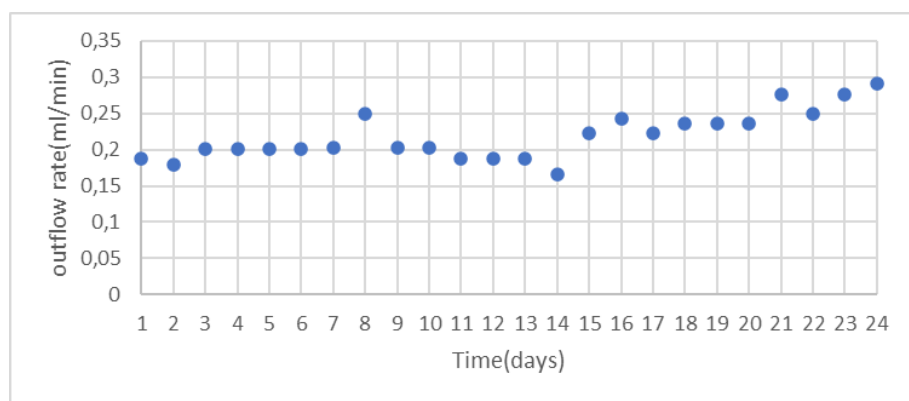
### 3.3. Figure 16. Total erosion of soil over time

Compressed bentonite with a dry density of 1.72% is exposed to distilled water with a flow rate of 0.22 ml/min for 24 days. During this time, daily NTU values and effluent volumes are recorded. Figure 17 shows the daily NTU values measured. NTU values changed abruptly during the 24-day experiment. The average daily NTU value is 37.3.



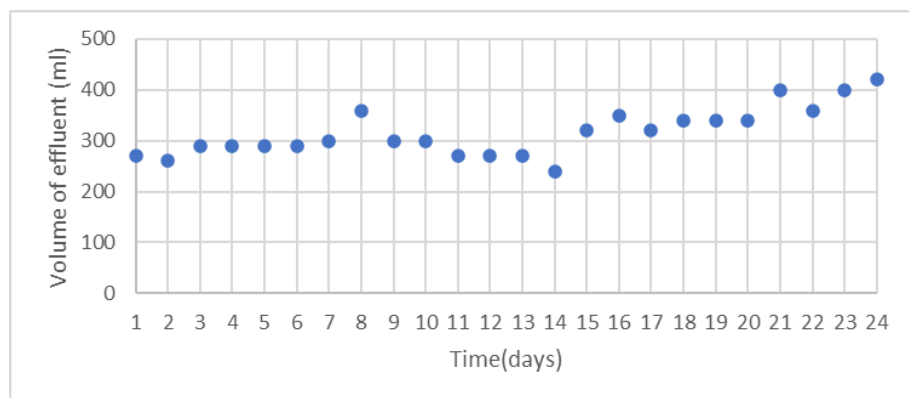
**Figure 17.** NTU values and time relationship per day

Figure 18 shows the daily outflow rate throughout the test. Average daily flow rate is 0.22ml/min.



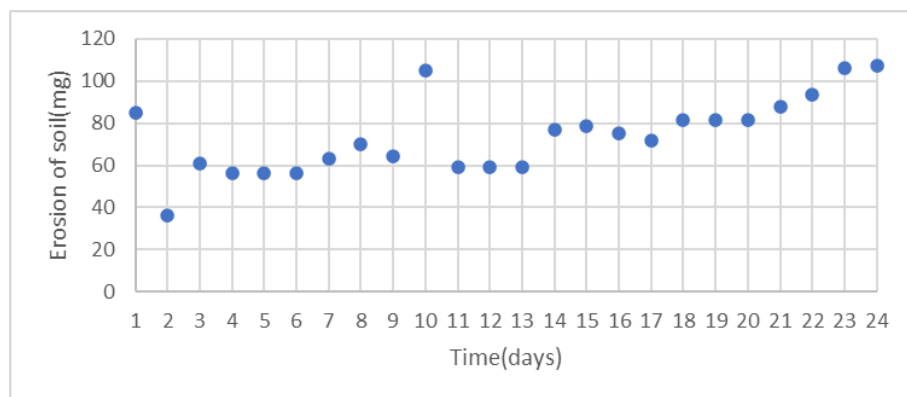
**Figure 18.** Outflow rate and time relationship per day

Figure 19 shows the daily volume of effluent throughout the test. The total eluted volume is 7590 ml. Average daily volume of effluent is 316.25 ml.



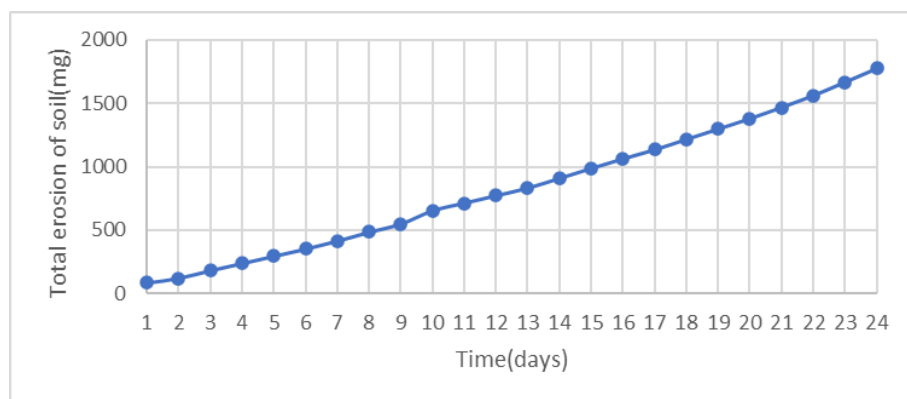
**Figure 19.** Volume of effluent and time relationship per day

Figure 20 shows the daily erosion rate throughout the test. Average daily erosion is 73.95 mg. During the 24 days of the test, approximately 1.774 g of the original 5.41 g of dry mass of bentonite initially emplaced was eroded, i.e., 32.79% of the initial sample mass.



**Figure 20.** Erosion of soil and time relationship per day

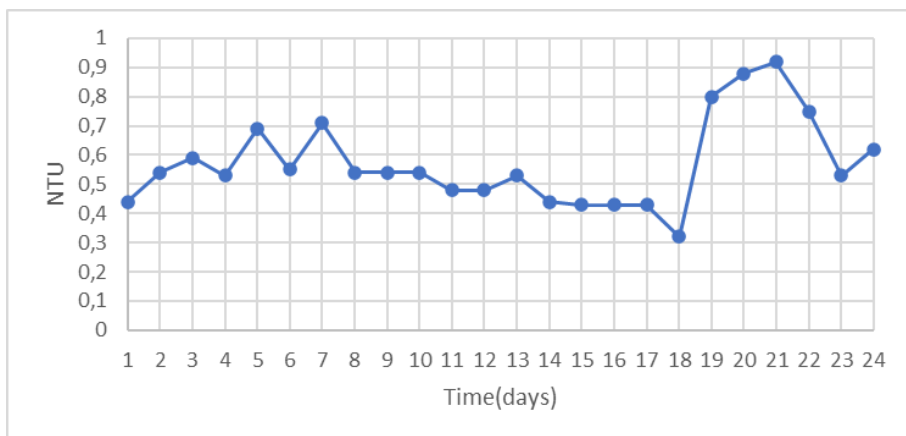
Figure 21 shows total erosion of soil throughout the test. During the 24 days of the test, 1774.85 mg bentonite was eroded.



**Figure 21.** Total erosion of soil over time

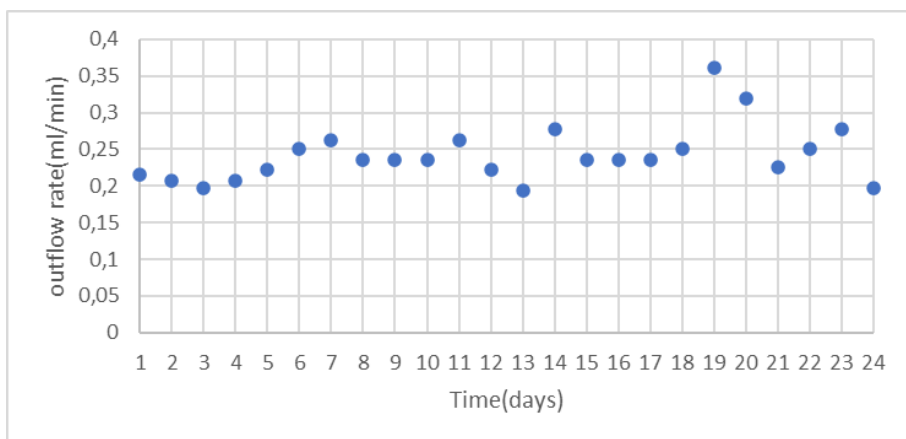
### 3.4. 5.899 Grams Compacted Bentonite with Dry Density 1.72 g/cm<sup>3</sup> Under 0.242 ml/min Flow Rate (0.05 M NaCl Water)

Compressed bentonite with a dry density of 1.72% is exposed to 0.05 M NaCl ionic strength water with a flow rate of 0.242 ml/min for 24 days. During this time, daily NTU values and effluent volumes are measured. Figure 22 shows the daily NTU values recorded. NTU values ranged from 0.3 to 1 NTU during the 24-day experiment. The average daily NTU value is 0.57.



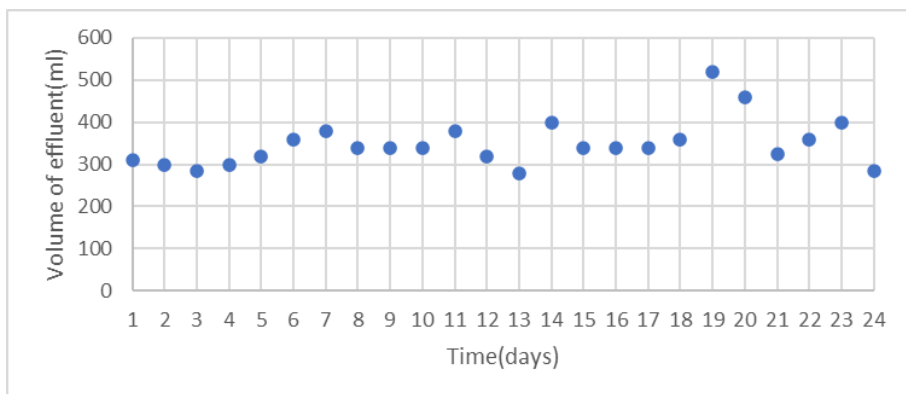
**Figure 22.** NTU values and time relationship per day

Figure 23 shows the daily outflow rate throughout the test. Average daily flow rate is 0.242 ml/min.



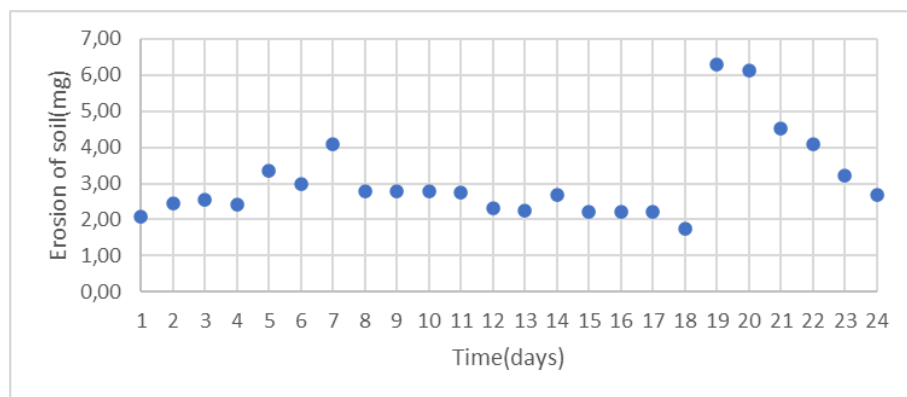
**Figure 23.** Outflow rate and time relationship per day

Figure 24 shows the daily volume of effluent throughout the test. The total eluted volume is 8385 ml. Average daily volume of effluent is 349.375 ml.



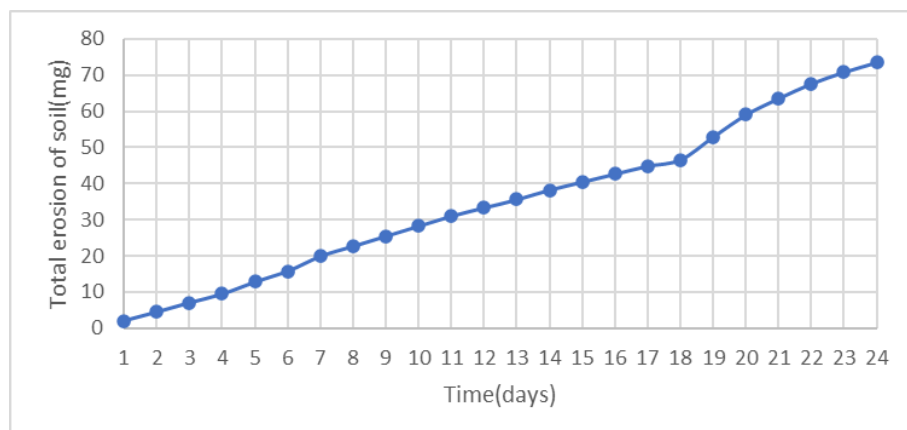
**Figure 24.** Volume of effluent and time relationship per day

Figure 25 shows the daily erosion rate throughout the test. Average daily erosion is 73.60 mg. During the 24 days of the test, approximately 0.07 g of the original 5.41 g of dry mass of bentonite initially emplaced was eroded, i.e., 1.36% of the initial sample mass.



**Figure 25.** Erosion of soil and time relationship per day

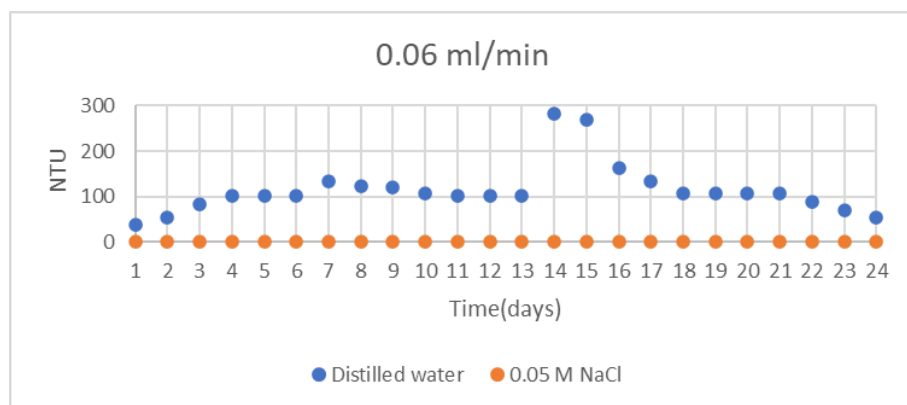
Figure 26 shows total erosion of soil throughout the test. During the 24 days of the test, 73.6 mg bentonite was eroded.



**Figure 26.** Total erosion of soil over time

Under flow rates of 0.06 ml/min and approximately 0.22 ml/min, both distilled water and 0.05 molarity sodium chloride saline water were applied to the system containing compacted bentonite and the erosion occurring in these conditions was measured by means of a turbidity meter. Daily NTU values, daily erosion values, daily effluent volumes and daily flow rates were recorded throughout the experiment.

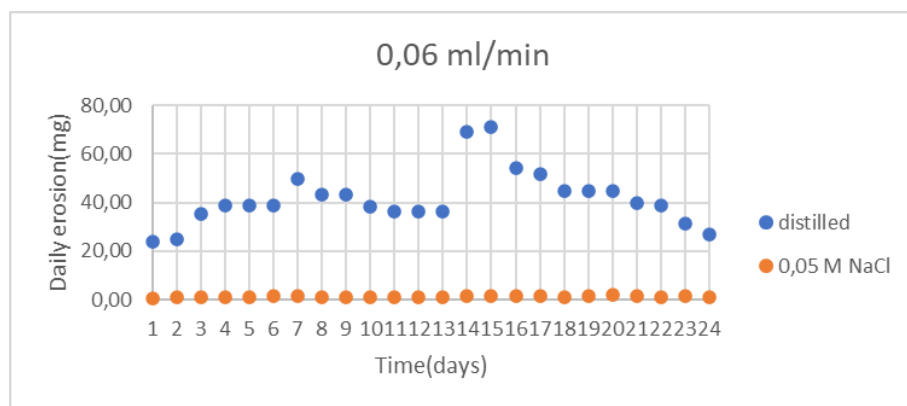
Figure 27 shows the change in the NTU values of two compacted bentonites exposed to the same flow rate but tested with waters of different ionic strengths during the 24-day experiment.



**Figure 27.** The effect of ionic strength under 0.06 ml/min flow rate (turbidity meter)

In Figure 27, NTU values obtained when water containing 0.05 Molar NaCl acts on the system are between 0 and 2. However, in the system where distilled water acts, NTU values vary between 37 and 287. This shows the effect of increasing the ionic strength by a relatively small amount on NTU values.

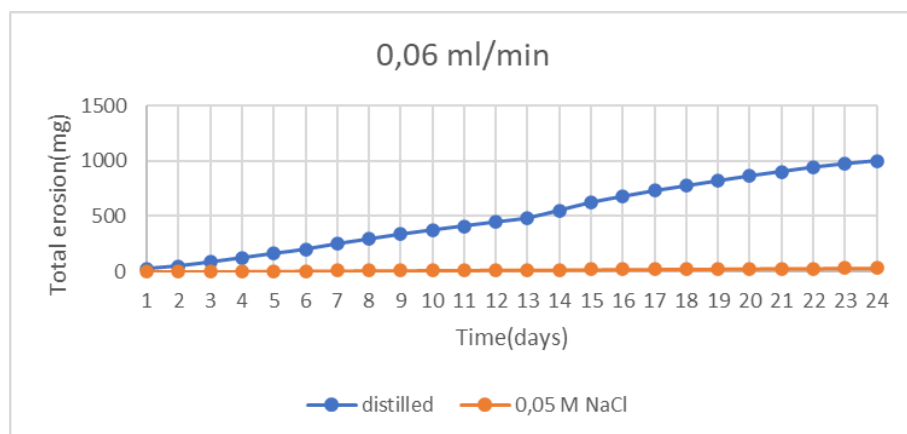
Figure 28 shows the daily erosion amounts of distilled water and water containing 0.05 M NaCl under a flow rate of 0.06 ml/min. In the system where distilled water is applied, daily erosion values vary between 23 mg and 71 mg. On the other hand, daily erosion values vary between 0 and 2 mg in the system where 0.05 M NaCl salt-containing water is applied.



**Figure 28.** Daily erosion value

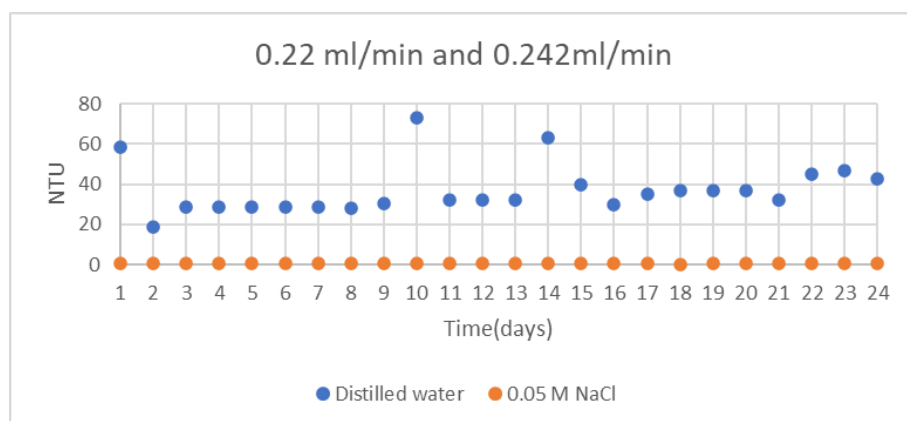
Figure 29 shows the total erosion values at the end of each day. At the end of the 24th day, the total erosion value in the system where distilled water was applied was 1002,7 mg, while the total erosion value in the system where water containing 0,05 M NaCl salt was applied was 31.13 mg. The erosion value obtained by mixing 0,05 M NaCl salt with water decreased to 1 in 30. The effect of salt on erosion is too great to be neglected.





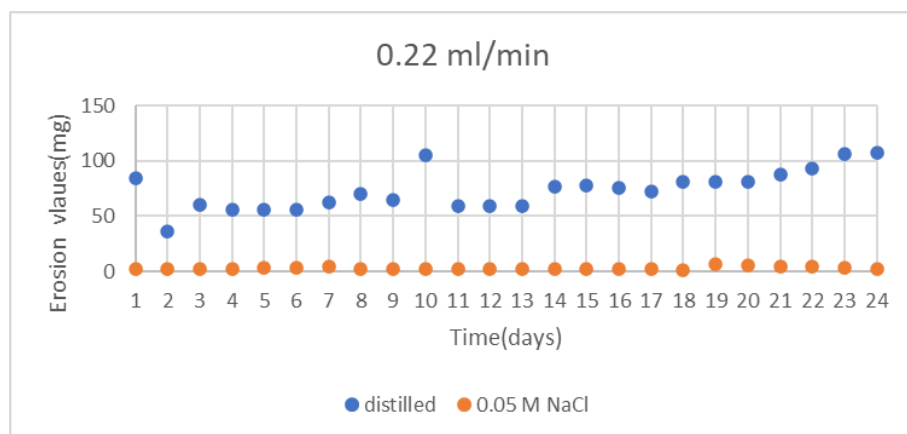
**Figure 29.** Total erosion values during the experiment

In Figure 30, both distilled water and 0.05 M NaCl ionic strength water were applied to the system under a flow rate of 0.22 ml/min. NTU values obtained when distilled water was used under a flow rate of 0.22 ml/min ranged between 18.5 and 73.3, while they ranged between 0 and 1 when 0.05 M NaCl was used. This showed the effect of ionic strength on NTU values and thus its effect on erosion.

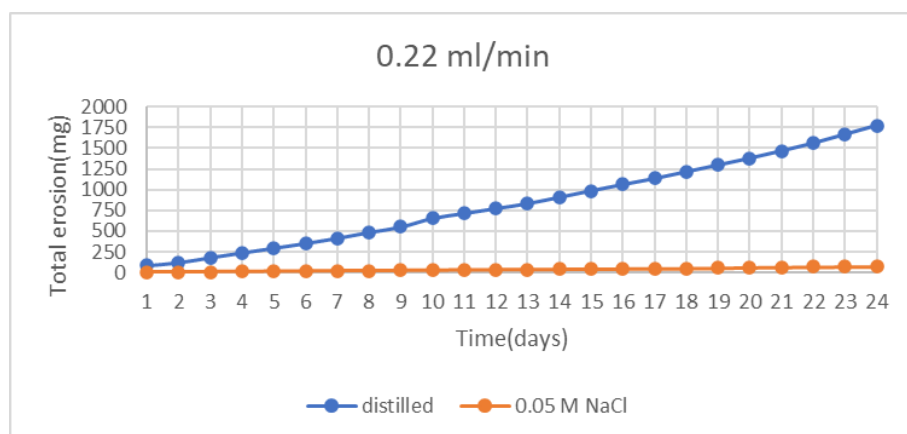


**Figure 30.** The effect of ionic strength under 0.22 ml/min and 0.242 ml/min flow rate (turbidity meter)

Figure 31 shows the daily erosion amounts of distilled water and water containing 0.05 M NaCl under a flow rate of 0.06 ml/min. In the system where distilled water is applied, daily erosion values vary between 36 mg and 107 mg. On the other hand, daily erosion values vary between 2 and 6 mg in the system where 0.05 M NaCl salt-containing water is applied.



**Figure 31.** Daily erosion values



**Figure 32.** Total erosion values during the experiment

In the studies conducted in the literature on this subject, numerical comparison will not give healthy results because of the ratio of montmorillonite contained in the bentonite material used, the type and ratio of exchangeable cations in the intermediate of bentonite, the dry densities of the compacted bentonite, the weights of the compacted bentonite, the different experimental setup prepared, the different flow rate values applied and the different aperture value in the experimental setup.

Baik et al. (2007) has investigated the effect of ionic strength of water on the erosion of compacted bentonite [14]. In their findings, erosion of compacted bentonite with ionic strength is depending on contacting time. In the short run, eroded bentonite fines decrease as the ionic strength of water increases. On the other hand, in the long run, the amount of bentonite particles eroded increases with increasing ionic strength. This is something we have not observed in our own experiments.

Baik and Lee (2010) have examined colloidal stability of bentonite clay as a function of pH and ionic strength [17]. According to them, pH does not have any significant effect, whereas ionic strength does. Bentonite colloids (Ca-bentonite) are more stable at lower ionic strength. This finding coincides with our experimental results.

Missana et al. (2003) conducted experiments to investigate the stability of bentonite colloids under both flow and still water (no flow) conditions [13]. According to their observations, bentonite colloids are more stable in low salinity water. This finding coincides with our experimental results.

#### 4. CONCLUSION

Experiments were conducted to investigate the influence of the salt content of the aqua on the erosion of compacted bentonite during the estimated water inflow to nuclear waste facilities. An easy, relatively cheap, and portable turbidity meter was used to measure the amount of bentonite particles eroded. The applied flow rates were 0.06 ml/min and 0.22 ml/min, and the applied waters were distilled water and 0.05 M NaCl ionic strength water. The range of NTU values obtained when using distilled water under 0.06 ml/min flow rate is 37 to 287, while the range of NTU values obtained when using water containing 0.05 M NaCl is 0 to 2. When distilled water was used, the daily erosion values obtained under 0.06 ml/min flow rate ranged between 23 mg and 71 mg, while the daily erosion values obtained when water containing 0.05 M NaCl salt ranged between 0 and 2 mg. When distilled water was used, the total erosion value obtained at the end of 24th day under 0.06 ml/min flow rate was 1002.7 mg, while the total erosion value obtained at the end of 24th day when water containing 0.05 M NaCl salt was used was 31.13 mg. With the application of 0.05 M NaCl salt-containing water to the system, the erosion value obtained under a flow rate of 0.06 ml/min decreased by 1 in 30 compared to the system using distilled water. Under 0.22 ml/min flow rate, the range of NTU values obtained when using distilled water is 18.5 to 73.3, while the range of NTU values obtained when using water containing 0.05 M NaCl is 0 to 1. When distilled water was used, the daily erosion values obtained under 0.22 ml/min flow rate ranged between 36 mg and 107 mg, while the daily erosion values obtained when water containing 0.05 M NaCl salt ranged between 2 and 6 mg. When distilled water was used, the total erosion value obtained at the end of 24th day under 0.22 ml/min flow rate was 1774.85 mg, while the total erosion value obtained at the end of 24th day when water containing 0.05 M NaCl salt was used was 73.6 mg. With the application of 0.05 M NaCl salt-containing water to the system, the erosion value obtained under a flow rate of 0.22 ml/min decreased by 1 in 24 compared to the system using distilled water. Under both 0.06 ml/min and 0.22 ml/min flow rates, when the salt content of the water was increased from 0 to 0.05 M NaCl, the daily NTU values, daily erosion values and total erosion values obtained at the end of the experiment decreased drastically. With increasing the flow rate, the effect of the salt content of the water on erosion decreased relatively compared to the experiments with distilled water. Under 0.06 ml/min flow rate, the amount of erosion obtained at the end of the experiment decreased to 1 in 30 with the introduction of 0.05 M NaCl into the system, while under 0.22 ml/min flow rate, the amount of erosion obtained at the end of the experiment decreased to 1 in 24 with the introduction of 0.05 M NaCl into the system. This can be explained by the increase in the shear force acting on the compacted bentonite with increasing flow rate.

#### *Acknowledgements*

*I would like to thank Dr Majid Sedighi for his help throughout this study.*

#### *Funding*

*The author did not receive any financial support for the research, authorship, or publication of this study.*

### ***The Declaration of Conflict of Interest/ Common Interest***

*No conflict of interest or common interest has been declared by the authors.*

### ***Author's Contribution***

*The first author contributed 90%, the second author 10%.*

### ***The Declaration of Ethics Committee Approval***

*This study does not require ethics committee permission or any special permission.*

### ***The Declaration of Research and Publication Ethics***

*The author of the paper declares that he complies with the scientific, ethical, and quotation rules of Environmental Toxicology and Ecology in all processes of the paper and that he does not make any falsification of the data collected. In addition, he declares that ETOXEC and its editorial board have no responsibility for any ethical violations that may be encountered and that this study has not been evaluated in any academic publication environment other than ETOXEC.*

## **REFERENCES**

- [1] Cho, W. J., Lee, J. O., Chun, K. S., & Park, H. S. Analysis of functional criteria for buffer material in a high-level radioactive waste repository. *Nuclear Engineering and Technology*, vol. 31, no.1, pp. 116-132, 1999.
- [2] J. Andersson, A. Ström, C. Svemar, K.-E. Almén, L.O. Ericsson, SKB Technical Report, TR-00-12, 2000.
- [3] S. García-García, M. Jonsson, and S. Wold, "Temperature effect on the stability of bentonite colloids in water," *Journal of Colloid and Interface Science*, vol. 298, no. 2, pp. 694–705, Jun. 2006, doi: <https://doi.org/10.1016/j.jcis.2006.01.018>.
- [4] S. García-García, S. Wold and M. Jonsson, "Effects of temperature on the stability of colloidal montmorillonite particles at different pH and ionic strength," *Applied Clay Science*, vol. 43, no. 1, pp. 21–26, Jan. 2009, doi: <https://doi.org/10.1016/j.clay.2008.07.011>.
- [5] C. Reid, R. J. Lunn, Gráinne El Mountassir, and A. Tarantino, "A mechanism for bentonite buffer erosion in a fracture with a naturally varying aperture," *Mineralogical Magazine*, vol. 79, no. 6, pp. 1485–1494, Nov. 2015, doi: <https://doi.org/10.1180/minmag.2015.079.6.23>.
- [6] Kersting, A. B., Efurud, D. W., Finnegan, D. L., Rokop, D. J., Smith, D. K., & Thompson, J. L.. Migration of plutonium in ground water at the Nevada Test Site. *Nature*, vol. 397, pp.56-59, Jan. 1999.
- [7] G. S. Boulton, P. E. Caban, and K. Van Gijssel, "Groundwater flow beneath ice sheets: Part I — Large scale patterns," *Quaternary Science Reviews*, vol. 14, no. 6, pp. 545–562, Jan. 1995, doi: [https://doi.org/10.1016/0277-3791\(95\)00039-r](https://doi.org/10.1016/0277-3791(95)00039-r).
- [8] Puigdomenech, SKB Technical Report, TR-01-28, 2001.

- [9] M. Benna, N. Kbir-Ariguib, A. Magnin, and F. Bergaya, “Effect of pH on Rheological Properties of Purified Sodium Bentonite Suspensions,” *Journal of Colloid and Interface Science*, vol. 218, no. 2, pp. 442–455, Oct. 1999, doi: <https://doi.org/10.1006/jcis.1999.6420>.
- [10] P. F. Luckham and S. Rossi, “The colloidal and rheological properties of bentonite suspensions,” *Advances in Colloid and Interface Science*, vol. 82, no. 1–3, pp. 43–92, Oct. 1999, doi: [https://doi.org/10.1016/s0001-8686\(99\)00005-6](https://doi.org/10.1016/s0001-8686(99)00005-6).
- [11] D. Penner and G. Lagaly, “Influence of anions on the rheological properties of clay mineral dispersions,” *Applied Clay Science*, vol. 19, no. 1–6, pp. 131–142, Jul. 2001, doi: [https://doi.org/10.1016/s0169-1317\(01\)00052-7](https://doi.org/10.1016/s0169-1317(01)00052-7).
- [12] V. R. Ouhadi, R. N. Yong, and M. Sedighi, “Influence of heavy metal contaminants at variable pH regimes on rheological behaviour of bentonite,” *Applied Clay Science*, vol. 32, no. 3–4, pp. 217–231, May 2006, doi: <https://doi.org/10.1016/j.clay.2006.02.003>.
- [13] Tiziana Missana, U. Alonso, and María Jesús Turrero, “Generation and stability of bentonite colloids at the bentonite/granite interface of a deep geological radioactive waste repository,” vol. 61, no. 1–4, pp. 17–31, Mar. 2003, doi: [https://doi.org/10.1016/s0169-7722\(02\)00110-9](https://doi.org/10.1016/s0169-7722(02)00110-9).
- [14] Min Hoon Baik, W.-J. Cho, and P.-S. Hahn, “Erosion of bentonite particles at the interface of a compacted bentonite and a fractured granite,” *Engineering Geology*, vol. 91, no. 2–4, pp. 229–239, May 2007, doi: <https://doi.org/10.1016/j.enggeo.2007.02.002>.
- [15] L. Moreno, L. Liu, and Ivars Neretnieks, “Erosion of sodium bentonite by flow and colloid diffusion,” *Physics and Chemistry of the Earth, Parts A/B/C*, vol. 36, no. 17–18, pp. 1600–1606, Jan. 2011, doi: <https://doi.org/10.1016/j.pce.2011.07.034>.
- [16] Z. Gong, L. Liao, G. Lv, and X. Wang, “A simple method for physical purification of bentonite,” *Applied Clay Science*, vol. 119, pp. 294–300, Jan. 2016, doi: <https://doi.org/10.1016/j.clay.2015.10.031>.
- [17] M. H. Baik and S. Y. Lee, “Colloidal stability of bentonite clay considering surface charge properties as a function of pH and ionic strength,” *Journal of Industrial and Engineering Chemistry*, vol. 16, no. 5, pp. 837–841, Sep. 2010, doi: <https://doi.org/10.1016/j.jiec.2010.05.002>.