

# SOC Estimation of Li-Po Battery Using Machine Learning and Deep Learning Methods

Nazire Nur Karaburun<sup>1</sup>, Seda Arik Hatipoğlu<sup>2\*</sup>, Mehmet Konar<sup>3</sup>

<sup>1</sup>Erciyes University, Graduate School of Natural and Applied Science, Aviation Electrical and Electronics (MSC) Program, 38039, Kayseri, Türkiye. (nazirenurkb@gmail.com).

<sup>2\*</sup>Erciyes University, Faculty of Aeronautics and Astronautics, Aeronautical Electrical and Electronics, 38039, Kayseri, Türkiye. (arikседа@erciyes.edu.tr).

<sup>3</sup>Erciyes University, Faculty of Aeronautics and Astronautics, Aeronautical Electrical and Electronics, 38039, Kayseri, Türkiye. (mkonar@erciyes.edu.tr).

## Article Info

Received: 29 January 2024  
Revised: 09 February 2024  
Accepted: 21 February 2024  
Published Online: 23 February 2024

### Keywords:

Aviation  
UAV  
SOC  
Machine learning  
LSTM

Corresponding Author: *Seda Arik Hatipoğlu*

## RESEARCH ARTICLE

<https://doi.org/10.30518/jav.1425676>

## Abstract

The aviation industry is one of the most important areas where developing technology contributes. It is important to evaluate many factors for the safe and comfortable flight of unmanned aerial vehicles (UAVs), one of the most popular areas of this industry. One of the most important of these factors is flight time estimation. Battery state of charge (SOC) plays a big role in flight time estimation. In this study, using the data obtained from the tests carried out using a lithium-polymer battery in the electric UAV engine test equipment, the SOC of the battery was estimated using deep learning like as Long-Short Term Memory (LSTM) and machine learning methods like as Support Vector Regression (SVR) and Random Forest (RF). The main reason why these methods are preferred is that they are suitable for time series analysis in the forecasting process, are trained faster, and have generalization abilities. The proposed models were compared among themselves and the simulation results were presented with graphs and tables.

When the results are examined, the predicted values and true values are quite compatible. This shows that the proposed methods can be used effectively in SOC estimation.

## 1. Introduction

Technological developments contribute to all areas of life. The aviation industry is one of these areas. The aviation industry has a wide range of applications, from transportation to defense industry (Gupta et al., 2015). One of the most important developing areas in the aviation industry is unmanned aerial vehicles (UAVs). UAVs are produced in different sizes and types due to different user requirements (Daniel et al., 2011; Sahin et al., 2020). A lot of research is done on improving UAV performance during design (Arik et al., 2018; Bilgin et al., 2022; Coban et al., 2023). Increasing flight safety is one of the main research topics. Many factors such as flight parameters, endurance, payload amount, mission duration, and environmental conditions need to be evaluated in order to ensure a safe flight. The power energy density of the UAV plays an important role in estimating the flight time, which is one of these factors.

Generally, lithium-ion (Li-ion) or lithium-polymer (Li-Po) batteries are used for power energy density in electric UAVs (Hannan et al., 2017). Many factors such as current rating and capacity are taken into account in battery selection. Another of these factors is the battery's state of charge (SOC). The SOC value is defined as the ratio of the current capacity to the usable

capacity of the battery and is expressed as a percentage (Xiong et al., 2013).

Although many methods are used in SOC estimation, with the increasing trend towards artificial intelligence methods in recent years, studies on SOC estimation using artificial intelligence methods have increased (Cai et al., 2003; Chaoui et al., 2017; Konar, 2019; Yang et al., 2019b; Song et al., 2019; Ersen et al., 2023). Cai et al. used an Adaptive Neuro-Fuzzy Inference System (ANFIS) and a Back-Propagation (BP) Artificial Neural Network (ANN) for battery SOC estimation in their study (Cai et al., 2003). When they compared ANFIS with BP-ANN model, they emphasized that ANFIS is better at predicting complex nonlinear system behavior. Chaoui et al. proposed a method based on Recurrent Neural Networks (RNN) to predict the SOC value of lithium-ion batteries (Chaoui et al., 2017). They stated that RNN makes better battery SOC prediction compared to traditional feedforward ANNs by using historical information. Konar proposed a model based on Backtracking Search Optimization (BSO) Algorithm based ANN for maximization of brushless engine performance and flight time in his study (Konar, 2019). By presenting the simulation results of the BSO algorithm-based ANN model, he emphasized that the proposed method will provide convenience for UAV designers. Yang et al. proposed the RNN method to predict lithium-ion battery SOC from

measured current, voltage and temperature signals (Yang et al., 2019b). They stated that their proposed method provides better prediction accuracy compared to traditional feedforward neural networks. Song et al. used the combined Convolutional Neural Network (CNN)-Long-Short Term Memory (LSTM) network structure, which shares the advantages of both CNN and LSTM networks, to predict battery SOC from lithium-ion battery data (Song et al., 2019). They highlighted that the experimental results show that the proposed CNN-LSTM network performs well in identifying non-linear relationships between SOC and measurable variables. Sidhu et al. presented a hybrid SOC prediction method using random forest (RF) regression and Gaussian filter together for SOC prediction of Li-ion batteries in electric vehicles (Sidhu et al., 2019). They emphasized that the results obtained gave better results than traditional methods such as Support Vector Regression (SVR) and Neural Network (NN). Ma et al. proposed a model based on LSTM neural network for simultaneous prediction of SOC and state of energy in their study (Ma et al., 2021). They compared the performance of the proposed method with SVR, RF and RNN methods. Youssef et al. presented a comparative analysis between machine learning algorithms including Multiple Linear Regression (MLR), Multilayer Perceptron (MLP), SVR and RF models in their study for SOC prediction of Li-ion batteries (Youssef et al., 2022). According to the results obtained, they stated that the RF model stands out for SOC prediction.

Considering the studies in the literature, it seems that monitoring the battery status is an important issue for UAVs to perform a safe mission. In this study, battery voltage monitoring, that is, SOC estimation of the battery, was discussed using the data obtained from the tests performed on the electric UAV engine test equipment. For this purpose, the GT2215/09 model brushless motor was tested on the test device of RCbenchmark company using a 50 Amper (A) Electronic Speed Control (ESC) unit, 10x5 propeller and a Li-Po battery with 5000 mAh, 25 C and 11,1 volts. Using the data obtained in the test stage, the voltage change of the battery was taken into account and thus models based on deep learning and machine learning methods were proposed for SOC estimation of the battery. When the proposed models are compared, it is seen that the LSTM method is better than others. The results of the simulations by using proposed models are presented with graphs and tables.

## 2. Methods

In this study, Support Vector Regression (SVR) and Random Forest (RF) methods from machine learning methods and Long-Short Term Memory (LSTM) method from deep learning methods were selected for SOC estimation of Li-Po battery. Time series models, especially models such as SVR, RF and LSTM can be used to solve the time-varying SOC estimation problem. SVR is powerful at modeling non-linear relationships and complex data structures. RF stands out for its ability to deal with noisy data sets and its ability to model interactions. LSTM, on the other hand, stands out with its ability to model long-term connections in time series. Using these models in SOC estimation can contribute to obtaining more reliable and accurate results. In this section, the methods preferred in this study are briefly explained.

### 2.1. Machine Learning

Machine learning is the technology of developing computer algorithms that can imitate human intelligence and learn on their own (Mitchell, 1997). There are 3 types of machine learning algorithms based on the type of learning. These are supervised, unsupervised and reinforcement learning. In supervised learning, the dependent variable is classified or predicted based on the label information of the independent variable data set, (Kotsiantis et al., 2007). In unsupervised learning, it is preferred for understanding and discovering the relationships between unlabeled data (Oztemel, 2003). In reinforcement learning, it is based on learning through trial and error (Sutton, 1992).

Machine learning algorithms are designed to classify events, find samples, predict results, and make conscious decisions. Algorithms can be used one at a time or in combination to achieve the best possible accuracy when dealing with complex and more unpredictable data.

In this study, SVR and RF methods, which are machine learning algorithms, were preferred due to their features explained below.

SVR is a machine learning method used to solve regression problems. SVR makes predictions by grouping data points on a hyperplane, a plane shaped by input properties. SVR can perform especially well on low-dimensional datasets. It is also possible to model relationships that are more complex by projecting data into high-dimensional spaces using kernel functions. In addition, the advantages of SVR can be explained as follows: it has high generalization ability, can be better adapted to new data, is resistant to overfitting, and can be applied to different data structures. The disadvantages of SVR can be explained as follows: the computational cost may be high in large data sets, model training may take time, and the selection of some SVR parameters may require expertise (Cortes et al., 1995; Burges, 1998; Vapnik, 1998).

RF is a machine learning algorithm based on decision trees that is used in both classification and regression problems. RF is developed to prevent the overfitting problem of decision trees (Breiman, 2001; Cutler et al., 2012). The RF method attracts attention due to its features such as being faster to train than other methods, having a higher prediction speed, having fewer control parameters, and being directly applicable to multidimensional problems (Hastie et al., 2017).

### 2.2. Deep Learning

Deep learning has the ability to work effectively on large data sets and complex data structures. Therefore, it can be said that it performs better than machine learning in various application areas. (LeCun et al. 2015). Deep learning uses multiple hidden layers for feature extraction and transformation. This means that deep learning is suitable for analyzing and extracting useful information from both large amounts of data and data collected from different sources (Zhang et al., 2018). There are many deep learning architectures such as Deep Boltzmann Machines (DBM), CNN and RNN. In this study, the LSTM method, one of the RNN algorithms, was preferred due to their features explained below.

RNNs are a class of neural networks for sequential data in which recurrent units are used to store historical information to be passed from the previous step to the next step (Elman et al., 1990). LSTM is one of the RNN algorithms developed to process and store time series sequential data. Although the main purpose of RNN algorithms is to learn long-term

dependencies, theoretical studies shows that they are not successful in storing information for a long time (Bengio et al., 1994). Therefore, the LSTM network is developed on the basis of RNN, which normally uses memory units instead of hidden nodes to avoid the gradient problem (Hochreiter et al., 1997). So, the advantages of the LSTM method can be summarized as follows: it is very suitable for classifying, processing and making predictions based on time series data, it has the ability to remember past information and forget it when necessary, it can make future predictions using past information, it can achieve better results with less training data.

LSTM architecture is given in Fig.1. Look-back is used to define the number of previous data so that LSTM can learn. The greater the look-back value, the more information LSTM can obtain (Hermawan et al., 2020). ☉☉☉

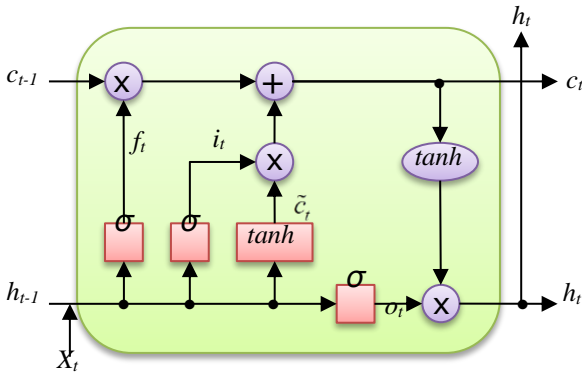

Figure 1. LSTM Block Diagram

The LSTM structure can be expressed mathematically with the set of equations in Equation 1 (Zha et al., 2022).

$$\begin{aligned}
 i_t &= \sigma_g (W_i x_t + U_i h_{t-1} + b_i) \\
 f_t &= \sigma_g (W_f x_t + U_f h_{t-1} + b_f) \\
 o_t &= \sigma_g (W_o x_t + U_o h_{t-1} + b_o) \\
 \tilde{c}_t &= \sigma_c (W_c x_t + U_c h_{t-1} + b_c) \\
 c_t &= f_t \odot c_{t-1} + i_t \odot \tilde{c}_t \\
 h_t &= o_t \odot \sigma_h (c_t)
 \end{aligned} \tag{1}$$

Here,  $x_t$  represents the input of LSTM,  $h_t$  represents the output of LSTM, and  $c_t$  represents the cell state vector.  $i_t, f_t$  and  $o_t$  are the input gate, forget gate and output gate vectors, respectively.  $\tilde{c}_t$  is the cell input activation vector.  $\odot$  represents the Hadamard product.  $W$  and  $b$  are the weight matrices and bias parameters that need to be learned during training;  $\sigma_g, \sigma_c$  and  $\sigma_h$  are logistic (sigmoid) function, hyperbolic tangent function and hyperbolic tangent functions, respectively (Yang et al., 2019a).

### 3. Test Equipment and Obtaining Data

In this section, obtaining the data used for SOC estimation of the battery using the electric UAV engine test equipment is explained.

RCbenchmark's 1580 model dynamometer and its interface software were used to obtain the data. In the study, GT2215/09 model brushless motor from Emax company, 50 A ESC unit to adjust the speed of the brushless motor and 10x5 propeller

were preferred. During the test, a Li-Po battery with 5000 mAh, 25 C and 11,1 volts was used as the electrical source. The test setup of the experimental study is given in Fig. 2.

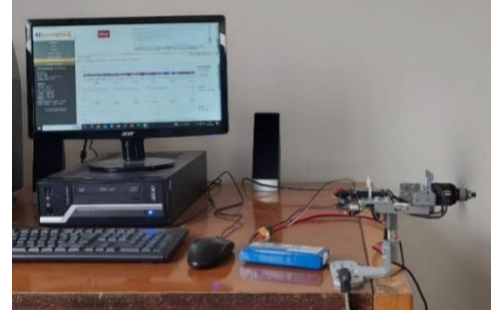

Figure 2. Test Equipment Setup to Obtain Data

The correlation matrix of the data obtained as a result of the experimental study is given in Fig. 3. A correlation matrix is a coefficient that shows the relationship between two variables. The correlation coefficient is between -1 and 1. As this coefficient approaches 1, the strength of the direct proportion between two variables increases. As this coefficient approaches -1, the strength of the inverse proportion between the two variables increases. If this coefficient is 0, the relationship between the two variables is not available. The color intensity of the correlation coefficients between -1 and 1 are showed on the right side of the Fig. 3. According to this information, when the correlation matrix is examined, it is seen that the data obtained are related to each other. In particular, while the SOC variable is directly proportional to thrust and voltage, it changes inversely proportional to current, ESC signal, vibration and electrical power. The time-dependent change of SOC by using the data obtained is presented in Fig. 4.

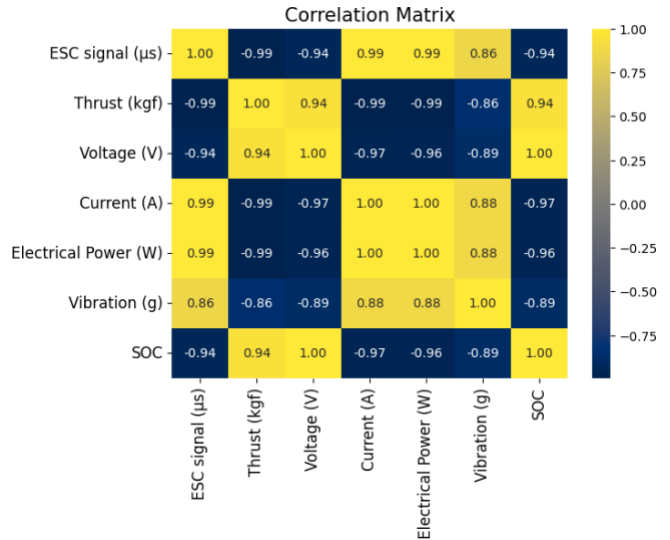

Figure 3. Correlation Matrix of the Data Obtained

When the Fig. 4 is examined, the SOC value given as a percentage decrease approximately linearly with time. Considering that the correlation coefficient between SOC and voltage is 1, the voltage also decreases linearly throughout the flight. Therefore, the SOC-time change graph means that the data obtained is appropriate.

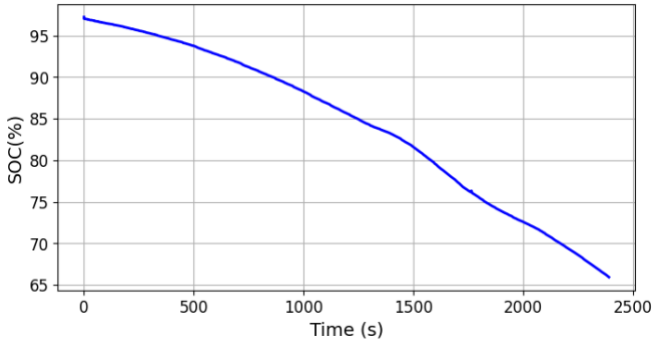

Figure 4. SOC-Time Change Graph

#### 4. Simulation Results

In this section, simulation results of the proposed models are presented using the data obtained during the test phase and the selected deep learning and machine learning algorithms. In this study, SVR and RF, which are machine learning models, and LSTM, which are deep learning architectures, were preferred. The proposed models were implemented by using Anaconda Python software. The performance criterias as Root Mean Square Error (RMSE), Mean Squared Error (MSE) and Mean Absolute Error (MAE) were preferred to evaluate the simulation performance. Mathematical expressions for these criteria are given in Equations 1-3, respectively. The smaller error value is considered proportional to the model accuracy (Chicco et al., 2021).

$$MSE = \frac{1}{n} \sum_{i=1}^n (y_i - \hat{y}_i)^2 \quad (1)$$

$$RMSE = \sqrt{\frac{1}{n} \sum_{i=1}^n (y_i - \hat{y}_i)^2} \quad (2)$$

$$MAE = \frac{1}{n} \sum_{i=1}^n |e_i| \quad (3)$$

858 data were used in the study. About 80% of the data (686 data) was selected for training and about 20% (172 data) for testing. In the proposed models using the selected methods, the steps of data preprocessing, model installation and obtaining predictions were carried out, respectively. In data preprocessing, normalization process was applied to the obtained data. Models for SOC prediction were built on training data and predictions were made on testing data.

The parameters of the proposed LSTM structure were chosen as 120 neurons in input layer, 0.2-dropout, 300-epochs and 4-batch size. The early stopping function, which automatically limits the number of epoch to prevent the proposed model from overlearning, was also used (Yao et al., 2007). In SOC prediction models made with LSTM, simulations were carried out by applying different look-back numbers instead of different layers or number of neurons. Training and test error values for different look-back numbers are presented in Table 1. When the performance criteria in Table 1 are compared, it is seen that error values increase as the number of look-back increases. In the 10-20 look-back value range, accordingly, it can be said that the LSTM structure with a look-back number of 10 is better.

Table 1. Training and test error values for different look-back numbers of LSTM

Look-back	MSE		RMSE		MAE	
	Train	Test	Train	Test	Train	Test
10	0.0049	0.0952	0.0701	0.3086	0.0664	0.2940
15	0.6688	0.1930	0.8178	0.4393	0.6727	0.3819
20	1.4054	0.3839	1.1855	0.6196	0.9623	0.5381

In Table 2, a comparison of the models determined to be better depending on the performance criteria for SOC prediction is presented. When the table is examined, it is seen that the LSTM model has the lowest error values in SOC estimation. Therefore, it can be said that the LSTM model performs better than the SVR and RF models in SOC prediction.

Fig. 5 shows the comparison of the predicted values and the true values of the SOC prediction made with the SVR model. Fig. 6 shows the comparison of the predicted values and the true values of the model generated for SOC prediction with RF. Fig. 7 shows the comparison of the predicted values obtained from the better model selected in the SOC prediction simulations made with LSTM with the true values.

Table 2. Comparison of the models determined to be better depending on the performance criteria for SOC prediction

Models	MSE		RMSE		MAE	
	Train	Test	Train	Test	Train	Test
RF	0.0182	0.1268	0.1349	0.3562	0.1093	0.3444
SVR	0.8371	0.6767	0.9149	0.8226	0.8664	0.7317
LSTM	0.0049	0.0952	0.0701	0.3086	0.0664	0.2940

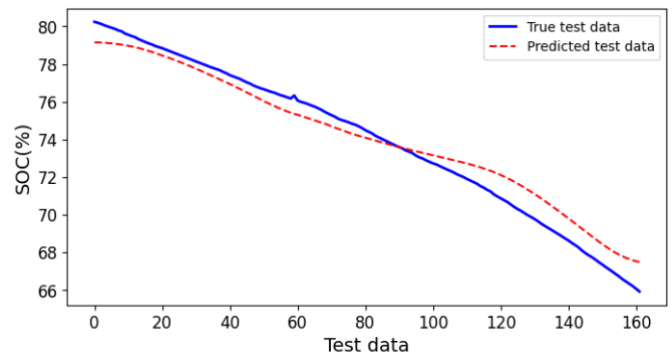

Figure 5. Comparison of actual values and obtained values for SOC estimation made with the proposed SVR model

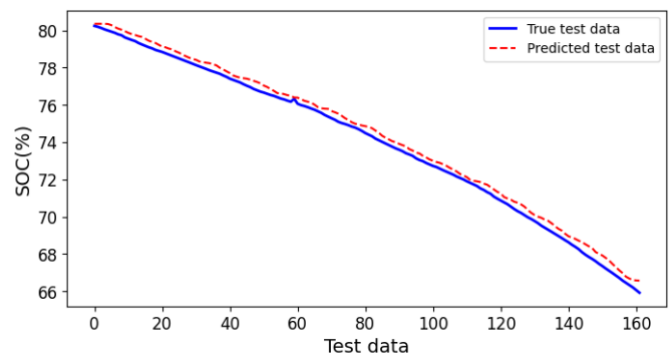
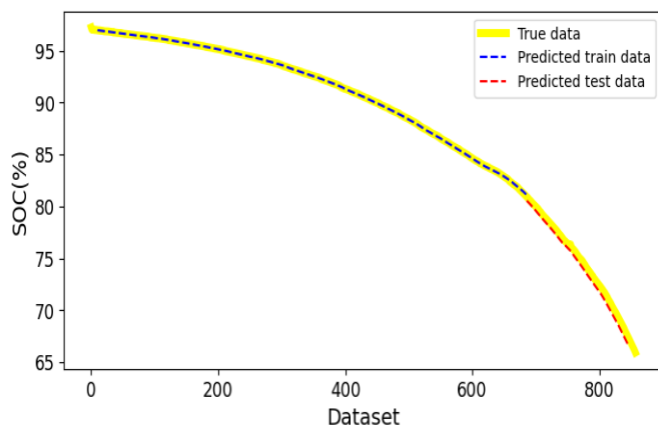

Figure 6. Comparison of actual values and obtained values for SOC estimation made with the proposed RF model



**Figure 7.** Comparison of actual values and obtained values for SOC estimation made with the proposed LSTM model

### 5. Conclusion

It is important to evaluate many factors for safely and comfortable flight. One of the most important among these factors is the estimation of flight time. In this study, SOC values of the battery, which is effective in the flight time of the UAV, was estimated using deep learning and machine learning algorithms. The data used in the proposed models were obtained through tests performed on an electric UAV engine test equipment by using a Li-Po battery. Using the data obtained, that is, based on the voltage change of the Li-Po battery, SOC value of the battery was estimated using SVR, RF and LSTM methods. Using the data obtained, that is, based on the voltage change of the Li-Po battery, SOC value of the battery was estimated using SVR, RF and LSTM methods. However, when the predicted values because of simulation made with the proposed models are compared with the true data, the presented results are quite satisfactory. These results support the reliability of the proposed models in estimating SOC, which plays an important role in the flight time of UAVs. Therefore, the models proposed in this study can be effectively used as an alternative to other methods for battery SOC estimation.

### Ethical approval

Not applicable.

### Conflicts of Interest

The authors declare that there is no conflict of interest regarding the publication of this paper.

### Acknowledgement

This study was supported by the Scientific Research Projects Unit of Erciyes University with the FYL-2023-13166 project code. Thank you for support.

### References

Arik, S., Turkmen, I. and Oktay, T. (2018). Redesign of Morphing UAV for Simultaneous Improvement of Directional Stability and Maximum Lift/ Drag Ratio. *Advances in Electrical and Computer Engineering*. 18(4), 57-62.

Bengio, Y., Simard, P. and Frasconi, P. (1994). Learning long-term dependencies with gradient descent is difficult. *IEEE transactions on neural networks*. 5(2), 157-166.

Bilgin, M. and Konar, M. (2022). Investigation of Visual Disappearance by Intelligent Illumination of Exterior Surfaces of Unmanned Aerial Vehicles. *Journal of Aviation*. 6(1), 26-32.

Breiman, L. (2001). Random forests. *Machine learning*, 45(1), 5-32.

Burges, C. J. C. (1998). A tutorial on support vector machines for pattern recognition, *Data Mining Knowledge Discovery*. 2(2), 121- 167.

Cai, C. H., Du, D. and Liu, Z. Y. (2003, May). Battery state-of-charge (SOC) estimation using adaptive neuro-fuzzy inference system (ANFIS). In *The 12th IEEE International Conference on Fuzzy Systems*, 2003. 1068-1073.

Chaoui, H. and Ibe-Ekeocha, C. C. (2017). State of charge and state of health estimation for lithium batteries using recurrent neural networks. *IEEE Transactions on Vehicular Technology*. 66(10), 8773-8783.

Chicco, D., Warrens, M. J. and Jurman, G. (2021). The coefficient of determination R-squared is more informative than SMAPE, MAE, MAPE, MSE and RMSE in regression analysis evaluation. *PeerJ Computer Science*, 7, e623.

Coban, S. and Oktay, T. (2023). Innovative Morphing UAV Design and Manufacture. *Journal of Aviation*. 7(2), 184-189.

Cortes, C. and Vapnik, V. (1995). Support-vector networks. *Machine Learning*. 20, 273-297.

Cutler, A., Cutler, D. R. and Stevens, J. R. (2012). *Random forests, Ensemble machine learning Methods and Applications*. Springer, Boston, MA.

Daniel, K. and Wietfeld, C. (2011). Using public network infrastructures for UAV remote sensing in civilian security operations. *Homeland Security Affairs, Supplement*.

Elman, J. L. (1990). Finding structure in time. *Cognitive Science*. 14(2), 179-211.

Ersen, M and Konar, M. (2023). Obtaining Condition Monitoring Data for the Prognostics of the Flight Time of Unmanned Aerial Vehicles. *Journal of Aviation*. 7(2), 209-214.

Gupta, L., Jain, R. and Vaszkun, G. (2015). Survey of important issues in UAV communication networks. *IEEE Communications Surveys & Tutorials*. 18(2), 1123-1152.

Hannan, M. A., Lipu, M. H., Hussain, A. and Mohamed, A. (2017). A review of lithium-ion battery state of charge estimation and management system in electric vehicle applications: Challenges and recommendations. *Renewable and Sustainable Energy Reviews*. 78, 834-854.

Hastie, T., Tibshirani, R. and Friedman, J. (2009). *The elements of statistical learning: data mining, inference, and prediction*. Springer Science & Business Media.

Hermawan, A. P., Kim, D. S. and Lee, J. M. (2020, September). Sensor failure recovery using multi look-back lstm algorithm in industrial internet of things. In *2020 25th IEEE International Conference on Emerging Technologies and Factory Automation (ETFA)*, 1363-1366.

Hochreiter, S. and Schmidhuber, J. (1997). Long short-term memory. *Neural Computation*. 9(8), 1735-1780.

Konar, M. (2019). GAO Algoritma tabanlı YSA modeliyle İHA motorunun performansının ve uçuş süresinin

- maksimizasyonu. *Avrupa Bilim ve Teknoloji Dergisi*. 15, 360-367.
- Kotsiantis, S. B., Zaharakis, I. and Pintelas, P. (2007). Supervised machine learning: A review of classification techniques. *Emerging Artificial Intelligence Applications in Computer Engineering*. 160(1), 3-24.
- LeCun, Y., Bengio, Y. and Hinton, G. (2015). Deep learning. *Nature*. 521(7553), 436-444.
- Liu, X., Wu, J., Zhang, C. and Chen, Z. (2014). A method for state of energy estimation of lithium-ion batteries at dynamic currents and temperatures. *Journal of Power Sources*. 270, 151-157.
- Ma, L., Hu, C. and Cheng, F. (2021). State of charge and state of energy estimation for lithium-ion batteries based on a long short-term memory neural network. *Journal of Energy Storage*. 37, 102440.
- Mitchell, T. M. (1997). *Machine learning*. McGraw Hill.
- Oztemel, E. (2003). *Yapay Sinir Ağları*. İstanbul: Papatya Yayıncılık.
- Sahin, H., Oktay, T. and Konar, M. (2020). Anfis Based Thrust Estimation of a Small Rotary Wing Drone. *European Journal of Science and Technology*. 18, 738-742.
- Sidhu, M. S., Ronanki, D. and Williamson, S. (2019). State of charge estimation of lithium-ion batteries using hybrid machine learning technique. In *IECON 2019-45th Annual Conference of the IEEE Industrial Electronics Society*. 1, 2732-2737.
- Song, X., Yang, F., Wang, D. and Tsui, K. L. (2019). Combined CNN-LSTM network for state-of-charge estimation of lithium-ion batteries. *IEEE Access*. 7, 88894-88902.
- Sutton, R. S. (1992). Introduction: The challenge of reinforcement learning. In *Reinforcement learning*. Boston, MA: Springer US.
- Vapnik, V. N. (1998). *Statistical learning theory*. New York: Wiley.
- Yang, F., Song, X., Xu, F. and Tsui, K. L. (2019a). State-of-charge estimation of lithium-ion batteries via long short-term memory network. *IEEE Access*. 7, 53792-53799.
- Yang, F., Li, W., Li, C. and Miao, Q. (2019b). State-of-charge estimation of lithium-ion batteries based on gated recurrent neural network. *Energy*. 175, 66-75.
- Yao, Y., Rosasco, L. and Caponnetto, A. (2007). On Early Stopping in Gradient Descent Learning. *Constructive Approximation*. 26(2), 289-315.
- Youssef, H. Y., Alkhaja, L. A., Almazrouei, H. H., Nassif, A. B., Ghenai, C. and AlShabi, M. A. (2022). A machine learning approach for state-of-charge estimation of Li-ion batteries. In *Artificial Intelligence and Machine Learning for Multi-Domain Operations Applications IV*. 12113, 674-682).
- Zha, W., Liu, Y., Wan, Y., Luo, R., Li, D., Yang, S. and Xu, Y. (2022). Forecasting monthly gas field production based on the CNN-LSTM model. *Energy*, 124889.
- Zhang, L., Wang, S. and Liu, B. (2018). Deep learning for sentiment analysis: A survey. *Wiley Interdisciplinary Reviews: Data Mining and Knowledge Discovery*. 8(4), e1253.
- Xiong, R., He, H., Sun, F., Liu, X. and Liu, Z. (2013). Model-based state of charge and peak power capability joint estimation of lithium-ion battery in plug-in hybrid electric vehicles. *Journal of Power Sources*. 229, 159-169.

**Cite this article:** Karaburun, N.N., Arık Hatipoğlu, S., Konar, M. (2024). SOC Estimation of Li-Po Battery Using Machine Learning and Deep Learning Methods. *Journal of Aviation*, 8(1), 26-31.



This is an open access article distributed under the terms of the Creative Commons Attribution 4.0 International License

Copyright © 2024 *Journal of Aviation* <https://javsci.com> - <http://dergipark.gov.tr/jav>