

PRODUCTION of a FRESHNESS DETERMINATION SENSOR

Emine KEMİKLİOĞLU*,

Department of Bioengineering, Manisa Celal Bayar University, Turkey, emine.kemiklioglu@cbu.edu.tr

 <https://orcid.org/0000-0002-7827-2423>

Özlem ÖZEN,

Department of Bioengineering, Manisa Celal Bayar University, Turkey, zlemozen@gmail.com

 <https://orcid.org/0000-0003-1522-1271>

Berfin GÜRBOĞA,

Department of Bioengineering, Manisa Celal Bayar University, Turkey, gurbogaberfin@gmail.com

 <https://orcid.org/0000-0001-5069-0212>

Received: 23.02.2018, Accepted: 31.08.2018

Research Article

*Corresponding author

DOI: 10.22531/muglajsci.426448

Abstract

Since fruits and vegetables are rich in vitamins, minerals and antioxidant they are irreplaceable for a healthy life. Despite the fact that their benefits, they could cause serious diseases when they are consumed while they are deteriorated since they lose their nutrient value with time and became available for microorganisms. As a consequence of it, mold formation occurs which is harmful to both health and food industry. As a consequence of a serial of experiments which were performed considering the importance of the freshness of food in terms of health and food industry, the relation between freshness and ion mobility is revealed. As following a device was developed with the aim of determination freshness - ion concentration relation. For the evaluation of the sensor measurements, a software including experimental measurement deterioration and freshness result data has been developed and the freshness can be determined by using the designed sensor through this software. Obtained experimental measurement results and sensor measurement results are compared and the results are also supported by observations repeated at different conditions.

Keywords: Freshness detection, novel design, vegetable freshness, novel sensor, mold.

TAZELİK BELİRLEYEN SENSÖR ÜRETİMİ

Öz

Meyve ve sebzeler sağlıklı bir yaşam için tüketilmesi gereken esansiyel ürünler arasında içerdikleri yüksek vitamin, mineral ve antioksidan gibi faydalı maddeler bakımından da ilk sırada bulunmaktadır. İyi etkileri sayılamayacak kadar fazla olsa da taze tüketilmediklerinde besin değerleri düşmekte ve mikroorganizmalarca istila edilmektedirler. Bu durum sonucunda küf oluşumu gözlemlenmekte ve hem sağlık açısından hem de gıda sektöründe ekonomik açıdan birtakım sorunlar oluşmaktadır. Meyve ve sebzelerin tazeliğinin sağlık ve gıda sektörüne ek olarak ekonomik anlamda yarattığı önem göz önünde bulundurularak yapılan deneyler sonucu tazelik parametresinin iyon hareketliliği ile olan etkisi ortaya çıkarılmıştır. Gerçekleştirilen deneysel çalışmalar sonucunda elde edilen veriler yardımıyla tazelik ile iyon hareketliliği arasında bir ilişki kurularak bu deneyin sonuçlarının pratikte kullanılabilirliğini sağlamak amacı ile bir cihaz geliştirilmiştir. Yapılan deneyleri takiben geliştirilen cihaz tazelik-iyon hareketliliği ilişkisini belirleyebilen bir sensör olarak tasarlanmıştır. Sensör ölçümlerinin değerlendirilmesi için deneysel ölçümler ile elde edilen tazelik ve bozulma değeri verilerini içeren bir yazılım geliştirilmiş ve yazılımdan yararlanarak tazelik, tasarlanan sensör ile belirlenebilmiştir. Elde edilen deneysel ölçüm sonuçları ve sensör ölçüm sonuçları karşılaştırılmış, sonuçların birbirini destekler nitelikte oldukları aynı zamanda farklı koşullarda tekrarlanan gözlemlerle de belirlenmiştir.

Anahtar Kelimeler: Tazelik tespiti, yeni tasarım, sebze tazeliği, yeni sensör, küf

Cite

Kemiklioğlu E., Ozen O., Gurboga B., (2017). "Production of a freshness determination sensor", *Mugla Journal of Science and Technology*, 4(2), 248-256.

1. Introduction

Foods provide the necessary nutrients for life, as well as the bioactive compounds necessary to promote and improve health [1, 2]. Fruits and vegetable gained their unchangeable places in humans eating habits years ago since they are considered as natural protectors of our

bodies. They protector ability comes from their vitamin, antioxidant and mineral content also they have low calories. At the same time, the phytochemical properties of fruits and vegetables have the role as the anti-obesity agent [3].

According to popular belief among the people and, also scientific evidence shows that consumption of a specific amount fruit and vegetable could protect us from diseases by strengthening our immune system against a foreign microorganism. This phenomenon is proved by lots of scientific studies for a long time ago. For instance, banana consumption could help avoiding strokes since it is rich in potassium. In addition to that, banana also could help lowering of TC/HDL-C and LDL-C/HDL-C ratio and could increase insulin sensitivity of a regular banana consumer [4]. In addition to banana, apples have some important benefits like they could prevent lung cancer since they are highly rich in carotene called flavonoid [4]. Also, apples are known to be rich in antioxidants such as vitamin C and phloretin etc. Moreover, orange colored fruits and vegetables are rich in carotenoids. In addition to these, a high amount of carotenoid is present in dark green vegetable [2]. In citrus type fruit juices, vitamins and minerals, as well as sugars and polyphenols, along with phytochemicals and different organic components has a natural balance [5]. Also, fruit and fruit juices of citrus fruits contain antioxidants such as flavonoids, phenolic compounds, and pectins which are important for human health [6, 8]. Another example of the flavonoid source is peppers. Flavonoids in peppers act as anti-inflammatory agents or anti-allergens [9]. Another beneficial chemical present in plants is phenolic compounds. Strawberries are one type of the fruits which are highly rich in phenolic compounds [10]. This chemical present in strawberries could contribute anti inflammation-related pathways and have a positive impact on cardiovascular diseases, cancer, and neurological problems [10, 11].

All these beneficial impacts of fruits and vegetables depend on their freshness and freshness depends on some environmental factors. Changes and imbalances in these environmental factors such as temperature changes, light, humidity ratio, and microorganism presence could have a detrimental impact on the freshness of food. Changes in these parameters or storing fruits and vegetables at unsuitable conditions (in terms of these parameters) will speed up their deterioration process and also make them more defenseless for microorganism contamination, in other words in a situation like this, fruits and vegetables are more suitable for mold formations [12] by variable fungi types. Moreover, their formation results could be undistinguishable with the naked eye at the beginning without laboratory equipment. Molds are long and filament shaped microorganisms which could grow very fast on any fruits and vegetables if they could pass their protection barrier and the environmental parameters are suitable [3]. One of the reasons for avoiding the consumption of moldy fruits and vegetables is that they cause some diseases since some of them could produce very dangerous toxins called mycotoxins as their secondary metabolites. These secondary metabolites could infect people by inhalation, ingestion and dermal routes [11]. The most famous and dangerous one among

the mycotoxins is aflatoxin which is produced by *Aspergillus flavus*. The reason of fame of this toxin has arisen from its ability to cause cancer [12, 13]. Besides cancer, commonly seen diseases caused by interaction with mold could be sorted as allergies, respiratory-related diseases, immune system disorders, weight loss, skin rash even death [14]. If the contamination by microorganisms occurs at early stages of growth of fruits or vegetables, it becomes impossible to detect since mold formation stays underneath of the peepo and peel of the product and became hard to realize. To overcome these problems lots of studies have been performed in the past. Most of the previous studies were related to conservation of freshness instead of the determination of the present freshness. One of these methods depends on the usage of some protective agents, such as calcium and ascorbate ions in order to prolong the shelf life and conserve present freshness level [15]. There is another study which uses ascorbate ion to extend shelf life and avoid browning of the fruits. In this study, a solution of ascorbate ion whose pH is between 4 and 7.5 is used [16]. Besides ions, as a chemical agent also benzyl alcohol solution has used as a deterioration blocker treatment [17]. In addition to chemicals, UV light exposure method is also used to slow down the deterioration process [18]. One of the UV related studies used UV light to convert ethylene gas which is released by fruits and vegetables into carbon dioxide gas in order to conserve freshness of plants in refrigerators [19]. In order to avoid all these possible dangers, we started a study about observable specific changings during deterioration process. In addition to apparent observed changes in color, odor and taste our experiments show that fruits and vegetables undergo electrical changes like ion concentration change during deterioration process.

In this study, we have developed a novel device which could be used to detect freshness of fruits and vegetables according to the obvious change in ion concentration with time. The motivation of this study was avoiding diseases arisen from consumption of spoiled fruits and vegetables and avoiding economic problems related to spoiled products.

2. Material and Methods

2.1. Sensor Design

Since the freshness is very crucial in terms of foods, a sensor was designed in order to determine samples' freshness level. This determination is accomplished by using an electrical circuit which is designed by using a program called DIP Trace. Also, the data evaluated according to a code which is developed by using a program called PIC basic. This developed code has all the threshold values obtained from laboratory experiments for each different sample.

The electrical circuit could be divided into four parts as shown in Fig. 1. The first part, the processor supply circuit (A), is related to the energy supply of the sensor which is a 9-volt battery. The second part, the liquid crystal display (LCD) circuit (B), is responsible for the LCD. Each leg of LCD has a different duty like one of them

is responsible for hue; another one is responsible for color other is responsible for light density etc. Each leg should be connected to the third part, PIC (C), in the right order in order to change these features of display and also PIC has our code inside it which decides the sample is fresh or spoiled according to its library. Finally, the last part of the circuit is its measurement part (D) where the electrodes are connected to the circuit so the ions flow through them and their amount is detected.

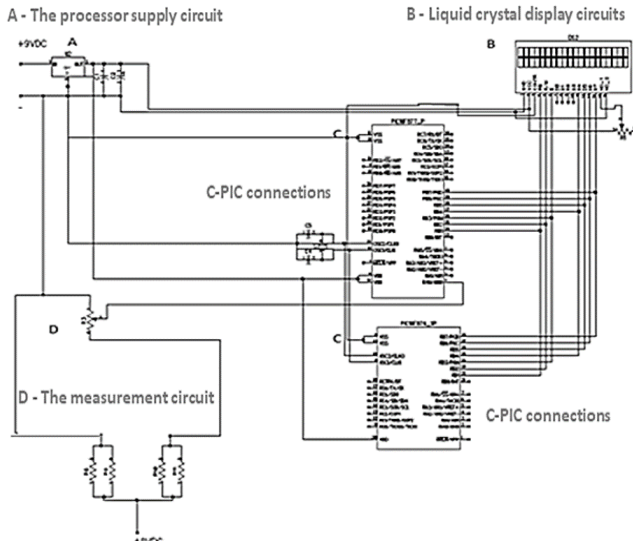

Figure 1. Electrical circuit of the device.

The developed code for this device allows us to select which type of sample we have. This selection and determination of threshold values are very crucial since each sample has different threshold values for their freshness. In addition to them, code light different Light Emitting Diodes (LEDs) according to the value such as red for spoiled, blue for about to be spoiled and green for fresh samples. Also it there is loose contact at electrodes the program detects it and the “measurement failed” writing appears on the LC display. The measurement results are illustrated in Fig. 2. for both conditions and appearance of the sensor is designed by using a design program called RhinoCeros.

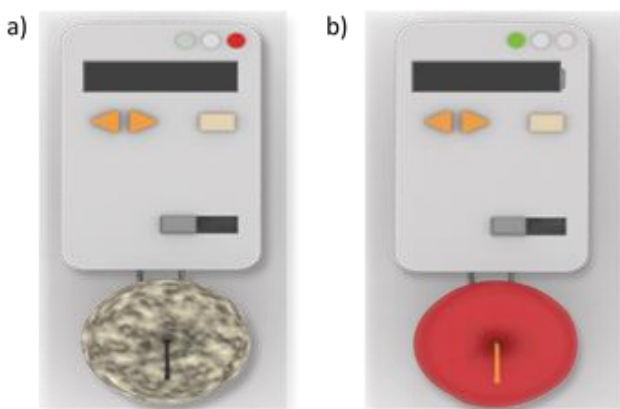

Figure 2. The first prototype appearance.

The designed sensor mainly consists of five parts which are display and LEDs, control panel, electrical circuit, electrodes and, battery as shown in Fig. 3.

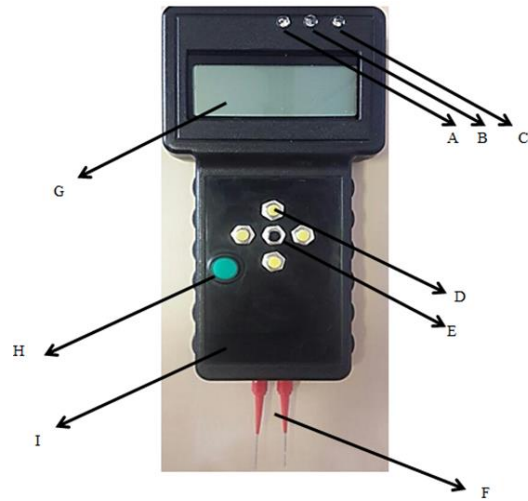

Figure 3. The first prototype appearance.

The display is used for visualization of measurement results (G) while LEDs (A, B, C) are responsible for simplification of the understanding of results. In order to accomplish that three different colored LEDs are used which are red, blue and green respectively they mean spoiled sample, the sample is about to be spoiled and the sample is fresh. The second part of the sensor, control panel, is consist of an off-on button (H) a selection key (E) and, direction keys (D) which are needed to choose the type of the sample. To interact with the pepo of the fruit or vegetable 2 copper electrodes (F) were placed at the bottom of the device.

Measurement is performed by stabbing these electrodes to sample of interest. The reason for copper electrodes is their high resistivity. All measurements are performed by using electrodes which have the same thickness, height, diameter, and resistivity in order to eliminate experimental errors. Additionally, the designed circuit has a wide measurement range which is between 0 and 1 MΩ in favor of its design and used components. After stabbing the electrodes to sample, within 30 seconds measurement can be seen from the LC display. Electrodes are placed on the sensor with 20 mm distance and it kept constant during all measurements. As the distance between electrodes, length of the electrodes kept constant as 40 mm. As shown in Fig. 4., the size of the first prototype is 190mmx110mmx10mm.

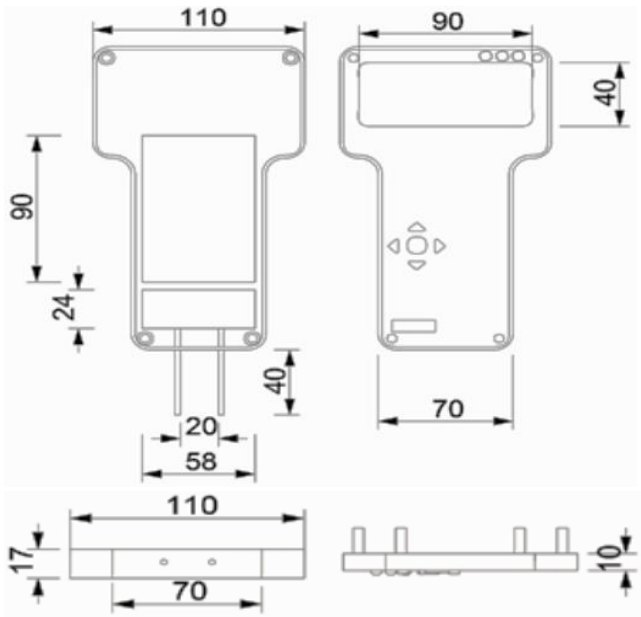

Figure 4. The technical drawings of the first prototype

In order to make a test first of all the sample of interest should be selected from the menu. As a second step electrodes should be cleaned and stabbed to sample. After stabbing, by pressing the start button measurement should be started. Measurement takes about 20 seconds for each sample and after that, a message appears in the LC display which indicated the freshness stage of the sample also according to the interval which measured value belongs one of the colored LEDs starts to light to simplify the understanding of the result. Also after each measurement, a beep tone is heard to show measurement is completed. To make a new measurement by using direction and selection keys the measure again button should be selected. Then the software leads us back to the menu of samples to select the sample type for next measurement [20].

The illustration of freshness measurement of an apple is shown in Fig. 5. The apple sample is fresh because green light appears after the measurement is completed.



Figure 5. Freshness measurement of apples by using the first prototype

2.1.1. Experimental Section

In this study, as nutrition samples; potato, tomato, pepper, lemon, orange, strawberry, banana and, apple, as well as solid samples also lemon and orange juices, were used. The freshness levels of this nutrition samples were determined depending on their ion mobility changes as a function of time and environmental conditions. The ion mobility of all these nutrition and juices were determined both at room temperature (25 °C) and refrigerator temperature (+4 °C) to understand the temperature impact on the freshness level. Moreover, the juices of lemon and orange, which were obtained by squeezing the fresh fruits were stored in glass and plastic bottles at different temperatures in order to understand the impact of plastic and glass on freshness. Two electrodes of the sensor were stabbed into the nutrition keeping the distance between the two electrodes constant. The resistance changes of the solid nutrition samples were measured between 0 and 1 MΩ and were recorded as a function of the ambient temperatures and day. The same procedure was applied to all fruit juices at room and refrigerator temperatures and in the glass and the plastic bottle. In order to measure the resistivity in the juices, all liquid samples were mixed by using a vortex for twenty seconds before the measurements.

During experiments observed physical and chemical changes on both solid and liquid samples were saved such as changes in odor, color, shrinkage, softening, mold formations. As seen in Fig. 6. in plastic falcon both orange and lemon juice showed some visible changes after one week.



Figure 6. The formation of molds in juices of a) orange
b) lemon

Furthermore, the samples from the moldy part of each solid fruit and vegetable were taken with the help of a steel spatula and then these parts were placed on the glass slides. These samples were examined via Polarizing Light Microscope (POM) using different magnifications as seen in Fig. 7. As a result of the observations, the pictures of mold formations were captured.

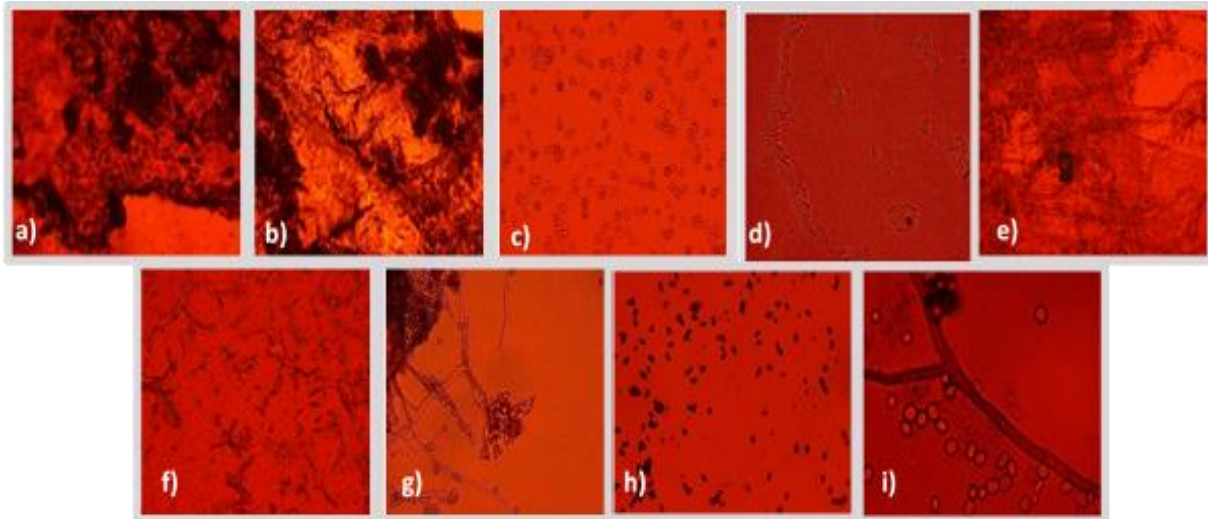

Figure 7. POM images of a) lemon (100x), b) orange (100x), c) strawberry (400x), d) banana (400x), e) orange juice (100x), f) lemon juice (100x), g) apple (400x), h) pepper (400x), i) tomato (400x)

3. Results and Discussions

The ion concentration changes in lemons and oranges were measured after they cut into two pieces. These measurements were repeated for 23 days in room condition and 17 days in refrigerator condition until they are completely covered with mold formation. The first mold formation on the orange peel were observed in the first week of the experiment. At the same time, after peeling off the orange and lemons, fruits were started to show softening and molding faster. The changes in lemon

and orange ion concentrations (resistivity) stored in the refrigerator and room conditions illustrated in Fig. 8.

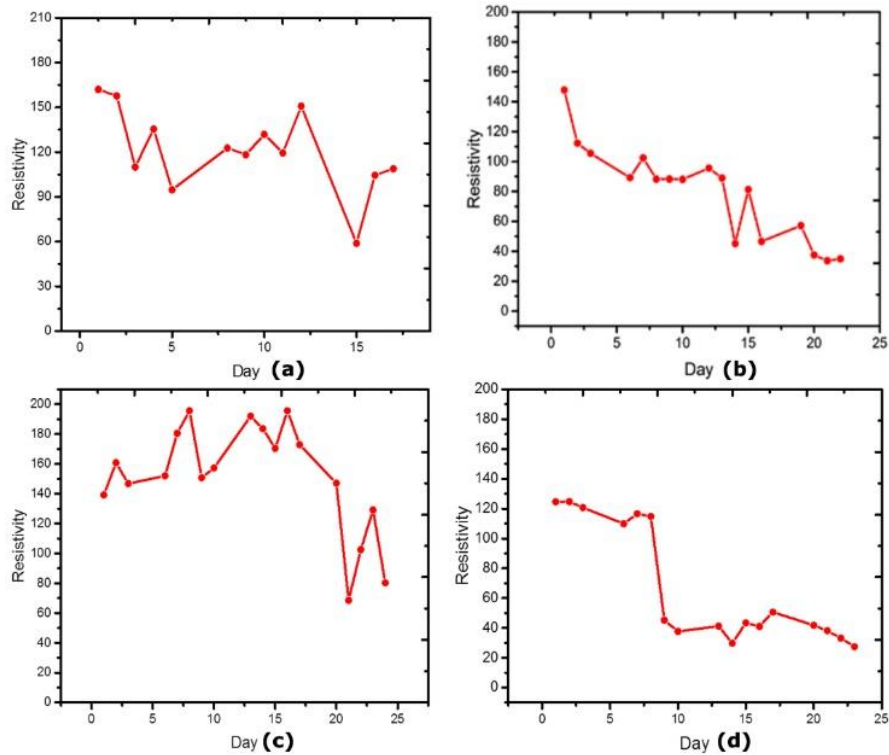

Figure 8. Resistivity of lemon at a) refrigerator condition b) room condition, and resistivity of orange at c) refrigerator condition d) room condition, respectively.

According to obtained data from several repeats, freshness thresh-hold values for lemon and orange are determined. The ion concentration changes in strawberries were measured after they stored in both room and refrigerator conditions. These measurements were repeated at room temperature and refrigerator temperature until they are completely covered with mold formation. The first mold formation on the samples observed after 5 days at room condition and after 8 days at refrigerator condition. Moreover, different mold formations were observed when strawberry started to deterioration. As seen in Fig. 9. the deterioration times different at each condition. According to obtained data from several repeats, freshness thresh-hold values for strawberry are determined.

The ion concentration changes in bananas were measured after they stored at in both room and refrigerator conditions. These measurements were repeated at room temperature and refrigerator temperature until they are completely covered with mold formation. The first mold formation on the samples observed after 14 days at room condition and after 19 days at refrigerator condition. Since banana is a tropical fruit color change occurred faster when it is stored in refrigerator. However, at deterioration time difference between each condition in terms of resistivity is quite small as expected.

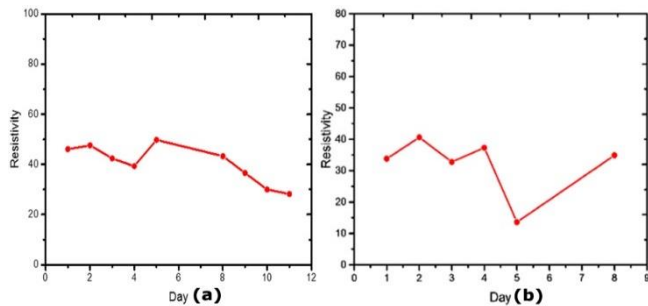

Figure 9. Resistivity of strawberries at a) refrigerator condition b) room condition.

Besides, as seen in Fig. 10., the deterioration times are different for each condition. According to obtained data from several repeats, freshness threshold values for banana are determined.

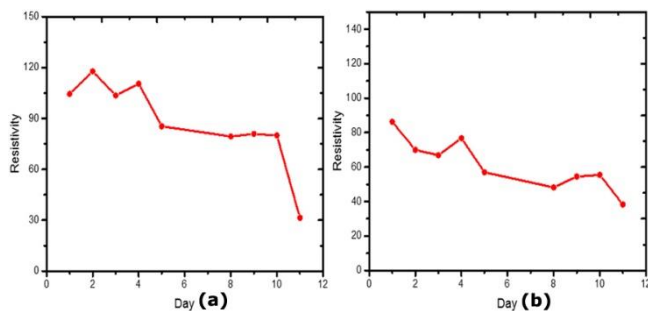

Figure 10. Resistance values of bananas at a) refrigerator condition b) room condition.

The ion concentration changes in apples were measured after they stored at in both room and refrigerator conditions. These measurements were repeated at room temperature and refrigerator temperature until they are

completely covered with mold formation. The first mold formation on the samples observed after 14 days at room condition and after 25 days at refrigerator condition. As seen in Fig. 11. the deterioration times are different for each condition. According to obtained data from several repeats, freshness thresh-hold values for apples are determined.

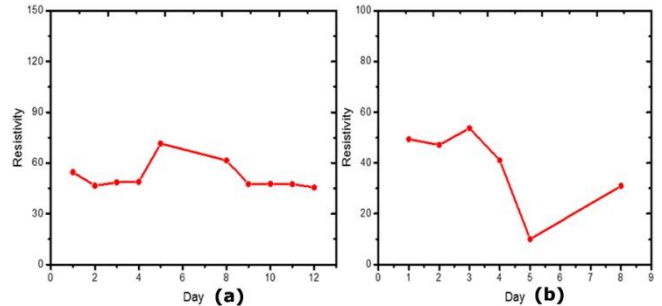

Figure 11. Resistance values of apples at a) refrigerator condition b) room condition

The ion concentration changes in tomatoes were measured after they stored at in both room and refrigerator conditions. These measurements were repeated at room temperature and refrigerator temperature until they are completely covered with mold formation. The first mold formation on the samples observed after 9 days at room condition and after 25 days at refrigerator condition. Tomatoes were another sample type which showed different mold formations. As seen in Fig. 12. the deterioration times are different for each condition. According to obtained data from several repeats, freshness thresh-hold values for tomatoes are determined.

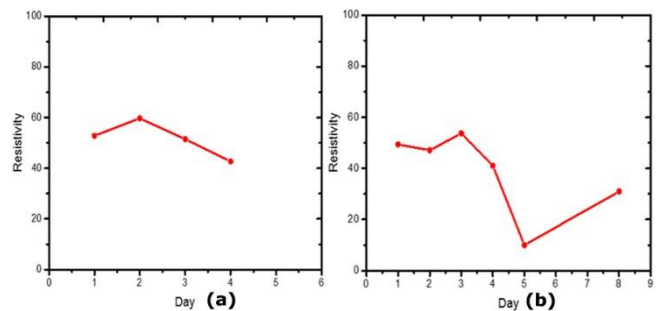

Figure 12. Resistance values of tomatoes at a) refrigerator condition b) room condition

The ion concentration changes in potatoes and peppers were measured after they stored at in room conditions. These measurements were repeated at room temperature until they are completely covered with mold formation. Contrary to expectations and other samples there wasn't any mold formation on potatoes. Even though there were changes in color, smell and, hardness of potatoes. Moreover, it was the only sample type which showed germination. As shown in Fig. 13., deterioration times have changed depending on the time. According to obtained data from several repeats, freshness thresh-hold values for pepper and potato are determined.

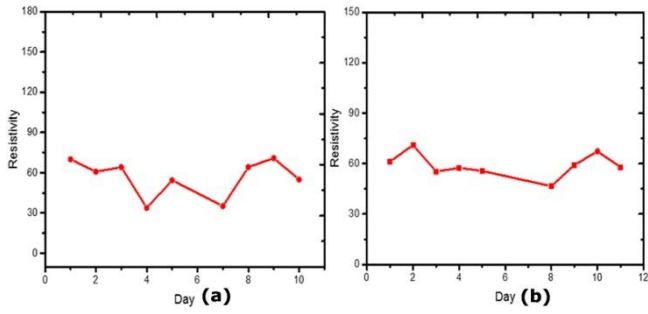

Figure 13. Resistance values of a) potatoes at room condition b) peppers at room condition

The ion concentration changes in lemon juices were measured after they stored in the glass and plastic bottles. These measurements were repeated at room temperature and refrigerator temperature until their tops are completely covered with mold formation. Fig. 14. shows ion concentration changes in lemon juices.

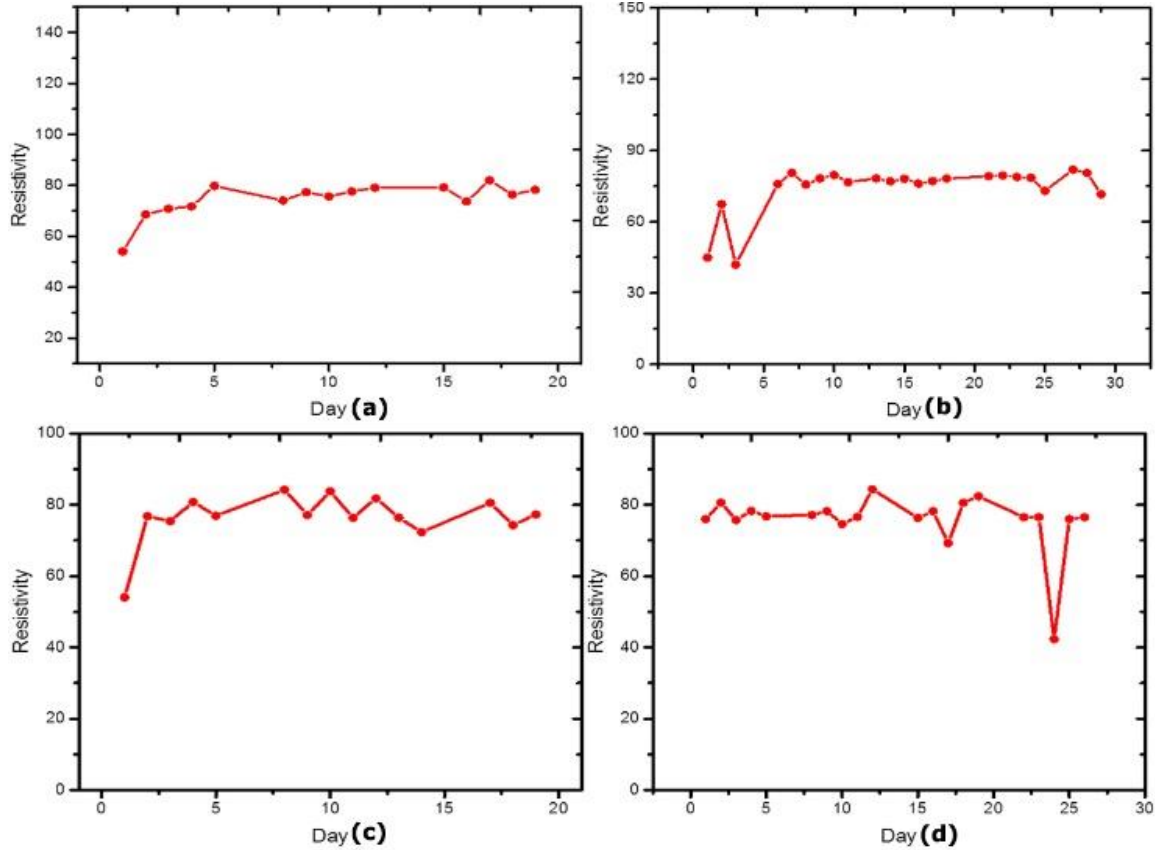

Figure 14. Lemon juices a) in glass bottle at refrigerator condition b) in glass bottle at refrigerator condition c) in plastic bottle at room condition d) in plastic bottle at room condition.

According to obtained data from several repeats, freshness threshold values for lemon juice are determined. The ion concentration changes in orange juices were measured after they stored in the glass and plastic bottles. These measurements were repeated at room temperature and refrigerator temperature until their tops are completely covered with mold formation.

Fig. 15 shows ion concentration changes in orange juices. According to obtained data from several repeats, freshness threshold values for orange juice are determined.

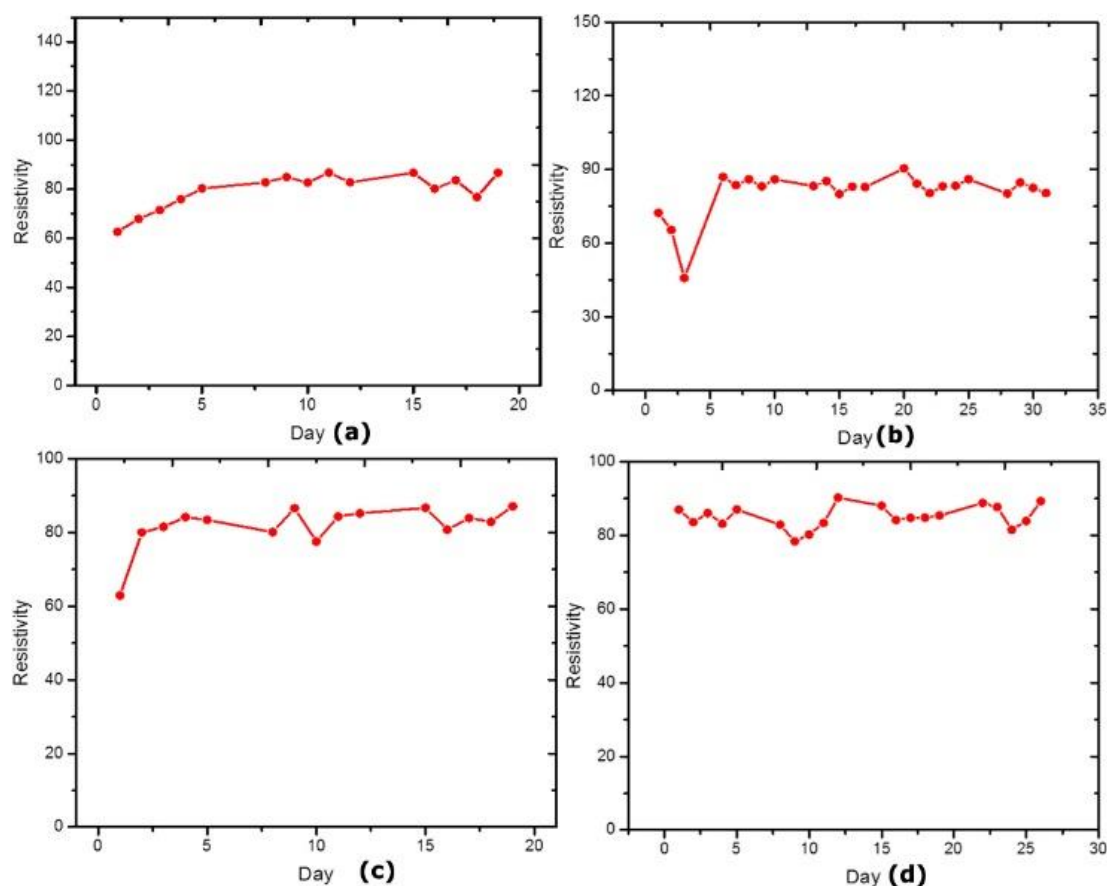

Figure 15. Orange juices a) in glass bottle at refrigerator condition b) in glass bottle at refrigerator condition c) in plastic bottle at room condition d) in plastic bottle at room condition

Moreover, mold formation on the lemon and orange juices were observed after 8 days in plastic bottles in the room, after 11-12 days in plastic bottles in the refrigerator, after 10 days in the glass bottles in the room, later than 15 days in the glass bottles in the refrigerator.

In addition to changes in resistivity some odor changes and a reduction at amount of the water content have been observed. Also, in the juices acidification was observed.

4. Conclusion

Consequently, the health problems and, other freshness related problems of food-related companies, markets and consumers can be overcome by this novel freshness determination sensor. The sensor provides a chance to detect invisible microorganism contamination by measuring the freshness loss caused by these organisms according to ion concentration change. So, this device could be used to prevent spoiled food-related allergies and respiratory diseases etc. The sensor could be used on samples even without any chemical or physical treatment. Elimination of this step contributes the usability of the sensor in terms of cost and time. Additionally, not using any chemical agent for the test makes this sensor more health friendly. After a series of

experimental studies and their results developed novel sensor show that it could be used for freshness determination of fruits and vegetables and with further study, the sensor could be made suitable for dairy products.

5. References

- [1] Liu, R. H. Health benefits of fruit and vegetables are from additive and synergistic combinations of phytochemicals. *Am J Clin Nutr*, 2003, 517s-520s.
- [2] Slavin, J. L.; Lloyd, B. Health benefits of fruits and vegetables. *Adv Nutr*, 2012, 3(4), 506-516. DOI: 10.3945/an.112.002154.
- [3] Pem, D.; Jeewon, R. Fruit and Vegetable Intake: Benefits and Progress of Nutrition Education Interventions- Narrative Review Article. *Iranian Journal of Public Health*, 2015, 44(10), 1309-1321.
- [4] Van Duyn, M. A.; Pivonka, E. Overview of the health benefits of fruit and vegetable consumption for the dietetics professional: selected literature. *J Am Diet Assoc*, 2000, 100(12), 1511-1521. DOI: 10.1016/s0002-8223(00)00420-x.
- [5] Boyer, J.; Badis, G.; Fairhead, C.; Talla, E.; Hantraye, F.; Fabre, E.; Dujon, B. Large-scale exploration of growth inhibition caused by overexpression of genomic fragments in *Saccharomyces cerevisiae*. *Genome Biology*, 2004, 5(9), R72-R72. DOI: 10.1186/gb-2004-5-9-r72.

- [6] Rampersaud, G. C.; Valim, M. F. 100% citrus juice: Nutritional contribution, dietary benefits, and association with anthropometric measures. *Crit Rev Food Sci Nutr*, 2017, 57(1), 129-140. DOI: 10.1080/10408398.2013.862611.
- [7] Djenane, D. Chemical Profile, Antibacterial and Antioxidant Activity of Algerian Citrus Essential Oils and Their Application in *Sardina pilchardus*. *Foods*, 2015, 4(2), 208-228. DOI: 10.3390/foods4020208.
- [8] Mahmoud, K. F.; Ibrahim, M. A.; Mervat, E.-D.; Shaaban, H. A.; Kamil, M. M.; Hegazy, N. A. Nano-encapsulation Efficiency of Lemon and Orange Peels Extracts on Cake Shelf Life. *American Journal of Food Technology*, 2016, 11(3), 63-75. DOI: 10.3923/ajft.2016.63.75.
- [9] Materska, M.; Perucka, I. Antioxidant activity of the main phenolic compounds isolated from hot pepper fruit (*Capsicum annuum* L.). *J Agric Food Chem*, 2005, 53(5), 1750-1756. DOI: 10.1021/jf035331k.
- [10] Giampieri, F.; Tulipani, S.; Alvarez-Suarez, J. M.; Quiles, J. L.; Mezzetti, B.; Battino, M. The strawberry: composition, nutritional quality, and impact on human health. *Nutrition*, 2012, 28(1), 9-19. DOI: 10.1016/j.nut.2011.08.009.
- [11] Tulipani, S.; Armeni, T.; Giampieri, F.; Alvarez-Suarez, J. M.; Gonzalez-Paramas, A. M.; Santos-Buelga, C.; Battino, M; Strawberry intake increases blood fluid, erythrocyte and 14 mononuclear cell defenses against oxidative challenge. *Food Chem*, 2014, 156, 87-93. DOI: 10.1016/j.foodchem.2014.01.098.
- [12] Barth, M.; Hankinson, T. R.; Zhuang, H.; & Breidt, F. Microbiological Spoilage of Fruits and Vegetables. In W. H. Sperber & M. P. Doyle (Eds.), *Compendium of the Microbiological Spoilage of Foods and Beverages* (pp. 135-183), 2009, New York, NY: Springer New York.
- [13] Zain, M. E. Impact of mycotoxins on humans and animals. *Journal of Saudi Chemical Society*, 2011, 15(2), 129-144. DOI: 10.1016/j.jscs.2010.06.006.
- [14] Bush, R. K.; Portnoy, J. M.; Saxon, A.; Terr, A. I.; Wood, R. A. The medical effects of mold exposure. *Journal of Allergy and Clinical Immunology*, 2006, 117(2), 326-333. DOI: 10.1016/j.jaci.2005.12.001.
- [15] Chen, C.; Trezza, T. A.; Wong, D. W. S.; Camirand, W. M.; Pavlath, A. E. Methods for preserving fresh fruit and product thereof, United States Patents, US5939117A, 1999.
- [16] Farrier, R. W., & Leavens, R. B. (1977). Process for inhibiting browning of fruit: Google Patents.
- [17] Sharma, J. N. Process of treating fresh fruits and vegetables and compositions for use therein, United States Patents, US3652300A, 1972.
- [18] Nicole, C. C. S., & Schobben, D. W. E. Freshness of fruit and/or vegetables. United States Patents, WO2015150091A1, 2017.
- [19] Uthicke, S.; Fabricius, K.; De'ath, G.; Negri, A.; Warne, M.; Smith, R.; Noonan, S.; Johansson, C.; Gorsuch, H. and Anthony, K. Multiple and cumulative impacts on the GBR: assessment of current status and development of improved approaches for management. Final Report Project 1.6. Report to the National Environmental Science Programme. Reef and Rainforest Research Centre Limited, Cairns, 2016, (144pp.).
- [20] Kemiklioğlu, E.; Ozen, O. "Design of a Sensor to Detect Fruit Freshness. *International Journal of Scientific and Technological Research Journal*, 2018. 4.