

Exhaust Gas Recirculation in Gas Turbines for Reduction of CO₂ Emissions; Combustion Testing with Focus on Stability and Emissions

Petter E. Røkke*
SINTEF Energy Research
N-7465 Trondheim
E-mail: peter.e.rokke@sintef.no

Johan E. Hustad
Norwegian University of Science and Technology
Department of Energy and Process Engineering
N-7491 Trondheim

Abstract

Exhaust gas recirculation can be applied with the intention of reducing CO₂ emissions. When a fraction of the exhaust gas is injected in the entry of a gas turbine, the amount of CO₂ in the exhaust gas not being recirculated will be higher and less complicated to capture. However, with this change in combustion air composition, especially the reduced concentration of oxygen, the combustion process will be affected. The lower oxygen concentration decreases the stability and the increased amount of CO₂, H₂O and N₂ will decrease the combustion temperature and thus, the NO_x emissions. Testing has been performed on a 65 kW gas turbine combustor, to investigate the effect of adding N₂, CO₂ and O₂ in the combustion process, with focus on stability and emissions of NO_x. Results show that adding N₂ and CO₂ decreases the NO_x emissions, whereas O₂ addition increases the NO_x emissions. The tests have been performed both in a diffusion flame (pilot burner) and a premixed flame (main burner), and for additives being injected with the fuel or with the air stream. Addition into the fuel stream is proven to affect the NO_x emissions the most. The stability limits of the flames are indicated with respect to mass-based additive-to-fuel ratios.

Keywords: Exhaust gas recirculation, combustion, NO_x emissions

1. Introduction

Natural gas fired power generation facilities have always been considered as an environmental friendly power source, when compared to other fossil fuel-based power sources such as, for instance, coal-fired power plants. The NO_x and CO emissions from natural gas fired power plants are significantly lower than when coal is applied as fuel. More recently focus has turned onto CO₂ emissions and the effect CO₂ has on the atmosphere. An increased greenhouse effect is proved to have a source in the higher concentration of CO₂ in the atmosphere. CO₂ stems from multiple human generated sources, along with more natural sources or sinks such as photosynthesis. Combustion engines in cars, boats and planes contribute significantly, but the CO₂ from these distributed sources is difficult to handle. CO₂

from larger stationary combustion facilities, such as power plants, can be handled with a CO₂ clean-up system. Several different technologies for CO₂ capture processes are being developed, as described in Bolland O. et al., 2002. Especially the power demanding oil industry is interested in the development of so-called CO₂ free power generation sources. In Norway, the CO₂-tax is a significant motivation for decreasing the CO₂ emissions into the atmosphere.

An alternative technology for CO₂ mitigation is to recirculate the exhaust gas of a simple cycle gas turbine. A part of the exhaust gas can be recirculated to the entry of the gas turbine and mixed with the air. This will change the composition of the combustion air and thus affect the combustion process. Most important with respect to NO_x emissions, the

*Author to whom correspondence should be addressed

recirculated exhaust gas will decrease the O_2 concentration in the combustion air. With regard to CO_2 mitigation, the exhaust gas that is not recirculated will have a higher CO_2 concentration. One of the problems for post-combustion CO_2 separation, where the CO_2 is separated with an amine-process, is the low concentration of CO_2 in the exhaust gas. Thus, the exhaust gas from a recirculation process can give a higher CO_2 capture than for a regular gas turbine exhaust gas.

As mentioned above, the combustion process is affected due to the change in the combustion air composition. For gas turbines today that are operated with low emission combustion systems, most commonly so-called lean premixed systems, the flame stability will be affected by the lower O_2 concentration in the combustion air. Premixed combustion systems are highly dependent on the flame velocity of the mixture, and a decrease in the O_2 concentration of the mixture lowers the flame velocity, (Pourkashanian et al., 1989). A decrease in the O_2 concentration, without further modifications of the system, may then cause blowout of the flame. More conventional combustion systems that are operated with diffusion flames are less sensitive to variations in combustion air composition with regards to flame stability. NO_x emissions for such flames, however, are significantly higher than for lean premix combustion systems.

In gas burners, so-called flue gas recirculation (FGR) is widely applied for reduction of NO_x emissions. Gas burners refer to 3 vol% O_2 in the exhaust gas in contrast to gas turbines that refer to 15 vol% O_2 . In this paper, a gas turbine combustor has been applied for experiments on both a premixed and a diffusion flame with focus on NO_x emissions, and how the addition of O_2 , N_2 and CO_2 affects the NO_x emissions. O_2 , N_2 , CO_2 and H_2O are the main components in a hydrocarbon combustion process. Steam injection has not been applied in these experiments due to the available equipment in the laboratory, preheating to temperatures above $100^\circ C$, for the air supply has not been possible. The effect of steam is thus based on the literature. These experiments will also investigate the importance of O_2 concentration in the recirculated exhaust gas with respect to NO_x emissions.

2. Experimental Setup

A gas turbine combustor is applied for combustion testing. The combustor has the possibility for both diffusion flame (pilot burner) and premixed flame operation (main burner).

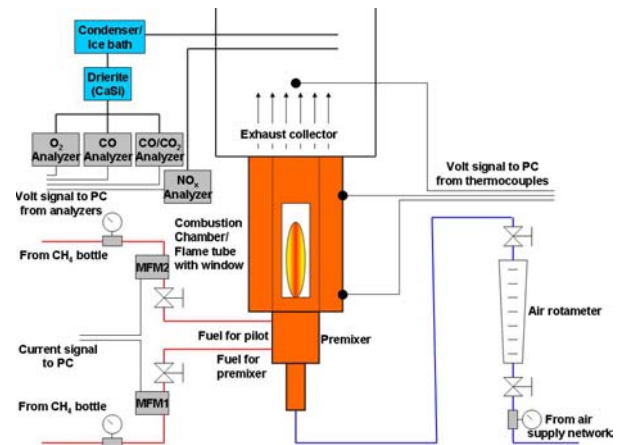

Figure 1. Experimental schematic.

A schematic of the rig is shown in Figure 1.

Two mass flow meters are applied for the addition of two different components (fuel + additive). The additive can either be injected into the air stream or premixed with the fuel. For premixing with the fuel, a mixing chamber with a fine metal grid inside is built for efficient mixing.

A more detailed view on the premixer is shown in Figure 2. The combustion air enters vertically at (1), and flows through a section of 12 airfoil vanes (2) that creates a high swirl (tangential velocity/axial velocity ~ 9). Premixed fuel injection is done through these vanes that are hollow and have four fuel injection holes on the pressure side of each vane. The fuel is distributed in the premix fuel manifold (5). About 2% of the air flows through the center hollow reverse cone (3) for cooling of the perforated bluff-body (4) inside the combustor. The fuel manifold for the diffusion flame (6) distributes the fuel into the combustor through 12 holes.

A photo of the premixer and bluff-body is shown in Figure 3.

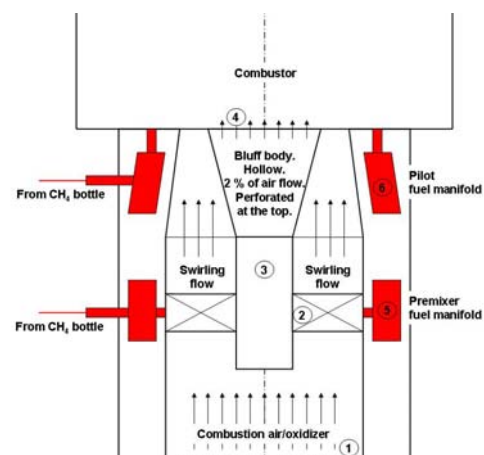

Figure 2. Premixer schematic.



Figure 3. Premixer and bluff-body.

Measurements are performed on surface temperatures of the combustor and the combustion gas. The concentrations of the species in the exhaust gas are measured as indicated in Figure 1. The mass flows of fuel and additive are controlled with needle valves and measured with mass flow meters, whereas the supply of air is controlled by a rotameter. The measured O_2 concentration in the exhaust gas is applied for calculation of exact air-excess ratios. As methane (CH_4) is the main component of natural gas, it is applied as fuel.

3. Experimental Results

The presented values given in this section are average values of at least two repeated runs at selected conditions, ensuring repeatability. The readings are noted when stability has been reached in the measurements.

First, stability limits for operation in diffusion and premixed mode are checked. In Figure 4, the indicated equivalence ratios, where the flame becomes unstable, are shown for operation in diffusion and premixed modes. The air supply is kept constant for each test, and the fuel supply is gradually decreased until the flame becomes unstable. The premixed flame LBO limit occurs at a 0.6 equivalence ratio, whereas the diffusion flame becomes unstable at an equivalence ratio below 0.25. The equivalence ratio (ER) is defined as:

$$ER = \frac{FAR}{FAR_{st}} \quad (1)$$

where FAR is the fuel-to-air ratio.

Further, the emissions of CO and NO_x are measured for the two operation modes. The NO_x emissions are shown in Figure 5. The diffusion flame operation is a swirling co-flow flame, and the air supply to the flame is controlled. Usually, the equivalence ratio is not applied as a measure for diffusion flames, but since this is a confined system, it is an important parameter.

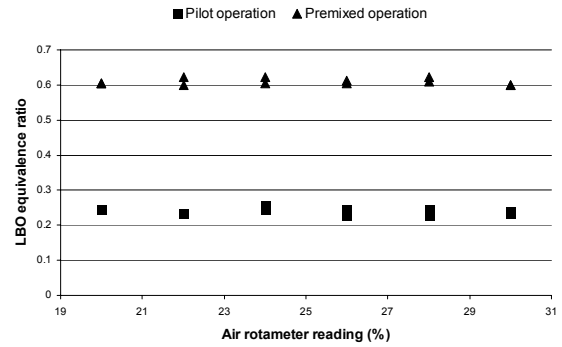

Figure 4. Lean Blowout (LBO) limits for diffusion and premixed operation.

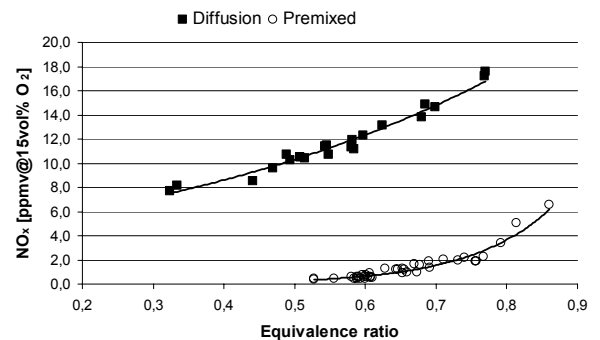

Figure 5. NO_x emissions measured for operation in diffusion and premixed mode.

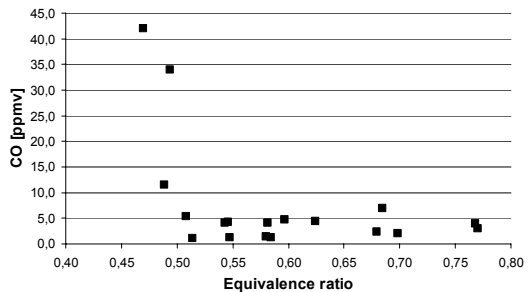

Figure 6. CO emissions for operation in diffusion mode.

The CO emissions measured were in general very low, especially for the premixed flame where the measured CO was below 3 ppmv for all equivalence ratios. For the diffusion operation, the CO emissions increased significantly when approaching equivalence ratios below 0.5, as shown in Figure 6.

Thus, the points for NO_x emissions below the 0.5 equivalence ratio for diffusion operation are doubtful due to the high amounts of CO in the exhaust products. However, the higher NO_x emissions for diffusion operation than for those of the premixed operation are not to be questioned.

The increase in NO_x emissions at higher equivalence ratios is expected. Increasing the

equivalence ratio gives a more fuel rich flame with a higher flame temperature. A higher temperature affects the NO_x formation mainly through the thermal mechanism (Zel'dovich et al., 1947). The increase in CO emissions at lean condition is caused by lower reaction ratios for the oxidation of CO to CO_2 at lower flame temperatures.

A diffusion flame will always have a flame surface with a stoichiometric fuel-air composition. Thus, at the flame surface the temperature will be significantly higher than in a premixed flame where the overall equivalence ratio is leaner than stoichiometry, i.e. higher NO_x emissions in diffusion flames.

In the case of exhaust gas recirculation, an interesting issue is to see if NO_x emissions of diffusion operation can be reduced to premixed operation levels.

The results given in *Figure 7* show how the different additives affect the NO_x emissions in the diffusion operation. The points with the highest additive-to-fuel ratio indicate stability limits where the flame becomes unstable due to the amount of additive being injected (not the actual blow-out limits). It is seen that the unstable flame occurs at lower ratios when the additive is premixed with the fuel than with the air stream. Even for O_2 enrichment of the flame, a stability limit is approached already before an additive-to-fuel ratio at unity.

For additives being injected into the fuel stream, the flame is lifted when more additive is injected. This is due to the increased jet velocity out of the fuel nozzles. Also, the different additives have different molar weights, and thus, the molar additive-to-fuel ratio must be considered. TABLE I shows the values for the stability limits referred to in *Figure 7* for the mass-based values.

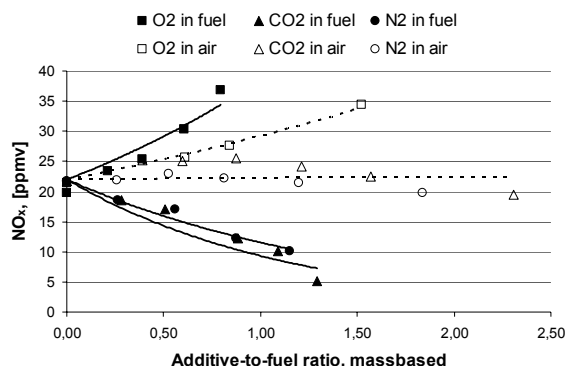

Figure 7. Additives effect on NO_x emissions in diffusion operation.

TABLE I. COMPARISON OF MASS- AND MOLAR-BASED STABILITY LIMIT ADDITIVE-TO-FUEL RATIOS.

	Mass	Molar
O_2/CH_4	0.79	0.40
CO_2/CH_4	1.29	0.47
N_2/CH_4	1.15	0.66

Premixing the additive with the fuel affects the NO_x emissions more than when injected with the air stream. Oxygen enrichment of the flame increases the NO_x emissions, both when injected with the fuel stream and with the air stream. When premixed with the fuel, the NO_x emissions are doubled already at an oxygen-fuel ratio below unity. CO_2 and N_2 injections seem to have quite similar effects on the NO_x emissions. A significant decrease is seen when premixed with the fuel, whereas the addition into the air stream has less effect on the NO_x emissions.

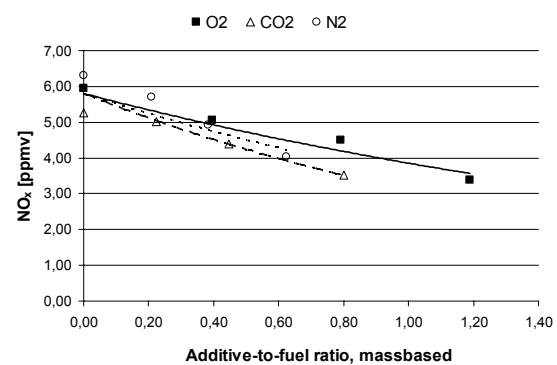

Figure 8. Additives effect on NO_x emissions in premixed operation.

The results from the experiments where the additives were injected into the flame in premixed operation are shown in *Figure 8*. Injection of additives into the premixed operation of the flame is not affected by the injection point of the additive. The fuel and air mixture is well mixed. For all additives, the NO_x emissions decrease similarly. Even for oxygen addition to the fuel stream a decrease is seen. This is explained by the fact that for a well mixed premixed flame, operating lean, extra oxygen addition will only make the flame leaner, and the NO_x emissions will thus decrease.

The specific heat for the components of an exhaust gas is shown in TABLE II.

TABLE II. SPECIFIC HEAT (C_p) VALUES FOR H_2O , CO_2 , N_2 AND O_2 FOR DIFFERENT TEMPERATURES [kJ/kg.K] – INCLUDED FOR INFORMATION/REFERENCE.

T [K]	H_2O	CO_2	N_2	O_2
250 K	liquid	0.782	1.044	0.910
1000 K		1.232	1.167	1.085
2000 K		1.371	1.287	1.180

Steam has significantly higher specific heat than the other components and will surely affect the flame temperature in a larger degree than the other additives if evaluating only the thermal effect. The evaluation of the NO_x chemistry is similarly important. The thermal mechanism is often described by the following reaction as the rate determining step (Zel'dovich et al., 1947)

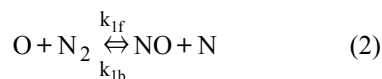

Thus, the N₂ concentration in the flame is of main importance. It is referred to as the thermal NO_x formation mechanism because it is highly dependent on the temperature, especially at temperatures above 1850 K (Lefebvre, 1998). The prompt mechanism is determined by the sudden cracking of hydrocarbons in the flame, with the following reaction as the main (Fenimore, 1971):

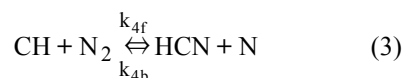

The radical (CH) concentration is dependent on the temperature, and as for the thermal mechanism, the N₂ concentration is important. The principal reaction of the nitrous oxide mechanism is:

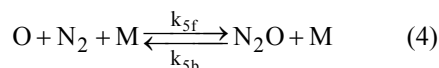

Due to the third body dependence, this mechanism has more influence at increased pressure (Drake and Blinth, 1991).

The results indicate that the flame being analyzed here is affected by the thermal effect when CO₂ or N₂ is added, since both have quite similar effects on the NO_x emissions. It is indicated in Liu et al. (2003) that CO₂ may affect the NO_x formation mechanism. The CO₂ added will change the equilibrium of the CO+OH↔CO₂+H reaction to the left, and thus compete with the H+O₂↔O+OH reaction for the H-atom. Fewer radicals in the flame are due to the lower temperatures, and thus fewer NO_x emissions. The specific heats are quite similar for the two components, and thus the chemical effect is indicated to be less important for such a flame. The oxygen enrichment of the diffusion flame affects the chemical kinetics through the increased oxygen content in the flame, and also that the mixture turns towards a fuel-oxygen mixture rather than a fuel-air mixture. The properties of a CH₄-O₂ flame are significantly different from those of a CH₄-air flame as described in TABLE III.

TABLE III. DIFFERENT FLAME PROPERTIES FOR CH₄ COMBUSTION IN OXYGEN OR IN AIR.

Stoichiometric	CH ₄ -O ₂	CH ₄ -Air
Flame temperature(K)	~3800	~2600
Flame velocity (cm/s)	330	40

The flame temperatures are calculated for atmospheric conditions (Kee et al., 1985) and the flame velocities from Pourkashanian et al. (1983). Thus, the thermal NO_x formation mechanism gives higher NO_x emissions with an increased amount of oxygen enrichment. As previously mentioned, the oxygen addition in the lean premixed flame, however, acts as a diluent.

4. Exhaust Gas Recirculation

The experiments performed here are with additions of the components of an exhaust gas separately. Limitations in the laboratory have excluded the possibility for injection of all components of an exhaust gas to simulate the actual combustion environment in such a process. The effect the reduction of O₂ concentration in the combustion air has on the blowout limits has been tested in Wheeler (2001), indicating blowout for combustion air with less than 13.5 vol% O₂. In Bolland et al. (1997), it is said that 16-18 vol% O₂ is required for stability. The reduction in the flame velocity for some hydrocarbon fuels as a function of the oxygen concentration (in an oxygen-nitrogen mixture) is shown in Glassmann (1996), indicating a significant reduction when the oxygen concentration is reduced. The temperature change in the flame will also affect the combustion stability, lower temperature reduces the reaction rates, and the reaction may become too slow to maintain stability. This is, however, not likely to affect the stability as much as the oxygen concentration and the flame velocity. The change in temperature is more likely to affect the NO_x emissions. As mentioned, the temperature affects both the prompt and (especially) the thermal NO_x formation mechanisms. The composition of the combustion air will have different bulk specific heats and a specific heat ratio, which will give a change in the combustor inlet temperature and pressure. A change in the inlet temperature gives a corresponding change in the flame temperature (~half the change). This, along with the flame temperature change due to the additives, will influence the NO_x emissions.

The experiments performed with the additives being injected separately can be applied for correlating the recirculation of an exhaust gas. The trendlines can be extracted from the curves shown above and correlated in a single equation. The correlated trendlines for the different additives are as follows, based on the

effect on NO_x emissions when the additive is premixed with the fuel for the diffusion flame:

$$\frac{\text{NO}_{x,\text{O}_2}}{\text{NO}_{x,0}} = e^{0.56 (\text{O}_2/\text{CH}_4)_m} \quad (5)$$

$$\frac{\text{NO}_{x,\text{N}_2}}{\text{NO}_{x,0}} = e^{0.64 (\text{N}_2/\text{CH}_4)_m} \quad (6)$$

$$\frac{\text{NO}_{x,\text{CO}_2}}{\text{NO}_{x,0}} = e^{0.86 (\text{CO}_2/\text{CH}_4)_m} \quad (7)$$

Steam injection into the combustor, premixed with the fuel in a diffusion flame, has been investigated in the Cheng Low NO_x process (Sahai et al., 2003). With emphasis on homogeneity in the fuel-steam mixture, NO_x reduction has been proven without increasing the CO emissions. A decrease in the homogeneity of the fuel-steam mixture would increase the CO emissions significantly. From the results shown for NO_x emissions as a function of steam injection in Sahai et al. (2003), a trendline can be extracted as follows:

$$\frac{\text{NO}_{x,\text{H}_2\text{O}}}{\text{NO}_{x,0}} = e^{0.90(\text{H}_2\text{O}/\text{CH}_4)_m} \quad (8)$$

Now, these four equations (5), (6), (7), and (8) can be combined into one expression for the modeling of an exhaust gas recirculation process. This can be done as shown here:

$$\text{NO}_{x,\text{total}} = w_{\text{CO}_2} \text{NO}_{x,\text{CO}_2} + w_{\text{H}_2\text{O}} \text{NO}_{x,\text{H}_2\text{O}} + w_{\text{O}_2} \text{NO}_{x,\text{O}_2} + w_{\text{N}_2} \text{NO}_{x,\text{N}_2} \quad (9)$$

where w_i are coefficients for the different additives that may be adjusted due to the influence of the additives. The denominator ($\text{NO}_{x,0}$) is already eliminated since it is the same for all additives, and also for the total exhaust gas recirculation process. The w_i coefficients have been fixed at 0.25 if similar influence from the additives is assumed. If the recirculated exhaust gas is free of oxygen (from a stoichiometric combustion process), the coefficients for CO_2 , H_2O and N_2 are simplified and fixed at 0.33, and the w_i coefficient for O_2 at zero. In the case of air addition (partially premixed flame), the w_i coefficients for O_2 and N_2 are fixed at 0.5 and the rest at zero. This approximation of the w_i coefficients is a simplification, and a further study to relate these coefficients to the additives influence on the NO_x emissions will be of interest to increase the accuracy.

The composition of the exhaust gas will vary due to the air excess ratio ($\lambda = 1/\text{equivalence ratio}$) in the combustion process. Gas turbines operate with an overall air excess ratio in the range from 3-4 which gives 13-15 vol% O_2 in the exhaust gas. For the recirculation

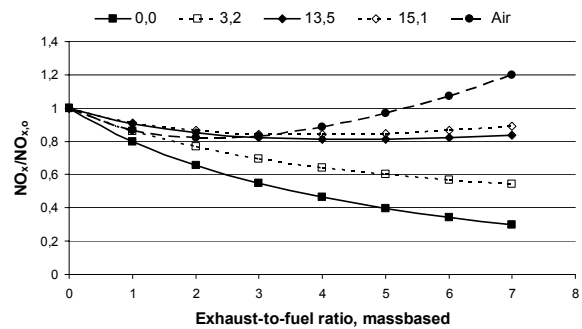

Figure 9. NO_x emissions as function of exhaust-to-fuel ratio in the combustion process for the diffusion flame. The different curves describe exhaust gas with the specified concentration of oxygen.

of exhaust gas, the concentrations of O_2 , N_2 , CO_2 and H_2O are calculated, which is required for predictions based on equation (9).

Equation (9) is applied with fixed w_i coefficients (as explained above) for varying exhaust gas recirculation ratios, and the predicted NO_x emissions varies as shown in Figure 9, dependent on the amount of oxygen in the recirculated gas. The lower line, with the most efficient NO_x reduction, is with exhaust gas from a complete combustion process (no oxygen). On the opposite side, applying pure air, with 20.9 vol% oxygen, gives an optimum “additional air”-to-fuel ratio (exhaust-to-fuel ratio in the figure) of around 3. This is then the case for a partially premixed combustion process. The curves indicate that for the cases with higher oxygen concentrations, an optimum exhaust-to-fuel ratio can be found, approaching 3 for the partially premixed case. It is seen that for 15 vol% O_2 content in the exhaust gas, which is reference for gas turbine processes, a 20% decrease in NO_x emissions can be achieved. A 20% decrease in NO_x emissions in the diffusion operation mode is far from the levels achieved in the premixed operation. In the case of gas burners, 3 vol% O_2 is the reference value. Thus, it is seen that a 40% decrease in NO_x emissions can be achieved with an exhaust-to-fuel ratio at 7 for such applications. For gas turbines, the improvement potential points towards methods that can reduce the oxygen content of the recirculated exhaust gas, which will further reduce the NO_x emissions. O_2 can, for instance, be separated from the exhaust gas, which is a costly process. A less costly alternative is to supply additional fuel for afterburning, which will reduce the oxygen content further.

The advantage for NO_x emissions in diffusion flames with exhaust gas recirculation is not comparable to premixed flame NO_x levels. But with the emphasis on increasing the CO_2 concentration in the exhaust gas, the 20%

reduction in NO_x emissions is a positive side-effect. Post combustion CO₂ capture processes may be suited to absorb the NO_x in the exhaust gas, and thus the NO_x emissions can be avoided for such a process.

5. Conclusions

Experiments have been performed on a gas turbine combustor with the emphasis on stability and NO_x emissions. The combustor has been operated both in diffusion mode and premixed mode, proving that a lean premixed operation is significantly more advantageous for low NO_x emissions.

To simulate the effect of the components of an exhaust gas on stability and NO_x emissions, experiments have been performed with the addition of O₂, N₂ or CO₂ injected either into the fuel or into the air stream. Steam injection has been referenced from the literature. Oxygen enrichment of the diffusion flame increases the NO_x emissions, both when injected into the fuel and into the air stream, whereas N₂ and CO₂ act as diluents. For injection into the fuel of the diffusion flame, a decrease in NO_x emissions is seen, whereas a negligible change in NO_x is seen when injected into the air stream. All additives act as diluents when injected into a lean premixed flame.

Modeling of exhaust gas recirculation has been done based on the experiments with the additives injected separately. This indicates that the amount of O₂ in the exhaust gas plays an important role, concerning the NO_x emissions, with the change in composition of the combustion air.

Nomenclature

C _p	specific heat [kJ/kgK]
CH ₄	methane
CO	carbon monoxide
CO ₂	carbon dioxide
H ₂ O	steam
K	chemical equilibrium constant
NO _x	oxides of nitrogen
N ₂	nitrogen gas
O ₂	oxygen gas
T	temperature [K]
w	weighted coefficients [-]

Subscripts

0	initial (without additives)
b	backward reaction
f	forward reaction
i	additive "i"

m	mass-based
st	stoichiometric

References

References

- Bolland, O., Hagen, R. I., Maurstad, O., Tangen, G., Juliussen, O., Svendsen, H., 2002, "Gasskraftverk med CO₂-håndtering. Studie av alternative teknologier", *SINTEF Technical Report* TR A5693. In Norwegian only.
- Bolland, O. and Mathieu, P., 1997, "Comparison of Two CO₂ removal Options in Combined Cycle Power Plants", *Energy Conversion and Management*, 39 (16-18), p. 1653-1663.
- Drake, M. C. & Blint, R. J., 1991, "Relative Importance of Nitric Oxide Formation Mechanisms in Laminar Opposed-flow Diffusion Flames", *Comb. Flame* 83:185-203.
- Fenimore, C. P., 1971, "Formation of Nitric Oxide in Premixed Hydrocarbon Flames", *13th Symp. Comb.*, pp. 373-379.
- Glassmann, I., 1996, *Combustion*, 3rd edition, p. 159, Academic Press Inc.
- Kee, R.J., Grcar, J.F., Smooke, M.D., Miller, J.A., 1985, "A Fortran program for modeling steady laminar onedimensional premixed flames", Sandia Report SAND 85-8240.
- Lefebvre, A. H., 1998, *Gas Turbine Combustion*, Taylor & Francis Ltd, Printed by Edwards Brothers, Ann Arbor, MI.
- Liu, F., Guo, H., Smallwood, G. J., 2003, "The chemical effect of CO₂ replacement of N₂ in air on the burning velocity of CH₄ and H₂ premixed flames", *Comb. Flame* 133:495-497.
- Pourkashanian, M., Yapp, L., Williams, A., 1989 "The use of oxygen enrichment in combustion technology", *Applied Energy Research, Proceedings of the Institute of Energy Conference held in Swansea, UK, 5-7 September*.
- Sahai, V., Cheng, D. Y., 2003, "Reduction of NO_x and CO to Below 2ppm in a Diffusion Flame", *ASME GT* 2003-38208.
- Wheeler, R. V., 1955, "The Effects of Incombustible Gases", slide in course material from "Ultra Low NO_x Gas Turbine Combustion" at Leeds University, January 2001.
- Zel'dovich, Y. B., Sadovnikov, P. Y., Frank-Kaminetskii, D. A., Shelef, M., 1947, Trans., Academy of Sciences of USSR, Inst of Chem Physics, Moscow-Leningrad.