



- RESEARCH ARTICLE -

Mitochondrial Genetic Diversity of Bat Species from the Maltese Islands and Applications for their Conservation

Clare Marie Mifsud, Adriana Vella*

Conservation Biology Research Group, Biology Department, University of Malta, Msida, Malta

Abstract

This work presents the first genetic species identification and phylogenetic analyses of all six bat species known to inhabit the Maltese archipelago. The results provide a DNA-based reference library of 12S rRNA, 16S rRNA, COI, Cytb and ND1 mitochondrial sequences for Maltese bat species. Phylogenetic analyses revealed that the Maltese bat populations do not harbour cryptic diversity. Analyses of genetic diversity for Maltese bat species showed contrasting matrilineal diversity between species, *Hypsugo savii* exhibited the highest haplotype diversity ($H_d = 0.802$), while *Rhinolophus hipposideros* showed no haplotype diversity and *Plecotus gaisleri* exhibited low values for haplotype diversity ($H_d = 0.091$). Comparative phylogeographical analyses of mtDNA gene datasets from this study with sequences of conspecific bat populations outside of Malta indicate that mitochondrial haplotypes of *Pipistrellus pipistrellus* and *Rhinolophus hipposideros* are unique to the Maltese Islands. *Hypsugo savii*, *Pipistrellus kuhlii*, *Myotis punicus* and *Plecotus gaisleri* shared the most common mitochondrial haplotype with surrounding geographical areas, including the Ibero-Maghreb region, the Apennine Peninsula and Sicily. The observed genetic diversity and phylogenetic relationships are discussed in the context of the species' biology and long-term conservation planning of Maltese bat populations.

Keywords:

Mitochondrial DNA, Genetic diversity, DNA barcoding, Bat conservation, Insular populations

Article history:

Received 01 July 2019, Accepted 29 October 2019, Available online 30 October 2019

Introduction

Molecular tools allow the identification of distinct mitochondrial lineages, some lineages within Western Palaearctic bat species also exhibit distinct ecology and morphology, supporting their status as separate species (Kiefer & Veith, 2001; von Helversen et al., 2001; Mucedda et al., 2002;

* Corresponding Author: Adriana Vella, E-mail: adriana.vella@um.edu.mt

Benda et al., 2004; Juste et al., 2004, 2019; Puechmaille et al., 2014). Although mtDNA aids the discovery of diverging lineages, these might not always confirm the presence of cryptic taxa, as exemplified by the case of *Pipistrellus kuhlii* (Andriollo et al., 2015). MtDNA studies are especially useful when combined with other molecular markers, ecological, morphological and acoustic data (Juste et al., 2013; Puechmaille et al., 2014) as this combined information can be used to identify evolutionary significant units (ESU) or management units (MU) to assist in setting up conservation priorities for island populations (Robertson et al., 2014). Correct bat species identification, using acoustic, morphometric and molecular techniques, is also key to biodiversity conservation, as it allows better understanding of the species-specific ecology, behaviour, distribution, and conservation status (Balakrishnan, 2005; Arif et al., 2011; Salicini et al., 2011).

One of the latest published research on bats from Malta has confirmed through acoustic and morphological analyses the presence of six resident bat species (Mifsud & Vella, 2018) representing species within genera which showed signs of cryptic diversity when studied across the Western Palaearctic using molecular techniques (Ibáñez et al., 2006; Spitzenberger et al., 2006; Mayer et al., 2007; García-Mudarra et al., 2009; Bogdanowicz et al., 2015). Previous acoustic surveys of bats from Malta revealed sensory divergence for the species *Pipistrellus pipistrellus* and *Rhinolophus hipposideros* when compared to their mainland conspecifics (Mifsud & Vella 2018), and therefore the addition of molecular data to the morphological and acoustic data available would further uncover the evolutionary significance of bat populations present in the Maltese Islands.

The present study therefore aims at investigating mtDNA characteristics of bat species from Malta: (1) to generate a DNA-based reference library for species identification; (2) to explore the genetic structure and diversity; and (3) to identify the evolutionary lineages of Maltese bats with the ultimate aim to support the long-term conservation planning of bat populations.

Material and Methods

Mist netting and tissue sample collection

Mist netting was conducted to capture bats from 20 sites in Malta and Gozo between February 2016 and October 2018. Captured bats were identified based on morphology following Dietz & von Helversen (2004) and Benda et al. (2004).

Wing membrane biopsies were obtained from 120 individuals representing all bat species known to occur in the Maltese Islands, including: *Hypsugo savii* ($n = 23$); *Myotis punicus* ($n = 19$); *Pipistrellus kuhlii* ($n = 5$); *Pipistrellus pipistrellus* ($n = 25$); *Plecotus gaisleri* ($n = 29$); and *Rhinolophus hipposideros* ($n = 19$). Two wing membrane biopsies were taken from each captured bat individual using a sterile and disposable 4-mm diameter biopsy punch tool (Kai Medical). Biopsy punches were taken from each plagiopatagium without puncturing major blood vessels and following Worthington Wilmer & Barratt (1996). All wing membrane biopsies were stored in desiccated silica gel beads (Merck) at -80°C , until genomic DNA was extracted. Biopsy punches were also obtained from voucher specimens stored at -80°C under the care of the Conservation Biology Research Group, University of Malta.

DNA extraction, PCR amplification and sequencing of five mitochondrial genes

Total genomic DNA was extracted from one 4-mm diameter wing membrane biopsy punch following the GF-1 Tissue DNA Extraction Kit (Vivantis, Malaysia) protocol. The eluted DNA was then stored at -20°C until required for PCR amplification. Five primer pairs were used to amplify five mitochondrial genes with a total of 3815 bp of the mitochondrial DNA (see supplementary material Table S3 for primer details).

PCR amplification was carried out in 25 µL reaction volume containing approximately 50ng DNA template, 1X FIREPOL[®] Master Mix containing 2.5 mM Mg²⁺, 200 µM of each dNTP and 1 U FIREPOL[®] DNA polymerase (Solis BioDyne, Estonia), 5 ng Bovine Serum Albumin (NEB, USA), and 0.5 µM of each primer. PCRs were carried out on a Nexus Gradient Mastercycler[®] (Eppendorf, Germany) using the following temperature profile for 16S, 12S, Cytb and COI genes: 95 °C for 5 min; followed by 35 cycles of 95 °C for 45 s, 50 °C for 30 s, 72 °C for 1 min and final extension at 72 °C for 15 min. For the ND1 gene the temperature profile was set to 95 °C for 5 min; followed by 37 cycles of 95 °C for 45 s, 52 °C for 30 s, 72 °C for 1 min 30 s and final extension at 72 °C for 15 min. From each PCR reaction, 2 µL of the PCR product was visualised on a 1.5% agarose gel stained with ethidium bromide, together with a 100 bp DNA ladder (Solis BioDyne, Estonia). PCR products showing amplified products of correct size, were subsequently purified and sequenced with the respective forward and reverse primers with ABI3730XL sequencer.

Mitochondrial DNA sequence analyses

All mtDNA sequences were manually trimmed to remove primer nucleotide sequences, checked for ambiguous peaks in chromatograms and complementary sequences for each individual were assembled. Multiple sequence alignments were produced for each gene and bat species independently. Additionally, a multiple locus alignment was made using concatenated genetic data of specimens that were successfully sequenced for all five mtDNA loci. The complete mitochondrial genome of *Tadarida teniotis* [KY581661] was aligned, trimmed accordingly and included as an outgroup taxon for the separate gene datasets and the concatenated dataset. Sequences were edited, aligned using MUSCLE (Edgar, 2004) with default parameters, and concatenated using Geneious[®] 11.1.2 (Kearse et al., 2012). The number of variable sites and parsimony informative sites were calculated using MEGA7 (Kumar et al., 2016).

To assess whether individuals sampled form a monophyletic lineage concordant with current taxonomic delineations, phylogenetic trees were constructed for each gene separately and for the concatenated mtDNA dataset. Phylogenetic relationships were estimated using the Neighbor-Joining (NJ) method (Saitou & Nei 1987) and maximum likelihood (ML) analyses as heterogeneous evolutionary rates among sites was revealed by topological incongruencies between the different gene trees and by performing a partition-homogeneity (ILD) test ($p > 0.05$) implemented in PAUP* 4.0a (Swofford, 2002). PartitionFinder2 (Lanfear et al., 2017) was used to estimate the best partitioning scheme using the greedy algorithm (Lanfear et al., 2012) and the best fitting nucleotide substitution model was selected according to the corrected Akaike Information Criterion (AICc). Data partitioning and evolutionary model selection were performed using CIPRES Science Gateway (Miller et al., 2010).

Genetic diversity at species level was quantified using the concatenated gene dataset by calculating the number of haplotypes (h), haplotype diversity (Hd), nucleotide diversity (π) and the number of segregating sites (s) with DnaSP v6 (Rozas et al., 2017).

The mitochondrial lineages of Maltese bat populations were examined using phylogenetic trees by including available sequences of these species from GenBank and BOLD. Multiple sequence alignments for each species was produced for each mtDNA locus when sequence data was available. Sequences of protein-coding genes containing ambiguous bases and codons were not included. Multiple sequence alignments for phylogenetic trees contained only unique haplotypes identified using DnaSP v6 (Rozas et al., 2017). Multiple sequence alignments were produced using MUSCLE (Edgar, 2004) with default parameters as implemented in Geneious[®] 11.1.2 (Kearse et al., 2012).

ML phylogenetic trees were computed using the best fitting nucleotide substitution model for each dataset. ML trees were inferred using the Nearest-Neighbor-Interchange (NNI) heuristic search. Reliability of NJ and ML phylogenies was evaluated by estimating branch support using 1000 bootstrap replications (Felsenstein, 1985). Intraspecific and interspecific genetic distances were estimated using the p -distance model (Nei & Kumar, 2000). Alignment positions containing gaps and missing data were not included in the analyses. NJ, ML and genetic distances were estimated using MEGA7 (Kumar et al., 2016).

Haplotype networks were used to explore the genetic relationships between bat populations from Malta and those from surrounding geographical areas. Haplotype networks were produced using a mtDNA gene dataset containing a representative sample of reference nucleotide sequences from geographical areas surrounding the Maltese Islands. Parsimony-based haplotype networks were constructed using the package pegas (Paradis, 2010) in RStudio v1.1.447 (Boston, USA). Accession numbers of sequences obtained from GenBank and BOLD included in haplotype networks and sequence divergence analyses are given in Appendix S1.

Results

All five mtDNA genes were successfully sequenced for 87 of 120 sampled bats. All multiple sequence alignments showed no evidence of heteroplasmy and are assumed to be of mitochondrial origin. The resulting mtDNA sequences were submitted to GenBank (Accession numbers: 12S rRNA, MN028537-651; 16S rRNA, MN028652-770; COI, MN031753-870; Cytb, MN045532-634; ND1, MN158219-324). The concatenated gene sequence alignment of 87 bats was composed of 2648 bp with 1011 variable sites of which 1007 were parsimony informative.

Genetic species identification and diversity

Both NJ and ML phylogenetic trees formed distinct and well-differentiated monophyletic groups for each bat species sampled and there is no sign of cryptic diversity within the Maltese bat species. The phylogenetic reconstructions from the two data partitions differed in the placement of two species; *Myotis punicus* and *Plecotus gaisleri* (Figure 1).

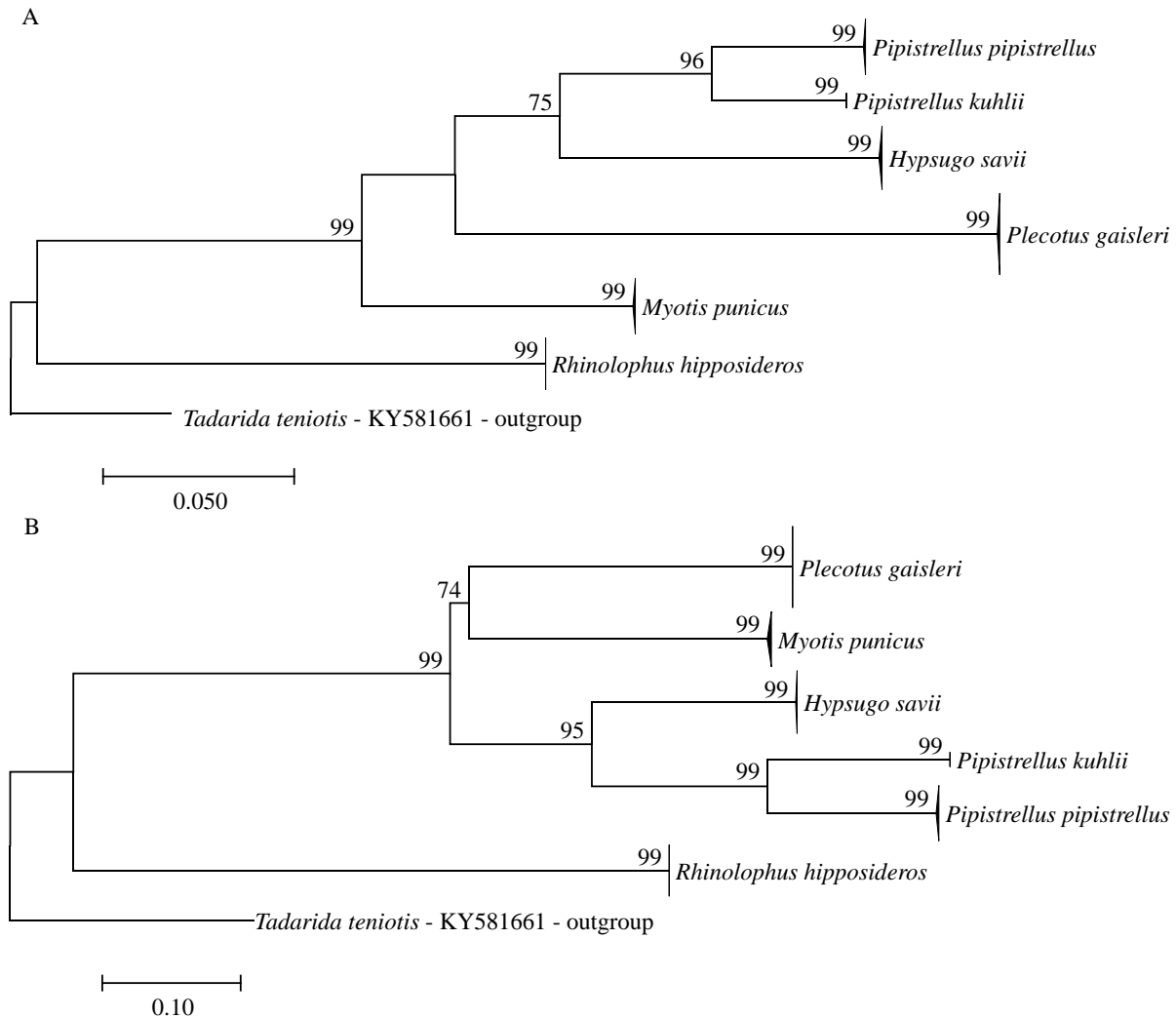

Figure 1. Maximum likelihood (ML) phylogenetic trees based on partitioned mtDNA datasets of 87 sequences and an outgroup sequence. Branch support values are shown if >50%. The scale bars represent the number of substitutions per site. (A) Phylogenetic tree estimated using the 12S rRNA, tRNA-Leu and 1st codon positions of protein-coding genes using the GTR+G model. A total of 909 positions were included in this dataset. (B) Phylogenetic tree estimated using the 16S rRNA, 2nd and 3rd codon positions of protein-coding genes using the GTR+G+I model. A total of 1714 positions were included in this dataset.

The mitochondrial genetic diversity of bat species from Malta is indicated using various genetic diversity indices (Table 1). The haplotype and nucleotide diversity show that *Hypsugo savii* exhibits the highest matrilineal genetic diversity, followed by *Myotis punicus* and *Pipistrellus pipistrellus*. *Plecotus gaisleri* shows an overall low genetic diversity. Conversely, *Pipistrellus kuhlii* and *Rhinolophus hipposideros* show no genetic diversity based on 2648 bp of mtDNA.

Table 1. Molecular diversity statistics of bat species based on the concatenated mtDNA dataset of the 12S, 16S, tRNA-Leu, COI, Cytb and ND1 gene fragments.

Species	<i>n</i>	<i>h</i>	<i>s</i>	$H_d \pm SD$	$\pi \pm SD$
<i>Hypsugo savii</i>	17	8	16	0.802 ± 0.081	0.0015 ± 0.0002
<i>Myotis punicus</i>	15	4	12	0.552 ± 0.137	0.0014 ± 0.0005
<i>Pipistrellus kuhlii</i>	4	1	0	0	0
<i>Pipistrellus pipistrellus</i>	15	3	10	0.448 ± 0.134	0.0007 ± 0.0003
<i>Plecotus gaisleri</i>	22	2	1	0.091 ± 0.081	0.0001 ± 0.0001
<i>Rhinolophus hipposideros</i>	14	1	0	0	0

n, number of individuals included in the concatenated dataset; *h*, number of observed haplotypes; *s*, number of segregating sites; H_d , haplotype diversity ± 1 SD; π , nucleotide diversity ± 1 SD.

Mitochondrial lineages and haplotype relationships

Hypsugo savii

On analysing our ND1 sequences together with previously published sequences of *Hypsugo savii* from the Western Palaearctic, three diverging mitochondrial lineages were obtained and show an average *p*-distance of $8.3 \pm 0.9\%$. These lineages correspond to (1) a western Mediterranean clade, (2) an eastern Mediterranean clade and (3) an Ibero-Maghreb and Central Mediterranean clade. Clade 1 and Clade 2 are more closely related to each other than to Clade 3. Specimens from Malta clustered with Clade 3 based on ML and NJ phylogenetic trees. The three diverging lineages were also revealed by phylogenetic trees based on Cytb, 16S and COI sequences with an average *p*-distance ranging from 3.5 – 4.8%, 6.3 – 8.9% and 9.4 – 10.4% between the three lineages for 16S, COI and Cytb, respectively. The 16S phylogenetic tree revealed a closer relationship between the western and the Ibero-Maghreb clade (Figure 2A), while for COI the western and eastern clades were more closely related (Figure 2B).

The results also reveal the presence of the Ibero-Maghreb lineage in Turkey [HQ848776] based on the 16S fragment, and the presence of this lineage in Switzerland [ABBWP005-06 and ABBWP089-06] based on COI sequences. This indicates sympatry of the Ibero-Maghreb and the western clade in Switzerland, with both lineages being sampled c. 4km apart based on geographical coordinates available on BOLD for the three Swiss COI sequences. The 16S phylogenetic tree indicates the presence of the Ibero-Maghreb clade in Turkey, while the presence of the eastern clade in Turkey is revealed by analyses of the ND1 gene.

Phylogenetic trees for 16S, COI and ND1 show that at least one of the haplotypes recovered from Malta is shared with other *H. savii* populations. The relationships between the ND1 haplotypes within the Ibero-Maghreb and Central Mediterranean clade were further inspected through a haplotype network (Figure 6A). The most common ND1 haplotype recovered from Malta and Italy is shared, with all other haplotypes from Malta radiating from this ancestral haplotype. All haplotypes from Malta and Italy are connected by less than four mutations except for one Italian haplotype which is distant by 10 mutational steps. Given that the number of samples collected from Italy and Malta were similar, the genetic diversity between these two populations was compared. The haplotype diversity (π) for the Maltese and Italian *H. savii* population was 0.7714 and 0.2714, respectively. The 21 individuals of *H. savii* from Malta and Gozo were sampled from 5 locations

being 8 – 36 km apart, while samples from Italy were collected from 8 sampling areas separated by c. 27 – 300 km (Bogdanowicz et al., 2015).

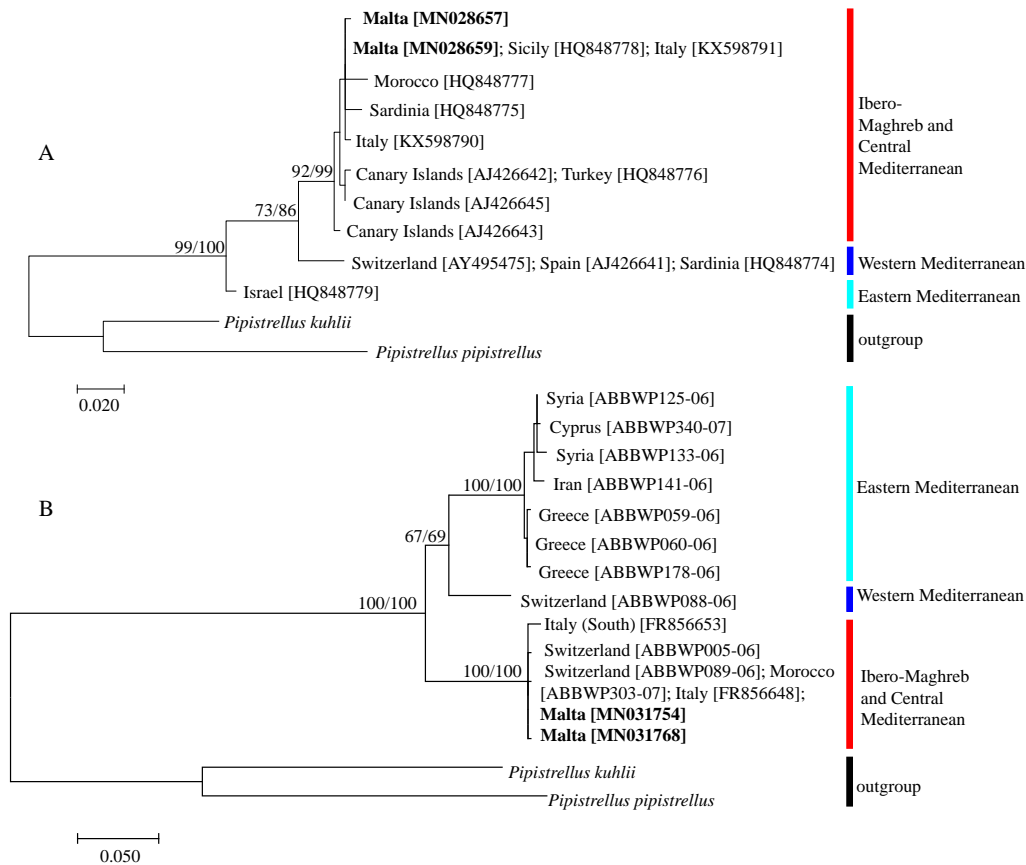

Figure 2. ML phylogenetic trees for *Hypsugo savii*. ML/NJ branch support values are shown if >50%. Sequences generated from this study are marked in bold. The scale bar represents the genetic distance measured in the number of substitutions per site. (A) ML phylogenetic tree based on 451 bp of 16s rRNA sequences estimated using the GTR+G model. (B) ML phylogenetic tree based on 556 bp of COI sequences estimated using the Tamura-Nei model with a proportion of invariable sites (TN93+I).

Pipistrellus pipistrellus

Phylogenetic relationships of *Pipistrellus pipistrellus* haplotypes across the Western Palaearctic using partial sequences of the 16S rRNA were analysed by Veith et al. (2011). Adding our data to previously sequenced samples recovered the same phylogenetic relationships with a clear presence of two mitochondrial lineages, one corresponding to samples from mainland Europe up to Turkey (*P. pipistrellus* s.str.), and a second lineage present in North Africa (Morocco) and central Mediterranean (including Sardinia, Sicily and Malta) referred to as *P. pipistrellus* SW lineage in Hulva et al. (2010). The 16S rRNA dataset from Malta formed two haplotypes which are not shared with any other haplotypes retrieved from GenBank. The unique haplotypes from Malta showed genetic distances of 2.2 ± 0.6 % with *P. pipistrellus* s.str. and 1.0 ± 0.4 , 0.9 ± 0.4 and 0.3 ± 0.2 % with haplotypes from Sardinia, Morocco and Sicily, respectively. The 12S rRNA sequences of *P. pipistrellus* from Malta formed one haplotype. The presence of two mitochondrial lineages is also

evident using the 12S dataset as two haplotypes from Switzerland [AF326105] and [HM561630] showed a genetic distance of 3.2% and 0.5% to the Maltese haplotype, respectively.

COI sequences of *P. pipistrellus* from Malta formed a distinct group, with an average p -distance of 2.6 ± 0.6 % to sequences available on BOLD and GenBank and a minimum of 12 mutations to the closest haplotype from Switzerland. The sequences from this study represent the first COI sequences of *P. pipistrellus* SW mitochondrial lineage. The ND1 dataset including sequences from Malta and those analysed by Bogdanowicz et al. (2015) recovered the same phylogenetic tree topology with a main continental lineage, *P. pipistrellus* s.str., a Moroccan lineage and a central Mediterranean lineage which includes samples from south Italy and Malta (Figure 3). The Maltese haplogroup had a p -distance of 3.1 ± 0.5 , 2.7 ± 0.5 , 1.5 ± 0.4 % to the continental, Moroccan and Italian lineages, respectively.

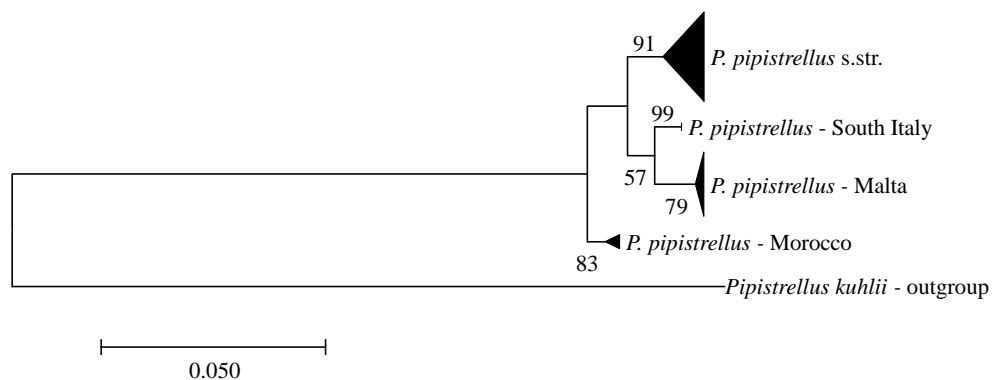

Figure 3. ML phylogenetic tree of *P. pipistrellus* complex based on 823 homologous positions of 50 ND1 sequences. Relationships inferred using the Hasegawa-Kishino-Yano model with a discrete Gamma distribution (HKY+G). Bootstrap support values >50% are shown. Scale bar corresponds to the number of substitutions per site.

Myotis punicus

The 12S rRNA and 16S rRNA sequences for *Myotis punicus* from this study are the first sequences obtained for this species. COI sequences of *M. punicus* from Malta and Sardinia produced a multiple sequence alignment of 556 positions with five variable sites and two haplotypes each corresponding to the geographical location of the sample. There was no genetic differentiation within the two populations for COI and a low genetic distance of 0.9 ± 0.4 % between Maltese and Sardinian samples typically observed within species. ND1 sequences of *M. punicus* specimens from Morocco, Sicily and Malta produced an alignment with 852 positions and 13 variable sites resulting in five haplotypes and a shared haplotype between Malta and Sicily (Figure 6B).

Pipistrellus kuhlii

The 12S rRNA marker used in this study provides the first reference sequence for *Pipistrellus kuhlii*. The 16S rRNA haplotype of *P. kuhlii* from Malta is shared with haplotypes from Tenerife and Albania while the COI haplotype is shared with Italy, Corsica, Greece and Switzerland. All the COI sequences belonging to this shared haplotype were assigned to the eastern Mediterranean lineage in previous investigations (Andriollo et al., 2015). Comparison of the Cytb haplotype to

sequences published by Benda et al. (2014) with samples from North Africa, Eastern Mediterranean and Middle East revealed the sharing of the Maltese haplotype with one specimen of *P. kuhlii* from Crete. A NJ phylogenetic tree of ND1 sequences of *P. kuhlii* from the Mediterranean region recovered three mitochondrial lineages as shown by Çoraman et al. (2013). In our analyses the Maltese haplotype formed part of the clade which includes samples from Eastern Europe, North Africa and Anatolia. Analyses of the haplotype relationships within this clade reveal sharing of the Maltese haplotype for ND1 with Greece, Switzerland and Italy (Figure 6C).

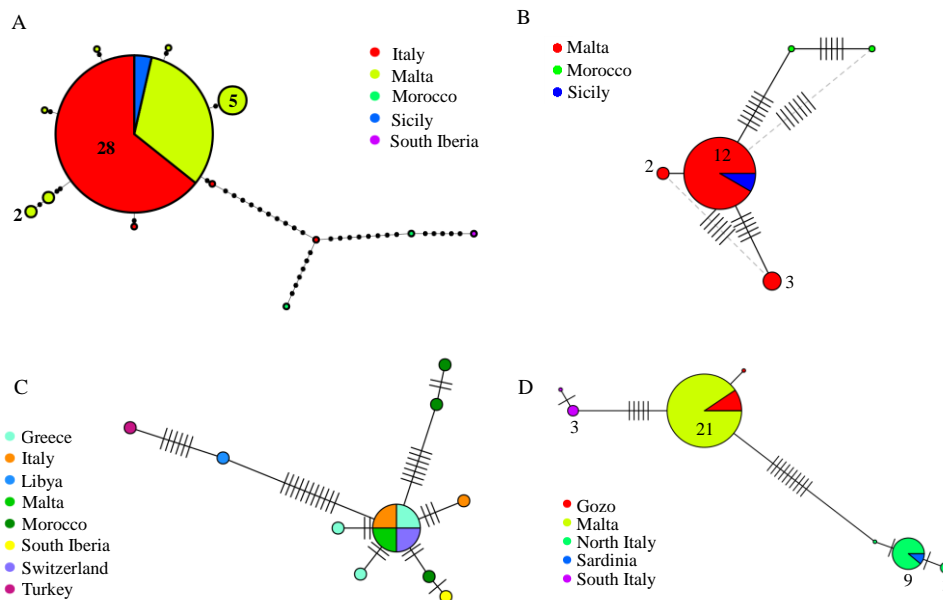

Figure 4. Parsimony-based haplotype networks. Diameter of haplotype circle is proportional to its frequency. The haplotype frequency is shown next to each haplotype when >1. Black dots or black lines on haplotype links indicate the number of mutations. Alternative links are shown for a maximum of 10 mutational steps. Haplotype relationships for (A) *Hypsugo savii* based on 900 bp for ND1, (B) *Myotis punicus* based on 868 bp for ND1, (C) *Pipistrellus kuhlii* from the Eastern clade, based on 543 bp of ND1. The network shows only unique haplotypes from each geographical region. (D) Haplotype relationships between Maltese and Italian *Rhinolophus hipposideros* populations based on 591 bp for Cytb.

Rhinolophus hipposideros

The 12S rRNA sequences obtained from this study are the first published sequences for *Rhinolophus hipposideros*. Analyses of the Cytb sequences from Malta obtained during this study, together with previously published sequences of *R. hipposideros* from Gozo reveal the presence of two mt-haplotypes for the Maltese Islands. Analysis of the haplotype relationships with surrounding geographical areas revealed that the Maltese haplotype is not shared with any other geographical region (Figure 4D). The Maltese specimens showed a genetic *p*-distance of 0.9% from those of southern Italy and 1.9% to samples from North Italy while the genetic divergence between north and south Italian samples was of 2.1%.

Plecotus gaisleri

Phylogenetic analyses using NJ and ML trees to explore the relationships between the different lineages of the *Plecotus austriacus* complex with the 16S dataset showed low support for nodes separating *Plecotus teneriffae kolombatovici*, *P. t. gaisleri* (Libya and Malta) and *P. t. cf. gaisleri* (Morocco) lineages (Figure 5). The results show that the Maltese haplotype is shared with a specimen from Libya [AY531624] listed as *P. t. gaisleri*. In addition, one haplotype from Libya [DQ294107] morphologically identified as *P. t. gaisleri* in Benda et al. (2014) clustered with Turkish *P. t. kolombatovici* in our 16S phylogenetic tree.

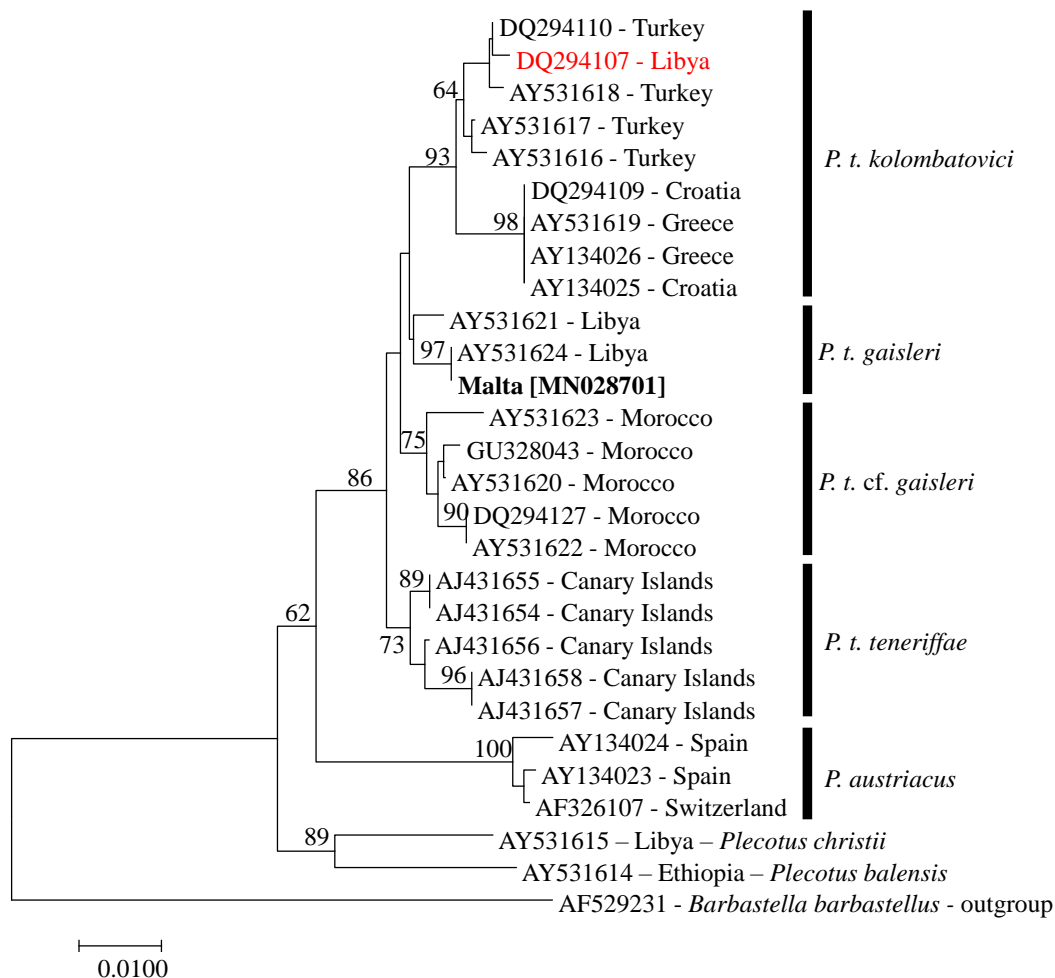

Figure 5. NJ phylogenetic tree of 16S sequences of *Plecotus austriacus* complex based on 485 positions. Sequences generated from this study are marked in bold. The specimen collected from Libya and morphologically identified as *P. gaisleri* in Benda et al. (2014) is shown in red. Bootstrap support values > 50% are shown. Scale bar represents the number of substitutions per site.

The 12S rRNA sequences of the *P. austriacus* complex were available for one individual collected from Morocco [GU328043] listed as *P. t. gaisleri* and one from Switzerland [AF326107] as *P. austriacus*. The Maltese specimens showed a genetic *p*-distance of 2.8 – 3.1% from *P. t.*

gaisleri (Morocco) and 3.9 – 4.1% from *P. austriacus*. Using the COI dataset, *P. gaisleri* from Malta shows a genetic *p*-distance of 2.2 ± 0.5 % to the haplotype from Libya [ABBWP163-06]. From the data retrieved from BOLD, a sequence listed as *P. t. gaisleri* collected from Morocco [ABBWP040-06] showed a genetic distance of 5.1 – 5.7% to *P. t. gaisleri* from Libya and Malta. Phylogenetic analyses of species within the *P. austriacus* complex using COI, support the distinct genetic characteristics of *P. t. cf. gaisleri* from Morocco (Figure 6A). Phylogenetic analyses using ND1 show a weakly supported sister relationship between Turkish and Balkan *P. kolombatovici* and a well-supported split between *P. gaisleri* and *P. kolombatovici* (Figure 6B). Based on ND1 sequences, *P. gaisleri* from Malta and Libya displayed a genetic *p*-distance of 5.7% and 6.1% to the Turkish and Balkan *P. kolombatovici* specimens, respectively and a *p*-distance of 11.7 – 12.8% to *P. austriacus*.

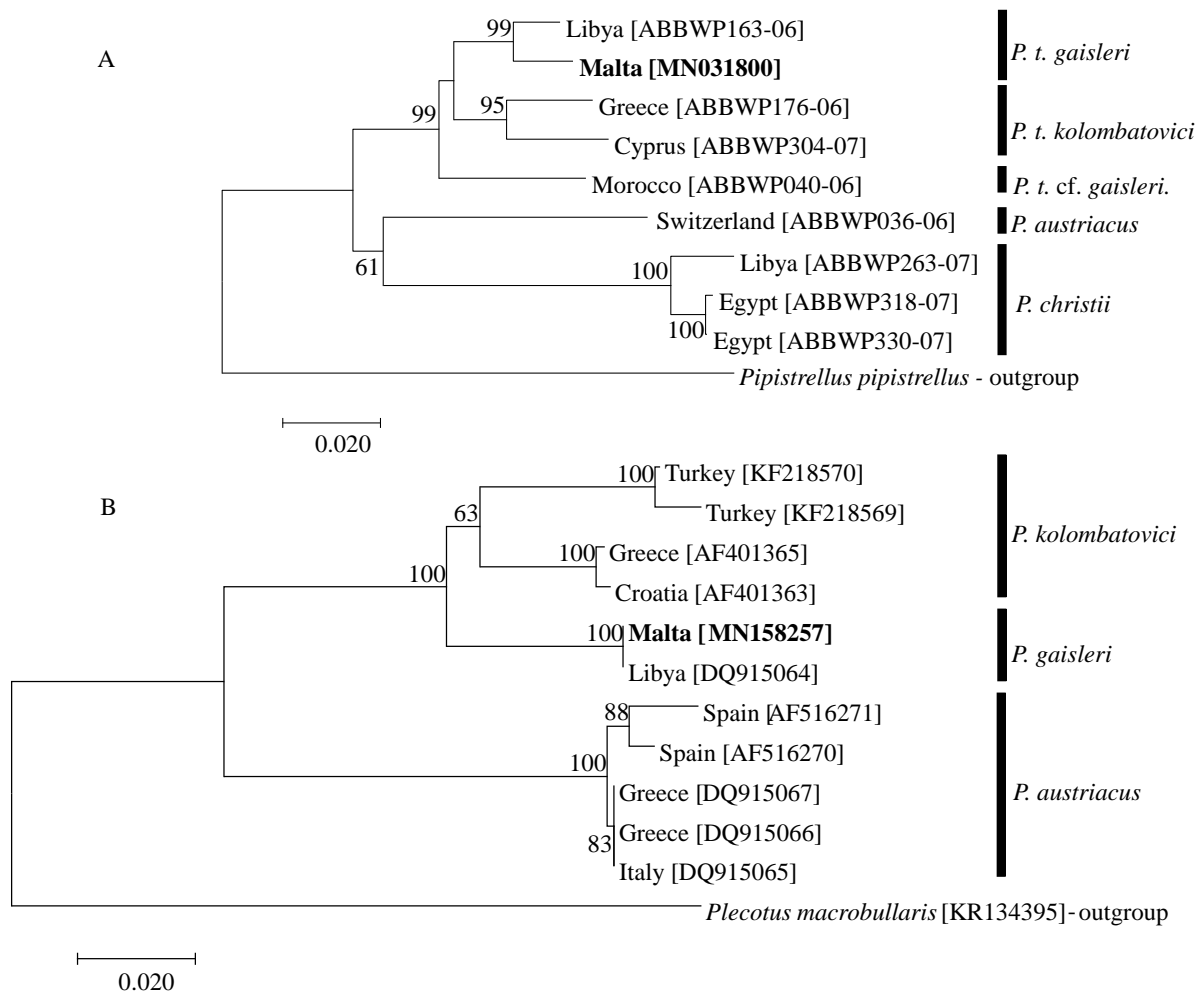

Figure 6. Phylogenetic trees of *Plecotus austriacus* species complex. Sequences generated from this study are marked in bold. Bootstrap support values > 50% are shown. Scale bars represents the number of substitutions per site. (A) NJ phylogenetic tree of unique haplotypes based on 650 positions of COI sequences available on BOLD. (B) ML phylogenetic tree based on 831 positions of ND1 sequences estimated using the GTR+G+I model.

Discussion

Genetic species identification

In this study, we confirmed the identity of the bat species occurring in Malta through molecular genetic analyses and provide the first genetic evidence for the presence of *Pipistrellus kuhlii*, *Hypsugo savii* and *Plecotus gaisleri* in Malta. Our mtDNA-based approach using multiple mitochondrial genes revealed that all five genes, including short fragments of 12S rRNA (c. 200 bp) and the longer ND1 fragments (c. 1000 bp), are suitable to differentiate all bat species from Malta. This has important implications for species identification when DNA is obtained from degraded samples, such as faecal samples or parts of dead specimens. In such cases, large DNA fragments of 600 bp or larger are difficult to obtain and hence by using smaller fragments, such as the 12S rRNA used in this study, enough DNA material can be obtained to identify the species origin of these samples thus serving as a reliable and non-invasive tool for the identification of threatened and protected taxa in order to assist conservation efforts.

Genetic diversity of bat species

Another important application of mtDNA studies is the assessment of genetic diversity between and within species. Genetic diversity constitutes an important component of biodiversity and requires careful assessment to aid conservation management plans for the preservation of the species' evolutionary potential. Matrilineal genetic diversity reveals aspects of maternal gene flow and life-history traits of a species (Turmelle et al., 2011). Our results show low mitochondrial diversity for *Rhinolophus hipposideros* and *Plecotus gaisleri*. Both species show limited dispersal abilities, high roost fidelity and strong female philopatry to natal territory (Hutterer et al., 2005) and therefore have a reduced ability to rapidly colonise new areas after a local population crash. In this respect, long-term conservation planning for these bat populations needs to effectively protect maternity roosts from disturbance and destruction in order to ensure their survival.

Analyses of the genetic diversity across bat species from Malta also revealed the highest mitochondrial diversity in *Hypsugo savii*. The Maltese population of *H. savii* is characterised by high haplotype diversity (0.802) and low nucleotide diversity (0.0015) and a star-like haplotype network. These are characteristics of populations which underwent a bottleneck event followed by population expansion (Avice 2009). The higher mitochondrial genetic diversity of *H. savii* from Malta compared to Italy revealed by our results support previous suggestions that *H. savii* colonised Italy from the Ibero-Maghreb region through Malta and Sicily in a stepping-stone manner (Bogdanowicz et al., 2015) since genetic diversity is generally reduced along a colonisation route (Hulva et al., 2010). Understanding maternal patterns of colonisation history is useful to biodiversity conservation as it allows better predictions of future species' responses to anthropogenically-induced environmental changes.

Phylogeographical patterns

The phylogeographical patterns of the mitochondrial lineages identified for Maltese bats display an affinity to the Central Mediterranean and North African clades. The bat species sharing mitochondrial haplotypes with surrounding geographical areas include *Pipistrellus kuhlii*, *Hypsugo savii*, *Myotis punicus* and *Plecotus gaisleri*, while the Maltese populations of *Pipistrellus pipistrellus* and *Rhinolophus hipposideros* exhibited private mitochondrial haplotypes. Such distinct mitochondrial lineages, revealed for the latter two species, represent a relatively isolated allopatric lineage and may indicate reduced female gene flow between Malta and neighbouring

islands and mainland. Despite that evidence from previous studies suggest incomplete isolation of the Maltese *P. pipistrellus* lineage (Hulva et al., 2010), the use of higher echolocation peak frequencies by both species (Mifsud & Vella, 2018) may be the result of enhanced local adaptation through limited gene flow (Puechmaille et al., 2011). The genetically distinct populations of these species, together with their observed sensory divergence allow for these populations to be delimited as separate conservation units as they represent unique genetic diversity and hence deserve higher conservation priority.

Previous phylogeographic studies based on Cytb and ND1 across the Western Palaearctic have demonstrated the presence of three distinct mitochondrial lineages for *H. savii* (Ibáñez et al., 2006; García-Mudarra et al., 2009; Çoraman et al., 2013; Bogdanowicz et al., 2015). Additional previous work based on 16s has also demonstrated the presence of three distinct lineages for *H. savii* (Veith et al., 2011), however, the three lineages were named following Mayer et al. (2007). In Veith et al. (2011) the Ibero-Maghreb lineage was assigned to *Hypsugo* cf. *darwinii*, the western lineage to *Hypsugo savii* s. str. and the eastern lineage named as *Hypsugo* sp.. By adding sequences of *H. savii* from Malta to previously published sequences for Cytb, ND1 and 16S and through the analyses of additional markers including COI, we have shown that the same lineage pattern is seen using COI data. Through these results we have updated the distribution of the Ibero-Maghreb clade to include Malta and revealed possible zones of sympatry for different lineages in Switzerland and Turkey. Our phylogeographical analyses based on 12S sequences also indicated that two diverging *P. pipistrellus* lineages are present in a zone of sympatry in Switzerland were a genetic distance of 0.5% and 3.5% was obtained between the Maltese specimens and two sequences from Switzerland. Despite this indication, the exact geographical location of these two Swiss samples was not available and the exact zone of sympatry cannot be ascertained. Identifying zones of sympatry for diverging mitochondrial lineages is important for further investigations, to understand the underlying evolutionary processes which are important for generating future biodiversity.

The phylogenetic relationships and morphological features of different lineages within the *Plecotus austriacus* complex across the Western Palaearctic has been analysed by various previous studies (Kiefer et al., 2002; Benda et al., 2004; Juste et al., 2004; Spitzenberger et al., 2006; Mayer et al., 2007). Despite the various genetic studies conducted on these bats, the relationship between the Balkan, Turkish, Libyan and Moroccan lineages within the *teneriffae/kolombatovici* clade remained poorly resolved (Benda et al., 2004; Juste et al., 2004; Spitzenberger et al., 2006). Contrasting phylogenetic relationships between *P. kolombatovici* from the Balkans and Turkey, and *P. gaisleri* from Libya were obtained by previous authors as outlined in Spitzenberger et al. (2006). In our 16S phylogenetic tree we have included all sequences available from Benda et al. (2004) and Spitzenberger et al. (2006) in addition to sequences produced in this study. In contrast to previous studies, our results have shown that only one specimen from Libya, previously assigned to *P. kolombatovici* in Spitzenberger et al. (2006) and morphologically identified as *P. gaisleri* in Benda et al. (2014), clustered within the Turkish *P. kolombatovici* clade. The results suggest the presence of the nominate form of *P. kolombatovici* in Libya. The results also show the distinct mitochondrial lineage of *Plecotus* from Morocco based on COI data. The COI haplotypes of *Plecotus* from Morocco show a *p*-distance greater than 5% from *P. gaisleri*. Intraspecific *p*-distances based on COI rarely accede 3% in bat taxa, while interspecific distances of 5% are used to distinguish the sister taxa *Pipistrellus pipistrellus* and *P. pygmaeus* (Kruskop et al., 2012). The supported split between *P. kolombatovici* and *P. gaisleri* based on ND1 was previously used to support the species status of *P. gaisleri* by Mayer et al. (2007) and therefore obtaining ND1

sequences from Moroccan specimens would further aid in resolving the phylogenetic relationships between the Moroccan lineage, *P. gaisleri* and *P. kolombatovici*.

Conclusion

The use of several mitochondrial markers has provided a DNA-based reference library for Malta's bat species genetic identification and a consideration of previous phylogeographical studies to update the distribution of specific mitochondrial lineages of bat species complexes across the Western Palaearctic. The presence of unique haplotypes for *P. pipistrellus* and *R. hipposideros* from Malta together with the previously documented sensory divergence points toward local adaptation by these two bat species' populations. Such isolated populations merit higher conservation priorities, and further research to understand patterns of adaptive divergence.

Acknowledgment

We thank other members of the Conservation Biology Research Group (University of Malta) for field research support and Dr Noel Vella for insightful genetic research recommendations. We are grateful to BICREF NGO volunteers who helped during fieldwork. The research work disclosed in this publication was supported by the ENDEAVOUR Scholarships Scheme (Malta).

References

- Andriollo, T., Naciri, Y., & Ruedi, M. (2015). Two mitochondrial barcodes for one biological species: The case of European Kuhl's pipistrelles (Chiroptera). *PLoS ONE*, *10*(8), e0134881.
- Arif, I. A., Khan, H. A., Bahkali, A. H., Al Homaidan, A. A., Al Farhan, A. H., Al Sadoon, M., & Shobrak, M. (2011). DNA marker technology for wildlife conservation. *Saudi Journal of Biological Sciences*, *18*(3), 219–225.
- Avise, J. C. (2009). Phylogeography: Retrospect and prospect. *Journal of Biogeography*, *36*(1), 3–15.
- Balakrishnan, R. (2005). Species concepts, species boundaries and species identification: A view from the tropics. *Systematic Biology*, *54*(4), 689–693.
- Benda, P., Kiefer, A., Hanák, V., & Veith, M. (2004). Systematic status of African populations of long-eared bats, genus *Plecotus* (Mammalia: Chiroptera). *Folia Zoologica*, *53*(1), 1–47.
- Benda, P., Spitzenberger, F., Hanák, V., Andreas, M., Reiter, A., Ševčík, M., Šmid, J., & Uhrin, M. (2014). Bats (Mammalia: Chiroptera) of the Eastern Mediterranean and Middle East. Part 11. On the bat fauna of Libya II. *Acta Societatis Zoologicae Bohemicae*, *78*, 1–162.
- Bogdanowicz, W., Hulva, P., Černá Bolfíková, B., Buš, M. M., Rychlicka, E., Sztencel-Jablonka, A., Cistrone, L., & Russo, D. (2015). Cryptic diversity of Italian bats and the role of the Apennine refugium in the phylogeography of the western Palaearctic. *Zoological Journal of the Linnean Society*, *174*(3), 635–648.

- Çoraman, E., Furman, A., Karataş, A., & Bilgin, R. (2013). Phylogeographic analysis of Anatolian bats highlights the importance of the region for preserving the Chiropteran mitochondrial genetic diversity in the Western Palaearctic. *Conservation Genetics*, *14*(6), 1205–1216.
- Dietz, C., & von Helversen, S. (2004). Illustrated Identification key to the bats of Europe. Electronic publication Version 1.0., Tuebingen & Erlangen, Germany.
- Edgar, R. C. (2004). MUSCLE: multiple sequence alignment with high accuracy and high throughput. *Nucleic Acids Research*, *32*(5), 1792–1797.
- Felsenstein, J. (1985). Confidence limits on phylogenies: An approach using the bootstrap. *Society for the Study of Evolution*, *39*(1), 1–15.
- García-Mudarra, J. L., Ibáñez, C., & Juste, J. (2009). The Straits of Gibraltar: Barrier or bridge to Ibero-Moroccan bat diversity? *Biological Journal of the Linnean Society*, *96*(2), 434–450.
- Hulva, P., Fornůsková, A., Chudárková, A., Evin, A., Allegrini, B., Benda, P., & Bryja, J. (2010). Mechanisms of radiation in a bat group from the genus *Pipistrellus* inferred by phylogeography, demography and population genetics. *Molecular Ecology*, *19*(24), 5417–5431.
- Hutterer, R., Ivanova, T., Meyer-Cords, C., & Rodrigues, L. (2005). *Bat migrations in Europe - A review of banding data and literature* (Vol. 28). Federal Agency for Nature Conservation, Bonn, Germany.
- Ibáñez, C., García-Mudarra, J. L., Ruedi, M., Stadelmann, B., & Juste, J. (2006). The Iberian contribution to cryptic diversity in European bats. *Acta Chiropterologica*, *8*(2), 277–297.
- Juste, J., Ibáñez, C., Muñoz, J., Trujillo, D., Benda, P., Karataş, A., & Ruedi, M. (2004). Mitochondrial phylogeography of the long-eared bats (*Plecotus*) in the Mediterranean Palaearctic and Atlantic Islands. *Molecular Phylogenetics and Evolution*, *31*(3), 1114–1126.
- Juste, J., Benda, P., Garcia-Mudarra, J. L., & Ibáñez, C. (2013). Phylogeny and systematics of Old World serotine bats (genus *Eptesicus*, Vespertilionidae, Chiroptera): An integrative approach. *Zoologica Scripta*, *42*(5), 441–457.
- Juste, J., Ruedi, M., Puechmaille, S. J., Salicini, I., & Ibáñez, C. (2019). Two new cryptic bat species within the *Myotis nattereri* species complex (Vespertilionidae, Chiroptera) from the Western Palaearctic. *Acta Chiropterologica*, *20*(2), 285–300.
- Kearse, M., Moir, R., Wilson, A., Stones-Havas, S., Cheung, M., Sturrock, S., Buxton, S., Cooper, A., Markowitz, S., Duran, C., Thierer, T., Ashton, B., Meintjes, P., & Drummond, A. (2012). Geneious Basic: An integrated and extendable desktop software platform for the organization and analysis of sequence data. *Bioinformatics*, *28*(12), 1647–1649.
- Kiefer, A., Mayer, F., Kosuch, J., Von Helversen, O., & Veith, M. (2002). Conflicting molecular phylogenies of European long-eared bats (*Plecotus*) can be explained by cryptic diversity. *Molecular Phylogenetics and Evolution*, *25*(3), 557–566.

- Kiefer, A., & Veith, M. (2001). A new species of long-eared bat from Europe (Chiroptera : Vespertilionidae). *Myotis*, 39, 5–16.
- Kruskop, S. V., Borisenko, A. V., Ivanova, N. V., Lim, B. K., & Eger, J. L. (2012). Genetic diversity of northeastern Palaearctic bats as revealed by DNA barcodes. *Acta Chiropterologica*, 14(1), 1–14.
- Kumar, S., Stecher, G., & Tamura, K. (2016). MEGA7: Molecular Evolutionary Genetics Analysis Version 7.0 for Bigger Datasets. *Molecular Biology and Evolution*, 33(7), 1870–1874.
- Lanfear, R., Calcott, B., Ho, S. Y. W., & Guindon, S. (2012). PartitionFinder: Combined selection of partitioning schemes and substitution models for phylogenetic analyses. *Molecular Biology and Evolution*, 29(6), 1695–1701
- Lanfear, R., Frandsen, P. B., Wright, A. M., Senfeld, T., & Calcott, B. (2017). Partitionfinder 2: New methods for selecting partitioned models of evolution for molecular and morphological phylogenetic analyses. *Molecular Biology and Evolution*, 34(3), 772–773.
- Mayer, Frieder, Dietz, C., & Kiefer, A. (2007). Molecular species identification boosts bat diversity. *Frontiers in Zoology*, 4(4), 1–5.
- Mifsud, C. M., & Vella, A. (2018). Acoustic characterization of bats from Malta: setting a baseline for monitoring and conservation of bat populations. *Bioacoustics*, 28(5), 427–442.
- Miller, M. A., Pfeiffer, W., & Schwartz, T. (2010). Creating the CIPRES Science Gateway for inference of large phylogenetic trees. *Proceedings of the Gateway Computing Environments workshop (GCE) 2010*, New Orleans, 1–8.
- Mitchell-Jones, A. J., & McLeish, A. P. (Eds.). (2004). *Bat Workers' Manual*. 3rd Edition, Joint Nature Conservation Committee, Peterborough.
- Mucedda, M., Kiefer, A., Pidinchedda, E., & Veith, M. (2002). A new species of long-eared bat (Chiroptera, Vespertilionidae) from Sardinia (Italy). *Acta Chiropterologica*, 4(2), 121–135.
- Nei, M., & Kumar, S. (2000). *Molecular evolution and phylogenetics*. Oxford University Press, New York.
- Paradis, E. (2010). pegas: an R package for population genetics with an integrated-modular approach. *Bioinformatics*, 26(3), 419–420.
- Puechmaille, S. J., Allegrini, B., Benda, P., Gürün, K., Šrámek, J., Ibañez, C., Juste, J., & Bilgin, R. (2014). A new species of the *Miniopterus schreibersii* species complex (Chiroptera: Miniopteridae) from the Maghreb region, North Africa. *Zootaxa*, 3794(1), 108–124.
- Puechmaille, S. J., Gouilh, M. A., Piyapan, P., Yokubol, M., Mie, K. M., Bates, P. J., Satasook, C., New, T., Bu, S. S. H., MacKie, I. J., Petit, E. J., & Teeling, E. C. (2011). The evolution of sensory divergence in the context of limited gene flow in the bumblebee bat. *Nature Communications*, 2(573), doi:10.1038/ncomms1582.
- Robertson, J. M., Langin, K. M., Sillett, T. S., Morrison, S. A., Ghalambor, C. K., & Funk, W. C. (2014). Identifying evolutionarily significant units and prioritizing populations for

- management on islands. *Monographs of the Western North American Naturalist*, 7(1), 397–411.
- Rozas, J., Ferrer-Mata, A., Sánchez-DelBarrio, J. C., Guirao-Rico, S., Librado, P., Ramos-Onsins, S. E., & Sánchez-Gracia, A. (2017). DnaSP 6: DNA Sequence Polymorphism Analysis of Large Data Sets. *Molecular Biology and Evolution*, 34(12), 3299–3302.
- Saitou, N., & Nei, M. (1987). The neighbor-joining method: a new method for reconstructing phylogenetic trees. *Molecular Biology and Evolution*, 4(4), 406–425.
- Salicini, I., Ibáñez, C., & Juste, J. (2011). Multilocus phylogeny and species delimitation within the Natterer's bat species complex in the Western Palearctic. *Molecular Phylogenetics and Evolution*, 61(3), 888–898.
- Spitzenberger, F., Strelkov, P. P., Winkler, H., & Haring, E. (2006). A preliminary revision of the genus *Plecotus* (Chiroptera, Vespertilionidae) based on genetic and morphological results. *Zoologica Scripta*, 35(3), 187–230.
- Swofford, D. L. (2002). *Phylogenetic Analysis Using Parsimony (*and Other Methods)*. Version 4. Sinauer Associates, Sunderland, Massachusetts.
- Turmelle, A. S., Kunz, T. H., & Sorenson, M. D. (2011). A tale of two genomes: Contrasting patterns of phylogeographic structure in a widely distributed bat. *Molecular Ecology*, 20(2), 357–375.
- Veith, M., Mucedda, M., Kiefer, A., & Pidinchedda, E. (2011). On the presence of pipistrelle bats (*Pipistrellus* and *Hypsugo*; Chiroptera: Vespertilionidae) in Sardinia. *Acta Chiropterologica*, 13(1), 89–99.
- von Helversen, O., Heller, K. G., Mayer, F., Nemeth, A., Volleth, M., & Gombkötö, P. (2001). Cryptic mammalian species: A new species of whiskered bat (*Myotis alcathoe* n. sp.) in Europe. *Naturwissenschaften*, 88(5), 217–223.
- Worthington Wilmer, J., & Barratt, E. (1996). A non-lethal method of tissue sampling for genetic studies of chiropterans. *Bat Research News*, 37, 1–3

Appendix S1: Accession numbers and sampling location of GenBank and BOLD sequences used in haplotype networks and sequence divergence analyses. The mtDNA locus used for each analysis is indicated in bold.

Hypsugo savii

- ND1: DQ915018, EU360620 Morocco; EU360621 Southern Iberia; KJ948301-4 Italy.

Myotis punicus

- ND1: DQ915039-40 Morocco; KJ948264 Sicily.

Pipistrellus kuhlii

- ND1: AF401414-16 Greece; DQ120796 South Iberia; DQ914985 Libya; DQ914987, KJ948258 Italy; DQ914990, EU360616-17 Morocco; EU360618 Switzerland; KF218491 Turkey.

Pipistrellus pipistrellus

- 16S rRNA: HM561630 Switzerland; HQ848741 Germany; HQ848742, HQ848745-48, HQ848752 Turkey; HQ848743 Israel; HQ848749 Austria; HQ848750 France; HQ848751 Italy, HQ848754-58 Sardinia; HQ848759 Morocco; HQ848760 Sicily.

- COI: ABBWP010-06 Spain; ABBWP054-06 Greece; ABBWP084-06, JF443078 Switzerland; FR856771-82 Italy.

- Cytb: AJ504443 Greece; DQ120851-54 Iberia; EU360661-76 Ibero-Maghreb; KF218396-403 Turkey; KF874512-21 Iran; KX375162 Jordan.

- ND1: DQ914967-8, KJ948241-9, KJ957194 Italy; DQ914969-72 Morocco; DQ914974 Greece; DQ914975, DQ914980, DQ914982, KF218503-13 Turkey;

Rhinolophus hipposideros.

- **Cytb**: KC978378-80 Gozo, KC978381-88, KC978714-6 North Italy; KC978389-93 South Italy; KC978452 Sardinia

Table S2: Sources of primers used, and product size obtained from the amplification of five mitochondrial DNA genes.

Gene	Primer	Sequence 5' – 3'	Reference	Size (bp)
16S	16Sar	CGCCTGTTTATCAAAAACAT	Palumbi (1996)	549
	16Sbr	CCGGTCTGAACTCAGATCACGT		
12S	L1091	AAAAAGCTTCAAACCTGGGATTAGATACCCCACTAT	Kocher et al. (1989)	390
	H1478	TGACTGCAGAGGGTGACGGGGCGGTGTGT		
COI	BatL5310	CCTACTCRGCCATTTTACCTATG	Robins et al. (2007)	702
	R6036R	ACTTCTGGGTGTCCAAAGAATCA		
Cytb	L15162	GCAAGCTTCTACCATGAGGACAAATATC	Irwin et al. (1991)	750
	H15915	AACTGCAGTCATCTCCGGTTTACAAGAC		
ND1	ER65	CCTCGATGTTGGATCAGG	Petit et al. (1999)	1424
	ER66	GTATGGGCCCGATAGCTT		

References Table S2:

- Irwin, D. M., Kocher, T. D., & Wilson, A. C. (1991). Evolution of the cytochrome b gene of mammals. *Journal of Molecular Evolution*, 32(2), 128–144.
- Kocher, T. D., Thomas, W. K., Meyer, A., Edwards, S. V., Pääbo, S., Villablanca, F. X., & Wilson, A. C. (1989). Dynamics of mitochondrial DNA evolution in animals: amplification and sequencing with conserved primers. *Proceedings of the National Academy of Sciences of the United States of America*, 86(16), 6196–6200.
- Palumbi, S. R. (1996). Nucleic Acids II: the polymerase chain reaction. In D. M. Hillis, C. Mortiz, & B. K. Mable (Eds.), *Molecular Systematics*. Sinauer & Associates Inc., Sunderland, Massachusetts.
- Petit, E., Excoffier, L., & Mayer, F. (1999). No evidence of bottleneck in the postglacial recolonization of Europe by the noctule bat (*Nyctalus noctula*). *Evolution*, 53(4), 1247–1258.
- Robins, J. H., Hingston, M., Matisoo-Smith, E., & Ross, H. A. (2007). Identifying *Rattus* species using mitochondrial DNA. *Molecular Ecology Notes*, 7(5), 717–729.

Appendix S3: Additional phylogenetic tree constructed for phylogeographical analyses of *Hypsugo savii*

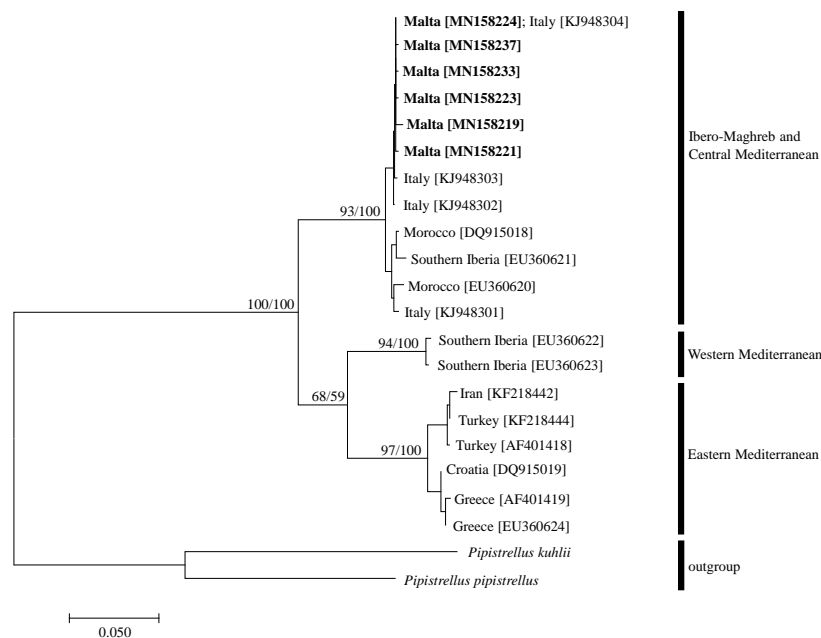

Figure S3. ML phylogenetic tree for *Hypsugo savii* based on 788 bp of ND1, estimated using the Hasegawa-Kishino-Yano (HKY) model with a discrete Gamma distribution (+G, parameter = 0.1837) to model evolutionary rate difference among sites. Branch support values at major nodes indicate the percentage of replicate trees (1000 replicates) in which the associated taxa clustered together (ML/NJ branch support values and are shown if >50%). Sequences generated from this study are marked in bold. The scale bar represents the genetic distance measured in the number of substitutions per site