



## Artificial Bee Colony Optimization for Effective Power System Stabilization

V.Ravi<sup>1</sup> and K.Duraiswamy<sup>2</sup>

<sup>1</sup>Associate Professor, Department of EEE, K.S.R College of Engineering, Tiruchengode, India

<sup>2</sup>Dean, Department of CSE, K.S.R College of Technology, Tiruchengode, India

---

**Abstract:** *The power system stability has been considered as one of great concerns in the power system domain. Power industries are restructured to provide effective utilization of power to more users at lower prices and better power efficiency. Load demand has increased linearly with the increase in number of users. Since stability phenomena limits the transfer capability of the system, there is a need to ensure stability and reliability of the power system due to economic reasons. As a result, serious consideration is now being given on the concern of power system stabilization control. Thus, various stabilization techniques have been proposed by several researchers for the multi-machine power system through several intelligent methods. In recent times, the utilization of optimization techniques is found to be effective in dealing with the stabilization of the power systems. This paper uses the Artificial Bee Colony algorithm for better stability of the power system. Simulation results suggest that the proposed technique is better for power system stabilization when compared to the conventional techniques.*

**Keywords:** *Power System Stabilization, Optimization Algorithm, Artificial Bee Colony.*

---

### 1. Introduction

As Power system is a large scale system and has strong nonlinearity. The stability of the power system [1] has been an active area of research and has been studied extensively. High complexity, dynamic nature, nonlinearity characteristics and the time varying behavior of power systems have created challenges in providing stability of the power systems [2].

Electric power systems have become massive and highly complex. Many oscillations are intrinsic in large interconnected power systems. The importance and the complexity of the power systems put stress on the existing power system stabilization techniques.

There are various problems in maintaining the stability of the power system. The stability issue in a power system is considered as one of the most important and essential concepts of power systems quality.

In order to deal with the drawbacks of the existing stabilization techniques, various electric power system stability improvements have been proposed [3]. Supplementary excitation control signal and Power System Stabilizer (PSS) have been widely used in enhancing the stability of the power system. PSS has been considered as a significant technique to improve the damping of

electromechanical oscillations in electrical power systems. PSS extends stability limits by adapting the generator excitation to offer extra damping to the oscillations of synchronous machine rotors [4]. In multi-machine power systems, enhancing the damping of one generator with the help of PSS is inadequate to enhance the damping of the other generators.

Several techniques such as root locus [5] and sensitivity analysis [6] and robust control [7] have been used in the design of PSS. These existing techniques have several drawbacks such as the control law depends on a linearized machine model and the control parameters are adjusted to certain nominal operating conditions. Moreover, parameters of the controllers are not valid as the system conditions changes nonlinear in case of large disturbances [8].

With such limitations, it is difficult to stabilize power system efficiency by the existing stability techniques. Thus, novel modern control approaches like adaptive controller and  $H_\infty$  control system were used for better performance than traditional stabilizers [9]. These stabilizers based on modern control theory also suffer from certain drawbacks such as the requirement of complete information about the power system, high computing time for on-line parameter identification and large implementation costs.

Thus a novel research technique is very necessary for the effective stabilization of the power systems. Optimization techniques are found to be very

effective in the stabilization of the power systems. Optimization techniques are widely applied in many real world problems such as image processing, pattern recognition, classifiers, machine learning, routing. Recently, field of Artificial Intelligence (AI) is observed to be an active area of research and is utilized in stabilization of the power system. AI is the study and research for identifying relationships between cognitive science and computation theories. These relationships are denoted as data structures, search methods, problem solving techniques etc., [10]. Social insects usually work without supervision. Moreover, the team work of the social insects is chiefly self-organized, and coordination occurs from the various interactions among individuals in the system. Swarm Intelligence (SI) [11] is a technique that represents the collective nature of a set of social insects. SI systems usually consist of a set of self-organized individuals which interacts locally with them and their environment. Even though there is no centralized control structure for identifying the nature of the individuals, interactions between all individuals often provides the way for the emergence of global behavior.

Thus, swarm intelligence is used for the optimization of the stability. This would provide better technique for stabilizing the power system. ABC is a non-pheromone based approach, updation of pheromone values is not necessary. The communication between the bees is through waggle dance. Parallel behavior of group of bees results in reaching near global optimal solution at a faster rate. The final optimal solution can be obtained during each iteration of the bees' exploration procedure. Thus, it is not necessary to examine all the solution candidates generated from the beginning to the end at the final step which in turn results in less computational overhead and reduced memory limit problems.

Thus, this paper uses Artificial Bee Colony (ABC) [12] for the stabilization of power systems. Artificial Bee Colony (ABC) techniques have been used to enhance the stabilization of the power systems.

The paper is organized as follows. Section II describes about various previous power system stabilization techniques related to the present research work. Section III describes about the proposed power system stability mechanism using ABC algorithm. Section IV discusses about the experimental results and analysis of the proposed approach. Section V provides the conclusion of the paper.

## 2. Literature Survey

The Several researches have been done in the field of power system to provide stability. Various techniques are proposed by several

researchers which have their advantages and disadvantages. Some of the techniques are discussed below.

Folly et al., [13] proposed a power system stabilization considering system uncertainties. This approach uses both structured and unstructured uncertainty representations for the design of robust power system stabilizer. The Structure Singular Value (SSV) optimization approach ( $\mu$ -synthesis) is used to design a controller that provides robust performance in presence of system's uncertainties. When SSV of the augmented closed-loop system is less than one, then this approach is said to achieve the robust performance. D-K iteration technique is used to provide solution to this problem, which gives a lower and upper bound of  $\mu$ . Simulation results illustrated that this approach attains a better robust performance over a wide range of operating conditions when compared to the conventional power system stabilizers and the  $H_\infty$  power system stabilizer. Eigen value results of this approach are more robust than the other two controllers over a wide range of operating conditions.

A robust decentralized controller based on optimal sequential design is proposed by Yoshitaka et al., [14]. The inter-area oscillation mode on design phase can be directly considered by this controller. Moreover, the sequential process is applied to design robust controllers. The best design sequence of the controller is determined by using the condition number. The performance of the controller is illustrated by comparing it with traditional controllers. Damping of many oscillations for a multi-machine power system is illustrated via simulations, which concern a three line-to-ground fault for power system disturbance [15, 16].

Li Xiaohua et al., [17] proposed a research on robust decentralized connective stabilization control for a class of interconnected power systems in which the new subsystems are added to one after another on line. The main issue to be considered is how to design the local control law of the new subsystem without changing the decentralized control laws of original power system, in order that both the subsystem and the resultant expanded power system [18] are connective stable. The adequate condition of the robust decentralized connective stabilization for expanding construction of the interconnected power systems is attained by considering Lyapunov theory and LMI technique. The efficiency of this approach is illustrated by the control simulation results for the interconnected power system model with expanding construction.

The implementation of fuzzy logic within the power industry has seen little success because of the requirement of previous data about an enormously complex system. Soon et al., [19] proposed a Fuzzy Logic Controller (FLC) for decentralized stabilization of multi-machine power systems. A unique, largely analytical approach for design of robust Multi-Input-Single-Output (MISO) FLC is presented for enhancing damping and stability of an electrical power system without affecting the voltage regulation. This

decentralized FLC technique uses a systematic analytical approach based on a performance index in order to bypass the need for prior knowledge about the system. This FLC approach tracks speed deviations to zero in order to stabilize the power output of the generator, while, at the same time, it controls and stabilizes the terminal voltage of the generator. FLC successfully stabilizes both voltage and power oscillations following small and large disturbances in a power system. A multi-machine power system, which comprises of a four-machine and a ten-machine (New England) system is used for the simulation of the FLC technique. The simulation results clearly showed the effectiveness of designed FLCs in stabilizing the system. The result of the FLC technique is compared with the classical Power System Stabilizers (PSSs) [20, 21] tuned by a conventional linear sequential tuning method (LSM) and optimization-based methods.

Abedinia et al., [22] presented an Artificial Bee Colony (ABC) algorithm to adjust optimal rule-base of a Fuzzy Power System Stabilizer (FPSS) which leads to damp low frequency oscillation following disturbances in power systems. Therefore, mining of a suitable group of rules from the collection of possible rules is a vital step toward the design of any efficient fuzzy logic controller. Accordingly, ABC based rule generation techniques are used for automated fuzzy PSS design to enhance power system stabilization and minimize the design effort. The efficiency of this technique is verified on a 3-machine 9-bus standard power system in comparison with the Genetic Algorithm based tuned FPSS under various loading condition via ITAE performance indices.

Optimal Power Flow (OPF) is one of the most significant techniques for the study of power system operation, which needs a complex mathematical formulation to find the best solution. Traditional techniques such as Linear Programming, Newton-Raphson and Non-linear Programming were employed to handle with the difficulty of the OPF. But, with the occurrence of artificial intelligence, several effective approaches such as Artificial Neural Networks, Genetic Algorithms, Particle Swarm Optimization and other Swarm Intelligence approaches have become popular. Sumpavakup et al., [23] proposed the use of Artificial Bee Colony (ABC), which is one of the latest computational intelligence to solve the OPF problems. The results reveal that solving the OPF problem by the ABC is very effective.

### 3. Methodology

The power system dynamic stability characteristic acts as a forever growing field of research because of the large scale interconnection of the power system. This field has been recognized as a significant problem for secure system operation

from the 1920's [24]. There were various important collapses resulted by the instability of a power system that indicates the significance of this trend [25]. The stability maintenance in a power system is considered as one of the highly important and necessary factor of power systems quality.

#### 3.1. Power System Modeling

The model of multi-machine power system considered for this proposed approach is shown in figure 1. The multi-machine consists of 3 machine nine bus system. G1, G2 and G3 are machine present in the multi-machine taken into consideration.

Proposed first order all-pass filter circuits and their voltage transfer functions are given in Figure.2. The transfer functions of the allpass filters which is given in Figure.2 are expressed as:

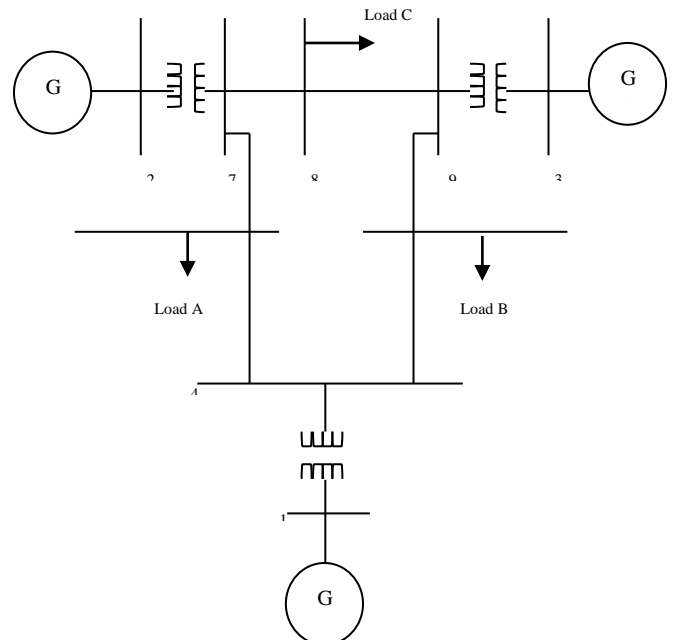

Figure 1: Single-line Diagram of Three-Machine Nine-Bus System

#### 3.2. System Model and PSS Structure

A power system can be modeled by a set of nonlinear differential equation as:

$$\dot{X} = f(X, U) \tag{1}$$

Where X is the vector of the state variables and U is the vector of input variables. In this study,  $X = [\delta, \omega, E'_q, E_{fd}]^T$  and U is the PSS output signals.

In the design of PSSs, the linearized incremental models around an equilibrium point are usually employed [26, 27]. Hence, the state equation of a power system with n machines and  $n_{PSS}$  stabilizers can be written as:

$$\Delta \dot{X} = A \Delta X + B U \tag{2}$$

Where  $A$  is a  $4n \times 4n$  matrix equals  $\partial f / \partial X$ , while  $B$  is  $4n \times n$  PSS matrix and equals  $\partial f / \partial U$ . Both  $A$  and  $B$  are evaluated at the equilibrium point.  $\Delta X$  is a  $4n \times 1$  state vector while  $U$  is  $n$  PSS  $\times 1$  input vector.

A widely used conventional lead-lag PSS is considered in this study. It can be described as [26, 27].

$$U_i = K_i \frac{sT_w}{1 + sT_w} \frac{(1 + sT_{1i})}{(1 + sT_2)} \frac{(1 + sT_{3i})}{(1 + sT_4)} \Delta\omega_i \quad (3)$$

Where  $T_w$  the washout time is constant,  $U_i$  is the PSS output signal at the  $i$ th machine, and  $\Delta\omega_i$  is the speed deviation of this machine. The time constants  $T_w$ ,  $T_2$  and  $T_4$  are usually prespecified [27]. The stabilizer gain  $K_i$  and time constants such as  $T_{1i}$  and  $T_{3i}$  still need to be optimized.

### 3.3 Objective function and PSS tuning

To increase the system damping to electromechanical modes, an objective function  $J$  defined below is considered.

$$J = \max\{\text{Re}(\lambda_i), i \in \text{set of electromechanical modes}\}$$

Where  $\text{Re}(\lambda_i)$  is the real part of the  $i$ th eigen value associated with electromechanical modes. This objective function is proposed to shift these eigenvalues to the left of  $s$ -plane in order to improve the system damping factor and setting time and insure some degree of relative stability.

The problem constraints are the optimized parameter bounds. Therefore, the design problem can be formulated as the following optimization problem.

Minimize  $J$

Subject to

$$\begin{aligned} K_i^{\min} &\leq K_i \leq K_i^{\max} \\ T_{1i}^{\min} &\leq T_{1i} \leq T_{1i}^{\max} \\ T_{3i}^{\min} &\leq T_{3i} \leq T_{3i}^{\max} \end{aligned} \quad (4)$$

Typical ranges of these parameters are [0.01-50] for  $K_i$  and [0.01-1.0] for  $T_{1i}$ . The time constants  $T_w$ ,  $T_2$  and  $T_4$  are set as 5, 0.05 and 0.05  $s$  respectively [28].

The proposed approach employs Artificial Bee Colony (ABC) algorithm to solve this optimization problem and search for optimal set of PSS parameters,  $\{K_i, T_{1i}, T_{3i}, i = 1, 2, \dots, n_{\text{PSS}}\}$ .

### 3.4. Artificial Bee Colony (ABC) Algorithm

This paper uses ABC algorithm for the stabilization of the power system. A modeling of artificial bee colony system is seen in figure 2. This paper proposes a new optimization algorithm that uses the bee behavior in food foraging as the functions to be used by the processing engine.

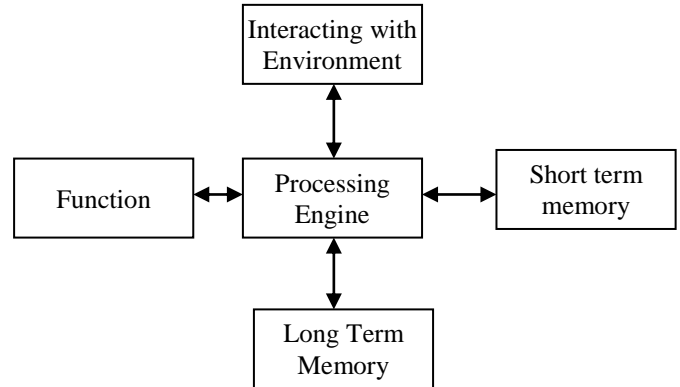

Figure 2: Architecture of Artificial Bees' Colony System

Artificial Bee Colony algorithm is introduced by Dervis Karaboga in 2005 [29]. ABC algorithm was formed by observing the activities and behavior of the real bees, while they were looking for the nectar resources and sharing the amount of the resources with the other bees.

Data flows creation around the beehive is a behavior of bees that involves the fundamentals of the swarm intelligence. There are three kinds of bees such as employed, onlooker and scouts. Each type of bees has a different role in the optimization process. Employed bees wait above the nectar source and keep the neighboring sources in memory. Onlooker bees get that data from employed bees and make a resource choice to collect the nectar. Also, the scouts are very much accountable for calculation. The algorithm comprises of three steps. In the first step, employed bees are sent to scamper for resources and the nectar amount is computed. In the second step, onlooker bees make a resource choice appropriate to the data they took from identifying new nectar resources. Ultimately, in the third step, one of the employed bees is chosen at random as a scout bee and it is sent to the sources to identify new sources [30]. Half of the bees in the colony are chosen as employed and the rest half are chosen as onlooker bees in the algorithm. Therefore, the number of employed bees is equal to the number of nectar sources. The food sources in the approach refer to the probable solutions of the issue to be optimized. The nectar amount belonging to a source denotes the quality value which is said by that source as shown in Figure 3.

In the first step of the ABC, random solutions are created in the particular range of the variables  $x_i$  ( $i = 1, \dots, S$ ).

Secondly, each employed bee identifies new sources whose amounts are equal to the half of the total sources. Equation 5 is used to find a new source.

$$V_{ij} = x_{ij} + \phi_{ij}(x_{ij} - x_{kj}) \quad (5)$$

In Equation 5,  $k$  is equal to  $(\text{int}(\text{rand} * S) + 1)$  and  $j$  is equal to  $1, \dots, D$ . After creating  $V_i$ , they compared  $x_i$  solutions and the best one was used as the source.

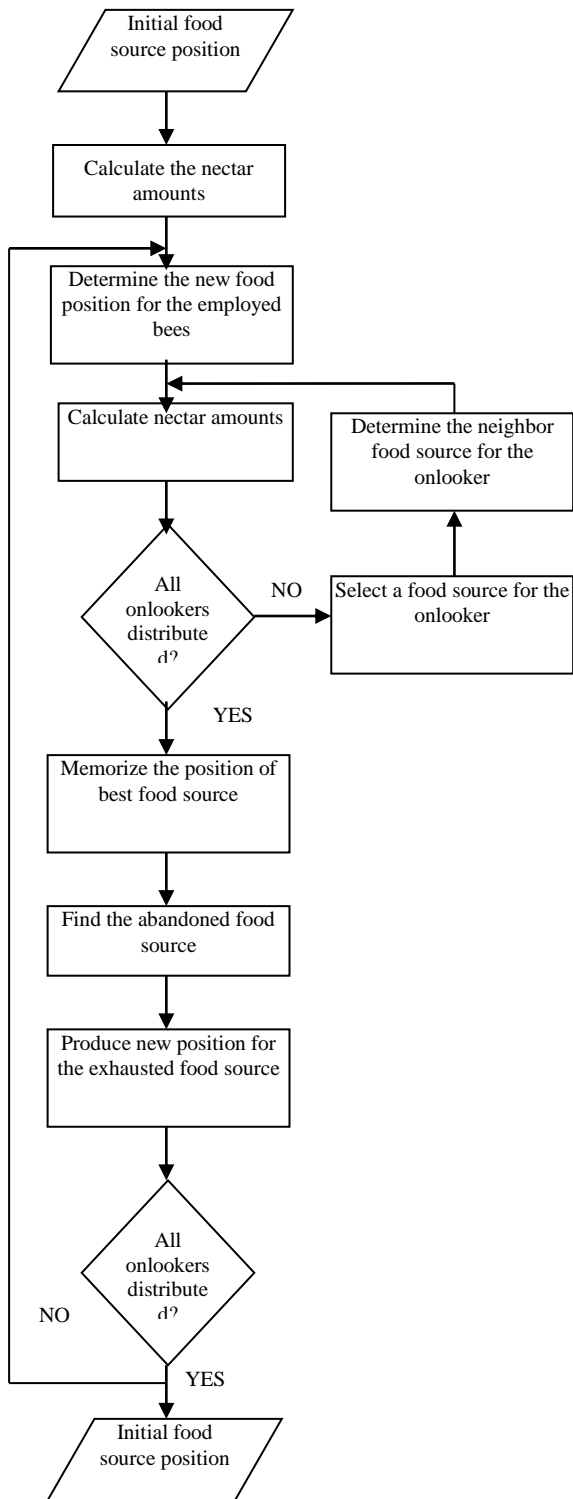

Figure 3: Flowchart of the ABC algorithm

In the third step, onlooker bees select a food source with the probability given in Equation 6.

$$P_i = \frac{fit_i}{\sum_{j=1}^{SN} fit_j} \quad (6)$$

The scout bees are very much accountable for random researches in each colony. Scout bees do not use any pre knowledge and facts when they

are looking for nectar sources, and as such, their research was randomly done completely [31]. The scout bees are chosen among the employed bees with respect to the limit parameter. If a solution that denotes a source is not realized with particular number of trials, then this source is discarded. The bee of that source identifies new source as a scout bee. The number of incomings and outgoings to a source is obtained by the ‘limit’ parameter. Identifying a new source of a scout bee is given in Equation 7.

$$x_{ij} = x_j^{min} + x_j^{max} - x_j^{min} * rand \quad (7)$$

In ABC, the employed and the onlooker bees serve in the utilization process and the scouts serve in the process of exploration. Bees toil for the maximization of the energy function E/T, showing the amount of the foods that are brought to the nest. The maximization of the objective function is  $F(\theta_i)$ , where  $\theta_i \in R^P$  is done in the maximization problem.  $\theta_i$  represent the position of the  $i$ th source, where  $F(\theta_i)$  denote the nectar amount in this source and it is proportional with  $E(\theta_i)$ .  $P_c = \theta_i \ c \ i = 1, 2, \dots, S$  is the population of the sources including the positions of all the sources. Selecting a source of onlooker bees is based on the value of  $F(\theta)$ . The more nectar amount of a source denotes more probability that the source would be selected. It means that, the probability of selecting a nectar source in the position is:

$$P_i = \frac{F(\theta_i)}{\sum_{k=1}^S F(\theta_k)} \quad (8)$$

After the onlooker bee observes the dance of the employed bees and selects the source with the equality (equation (8)), it identifies a neighboring source and takes its nectar. The position information of the chosen neighbor is computed by the following:

$$c + 1 = \theta_i(c) \pm \phi(c) \quad (9)$$

$\phi(c)$  is evaluated by considering the difference of certain parts of  $\theta_i \ c$  and  $\theta_k(c)$ , where  $k$  is different from  $i$ , are randomly formed indices of a solution in the population. If the nectar amount of  $\theta_i(c + 1)$ ,  $F(\theta_i(c + 1))$ , is greater than the nectar amount in the position  $\theta_i \ c$ , then the bee goes to its beehive and shares this data with the other bees and keeps  $\theta_i(c + 1)$  in the mind as a new position. Or else, it goes on keeping  $\theta_i \ c$  in mind. If the nectar source of the position  $\theta_i$  is not realized by the number of ‘limit’ parameter, then the source in the position  $\theta_i$  is discarded and the bee of that source becomes scout bee. The scout bee creates random researches and identifies a new source and the new found source is assigned to  $\theta_i$ . The algorithm iterates to the preferred cycle number, and the sources having the best nectar in mind denote the possible values of the variables. The obtained nectar amount denotes the solution of the object function.

The system is solved for the stabilization of the power system to solve the optimization problem and search for optimal set of PSS parameters,  $\{K_i, T_{1i}, T_{3i}, i = 1, 2, \dots, n_{PSS}\}$ . When the solution steps stated in the ABC algorithm are applied, it gives better stabilization results.

This proposed Artificial Bee Colony (ABC) provides significant convergence and stabilization for the multi-machine power system.

**4. Experimental Results**

The evaluation for the power system stabilization is presented in this section. The power system stabilization using proposed ABC optimization technique is evaluated by comparing with the power system stabilization using Genetic Algorithm (GA) and Non Dominated Ranked Genetic Algorithm (NRGA). The controller parameters such as lower bound and upper bound are altered to 0 and 60 respectively.

Table 1 shows the loading of the generators G1, G2 and G3 in the proposed multi-machine power system. Three cases are given in Table 1 and the coreresponding values of P and Q are tabulated of all the three cases.

TABLE 1  
Generator loading in pu

Gen	Case 1		Case 2		Case 3	
	P	Q	P	Q	P	Q
G <sub>1</sub>	0.71	0.25	2.19	1.06	0.34	1.10
G <sub>2</sub>	1.62	0.07	1.92	0.55	2.00	0.56
G <sub>3</sub>	0.84	-0.10	1.28	0.36	1.51	0.38

Table 2 shows the loads used in A, B and C for the proposed multimachine power system stabilization approach.

TABLE 2

Load loading in pu

Load	Case 1		Case 2		Case 3	
	P	Q	P	Q	P	Q
A	1.24	0.51	2.01	0.80	1.50	0.91
B	0.90	0.30	1.81	0.61	1.21	0.81
C	1.00	0.34	1.51	0.60	1.00	0.52

TABLE 3

Electromechanical Mode Eigenvalues

Case 1		
GA	NRGA	ABC
-0.023±j8.921	-0.045±j7.745	-0.056±j7.012
-0.845±j13.45	-0.845±j13.16	-0.913±j12.01
Case 2		
GA	NRGA	ABC
-0.034±j8.441	-0.064±j8.042	-0.073±j8.001
-0.651±j13.01	-0.651±j12.17	-0.702±j12.01
Case 3		
GA	NRGA	ABC
0.287±j7.925	0.201±j7.120	0.194±j7.011
-0.636±j12.02	0.699±j11.22	0.801±j11.12

Table 3 shows the electromechanical mode eigenvalues. The table shows the comparison of the eigen values for stabilization with GA, NRGA and proposed ABC multimachine power system stabilization approach. It is clearly observed from the table that the proposed ABC approach has very less electromechanical mode eigenvalues in all the three cases when compared with the GA and NRGA approaches. Thus the proposed stabilization technique with ABC approach provides significant performance.

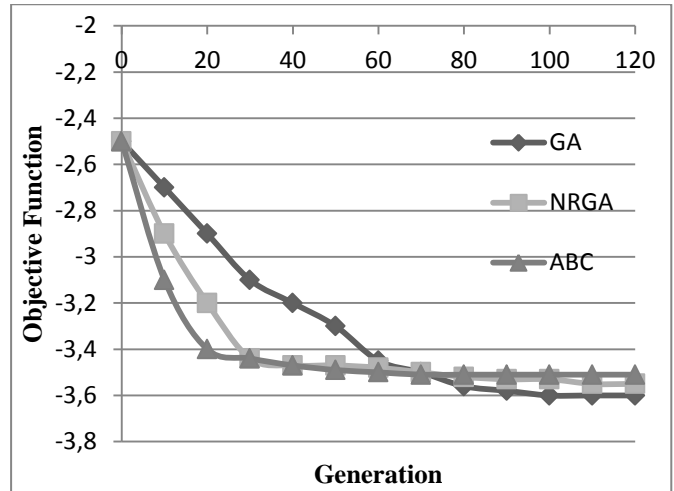

Figure 4: Comparison of Objective Function

Figure 4 shows the comparison of the objective function of the GA, NRGA and the proposed ABC approach. It is observed from the figure that the convergence of the ABC is better than GA and NRGA. Thus the proposed ABC technique is very significant when compared with the GA, NRGA approaches.

For evaluation, the load disturbance of 5 % is induced in the considered power system at time 1 second. Then the load disturbance induced power system undergoes stabilize using power system stabilization techniques using GA, NRGA and the proposed ABC power system stabilization technique. The controller parameters are adjusted in order to stabilize the system.

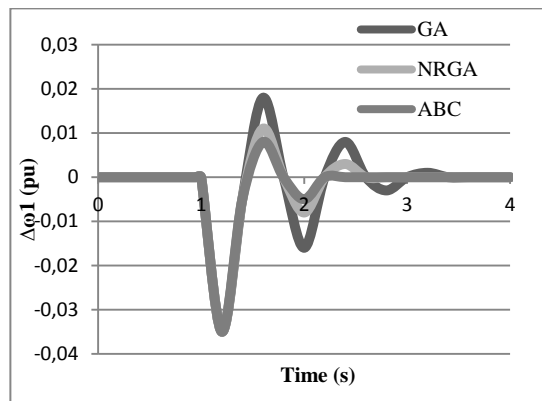
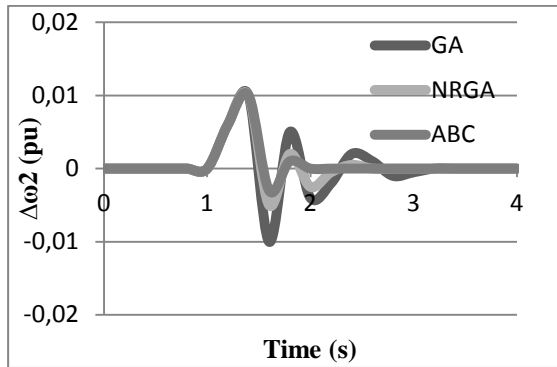
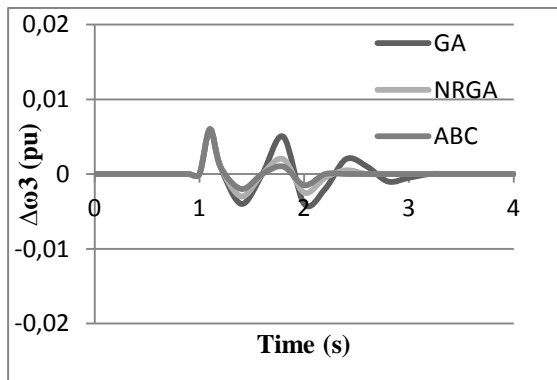

Figure 5: System Response under fault disturbance for Δφ<sub>1</sub>



**Figure 6:** System Response under fault disturbance for  $\Delta\omega_2$



**Figure 7:** System Response under fault disturbance for  $\Delta\omega_3$

$\Delta\omega_1$ ,  $\Delta\omega_2$  and  $\Delta\omega_3$  deviations that occur in power system because of the introduction of 5 % load disturbance are provided in figure 5, 6 and 7 respectively. The figure depicts the stabilization behavior for using GA, NRGGA and the proposed ABC for optimizing stability parameters. From the figure, it can be observed that initially the system is stable until 1 second, after that the system becomes unstable because of load disturbances. The usage of GA for stabilizing takes around 4 seconds for making the system stable and around 3 second is required for the NRGGA technique to stabilize the system. But the proposed ABC technique takes only 2.2 seconds for stabilizing the system.

The effect of load disturbances on bus voltages is an important factor to be considered. When the load disturbance is applied, there will be fluctuation in the bus voltages. So, this fluctuation has to be optimized through effective optimization. This scenario is considered as the future enhance of this research work.

## 5. Conclusion

The demand for stabilization of the multi-machine power systems has been attracting wide range of researchers. There are various techniques available in the literature to carry out the stabilization of power systems. But, most of the techniques suffer from convergence problem.

Recently, optimization algorithms have been widely used for the stabilization of the power systems. This proposed approach uses a novel Artificial Bee Colony technique for the power system stabilization. ABC technique has better convergence than the existing techniques. The performance of the proposed approach is compared with the stabilization using the optimization techniques like Genetic Algorithm and Non Dominated Genetic Algorithm. The simulation results indicate that the proposed technique results in better stabilization than the existing techniques. The objective functions for the multi-machine power system taken into consideration shows better convergence with proposed ABC approach. The future scope of this approach would be to use better optimization techniques which can provide better results.

## 6. References

- [1] Rong He, Kang-Zhi Liu, Shengwei Mei and Xiaoyang Gui, "A Gain-Scheduled State Feedback Control Method For The Transient Stability Control of A Single-Machine Infinite-Bus Power System", pp. 2147 – 2152, 2006.
- [2] M. Ouassaid, A. Nejmi, M. Cherkaoui, and M. Maaroufi, "A New Nonlinear Excitation Controller for Transient Stability Enhancement in Power Systems" World Academy of Science, Engineering and Technology, vol.8, 2005.
- [3] T. Senjyu, R. Kuninaka, N. Urasaki, H. Fujita, T. Funabashi, "Power System Stabilization based on Robust Centralized and Decentralized Controllers", The 7th International Power Engineering Conference, (IPEC), vol. 2, pp. 905 – 910, 2005.
- [4] P.M. Anderson, A.A. Fouad, "Power System Control and Stability", Iowa state university press, Ames, 1977.
- [5] O. P. Malik, G. S. Hope, Y. M. Gorski, V. A. Ushakov, A. L. Rakevich, "Experimental Studies on Adaptive Microprocessor Stabilizers for Synchronous Generators," in IFAC Power System and Power Plant Control, pp. 125–130, 1986.
- [6] E. V. Larsen and D. A. Swann, "Applying power system stabilizers, P-III," IEEE Trans. Power Appar. Syst., vol. PAS-100, pp. 3017– 3046, 1981.
- [7] H. Werner, P. Korba, T. C. Yang, "Robust Tuning of Power System Stabilizers using LMI-techniques," IEEE Trans. Control System Technology, vol. 11, no. 1, pp. 147–152, 2003.
- [8] N. S. D. Arrifano, V. A. Oliveira, R. A. Ramos, "Design and Application of Fuzzy PSS for Power Systems Subject to Random Abrupt Variations of the Load", Proceeding of the 2004 American Control Conference Boston, Massachusetts June 30 - July 2, 2004
- [9] L.H. Hassan, M. Moghavvemi, H.A.F. Mohamed, "Power System Stabilization based on Artificial Intelligent Techniques; A review", 2009 International Conference for Technical Postgraduates (TECHPOS), pp. 1-6, 2009.
- [10] Owaied H. Hussein , Abu-Arr'a M. Mahmoud, "Functional Model of Human System as knowledge Base System" , The International Conference on Information & Knowledge Engineering , pp. 158-161, 2007.
- [11] G. Beni, and J. Wang, "Swarm Intelligence", In Proceedings Seventh Annual Meeting of the Robotics Society of Japan, Tokyo, RSJ Press, pp. 425-428, 1989.

- [12] Hussein Owaied, Saif Saab "Modeling Artificial Bees Colony System", IC-AI: pp. 443-446, 2008.
- [13] K.A. Folly, M. Magidimisa, "Power Systems Stabilization Considering System Uncertainties", IEEE Power Engineering Society Inaugural Conference and Exposition in Africa, pp. 249 – 255, 2005.
- [14] Yoshitaka Miyazato, Tomonobu Senjyu, Ryo Kuninaka, Naomitsu Urasaki, Toshihisa Funabashi, Hideomi Sekine, "Multi-Machine Power System Stabilization Control by Robust Decentralized Controller Based on Optimal Sequential Design", PSCE, 2006.
- [15] N. S. D. Arrifano, V. A. Oliveira, R. A. Ramos, N. G. Bretas, R. V. Oliveira, "Fuzzy Stabilization of Power Systems in a Co-Generation Scheme Subject to Random Abrupt Variations of Operating Conditions", IEEE Transactions on Control Systems Technology, vol. 15, no. 2, pp. 384 – 393, 2007.
- [16] T. Senjyu, D. Hayashi, E. Omine, A. Yona, T. Funabashi, H. Sekine, "Stabilization Control for Remote Power System by Using  $H_{\infty}$  Decentralized Controllers", IEEE Power Engineering Society General Meeting, pp. 1 – 8, 2007.
- [17] Li Xiaohua, Wu Wenbo, "Research on Robust Decentralized Connective Stabilization Control for Power Systems Expanded Capacity on Line", 2010 8th World Congress on Intelligent Control and Automation (WCICA), pp. 3404 – 3409, 2010.
- [18] M. H. Khammash, V. Vittal, C.D. Pawloski, "Analysis of Control Performance for Stability Robustness of Power Systems", IEEE Trans. on Power Systems, vol. 9, no. 4, 1994.
- [19] Soon Kiat Yee, J.V. Milanovic, "Fuzzy Logic Controller for Decentralized Stabilization of Multimachine Power Systems", IEEE Transactions on Fuzzy Systems, vol. 16, no.4, pp. 971-981, 2008.
- [20] H. M. Soliman, A.L. Elshafei, A.A. Shaltout and M. F. Morsi, "Robust Power System Stabilizer", IEE Proc. Electr. Power Appl., Vol. 147, No. 5, 2000.
- [21] V.H.C. Alcalde, A.A. Fernandes, L.R. Soares, "Electrical Power Systems Stabilization through Series Compensation by using Variable Structure Control", International Workshop on Variable Structure Systems, VSS'06, pp. 98-104, 2006.
- [22] O. Abedinia, B. Wyns, A. Ghasemi, "Robust fuzzy PSS design using ABC", 2011 10th International Conference on Environment and Electrical Engineering (EEEIC), pp. 1 – 4, 2011.
- [23] C. Sumpavakup, I. Srikun, S. Chusanapiputt, "A solution to the Optimal Power Flow using Artificial Bee Colony algorithm", 2010 International Conference on Power System Technology (Powercon), pp. 1 – 5, 2010.
- [24] M. Soliman, E. H. E. Bayoumi, M. F. Hassan, "PSO -- Based Power System Stabilizer for Minimal Overshoot and Control Constraints", Journal of Electrical Engineering, vol. 59, no. 3, pp. 153-159, 2008
- [25] C. Bayliss, B. Hardy, Transmission and Distribution Electrical Engineering, 3rd edition, Newnes, pp. 28, 2007.
- [26] FP. deMello, C. Concordia, "Concepts of Synchronous Machine Stability as Affected by Excitation Control, IEEE Trans PAS, vol. 88, pp.316-329, 1969.
- [27] CM Lim, S. Elangovan, "Design of Stabilizers in Multimachine Power System", IEEE Proc, vol. 132, no. 3, pp 543-551, 1985.
- [28] YL Abel-Magid, MA Abido, S Ai-Baiyat, AH Mantawy, "Simultaneous Stabilization of Multimachine Power Systems via Genetic Algorithms", IEEE Trans PERS, vol 14, no 4, pp 1428-1439, 1999.
- [29] D. Karaboga, "An Idea Based On Honey Bee Swarm for Numerical Optimization", Technical Report-TR06,Erciyes University, Engineering Faculty, Computer Engineering Department 2005.
- [30] HB Arabia, HH Abdallah, "Multi Objectives Reactive Dispatch Optimization of an Electrical Network", Leonardo J. Sci., vol. 10, pp. 101-114, 2007.
- [31] SN Omkar, J Senthilnath, "Artificial Bee Colony for Classification of Acoustic Emission Signal", Int. J. Aerospace Innov., vol. 1, no. 3, pp. 129-143, 2009.



**V. Ravi** received the B.E. and M.E degrees, from Periyar Univ. and Annamalai Univ. in 2002 and 2004 respectively. After working as a Lecturer (from 2004) in the Dept. of Electrical and Electronics Engineering in MPNMJ Engineering College, Erode, India - affiliated to Anna Univ. and as a Lecturer (from 2007) and as a Assistant Professor (from 2008) in the Dept. of Electrical and Electronics Engineering in K.S.Rangasamy College Engineering College, Tiruchengode, India - affiliated to Anna Univ. and he has been working as a Associate Professor in the Dept. of Electrical and Electronics Engineering at K.S.R. College of Engineering, Tiruchengode, India - affiliated to Anna Univ. since June 2010. His area of interest includes Power Systems. He is a member of ISTE.



**Dr.K.Duraiswamy** received the B.E., M.Sc. and Ph.D. degrees, from the University of Madras and Anna Univ. in 1965, 1968 and 1987 respectively. After working as a Lecturer (from 1968) in the Dept. of Electrical Engineering in Government College of Engineering, Salem - affiliated to Anna Univ. and as an Asst. professor (from 1983) in Government College of Technology, Coimbatore (Anna Univ.), and as a Professor and Principal (from 1995) at K.S.Rangasamy College of Technology (Anna Univ.). He has been working as a Dean in the Dept. of Computer Science and Engineering at K.S.Rangasamy College of Technology, Anna University since 2005. His research interest includes Mobile Computing, Soft Computing, Computer Architecture and Data Mining. He is a Sr. member of ISTE, SIEEE and CSI.