

# COMMUNICATIONS

DE LA FACULTE DES SCIENCES  
DE L'UNIVERSITE D'ANKARA

FACULTY OF SCIENCES  
ANKARA UNIVERSITY

Series A2-A3: Physical Sciences and Engineering

---

**VOLUME: 59**

**Number: 1**

**YEAR: 2017**

---

Faculty of Sciences, Ankara University  
06100 Beşevler, Ankara-Turkey  
ISSN 1303-6009

# COMMUNICATIONS

DE LA FACULTE DES SCIENCES  
DE L'UNIVERSITE D'ANKARA

FACULTY OF SCIENCES  
ANKARA UNIVERSITY

Series A2-A3: Physical Sciences and Engineering

---

**Editor in Chief**  
Nuri ÖZALP

**Managing Editor**  
A. Ulvi YILMAZER

## Area Editors

Ali YAMAN (Physics)

Iman ASKERZADE(Askerbeyli)(Computer Eng.)

Tülay SERİN (Engineering Physics)

Ziya TELATAR(Electronic Engineering)

H. Volkan ŞENAVCI (Astronomy)

M. Emin CANDANSAYAR (Geophysical Eng.)

## Editors

Gabriela CIUPRINA  
Politehnica University of Bucharest,  
ROMANIA

H. Gokhan ILK  
Ankara University, TURKEY

İsa NAVRUZ  
Ankara University, TURKEY

Emre YENGEL  
King Abdullah Uni. of Sci. and Tech.  
(KAUST), SAUDI ARABIA

Murat EFE  
Ankara University, TURKEY

Mustafa E. KAMASAK  
Istanbul Tech. Uni., TURKEY

Hakan TORA  
Atılım University, TURKEY

A. Egemen YILMAZ  
Ankara University, TURKEY

Osman EROGLU  
TOBB Economy and Technology  
University, TURKEY  
İlhan KOSALAY  
Ankara University, TURKEY

Miroslav VOZNAK  
VŠB – Tech.Uni. of Ostrava, CZECH  
REPUBLIC

Roy L. STREIT  
Uni. of Massachusetts at Dartmouth, USA

This Journal is published two issues in a year by the Faculty of Sciences, Ankara University. Articles and any other material published in this journal represent the opinions of the author(s) and should not be construed to reflect the opinions of the Editor(s) and the Publisher(s).

### Correspondence Address:

COMMUNICATIONS  
EDITORIAL OFFICE  
Ankara University, Faculty of Sciences  
06100 Tandogan, ANKARA – TURKEY  
**Tel: (90) 312-212 6720 Fax: (90) 312-223 5000**

e-mail: [commun@science.ankara.edu.tr](mailto:commun@science.ankara.edu.tr)

<http://communications.science.ankara.edu.tr/index.php?series=A2A3>

### Print:

Ankara University Press  
Tandogan Campus 06100  
ANKARA – TURKEY  
Tel: (90) 312-215 9001

# COMMUNICATIONS

DE LA FACULTE DES SCIENCES  
DE L'UNIVERSITE D'ANKARA

FACULTY OF SCIENCES  
ANKARA UNIVERSITY

**VOLUME: 59**

**Number: 1**

**YEAR: 2017**

---

Series A2-A3: Physical Sciences and Engineering

C. YILMAZ, İ. KOŞALAY, Ö. BINARBAŞI, Design and frequency performance  
of a microprocessor based speed governor ..... 1

# **COMMUNICATIONS**

DE LA FACULTE DES SCIENCES  
DE L'UNIVERSITE D'ANKARA

FACULTY OF SCIENCES  
ANKARA UNIVERSITY

**VOLUME: 59**

**Number: 1**

**YEAR: 2017**

---

Series A2-A3: Physical Sciences and Engineering

## DESIGN AND FREQUENCY PERFORMANCE OF A MICROPROCESSOR BASED SPEED GOVERNOR

Cemal YILMAZ<sup>1</sup>, İlhan KOŞALAY<sup>2</sup>, Ömür BINARBAŞI<sup>3</sup>

<sup>1</sup>*Gazi University, Technology Faculty, Electrical and Electronics Eng. Dept., Turkey  
cemal@gazi.edu.tr*

<sup>2</sup>*Ankara University, Engineering Faculty, Electrical and Electronics Eng. Dept., Turkey  
ikosalay@ankara.edu.tr*

<sup>3</sup>*Gazi University, Technology Faculty, Electrical and Electronics Eng. Dept., Turkey  
omur.binarbasi@gazi.edu.tr*

(Received: November 30, 2016; Accepted: January 10, 2017 )

### ABSTRACT

In this study, closed loop and grid independent prototype of 750 W cross-flow turbine whose cycle regulations are done by using adjustable wing mechanism is implemented. Movement to an adjustable wing is performed by direct current motor which is controlled by microcontroller by using screw shaft system and mechanical hand. The frequency of the obtained voltage are controlled in function of that the number of turns of the generator and of the turbine. For the control operation, the voltage frequency obtained from the generator has been measured with the zero crossing circuit and transferred to the microcontroller. With the setting of the number of turns on the turbine, the value of the frequency of the 500 W generator working in conjunction with the turbine is kept on desired levels. These operations are realized by using a PIC16F877 microcontroller. Then, frequency performance of the designed system is examined

**KEYWORDS:** *Microcontrollers, hydroelectric power generation, frequency control.*

### 1. INTRODUCTION

Due to their low cost of establishment and low maintenance cost and need of eliminating dependence of national grids, there is continuously increase in interest in micro hydroelectric power plant. Generally Micro scale hydroelectric systems are used in areas where national energy grids have not reached. The most important topic in hydroelectric power plants (HPP) is governor systems in their structures. Governor mechanisms are used in regulation of turbine – generator speed in power systems. In development of governor system there are three phases; these phases are mechanic- hydraulic

speed regulator, analogy electro-hydraulic speed regulator and digital electro-hydraulic speed control. Digital electro-hydraulic governor is divided in two types, the first of them is full digital control and the other is analogy control of hydraulic part and digital control of the electrical part. Digital governor systems are the mostly used governor mechanisms nowadays. Advantages of these systems include ability to give fast response in transient states, ability to be controlled from remote distance, starting by using single command, ability to be removed from the circuit and ability to control its output power according to grid frequency [1]. Before implementing of mini or micro hydro power plants, some designer prefer to model and simulate the system. Simulations are based on different models [2]. Some simulations contains dynamic modeling [3] and speed variability [4].

Conventional control methods for frequency stabilization in mini and micro hydro power plants generally use PI, PID controllers. In [5], the authors designed a new PID load frequency controller for a single machine infinite bus hydro system. They also mentioned that this controller had better performance than conventional PI controller.

Some scientists have proposed alternative control methods, as to employ ballast/dump load, to stabilize the frequency variation. This kind of control methods is based on digital load controllers. Digital load controller is controlled by using microcontroller. In the system, generator works continuously with the maximum load. This means in order to keep number of revolutions (speed) and its resulting generator frequency constant generator must continuously work at its maximum load. In this system, the water discharge entering the turbine cannot be regulated by any means. In the output of generator, current and voltage are measured. These measured values are processed by microprocessor then in accordance with to the need, ballast load are entered or removed from the circuit. By the help of this process, the generator load is kept constant. Since frequency and voltage do not change, when the power taken from the generator is constant, ideal AC voltage is obtained. However despite the fact that this control system produces ideal energy it has some disadvantages. In this system hydroelectric energy is wasted in ballast load. Turbines continuously work in maximum discharge and the excess amount of energy produced by generator is converted to heat. Henderson and Pearson studied to improve transient response in [6] electronic load governor for micro hydro power plant. Doolla and his collogues [7] designed a new cost-effective technique for load frequency control by reducing the size of dump load.

Due to the needs for optimum control of operating frequency, intelligent control techniques like Fuzzy logic, Neuro-fuzzy and artificial neural

Networks are used in hydro governor systems. Salhi et al. [8] designed a fuzzy logic controller for load frequency control in micro hydro power plant. In their study, two fuzzy sets are used. In an another study, Çam [9] compared PI controller with Fuzzy gain scheduled PI controller (FGPI) for frequency control of hydro power system in single and two area plants.

Among the investigation topics related to micro HPP in general includes; control of speed governor by using motor flux estimation algorithm in order to control effective frequency of micro hydroelectric power plant [10], design of the controller of nonlinear excitations and coordinated governor in hydroelectric power plant for the purpose of developing transient regimes in power system [11, 12], suggestions of solutions for implementation of control of grid dependent or grid independent micro hydro turbines [13], operating system when isolated from the main grid using ballast load and study on precautions against changes in frequency [14], using synchronous permanent magnet in micro HPP and speed control using maximum power point tracker (MPPT) [15], using electrical servo motor as a governor for operating micro hydroelectric power plant in isolated mode and modeling of the system using fuzzy PI and neural network control methods [16].

Some of the proposed controller techniques are also able to stabilize the power system effectively when there are non-linearity in the system as in [17].

In the implemented study, related previous works has been taken into account. By dealing with prototype of micro hydroelectric power plant which operates in closed loop with cross-flow turbine, by using microcontroller the generated electrical frequency is kept in a specified band interval. The generated electrical frequency is continuously measured by using zero crossing circuit and sent to a microcontroller. PIC 16F877 was used as a microcontroller. Movement to the adjustable wing of the turbine was given by DC motor and screw shaft system. Two direction motion of the DC motor was provided by application of the PWM signals generated by microcontroller to a motor through H Bridge. While there is no possibility of regulating amount of water entering the turbine in digital load control systems, in cross-flow turbines water flow rate can be controlled by moving adjustable wing. Cross-flow turbines consist of two main parts; turbine rotor and water spray nozzle. There is an adjustable wing which provides a mechanism of regulating water discharge rate and power by changing cross-section inside input nozzle. Number of wings can be between 25 and 30. Rotor of this structure is empty inside to allow water to pass. Water flow which affect the wings at first time power passes through inside empty space and from inside circle of the rotor enters again between the wings, it generate second force and then leave the turbine [18].

In the study, in order to control the adjustable wing, DC motor is used. MOSFET which is the switching element of the DC motor is controlled in two directions by H bridge motor driver circuit. For controlling the speed of the motor control card which utilizes PWM signal from microcontroller PIC16F877 is employed.

## 2. GENERAL DESIGN OF THE SYSTEM

Figure 1 shows general appearance of the implemented system. In the study, the used adjustable wing of the cross-flow type turbine has been controlled. In the prototype of the micro HPP the turbine works with the free fall of the water. In the system there is a 1500 liters water reservoir at the tower of 7m high. The upper side of the reservoir water by itself through penstock flows to the turbine. The water coming out of the turbine is collected at second reservoir located the ground. The volume of this reservoir is 1000 liters. The general picture of the hydro-mechanical section is given in Figure 2.

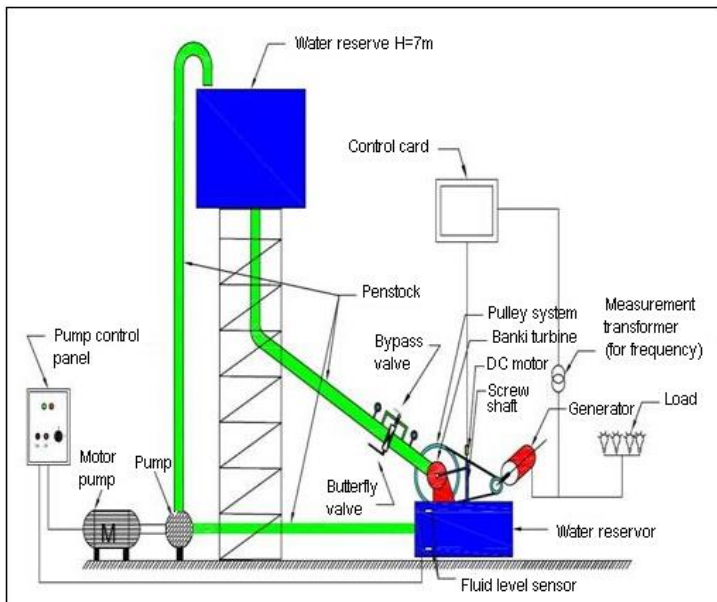

**Figure 1.** General appearance of the system which works in closed loop.





**Figure 2.** hydro-mechanical section general appearance.

The electro-mechanical section consists of cross-flow turbine, induction generator, pulley system and the control mechanism of the adjustable wing. In this application the used turbine is selected as a 0.74kW cross-flow type turbine. The mechanical energy obtained from the turning of the turbine is transferred to the generator by the aid of pulley system. The nominal cycle of the turbine is 500 rpm and cycles of the 500W generator is 3000 rpm. In order for cycles of the turbine to reach that of the generator, the cycles of pulley system is made 6 times. The discharge rate of the water entering the turbine is regulated by adjustable wing. Depending on the design of the turbine, adjustable wing moves within a given angle. In our system the movement is transferred to an adjustable wing by using mechanical hand connected at the shaft of the adjustable wing. The other hand of the mechanical hand is connected to screw shaft system. Screw shaft system provides the up and down movement of the carrier shaft by moving the motor direct current in the two directions. The connection between mechanical hand coming from adjustable wing and carrier shaft is established and up and down movement of the carrier shaft regulates the position of the adjustable wing.

### 3. CONTROL SECTION

In control section, PIC 16F877A is used. The frequency of the voltage obtained from generator is read with zero crossing circuit which is shown in

Figure 3 and compared with reference value of 50Hz, PWM signal is generated with respect to the obtained error. By this mechanism direct current motor is controlled and the frequency of the voltage coming for generator is set to 50Hz.

Output frequency of the generator depends on two parameters; number of cycles (n) and number of poles (p). Since number of poles in generator is constant the only factor which affects the frequency is the number of cycles. In order to control the frequency of the generator, the number of cycles of the turbine should be controlled. Number of cycles of turbine depending on opening and closing condition of the adjustable wing changes with amount and pressure of water applied to a turbine. For design in this study, control card made to continuously measure the frequency of the voltage at the output of generator ( $f_o$ ) using zero crossing circuit and compare with the reference  $f_{ref} = 50\text{Hz}$  and according to error between the measured frequency value and reference value PWM signal is generated inside the PIC. By using this generated PWM signals the opening and closing operation of adjustable wing is performed and is applied to H bridge circuit which control DC motor. In this way DC voltage coming from H bridge circuit DC motor with the calculated speed by accordingly turns back and forward or keep its position tries to regulate the position of adjustable wing.

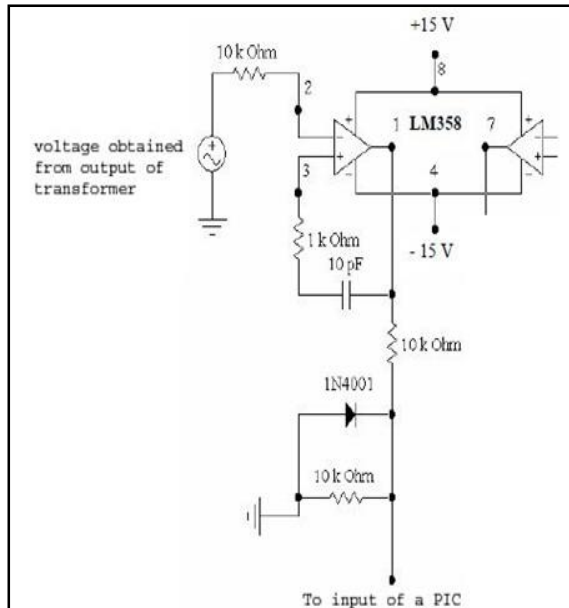

**Figure 3.** Zero crossing circuit

In control card, there exists a part which gives the system a DC voltage of 5V. A LCD screen for observing the values read from output of generator and coefficient of PID (proportional-integral-derivative) parameter formed by PWM signals is also connected. The start and stop button on the card help to start and stop the system. Lower limit and upper limit buttons are used for the purpose of testing the system in the laboratory. In real life application switches to be connected to terminal which is parallel to lower and upper limit buttons are used to specify the boundaries of movement of adjustable wing. These boundary switches help us to end automatically commands from control card. If there was no these boundary switches appearance of faults in mechanical systems would be unavoidable. The LED's in the card are used to understand whether its corresponding output is active or not.

During specifying the microcontroller which is going to be used in this study whether the output and input number needed by the PIC and PWM for controlling direct current motor exist or not has been checked. The knowledge which is taken from external environment is the frequency taken from zero crossing circuit. This information is read by interrupt except for port RBO. The other information is the normal inputs which are connected to limit switches which tell the open or closed state of the adjustable wing. PWM signals are taken as output of the PIC. PIC 16F877A is the one which easily satisfies these input and output specifications.

In the designed system, system in order to keep frequency of the generator which is connected to the turbine to a constant value of 50Hz, turbine adjustable wing must be controlled. This is implemented by controlling the motor with the PWM signals generated by the PIC. This operation is implemented by pressing of start button on the control card and some conditions and logics inside the PIC.

The frequency is being kept in a certain reference interval. According to UCTE criteria minimum instant frequency should not be below -800 mHz (49.2 Hz) and maximum instant frequency should not be more than +800 mHz (50.8 Hz) [19]. The reference boundary values of frequency used in written program for PIC were specified by considering these values.

#### **4. RUNNING OF THE PIC PROGRAM**

When the energy is supplied to a system, the program at first measures frequency of the generator by using zero crossing circuit. The measured frequencies are shown on the screen after every reading and after giving the command to a program. When the start button is pressed, PIC compares the measured value ( $f_o$ ) and the reference value ( $f_{ref}$ ). In this way error ( $f_{error}$ )

is found. By using the calculations in PID control this error generates PWM output signals. If we are to explain the PWM signals obtained from PIC according to the values of the measured frequency; when frequency is lower than 49.2 Hz in order for the direct current motor to quickly open the adjustable wing to apply the voltage of 24V to the motor PWM is generated. By using this, the system in a fast way possible opens the adjustable wing and increases the flow of water entering the turbine and in connection with this cycles of turbine and generator increases as a result the measured frequency is brought toward 50 Hz. In order for the DC motor to turn the adjustable wing in the opening direction the generated PWM signals operates switching elements S2(Q7) and S3(Q6) on the motor driver circuit. If the measured frequency is in interval of 49.2 and 49.8 since the measured frequency has not yet reached 50Hz direct current motor opens the adjustable wing and works in the direction of increasing amount of water flow. However here since frequency needed for application of maximum voltage to a direct current motor is above 50Hz, direct current motor regulates the number of cycles by using PID controller and the PWM signals is applied to a motor until the measured frequency reaches 49.8 Hz. If the measured frequency is between 49.8 Hz and 50 Hz microcontroller does not generate PWM signals to move the adjustable wing and in that way the frequency is kept stable in a required band interval. As long as there is no any change in receiver load and there is no mechanical or hydraulic change which can affect the system operation, frequency stays constant.

If the measured frequency is between 50.2 Hz and 50.8 Hz in order to bring the frequency to a reference value adjustable wings should be moved to a closing direction. By this way the amount of water flow entering the turbine will slow down and turbine cycles will decrease. Since decreased in turbine cycles decrease cycles of generator as well, then the frequency is being lowered in that way. For the measured frequency between 50.2 Hz and 50.8 Hz microcontroller generates PWM signals and switching elements s1 and s4 in motor driver circuit are being activated. By the help of this direct current motor moves the adjustable wing to the closing direction. In this operation the system is controlled by PID controller in every 5 cycles until the result of a taken measurement is controlled until it reach the require band interval. When the required band interval is attained adjustable wing (49.8 Hz and 50.2 Hz) is kept constant. If the frequency value is greater than 50.8 Hz the system automatically close. Lower limit and upper limit are used to specify the boundaries of the hand which moves adjustable wing. When this limit touches the switches the system stops and motor and mechanical system goes to protective mode.

On the designed circuit, zero crossing circuit helps to read electrical frequencies from the output of the generator. The function of the zero crossing circuit here is to give the logical value of 1 at the instant the voltage coming from transformer crosses zero. In zero crossing circuit OPAMP LM 358 was used. The output voltage of the transformer is applied at the input number 6 of the OPAMP. Zero crossing voltage are determined by using output number 6 of the OPAMP. By detecting the obtained signals using RBO of the controller, it is processed by microcontroller and is used during the reading of the frequency as in [20]. The transformer used in zero crossing circuit is connected to the output of the generator. The maximum value of voltage obtained from transformer is selected to be 5V. To control DC motor, H bridge circuit is used. Since the DC motor used in our application is of high power switching element used is IRFZ44N 55 volt and 49 amperes MOSFET. In order to bring MOSFET to conduction PC 817 optocoupler was used. Figure 4 shows control card, LCD screen, zero crossing circuit and H Bridge when they are connected to each other.

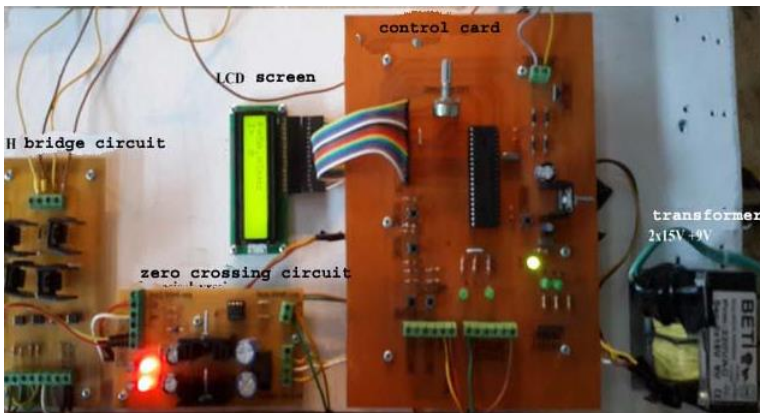

**Figure 4** Complete circuit used in application.

## 5. APPLICATION

In the designed system, by using microcontroller the position of adjustable wing of the cross-flow turbine is changed by the DC motor. As a result, number of cycles of generator and its frequency are regulated. The measured frequency from the output of generator is measured by zero crossing circuit and the measured value is controlled by PID control method using microcontroller. The frequency value is being kept between the specified frequency intervals.

While testing of the system starts, the butterfly van on penstock opens and turbine slowly gain speed. In this moment energized control card continuously

measures frequency of the generator and measured values are shown on the LCD screen. When the start button on the control card is pressed, in accordance with program codes inside microcontroller implementation of control process starts and frequency of 50Hz is kept constant. At this time generator works no-load. To test how the system works when there is a load, the bulbs connected to the output of the generator are entered to a circuit in stages. In every stage two 60 W incandescent film lamp is used. By taking load one by one to a system makes system to work fast and in order to keep output frequency 50Hz constant adjustable wing opens. In same condition taking load out of the circuit one by one has been tested and also system quickly works in the closing direction of adjustable wing and frequency of 50 Hz was kept constant.

In the study by using microcontroller governor control of the prototype of the micro HPP which works independent of the grid has been implemented. During doing this work the electrical frequency obtained from the output of the generator which is connected to a turbine was taken to account and frequency 50 Hz is kept constant. The change in the load on the receiver causes the momentarily frequency changes. On the designed control card frequency of generator is continuously measured by using zero crossing circuit. PWM signals generated by the microcontroller and DC motor are operated in both directions in controlled manner. Due to this the position of adjustable wing of the turbine is being changed and frequency of 50 Hz is kept constant.

#### Loading test of the system:

At first, generator was operated at idle mode (no-load) at all loading levels while the load test is running. After the frequency was kept at 50 Hz, loads were connected to the generator respectively. Tests were made for loads which had level %25, %50, %75, and % 100. Frequency variations which belong to loading are given in Figure 5 and 6.

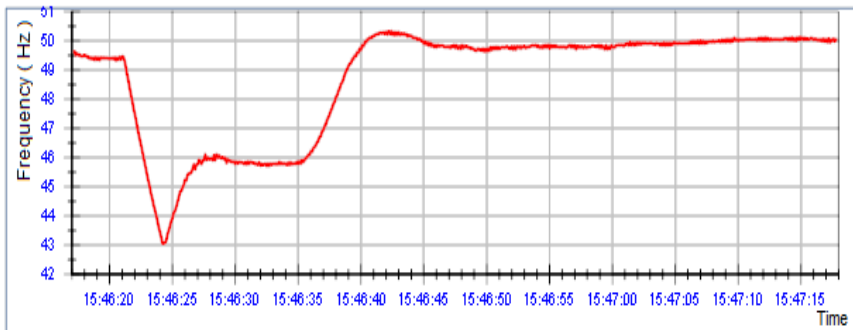

**Figure 5.** Frequency variation for loading, % 50

As it is understood from Figure 5, there is no striking peak value in frequency when the load is connected to generator. Frequency decreases its lowest value in 2-3 seconds. Together with the opening of the adjustment wing, turbine speeds begins to increase. After a while, frequency becomes constant.

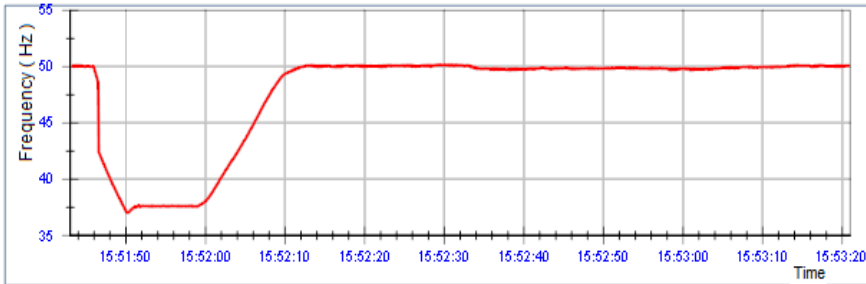
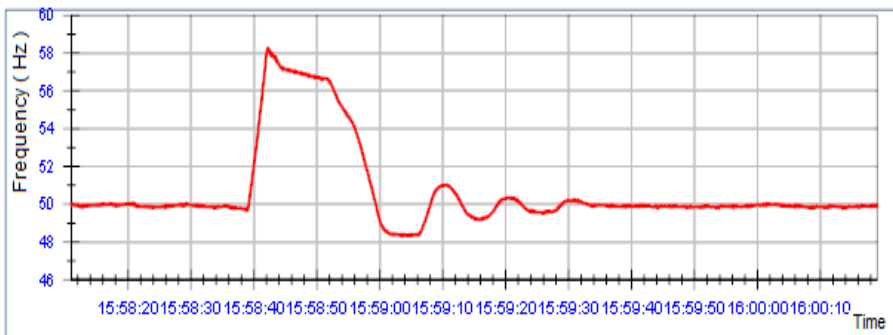

**Figure 6.** Frequency variation for loading, % 100

At % 100 loading test, after the switching operation the frequency is reduced too quickly. Then, the frequency increases again very quickly.

Load shedding test of the system:

Generator was operated at full load at all load shedding levels while the load shedding test is running. After the frequency was kept at 50 Hz, the loads were separated from the generator respectively. Tests were repeated for loads which had level %25, %50, %75, and % 100. Frequency variations which belong to some load shedding levels are given in Figure 7 and 8.



**Figure 7.** Frequency variation for load shedding, % 50

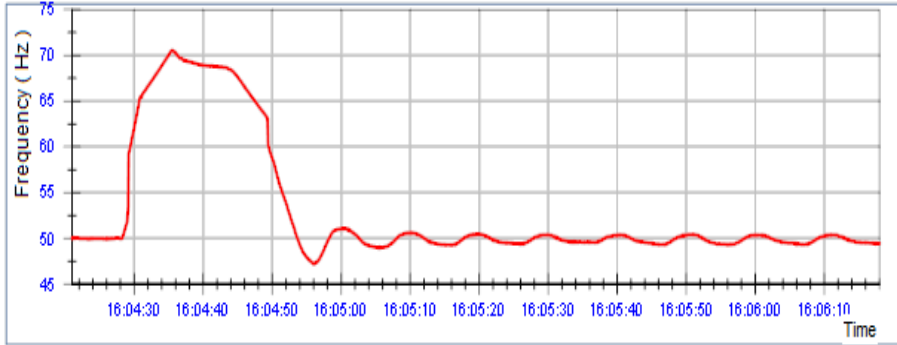

**Figure 8.** Frequency variation for load shedding, % 100

## 6. CONCLUSIONS

In this study, closed loop and grid independent prototype of 750 W cross-flow turbine whose cycle regulations are done by using adjustable wing mechanism is implemented. Movement to an adjustable wing is performed by direct current motor which is controlled by microcontroller by using screw shaft system and mechanical hand. By setting the number of cycles (speed) of the turbine, the number of cycles and frequency of the 500 W generator which is connected to a turbine is kept at required values. By the help of study implemented using microcontroller, conclusion that this technique is more economical than other micro hydroelectric plant control methods been presented and also its performance for frequency is evaluated at good level for most practical applications.

The study is performed on cross-flow type turbine. It is possible to apply the same control technique to Pelton turbines. With the investment to be made, in the future times implementations of control systems of the micro turbine using microcontrollers will provide more development in the sector and will bring possibility of easily controlling both grid dependent and independent micro HPP. Microcontroller based control system together with its low cost; it will be a measure to any country from spending money to abroad.

## REFERENCES

- [1] A. Dalcalı, E. Çelik, S. Arslan, Design of a microprosper based electronic governer system for micro and mini hydroelectric power systems, Erciyes University, Science Institute Journal, (2012) 130-135.



- [2] A. Amevi, B. H. Essel, X. F. Francois, Review of Hydropower Plant Models, *International Journal of Computer Applications*, 108/18 (2014) 0975 – 8887.
- [3] J. L. Marquez, M. G. Molina, J. M. Pacas, Dynamic modeling; simulation and control design of an advanced micro-hydro power plant for distributed generation applications, *international journal of hydrogen energy*, 35 (2010) 5772-5777.
- [4] A. Ansel, B. Robyns, Modeling and simulation of an autonomous variable speed micro hydropower station, *Mathematics and Computers in Simulation*, 71 (2006) 320–332.
- [5] A. Khodabakhshian, R. Hooshmand, A new PID controller design for auto- matic generation control of hydro power systems, *International Journal of Electrical Power and Energy Systems*, 32/3 (2010) 75-82.
- [6] D. Henderson, W. Pearson, Electronic load governor – Application of derivative control action for improving transient response, Available: <http://citeseerx.ist.psu.edu/viewdoc/download?doi=10.1.1.567.5216&rep=rep1&type=pdf>
- [7] S. Doolla, T. S. Bhatti, Load frequency control of an isolated small-hydro power plant with reduced dump load, *IEEE Transactions on Power Systems*, 21/191 (2006) 2-9.
- [8] I. Salhi, S. Doubabi, N. Essounbouli, A. Hamzaoui, Application of multi-model control with fuzzy switching to a micro hydro-electrical power plant, *Renewable Energy*, 35/207 (2010) 1–9.
- [9] E. Cam, Application of fuzzy logic for load frequency control of hydro electrical power plants, *Energy Conversion and Management*, 48/128 (2007) 1-8.
- [10] L. G. Scherer, R. F. Camargo, Frequency And Voltage Control of Micro Hydro Power Stations Based on Hydraulic Turbine's Linear Model Applied on Induction Generators, *IEEE Power Electronics Conference (COBEP)*, (2011) 546-552.
- [11] M. J. Jin, W. Hu, F. Liu, S. W. Mei, Q. Lu, Nonlinear Decentralized Excitation and Governor Coordinated Control For Hydraulic Power Plants, *IEEE International Conference on Power System Technology- POWERCON*, 1 (2004) 918 – 923.
- [12] M. J. Jin, W. Hu, F. Liu, S. W. Mei, Q. Lu, Nonlinear Coordinated Control of Excitation and Governor For Hydraulic Power Plants, *IEEE Proc.-Generation Transmission and Distribution*, 152/4 (2005).
- [13] M. Andrecia, S. Bacha, D. Roye, I. E. Qtadui, I. Munteanu, Micro-Hydro Water Current turbine Control For Grid Connected or Islanding Operation, *IEEE Power Electronics Specialists Conference*, (2008) 957-962.

- [14] D. Henderson, An Advanced Electronic Load Governor For Control Of Micro Hydroelectric Generation, IEEE Transactions on Energy Conversion, 13/3 (1998) 300-304.
- [15] M. Sing, A. Chandra, Modeling and Control of Isolated Micro-Hydro Power Plant with Battery Storage System, National Power Electronic Conference (Roorkee India 2000).
- [16] M. Hanmandlu, H. Goyal, D. P. Kothari, An Advanced control Scheme for Micro Hydro Power Plants, IEEE International Conference on Power Electronics Drives and Energy Systems, (2006) 1-7.
- [17] D. Preeti, S. Veena, N. Ram, Solution Approach to Automatic Generation Control Problem Using Hybridized Gravitational Search Algorithm Optimized PID and FOPID Controllers, Advances in Electrical and Computer Engineering, 15/2 (2015).
- [18] C. A. Mackmore, F. Merryfield, The Cross-flow Water Turbine, Engineering Experiment Station, (Oregon State College Corvalins USA 1949).
- [19] M. Bircan, Updating of Frequency control quality of Turkish Electric Power system with UCTE standarts in terms of UCTE connection, World energy council Turkish national committee Turkey, 10. Energy Congress, (2006) 265-273.
- [20] M. Ateş, Design and simulation of power factor measuring circuit with PIC, Master Thesis Yüzüncü Yıl University, Institute of Science and Technology, (2009).

## INSTRUCTIONS TO CONTRIBUTORS

**Communications Faculty of Sciences University of Ankara Series A2-A3: Physical Sciences and Engineering** is a peer reviewed journal which has been published since 1948 by Ankara University, accepts original research articles written in English in the fields of Physics, Engineering Physics, Electronics/Computer Engineering, Astronomy and Geophysics. Review articles written by eminent scientists can also be invited by the Editor.

Manuscripts should be submitted as a single PDF file attached to an e-mail with a covering letter. In the covering letter, authors should nominate three potential reviewers and e-mailed the file to the most appropriate Area Editor of the research. The editorial office may not use these nominations, but this may help to speed up the selection of appropriate reviewers.

Manuscripts should be typeset using the LATEX typesetting system. Authors should prepare the article using the COMMUNICATIONS style before submission by e-mail. Manuscripts written in DOC form are also acceptable. A template of manuscript can be reviewed in <http://communications.science.ankara.edu.tr/index.php?series=A2A3&link=300>. After the acceptance of manuscripts for publication, we will ask you to submit the TeX or Doc form of the manuscript prepared in accordance with the style of the Journal.

Acknowledgements should be given as short as possible at the end of the text. Formulas should be numbered consecutively in parentheses ( ). Footnotes should be avoided if possible, but when necessary, should be short and never contain any important part of the work and should be numbered consecutively by superscripts. All illustrations not including tables (photographs and other films, drawings, graphs, etc) must be labeled as "Figure".

The proper position of each table and figure must be clearly indicated in the paper.

All tables and figures must have a number (Table 1, Figure 1) and a caption or legend. References including comments must be numbered consecutively in order of first appearance in the text. The reference number should be put in brackets [] where referred to in the text. References should be listed at the end of the manuscript in the numbered order in which they appear in the text as follows:  
[1] Bairamov, E, Ozalp N. "Uniform convergence and numerical computation of the Hubbell radiation rectangular source integral", Radiation Physics and Chemistry, 80 (2011) 1312–1315.  
[2] Kelley, J. L., General Topology, Van Nostrand, 1970.

It is a fundamental condition that articles submitted to COMMUNICATIONS have not been previously published and will not be simultaneously submitted or published elsewhere. After the manuscript has been accepted for publication, the author will not be permitted to make any new additions to the manuscript.

Before publication, the galley proof is sent to the author for correction. Thus, it is solely the author's responsibility for any typographical mistakes occur in their article as it appears in the Journal. The contents of the manuscript published in the COMMUNICATIONS are the sole responsibility of the authors.

The PDF copies of accepted papers are free of charges, but hard copies of the paper, if required, are due to be charged for the amount of which is determined by the administration each year.

Editor in Chief

Commun. Fac. Sci. Univ. Ank. Ser. A2-A3.

Ankara University, Faculty of Sciences

06100, Besevler - ANKARA TURKEY

<http://communications.science.ankara.edu.tr/index.php?series=A2A3>

# COMMUNICATIONS

DE LA FACULTE DES SCIENCES  
DE L'UNIVERSITE D'ANKARA

FACULTY OF SCIENCES  
ANKARA UNIVERSITY

**VOLUME: 59**

**Number: 1**

**YEAR: 2017**

---

Series A2-A3: Physical Sciences and Engineering

C. YILMAZ, İ. KOŞALAY, Ö. BINARBAŞI, Design and frequency performance  
of a microprocessor based speed governor ..... 1