



Istanbul
GEDİK
University

Vol. 1 | No 1
2023

IJONFEST

*International Journal of New Findings In Engineering,
Science and Technology*



INTERNATIONAL JOURNAL OF NEW FINDINGS IN ENGINEERING, SCIENCE AND TECHNOLOGY (IJONFEST)

PUBLISHER

Ahmet Kesik, Professor
Istanbul Gedik University

EDITOR-IN-CHIEF

Redvan Ghasemlounia, Associate Professor
Istanbul Gedik University

ASSOCIATE EDITOR

Bestem Esi, Assistant Professor
Istanbul Gedik University

MANAGER

Gülperen Kordel
Istanbul Gedik University

PUBLICATION COORDINATOR

Şafak Çelik
Istanbul Gedik University

ENGLISH LANGUAGE EDITORS

Antonina Nemtinova, Lecturer
Istanbul Gedik University

Ali Köse, Research Assistant
Istanbul Gedik University

EDITORIAL BOARD (FIELD EDITORS)

Civil and Environmental Engineering

Redvan Ghasemlounia, Associate Professor

Istanbul Gedik University

Computer Engineering

Feridun Özçakır, Assistant Professor

Istanbul Gedik University

Electrical & Electronics Engineering

Murathan Alpay, Assistant Professor

Istanbul Gedik University

Industrial Engineering

Tuğbay Burçin Gümüş, Assistant Professor

Istanbul Gedik University

Mechanical Engineering

Bülent İmamoğlu, Assistant Professor

Istanbul Gedik University

Mechatronics Engineering

Haydar Şahin, Assistant Professor

Istanbul Gedik University

Metallurgical and Materials Engineering

Murat Danışman, Professor

Istanbul Gedik University

Chemistry

Haslet Ekşi Koçak, Professor

Istanbul Gedik University

Physics

Özden Aslan Çataltepe, Professor

Istanbul Gedik University

Mathematics

Pegah Mutlu, Assistant Professor

Istanbul Gedik University

ADVISORY BOARD

Mehdi Mirdamadi, Associate Professor / Islamic Azad University West Tehran Branch
Ahmet Çağdaş Seçkin, Associate Professor / Aydın Adnan Menderes University
Abolfazl Nazari Giglou, Ph.D. / University of Alabama-Birmingham
Mahmood Abbasi Layegh, Assistant Professor / Urmia University
Demet Balkan, Assistant Professor / Istanbul Technical University
Mehmet Kılıç, Associate Professor / Yıldız Technical University
Zeynep Güven Özdemir, Professor / Yıldız Technical University
Yaşar Karabul, Assistant Professor / Yıldız Technical University
Mustafa Armağan, Assistant Professor / Medeniyet University
Feriha Erfan Kuyumcu, Professor / Istanbul Gedik University
İsmail Duranyıldız, Professor / Istanbul Technical University
Özden Aslan Çataltepe, Professor / Istanbul Gedik University
M. Sedat Kabdaşlı, Professor / Istanbul Technical University
Polat Topuz, Associate Professor / Istanbul Gedik University
Ozan Ateş, Assistant Professor / Istanbul Gedik University
Halil İbrahim Uğraş, Professor / Istanbul Gedik University
S.Mahdi Sagheblian, Assistant Professor / Ahar University
Mehmet Ali Baykal, Professor / Istanbul Gedik University
Haslet Ekşi Koçak, Professor / Istanbul Gedik University
Sirvan Khalighi, Associate Professor / Emory University
Ahmet Karaaslan, Professor / Istanbul Gedik University
Hirad Abghari, Associate Professor / Urmia University
Murat Danişman, Professor / Istanbul Gedik University
Gözde Ulutagay, Professor / Istanbul Gedik University
Gözde Ulutagay, Professor / Istanbul Gedik University
Yaşar Mutlu, Assistant Professor / Beykent University
Eralp Demir, Associate Professor / Oxford University
Mustafa Koçak, Associate Professor / Gedik Holding
Mert Tolon, Assistant Professor / Maltepe University
Hojjat Salehinejad, Assistant Professor / Mayo Clinic
Oktay Baysal, Professor / Old Dominion University
Savaş Dilibal, Professor / Istanbul Gedik University
Elif Altıntaş, Assistant Professor / Haliç University
Ahmet Topuz, Professor / Istanbul Arel University
Ahmet Zafer Şenalp, Professor / Doğuş University
Sevinç Gülseçen, Professor / Istanbul University
Ertuğrul Taçgın, Professor / Doğuş University
Sunullah Özbek, Professor / Doğuş University
Ahmet Güllü, Ph. D. / Texas State University
Semra Birgün, Professor / Doğuş University
Gökhan Bulut, Professor / Haliç University
Emel İrtem, Professor / Doğuş University
Tuba Bayraktar, Ph.D. / General Electric
Sahar Azarkamand, Ph. D. / UNESCO
Kaveh Ghasemloo, Ph.D. / Google
Saber Taghavipour, Ph.D. / Coates
Hamed Fazli, Ph.D. / Profielnorm

TABLE OF CONTENT

- DESIGN OF A COLD STORAGE WITH R507A REFRIGERANT FOR THE PRESERVATION OF TWENTY-FIVE TONS OF APPLES IN THE ANKARA PROVINCE
Berker Özün Fenni, Ali Köse, Parisa Heidarnejad
P:1-14
- QUANTIFYING THE EFFECTS OF CLIMATE CHANGE ON SIMINEH RIVER DISCHARGE IN LAKE URMIA BASIN
Hirad Abghari, Mahdi Erfanian
P:15-25
- DETERMINATION AND STATIC ANALYSIS OF THE CHASSIS MODEL FOR ELECTRIC VEHICLES
Koray Erhan, Mustafa Can Kurt, Feriha Erfan Kuyumcu
P: 26-35
- IMPROVING THE THERMAL COMFORT OF THE STRUCTURES BY APPLYING THE SUSTAINABLE ENGINEERING REQUIREMENTS
Basheer Majeed Ali, Redvan Ghasemlounia
P: 36-46
- EXPLORING ORGANIZATIONAL PERSPECTIVES ON SUSTAINABLE DEVELOPMENT: A COMPARATIVE STUDY OF COMPANIES IN DUBAI AND ISTANBUL
Basheer Bambouk, Tuğbay Burçin Gümüş, Gözde Ulutagay
P: 47-52
- IMPROVEMENT OF FOREST ROADS, CASE STUDY: THE ACCESS ROAD TO THE GOLIRAN COAL MINE IN MAZANDARAN PROVINCE, IRAN
Mahdi Pourmojarab
P: 53-75
- DETERMINING THE APPROPRIATE TRANSPORTATION OPTION WITH THE DECISION TREE
Ozan Ateş
P: 76-82

FROM EDITOR

Dear researchers,

We are happy to be publishing the first issue of the International Journal of New Findings in Engineering, Science and Technology (IJONFEST). In this regard, we would like to thank both our authors who prepared and submitted their scientific studies, which require intensive labor, and our valuable referees, who put forward their experiences, knowledge and dedication, without any other motivating factor other than the academic responsibility and the happiness of contributing to the field, in order to turn these studies into a more qualified and scientific study. In addition, I would like to thank all the members of our journal team, who, as the third part of the trivet, ensure that the articles meet the relevant readership.

This issue includes seven research articles. Considering the topics of the articles published in this issue, it is obvious that our journal complies with the principle of subject diversity, which is one of our publishing principles.

We hope that our current new issue will contribute to the relevant areas and look forward to your valuable researches/articles to be published in the next issue of our journal.

Assoc. Prof. Dr. Redvan Ghasemlounia

Editor-in-Chief

International Journal of New Findings in Engineering,
Science and Technology (IJONFEST)



September 2023, Vol:1, No:1

International Journal of New Findings in Engineering, Science and Technology

journal homepage: <https://ijonfest.gedik.edu.tr/>



Design of a Cold Storage with R507A Refrigerant for the Preservation of Twenty-Five Tons of Apples in the Ankara Province

Berker Özün Fenni^a, Ali Köse^{b*}, Parisa Heidarnjad^c

^aB.Sc. in Mechanical Engineering, Türkiye, berker.ozun@hotmail.com

^bResearch Assistant, Faculty of Engineering, Department of Mechanical Engineering, Istanbul Gedik University, Türkiye, ali.kose@gedik.edu.tr (*Corresponding Author)

^cAssistant Professor, Faculty of Engineering, Department of Mechanical Engineering, Istanbul Gedik University, Türkiye parisa.heidarnjad@gedik.edu.tr

Abstract

In the absence of proper humidity and temperature conditions, undried fresh foods will experience physiological and biological deterioration, resulting in mass loss and the development of mold. Thanks to this rationale, humanity has endeavored to keep food products from deteriorating. This can be observed through the use of cold rooms constructed by the Ancient Romans using clay and the cooling chambers known as "Yakhchāl" developed by the Persians. The advancement of refrigeration technology has persisted since the era of ancient civilizations. The advent of refrigeration cycles has significantly streamlined the implementation of containment technology. The presence of these systems in residential settings can be attributed to the development of the vapor compression refrigeration cycle and the compact nature of this technology, which enables convenient freezing or cooling of products for storage purposes. Vapor compression refrigeration cycles are still widely employed in various applications, such as office and automotive air conditioning systems, refrigerators, and industrial cold rooms. This study aims to develop an industrial cold room design tailored explicitly for storing and transporting apples, a perishable agricultural commodity. The primary objective is to ensure that the apples are maintained in optimal humidity and temperature conditions, thereby preventing any degradation, even when handling large quantities in Ankara.

Keywords: Refrigerant; Cold storage; Vapor compression cycle; Refrigeration; Fresh food

1. INTRODUCTION

The cooling process is commonly referred to as a closed cycle, wherein heat is transferred from the surrounding environment to a different location using a refrigerant [1]. The vapor compression refrigeration cycle is used to lower the temperature of a medium through the cooling process resulting from the phase transition of the refrigerant.

Throughout history, humanity has employed diverse methodologies dating back to ancient civilizations in order to preserve and extend the shelf life of food. Architectural remnants attributed to ancient civilizations, including the Greeks, Romans, Sumerians, and Persians, are extant. One notable illustration of such architectural structures is represented by the Yakhchāls, which the ancient Persians ingeniously constructed for passive cooling and food preservation. These structures are outfitted with walls that possess a dome-shaped configuration and are constructed using a combination of clay and diverse composite materials. Additionally, these structures are equipped with channels that are interconnected to a nearby water source and propellers that facilitate air circulation within the interior.

In 1916, the DOMELRE company introduced an affordable, lightweight, and compact electric refrigerator to the consumer market. During that period, certain refrigerants, namely ammonia (R717), chloromethane (R40), and sulfur dioxide (R764), were used due to a lack of awareness regarding their detrimental effects on the environment [1-3]. The development of the initial chlorofluorocarbon, R-12, which was less harmful to the environment, occurred in 1928 thanks to progress in chemical technology [4]. Following that, two professors with ties to the University of California elaborated on the detrimental effects of chlorinated halocarbons on the ozone layer in a 1974 article. As a result, the Montreal Protocol Agreement, enacted in 1984, banned the utilization of these chlorofluorocarbons (CFCs).

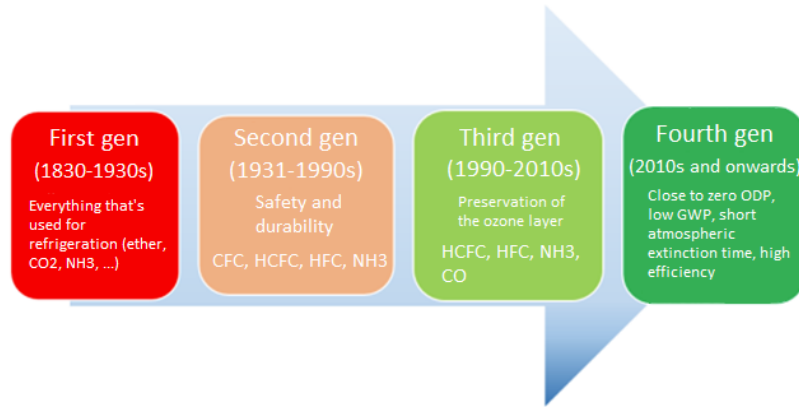

Figure 1. Historical development of refrigerants [5]

In Figure 1, the development of refrigerants throughout history can be seen. Historically, refrigerants incorporating fluorine and ammonia were employed for some time, unknowingly of their detrimental effects on the environment. Consequently, in 1996, a transition was made to hydrofluorocarbon (HFC) based refrigerants [6]. Currently, the most commonly employed refrigerants in industrial and domestic refrigeration systems are R134A, R32, and R125. The refrigerants mentioned in this context have been developed to mitigate the adverse effects of global warming potential (GWP) and ozone depletion potential (ODP) [7].

1.1. Related Literature

A variety of insulation and construction materials have been utilized in the current set of literature, engineered projects, and constructed cold rooms. Each food product has specific storage conditions.

The study, carried out by Koyuncu and Eren [8], involved procuring Granny Smith, Imperatore, and Idared apple cultivars from orchards established with M9 rootstock at the Eğirdir Horticultural Research Institute. The experiment was conducted at the Post-Harvest Physiology Laboratory, which is in the Department of Horticulture within the Faculty of Agriculture at Süleyman Demirel University in Isparta.

The cold room was consistently maintained at a relative humidity level of 90 % to 95 %. Specimens exhibiting physiological deterioration were subjected to a separation process with a one-month interval between each instance. In the initial year study, various apple cultivars, namely Granny Smith, Imperatore, and Idared, experienced mass losses of 0.7 %, 1.19 %, and 0.95 %, respectively, when stored at 0°C for six months. In the second year of the study, the average mass losses of the apples, which underwent a storage period of 6 months at three distinct temperatures (-1°C, 0°C, and 2°C), were observed to be as follows: 1.57–1.7 % for Granny Smith, 1.77 %-2.22 % for Imperatore, and 2.38 %-3.51 % for Idared. Based on the results of this study, the apples stored at a temperature of 0°C exhibited the lowest degree of mass.

According to West and Kedd [9], recent advancements in gas storage technology present a viable alternative to traditional cool rooms for storing apples and pears. Based on the findings of West and Kedd, subjecting apples to a temperature of 1°C resulted in the manifestation of a disease known as "low-temperature breakdown." This condition is characterized by the deceptive appearance of normalcy in the apples, despite their rapid deterioration during the subsequent distribution process. Consequently, in addition to maintaining optimal temperature, it is advisable to store the apples under appropriate humidity conditions.

In another study, a vapor compression refrigeration plant using two different working fluids, R22 and its substitute R417A, was experimentally investigated by Apreo and Renno [10]. The plant is commonly used in commercially available cold stores for preserving foodstuff. Through the experimental analysis, the research team assessed and compared the energetic performances of R22 and R417A. The evaluation was based on various parameters, including the coefficient of performance, exergetic efficiency, exergy destroyed in different plant components, and other variables that characterize the overall performance of the refrigeration system.

Evans et al. [11] conducted an assessment of various methods to reduce energy consumption in food cold stores. They found that many cost-effective improvements, such as enhanced door protection, optimized defrost cycles, control settings, and equipment repairs, could significantly reduce energy usage. In large cold stores (with a capacity greater than 100 m³), these improvements were particularly effective, offering quick payback times. However, in small stores, the options for energy savings were limited, and the payback times were less realistic. By optimizing store usage, repairing existing equipment, and retrofitting

energy-efficient equipment, potential energy savings ranging from 8 % to 72 % were identified. These improvements often yielded short payback times of less than 1 year.

A temperature-controlled cold room kept at 4-6°C was used to store olives in research by Plasquy et al. [12] that found it might postpone further processing and ripening of the olives by up to 4 weeks. It has been observed that by storing the olives until they're processed for oil extraction, it has improved the oil quality. So, the cold room proved its point in prolonging the storage life of olives and in increasing the quality of the olive oil.

2. MATERIALS AND METHOD

2.1. Insulation and Construction Materials

Before determining the total heat transfer coefficient, it is necessary to ascertain the thickness of the structures and the types and thicknesses of insulation materials.

This study used Bloksan companies' expanded polystyrene (EPS) thermo brick, or carbon-reinforced styrofoam, to construct the interior and external walls. The primary feature that sets apart this thermobrick from conventional bricks in the industry is its integration of EPS insulation panels measuring 45 mm in thickness, strategically placed in regions where air gaps commonly occur.

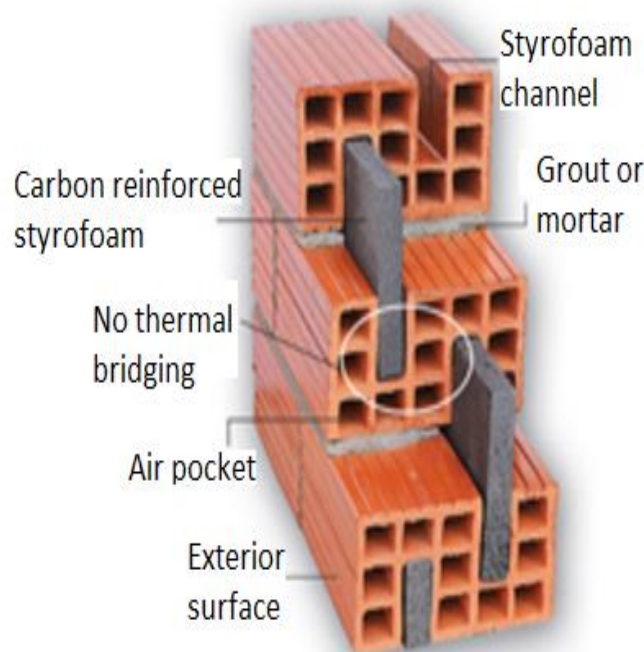

Figure 2. Carbon-reinforced styrofoam thermobrick [13]

As seen in Figure 2, this design modification reduces heat permeability, thereby enhancing the thermal insulation properties of the brick. The third brick in Bloksan's product line features a 45 mm styrofoam, which offers the highest level of thermal insulation or possesses the greatest thickness of insulation material. By employing this procedure, the utilization of additional insulation material becomes unnecessary. The brick's transmission coefficient is 0.095 kcal/mh°C, according to Bloksan's catalog. The brick's dimensions are also provided as 240x240x135 mm [13].

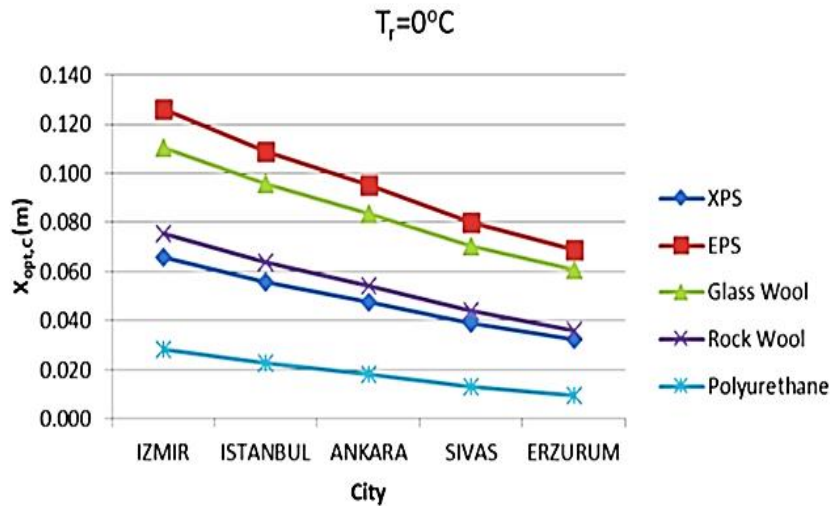

Figure 3. Optimum insulation type and thickness for Ankara province [14]

According to Kürekcı's study from 2020 [14], as depicted in Figure 3, the ideal insulation thickness for EPS, XPS and Polyurethane were 95, 54 and 18 mm respectively at 0°C in Ankara province. The determination was made based on electricity and insulation cost factors, considering the specific EPS insulation type and an ambient temperature of 0°C for Ankara province.

As per Özkol's work [15], for storing a product at 0°C in a warm and sunny environment, it is recommended to utilize polyurethane insulation with a minimum thickness of 75 mm. Based on this information, the insulation material selected for this study is EPS, with a thickness of 75 mm.

In order to keep the walls from degrading, coarse plaster was applied to the interior and exterior surfaces of this wall, and the thermal conductivity coefficient of the material is 0.595 kcal/mh°C, according to Ertem's study [16]. To sum it up, the ultimate configuration of the walls consists of the following layers, arranged from the exterior to the interior: a 20 mm exterior plaster, a 240 mm layer of thermobrick, a 75 mm polyurethane layer, and finally, a 20 mm rough plaster. The depiction of the wall has been generated utilizing a CAD software to enhance the visual representation of the arrangement, as shown in Figure 4.

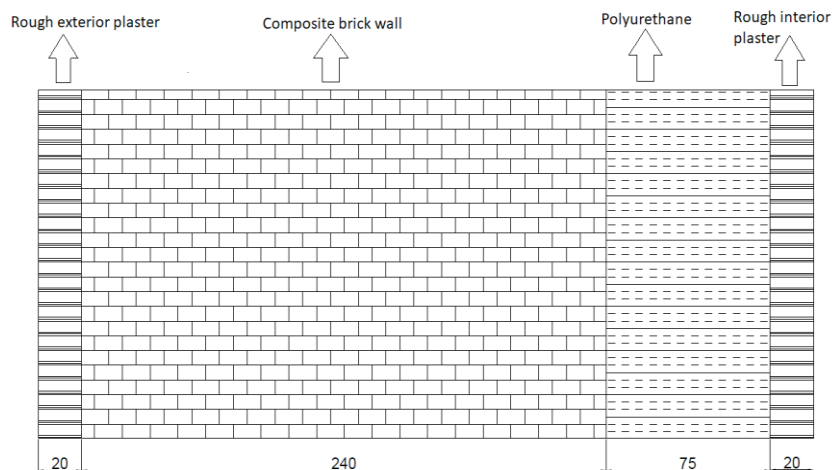

Figure 4. CAD sketch of the walls

The EPS material mentioned above exhibits a porous structure because of its production process, which enhances its ability to either allow passage or retain water vapor and moisture. Extruded polystyrene (XPS) is an alternative insulation material derived from the same base material but manufactured using a different technique. In contrast to expanded polystyrene (EPS), this material exhibits a denser structure with a smaller pore size. Hence, it exhibits greater resistance to external influences and exhibits reduced moisture permeability [17].

Subsequently, XPS was utilized in the flooring to ensure that the intended flooring or the floor insulation would not crack at a weight of more than 25 tons. The heat transfer coefficient has been reported as 0.027 kcal/mh°C. The foundation comprises 150 mm of gravel (1.29 kcal/mh°C). The slab was made of low-density concrete with a thickness of 100 mm, also known as lean concrete. Its heat transmission coefficient was documented as 0.149 kcal/mh°C according to Özkol. In addition, a layer of 50 mm XPS and a layer of 100 mm reinforced concrete were applied once more. The final step was to apply a layer of 25 mm rough plaster with a thermal conductivity of 0.595 kcal/mh°C, followed by a layer of 5 mm mosaic tiles with a thermal conductivity of 1.29 kcal/mh°C [15,18].

The roof of the cold room was constructed using composite polyurethane roof panels from Yazkar Company. A panel with 80 mm thickness was chosen, and its heat transfer coefficient is 0.019 kcal/mh°C [17]. The inner and outer edges of the doors are constructed with a 2 mm AISI 304 stainless steel sheet (12.9 kcal/mh°C) [20] and 100 mm of polyurethane in the middle.

To find the heat gain resulting from infiltration, it is necessary to obtain the dry and wet bulb temperatures of the designated study province. Arslanyan and Zengin's 2017 study in Ankara [21] served as the reference for the wet and dry bulb temperatures. The wet bulb temperature values in Table 1 will be used to calculate the heat gain by infiltration in subsection 2.3.

Table 1. Wet bulb temperatures for Ankara [21]

No	Temperature Lower Limit (°C)	Temperature Upper Limit (°C)	Number of Days
1	-10	-5	5
2	-5	0	20
3	0	5	44
4	5	10	50
5	10	15	94
6	15	20	111
7	20	25	41

Table 2. Dry bulb temperatures for Ankara [21]

No	Temperature Lower Limit (°C)	Temperature Upper Limit (°C)	Number of Days
1	-10	-5	1
2	-5	0	16
3	0	5	42
4	5	10	33
5	10	15	43
6	15	20	78
7	20	25	62
8	25	30	51
9	30	35	39

The highest temperature was recorded at 35 °C, according to Arslanyan and Zengin [21]. In this study, the maximum outside temperature was established to be 35°C, as per Table 2 since it is the absolute highest temperature.

The optimum storage conditions for apples were considered to be 0°C temperature and 90 % relative humidity based on the work of Koyuncu and Eren [8]. Certain conditions were established following the determination of building materials and thermometer temperatures for the cold room design. The conditions and calculations were guided by Özkol's book titled "Applied Cooling Technique" [15]. The facility's walls have been defined as light in color, and its entrance is oriented toward the north. Based on [15], it has been determined that the configuration of the roof will be flat and light in color as well [8,15].

Following the establishment of these parameters, the cold storage's area allocation was calculated in units using the space that would be covered by the pallets and crates that would be utilized to store 25 tons of apples. The pallet was selected as the ISO standard Europalet. The pallet has a load-carrying capacity of 1500 kg. The arrangement consists of four rows stacked vertically, allowing for the placement of eight crates measuring 400x300x240 mm on a pallet with dimensions of 1200x800x144 mm. Thus, a pallet contains 32 crates. For this palette, the dimensions of the GP-22 case from Güllolu Plastik were found to be adequate [22]. This case has a load-carrying capacity of 16 kg. As a result, an estimated total of 49 pallets were utilized, with three of these pallets being stacked to accommodate the storage of 25 tons of apples. Considering the forklift's lifting distance and calculating the entire height as 3312 mm, the warehouse's height was determined to be 3.5 m. The pallets are organized in dual rows along the warehouse's walls, with a 200 mm gap between the wall and each pallet as well as between adjacent pallets. The dimensions of the warehouse were measured at 5400 x 9200 mm. 2.5 meters have been allocated to allow the forklift to maneuver unrestrictedly between the pallets. Upon the inclusion of the office and engine room within the architectural plan, the overall dimensions of the building will amount to 5400 x 13200 x 3500 mm, as seen in Figure 5.

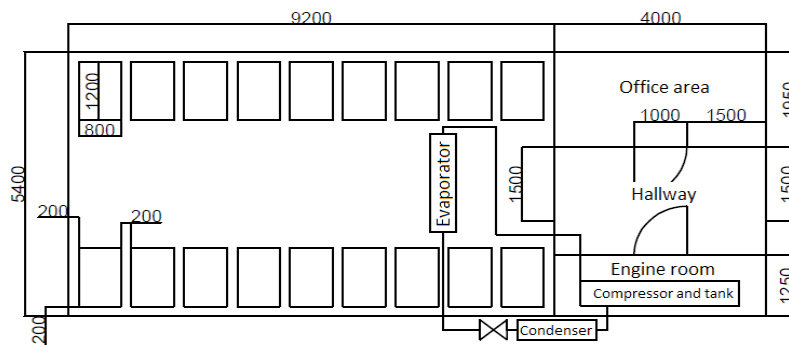

Figure 5. CAD sketch of the cold room

As shown in Figure 5, the facilities' doors were chosen to be 1500 mm wide so that the forklifts could move in and out freely. As for the forklift, the SXV-CB 10 model was chosen from STILL-ARSER. The maximum lifting capacity of this forklift is 1 ton, and it can raise its forks to a height of 5380 mm [23].

2.2. Heat Gain by Transmission

Once the area allocation for the cold store was determined, the heat transfer coefficients of the walls, floor, ceiling, and doors were subsequently computed. The formula used to calculate the total heat transfer coefficient (K) is as follows:

$$K = \frac{1}{\frac{1}{a_{inside}} + \sum_{k=1}^n \frac{l_n}{\lambda_n} + \frac{1}{a_{outside}}} \quad (1)$$

Here, 'a' denotes the surface transmission coefficient or the heat transmission coefficient of the medium. The symbols 'l' and 'λ' represent the material's thickness and heat transmission coefficient, respectively. After applying the prescribed formula, the resultant value for the overall heat transfer coefficient, denoted as 'K', is determined [24].

The adjacent volume temperatures and the solar radiation impact values are needed to calculate the heat gained via transmission using these subsequently acquired data. To address this matter, it is recommended to refer to Table VII-9 as presented by Özkol [15]. Given the hot climate and the decision to construct the cold storage facility on soil flooring, a temperature of 25°C has been selected. To determine the heat gained from the office area of the warehouse, the non-climatized volumes for typical utilization are within the range of 35–5, specifically 30°C. The temperature figure of 35 + 10 = 45°C is finally used to calculate the heat gained from the engine room. The transmission value is subsequently determined using the

equation below [15].

$$Q = K * A * \Delta T \quad (2)$$

2.3. Heat Gain by Infiltration

In the next step, the heat gain from infiltration will be determined. To perform this, the enthalpies for both indoor and outdoor environments were obtained from the psychometric diagram under the given conditions. The following equation was used to evaluate infiltration [15]:

$$Q_i = ACH * V * \rho_{air} * (h_i - h_o) \quad (3)$$

ACH, which stands for air exchanges per hour, refers to the measurement of the number of times the air within a given space is replaced with fresh air in one hour. The variable 'V' denotes the volume of the room, ' ρ_{air} ' denotes the density of the air, and 'h' denotes the internal and external enthalpy values [25].

2.4. Heat Gain from the Products

As per the work of Özkol [15], apples undergoing storage exhibit a heat emission phenomenon during the ripening process. The phenomenon is referred to as the biological process of ripening and respiration heat, which occurs due to the loss of moisture in fresh fruits [26].

Table VII-13 in Özkol's book [15] was consulted to determine the average amount of ripening-respiratory heat released by an apple per day, which is 207.5 kcal/day. The following formula was then used to determine the heat gain from the products:

$$Q_{resp} = m * c_{resp} \quad (4)$$

The variable 'm' represents the mass of the apple, measured in tons, while ' c_{resp} ' denotes the daily heat generated by the apple.

Due to the disparity between the temperatures of externally sourced products and the cold storage facility, a thermal energy transfer will occur, resulting in a net heat gain. Based on the data in Table VII-10 of Özkol's publication, an apple's freezing point is recorded as -1.1°C . In the present study, apples are subjected to a storage temperature of 0°C . Consequently, the thermal energy required to raise the temperature of apples to a level above the freezing point prior to freezing is determined to be 0.88 kcal/kg $^{\circ}\text{C}$. Assuming that apples are in a cooling state, the following cooling load calculation was made [15]:

$$Q_c = m * c_a * \Delta T \quad (5)$$

'm' stands for the mass of the apple as measured in kilograms; ' c_a ' is the apple's warming temperature before freezing; and ' ΔT ' is the temperature difference between the outside and the warehouse.

Furthermore, it is essential to consider that transporting these apples from external sources will involve using pallets and crates, which may contribute to an increase in heat gain. So, another calculation should be made using the same formula to determine this amount.

2.5 Heat Gain from People

The cold room work assignment entails the presence of a single forklift operator, two warehouse workers, one technician, and one engineer. Their daily working hours in this environment are set at seven hours. Upon examination of Table VII-14 [15], it is observed that there was a heat gain of 235 kcal/h per individual at a temperature of 0°C . The calculation of this gain can be determined by utilizing the following formula:

$$Q_h = c_h * n * t \quad (6)$$

The variable ' c_h ' indicates the amount of heat acquired from individuals, 'n' denotes the number of individuals engaged in work, and 't' signifies the duration of their work.

2.6 Heat Gain from Lighting, Forklifts, and Other Devices

A certain quantity of heat will be gained through forklifts, lighting, and other electrical equipment. The light source was a set of 14-100 W Essential E27 bulbs from Phillips. Every 10 m² of space will have one light bulb installed. The lights will be on for 8 hours each day. The heat gain from these bulbs can be calculated by using the following equation:

$$Q_l = A * P * c_l * t \quad (7)$$

The variables in this formula can be explained as follows: 'A' stands for the cold room ceiling area; 'P' for the luminaire power; 'c_l' for the lamp specific heat; and 't' for the operating duration.

An electric forklift is desirable, as was previously stated. As a result, the forklift's electric motor will also generate heat. The typical efficiency of electric motors is 90 %. In other words, some energy will undergo friction and become heat energy, radiating outward as heat gain [27]. According to its brochure, this forklift has a 1450 W motor; therefore, if we assume that it will operate for 7 hours per day, then:

$$Q_f = t * P * 0.1 \quad (8)$$

In this equation, 't' stands for run time and 'P' for power.

When figuring the heat gain of other devices, As the apple ripens, it will emit 10 % more ethylene gas into the atmosphere. Frigo Block's ethylene absorber has been placed to eliminate this gas from the environment. The device has a motor of 1 kW, and its operation will result in heat gain [28].

The NUH ATM 3000 ultrasonic humidification system from Frigo Block was also selected to ensure the environment is at ideal humidity levels. Using ultrasonic sound waves, the device turns liquid water into vapor, humidifying the surrounding air. This humidifier has a power output of 340 W, which will also result in heat gain [29].

2.7 Heat Gain from the Evaporator

Once all the heat gains above have been combined, the overall cooling load equals 41.67 kW. After incorporating a 10 % increase to account for the heat gain from the evaporator and other previously unaccounted heat gains, the measured value was determined to be 45.83 kW. Calculations of the evaporator's actual heat output will be made in subsection 2.10, and the results will be shown in the results section.

2.8 Selection of the Evaporator

For evaporator selection, there are several measures to be taken. These include the temperature difference between the room and the evaporation temperature, the relative humidity level, and the refrigerant type.

The room temperature-evaporation temperature differential is taken from the Applied Cooling Technique book [15]. For fresh fruits, 6.5°C is obtained from Table V-2 [15] using the specified room temperature (0°C) and relative humidity (90 %) values.

See Table V-3 [15] to determine the temperature differential associated with room evaporation based on relative humidity. For 90 % relative humidity, the temperature difference is 5.6°C. The optimal evaporation temperature for this humidity level is 0-5.6 = -5.6°C. As stated in the note under Table V-2 [15], if the temperature of the coil surface is assumed to be approximately 2.5-5.6 °C (-3.1°C), then 0-(-3.1) = 3.1°C is taken into consideration as the evaporation temperature since it is lower than the maximum temperature difference (5.6°C).

The evaporator or coil's surface will have the lowest temperature in a cooled volume. As a result, in high-humidity warehouses, the evaporator's surface will freeze. Defrosting must be done [13] to prevent this freezing. In the next stages of the process, it will be determined when to apply defrost and how much electricity is needed.

The most common refrigerant for use in vapor compression refrigeration systems is R507A, which is an azeotropic mixture of 50:50 by mass composed of R125 and R134A. It has relatively little environmental impact and is in the A1 security class due to its ODP of 0 and its GWP of 3900 [28]. In the study by Arora and Kaushik [30], R507A demonstrated better overall COP and exergy efficiency. R507A was chosen as the refrigerant in this study based on the findings of Arora and Kaushik [28].

The SC2 evaporator standard will be acceptable in the current room conditions at an evaporation temperature of -3.1°C and a cooling load of 45.89 kW. The lamella spacing is 7 mm, and the maximum temperature differential, denoted by ΔT, is -8.

The PSE 50.31.6 device from Frigo Block was chosen as the best option for meeting these criteria, and its specifications can be seen in Figure 6. One unit has a cooling capacity of 26.3 kW. Therefore, two evaporators, whose combined cooling capacity is 52.6 kW, will be adequate to chill the cold store proposed in the study.

PSE - Ø500

Lamel Aralığı Fin Spacing	Model Model	Kapasite Capacity				Yüzey Alan Surface Area	Boru Hacmi Tube Volume	Hava Debişi Airflow Rate	Fanlar / Fans				Elektrikli Defrost Electric Defrost			Boyutlar Dimensions						Giriş Bağlantı Çapı Inlet Diameter	Çıkış Bağlantı Çapı Outlet Diameter	
		Soğuk Oda Cold Room		Donmuş Oda Frozen Room					Gerilim Voltage	Adet Piece	Çap Diameter	Güç Power	Akım Current	E1		Drenaj Tavani Drip Tray	L	K	H	A	A1			F
		SC1 T _e =0°C DTI=10K	SC2 T _e =-8°C DTI=8K	SC3 T _e =-25°C DTI=7K	SC4 T _e =-31°C DTI=6K									Batarya Coil	Batarya Coil									
		kW	kW	kW	kW				m ²	L	m ³ /h	V/-/Hz	n	mm	W	A	W	W	mm	mm	mm			mm
6	PSE 50.11.6	12,90	8,70	6,90	-	32,90	9,30	6370	230V/1-/50Hz	1	500	710	3,10	9x225	10x225	2x225	1140	630	822	780	-	465	5/8"	7/8"
	PSE 50.12.6	15,00	10,10	7,80	-	43,70	12,00	5840	230V/1-/50Hz	1	500	710	3,10	9x225	10x225	2x225	1140	700	822	780	-	534	5/8"	7/8"
	PSE 50.21.6	25,90	17,50	14,00	-	65,70	18,50	12740	230V/1-/50Hz	2	500	1420	6,20	9x400	10x400	2x400	1890	630	822	1530	-	465	7/8"	1 1/8"
	PSE 50.22.6	30,30	20,40	15,80	-	87,60	24,70	11680	230V/1-/50Hz	2	500	1420	6,20	9x400	10x400	2x400	1890	700	822	750	780	534	7/8"	1 3/8"
	PSE 50.31.6	38,90	26,30	21,00	-	98,60	27,80	19100	230V/1-/50Hz	3	500	2130	9,30	9x600	10x600	2x600	2640	630	822	750	780	465	7/8"	1 3/8"
	PSE 50.32.6	44,90	30,50	24,30	-	131,50	37,10	17520	230V/1-/50Hz	3	500	2130	9,30	9x600	10x600	2x600	2640	700	822	750	780	534	1 1/8"	1 5/8"
	PSE 50.41.6	52,00	35,10	28,10	-	131,50	37,10	25470	230V/1-/50Hz	4	500	2840	12,40	9x800	10x800	2x800	3390	630	822	750	780	465	1 1/8"	1 5/8"
	PSE 50.42.6	60,80	41,10	32,00	-	175,30	49,40	23380	230V/1-/50Hz	4	500	2840	12,40	9x800	10x800	2x800	3390	700	822	750	780	534	1 1/8"	1 5/8"

Figure 6. Specifications of Frigo Block's Evaporators [31]

This evaporator features three fans with a combined power of 2130 W and a 500 mm fan diameter. It has an airflow of 19100m³/h. The E2 defrost battery has an output of 6120 W.

2.9 Actual Heat Gain from the Evaporator

A small amount of heat gain from the evaporator's motor and fans will be released into the atmosphere in addition to the cooling load value calculated in the preceding sections. Consult Table VII-15 [15] to determine this. The operational period of the evaporator is considered 23 hours and is computed using the formula below after defrosting for 15 minutes four times each day [15]:

$$Q_{evap} = n_{fan} * P * t * 930 \tag{9}$$

In this equation, 'n_{fan}' represents the number of fans, 'P' for fan power, 't' for daily operation time, and '930' for the correcting factor.

The total heat gain can finally be determined once the defrost temperature is calculated. Using the following formula, the defrosting heat gain can be computed:

$$Q_{def} = n_{evap} * P * t * F \tag{10}$$

The term 'n_{evap}' refers to the number of evaporators, 'P' to the evaporator's horsepower, 't' to its activity time, and 'F' to the defrost factor. For electric defrost, this value can be interpreted as '0.5'.

2.10 Selection of the Compressor

The temperature at which the refrigerant condenses should be 10 to 20 degrees Celsius above the air inlet temperature, according to what Özkol stated in his book [15]. Then, using a psychometric diagram and the following parameters: 52.6 kW cooling capacity, 0°C evaporation, and 35 + 10°C condensation temperature, the enthalpy values of the R507A refrigerant should be calculated to determine the compressor capacity. It is possible to figure out the powers of the compressor, condenser, and evaporator using the enthalpy calculations made here. Next, a COP value, also known as a coefficient of performance, can be determined. The COP number serves as a measure of the refrigeration cycles' effectiveness. Removing heat from a medium is the goal of refrigeration cycles, and doing so requires a net power input. The COP can therefore be stated as follows in [25]:

$$COP_R = \frac{\text{Energy out}}{\text{Energy in}} \tag{11}$$

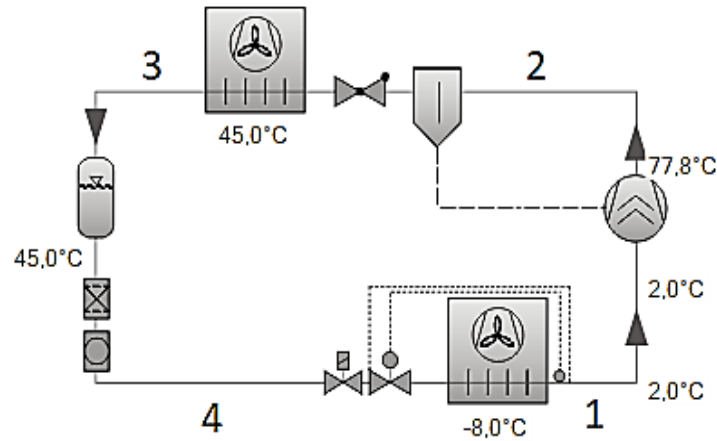

Figure 7. Diagram of a vapor compression cycle [32]

Using the EES tool (Engineering Equation Solver), several R507A refrigerant enthalpy values were found based on the diagram in Figure 7. These enthalpy data allowed for the calculation of the compressor's power and COP. The stages of the vapor compression refrigeration cycle can be stated as follows [25]:

- 1-2: Isentropic compression occurs in the compressor while the pressure increases.
- 2-3: Heat transfer from the condenser to the surroundings at constant pressure.
- 3-4: Lowering the fluid's pressure inside the throttling valve (constant enthalpy)
- 4-1: Heat transmission to the evaporator fluid while the pressure is constant.

The enthalpy values obtained in the EES software, and the formulas used are given below:

$$Q_{evap} = \dot{m} * (h_1 - h_4) \tag{12}$$

$$W_{comp} = \dot{m} * (h_2 - h_1) \tag{13}$$

$$Q_{cond} = \dot{m} * (h_2 - h_3) \tag{14}$$

The variable ' \dot{m} ' in this equation represents the refrigerant flow rate of the evaporator, and its unit is kg/s. Since the evaporator's cooling capacity is known, equation 11 may be used to determine the flow rate value. Then, a COP value may be calculated using the compressor's power and the condenser's heat capacity:

$$COP = \frac{Q_{evap}}{W_{comp}} \tag{15}$$

A condenser and compressor must be chosen to complete the cooling system. Bitzer's [30] web-based selection guide served as the basis for these decisions. The application starts by picking the preferred compressor type. Özkol [15] asserts that vapor compression refrigeration cycles typically employ semi-hermetic or open-type compressors. In this study, a semi-hermetic screw compressor was preferred. Following input of the refrigerant type, cooling capacity value, refrigerant evaporation temperature, and condensation temperature, the compressor with model number HSK5353-35-40P is recommended. This compressor has a cooling capacity of 54.8 kW, 29.6 kW of power input, 2003 kg/h of flow rate, and 77.4°C of gas outlet temperature. Additionally, the condenser capacity was found to be 84.3 kW.

3. RESULTS

In this section, the results obtained through the utilization of the equations provided in the materials and methods section will be presented.

Using Equation 1, the overall heat transfer coefficient was calculated. Table 3 lists the total heat transmission coefficients determined by the thickness and heat transfer coefficients of the building components:

Table 3. Total heat transfer coefficients of the building components

Component	K (kcal/mh°C)
Inside wall	0.1372
Outside wall	0.1389
Slab	0.2872
Roof	0.2241
Door	0.1666

Then a transmission heat gain value was determined using, through Eq. 2, these total heat transfer coefficient values. The chambers' transmission value was determined to be 47890 kcal/day, equivalent to 2319 W. Subsequently, substituting the matters in subsection 2.3 into Eq. 3, the heat gain of infiltration was calculated to be 14241 kcal/day, or 689 W. Next, using the values given in subsection 2.4 and Eq. 4, the ripening-respiratory temperature of 25 tons of apples was determined to be 251 W. As for the heat gained from the products, upon substituting the given values in subsection 2.4 into Eq 5., the resulting calculation yields a value of 32083 kcal/hour, which can be equivalently expressed as 37287 W. Upon recalculation using Eq. 5, it is determined that 150 W of heat will be gained from the crates. In contrast, the pallets will yield 365 W. The amount of heat gained by people was estimated to be using Eq 6., 8225 kcal/day, which is equivalent to 398 W (subsec. 2.5). The heat gained by the lighting equals 33 W using Eq. 7. (subsec. 2.6). heat gained by the forklifts equals 42 W using Eq 8. The 1 kW motor of the ethylene absorber will result in a heat gain of 100 W, and the humidifier will generate 34 W of heat. The evaporator's actual heat gain equals 8875 W utilizing Eq 9 (subsec 2.9). Then, a 6120 W of heat gain will result from four 15-minute daily thaw cycles (Eq 10). After calculating all the heat gain values transmitted to the cold room, the total heat acquired may be computed. The sum of all heat gains was calculated to be 60.89 kW, as shown in the table below.

Table 4. Total heat gain.

The type of heat gained	Heat gain (W)
Heat gain by transmission	2319
Infiltration	698
Products	38098
People	398
Lighting, forklifts and other	209
Evaporator (10 % increase)	4172
Subtotal	45894
Evaporator (actual)	8875
Defrost	6120
Total	60889

With the help of EES software, the enthalpy values were calculated and are shown in the table below.

Table 5. Enthalpy values found in the EES software.

No	Enthalpy (kJ/kg)
1	363
2	394
3	268
4	268

After calculating these enthalpy values, the power output of the compressor, the heat capacity of the condenser, the flow rate of the refrigerant, and finally a COP value was calculated utilizing the Equations 12, 13, 14, and 15 the values shown below were found.

Table 6. Flow rate, power, and COP values found in the EES software.

\dot{m} (kg/s)	0.28
W_{comp} (kW)	8.49
COP	3.1

4. CONCLUSION

The necessity to preserve fresh fruit in the best possible circumstances is rising due to the agriculture industry's continued expansion. These fruits need to be kept in optimal temperature and humidity conditions to be preserved with the least amount of mass loss. This study has attempted to address this issue in the best possible manner. The cooling room's space allocation and the necessary number of pallets and boxes were determined using the calculations performed in this study. Additionally, the equipment that would be employed, including the compressor, condenser, evaporator, and refrigerant, was chosen. The thermobricks that were chosen in this study proved to be quite efficient in terms of thermal bridging. In future studies, different construction and insulation materials may be preferred, such as autoclaved aerated concrete bricks, celcon blocks, rock wool, glass wool, etc. Also, with the advancement of refrigeration technology, a different study can be done with the discovery of better refrigerants. Compared to other values in the literature, the study's 3.1 COP value can be considered quite a good result. The research findings have the potential to revolutionize the way perishable agricultural commodities are handled, stored, and transported. They can lead to enhanced food security, reduced food waste, increased economic opportunities, and improved sustainability in the agriculture and food sector. In details, by maintaining optimal humidity and temperature conditions, the cold room design could help increase the availability of apples in the market throughout the year. It would also reduce spoilage and wastage, contributing to more efficient supply chains and lower food waste. Also by reducing post-harvest losses and extending the shelf life of apples, the agricultural industry could experience economic benefits. Farmers would have access to more stable and profitable markets, leading to potential growth and development in the agricultural sector. Finally the research could pave the way for advancements in refrigeration technology specific to cold room designs for other agricultural commodities. The knowledge gained from this study could be adapted and applied to other fruits and vegetables, expanding the scope of efficient storage and transportation in the food industry.

Funding

There are no financial interests in this study.

Declaration of Competing Interest

There is no conflict of interest in this study.

References

- [1] ASHRAE Committee, 2018. ASHRAE Handbook: Refrigeration

- [2] Hosseini, B., Namazian, A., 2012. An Overview of Iranian Ice Repositories An Example of Traditional Indigenous Architecture, METU Journal of the Faculty of Architecture, 29:2, 223-234.
- [3] Gantz, C., 2015. Refrigeration: A History.
- [4] Giunta, C. J., 2006. Thomas Midgley, Jr., and the Invention of Chlorofluorocarbon Refrigerants: It ain't Necessarily so, Bulletin for the History of Chemistry 31(2):66-74.
- [5] Altun, Ö., Aslantaş, K., Sökmen, E., 2020. Eskişehir İlinde R744 Soğutucu Akışkanlı İki Buharlaştırıcılı Bir Soğuk Hava Deposu Tasarımı, Soğutma Dünyası, 23:88, 50-57.
- [6] Calm, J. M., 2008. The Next Generation of Refrigerants—Historical Review, Considerations, and Outlook, Ecolibrium Nov:24-33.
- [7] Benhadid-Dib, S., Benzaoui, A., 2012. Refrigerants and Their Environmental Impact Substitution of Hydro Chlorofluorocarbon HCFC and HFC Hydro Fluorocarbon. Search for an Adequate Refrigerant, Energy Procedia, 18, 807-816.
- [8] Koyuncu, M.A., Eren, İ., 2005. Bazı Elma Çeşitlerinin Soğukta Depolanma Koşullarının Belirlenmesi, ADÜ Ziraat Fakültesi Dergisi, 2(1):45-52.
- [9] Kedd, F., West, C., 1937. Recent Advances in the Work on Refrigerated Gas-Storage of Fruit, Journal of Pomology and Horticultural Science, 14:4, 299-316.
- [10] C. Aprea, C. Renno., 2004. Experimental comparison of R22 with R417A performance in a vapour compression refrigeration plant subjected to a cold store, Journal of Energy Conversion and Management, 4, 1807-1819.
- [11] J.A. Evans, E.C. Hammond, A.J. Gigiel, A.M. Fostera, L. Reinholdt, K. Fikiin, C. Zilio., 2014. Assessment of methods to reduce the energy consumption of food cold stores, Journal of Applied Thermal Engineering, 62, 697-705.
- [12] Plasquy, E., Martos, J. M. G., Florido, M. C., Sola-Guirado, R. R., Martín, J. F. G., 2021. Cold Storage and Temperature Management of Olive Fruit: The Impact on Fruit Physiology and Olive Oil Quality-A Review, Processes, 9, 1-34.
- [13] Bloksan, Styroporlu Termo Yalıtım Tuğlaları, <https://bloksan.com.tr/portfolio/bt-19-20-24styroporlu-termo-yalitim-tuglari-2/>, 08.04.2023.
- [14] Kürekci, N. A., 2020. Optimum Insulation Thickness for Cold Storage Walls: A Case Study for Turkey, Journal of Thermal Engineering, 6(5), 873-887, Yıldız Technical University Press.
- [15] Özkol, N., 1999. Uygulamalı Soğutma Tekniği, Makine Mühendisleri Odası, 115.
- [16] Ertem, S., 2006. Konut Dışı Yapılarda İklimlendirme Santrallerinin Tasarımı, İstanbul Teknik Üniversitesi, Fen Bilimleri Enstitüsü, Yüksek Lisans Tezi.
- [17] Amir, A. H., Alibaba, H. Z., 2018. Comparison between Heat Conductivity of EPS and XPS, International Journal of Recent Research in Civil and Mechanical Engineering, 4(2):24-31.
- [18] Daşdemir, A., 2014. Farklı Yalıtım Malzemesi ve Yakıt Türüne Bağlı Olarak Optimum Yalıtım Kalınlığının ve Enerji Tasarrufunun Tespiti, Makine Mühendisliği Odası, Tesisat Mühendisliği Dergisi, 139, 5-13.
- [19] Yazkar, Soğuk Oda Çatı Panelleri, <http://sogukoda.yazkar.com.tr/urunlerimiz/soguk-oda-cati-panelleri.html>, 08.04.2023.
- [20] Blackwell, B. F., Gill, W., Dowding, K. J., Voth, T. E., 2000. Determination of Thermal Conductivity of 304 Stainless Steel Using Parameter Estimation Techniques, Proceedings of NHTC '00 34th National Heat Transfer Conference Pittsburgh, Pennsylvania.
- [21] Arslanyan, T., Zengin, G., 2017. Hibrit Tip Kapalı Çevrim Soğutma Kulelerinin Teknik İncelemesi, Makine Mühendisleri Odası, 13. Ulusal Tesisat Mühendisliği Kongresi, İzmir.
- [22] Güloğlu Plastik, One Way Kasalar, <https://guloglu.com.tr/one-way-kasalar/>, 09.06.2023.
- [23] STILL ARSER, Elektrikli Forklift, <https://www.still-arser.com.tr/araclar/yeni-araclar/elektrikli-forklift/sxv-cb-10.html>, 09.06.2023.
- [24] Çengel, Y. A., 2002, Heat Transfer: A Practical Approach, 2nd edition, McGraw-Hill, New York, USA.
- [25] Çengel, Y. A., Boles, M. A., Kanoğlu, M., 2023. Thermodynamics: An Engineering Approach, 10th edition, McGraw-Hill, New York, USA.
- [26] Becker, B. R., Fricke, B. A., 2002. Transpiration and Respiration of Fruits and Vegetables, University of Missouri-Kansas City, Mechanical and Aerospace Engineering Department, Environmental Science Paper.
- [27] De Almeida, A.T., Ferreira F.J., Fong, J. A. C., 2010. Standarts for Efficiency of Electric Motors, Industry Applications Magazine, 17(1), 12-19.
- [28] Frigo Block, Etilen Alma Cihazı, <https://www.frigoblock.com.tr/etilen-alma-cihazı.php>, 09.06.2023.

[29] Frigo Block, Ultrasonik Nemlendirici, <https://www.frigoblock.com.tr/ultrasonik-nemlendirici.php>, 09.06.2023.

[30] Arora, A., Kaushik, S. C., 2008. Theoretical Analysis of a Vapour Compression Refrigeration System with R502, R404A and R507A, *International Journal of Refrigeration*, 31, 998-1005.

[31] Frigo Block, Standard Evaporatörler, <https://www.frigoblock.com.tr/standart-evaporatorler.php>, 09.06.2023.

[32] Bitzer, Web Software, <https://www.bitzer.de/websoftware/Default.aspx>, 08.07.2023.

Quantifying the Effects of Climate Change on Simineh River Discharge in Lake Urmia Basin

Hirad Abghari^{a*}, Mahdi Erfanian^b

^a Associate Professor, Department of Range and Watershed Management, Faculty of Natural Resources, Urmia University, Urmia, Iran. e-mail: Email: h.abghari@urmia.ac.ir (*Corresponding Author)

^b Associate Professor, Department of Range and Watershed Management, Faculty of Natural Resources, Urmia University, Urmia, Iran. e-mail: Email: m.erfanian@urmia.ac.ir

Abstract

The Simineh River is heavily reliant on water resources for agricultural aims in the Lake Urmia. However, the hydrological system of the Simineh basin is highly susceptible to the impacts of climate change scenarios, primarily due to the presence of diverse topographical features, limited availability of data, and the complex nature of the local climate. This study aimed to simulate the monthly discharge of the Simineh River using the SWAT and assess the effects of climate change on the monthly discharge. Future climate scenarios for the years 2011-2030 were generated using the HadCM3 weather models under the A2, B1, and A1B scenarios. After evaluating the performance of the LARS-WG model in producing precipitation, minimum and maximum temperatures for the Simineh River watershed, the output of the HadCM3 under the A1B, B1, and A2 scenarios reduced, and the desired meteorological parameters predicted. These predicted values used as inputs for the SWAT model. In this study, assuming no change in land use, the focus was solely on the impact of climate change scenarios. However, appropriate measures can be taken to save the Simineh River's water consumption by optimizing irrigation efficiency through innovative methods. This is crucial because the results indicate that a total reduction of up to 25% in discharge in the Lake Urmia basin under climate change leads to a significant decrease in the annual average inflow to the lake from 570 million cubic meters to 394, 398, and 440 million cubic meters under the A2, B1, and A1B scenarios, respectively. The Simineh River supplies 11% of the water in Lake Urmia, and taking necessary measures to conserve its water resources is essential.

Keywords: Discharge, Downscaling, Had CM3, LARS-WG, Iran, Simineh river, SWAT

INTRODUCTION

The main cause of climate change is the increase greenhouse gases in the atmosphere, as noted by various researchers (Nijssen et al., 2001; Nilawar and Waikar, 2019; Li and Fang, 2021). It is widely agreed upon by the scientific community that the temperature of the Earth is on the rise and this trend is predicted to continue (Li and Fang, 2017). As per the IPCC's Fifth Assessment Report, the global average temperature risen about 0.85 °C during the period of 1880-2012 (IPCC, 2013). To estimate the possible impacts of climate change on water resource systems, it is necessary to have precise forecasts of critical meteorological variables like temperature and precipitation, which can fluctuate significantly at the regional or local level, as stated by Horton et al. in 2006. To generate predictions for such meteorological variables, scientists often rely on climate change projections produced by coupled AOGCMs or RCMs that are driven by AOGCM outputs. AOGCMs offer a global outlook while RCMs are intended to capture regional-scale climate patterns with increased spatial resolution. Therefore, RCMs are generally deemed more effective in describing regional-scale climate and can provide more precise and accurate forecasts of such meteorological variables. However, it is essential to recognize that both AOGCMs and RCMs have limitations, and their projections should be used with caution while making decisions related to water resource systems. It is important to acknowledge that the development of precise climate change projections is a dynamic field, and ongoing research is dedicated to enhancing the accuracy and reliability of these projections. Staying up-to-date on the latest advancements in weather modeling and refining approaches for evaluating the potential impacts of climate change on water resource systems is essential for researchers. Staying informed about these advancements can guarantee the precision and efficacy of models and methodologies, leading to improved decision-making and management of water resources amidst the changing climate. Due to the intricate and nonlinear nature of the climate system, different experiments using AOGCMs or RCMs may yield varying results for the same emission scenario. This variability can be attributed to several factors, including differences in model design, assumptions, and input data. The use of different AOGCM or RCM experiments can lead to significant uncertainty in climate projections, as noted by researchers such as Frei et al. in 2003, Rais et al. in 2004, and Horton et al. in 2006. While RCMs are generally deemed more dependable for

regional-scale climate projections compared to AOGCMs, the uncertainty introduced by RCMs cannot be disregarded entirely. Nevertheless, studies have demonstrated that the inter-model variability of RCMs is generally lower than that of AOGCMs, as reported by Jenkins and Lowe in 2003.

The IPCC predicts that the global average temperature will continue to rise by 0.3 °C to 0.7 °C during 2016–2035, with a projected increase of 1 °C under the low scenario and over 4 °C under the high scenario by the end of the 21st century, according to various studies, including Milly et al. in 2005, UNFCCC in 2015, Marahatta et al. in 2021, Masson-Delmotte et al. in 2021, and Wang et al. in 2022. The rise in temperature has caused a rapid increase in evapotranspiration rates, resulting in notable modifications to worldwide precipitation patterns (Wang et al., 2013; Paparrizos et al., 2015; Zhang et al., 2016; Zhang and Villarini, 2017; Lehner et al., 2017; Li and Fang, 2021). Furthermore, according to Bajracharya et al. (2018), the global average surface temperature will increase and precipitation patterns will change in the coming century. It is predicted that the hydrological cycle will be impacted by climate changes, as the altered temperature and precipitation patterns affect the distribution of water cycle components such as evaporation, precipitation, soil moisture, and runoff (Rabeanahary et al., 2021; Liu et al., 2022; Wang et al., 2022). Understanding about river flow response to climate change is essential for effective planning and management of water resources. Several studies have indicated that the discharge of one-third of the world's rivers have change since the 1950s (Tan and Gan, 2015; Bhatta et al., 2019; Lehner et al., 2019). In previous modeling studies, a common approach to use a unit increase in temperature and a percentage change in precipitation as input for weather models, or to adjust the output of the weather model by revising observed station data. While this approach may reduce bias in the weather model, not fully account for changes in the intensity and frequency of precipitation that occur due to climate changes (Liu et al., 2013; Fan and Shibata, 2015; Steinschneider et al., 2015). To overcome this limitation, many studies have employed a combination of GCMs and hydrological models to assess the potential impact of climate change on river flow (Wang et al., 2018). To account this uncertainty, researchers often use a various GCMs to provide better assessments of water resources. Downscaling techniques such as dynamic or statistical methods are then employed to adapt the spatio-temporal resolutions of hydrological models and GCMs. Based on different scenarios in climate changes, temperature and precipitation are procreated as input data for SWAT and other hydrological models to anticipation future discharge. This is regarded as most important methods for evaluating discharge and runoff changes (Tan et al., 2017; Luo et al., 2018; Bhatta et al., 2019; Xu, 1999). The SWAT is a semi-distributed and physical-based model in basin-scale that is well-suited for assessing the reply of runoff and discharge to precipitation and temperature changes. Many researchers have employed the SWAT model to evaluate the impact of precipitation and temperature changes on runoff and water resources in different areas. For example, Pongpetch et al. (2015) employed the SWAT to simulate discharge, flow and sediment in Thailand. In 2017, Golmohammadi et al. used this model to predict runoff-generating regions in Ontario, Canada, providing a source for modeling runoff generation in the watershed. Jung et al. (2018) applied the SWAT to estimate the influence of CO₂ changes on the hydrological cycle in Korea. Bhatta et al. (2019) used the SWAT and four RCMs to evaluate the effects of precipitation and temperature change on the hydrology on Himalayan river. Lucas-Borja et al. (2020) utilized the SWAT model to simulate and predict runoff in a small watershed in the tropical forest of Brazil and found a decreasing trend in the watershed runoff. Amin et al. (2020) applied the SWAT model to simulate the runoff of the Mojo river in Korea.

This study aimed to evaluate the impact of future climate changes on discharge in the Simineh river. The study findings contribute to the existing literature on streamflow changes in the region due to global warming. Additionally, this study provides valuable scientific insights for river basin management to mitigate potential water resource problems in the lake Urmia basin in the future. The study also has significant implications for water resources management in the lake Urmia Basin, as it can inform policymakers and water resource managers in the region about the potential effects of climate change on streamflow. Understanding how streamflow may change in the future is essential for developing effective strategies to manage and sustain water resources in the region and mitigate any potential adverse impacts on agriculture and other sectors that rely on water resources.

2 Materials and method

2.1 Study area

The Simineh river, located in the N38 zone, and is situated in the south of Lake Urmia in Iran (Fig 1). The basin covers an area of 3860 km², which represents approximately 27% of the northern Karun river basin. It flows into Lake Urmia to the north and the Karun river basin to the south. The Simineh river originates from the mountains surrounding Saqqez (near Zanjan and Terejan) in the south of Lake Urmia. The general slope of the basin is towards the northwest, and Most of the basin consists of flat topography, with slope gradients of less than 9% (Fig. 2-b). The elevation of the basin ranges from 1267 meters at the outlet to 2559 meters in the southwest highlands of the basin (Fig 2-a). The annual precipitation varies from approximately 231 mm to 848 mm, and the minimum and maximum temperatures in the basin are 11°C and 18.1°C, respectively. The Simineh river flows approximately 200 km from the mountains of Kurdistan in Iraq and Iran.

The Simineh river comprises five distinct land use types, as depicted in Figure 2-c. The dominant land use category is agriculture land (AGRL), accounting for 79.43% of the basin area, followed by grass land (PAST) at 6.16%, and forest land (FRST) at 3.29 %, and land for construction (URML) at 1.10%. The Simineh river basin encompasses a variety of land use types and soil compositions, including five distinct soil types (as depicted in Figure 2-d). The soil in the study area includes two types

of soils, Aridisols and Inceptisols, typically found in four different layers, often accompanied by rock outcrops. The most prevalent soil texture within the basin is L-GR-FSL-GRV-COS with B hydrologic group, which covers approximately 37.69% of the total area. HOGBACK (with STV-FSL-FSL-UWB texture and C hydrologic group) comprise 36.86% of the soil types, while CASTILE (with GR--L-GRV-SL-GRV-S texture and B hydrologic group) and GROTON (with GR--SL-GR--SL-GRV-LS-GRX texture and A hydrologic group) cover 16.38% and 6.83% of the area, respectively. TIOGA (with FSL-GR--FSL-GRV-LS texture and B hydrologic group) covers only 2.23% of the basin area. In summary agriculture is the primary land use within the basin, with a predominant focus on farming activities.

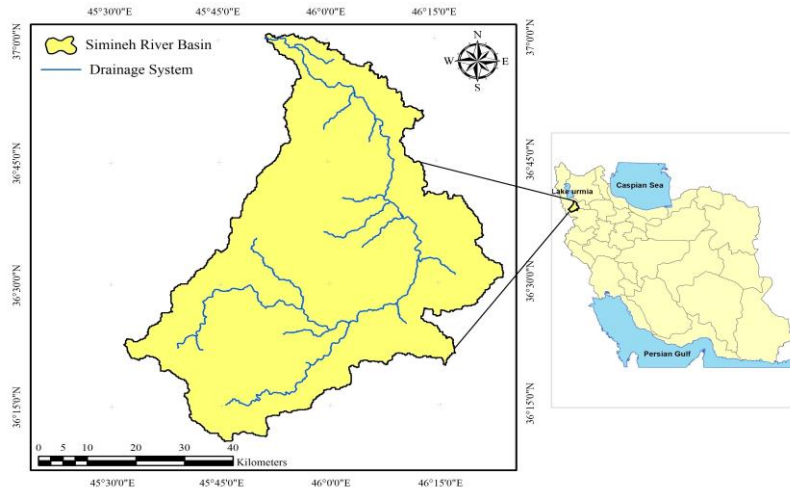

Figure 1. Location of the study area and river monitoring network.

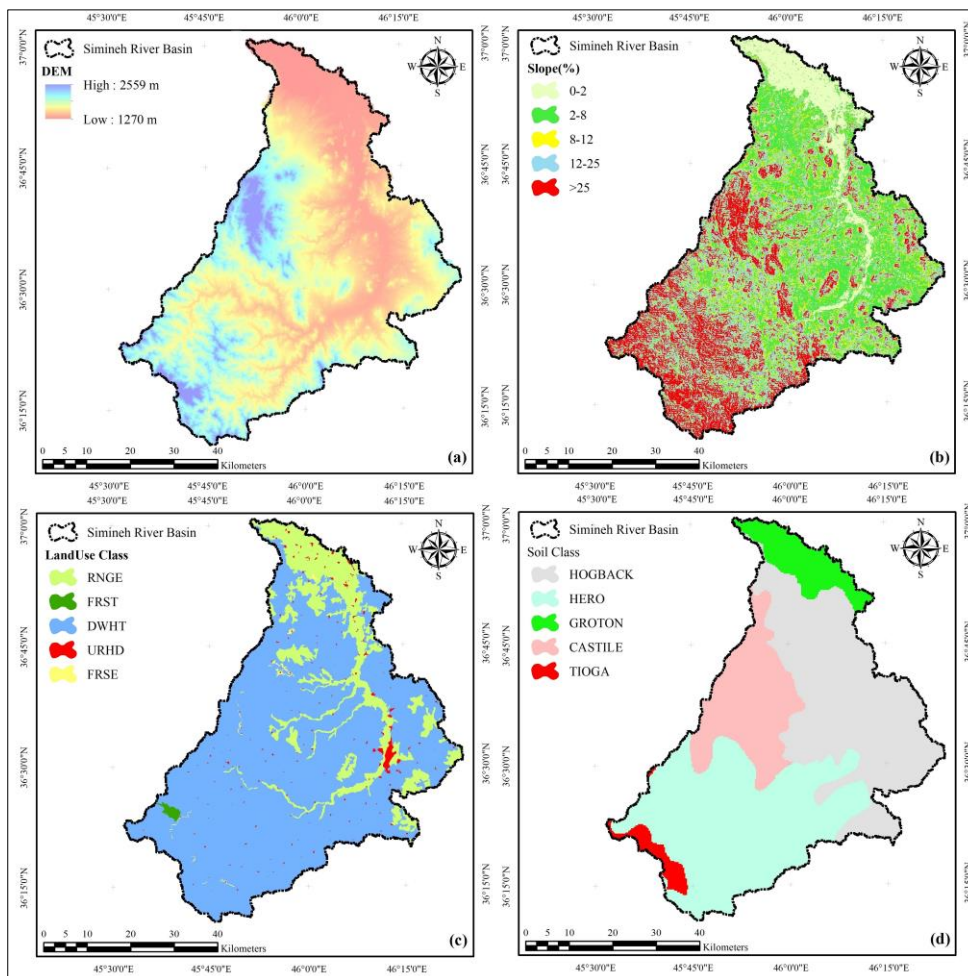

Figure 2. Characteristics of (a) DEM, (b) Slope, (c) land use, and (d) soil.

2.2 SWAT Model

The mainframe of water resources management under climate change is about the incorporation of the operational water projects in the planning horizon, policies, and macro-future decisions. However, when the allocation of water resources by neglecting climate change is performed, the results will not have the necessary validity and accuracy in practice (IPCC et al., 2007). Accordingly, examining the reliability of water supply in satisfaction of water demand for agricultural, industrial, drinking, and environmental uses; in addition to, allocation of the available water based on the predefined or dictated governmental rules for different sectors with consideration to the climate change and operational water projects is inevitable. Such applications are frequently addressed by the applications of the soil and water assessment tool (SWAT) and the river basin simulation, that showed promising results. SWAT (Arnold et al., 1998), as a basin-wide and well-established hydrologic model, is frequently used for simulating the streamflow process, especially in evaluation of inflows and outflows from the reservoir or the river-basin. This process-oriented model can simulate the hydrological processes based on the soil and water interactions and then develops estimations based on the changes of hydrologic variables in the allocated basin (Arnold and Fohrer, 2005). Due to the no-charge modeling, simultaneous simulation of hydrological variables, and agricultural management in complex basins with various land use and soil types, many studies endorsed the application of SWAT (Ahmadzadeh et al., 2016).

SWAT includes approaches describing how CO₂ concentration, precipitation, temperature, and humidity affect plant growth, ET, snow, and runoff generation, and has often been used as a tool to investigate climate change effects. Several case studies of climate change impacts on water resources have used this model (e.g., Hanratty and Stefan, 1998; Rosenberg et al., 1999; Cruise et al., 1999; Stonefelt et al., 2000; Fontaine et al., 2001; Eckhardt and Ulbrich, 2003; Chaplot, 2007; Schuol et al., 2008). SWAT has been used to model portions of the San Joaquin watershed (Flay and Narasimhan, 2000; Luo et al., 2008). Often-used hydrologic models for IWRM include: Soil and Water Assessment Tool (SWAT), a watershed modelling code that simulates the principal hydrologic fluxes at a daily time step (Arnold et al., 1998). The key indicators of floods, namely runoff, flood peaks, and precipitation, were assessed in this study. The SWAT model was utilized for this purpose as it can effectively simulate changes in regional runoff (Arnold et al., 1998; Shrestha et al., 2018; Bhatta et al., 2019). The model comprises three main components, including the hydrological cycle runoff process, slope confluence land process, and river confluence process (Konapala et al., 2016). The hydrological process on the surface was divided into two parts, namely land hydrological cycle and river confluence process (Osei et al., 2019; Ballesteros et al., 2020; Tanteliniaina et al., 2021; Li and Fang, 2021; Liu et al., 2022). The simulation of the land hydrological cycle was primarily based on the water balance equation represented by Equation (1):

$$SW_t = SW_0 + \sum_{i=1}^t (R_{day} - Q_{surf} - E_{surf} - W_{seep} - Q_{gw}) \quad (1)$$

In Equation (1), SW_t represents the final soil moisture content, SW_0 represents the initial soil moisture content in millimeters (mm), t represents the time step in days, R_{day} represents the rainfall on the i -th day, Q_{surf} represents the surface runoff on the i -th day in mm, E_a represents the evaporation on the i -th day in mm, W_{seep} represents the infiltration and lateral flow at the bottom of the soil profile on the i -th day in mm, and Q_{gw} represents the groundwater outflow on the i -th day in mm.

To estimate surface runoff, the SWAT model employs the SCS-CN method and the Green-Ampt and Ampere infiltration methods. The SCS model was developed to estimate runoff for various land uses and soil hydrologic groups. The Green-Ampt and Ampere equations assume the presence of excess water on the surface at all times to predict infiltration. The SCS equation for estimating surface runoff is given by:

$$Q_{swf} = \frac{(R_{day} - I_a)^2}{(R_{day} - I_a + S)} \quad (2)$$

In equation (2), I_a includes tracking, infiltration, and surface storage for the day in millimeters of water (H₂O), that represents the initial abstraction, while S represents the retention factor. The coefficient of surface retention depends on various factors such as soil type, vegetation cover, land use, elevation, and slope. The parameter S is defined as equation (3), where CN indicate the curve number.

$$S = 25.4 \left(\frac{1000}{CN} - 10 \right) \quad (3)$$

Dividing the sub-basins into branches is necessary for building the model and the simulation verification process. To achieve this, topographic data was filled in to reduce errors caused by various landforms. Then, homogeneous hydrological units (HRUs) were determined by dividing each sub-basin into several HRUs based on features such as land use, soil, and slope. The more accurate the unit division is, the higher the simulation accuracy, but the model calculation speed must be maintained. Ultimately, the Upper Simineh river basin was divided into 27 HRUs, as depicted in Figure 3.

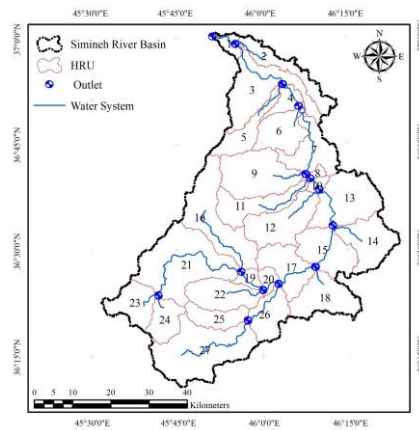

Figure 3. HRU division of Simineh river

2.3 Model parameter sensitivity, calibration, and validation

The hydrological sensitivity of watersheds varies significantly based on their conditions and characteristics, making them sensitive to specific parameters. Full calibration details can be found in Luo et al. (2008). The most sensitive model parameters were chosen in the calibration procedure based on literature review and a preliminary sensitivity analysis (Luo et al., 2008). According to studies in this field (such as Ficklin et al., 2009; Yuan et al., 2015; Chen et al., 2020; Liu et al., 2022) 20 of the most sensitive parameters selected and incorporated into the model for calibration. In the initial stage of calibration, the sensitive parameters identified, and further calibration conducted with a focus on these parameters. The sensitivity rankings of the parameters are listed in Table 1.

Table 1. The sensitive parameters for streamflow with their ranges and adopted values.

Rank	Parameter	Description	Range	Adopted value	P-value	t-Stat
1	ESCO.hru	Soil evaporation compensation factor	0-5	2.67	0.00	4.82
2	SMTMP.bsn	Snowfall temperature	-10-10	9.50	0.00	3.41
3	SOL_K.sol	Saturated hydraulic conductivity	-0.9 – 0.9	0.69	0.00	2.86
4	SLSUBBSN.hru	Average slope length	0-100	13.5	0.02	2.33
5	SURLAG.bsn	Surface runoff lag time	0-24	8.04	0.04	-1.99
6	SOL_AWC.sol	soil available water storage capacity	0-1	0.65	0.05	-1.94
7	ALPHA_BF.gw	Base flow alpha factor	-1-1	0.85	0.05	1.93
8	SMFMX.bsn	Maximum melt rate for snow during the year (occurs on summer solstice)	-10-10	-3.30	0.10	-1.62
9	SOL_BD.sol	Moist bulk density of first soil layer	0-10	6.45	0.11	1.59
10	SOL_Z.sol	The thickness of soil layers	1-5	1.18	0.14	-1.46
11	CH_K2.rte	Effective hydraulic conductivity in the main channel	0-100	35.5	0.23	-1.19
12	ALPHA_BNK.rte	Base flow alpha factor for bank storage	0-1	0.38	0.24	-1.17
13	EPCO.hru	Plant absorption compensation factor	0-5	2.27	0.3	1.04
14	GWQMN.gw	Threshold depth of water in shallow aquifer for return flow to occur	0-1	0.12	0.43	-0.79
15	CN2.mgt	SCS runoff curve number	-0.1–0.1	0.04	0.43	0.78
16	REVAPMN.gw	Threshold depth of water in the shallow aquifer for “revap” to occur	0-1	0.70	0.44	0.76
17	TIMP.bsn	Stack snow temperature delay factor	0-1	0.47	0.48	0.70
18	SMFMN.bsn	Minimum melt rate for snow during the year (occurs on winter solstice)	-10-10	-0.1	0.49	-0.68
19	SFTMP.bsn	Snow melting temperature	-10-10	-3.30	0.73	0.34
20	GW_DELY.gw	Groundwater delay time	0-10	8.65	0.94	-0.07

To ensure the accuracy of the SWAT model, sensitivity analysis, calibration, and validation were performed. Calibration used daily data from 1986-2000, with the first two years used as a warm-up period, while validation was performed on data from 2001-2010. SWAT-CUP was used for calibration and uncertainty analysis, while the Sequential Uncertainty Fitting algorithm (SUFI-2) was used for sensitivity analysis, calibration, validation, and uncertainty analysis in the Simineh River basin. Performance of the model was evaluated using the coefficient of determination (R^2), the Nash-Sutcliffe efficiency coefficient (NS), percent bias (PBIAS), the P coefficient, and the r coefficient. These measurements were used to verify whether the SWAT model was satisfactory for use in the study.

2.4 Future climate change projection

Two main climatic factors that influence discharge on a basin scale are temperature and precipitation (Wang et al., 2018). The Lars-WG model used to correct the future climate data for 2011-2030 under A2, B1, and A1B scenarios. This downscaling technique is commonly used and relatively simple, and it can cluster the entire range of various models and calculate their average level (Li and Fang, 2021). The mean changes in temperature and precipitation for the 2020s (2011-2030) A1B under, B1, and A2 scenarios compared to the baseline period (1986-2010). In order to predict the impacts of future precipitation and temperature changes on discharge in monthly scale, the calibrated SWAT model used. precipitation and temperature data generated by LARS-WG method under A2, B1, and A1B scenarios introduced as input to SWAT model.

3 Results

3.1 Projected changes in precipitation and temperature

3.1.1 Precipitation

The trend of precipitation changes in the 2020s compared to the 1986-2010 period does not show uniformity. The HadCM3 model indicates lower precipitation in some months and higher precipitation in other months of the future period compared to the baseline period. All three scenarios predict an increase in rainfall for February, March, September, October, November, and December, and a decrease in rainfall for April, July, and August. The A2, B1, and A1B scenarios predict the highest increase in rainfall for November. The scenarios have shown different changes in January, May, and July. In conclusion, the average annual precipitation in the Simineh river watershed will increase in the 2020s. The predicted average annual precipitation for this decade under the A2, B1, and A1B scenarios will be 468.48, 488.84, and 469.79 millimeters, respectively, while the annual precipitation during the baseline period was 453.47 millimeters. Therefore, the study area will experience an increase in precipitation ranging from 8.78% to 12.86%, depending on the scenario. (Figure. 4).

3.1.2 Temperature

Figure 4 shows the average minimum temperature of the study watershed in the 2020s compared to the 1986-2015 period. All three scenarios (A2, B1, and A1B) predict an increase in minimum temperature in all months. The A2, B1, and A1B scenarios predict an increase in minimum temperature of 0.1-1.27°C, 0.2-1.12°C, and 0.1-0.31°C, respectively. The highest increase in temperature will occur in February and the lowest in October. It can be observed that the A2 scenario predicts a higher increase in temperature compared to the other scenarios.

Furthermore, all three scenarios predict an increase in maximum temperature for all months. By comparing the maximum temperature of the observed period and the 2030-2011 period, it can be observed that the highest increase in maximum temperature will occur in August, ranging from 0.83°C to 0.95°C. The lowest increase will occur in January, ranging from 0.1°C to 0.3°C. It is also observed that the A2 scenario predicts a higher increase in temperature compared to the other scenarios (Figure 4).

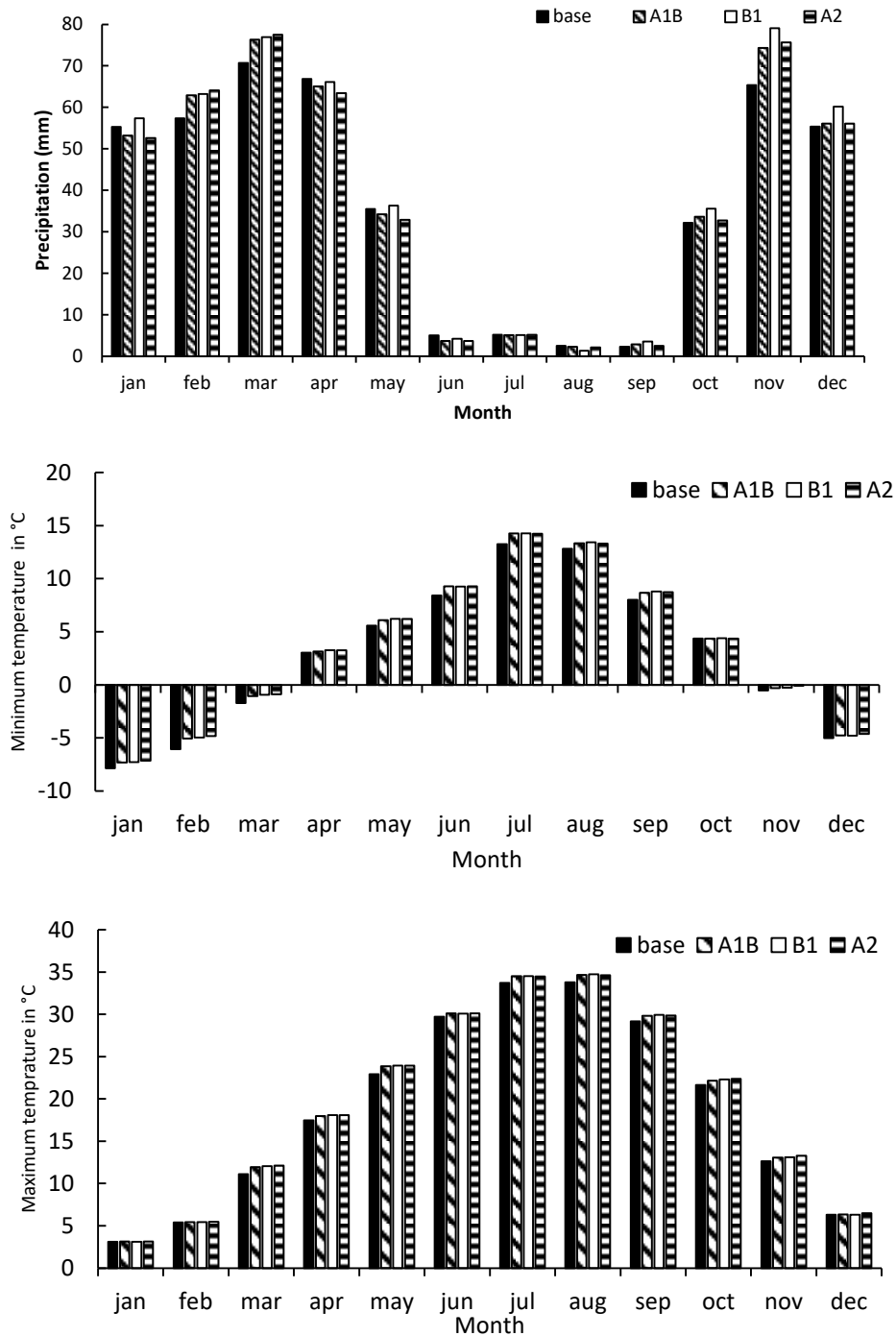

Figure 4. Monthly precipitation, Minimum temperature, and Maximum temperature during the baseline (1986–2010) and 2020s periods under A2, B1, and A1B scenarios.

3.2 Parameter sensitivity, calibration, and validation

Twenty parameters selected for calibration of the model, as shown in Table 1. The sensitivity of parameters is measured using two factors, P-Value and T-Stat. A parameter is considered sensitive if changes in its value significantly affect the output results (Tuo et al., 2016; Li and Fang, 2021). The sensitivity of a parameter is determined based on its P-Value, where a parameter with a value closer to zero is more sensitive and ranks first in the sensitivity ranking (Abbaspour, 2008). In terms of T-Stat, a parameter with a higher absolute value is more sensitive (Abbaspour, 2008; (Abbaspour et al., 2017). Based on the mentioned factors, the soil evaporation compensation factor (ESCO.hru) had the most significant impact on the output flow rate, while the groundwater delay time (GW_DELY.gw) had the least impact. During the calibration period (1986–2000), the simulated monthly streamflow values compared to the observed values (Figure.5). The R2 value is equal to 0.65, and the NS values is equal to 0.62,

respectively (Table 2). The PBIAS value is equal to 18.75%, indicating that the simulated values were generally lower than the observed values. During the validation period, the R2 and NS values equal to 0.57, and 0.48, respectively. The PBIAS value is equal to 19.2%, and the R2 and NS values during this period were slightly lower than those during the calibration period.

According to Tables 2, the results obtained from the objective functions found to be satisfactory. Nash and Sutcliffe (1970) showed that the Nash-Sutcliffe coefficient (NS) values greater than 0.75 are considered good, and if the value of NS is greater than 0.50, the simulation model can be considered good, but if it becomes negative, it is better to rely on observed data rather than the model results. Based on the obtained results, it is evident that the model had weaknesses in simulating streamflow. This could be attributed to various factors, such as errors in observed data, errors in input data, and insufficient number of stations in the study area. Given that hydrological simulation of a watershed is subject to significant uncertainty, it is necessary to prepare model inputs with sufficient accuracy to obtain good results.

Table 2. Statistical performance for the calibration and validation periods.

Stage	R2	NS	P-factor	R-factor	PBIAS	MSE
Before calibration	0.44	0.39	0.10	0.00	22.2	28.6
Calibration	0.65	0.62	0.43	0.44	18.75	18.2
Validation	0.58	0.47	0.41	0.40	19.4	12.8

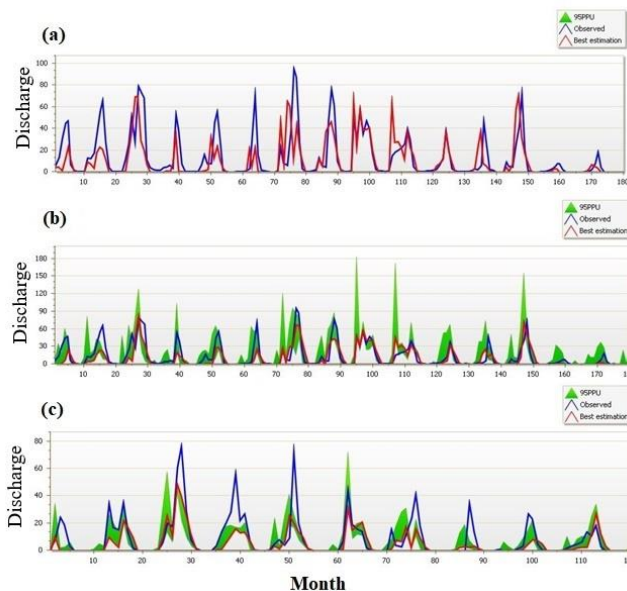

Figure 5. Comparisons between observed and simulated streamflow at Dashband station on the monthly time steps for (a) before calibration (b) calibration and (c) validation.

3.3 Changes in the discharge on Simineh river basin under climate change

In this study, using the SWAT model and under climate change conditions, the changes in monthly input flow to the lake were compared for the benchmark and future scenarios under the A2, B1, and A1B emission scenarios, for the Dashtband-e-Bukan watershed station. The results show a significant decrease in flow in March, April, May, June, July, August, September, and October, which is more pronounced under the A2 scenario. In the other months, the monthly mean flow has slightly increased, but overall and on an annual scale, all three scenarios predict a decrease in flow (Figure 6). The annual flow values for the 2030-2011 period, under the A2, A1B, and B1 scenarios, are 66.8, 73.8, and 73.9 cubic meters per second, respectively, while this value was observed to be 51.12 cubic meters per second for the baseline period. Table 3 shows the monthly flow values for the future and baseline periods.

4 Conclusions

This study was conducted to investigate the impact of climate change on discharge in the Simineh river basin. This basin is one of the important river basins on Urmia Lake basin. In general, the simultaneous increase in maximum and minimum temperatures could lead to significant temperature increases in the region in the future. The predicted mean temperature for the 2020s under the A2, B1 and A1B scenarios will be 11.49, 11.45 and 11.40 degrees Celsius, respectively. These results are somewhat consistent with other studies which predicted a temperature increase for different basins and synoptic stations (Furuya and Koyama, 2005; Aggarwal et al., 2010; Arunrat et al., 2018; Farokhzadeh et al., 2018; Mansouri Daneshvar et al., 2019; Sharafati et al., 2020; Doulabian, et al., 2021). The SWAT model calibrated and validated using observation data from 1986 to

2000 and 2001 to 2010 respectively, and finally the model was prepared to predict flows for future decades under climate change scenarios. The results indicate a decrease in peak flow and flood volume on an annual basis due to decrease in precipitation in the 2020s. Comparison of the results with research around the world (Bekiaris, 2005; Feyreisen et al., 2007; Wang et al., 2018; Abou Rafee et al., 2019) shows that although there are many challenges related to simulating hydrological characteristics and basin inputs, the simulation accuracy is acceptable and is consistent with the results of other researchers' studies.

This study provides useful information about the current and future river flow of the Simineh river based on climate change scenarios and can benefit from the results of this research in more precise planning of water resource and Urmia Lake revival projects. The results show an overall reduction of up to 25 percent in the water resources of the basin solely under climate change scenarios. Based on the results of the research, it is necessary to pay more attention to the problems of Lake Urmia. In climate change studies, uncertainties affect the simulation of climate variables by AOGCM models and the correction of the output of these models for application in simulating various systems including water resources at different stages. These sources of uncertainty include uncertainty in emission scenarios, uncertainty in converting greenhouse gas amounts to atmospheric concentration and radiative forcing, uncertainty related to the sensitivity of different AOGCM models to the same radiative forcing, uncertainty related to the simulation of AOGCM models at regional levels and uncertainty in downscaling methods (Ahmadalipour et al., 2017; Minville et al., 2008; Ouyang et al., 2015). Thus, it can be said that the output of hydrological simulation models under climate change have sufficient accuracy for decision making when the uncertainties related to the mentioned cases are applied and analyzed in the relevant calculations. Considering the sources of uncertainty in future studies and using the outputs of the fifth IPCC report is suggested. Since a significant part of the study area is agricultural lands and the livelihood of a large part of the basin dwellers depends on agriculture, and in this season, there is a need for water resources for irrigation of agricultural lands and drinking more, the need for management and planning to preserve water resources and measures appropriate to future changes indicates. Management planning to extract and store water in rainy seasons, development of new water supply methods, use of water consumption and efficiency increasing methods are recommended.

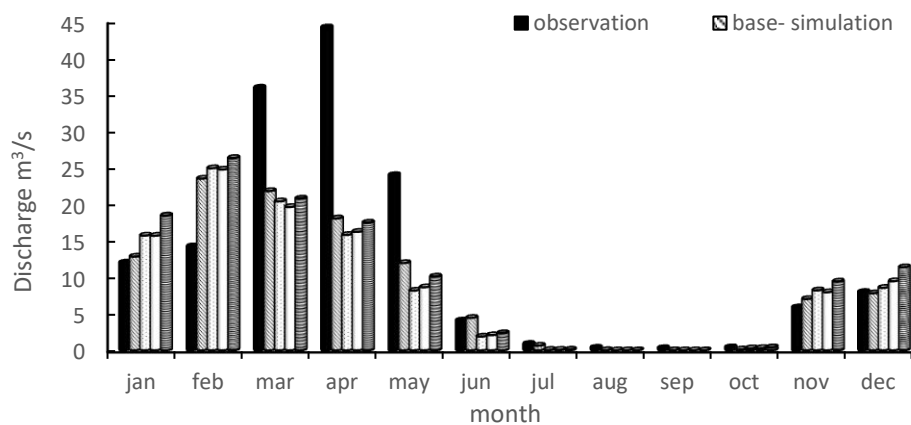

Figure 6. Monthly discharge during the baseline and 2020s periods under climate change scenarios.

Table 3. Monthly and Annual discharge during the baseline (1986–2010) and 2020s periods under A2, B1, and A1B scenarios.

Month	Observation	Simulation	A2	A1B	B1
Jan	12.01	12.83	15.71	15.69	18.46
Feb	14.24	23.51	24.93	24.75	26.33
Mar	35.93	21.81	20.40	19.63	20.79
Apr	44.16	18.06	15.80	16.23	17.49
May	23.99	11.94	8.17	8.63	10.10
Jun	4.08	4.43	1.87	2.07	2.34
Jul	0.88	0.63	0.05	0.06	0.08
Agu	0.35	0.01	0.00	0.00	0.00
Sep	0.29	0.00	0.00	0.00	0.00
Oct	0.40	0.11	0.27	0.30	0.40
Nov	5.88	7.02	8.20	7.95	9.42
Des	7.99	7.80	8.55	7.46	11.37
Annual	12.52	9.01	8.66	8.73	9.73

Acknowledgments

The authors wish to express their appreciation to Urmia Lake Research Institute (ULRI), Iran, for their support and provision of computing facilities. This study is part of a research project which has been financially supported by the ULRI, Urmia University, Urmia, Iran (Grant No. 53/6411926-A-95).

References

- [1] Abbaspour, K., Vaghefi, S., Srinivasan, R., 2017. A Guideline for Successful Calibration and Uncertainty Analysis for Soil and Water Assessment: A Review of Papers From the 2016 International SWAT Conference. Multidisciplinary Digital Publishing Institute.
- [2] Abou Rafee, S.A., Uvo, C.B., Martins, J.A., Domingues, L.M., Rudke, A.P., Fujita, T., Freitas, E.D., 2019. Large-Scale Hydrological Modelling of the Upper Parana River Basin. *Water* 11 (5).
- [3] Aggarwal, P.K., Kumar, N.S., Pathak, D.S., 2010. Impacts of climate change on growth and yield of rice and wheat in Upper Ganga Basin. WWF Report 1–44.
- [4] Ahmadalipour, A., Moradkhani, H., Rana, A., 2018. Accounting for downscaling and model uncertainty in fine-resolution seasonal climate projections over the Columbia River Basin. *Climate dynamics*, 50, 717-733.
- [5] Amin, A., Nuru, N., 2020. Evaluation of the performance of SWAT model to simulate stream flow of Mojo river watershed: in the upper Awash River basin, in Ethiopia.
- [6] Arunrat, N., Pumijumong, N., Hatano, R., 2018. Predicting local-scale impact of climate change on rice yield and soil organic carbon sequestration: A case study in Roi Et Province, Northeast Thailand. *Agricultural systems*, 164, 58-70.
- [7] Bajracharya, A. R., Bajracharya, S. R., Shrestha, A. B., Maharjan, S. B., 2018. Climate change impact assessment on the hydrological regime of the Kaligandaki Basin, Nepal. *Science of the Total Environment*, 625, 837-848.
- [8] Bhatta, B., Shrestha, S., Shrestha, P. K., Talchabhadel, R., 2019. Evaluation and application of a SWAT model to assess the climate change impact on the hydrology of the Himalayan River Basin. *Catena*, 181, 104082.
- [9] Doulabian, Shahab., Golian, S., Shadmehri Toosi, A.H., Murphy, C., 2021. Evaluating the effects of climate change on precipitation and temperature for Iran using RCP scenarios. *Journal of Water and Climate Change* 12,1: 166-184.
- [10] Fan, M., Shibata, H., 2015. Simulation of watershed hydrology and stream water quality under land use and climate change scenarios in Teshio River watershed, northern Japan. *Ecological Indicators*, 50, 79-89.
- [11] Farokhzadeh, B., Choobeh, S., Nouri, H., 2011. Impacts of climate and land-use change on runoff (case study: Balighloo Chai Basin, Iran). *International Journal of Environmental Science and Development*, 9, 3: 86-89.
- [12] Feyerisen, G. W., Strickland, T. C., Bosch, D. D., Sullivan, D. G., 2007. Evaluation of SWAT manual calibration and input parameter sensitivity in the Little River watershed. *Transactions of the ASABE*, 50(3), 843-855.
- [13] Frei, C., Christensen, J.H., Deque, M., Jacob, D., Jones, R.G., Vidale, P.L., 2003. Daily precipitation statistics in regional climate models: evaluation and intercomparison for the European Alps. *Journal of Geophysical Research: Atmospheres* 108(D3): 4124.
- [14] Golmohammadi, G., Rudra, R., Dickinson, T., Goel, P., Veliz, M., 2017. Predicting the temporal variation of flow contributing areas using SWAT. *Journal of Hydrology*, 547, 375-386.
- [15] Horton, P., Schaeffli, B., Mezghani, A., Hingray, B., Musy, A., 2006. Assessment of climate-change impacts on alpine discharge regimes with climate model uncertainty. *Hydrological Processes*, 20(10), 2091-2109.
- [16] IPCC, 2013. In *Clim at Change 2013: the physical science basis contribution of Working Group I to the Fifth Assessment Report of the Intergovernmental Panel on Climate Change*. Cambridge University Press, Cambridge, United Kingdom and New York, USA.
- [17] Jenkins, G., Lowe, J., 2003. Handling uncertainties in the UKCIP02 scenarios of climate change. Technical note 44, Hadley Centre, Exeter, UK.
- [18] Jung, C.G., Kim, S.J., 2018. Assessment of the water cycle impact by the Budyko curve on watershed hydrology using SWAT and CO₂ concentrations derived from Terra MODIS GPP. *Ecological Engineering*, 118, 179–190.
- [19] Konapala, G., Mishra, A.K., 2016. Three-parameter based streamflow elasticity model: Application to MOPEX basins the USA at annual and seasonal scales. *Hydrology and Earth System Sciences* 20, 6: 2545-2556.
- [20] Lehner, F., Coats, S., Stocker, T. F., Pendergrass, A. G., Sanderson, B. M., Raible, C. C., Smerdon, J. E., 2017. Projected drought risk in 1.5 C and 2 C warmer climates. *Geophysical Research Letters*, 44(14), 7419-7428
- [21] Lehner, F., Wood, A. W., Vano, J. A., Lawrence, D. M., Clark, M. P., Mankin, J. S., 2019. The potential to reduce uncertainty in regional runoff projections from climate models. *Nature Climate Change*, 9(12), 926-933.
- [22] Li, C., Fang, H., 2021. Assessment of climate change impacts on the streamflow for the Mun River in the Mekong Basin, Southeast Asia: using SWAT model. *Catena*, 201, 105199.
- [23] Liu, T., Merrill, N.H., Gold, A.J., Kellogg, D.Q., Uchida, E., 2013. Modeling the Production of Multiple Ecosystem Services from Agricultural and Forest Landscapes in Rhode Island. *Agricultural Resource Economic*, 42 (1), 251–274.
- [24] Liu, Y., Xu, Y., Zhao, Y., Long, Y., 2022. Using SWAT model to assess the impacts of land use and climate changes on flood in the upper Weihe river, China. *Water*, 14(13), 2098.
- [25] Luo, M., Liu, T., Frankl, A., Duan, Y., Meng, F., Bao, A., ... De Maeyer, P., 2018. Defining spatiotemporal characteristics of climate change trends from downscaled GCMs ensembles: how climate change reacts in Xinjiang, China. *International Journal of Climatology*, 38(5), 2538-2553.
- [26] López-Ballesteros, A., Senent-Aparicio, J., Martínez, C., Pérez-Sánchez, J., 2020. Assessment of future hydrologic alteration due to climate change in the Arachos River basin (NW Greece). *Science. Total. Environmental*, 733, 139299.
- [27] Lucas-Borja, M. E., Carrà, B. G., Nunes, J. P., Bernard-Jannin, L., Zema, D. A., Zimbone, S. M., 2020. Impacts of land-use and climate changes on surface runoff in a tropical forest watershed (Brazil). *Hydrological Sciences Journal*, 65(11), 1956-1973.
- [28] Mansouri Daneshvar, M. R., Ebrahimi, M., Nejadsoleymani, H., 2019. An overview of climate change in Iran: facts and statistics. *Environmental Systems Research*, 8(1), 1-10.
- [29] Marahatta, S., Aryal, D., Devkota, L. P., Bhattarai, U., Shrestha, D., 2021. Application of SWAT in hydrological simulation of complex mountainous river basin (Part II: climate change impact assessment). *Water*, 13(11), 1548.
- [30] Masson-Delmotte, V., Zhai, P., Pirani, A., Connors, S. L., Péan, C., Berger, S., ... Zhou, B., 2021. Climate change 2021: the physical science basis. Contribution of working group I to the sixth assessment report of the intergovernmental panel on climate change, 2.

- [31] Milly, P. C., Dunne, K. A., Vecchia, A. V., 2005. Global pattern of trends in streamflow and water availability in a changing climate. *Nature*, 438(7066), 347-350.
- [32] Minville, M., Brissette, F., Leconte, R., 2008. Uncertainty of the impact of climate change on the hydrology of a nordic watershed. *Journal of hydrology*, 358(1-2), 70-83.
- [33] Nijssen, B., O'Donnell, G.M., Hamlet, A.F., Lettenmaier, D.P., 2001. Hydrologic Sensitivity of Global Rivers to Climate Change. *Clim. Change*. 50 (1-2), 143-175.
- [34] Nilawar, A.P., Waikar, M.L., 2019. Impacts of climate change on streamflow and sediment concentration under RCP 4.5 and 8.5: A case study in Purna river basin, India. *Sci. Total Environ.* 650, 2685-2696.
- [35] Osei, M. A., Amekudzi, L. K., Wemegah, D. D., Preko, K., Gyawu, E. S., Obiri-Danso, K., 2019. The impact of climate and land-use changes on the hydrological processes of Owabi catchment from SWAT analysis. *Journal of Hydrology: Regional Studies*, 25, 100620.
- [36] Ouyang, F., Zhu, Y., Fu, G., Lü, H., Zhang, A., Yu, Z., Chen, X., 2015. Impacts of climate change under CMIP5 RCP scenarios on streamflow in the Huangnizhuang catchment. *Stochastic environmental research and risk assessment*, 29, 1781-1795.
- [37] Paparrizos, S., Maris, F., Matzarakis, A., 2016. Integrated analysis of present and future responses of precipitation over selected Greek areas with different climate conditions. *Atmospheric Research*, 169, 199-208.
- [38] Pongpetch, N., Suwanwaree, P., Yossapol, C., Dasananda, S., Kongjun, T., 2015. Using SWAT to Assess the Critical Areas and Nonpoint Source Pollution Reduction Best Management Practices in Lam Takong River Basin, *Environmental*, 8, 41-52.
- [39] Rabezanahary Tanteliniaina, M. F., Rahaman, M. H., & Zhai, J., 2021. Assessment of the future impact of climate change on the hydrology of the Mangoky River, Madagascar using ANN and SWAT. *Water*, 13(9), 1239.
- [40] Raisanen, J., Hansson, U., Ullerstig, A., D'oscher, R., Graham, L.P., Jones, C., Meier, H.E.M., Samuelsson, P., Will'en, U., 2004. European climate in the late 21st century: regional simulations with two driving global models and two forcing scenarios. *Climate Dynamics* 22(1): 13-31.
- [41] Sharafati, A., Pezeshki, E., Shahid, S. et al., 2020. Quantification and uncertainty of the impact of climate change on river discharge and sediment yield in the Dehbar river basin in Iran. *Journal of Soils Sediments*, 20, 2977-2996.
- [42] Steinschneider, S., Wi, S., Brown, C., 2015. The integrated effects of climate and hydrologic uncertainty on future flood risk assessments. *Hydrological Processes*, 29(12), 2823-2839.
- [43] Shrestha, S., Bhatta, B., Shrestha, M., Shrestha, P. K., 2018. Integrated assessment of the climate and landuse change impact on hydrology and water quality in the Songkhram River Basin, Thailand. *Science of the Total Environment*, 643, 1610-1622.
- [44] Tan, X., Gan, T. Y., 2015. Contribution of human and climate change impacts to changes in streamflow of Canada. *Scientific reports*, 5(1), 17767.
- [45] Tan, M. L., Gassman, P. W., Cracknell, A. P., 2017. Assessment of three long-term gridded climate products for hydro-climatic simulations in tropical river basins. *Water*, 9(3), 229.
- [46] UNFCCC.AddendumPart Two: Action Taken by the Conference of the Parties at Its Twenty-First Session (FCCC/CP/2015/10/Add.1) and (FCCC/CP/2015/10/Add.3). In Proceedings of the Report of the Conference of the Parties on Its Twenty-First Session; Paris, France, 30 November-13 December 2015, United Nations: New York, NY, USA; p. 01192.
- [47] Wang, G. Q., Zhang, J. Y., Xuan, Y. Q., Liu, J. F., Jin, J. L., Bao, Z. X., ... Yan, X. L., 2013. Simulating the impact of climate change on runoff in a typical river catchment of the Loess Plateau, China. *Journal of Hydrometeorology*, 14(5), 1553-1561.
- [48] Wang, Y., Bian, J., Zhao, Y., Tang, J., Jia, Z., 2018. Assessment of future climate change impacts on nonpoint source pollution in snowmelt period for a cold area using SWAT. *Scientific Reports*, 8(1), 2402.
- [49] Wang, Y., Xu, H. M., Li, Y. H., Liu, L. L., Hu, Z. H., Xiao, C., Yang, T. T., 2022. Climate Change Impacts on Runoff in the Fujiang River Basin Based on CMIP6 and SWAT Model, *Water*, 14(22), 3614.
- [50] Xu, X., Wang, Y. C., Kalcic, M., Muenich, R. L., Yang, Y. E., Scavia, D., 2019. Evaluating the impact of climate change on fluvial flood risk in a mixed-use watershed. *Environmental Modelling & Software*, 122, 104031.
- [51] Zhang, Y., You, Q., Chen, C., Ge, J., 2016. Impacts of climate change on stream flows under RCP scenarios: A case study in Xin River Basin, China. *Atmospheric Research*, 178, 521-534.
- [52] Zhang, W., Villarini, G., 2017. Heavy precipitation is highly sensitive to the magnitude of future warming. *Climatic Change*, 145(1-2), 249-257.

Determination and Static Analysis of the Chassis Model for Electric Vehicles

Koray Erhan^{a*}, Mustafa Can Kurt^b, Feriha Erfan Kuyumcu^c

^{a*} Department of Mechatronics Engineering, Marmara University, Turkey e-mail: koray.erhan@marmara.edu.tr (*Corresponding Author)

^b Department of Mechatronics Engineering, Istanbul Gedik University, Turkey e-mail: mustafa.kurt@ozkurt.com.tr

^c Department of Electric and Electronics, Istanbul Gedik University, Turkey e-mail: feriha.kuyumcu@gedik.edu.tr

Abstract

Vehicle technology with an internal combustion engine emerged at the end of the 19th century. Although it is not very well known, the first prototype studies of the electric vehicle coincide with the same period. Today, factors such as global warming, pollution and the decrease in fossil fuel reserves accelerate the transition to electric vehicle technology. In this context, a new system structure is needed for electrically driven systems differently from traditional vehicle structures. In this study, a chassis design for an electric vehicle is carried out. While designing, the part where the battery pack will be placed has been modeled and simulated with the help of the ANSYS program to protect the battery and electronic components that are particularly sensitive to impacts. In order to be successful in abuse tests such as Crush and Crash tests specified in the regulations and standards, the material selection and design should be done correctly. In this context, the right materials are determined as a result of the researches and 3D simulations are made and crash tests are carried out in the simulation environment. As a result, tube type chassis was chosen among many chassis models and 7079 aluminum alloy was found suitable as raw material. According to the simulation results, it is seen that the design and the selected alloy are suitable.

Keywords: Electric vehicle; Battery; Electric vehicle chassis; Chassis model; Electric vehicle static analysis; Static analysis; Crash and crush.

1. INTRODUCTION

Conventional vehicles will be replaced by electric vehicles in the near future. For this reason, improvement studies on electric vehicles are of great importance. The battery pack constitutes a large part of the cost of electric vehicles. This cost rate can go up to 40%. In addition, the battery pack is highly flammable due to the lithium cells it contains. The design of the structure where the electric vehicle battery pack is located is of great importance in terms of both preventing financial losses and protecting human life [1].

The first generation electric vehicles were built on the same chassis as conventional vehicles. This limits the vehicle interior volume, which is important for passengers. The reason of using conventional vehicle chassis was to try to reduce the production costs of electric vehicles. However, today, brands only use chassis designed specifically for the use of electric vehicles. Electric vehicles have battery packs weighing between 300-700 kg. This weight is an element that will completely change the design of the vehicle. Considering that batteries are sensitive to impact and flammable, it is clearly seen how important the chassis design of electric vehicles is. The only concern in this regard is not the weight or flammability of the batteries. In addition, since electric vehicles are heavier than conventional vehicles, the designed chassis is expected to be lightweight as well as durable. There are many studies on this subject in the literature. Iterative algorithms are proposed for determining the optimal chassis design of an electric vehicle. These algorithms balance the capacity of the battery pack and the dynamic properties of the chassis. Moreover, it seeks to optimize the tradeoff between the mass of the vehicle, its energy consumption, and the travel time. The design variables of the chassis include geometrical and inertial values, as well as the characteristics of the powertrain [2].

With increasing emphasis on lightweight construction design and efficient packaging of new electric powertrains, some techniques have been developed to solve these problems. In order to overcome the difficulties encountered in battery pack designs and to provide a combined solution to these difficulties, methods for integrated topology and packaging optimization

(iTOPO) have been developed to create dynamic component-structure interactions. The examples allow simplified components for battery modules and electric motors to be incorporated into the basic vehicle structure and to integrate up to 43 components simultaneously into a 3D design space. The study results show less than a 10% difference in compatibility despite the addition of various complex integration requirements (e.g., multiple geometries, packing symmetry) of the solution algorithms [3].

If a battery pack fails to meet the desired design criteria, thermal runaway, vibration or vehicle impact can lead to potential failure of lithium-ion (Li-ion) battery packs due to their high sensitivity to ambient temperature, pressure and dynamic mechanical loads. Among various factors, the safety and reliability of battery packs pose the biggest challenges in large-scale electrification of public and private transportation sectors. Simple mechanical features can be integrated into battery packaging design to minimize the probability of failure and mitigate the aforementioned safety risks. Furthermore, the key components of a robust battery pack must be closely studied and the materials have been identified to design these components and to meet their functional requirements.

To minimize battery-related problems, the following design criteria should be taken into consideration. Firstly, the movement of cells within the package should be restricted due to battery pack failures due to thermal runaway, mechanical vibrations, and vehicle impact. Restricting this movement will provide a higher degree of protection against all of them. Secondly, there are a number of mechanical design features. Effective in controlling the associated battery cell movement, i.e. cell spacers, a rigid battery mounting frame, and deformable electrode terminals. Thirdly, it is obvious that the benefits of incorporating a gas vent mechanism also prevent the development of high-pressure events in the battery pack. Additionally, the use of a hollow gas exhaust duct can provide additional dumping. [4].

In this study, a new chassis design will be realized for an electric vehicle, taking into account the placement of the battery pack. By examining the existing chassis designs in the literature, the most suitable structure for electric vehicles will be preferred. Then, the strength analysis of the designed structure will be carried out using the ANSYS program. In addition, the weight and durability of the raw material to be used in the chassis manufacturing for the electric vehicle will be determined. As a result of this examination, the most suitable alloy material for the newly selected chassis model will be determined.

2. ELECTRIC VEHICLES

The first electric vehicle in history was invented in Vermont, America by Thomas Davenport in 1835. Vehicle working principle; It was a small locomotive vehicle using two electromagnets, a pivot, and a battery. During the same period between 1832-1839, the electric vehicle was discovered by Robert Anderson in Aberdeen, Scotland [5].

The vehicles invented in those years did not have the ability to be charged. In 1897, the first electric taxis were used on the streets of New York. One of the most current and strongest brands and models at the moment is Tesla Model S Long Range. This vehicle travels 525 km in a full load [6].

EV's converts electrical energy into mechanical energy with the help of electric motors. They also store electrical energy through batteries. The engines of electric vehicles are simpler than the vehicles with internal combustion engines.

Due to the increase in fuel costs of diesel and gasoline vehicles and because of the environmental effect of petrol-engine [7], people started to be interested in electric vehicles. With the development of battery technology, people's demand for electric vehicles will increase.

Electric vehicles are very economical in terms of fuel and harmless to the environment. Since there is no exhaust emission in electric vehicles, air pollution is almost nonexistent. Electric vehicles work very quietly. On the downside, the necessary infrastructure for electric vehicles has not been established completely yet. Besides that, with full filling, it goes to limited distances and filling times are quite long compared to fuel filling time. Also, the purchase price of electric vehicles is higher than conventional vehicles.

The battery pack is the main energy storage unit of electric vehicles. The battery capacity of the vehicle directly affects the range of the vehicle. Energy recovery technologies such as regenerative braking are also used to increase the efficiency and range of electric vehicles. Figure 1 shows the general structure of an electric vehicle.

The battery pack is the main energy storage unit of electric vehicles. The battery capacity of the vehicle directly affects the range of the vehicle. Energy recovery technologies such as regenerative braking are also used to increase the efficiency and range of electric vehicles. Figure 1 shows the general structure of an electric vehicle.

An electric vehicle basically consists of a battery pack, motor driver, electric motor, battery management system (BMS), power distribution unit (PDU) and on board charger [8].

The battery pack is the vehicle's energy source. The electric motor is the component that converts the electrical energy into mechanical energy that enables the vehicle to move. The motor driver is an electronic component that can provide bidirectional energy flow, controlling the electric motor and sending the regenerative braking energy to the battery. BMS is the unit that monitors the SOX functions of the cells in the battery pack and decides accordingly. SOX function contains three basic information as SOC, SOF and SOH. With BMS, the battery's state of charge (SOC), functionality status (SOF) and health status (SOH) are detected. In addition, voltage imbalances between cells are detected and regulated by BMS.

The PDU is located between the battery pack and the motor driver. PDU is an enclosure fitted with multiple components incorporating various voltages, amperages, and functions connected via internal busbars, cable harnesses, and accessed externally via specific connectors.

On board charger is a circuit on the vehicle itself allows AC charging (low power). To charge at higher powers (fast charge), it is necessary to use a DC charging topology and an external charging station [9].

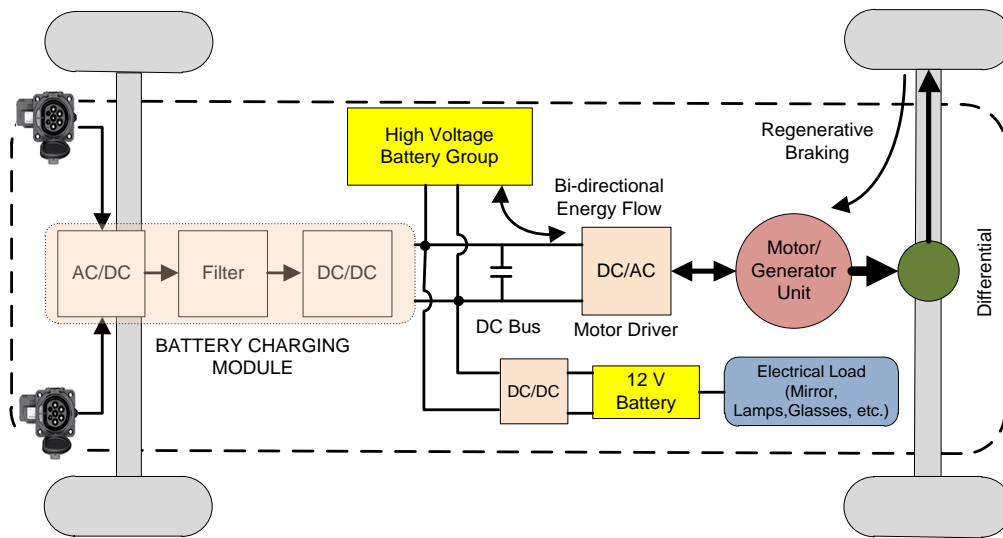

Figure 1. The general structure and energy flow of EVs [10].

2.1 Battery System in Electric Vehicles

The electric energy used to supply the motors in electric vehicles is stored in batteries. Batteries are available in a wide variety of structures. These are lead-acid battery, nickel-based battery and especially lithium battery. Lead-acid batteries are specially used in internal combustion engines as an auxiliary battery. Today, lithium-based batteries are the most commonly used batteries in electric vehicles.

Nickel-based batteries are often used in hybrid electric vehicles. Cycle life of nickel batteries can be up to 2000 cycles. However, energy and power density values are lower than lithium batteries. In addition, the memory effect found in nickel-based rechargeable batteries is not found in lithium batteries. Therefore, lithium batteries do not need to be fully charged.

Today, batteries used in electric vehicles are lithium batteries due to their high energy and power density values. Lithium batteries also have their own varieties. These are chemical compounds formed by lithium with different substances. LMO, LFP, LTO, NMC, NMO, NCA, LiCoO₂ chemistries are some of them [11]. These chemistries show different performances in areas such as cost, energy density, power density, reliability, safety, life span. It is necessary to choose the appropriate battery for the application. Figure 2 shows the comparison of the lithium batteries in the spider chart [12]. Generally 10 years lifetime-guarantee is given. The energy density of solid-state lithium batteries is around 400Wh/kg. However, in non-solid state batteries, this value is between 100-265 Wh/kg, 250-670 Wh/L [13]. The battery energy management system is the best way to charge an electric vehicle with a charger. In order to charge the battery in the best way, information about the state of charge, temperature, voltage and current is needed. A microprocessor is used to receive this data and evaluate it in an algorithm.

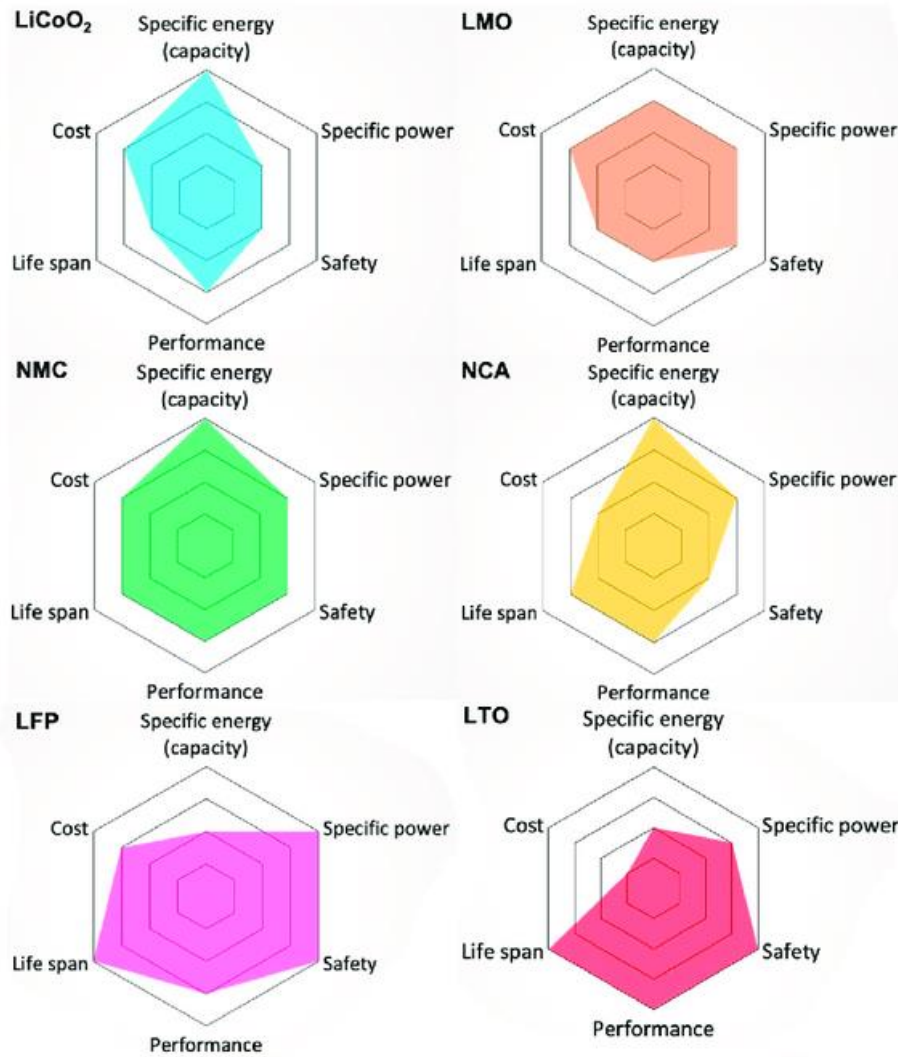

Figure 2. Comparison of various lithium battery chemistries [12].

Today, electric vehicle charging is done with the help of a cable and plug. However, there are many studies on wireless charging. In wireless charging, there is no physical connection between the vehicle and the charging station. Here, energy transfer is carried out electromagnetically. It is expected that this type of charging systems will become widespread in the near future.

In addition to these, battery pack replacement technique is also used in some countries [14]. In this system, the vehicle's battery is removed from its connections at the charging station and replaced with a charged battery. For this, the vehicle and the battery pack must be designed in accordance with this change. This process can be completed in a few minutes. However, today, the increase in vehicle variations causes battery packs to be produced in a wide variety of geometries and capacities. Since this situation will make it necessary to have battery packs belonging to tens or even hundreds of different types of vehicles at charging stations, it does not seem possible to use this technology after electric vehicles become widespread. In Figure 3 the structure of a battery pack is given.

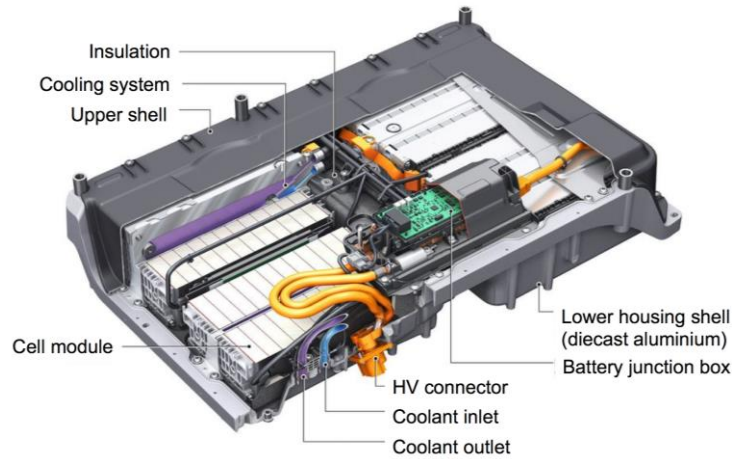

Figure 3. Die-cast aluminium battery enclosure for the Audi e-tron [15].

3. CHASSIS DESIGN AND STATIC ANALYSIS

There are many types of materials in the automotive industry. When classifying these materials, different mechanical properties of each material class are taken into account. Function, material, shape and production management should be considered as a whole. It is important that the material to be used is suitable for the design and structure of the vehicle. Some factors need to be considered when designing vehicles. Some of these can be listed as the class, volume, geometry, security level of the vehicle [16].

After these conditions are met, engineers make decisions based on the cost, environmental friendliness, quality, strength and machinability of the materials to be used. And it also checks the security values according to where it is used. In today's vehicles, 55% - 60% metal material, 18% - 25% plastic material and 7% to 15% rubber material are used. In the chassis model designed within the scope of this study, the ratio of steel alloy material is reduced to around 10-15%. The remaining 45% is designed to be aluminium alloy. The main reason for choosing this material is that electric vehicles are heavier than conventional vehicles. Today, the battery pack weight of an electric vehicle designed as a passenger car varies between 300 and 500 kg. In order to reduce this weight difference, aluminium alloys with less specific gravity are preferred.

Mass production in the world first started in the automotive industry in the first quarter of the 1900s. In this process, the chassis and bodies of the vehicles were produced together. This caused difficulties and time loss in terms of flexibility of production. Then the chassis and body were produced separately and connected to the processing through two different channels. The assembly of the chassis and other mechanical parts on it has become easier. Long time ago, vehicles were produced as ground sub-frame. It was formed by profiles connected with a 90-degree angle with the help of rivets, screws and welds. This technique is rarely used in the production of today's vehicles.

Chassis types are examined in 5 groups according to the usage patterns of the vehicles. Ladder type, space type, keel type, bathtub type, monocoque type chassis. There are many chassis designs in electric vehicles. The most commonly used chassis type of these is the metal monocoque chassis. The designed vehicle body has a bathtub-type chassis flat. As the name suggests, it got this name because its appearance and chassis structure resembles a bathtub type. In addition to being a type similar to Backbone and Ladder Frame Chassis type, it is a chassis type produced in accordance with today's modern design and production philosophy. In this design, the driver and passengers are provided with a living space, which can be called a bathtub, and in addition to this main part, the front and rear links carrying the vehicle's undercarriage are mounted to obtain the main skeleton of the vehicle. Generally, materials such as aluminium alloys or carbon fibre are used in this chassis type. Figure 4 shows the bathtub style chassis developed for electric vehicles. A large battery pool is located in the middle of the chassis. The battery pack, which is the heaviest part of the vehicle, is placed in this area and the vehicle's center of gravity is pulled down. In addition, the pack is placed in the middle of the vehicle to minimize damage to the battery pack in the event of an accident. In the realized design, the chassis part of the vehicle consists of five parts. These are the front bumper, the front suspension and engine mount, the battery pool, the rear suspension link and the rear bumper.

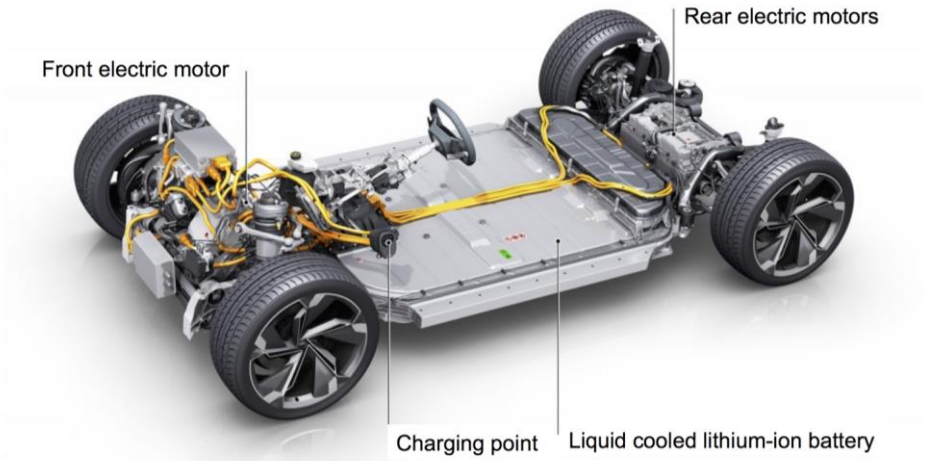

Figure 4. Bathtub style chassis developed for electric vehicles (Audi e-tron) [15].

Chassis materials of some mass production vehicles are given in Table 1. When the table is examined, aluminium is preferred in the simulations because it is the material that increased the vehicle weight the least. Due to its favourable physical properties aluminium 7079 alloy was used in the vehicle chassis. In Figure 5 and Figure 6, the general view of the designed chassis is given.

Table 1. Materials used for battery pack casing in some mass production cars [4].

Vehicle	Material used for battery case
Tesla Roadster	Aluminium
Honda Fit EV	Steel
Chevrolet Volt	Steel
Chevrolet Spark EV	Composite
BMW i3	Aluminium

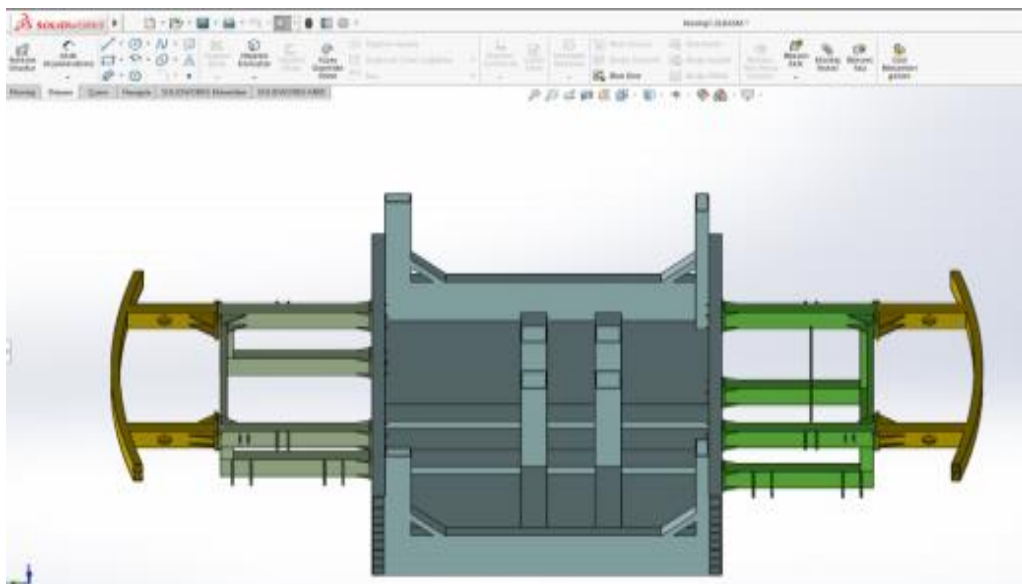

Figure 5. Tub type chassis installation view-1.

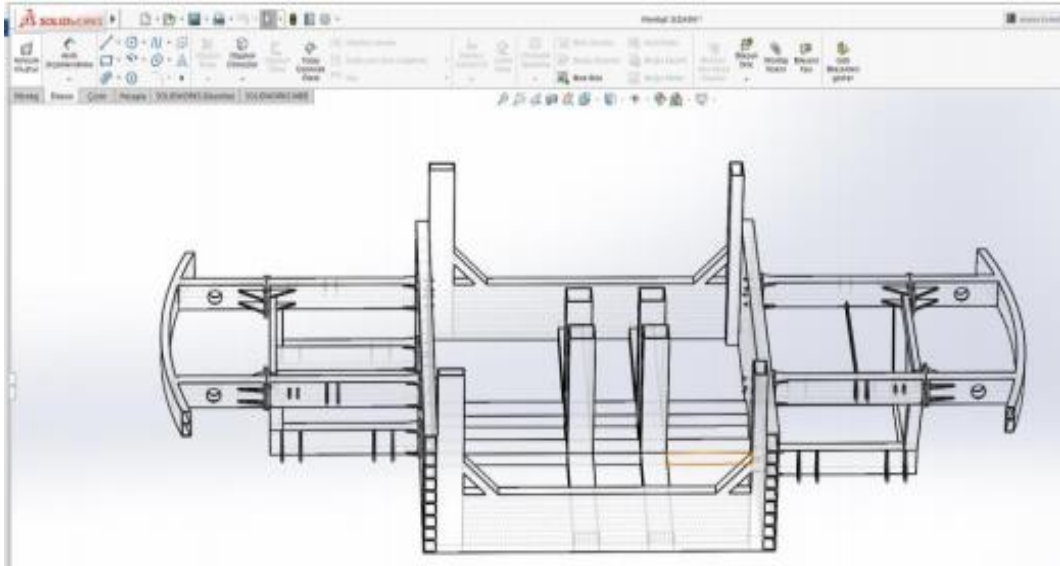

Figure 6. Tub type chassis installation view-2.

The connection types of these 5 main parts are made by welding and galvanized steel bolts. The main parts are made of aluminium 7079 alloy profiles. In this analysis, our analysis results were obtained by using the static structural command in the ANSYS program. The main topics that we create and review are; Solution Information, Equivalent Stress, Total Deformation, Maximum Principal Elastic Strain, Vector Principal Stress, Maximum Shear Elastic Strain. In Figure 7, the sections of the tub chassis, the connection and contact points of these sections and their visuals from different angles are given.

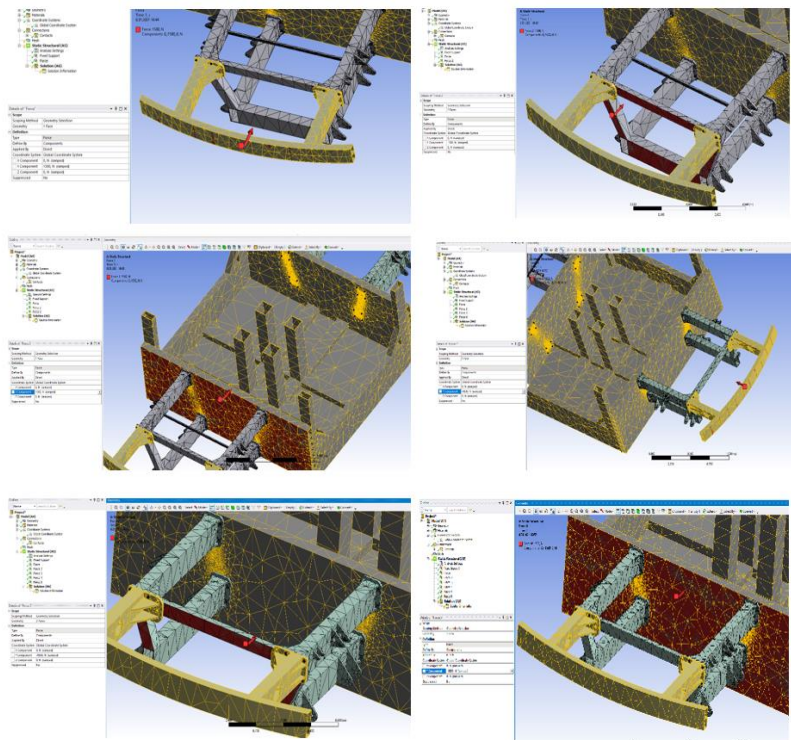

Figure 7. Tub-type chassis zone mesh images and force applied zones.

The deformations that occur in the whole system as a result of the 1500 Newton force applied from the bumper joint surfaces of the rear suspension are shown in Figure 8, and Figure 9, Figure 10. There are deformations in the front profiles, but they do not show much damage according to the force applied. In order to prevent this deformation, it is necessary to strengthen the upper part support elements. On the other hand, this means an increase in vehicle weight. Since there is not much deformation, it is not necessary to reinforce it with support.

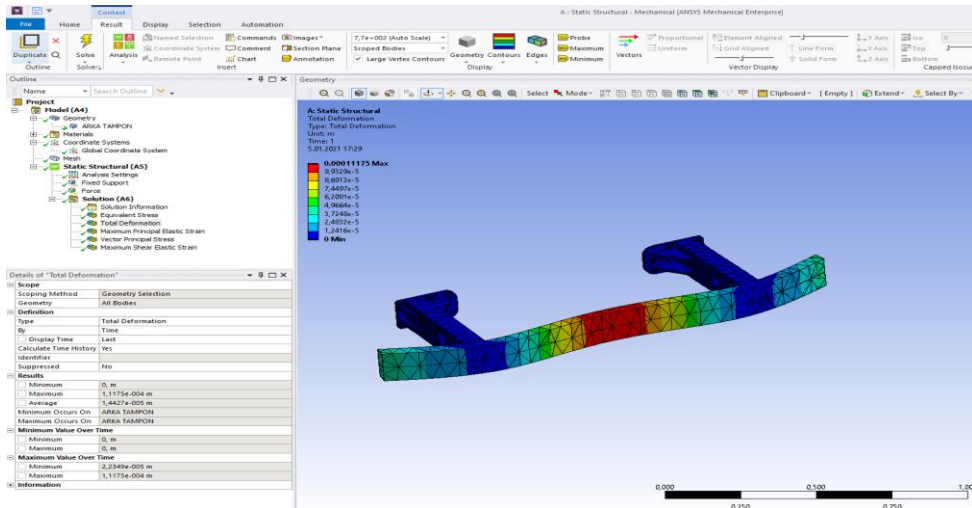

Figure 8. Front and rear bumper total deformation analysis.

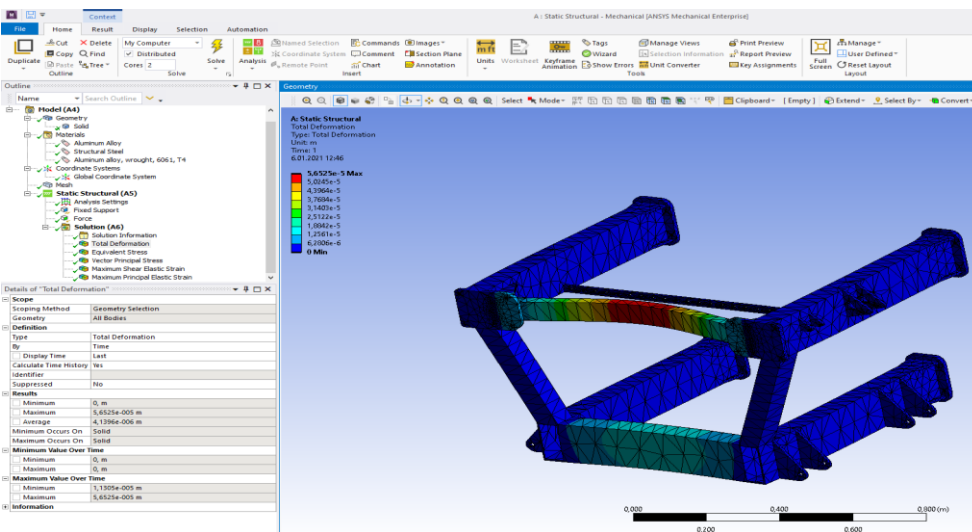

Figure 9. Total deformation analysis of front and rear suspension and motor connected part.

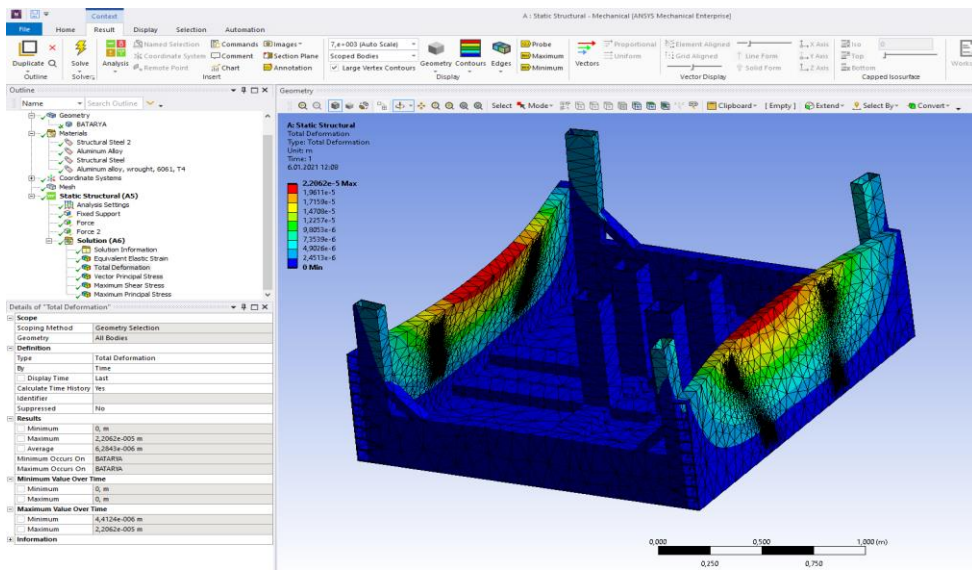

Figure 10. Battery pool total deformation analysis.

4. CONCLUSION and RECOMMENDATIONS

The biggest problems for electric vehicles are limited range and long charging times. Today, there are vehicles that can reach a range of 600 km on a single charge. However, these vehicles have large battery packs such as 90-100kWh capacity. Large battery capacity means high vehicle weight. The battery weights of these vehicles can reach 600kg. Compared to conventional vehicles, electric vehicles weigh much more. In order to compensate for this situation, the materials to be used in the vehicle chassis must be carefully selected.

In this study, the effect of the material used on the vehicle weight is revealed in a striking way. When aluminium alloy materials are used in the electric vehicle chassis design, it is seen that the extra weight from the battery can be significantly compensated.

As a result, it is seen that one of the most suitable raw materials to be used in the chassis is 7079 aluminium alloy material. Most of the chassis is made of this alloy. Considering the literature and prototypes, it is seen that the most suitable chassis model for electric vehicles is the tub-type chassis. It is seen that this chassis type is more protected against possible collision situations and is advantageous because it pulls the vehicle's center of gravity down.

Some analyses were made about the material selection and the accuracy of the designed chassis model. The static analysis module of the ANSYS program was used for these analyses. Among the results obtained, there are many data such as total deformation value, vector basic elastic stress value, equivalent elastic stress value, maximum principal stress and vector stress value. In static analysis, a force of 1500 Newtons is applied to each part surface to examine the total deformations of the parts one by one. As a result, no significant deformation occurred on the parts. It can be said that the results are quite good. It is seen that the chassis design and the aluminium 7079 material used make the electric vehicle quite light. In addition, it has been determined that the durability values are almost equal to those of steel chassis vehicles.

In the static analysis; it is seen that the chassis parts are deformed by a maximum of 9 mm against the 1500 Newton force applied to the front bumper. It has been calculated that when the same force is applied to the same type of chassis structure made of steel raw materials commonly used in conventional vehicles, a maximum deformation of 6.9 mm occurs in the chassis. There is no significant difference in the deformation values detected in two different materials under the same loads. However, when the chassis weights are compared, the weight of the chassis designed from Aluminum 7079 alloy material for the same type of structure is 408 kg, and the steel chassis weight is 1.136 kg. The difference is quite large for a vehicle. The intended design within the scope of this study has been successfully achieved.

Funding

No financial support was received from any institution or person within the scope of this study.

Declaration of Competing Interest

The authors declare that they have no known competing financial interests or personal relationships that could have appeared to influence the work reported in this paper.

References

- [1] PISTOIA, Gianfranco; LIAW, Boryann (ed.). Behaviour of lithium-ion batteries in electric vehicles: battery health, performance, safety, and cost. Springer, 2018.
- [2] LUQUE, Pablo, Daniel A. Mántaras, Álvaro Maradona, Jorge Rocas, Luciano Sánchez, Luis Castejón, and Hugo Malón. 2020. "Multi-Objective Evolutionary Design of an Electric Vehicle Chassis" *Sensors* 20, no. 13: 3633. <https://doi.org/10.3390/s20133633>.
- [3] ROOPER SWK, Kim IY. Integrated topology and packaging optimization for conceptual-level electric vehicle chassis design via the component-existence method. Proceedings of the Institution of Mechanical Engineers, Part D: Journal of Automobile Engineering. 2023;237(9):2118-2131. doi:10.1177/09544070221113895.
- [4] SHASHANK Arora, Weixiang Shen, Ajay Kapoor, Review of mechanical design and strategic placement technique of a robust battery pack for electric vehicles, *Renewable and Sustainable Energy Reviews*, Volume 60, 2016, Pages 1319-1331, ISSN 1364-0321, <https://doi.org/10.1016/j.rser.2016.03.013>.
- [5] WAKEFIELD, Ernest Henry. History of the electric automobile-hybrid electric vehicles. 1998.
- [6] STRAUBEL, J. Driving range for the model S family. Tesla Motors, 2015.
- [7] BOULTER, P.; LATHAM, Stephen. Emission factors 2009: Report 5-a review of the effects of fuel properties on road vehicle emissions. 2009.
- [8] SOYLU, Seref (ed.). Electric vehicles: modelling and simulations. BoD—Books on Demand, 2011.
- [9] SINGH, Krishna Veer; BANSAL, Hari Om; SINGH, Dheerendra. A comprehensive review on hybrid electric vehicles: architectures and components. *Journal of Modern Transportation*, 2019, 27.2: 77-107.
- [10] Koray Erhan, Engin Özdemir, Prototype production and comparative analysis of high-speed flywheel energy storage systems during regenerative braking in hybrid and electric vehicles, *Journal of Energy Storage*, Volume 43, 2021, <https://doi.org/10.1016/j.est.2021.103237>.
- [11] WARNER, John T. The handbook of lithium-ion battery pack design: chemistry, components, types and terminology. Elsevier, 2015.
- [12] MIAO, Yu, et al. Current Li-ion battery technologies in electric vehicles and opportunities for advancements. *Energies*, 2019, 12.6: 1074.
- [13] LI, Jianlin, et al. Toward low-cost, high-energy density, and high-power density lithium-ion batteries. *Jom*, 2017, 69.9: 1484-1496.

- [14] MATHEW, M., et al. Simulation of lithium ion battery replacement in a battery pack for application in electric vehicles. *Journal of power sources*, 2017, 349: 94-104.
- [15] Geoff Scamans, ARTICLE: Electric Vehicles Spike Demand for High Strength Aluminium Extrusions, Innoval Technology and Brunel University, September 2018. <https://www.lightmetalage.com/news/industry-news/automotive/article-electric-vehicles-spike-demand-for-high-strength-aluminum-extrusions/>
- [16] BIN AB RAZAK, Mohd Suffian; BIN HASIM, Mohd Hudairee; BIN NGATIMAN, Nor Azazi. Design of Electric Vehicle Racing Car Chassis using Topology Optimization Method. In: *MATEC Web of Conferences*. EDP Sciences, 2017. p. 01117.

Improving The Thermal Comfort Of The Structures By Applying The Sustainable Engineering Requirements

Basheer Majeed Ali^{a*}, Redvan Ghasemlounia^b

^{a*}Graduate Studies Institute, Engineering Management Program, Istanbul Gedik University, Istanbul, TURKIYE
basheermajeed90@gmail.com (*Corresponding Author)

^bAssociate Professor, Engineering Faculty, Department of Civil Engineering, Istanbul Gedik University, Istanbul, TURKIYE
redvan.ghasemlounia@gedik.edu.tr

Abstract

As a result of the ozone hole, which caused climatic changes in places near the equator, one of these areas is Baghdad's capital, and as a result of the absence of agricultural fields, the emergence caused climate changes. Baghdad climate is hot and dry, with a long time, summers that are hot and short, cold winters. Iraq's weather is impacted by its position among Arabian desert's tropical dryness and the Persian Gulf's tropical humidity, According to the United Nations, Iraq is the fifth-most susceptible country to warming temperatures. According to Berkeley, temperatures have risen by 1.8 degrees Celsius (3.2 degrees Fahrenheit) during the last thirty years. Earth, much above the world average, with summer temperatures often reaching 50 degrees Celsius (122 degrees Fahrenheit), (Washington journal post). Modern thermal comfort theories recommend that a restricted temperature difference be evenly maintained throughout all architectural styles, regions, and people. This strategy treats structure inhabitants for heating purposes, resulting in thermal comfort criteria that necessitate power climate management measures. This frequently results in a high need for air conditioning. Initial investigation and new Technology, HVAC (Heating, Ventilation, and Climate Control) advanced facilities are contesting conventional assumptions of thermal comfort criteria on the basis that they ignore main social and environmental comfort elements. In this paper the researcher took the effect of the modification in the design on the thermal comfort by several engineering solutions for reducing the total main radiant temperature (TMRT), Potential air temperature (PAT), and the developing of the relative humidity (RH) with the wind speed (WS) Which are playing a significant role on improving the urban heat island (UHI) The research mainly aims to analyze the effect of urban green spaces on the urban heat island as a common strategy for improving the thermal comfort. It is worth noting that changes in the urban design of built buildings, whether under construction or before design (green or sustainable building) have a significant impact on the energy used for air conditioning the building, as it reduces the energy used for cooling in the summer and heating in the winter, and thus reduces energy costs. by applying the sustainable requirements led to reduce in yearly cooling loads by (24.97%), resulting in a quarter decrease in energy loss. As a result, this research is an attempt to provide a clear notion to the designer about the benefits of the smart exterior technology implementation and to promote its adoption, (Dr.Ibrahim j.Al –Yousif).

Keywords: Urban Heat Island (UHI), Thermal Comfort, Total Mean Radiant Temperature (TMRT), Potential Air Temperature (PAT), Relative Humidity (RH).

1. INTRODUCTION

One of the biggest and most important concepts developed in the twentieth century was sustainability, which had an important role in the engineering fields. Sustainable practices aim to safeguard financial stability while maintaining the long-term value of the environment, and they offer a framework to integrate rules with future growth. (Maysoon.M.et al., 2014), During the last few years, the community began alerting to the fact that the construction industry is no longer isolated from environmental threats that threaten the world. These sectors consume the most dangerous environmental resources, including soil, resources, and water, as well as energy. Contrary to popular belief, the construction industry is a highly complex industry which generates large amounts of noise population and construction. Researchers have recently exhibited an increased interest in the major issues of energy and water waste in building due to its continuing use throughout the structure's life. Throughout the design and execution stages, a new notion has been developed in the minds of the sophisticated industrial countries in the globe that were not familiar with

previously Sustainability, green buildings, and sustainable construction are all the same thing. These terms reflect a growing interest in aspects of urban economic development that are concerned with environmental protection, reducing energy consumption, making the best use of natural resources, and relying more on renewable energy sources. Previous research have reported on sustainability in construction in general, but there is no professional study on the crucial role of sustainability in the building sector to prevent negative environmental effects. The balance of economic, social, and environmental objectives in the present and future was a fundamental topic in early Sustainable Development research, and it is becoming increasingly important for a range of organisational and geographical demands. As a result, the environment has become a prominent concern on global, regional, and national education policy agendas in recent years (Ali-Toudert F, 2005). The purpose of sustainable engineering is to create new solutions to fulfil human needs while minimising negative environmental consequences. This approach acknowledges that natural resources are limited and that the earth's ecosystems have a finite carrying capacity. Engineers use sustainable practises to reduce waste, pollution, and energy consumption while increasing efficiency, durability, and social equality.

(Mohammad Taleghani, 2011) determined that the three primary concepts for structural sustainability are sources the field of economics construction life cycle, and human design. These principles may be expressed as follows:

a. Energy and water-saving: this concept comprises energy savings by designing environmental circumstances according to the construction guidance, wall thickness, sufficient preparation for the work site, and the utilization of natural energy throughout the form and its resources.

b. Building life cycle: Each structure goes through three phases during its lifetime, as shown by the period beforehand constructing, which involves the preparation and the provision of supplies and supplies, the erection phase, which corresponds with the initial phase and consists of the non-use of natural resources throughout execution, and the stage after completing the building, that offers reuse of the building and facilities.

c. Human Design: Entails conserving all ecosystems via topographical assignment, design of cities, and construction planning by utilizing the drawings of neighboring buildings to decrease energy and water requirements and promote human comfort through health maintenance.

For a long time, a lack of renewable energy has been a health issue. Over the last several years, there has been concern about the use of natural resources during construction execution, which has resulted in waste of land, pure water, wood, iron, and other non-renewable resources such as petrol, gas,...etc, which could give rise to a lack of these supplies in the future. Sustainability is defined as the appropriate use of resources such as land, sunlight, and circulation to limit the consumption of nonrenewable energy (Prutha Platelet et al., 2009).

Based on the IPCC assessment, major worldwide pollution decreases of at least 50% below 1990 levels are necessary up to 2050, with additionally global emissions declines after 2050 needed to establish a low-carbon society by the end of the 21th century. It's the only way to keep the temperature rise to two degrees Celsius, which is regarded to be the highest level that humans can bear without suffering catastrophic consequences.

(Ratti. C et al., 2003), defined environment as a collection of environmental circumstances across time. Several vocabularies are used based on the size of the part of the world under discussion. At the person or restricted location level, we use the phrases macroclimate for a large area, meso climate for an average-sized region, regional climate, and ecosystem for a small region.

Local climate trends are frequently connected with surface areas ranging from just a few square meters to a few kilometers. It can refer to a hillside, a canyon, or a portion of a constructed time, for instance, and is characterized by significant variations in temperature, moisture content, wind, daylight because of the unique characteristics of the landscape, urban shape, position, resource nature, proximity to water, appearance or lack of vegetative cover, and so on (Setaih. K et al., 2013).

1.1 Thermal Comfort

Thermal comfort (the research's topic) is an important component of human pleasure. It is up to the designers to make this a reality. The human body constantly generates heat through metabolism, and maintaining thermal comfort involves balancing heat gain and heat loss. Several factors affect how individuals perceive and experience thermal comfort. Whichever of the subsequent sustainable construction goals intended to give the best level of thermal comfort for the institution's inhabitants yet using the least quantity of energy to try to cool in summer and heat in the winter? And, understanding the type of objects within the structure

and the character of its consumers from the bottom up is crucial when developing the correct heat medium for any property or any interior space. Gender, as well as the type of activity performed in the architectural areas Humans are affected by the environment in a number of ways. Thermal comfort constitutes one of the physical factors that influence an individual's general health and the sense of repair without relief. Thermal temperature develops as a result of a mix of surrounding conditions and sloughing, as the surrounding environment can remain heat-free. And was given. 37 degrees Celsius Sensation and no surplus wetness at a comparable rate of production while keeping the air temperature constant at 35 degrees Celsius, In the moment, the linguistic meanings varied while possessing the same content, and they were in disagreement. It is a state of mind in which a person is at ease and pleased with his or her current circumstances. Any average person who lives in it lacks thermal relaxing if the temperature increases or decreases over defined limits, i.e. he is not at peace in high temperatures and additionally not comfortable in extremely cold temperatures. The body's ability to maintain a balance among its own heat and the temperature of its surroundings (Fanger, P.,1988).

1.2 Factors that influence thermal comfort

1.2.1 The potential air temperature

It is a term employed in meteorological to represent the temperature of an object of atmosphere if it was raised internally (as opposed to adding or removing heat) to a standard pressure level, commonly 1000 hPa (hector pascals) or 1000 mb (milli bars).

The theoretical temperature is useful since it enables an analysis of mass of air at various pressure settings. It offers an indicator of the "heat capacity" of the air packet that is not affected by variations in pressure or volume. The real ambient temperature (estimated in Celsius degrees or Kelvin) and the actual pressure level where you are calculating the potential temperature are required for determining the potential temperature. The potential temperature may be calculated using the following formula:

$$\theta = T * (P_0 / P) ^ (R / C_p)$$

In which P0 is the normal pressure stage (e.g., 1000 hPa), P is the pressure stage that it is desired to determine the possibility of temperature, R is the particular gas unchanged for dried air (around 287 J/(kg.K)), and Cp is the specific heat capacity at steady pressure for evaporate air (around 1005 J/(kg.K)). Using this method, you may calculate the potential temperature at a particular level of pressure and learn about the thermal properties of the air parcel , (George Reeves et al ., 2001).

1.2.2 Total Mean Radiant Temperature (TMRT)

is the sum of all irradiance doses to which a live body is exposed - governs unique thermal comfort, On the median, radiant heat Although the interaction of radiant and turbulence thermal profits or losses has a considerable influence on the human equilibrium condition in outdoor situations, TMRT is the most important climatic factor influencing human energy expenditures throughout sunny weather in summer. Raymond output may also be used to calculate TMRT. "Trying to Calculate the Total Mean Radiant Heat in Urban Infrastructure - Assessment of Heating Index", The mean radiant temperature (TMRT) is one of the most important factors impacting human thermal comfort in an urban environment (Lindberg et al., 2014).

The periodic warming of a fake boundaries in which the radiation heat transfer from the majority of the human body's unit matches that of an actual irregular barrier is referred to as TMRT. ISO stands for the World Organization for Standardizations. It is the average temperature of the human body's radiation surrounds as its entirety. In compared to recirculation or the process of e solar energy flow accounts for a large fraction of body heat transfer (Folk G.et al., 1974). because it is closely related to both the environment and pedestrian action (Whyte.W,1980).

As a consequence, modelling convective heat transfer in both live beings and their environment is a realistic concern. We will be able to predict and manage the effects of heat in relation to the expanding urban heat island effect (UHI) and increasingly severe weather events once TMRT is defined in a real-world urban setting. TMRT varies both chronologically and spatially in cities as urban buildings react to sunlight by collecting, reflecting, or creating radiation at various wavelengths (Jianxiang, 2014).

Exterior shading affects the temperature outside and human interior thermal comfort, influencing space utilization (Tzu, 2012). It was established that if a place is slightly more shaded throughout the spring, summer and autumn, human thermal comfort increases. Because a sparsely shaded condition can give rise to more solar rays in the winter, someone's thermal condition is greater when the location is less protected (Hwang et al., 2011).

The mean radiant temperature (TMRT), which summarizes both short-term and long-wave energy fluxes (including direct and reflecting) that every person is exposed to, is one of the most critical environmental elements impacting human energy equilibrium and living conditions (Sofia, 2007).

1.2.3 Relative Humidity (RH)

The temperature, humidity, and wind speed of the room all influence thermal comfort. Other factors that impact your comfort include your level and habits, clothing, your gender, your age, and overall health. Thermal radiation (hot surfaces) and thermal radiation loss (cool surfaces) both influence heat transport. The environment's moisture content (RH) is an indication of its water contents in proportion to the feasible saturated level. Warmer air may retain more humidity. When absorption reaches 100%, the dew point is the temperature at which air water collapses. Since temperature affects the humidity ratio, (George Reeves et al., 2001).

The relative humidity is calculated using the following formula:

$$RH = (e / e_s) * 100\%$$

Where, RH is the relative humidity (expressed as a percentage), e is the actual vapor pressure, and e_s is the saturation vapor pressure at the given temperature. As chilly air from outside heats up, humidity levels decrease. Fridge cooling systems usually remove humidity from the air as they cool. The process of a conditioner introduces water into the air. Moisture levels are stated as a percentage of the quantity of moisture particles that are expected to be present in the atmosphere to the maximum number that can be kept until precipitation occurs. It is usually expressed as a percentage.

1.2.4 Wind velocity

Wind is the movement of air masses caused by differences in atmospheric pressures caused by topography and water, involving air temperature fluctuations that can occur on a basic (between various locations) or minor proportions (riverfront, lakefront zone, lowlands, and so on). In the first case, we're discussing global winds, but in the second, we're discussing localized winds. Three characteristics characterize air: speed, place of blowing, and consistency.

The impact of geography on localized storms is substantial and quantitative. The air configuration varies as a result of two factors on the ground with challenges: topography layer density and height. Wind is detected by meteorological sensors situated in specified geographical areas. Changing the surroundings influences the velocity, especially in relation to the elevation in the given site (Federico M. Butera, 2014).

1.3 Improving Thermal Comfort

Enhancing thermal comfort in structures entails taking into account a variety of elements that influence the atmosphere inside. Particular solutions for improving thermal comfort in structures include as follows:

a. Insulation: Appropriate exterior wall insulating reduces heat transmission via walls, roofs and floors. This comprises materials that insulate like fiberglass, foam, or cellulose, which serve to reduce the gain of heat in the summer and heat loss in the winter.

b. Efficient windows: Putting low-emissivity (low-E) treatments and multiple layers of glass on windows that are energy-efficient can assist limit heat transmission and manage solar heat absorption. Such windows can help improve efficiency and reduce draughts.

c. Shading: External shading devices like awnings, overhangs, or louvers can block direct sunlight from entering the building, reducing heat gain. Internal shading options such as blinds or curtains can also be used to control sunlight and glare.

d. Natural ventilation: Organic ventilation mechanisms in structures enable the inhalation of new air and the evacuation of stagnant air. This may be accomplished by arranging doors, vents, or movable sunroof to improve air flow and offer cooling in moderate weather.

e. Mechanical ventilation: In buildings where natural ventilation is not feasible or insufficient, mechanical ventilation systems can be installed. These systems ensure a continuous supply of fresh air while also providing the opportunity to control indoor air temperature and humidity.

f. Efficient HVAC systems: The presence of heat, airflow, and climate control (HVAC) systems are critical to preserving thermal comfort. Using energy-efficient HVAC systems, such as those with variable speed fans or inverter technology, may give more accurate temperature control while also reducing energy use.

h. Occupant control: Giving people control over their local surroundings improves comfort. Variable temperature controls, such as heaters or fan speed controls, allow occupants to customize the environment to their liking.

i. Lighting design: Appropriate illumination layout may lower the amount of heat produced by lighting fixtures, reducing the need for extra cooling. Lighting solutions that use less energy, such as LED lights, produce less heat and add to overall thermal comfort..

1.4 ENVI- Met 5.0.3

The ENVI- Met 5.0.3 Atmospheric Visualization and Data System for Urban environments is an application or model designed to improve thermal comfort micro size ecological models in urban environments. It is a software application designed to simulate urban climates, outside thermal comfort, and airflow dynamics. It enables extremely fine research and modelling of how environmental parameters such as moisture, humidity, temperature, wind, and solar radiation fluctuate inside cities and metropolitan regions. ENVI-met is frequently utilized by academics, developers, designers, and ecological consultants to examine the ecological effect of architectural decisions, green buildings, and environmental protection initiatives. It may aid in comprehending and optimizing elements such as building location, green space transportation, and material selection in order to promote outdoor comfort, minimize heat island impacts, and improve general sustainability in cities. To build 3D simulations and visualize how things look inside urban settings, the programmer integrates climate data, urban mathematics, vegetative knowledge, and other characteristics. It aids in assessing the efficacy of various urban design initiatives in fostering sustainable and livable urban settings.

2. METHODOLOGY

2.1 Study Area

A Place near of a governmental multi store building (printing house) in Baghdad city is selected for the study as shown in Figure 1. This place was selected since it is an essential the spot with large modern printing equipment to create various printing manufacturing such as newspapers, magazines, and booklets in various cutoff sizes, particularly as it is a government agency that gave it a special importance to print private papers such as colleges and schools exams copybooks and exam questions as well as government secret documents due to its privacy even though many commercial products are being that Many land surface temperatures can be found in the chosen location. that the chosen area has many land surface temperature (LST) principles, that affect the thermal comfort of the constructions and people walking around the buildings; additionally, there is no green cover, such as trees or plants, which contributes to better thermal comfort or provides some shade in summer conditions.



Figure 1. Selected Building (Printing House Al Sabah Newspaper).

2.2 Preparation of The Model For Simulation

It is utilized in the development of the model by ENVI-met 5.0.3 software to give actual imagination for the simulation process to offer excellent results after the modification by the ENVI-met program. One of the ENVI-met program's features is the ability to find the location of the selected area and automatically provide the latitude and longitude of this area, which provided accurate results for air temperature, wind speed, relative humidity, and total mean radiant temperature. Reality information should be entered like the nature of the main road which is paved by asphalt and the interior road's materials which

is paved by concrete, the nature of the building walls and roofing materials in addition to determine the true north for the building which is important to give the actual building orientation to the sunlight or thermal radiation, these functions must enter accurately before designing the model carefully to give accurate and satisfying results to improve the thermal comfort for the environment and the human using this building or walk around it as shown in Figure 2.

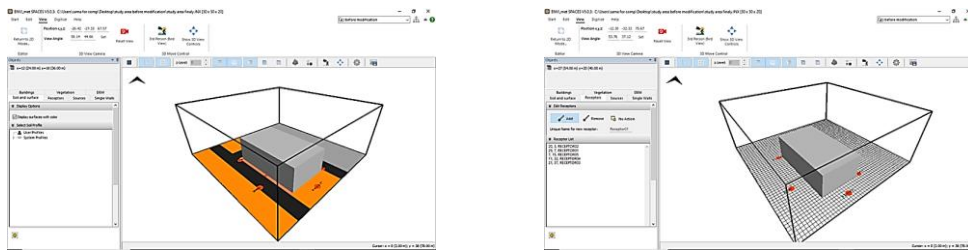

Figure 2. Designing Model by ENVI-met 5.0.3

The date of the hottest day in Iraq, which is July 30th, 2015 in which Baghdad experienced the warmest weather ever and recorded 123.8 degrees Fahrenheit equal to 50 degrees centigrade at 03:00 pm, should be determined to produce correct results in the simulation [Washington post journal].

3. RESULTS AND DISCUSSION

3.1. Results Before Modifying The Model

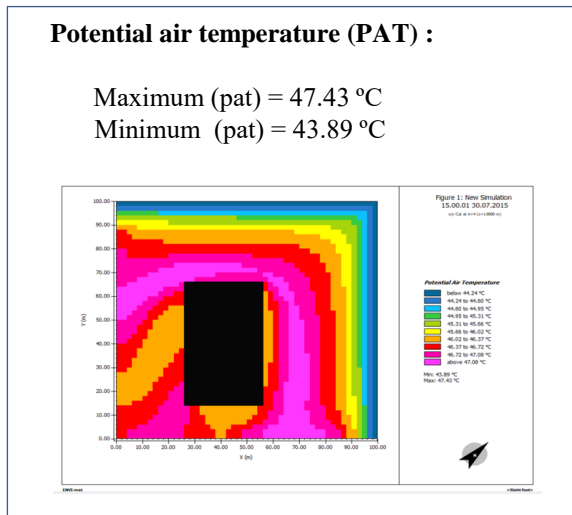

Figure 3: Results for PAT

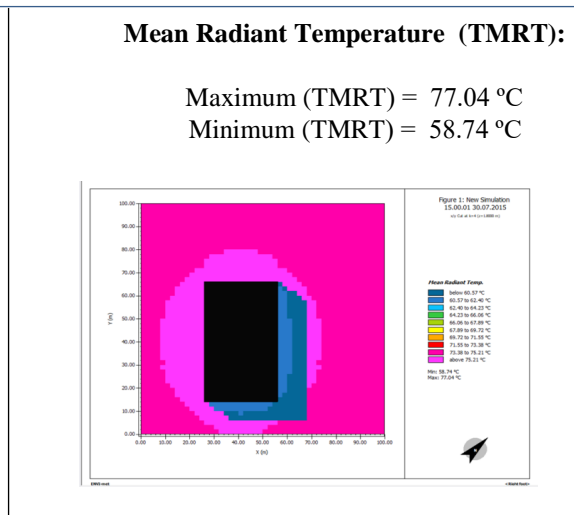

Figure 4: Results for TMRT

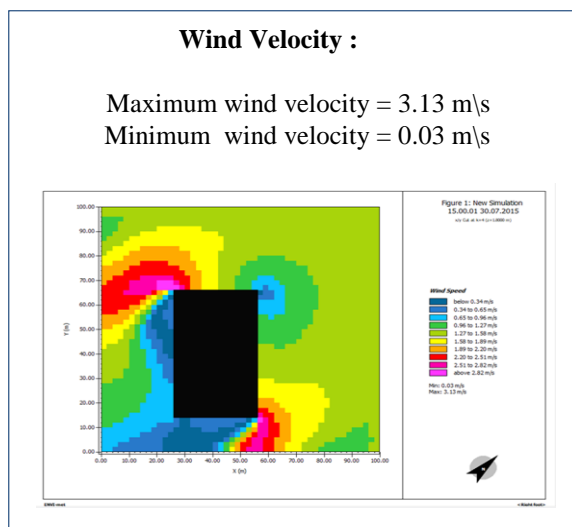

Figure 5: Results for wind velocity

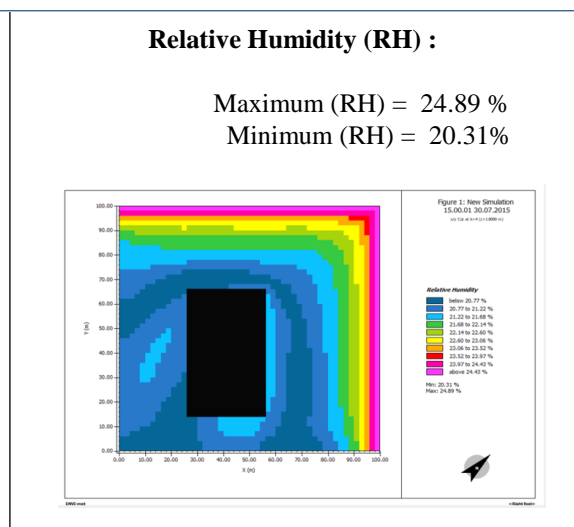

Figure 6: Results for relative Humidity

3.2. Modification of The Model

Achieving thermal comfort for the structure by lowering the mean radiant temperature (TMRT), potential air temperature, and relative humidity levels will occur in numerous ways:

1. Planting thickly trees that provide lots of shade; one of these trees that has recently expanded in Iraq is the Melia Azedarach tree; it costs between five and six dollars, depending on its size. It is planted for adornment and shade because it tolerates dryness, is perennial, densely shaded, and appealing (Figure 7).

2. Using thermal insulators Thermal insulators prevent heat transfer through walls, ceilings, and floors in a structure. The materials and forms of insulators are diverse, and they are often combined into rolls. The ability of a material to resist heat flow determines its thermal insulating capability. The researcher utilized a The best choice is to use (Isogam) which is made in the form of rolls (aluminum rolls with bituminous felt inside) with a width of 1 m * 10 m in length and 4 mm thick, consisting of aluminum and tar as shown in the Figure 8.

3. Asphalt pavements absorb and retain more heat than rough surfaces. As a result, typical asphalt pavements emit high temperatures into the atmosphere, contributing to the urban heat island (UHI) phenomenon. To reduce the impact of UHI, different cool asphalt solutions, including as the delivery of chemicals and substances, protective coatings, and multilayer design, have been used, Figure 9.

4. Using of the decorative brick road (red stones) in the interior roads of the building instead of the concrete roads which absorb the sunlight less than the concrete as shown in Figure 10.



Figure 7: Melia Azedarach (Orwa et al.2009)



Figure 8: Isogam single aluminum layer (William C. Turner, 2011)

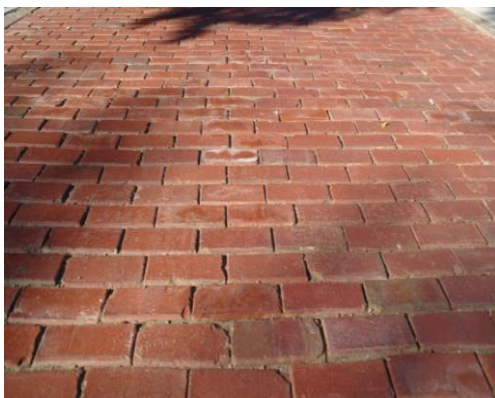

Figure 9: Red stone (brick road) (Wienerberger, 2009)



Figure 10: Red Coated Asphalt (P.E. Phelan et al., 2017)

3.3. Results for Model After Modification :

Mentioned modifications were applied to the model to develop the thermal comfort. The model after modifications is presented in Figure 11.

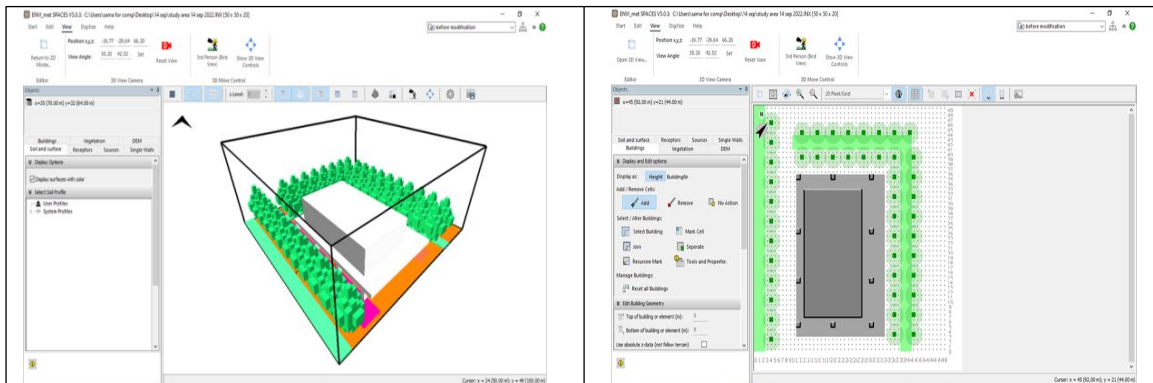

Figure 11: Model after modification

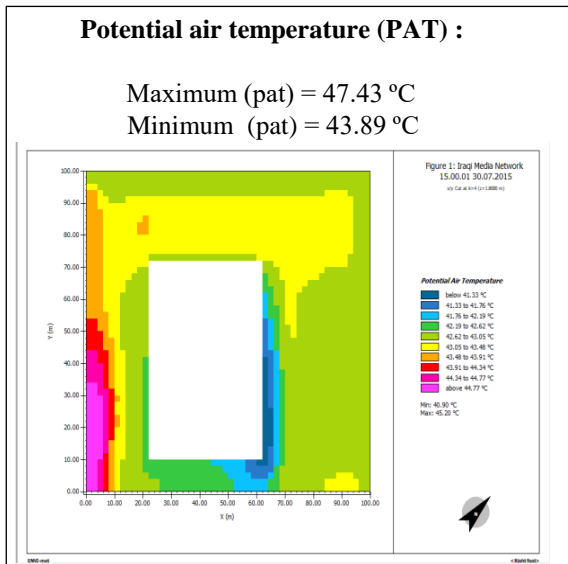

Figure 12: PAT

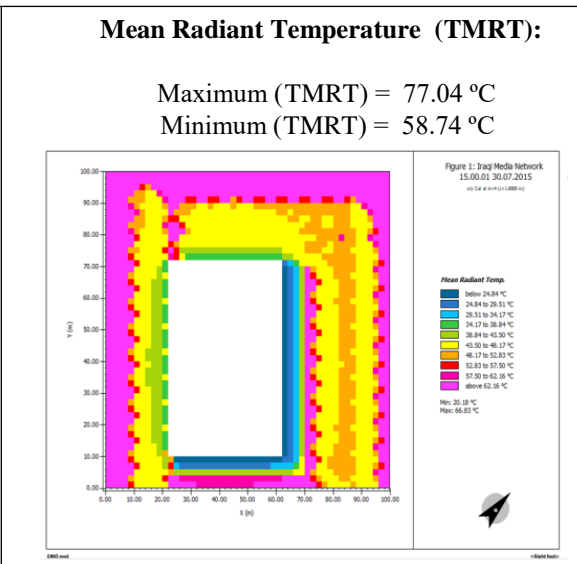

Figure 13: TMRT

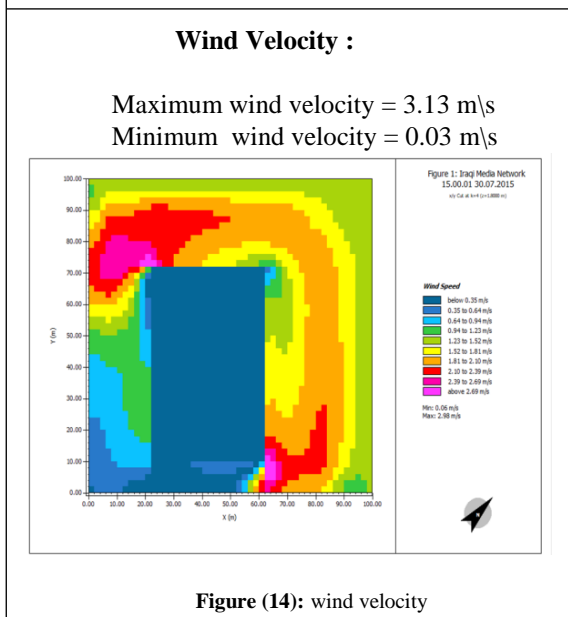

Figure 14): wind velocity

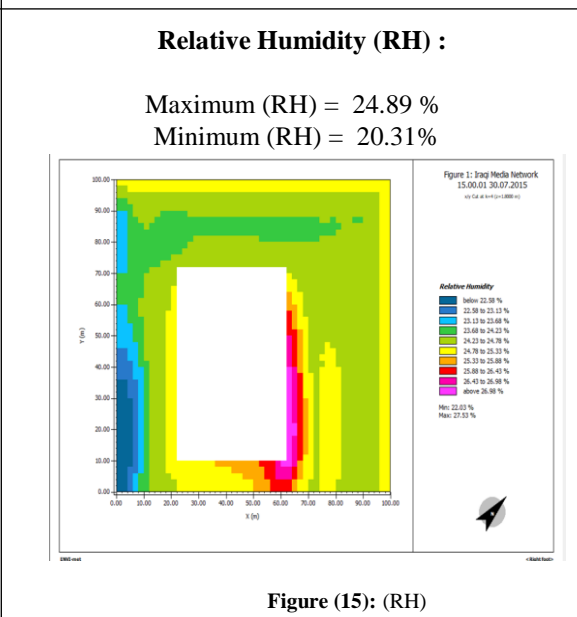

Figure 15): (RH)

4. CONCLUSION

Simulation results of this research show that:

1. The investigation revealed that the academic program ignored a number of the concepts and principles of sustainability, in addition to failing to examine sustainability-related technology, such as modeling methods and programming that aids in the sustainable design processes.
2. According to the findings, the vendors of customers are disinterested in implementing sustainability ideas and values into the layout of the building projects. Our civilization clearly lacks environmentally knowledge, and we face a number of issues and obstacles, some of being commercial in character.
3. Additionally, there is a societal barrier to prioritizing the power source concerns while looking for an idea.
4. The absence of vegetation cover in the research's location resulted in a warm and hot environment with a low level of relative moisture, which affects the warmth of the building's people inhabitants.
5. The lack of shading in the research region resulted in a rise in the surface of the ground region, that reflected sunlight and affects people going through the structure.
6. The conventional materials utilized for the research region's walls, roofs, and exterior building surfaces collected a large quantity of heat throughout the day and retained it until night.
7. The pavement utilized in the research area's major road (black asphalt) collected heat and reflected sunlight, resulting in massive volumes of (TMRT) and (PAT) impairing thermal comfort.
8. The research area's inner roadways have been coated with cement, which collects solar radiation and produces large levels of (TMRT) and (PAT), decreasing thermal comfort.

5. RECOMMENDATIONS

To get better results in developing thermal comfort the researcher recommended that :

1. The importance of modelling energy efficiency prior to the development process with simulated programs and pathways allows for assessment of the ecological design parameters used in the scope of work.
2. In terms of thermal efficiency, it is preferable to build residences and compact buildings along the east-west axis, since this circumstance boosts the amount of the walls facing north and south, enabling sunlight to penetrate when warming is necessary.
3. Developing thick vegetation surrounding this structure to provide shading and thermal comfort to its occupants. It is preferable to plant dense, persistent trees with plenty of leaves.
4. Sun curtains ought to be made from substances that are unable to retain or store warmth, such as hardwoods, and ought to have layouts so that they do not obscure the sun. The primary function of air movement is to reduce ambient temperature.
5. High-density cement should not be used in the construction of sun blinds or the inner roadways encircling the structure. Given its ability to hold heat throughout daytime and dissipate it at nighttime whenever the ambient temperature decreases than the outside temperature, this form of pavement is termed a heat lake, which impacts the warmth of the residence's inhabitants.
6. Avoid employing asphalt in the inner roadways surround the construction, as well as in pedestrian paths, because it has the ability to take in and reflect temperatures which has a negative impact on thermal comfort.

Acknowledgements

This research is a part of the master's thesis prepared by the researcher at Istanbul Gedik University.

Funding

There are no financial interests in this study.

Declaration of Competing Interest

There is no conflict of interest in this study.

References

1. Adriano Magliocco, Katia Perini, (2004). Urban environment and vegetation: comfort and urban heat island mitigation.
2. Ali-Toudert F, (2005). Thermal Comfort in an East-West Oriented Street Canyon in Freiburg (Germany) Under Hot Summer Conditions, Theoretical and Applied Climatology.
3. Baetz, B.W.; Korol, R.M., (2008). Integrating Sustainable Development Concepts into an Engineering and Society Programme”, Technology and Society, 1991. ISTAS apos; 91: apos; Preparing for a Sustainable Societyapos; Post Conference Edition. Proceedings of the 1991 International Symposium on.
4. Cenedese, a. & Monti, P., (2003). Interaction between an Inland Urban Heat Island and a Sea-Breeze Flow: A Laboratory Study. Journal of Applied Meteorology, 42(11), pp.1569–1583.
5. Dardel S., (2015). Climate Smart Fortaleza. Thesis for a diploma in Environmental Engineering, Department of Engineering, Faculty of Engineering, Lund University .
6. David V. J. Bell (2016) . Introduction To Sustainable Development.
7. Dhirgham Alobaydi., Mohammed Bakarman.,(2016). The Impact of Urban Form Configuration on the Urban Heat Island: The Case Study of Baghdad, Iraq.
8. Dorer V., Allegrini J., Orehounig K., Moonen P., Upadhyay G., Kämpf J., and Carmeliet J., (2013). Modelling the Urban Microclimate Impact on the Energy Demand of Building and Building Clustres. 13th Conference of International Building Performance Simulation Association, Chambéry, France .
9. Dorer V., Allegrini J., Orehounig K., Moonen P., Upadhyay G., Kämpf J., and Enno Koehan, Devang Patel, Santosh Khonde (2009). Introduction of sustainability to civil and construction engineering students, Lamar University, AC 2009-591.
10. Ethan, Jocie, Kim and Fred ., (2011). Roof Designs: Terms, Types, and Pictures.
11. Fahmy M., and Sharples S., (2009). On the Development of an Urban Passive Thermal Comfort System in Cairo, Egypt, Building and Environment.
12. Fanger, P.,(1988). Assessment of Man’s Thermal Comfort in Practice, British Journal of Industrial Medicine 30.
13. Federico M. Butera (2014) . Sustainable Building Design For Tropical Climates Principles and Applications for Eastern Africa .
14. Federico M. Butera, (2014). Nature of vegetation and building morphology characteristics across a city: Influence on shadow patterns and mean radiant temperatures .
15. George Reeves et al ., (2001). ASHRAE handbook.
16. Gwo-Jen Hwang., Hui-Chun Chu., (2011). A concept map approach to developing collaborative Mindtools for context - aware ubiquitous learning.
17. Herbert J., Johnson G., (1998). Arnfield A, Modeling the Thermal Climate in City Canyons. Environmental Modelling and Software 13 .
18. Jianxiang, (2014). Heat transfer in heterogeneous nanostructures can be described by a simple chain model.
19. Johnsson G. and Hunter L., (1995). A numerical Study of Dispersion of Passive Scalars in City Canyons: Boundary-Layer Meteorology 75 .
20. Krystyna Strumio., (2021) . Sustainable City- Green Walls and Roofs as Ecological Solution.
21. Lea & Febiger; ., (1974) .Textbook of environmental physiology. Philadelphia.
22. Lindberg et al., (2014). Role of Built Environment on Factors Affecting Outdoor Thermal Comfort - A Case of T. Nagar, Chennai, India .
23. M Nikolopoulou., M Bruse., (2004). Urban Green Space in Europe.
24. Maysoon.M.et al., (2014). Architecture and sustainability Investigate the relevance of sustainable design solutions in decreasing environmental impacts on the built environment, Al-Azhar Engineering Thirteenth International Conference December 23-25, 2014
25. Mohammad Taleghani, (2011) Sustainability in architectural education: A comparison of Iran and Australia.
26. Nichol J.(1996). High-Resolution Surface Temperature Patterns Related to Urban .
27. Omar H. Kharofa (2018). Methods and means of applying sustainable engineering in buildings\ Muthanna Journal of Engineering and Technology.
28. Panariti A., T., Maliqari A., Tashi P.,(2014). The Impact of Urban Texture in Outdoor Thermal Comfort, International Journal of Science and Research.
29. Prutha Platelet et al., (2009). Use of sustainable green materials in construction of green buildings for sustainable development.

30. Qudama Al-Yasiri., (2021). A short review on passive strategies applied to minimise the building cooling loads in hot locations.
31. Rachel Emas (2015). The Concept of Sustainable Development: Definition and Defining Principles, Florida International University.
32. Saleh, S.A., Ahmed, H.K., et al., (2013). Waterproofing Blog - Iraqi Building Code M. B. A. 501 First Edit., Baghdad, Iraq: Ministry of Planning, Central Organization for Standardization and Quality Control.
33. Setaih. K et al., (2013). Assessment of Outdoor Thermal Comfort in Urban Microclimate in Hot Arid Areas. 13th Conference of International Building Performance Simulation Association, Chambéry, France.



Exploring Organizational Perspectives on Sustainable Development: A Comparative Study of Companies in Dubai and Istanbul

Basheer Bambouk^a, Tuğbay Burçin Gümüş^b, Gözde Ulutagay^c

^a *Engineering Management Programme, Istanbul Gedik University, Istanbul, Turkey. bamboukbasheer@gmail.com*

^b *Department of Industrial Engineering, Istanbul Gedik University, Istanbul, Turkey. burcin.gumus@gedik.edu.tr*

^c *Department of Statistics, Ege University, Izmir, Turkey. gozde.ulutagay@ege.edu.tr*

Abstract

This research presents the findings of a study on the perceptions of sustainable development among companies in Dubai and Istanbul. It starts by providing an overview of the definitions, objectives, benefits, and requirements of sustainability, also highlighting some examples of best practices in this area. Then presents the results of a questionnaire survey that has been conducted to gather the views of companies on sustainable development and compare them. The main point of this research is to acknowledge the perspectives of companies in Dubai and Istanbul on sustainable development. This study aims to identify the sustainable development challenges that companies are currently facing and may face in the future, from an organizational perspective. It also aims to examine how companies can address these challenges in a way that benefits both their own operations and the larger society by contributing to sustainable development. The focus of the research is on understanding how companies can address these challenges from within their own organizational structures and practices. The survey results reveal similarities and differences in sustainability practices between Istanbul and Dubai. Istanbul-based companies prioritize customer-focused sustainability, while Dubai-based companies excel in sustainable operations. Istanbul ranked first in ethics and safety, while Dubai focused more on environmental impact. Both cities prioritize a safe work environment, but Istanbul focuses on employee engagement, while Dubai prioritizes energy efficiency and ethical sourcing. Common barriers include a lack of awareness, difficulty finding sustainable suppliers, and regulatory restrictions. Dubai companies perceive the higher implementation of sustainable strategies and measurable results. Regular evaluation, sharing of best practices, and alignment of sustainability priorities can drive improvements. Companies need to consider their unique context and challenges to effectively integrate sustainability into their business strategies, and overcome barriers. Collaboration, education, and stakeholder engagement are crucial for fostering a more sustainable future in both Istanbul and Dubai.

1. INTRODUCTION

Sustainable development is a vital concept in the realm of business, involving a responsible approach to meeting present requirements while safeguarding the preservation of the capacity for future generations to fulfill their own needs. For companies, incorporating sustainable development entails taking into account the social, environmental, and economic ramifications of their operations across the entire lifespan of their products. By striving to achieve these objectives, companies can not only contribute to sustainability but also improve their competitiveness [1]. In the business world, this means balancing economic, social, and environmental concerns to create long-term value for stakeholders. As such, sustainable development has become a central focus for many organizations around the world.

There are many different drivers for sustainable development in organizations, including regulatory requirements, the increasing desire of consumers for products and services that prioritize social and environmental responsibility, and the desire to improve operational efficiency and reduce costs. Some companies have also embraced sustainable development as a way to improve their reputation and attract and retain employees [1]. Implementing sustainable development practices in an organization necessitates a comprehensive approach that considers the needs and perspectives of all stakeholders. It also requires the development of clear goals and targets, as well as the implementation of strategies and systems to track progress and continuously improve performance [1].

2. LITERATURE REVIEW

2.1 Sustainable Development Background

One widely accepted definition of sustainable development is “meeting the needs of the present without compromising the ability of future generations to develop” [1]. This idea gained significant recognition during the 1992 United Nations Conference on Environment and Development held in Rio de Janeiro, but its origins go back further in history.

The concept of sustainable development is often linked to the "triple bottom line" of economic, social, and environmental performance. It involves maximizing the benefits and minimizing the negative impacts of economic activities on people and the planet. This includes efforts to reduce pollution, minimize waste and resource consumption, and protect natural ecosystems [2].

Sustainable development also involves addressing social issues such as poverty, inequality, and access to education, healthcare, and other basic needs. It requires a long-term perspective and an understanding that economic, social, and environmental goals are interconnected and must be addressed in a holistic way [3].

2.2 Objectives of Sustainable Development

Sustainable management of the planet's natural resources requires addressing two key concepts. Firstly, meeting basic human needs like food, shelter, and work is important, particularly for those who are currently unable to meet these needs, such as the world's poor. Ignoring these needs can lead to ecological disasters and perpetuate poverty. Furthermore, the constraints on development are yet to be fixed but rather depend on technological and social structures, their effects on the environment, and the Earth's ability to absorb the impacts of human activity [1].

The sustainable development concept aims to create a society that fairly distributes natural resources, willingly accepts ecological constraints, and strives for economic efficiency [1]. Essentially, this approach to development seeks to achieve social goals while also respecting the environment and being economically feasible. As shown in Table 1. These three objectives form the structural pillars of sustainable development.

Table 1. The three pillars of sustainable development

Sustainable Development		
Economy	Environment	Social
Profit & Economic Growth	Resource Conservation	Basic Human Needs
Cost Savings	Pollution Prevention	Equity and Education
Market Expansion	Carrying Capacity	Community Participation

From an economic perspective according to United Nations (1992), another goal of sustainable development is cost savings, which can also be viewed as a benefit in terms of conserving energy and reducing waste. from an environmental standpoint [4]. In order to meet basic needs and promote human development, economic growth is necessary for certain areas. However, this growth must be less destructive to the environment and should involve a shift in existing patterns of consumption and production to yield substantial advantages [5].

Community participation is essential for achieving well-being and sustainable progress at the community or regional level. It offers numerous advantages of community participation extending to individuals, communities, organizations, and society at large. For example, it can help to more effectively and efficiently target resources and can also help to build skills and competencies within communities. Additionally, it can serve as a way to extend the democratic process, open up governance, and address inequalities in power [6].

Education is also a crucial element in the pursuit of equitable and sustainable relationships and global order. Education for sustainable development seeks to equip individuals with the necessary knowledge, and attitudes needed to make well-informed choices that benefit themselves and others, in the present as well as in the future, and to proactively act upon these decisions [7].

2.3 Business Benefits of Implementing Sustainable Development

An organization's sustainable strategy, based on integrity, strong values, and a long-term perspective, can provide significant business benefits and make an optimistic influence to culture. Corporations that adopt an advanced sustainable method can reap a number of advantages including: Improved brand value and status, customer acquisition, differentiation, Lower operating costs and increased revenue, risk management improvement, talent retention and attraction and discovering new opportunities [8].

Adopting sustainable development principles within a company can bring numerous advantages, including an improved reputation and brand value, increased customer attraction and retention, a competitive edge over other firms, lower operating costs and increased revenues, better management of risk, and the identification of new opportunities. These benefits not only benefit the company itself but also contribute to a confident insight into the business within society and between customers. Implementing sustainable development strategies within the company can therefore be beneficial for the lasting achievement of the enterprise [9].

2.4 Sustainable Performance Measurement

The world is perceived as a holistic global system in which all components are interrelated. The term "sustainable development" refers to a process that takes into account the impact of economic, ecological, and social factors on a system over time [1].

To measure the progress toward sustainable development, it is essential to consider several aspects of a company's environmental performance. This includes using metrics that address sustainability issues in a comprehensive manner. Measuring the success of sustainability initiatives allows decision-makers to assess the benefits and drawbacks of current processes. To do this effectively, it may be required to develop novel methods for tracking performance, conducting financial assessments, and managing costs [10].

2.5 Requirements for Achieving Sustainable Development

Companies can be expected to meet certain requirements in terms of economy, ecology, and society. The economic requirement refers to a company operating in a financially viable way. The ecological requirement involves integrating environmental goals and actions into the company's strategy and implementing environmentally friendly practices. The social requirement involves considering the interests of stakeholders and implementing strategies for managing these stakeholders [11].

To build a sustainable enterprise, it is important to consider several key elements related to the environment and economy, including reducing waste and emissions, minimize energy usage in the production of goods and services, using sustainable and renewable energy sources, the incorporation of recycled components and materials into products and processes to the greatest extent possible, evaluation of the environmental impact of business operations and products, measures and standards that can be used to assess sustainability performance, and the entire organization must have a culture that is deeply aware of and concerned about the environment [12] [13].

2.6 Sustainable Practices

Implementing the requirements discussed in the previous section can help companies not only develop sustainability but also increase their effectiveness. It is known as a sustainable competitive benefit. Product manufacturing holds a crucial role in achieving this advantage, as it involves integrating environmental requirements throughout the entire lifecycle of a product [14]. Sustainable manufacturing involves developing technologies that allow for the transformation of materials without the usage of materials that are not renewable or toxic, releasing pollutants, or generating wastage. Consideration should be taken at all stages of the product lifecycle [15].

2.7 Sustainable Supply Chain Management

Supply chain management (SCM) contains the coordination of activities and information related to the movement and conversion of products from start to end, with the goal of achieving a sustainable competitive advantage. SCM integrates common business tasks and tactics among the organization and businesses in the supply chain to enhance the lasting performance of all involved parties [16].

A sustainable supply chain model integrates sustainability factors such as minimizing the production of CO₂, energy usage, and traffic congestion, alongside with common measures like availability, cost reduction, and financial performance. This model can lead to reduced handling and transportation costs per pallet, shorter delivery times, reduced carbon dioxide emissions, and enhanced availability of products at the point of purchase [17].

3. RESEARCH METHODOLOGY

The research project is a comparative study conducted in Dubai and Istanbul to evaluate companies' sustainability practices in the two cities. The study was conducted in two phases.

The first phase involved conducting a literature review to identify the relevant theories and concepts related to sustainability and its practices, to identify key concepts and theories related to sustainability practices. This included reviewing academic and industry journals, reports, and books on the topic. The second phase involved collecting primary data from companies in Dubai and Istanbul using a questionnaire survey. The data were presented in two formats, the background information was conveyed using percentages, detailing the company size, current function, and title. The sustainability-related data obtained from questions rated on a 1 to 5 scale was presented by calculating the arithmetic mean of each question in the questionnaire.

4. RESULTS AND ANALYSIS

The study utilized a survey questionnaire to collect data from a sample of employees in each city, with 30 respondents from each city completing the survey. The survey was distributed to approximately 150 people in each city, resulting in a response rate of 20%. The questionnaire comprised 11 questions divided into two sections. The questions in Section A aimed to collect background information about the company, while the questions in Section-B aimed to collect data about sustainability-related issues.

The following tables provide a comprehensive overview of the data obtained from the survey and present the results as arithmetic means, allowing for a comparative analysis between the two cities.

Table 2. Implemented claims and issues in organization (1 – Not realized or implemented / 5 – Fully realized and implemented).

	Customer-focused sustainability	Sustainable operations	New business opportunities	Sustainable materials and packaging	Comprehensive sustainability
Dubai	3.40	3.36	3.34	3.46	3.50
Istanbul	3.70	3.16	3.50	3.46	3.16

Table 3. Practices of sustainability in organizations (1 – Not at all / 5 – Completely established).

	Ethics and safety	Employee engagement	Environmental impact	Sustainable partnerships	Sustainability integration
Dubai	3.46	3.43	3.50	3.46	3.36
Istanbul	4.34	3.56	3.16	3.50	3.43

Table 4. The importance of sustainability-related issues (1 – Not at all / 5 – Very important).

	A safe and healthy work environment for employees.	Energy efficiency and conservation	Waste reduction and recycling initiatives	Ethical sourcing and responsible supply chain management	Employee engagement and well-being	Development and marketing of sustainable products and services.	Sustainable transportation and logistics
Dubai	3.73	3.43	3.50	3.56	3.63	3.40	3.40
Istanbul	4.63	3.73	3.36	3.66	4.10	3.56	3.06

Table 5. Qualities for establishing sustainability in organizations (1 – Not at all / 5 – Very important).

	Value	Management support	Centrality	Alignment	Metrics	Engagement	Integration
Dubai	3.13	3.36	3.20	3.23	3.20	3.26	3.26
Istanbul	4.43	4.13	3.93	3.90	3.63	3.83	3.76

Table 6. Practiced sustainable qualities in organizations (1 – Not at all / 5 – Extremely)

	Value	Management support	Centrality	Alignment	Metrics	Engagement	Integration
Dubai	3.26	3.26	3.33	3.13	3.20	3.23	3.30
Istanbul	3.83	3.56	3.43	3.43	3.30	3.40	3.26

Table 7. Items to influence the business decisions in organizations (1 – Not at all / 5 – Very important).

	Ensuring worker health and safety.	Addressing regulatory restrictions	Providing products/services that are good for the world	Improving brand image with stakeholders/public	Ensuring proper employee treatment among suppliers
Dubai	3.70	3.63	3.50	3.60	3.46
Istanbul	4.66	4.13	4.16	4.30	4.10

	Improving employee morale/engagement	Securing needed energy resources	Reducing pollution/toxic chemical use	Enhancing customer satisfaction/loyalty through sustainability initiatives	Reducing/managing risks/impacts of climate change
Dubai	3.56	3.70	3.46	3.53	3.40
Istanbul	4.03	3.30	1.93	2.96	1.80

Table 8. Factors to obstruct moving toward sustainability in organizations (1 – Not at all/ 5 – Extremely).

	Lack of financial resources for sustainability initiatives	Difficulty in finding sustainable suppliers or materials	Regulatory barriers or restrictions	Lack of awareness or education about sustainability among employees or management
Dubai	2.86	2.93	2.86	2.93
Istanbul	2.96	3.50	3.00	4.13

	Lack of clear sustainability goals or strategies	Competing priorities or limited resources for sustainability initiatives	Limited access to technology or innovation for sustainable practices	Lack of metrics or standards to measure sustainability progress.
Dubai	2.90	2.70	2.86	2.90
Istanbul	3.36	3.00	2.95	3.00

Table 9. Sustainable performance of the organization (1 – Very low extent/ 5 – Very high extent).

	Is the company implementing a sustainable strategy?	Does the company provide and review information used to develop sustainability metrics?	Is the company seeing measurable results from its sustainability initiatives?
Dubai	3.33	3.30	3.23
Istanbul	2.90	2.66	2.30

5. CONCLUSION AND RECOMMENDATION

Based on the findings from the survey comparing sustainability practices between companies in Istanbul and Dubai, it is evident that there are differences in the implementation of sustainability claims and issues in these two cities, these differences suggest that benchmarking and sharing best practices can enhance sustainability efforts and aligning sustainability priorities and strategies can contribute to addressing global sustainability challenges; Companies in Istanbul and Dubai can learn from each other's strengths and best practices to further enhance their sustainability efforts and contribute to a more sustainable future.

These results highlight the importance of considering city-specific contexts and priorities when developing sustainability strategies for businesses in these regions. Therefore, aligning sustainability priorities and strategies in both cities can collectively contribute to addressing global sustainability challenges and fostering a more sustainable future.

It is crucial for companies to align their sustainability priorities and strategies, taking into consideration factors such as customer-focused sustainability, new business opportunities, sustainable operations, comprehensive sustainability, and sustainable materials and packaging. Additionally, addressing areas that need improvement, such as waste reduction and recycling initiatives, can contribute to a more sustainable future.

Furthermore, it is important for companies to invest in education and awareness programs for employees and management to overcome the barrier of lack of awareness or education about sustainability. Collaboration with stakeholders, including suppliers, regulators, and the public, can also help overcome challenges such as regulatory restrictions and limited access to technology or innovation. By considering these recommendations, companies in Istanbul and Dubai can contribute to sustainable business practices and help create a more sustainable future for their cities and beyond.

There are several suggestions for future work that can further enhance sustainability efforts and contribute to a more sustainable future including establishing a Sustainable Business Network to facilitate knowledge sharing, collaboration, and regular meetings between companies, and conducting in-depth case studies on companies with exemplary sustainability practices to identify success factors and challenges.

References

- [1] WCED 2002. Report of the World Commission on Environment and Development: Our Common Future, 16,49,54,270,276.
- [2] American Management Association 2007. Creating a Sustainable Future: A Global Study of Current Trends and Possibilities 2007-2017, 7.
- [3] D. H. Meadows, D. L. Meadows, J. Randers, W. W. Behrens III 1972. The Limits to Growth, 48.
- [4] United Nations Agenda 21 1992. Declaration of the 1992 Rio Conference on Environment and Development, 1-4.
- [5] T. Jackson, L. Michaelis 2003. Policies for Sustainable Consumption, Report to the Sustainable Development Commission, 75-81.
- [6] WHO Regional Office for Europe 2002. Community Participation in Local Health & Sustainable Development European sustainable development & health series, 15.
- [7] M. Pavlova 2009. Technology and Vocational Education for Sustainable Development: Empowering Individuals for the Future, 59.
- [8] M. Shahbazzpour, R. H. Seidel 2006. Using Sustainability for Competitive Advantage, 285-294.
- [9] United Nations 2001. Uncovering the business case for corporate sustainability, 10.
- [10] C. O'Brien 1999. Sustainable production – a new paradigm for a new millennium, 1-7.
- [11] B. Ransburg, M. Vagasi 2007. Concepts and standards for the corporate internalization of sustainable development, 45.
- [12] J. De Ron 1998. Sustainable production: The ultimate result of continuous improvement, 101-109.
- [13] J. W. Sutherland, J. L. Rivera, K. L. Brown, M. Law, M. J. Hutchins, T. L. Jenkins, and K. R. Haapala 2008. Challenges for the Manufacturing Enterprise to Achieve Sustainable Development, 13-16.
- [14] C. A. Rusinko 2007. Green Manufacturing: An Evaluation of Environmentally Sustainable Manufacturing Practices and Their Impact on Competitive Outcomes, 50.
- [15] E. Westkämper, L. Alting, G. Arndt 2000. Life Cycle Management and Assessment: Approaches and Visions towards Sustainable Manufacturing, 501-522.
- [16] S. Seuring, M. Müller 2008. From a literature review to a conceptual framework for sustainable supply chain management, 1700-1709.
- [17] Capgemini 2008. Future Supply Chain 2016: Serving Consumers in a Sustainable Way, 38-45.



IMPROVEMENT OF FOREST ROADS, CASE STUDY: THE ACCESS ROAD TO THE GOLIRAN COAL MINE IN MAZANDARAN PROVINCE, IRAN

Mahdi POURMOJARAB ^{a*}

^{a*} Civil Engineer, Master of Hydraulic Engineering, Manager at ÖTÜKEN Mühendislik, Danışmanlık, ...Ltd.Şti, Ankara, TURKIYE
m.pourmojarab@gmail.com (*Corresponding Author)

Abstract

Improvement of existing forest roads for easier access to mineral resources and operation is one of the national needs and a factor of economic and tourism development in the forest areas on the southern Coast of the Khazar Lake and in the Highlands of the northern provinces of Iran. Forest resource management can only be sustainable through a well-organized road network designed with optimal spatial planning and minimum environmental impacts. Improving the quality of forest roads leads to reducing mining and transport costs, and improving the livelihoods of the local people. However, unscrupulous construction and improper maintenance could have adverse and irreparable effects. Environmental destruction should be minimized in the design and construction of forest roads and engineering principles should not be neglected in this regard. In the long run, Improved Road construction will have positive environmental impacts because road damage due to Erosion and Drift brings environmental damage in addition to economic and social injuries. One of the main factors in the stability and durability of roads is extensive drainage and stabilization of the road shell in inaccessible forest and mountain areas. This article examines environmental and engineering problems, sustainability, and impacts of drainage and stability in the construction and improvement of forest roads based on the access road to the Goliran coal mine in the highlands of Babol county in Mazandaran province, Iran.

Keywords: Forest road network, Environmental impact, Natural resources, Drainage, Stability, Construction.

1. INTRODUCTION

The opening up of mountain forest resources requires integrated planning to balance industrial demand and environmental protection. This becomes more crucial with the use of modern machines for road building, forest harvesting, and the growing need for Coal. Besides these main goals, land ownership and local people's rights and needs must also be respected in terms of fuelwood and fodder supply, water source, scenery, wildlife, etc. These aspects may affect the interests of a village, district, county, or country. For all these purposes, whether they are productive or protective, a well-planned forest road net is the key to performing the necessary work and sustaining the forests as a renewable resource. The design of a road net depends on various factors, such as the resources, terrain conditions, type of forest operations (afforestation, silvicultural treatment, fire protection, logging, and transport methods), technical equipment and machines, labor techniques, and costs, as well as other resource benefits to be considered. Special care has to be taken, when planning and locating roads in steep terrain, to prevent and reduce the erosional impact of roads on the environment.

Within a forest road net one can classify roads:

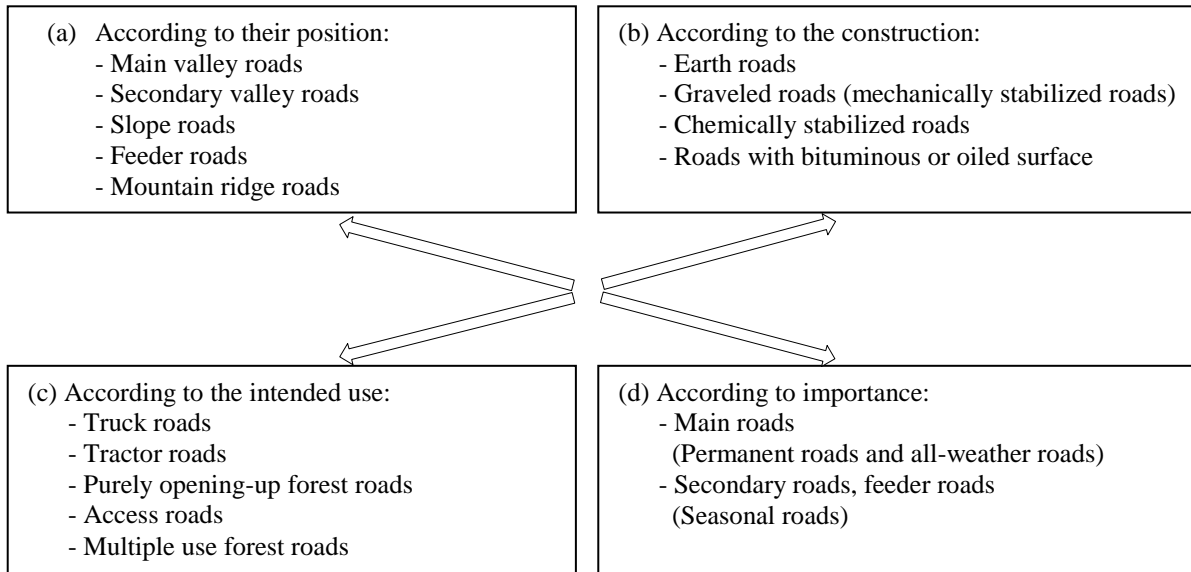

Nowadays, with the advancement of machinery and facilities the increase in production in the coal mine and the importance of the mine located at the end of the route for economic and social reasons in the region, as well as the need to increase transportation efficiency and reduce production and transportation costs, upgrading existing roads and proper maintenance over the period of operation is essential and inevitable. In this case, the improvement of the Goliran coal mine road is important because the Government wants to improve this road to multiple-use all-weather road status. Of course, it's worse nothing that this road was expanded and sandblasted in the mid-80s and turned into a vehicle road. Based on the researcher's observations of the road conditions, geographical location, and climate of the region, the greatest threat to the road is the instability of embankments and bed slopes, Heavy rainfall, and improper drainage along the entire length of the road. For this reason, hydrological studies are so important also we need to stabilize the slopes properly.

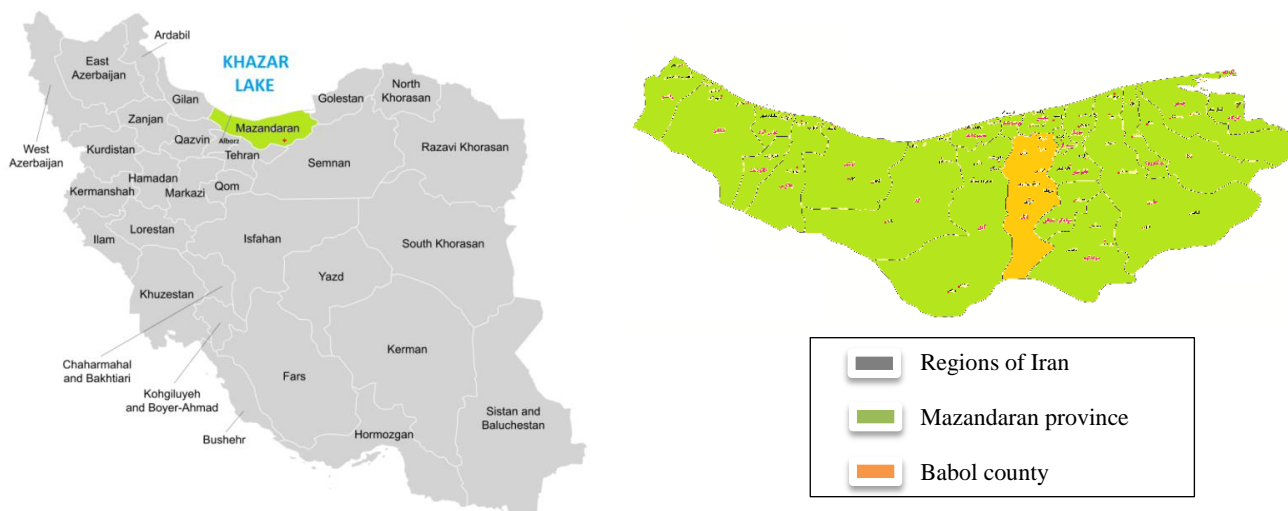

Figure 1. Location of the study area



Figure 2. Road path

1.1 Hydrological Studies

The study area is located on the northern margin of the Alborz Mountain range and south of the Khazar Lake in Mazandaran province. The area has a remarkable altitude diversity ranging from 700 meters at the beginning of the route to about 2300 meters above sea level.

This area is generally affected by the mid-latitude weather systems prevailing over Iran's plateau. The most important air masses that directly affect the region are as follows:

- Polar maritime air masses (MP) originating from the Mediterranean Sea, the Black Sea, and the southern Atlantic Ocean from the north and northwest, and tropical maritime air masses (MT) originating from the Indian Ocean and the Red Sea from the south and southwest can sometimes intensify rainfall in the region as a moisture feeding agent.
- Polar continental air masses (CP) from early December to early March alternately perform in the region from the northeast with Siberia as their source and also from the northwest that originates from Europe. The temperature accompanying this air is very low and mostly below zero.
- Continental tropical air masses (CT) also usually form in the region in summer. These masses mainly cause local winds and dust.
- Continental frozen air masses (CA), which are very cold and dry and rarely move towards Iran in winter from Siberia or northern Europe, affect northern, western, and even central Iran.

Estimating runoff is one of the most important components of hydrological studies. In this regard, selecting the design rainfall, which is usually done using intensity-duration-frequency (IDF) curves and for rainfall with a known duration and frequency, is the most fundamental step in estimating runoff. The design rainfall, which is the generator of the design runoff, is defined and determined through specifications such as total height, total duration, spatial distribution, and ultimately temporal distribution of rainfall.

Rainfall statistics, especially maximum daily rainfall, and short-term rainfall are extremely important in hydrological studies and designing systems for collecting and disposing of runoff. Especially since regular and systematic statistics of surface waters are not available and many of the studied basins lack hydrometric stations, estimating their runoff requires the use of rainfall statistics. Completion rainfalls should be extracted from synoptic charts of the country's meteorological organization or stable rain gauges of the Ministry of Energy and after verification, correction, and completion should be prepared in time series for subsequent analysis. Maximum daily rainfall statistics, including maximum Daily rainfall each year, are directly applicable in many hydrological studies.

1.1.1 Precipitation Plan

Flood estimation is one of the most important components of hydrological studies. In this regard, selecting the design rainfall, which is usually done by using intensity-duration-frequency (IDF) curves for rainfall with a known duration and frequency, is the most fundamental step in flood estimation. The design rainfall that generates flood is defined and specified by characteristics such as total height, total duration, spatial distribution, and ultimately temporal distribution of rainfall.

Rainfall statistics, especially maximum daily rainfall, and short-term rainfall are of great importance in flood studies and the design of flood collection and disposal systems, especially since regular and systematic statistics of surface runoff are not available in our country and many of the studied basins lack hydrological stations. Therefore, estimating their floods requires the use of rainfall statistics. Short-term rainfalls should be extracted from synoptic charts of the country's meteorological organization and stable rain gauges of the Ministry of Energy. After verification, correction, and completion, they should be prepared in time series for subsequent analyses. Maximum daily rainfall statistics, which include maximum daily rainfall during each year, are directly applicable in many flood studies and therefore their collection and completion are necessary for subsequent analyses. As expected, rainfall in the forest at different kilometers along the route varied with the data from the stations, but the average rainfall on the road was close to the average rainfall of the Shirgah station.

Table 1. Average monthly and annual rainfall in the study area stations (mm)

Station	Jan	Feb	Mar	Apr	May	June	July	Aug	Sep	Oct	Nov	Dec	Total annually
Goran-talar	77.8	84.9	93.4	70.6	75.9	57.6	73.5	72.4	111.1	133.3	97.3	102.9	1050.7
Babol-Slaughterhouse	66.6	65.1	62.2	40.9	31.1	22.1	28	28.2	58.7	85.5	97.3	93.5	679.3
Qarakhil	66.6	67.6	70.6	51.4	37.8	34.9	34.1	37	75.5	88.2	93.9	84.6	742
Kiakola	68.5	72.1	66.3	46.9	28.8	21.6	27.2	31.1	63.1	91.4	100	95.5	712.5
Galugah	77.4	88.8	95.7	76.1	78.7	63	70.4	69.7	118.5	147.4	97.7	92.9	1076.3
Shirgah	81.4	85.9	91.5	88.9	76.7	55.9	78.9	76.8	111.4	123.5	106.7	93.9	1071.5
Pol sefid	59.5	54	58.5	48.2	52.2	36.6	37.1	38.9	48.4	52.5	54	58.5	598.3

Table 2. The temperature of the Firouzjah evaporation station (Celsius)

Year	Jan	Feb	Mar	Apr	May	June	July	Aug	Sep	Oct	Nov	Dec	Total annually
Average	3.7	3.3	6.1	9.3	12.8	16.9	18.1	20.1	17.6	14.7	9.9	5.9	11.5
Min. Average	-1.15	-1.6	0.34	3.5	7.9	12.3	14.3	15.5	13.5	9.85	5	0.77	6.7
Max. Average	10.1	9.6	12.1	15.7	19.4	22.9	23.5	25.7	22.99	20.2	15.2	11.4	17.4

1.1.2 Climate Classification

The climate zoning of Iran based on the De-Martonne index is shown in Figure 3, which shows that there are six main climatic types in Iran. Most of Iran is made up of a dry climate and then a semi-dry climate. As we move from south to north of the country, the area of dry climate decreases, and the area of humid climates increases. The Alborz Mountain range separates two contrasting climates, separating the lowlands of the Caspian Sea from the central plateau and western mountain ranges, such as dams that prevent Mediterranean moisture from entering the Iranian plateau and trap humidity in their foothills. In the central plateau of Iran where dry climate dominates, due to lack of moisture and absence of clouds in the sky, the range of temperature changes is very high in these areas, which is why we see cold and harsh winters and hot and dry summers. The area of other climates has been much less than that of dry climates and for this reason, Iran is generally referred to as a dry country (Masoodian 2003). But as we see in Figure 3 Climate data comes from station and field observations Climatic type of the Project zone is Very Humid.

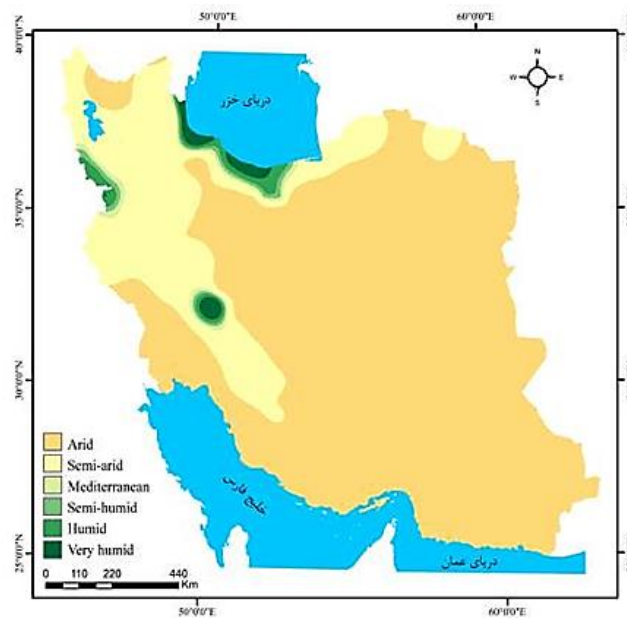

Figure 3. Climate classification map of Iran based on the De-Martone index (1995-2019)

1.2 Geological Studies

This mine is located approximately 35 kilometers south of Babol and 500 meters south of the village of Firouzjah. To get to this mine, you need to head south and after traveling about 27 kilometers and passing through many twists and turns, you will reach the area of the Goliran coal mine. According to the 1:100,000 geological map of Qaemshahr, the route under study is located on the upper sedimentary part of the Shemshak Formation. Based on studies conducted, these sediments are mostly composed of siltstone, sandstone, mudstone, and conglomerate.

The Alborz Mountains have been subject to historical earthquakes for many years, destroying many cities and villages. According to Chalenko, in modern times (such as Pliocene and Quaternary), the Iranian block has moved westward and the southern Khazar block has moved eastward. On the other hand, the Iran and Afghanistan plates can be described as two floating or semi-floating ice floes that have formed a small continent by joining together.

By referring to the reason for the emergence of the southern Khazar Lake, we must pay attention to the issue of the existence of tensile phases. The southern Caspian region has been formed in a tensile field over the past 5 million years with prominent evidence of the effects of this tension, which has resulted in severe subsidence in this basin, especially in the central part of the southern Caspian. If we move from the shores of the Caspian Sea towards the Alborz Mountains, we will face large tectonic structures that provide a suitable location for large earthquake centers.

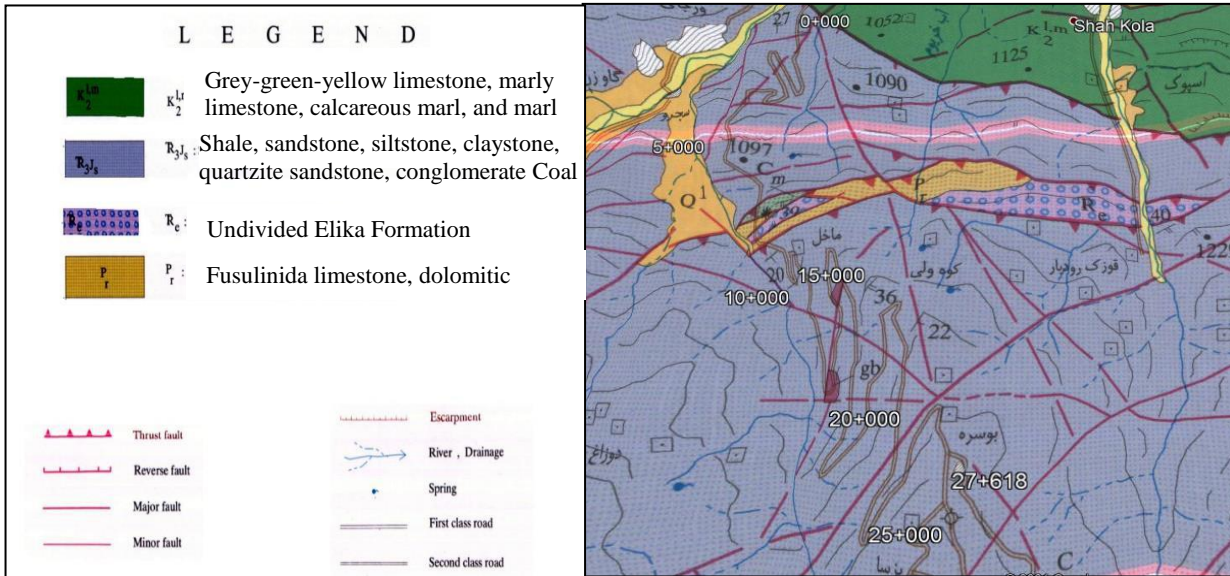

Figure 4. Road route Geological map

Given the important faults of the region the statistics of continuous earthquakes and geological maps that show the faults of Iran and the region, it seems that the studied area is in relatively active areas in terms of earthquake activity. Although the earthquake potential of the region is high, especially in mountainous areas, it decreases as we move away from mountainous areas and approach floodplains. At the same time, according to the earthquake hazard map of Iran prepared by the International Institute of Earthquake Engineering and Seismology in 1999, the studied route is in an area with high earthquake hazard and acceleration of about 0.3 g. Given the earthquakes that have occurred in the region, an acceleration of 0,3g is not far-fetched.

2. METHODOLOGY

Based on Hydrological and Geological data, the importance of drainage and stabilization of alluvial fans is evident. In the following, methods of drainage and stabilization of alluvial fans will be discussed.

2.1 Study Area

In this study, a forest road within the Hyrcanian forests in the Firouzjah region was chosen as the research area. The starting point of the road route is 700 m high from the sea, and the road ended at a height of 2300 m. The total length of the road is 27+618 km, and at the same time, the longitudinal slope of the road route varies between 2% -10%.

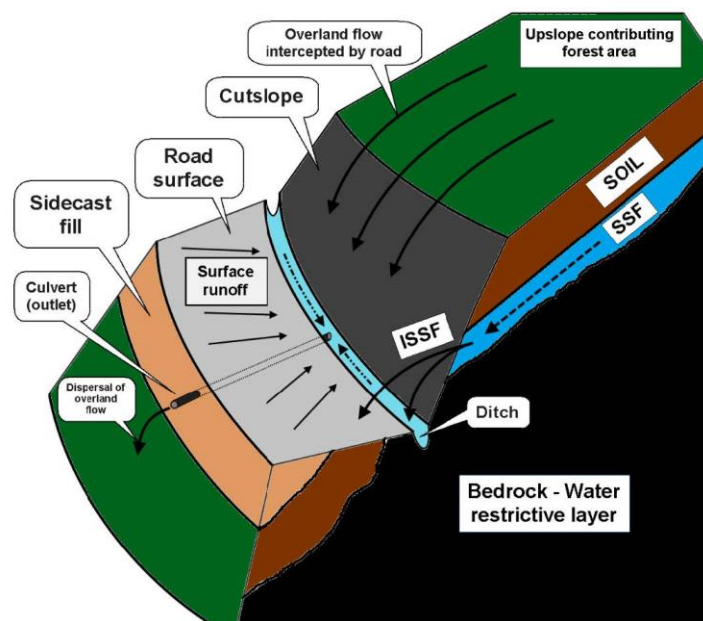

Figure 5. Schematic representation of forest road cut slope, depicting the overland flow, subsurface flow (SSF), and intercepted subsurface flow (ISSF).

2.2 Forest Roads Impact

It is widely accepted that forest roads are highly compacted and present very low infiltration rates, in most cases less than 5.0 mm/h. These low infiltration rates trigger the generation of Horton infiltration-excess overland flow, even during moderate or small rainfall events. Only a few millimeters of precipitation, ranging between 3 and 6 mm, could generate infiltration-excess overland flow. Derived from forest road surfaces, the forest road runoff rates are considerably greater than the runoff from undisturbed hill slopes. Well-constructed roads are safe, minimize environmental impacts, and are cost-effective to build. Implicitly, a major component to meet these objectives is constructing a stable road. Stabilized cuts and fills are therefore an essential part of a well-constructed road. This includes the ongoing stability of cut batter slopes, constructed fill slopes, and slopes adjacent to waterways, river margins, culverts, and bridge abutments. All components of the road need to be stable – the cut banks, ditches, road carriageway, berms, and fill slope. A core component of road stability is water control. Diluting and dispersing, especially away from fills, is a fundamental requirement of any road.

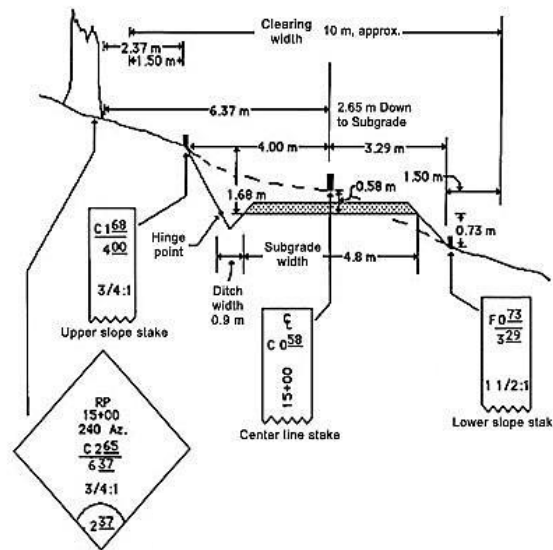

Figure 6. Road cross section showing construction pieces of information.

Table 3. Road construction equipment characteristics. (From OSU Extension Service, 1983).

Criteria	Bulldozer	Front end Loader	Hydraulic excavator	Dump trucks scrapers	Farm tractors
Excavation mode (level of control of excavated materials)	Digs and pushes; adequate control (depends on blade type)	Minor digging of soft material; lifts & carries; good control	Digs, swings, & deposits; excellent control; can avoid mixing materials long-distance material movement; excellent control	Scrapers can load themselves; •top down' subgrade excavation; used for small quantities	Minor digging and carrying; good control because it handles
Operating distance for materials movement	91 m; pushing downhill preferred	91 m on good traction surfaces	m (limited to swing distance)	No limit except by economics; trucks must be loaded	31 m (approximately)
Suitability for fill construction	Adequate	Good	Limited to smaller fills	Good for larger fills	Not suitable
Clearing and grubbing (capacity to handle logs and debris)	Good	Adequate	Excellent	Not suitable	Handles only small materials
Ability to install drainage features	Adequate	Digging limited to soft materials	Excellent	Not suitable	Adequate for small tasks
Operating cost per hour	Moderate, depending on machine size	Relatively low	Moderate to high, but productivity excellent	Very high	Low
Special limitations or advantages	Widely available: can match size to job; can do all required with good operator	Cannot dig hard material; may be traction limited	Good for roads on steep hillsides; can do all required except spread rock for rock surfacing	Limited to moving material long distances; can haul rock, rip rap, etc.	Very dependent on site conditions and operator skill

Poor practice can lead to significant sedimentation and high maintenance costs until cuts and fills self-stabilize. Fixing poor construction is often more expensive than doing it right the first time.



Figure 7. Goliran Road Widening

Road networks in mountainous forest landscapes can increase the susceptibility to shallow land sliding by altering subsurface flow paths. This is because roads can act as conduits for water and increase the amount of water that infiltrates the soil. This can lead to an increase in pore water pressure and a decrease in soil strength, which can increase the likelihood of landslides. This is because roads can increase the amount of surface runoff by reducing the amount of water that is absorbed by vegetation and soil. The increased surface runoff can then infiltrate the soil, also Human activity: mining, traffic vibrations, or urbanization change surface water drainage patterns. For all of this, if we didn't design ideal systems for Drainage and Slope stabilizing in such a rough region the Roads that we built could not do their jobs and we will have a chain of problems that need a large amount of money and effort.

2.3 Drainage

In this section, based on the results of hydrological studies, the technical structures of hydraulic studies are determined. To increase the coefficient of confidence, the maximum flow rates obtained from the Rational method are based on determining the diameter of the culverts. Currently, only 0.5-meter pipe culverts have been used on the current route and that too insufficient. These culverts quickly become clogged in forest environments due to their small diameter and are difficult to clean and aerate. Therefore, a diameter smaller than 1 meter is not recommended for culverts on this route. The capacity of a culvert depends on many factors. The most important of these factors are the slope of the ground, the roughness of the culvert bed, the shape of the culvert entrance, the upstream and downstream water levels, and the length of the culvert. Therefore, it is not possible to determine the exact capacity for each culvert and it depends on the location of each culvert. However, assuming an average height for flow in the culvert and using Manning's formula, an approximate capacity for each culvert can be calculated. Manning's equation is defined as follows:

$$Q = \frac{1}{n} AR^{2/3} S^{1/2}$$

eq.1

Where Q is the Culvert discharge (m^3/s), n is the channel bed roughness ($n=0.05$), R is the hydraulic radius (calculated from $R = A/P$, in which, A is the cross-sectional area and P is wetted perimeter), S refers to Average slope of the channel bed, and A is the cross-sectional area of the channel (m^2).

Table 4. Passing Capacity of Culverts

Width (m)	Flow Height (m)	Slope (%)						
		0.5	1	1.5	2	3	4	5
1	0.5	0.28	0.40	0.49	0.56	0.69	0.79	0.89
1.5	0.75	0.83	1.17	1.43	1.65	2.03	2.34	2.62
2	1	1.78	2.52	3.09	3.56	4.36	5.04	5.63
3	1.25	4.11	5.81	7.12	8.22	10.06	11.62	12.99
4	1.5	7.66	10.83	13.26	15.31	18.75	21.66	24.21
5	1.75	12.62	17.84	21.85	25.23	30.90	35.68	39.89
6	2	19.16	27.10	33.19	38.33	46.94	54.20	60.60
7	2.25	27.46	38.84	47.58	54.93	67.28	77.69	86.86
10	2.5	49.70	70.29	86.08	99.40	121.74	140.57	157.16
12	2.75	71.23	100.74	123.38	142.47	174.48	201.48	225.26
15	3	105.78	149.59	183.21	211.55	259.10	299.18	334.50

2.3.1 Considered Culvert:

A precast concrete culvert with 2 m width and 1 m height was used in the area.

- 1- The amount of entrance submergence is 85% which means 0.85 meters.
- 2- The maximum Manning's roughness coefficient for the concrete box is 0.016.
- 3- Considering that the output of all the water is towards the valley and in the form of rapid flow and any case needs protection, no limitation has been considered for the output speed.
- 4- The entrance of the culvert has been considered with a 30-degree angle on both sides.
- 5- Considering the formation of supercritical flow, the culvert is of the upstream control type. Therefore, the inlet conditions determine the flow rate and a change in slope does not cause much change in the flow rate.

Table 5. Flow rate and slope relation

Slope %	Q max cms	flow height m	V max m/s
1,00	2,25	0,85	2,58
2,00	2,30	0,85	2,97
3,00	2,35	0,85	3,26

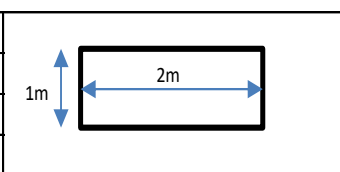

One of the most important points that should be considered in drainage in forest areas is the issue of debris and the inspection of culverts in a systematic manner. Because the presence of branches, leaves, flowers, and path debris can cause blockage of the culvert with any dimensions and length. Also, the culvert bed and the culvert underpass should be protected in the best possible way so that in critical situations it does not cause total or partial displacement of the culvert and disrupt its function. Regarding the implementation of culverts, it must be considered that the output of each culvert must be protected by stone or gabion. Due to the high slope of the culvert output, it is in the form of a landslide, and therefore in such cases, the culvert output is severely eroded in a short time and becomes empty underneath (Figure 8). In such cases, before and after the culvert, it must be protected by a retaining wall.



Figure 8. Severe erosion of the output of the old waterway

The minimum longitudinal slope for culverts is recommended to be equal to 3%. This minimum is necessary to ensure the complete discharge of the culvert from soil debris and sediment. During implementation, a longitudinal slope of 6% was considered.



Figure 9. An example of full protection of a culvert outlet downstream with natural materials



Figure 10. An example of preparing the placement of prefabricated concrete Culverts



Figure 11. Placement of Culvert boxes

In a way, the Drainage and Stabilization of the trenches are dependent and complementary to each other, and without the existence of one, the other has no meaning. The transfer of surface runoff and subsurface flow along the road will be the responsibility of the side ditch, and all cross-sectional slopes of the road profile must be directed as much as possible toward the ditch to prevent road shoulder erosion (Valley side erosion). This critical issue has not been considered in the design of old and existing roads in the area and has led to road shoulder erosion along the route, which is one of the most principal factors in left deviation and road accidents in forested and mountainous areas. Given that the transfer rate through the ditches will be less than 1 cubic meter per second in any case, assuming an 8 percent slope and a maximum flow rate of 1 cubic meter per second, and assuming Rock lining for the ditch, The required surface area for a flow rate of 5 meters per second will be 0 square meters, and a required surface area for a flow rate of 0.21 square meters must be provided. If the ditch is not covered, the required surface area will be 0.4 sqm.

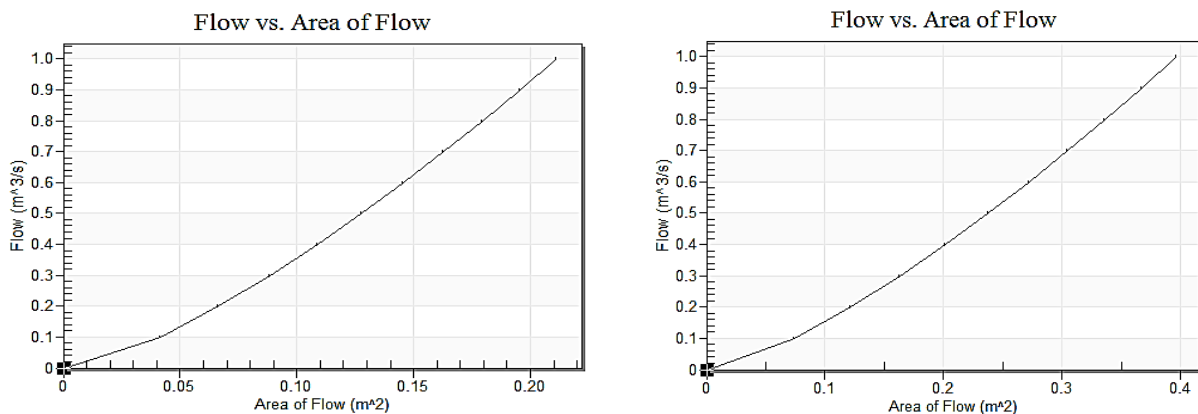

Figure 12. Plotted area vs Flow rate for the channel (a) without and (b) with cover.

It is especially important to use natural materials such as stone and wood in the construction of technical structures as much as possible in forested areas to minimize damage to the ecosystem. The aim is to avoid creating exposed concrete surfaces that make the forest look ugly and damaged. Of course, it is essential to note that unfortunately in Iran, due to the unfamiliarity of engineers with stone and especially wooden structures and a misconception that concrete is more suitable for project implementation without considering the ecosystem of the region and the future, they always consider concrete as the most suitable for project implementation. However, my colleagues and I have tried to use natural materials as much as possible, which I will refer to in the section on protecting the embankment slopes as shown in Figure 14, and lining with stone in places where there is a possibility of ditch erosion.



Figure 13. Removing Sludge and sediments, reviving the existing roadside ditch

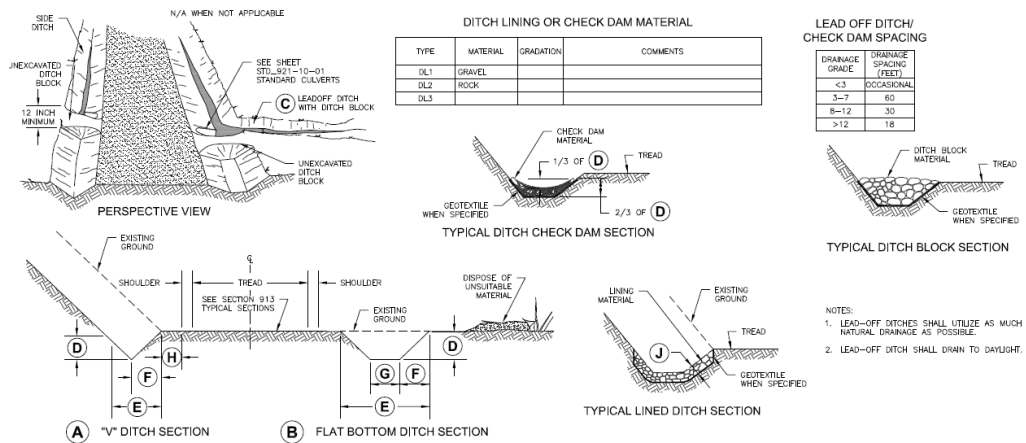

Figure 14. Typical ditch sections STD 925-01 (U.S DEPARTMENT OF AGRICULTURE, FOREST SERVICE)

In this regard, after removing the existing Ditch sludge and sediments, and rockfill section for protecting the road shoulder or digging ditches by the grader, we intended to rehabilitate and increase the efficiency and life period of the roadside ditches by constructing check dams in areas with the steep slope as shown in Figure 10 and lining with stone in places where there is a possibility of ditch erosion. There are two reasons for this. First, reducing the permeability of the ditches by concreting the surfaces as happens with road construction increases the volume of surface runoff. Increasing the volume and speed of surface runoff downstream and in the transverse culverts will destroy the culvert heads, increase water infiltration at these sections, reduce soil shear resistance at the culvert location, and increase the likelihood of landslides. Second, one of the most important issues in the region is preserving the natural beauty of the forest. As noted in the US Forest Service notes, it is always important to preserve natural drainage as much as possible. But unfortunately, we are faced with tragedy in Goliran road ditches.



Figure 15. The concrete lining of the ditches without meeting the required minimums (2023 Summer)

Concrete as you see in Figure 12 can have negative impacts on the environment. In the jungle, concrete can be particularly problematic because it can lead to deforestation and habitat loss for animals. Additionally, as we mentioned above concrete can cause soil erosion and water pollution.

2.4. Stability

This section is devoted to the study of static and pseudo-static stability of the slopes of the Goliran mining project. The geological data of each of them has been estimated based on field measurements. To investigate the above and determine the geological characteristics of the soil units, field measurements, and engineering geological surveys have been carried out. In the case of non-optimal slope design, there is a possibility of forming tensile cracks, instability, sliding, and destruction of the sloping wall. AASHTO and FHWA regulations have been used to limit the coefficient of confidence. So, the coefficient of confidence is 1,5 in static mode and 1,1 in dynamic mode (pseudo-static). Also, the maximum acceleration of strong ground motion in Iran has been presented based on the relative seismic hazard zoning map (standard 2800), in which in my study area, the maximum horizontal acceleration component is about 0.3g.

To analyze the stability of the slopes under discussion, the limit equilibrium method has been used in both static and dynamic modes. For this purpose, limit equilibrium principles and SLIDE software have been used. Also, due to the existence of layering, discontinuities, and main fractures in some rock units of some slopes, proportional kinematic analyses have been presented under critical conditions in some slopes." It should be noted that for the kinematic analysis of the slopes, for sections with lithology of the rock slopes, using geometric and specifications such as slope and slope extension (Dip & Dip direction) of fractures and layering surfaces, Schmidt network has been used, the results of which are in the relevant section.

Each slope mentioned is subject to three important types of instability that are analyzed based on the existing fracture and separation surfaces in the rock mass. These three types are (figure 13):

- Wedge instability
- Planar or layer instability
- Toppling instability

Slope instability is caused by the effect of gravity on masses of materials that can slowly creep, fall freely, slide along a fault plane, or flow like a fluid. Numerous factors affect the slope instability and instability of the slopes under study. In this section, the most crucial factors affecting the instability of the slopes under study are mentioned:

1- Road construction and embankment of the overpasses have caused the balance of driving and resisting forces against slipping to be disrupted and in some overpasses, the driving forces of slipping are more than the resisting forces against slipping and cause the movement of slopes. Also, some slopes are on the verge of movement.

2- Groundwater and surface waters are also considered effective factors in the instability of overpasses. The rise of groundwater in overpasses due to rainfall or drainage of surface waters causes saturation of overpasses. The effect of this factor is more on fine-grained materials. In fine-grained materials that have poor drainage, these conditions cause the production of seepage pressure and a decrease in the effective vertical stress on the surface of the slope and consequently a decrease in the shear resistance of the materials. Also, increasing water means increasing the weight of the slope and facilitating its gravitational movement.

3- Morphology susceptible to sliding is one of the other effective factors in the instability of these overpasses. The high slope and height of the overpasses have caused them to be in a critical stability condition. To prevent slope instability or design a stable slope, the following three methods can be considered:

- Relocation of the design site.
- Reduction of driving forces (motivators).
- Strengthening resisting forces against displacement.

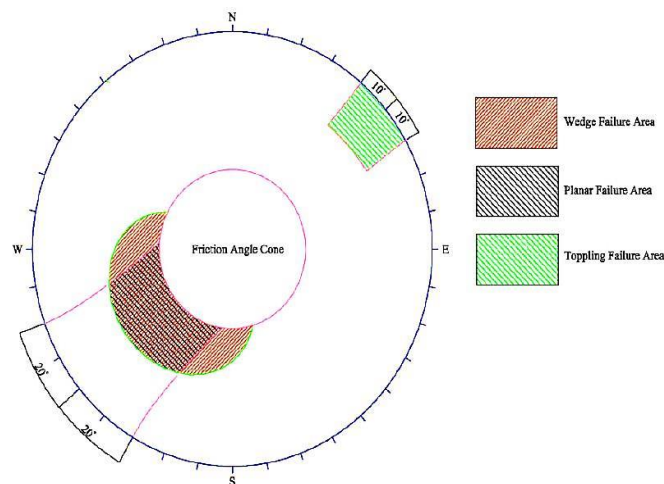

Figure 16. Range of Wedge, plane, and overturning instability in kinematic analysis

The main action to avoid the risk of slipping is to identify areas with weak drainage or active points in terms of displacement and settlement precisely in the design study stage. This knowledge will help a lot in deciding on the design site or relocating it. In these studies, if the safety factor against slipping is greater than one, it can be expected that the minimum reduction in resisting forces (for example, due to rising water levels) will cause instability. Since the criterion for instability is the collapse of the driving and resisting forces, reducing the weight of the sliding mass will reduce driving forces and consequently increase confidence against displacement. Reducing slope angle, terracing and soil drainage, and using lightweight materials in embankments are examples of methods for reducing sliding mass weight and consequently reducing driving forces. Another method to prevent slope instability is to increase resisting forces against displacement. For this situation, either external forces such as retaining walls must be applied to resist earth pressures or internal resistance of the sliding mass must be increased so that the slope remains stable. In general, it can be said that for overpass stability, both reducing driving forces and increasing shear resistance of sliding surfaces can be done.

To reduce driving forces, geometric methods such as reducing height, reducing slope, terracing the slope, and improving drainage can be used. To increase shear resistance, various methods such as ground improvement, mechanical modification, use of retaining structures, gabions, reinforced soil, etc. can be used. Choosing the proper method for stabilizing overpasses based on the characteristics of rock overpasses, implementation constraints, implementation costs, etc. is done. In general, it can be said that both reducing driving forces and increasing the shear resistance of sliding surfaces can be done for overpass stability.

In the following, two examples of long trenches and Stabilization methods in the project will be analyzed with Slide 2 Software.

❖ Km 1+180:

- ❖ Between kilometers 1+160 to 1+200 of the studied route, an overpass is found that has a maximum height on the right side of the route and is about twenty-five meters at around kilometer 1+180 and the length of the overpass is about 40 meters.

The lithology of the sediments and rocks of this overpass includes about 1 to 2 meters of clayey soil sediments and surface layers and forest soil and under it are destructive sediments of conglomerate type with cementitious lime that have pebbles in the range of sand to gravel. Also, the existence of sedimentary layers and lenses with silty sandstone geology that have cementitious - lime is also evident in this overpass. It is suggested that an exploratory guess be drilled at kilometre 180 + 1 to a depth of about 26 meters to clarify the columnar geology and soil and rock engineering parameters of this overpass so that its information can be used in analysing the stability of this overpass.



Figure 17. Conglomerate lithology of the trench body km 1+180 (top and bot)

According to field observations and similar projects, the internal friction angle of this rock is mostly about 35 degrees conglomerate, its cohesion parameter is about 100 kilo Newtons per square meter and its density is about 25 tons per cubic meter. Since there is no clear layering and the lithology of the body of this overpass is massive, the stability analysis of this overpass has been presented using Slide software by considering the above assumptions and a 25-meter-high right wall with a slope angle of 63 degrees (2 vertical - 1 horizontal), with 3-meter berms and an 8-meter step height for the right slope. It provides a static safety factor of 1.68 and a pseudo-static safety factor of 1.32.

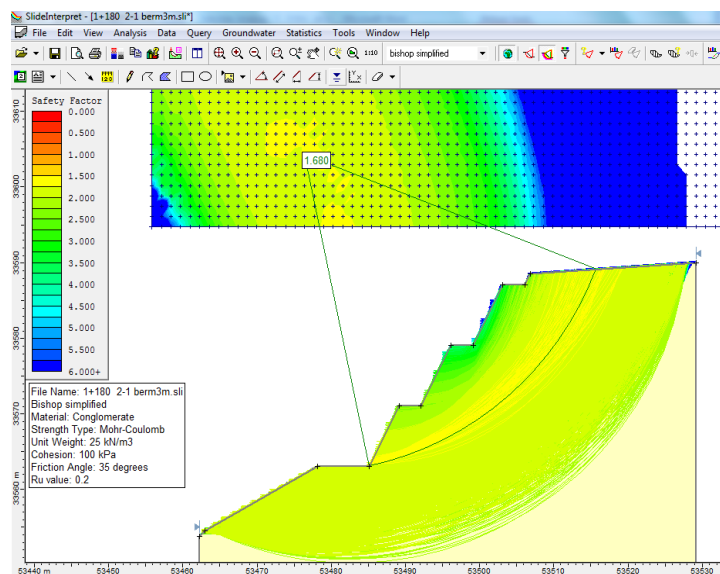

Figure 18. Cross section of right-side trench km 1+180, Static analysis

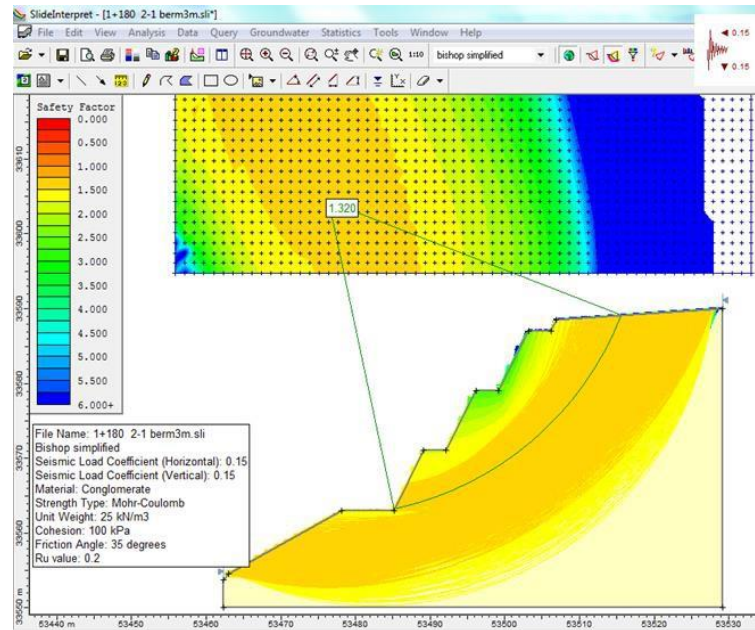

Figure 19. Cross Section of right-side trench km 1+180, Pseudo-Static analysis

❖ Km 5+720:

Between kilometers 700 + 5 to 730 + 5 of the studied routes, an overpass is found that has a maximum height on the left side of the route and is about 14 meters at around kilometer 720 + 5 and the length of the overpass is about 30 meters. The lithology of the sediments and rocks of this overpass includes about one meter of clayey soil sediments and surface layers and forest soil and under it are silty sandstone sediments with weak cementitious- lime that have pebbles and some parts are conglomerate. These rocks have a uniaxial compressive strength of about 20 to 50 megapascals. The mentioned rock layers in this area have an approximate slope and slope extension of 65° - 75° / 350° - 360° Bedding: Dip/Dip direction.

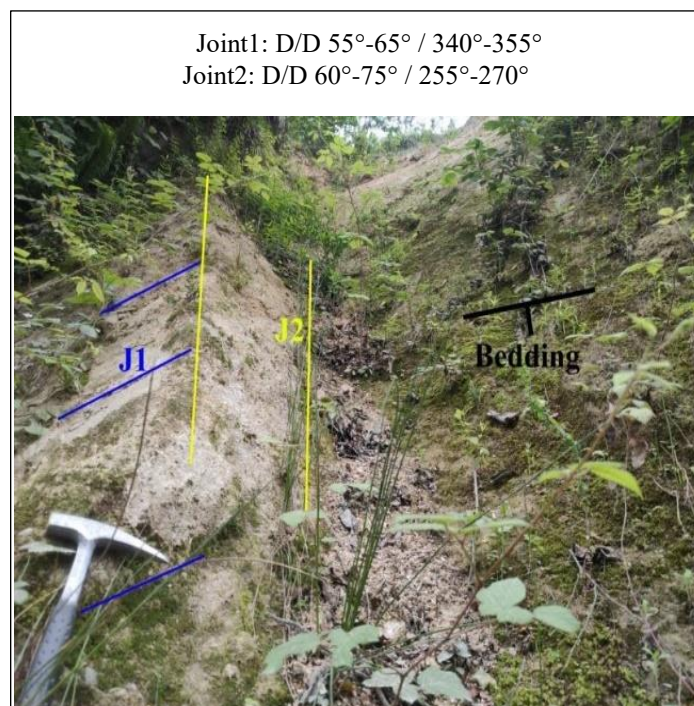

Figure 20. A view of trench lithology and systematic seams and layering

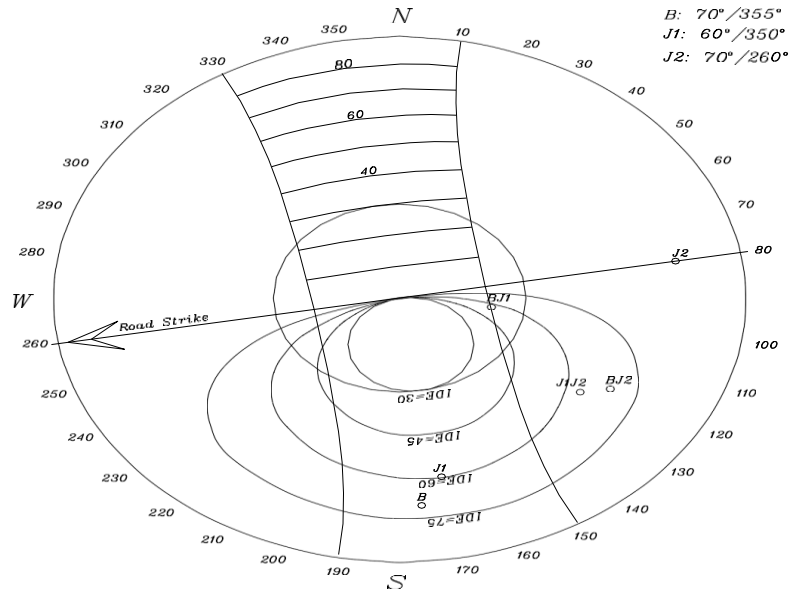

Figure 21. Sliding wedge

According to Figure 21, it can be seen that the poles J1J2 and BJ2 are located in the slip zone and are prone to slip. To stabilize these poles from an instability point of view, a stable slope with a slope of about 63 degrees should be used based on the above kinematic analysis. Also, pole BJ1 is located in the stable cone with a slope of about 30 degrees. Therefore, from the point of view of pole instability, the left wall of the overpass will remain stable with a slope of about 63 degrees. In terms of instability, no instability is observed in the type of overturning. Therefore, it is suggested that the slope of the overpass at kilometer 5+720 be about 60 degrees with a maximum slope of about 75 degrees (2 vertical - 1 horizontal) and be implemented with caution.

According to field observations and similar projects, the internal friction angle of these silty sandstone rocks is mostly about 35 degrees and its cohesion parameter is about 100 kilonewtons per square meter and its density is about 22 tons per cubic meter. The cross-sectional analysis of the left overpass at kilometre 5+72, which has a slope of 63 degrees (2 vertical - 1 horizontal) and has obtained a safety factor of over 1,5 in Static mode with 3-meter berms and an 8-meter step height. The pseudo-Static safety factor is 1.1.

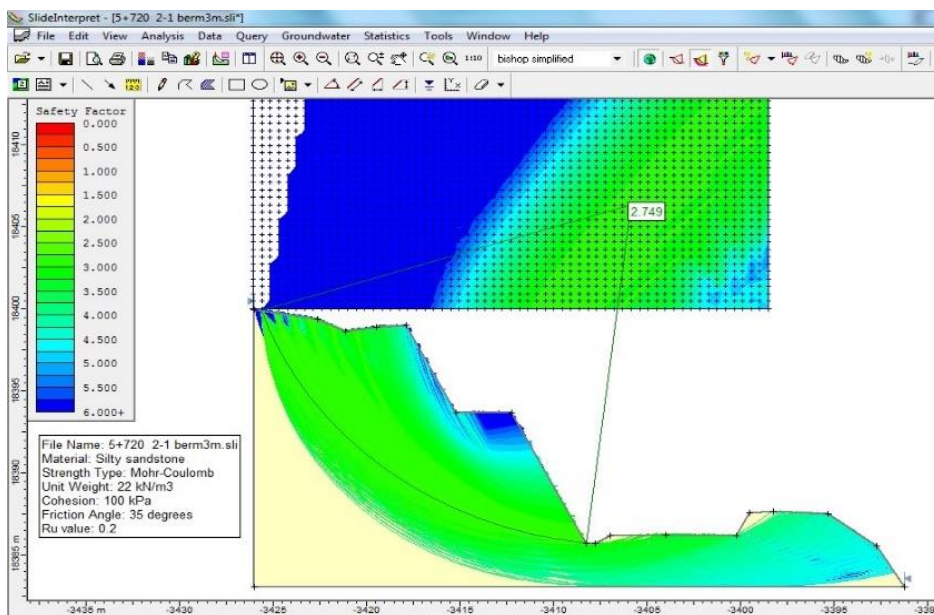

Figure 22. Cross section of left-side trench km 5+720, Static analysis

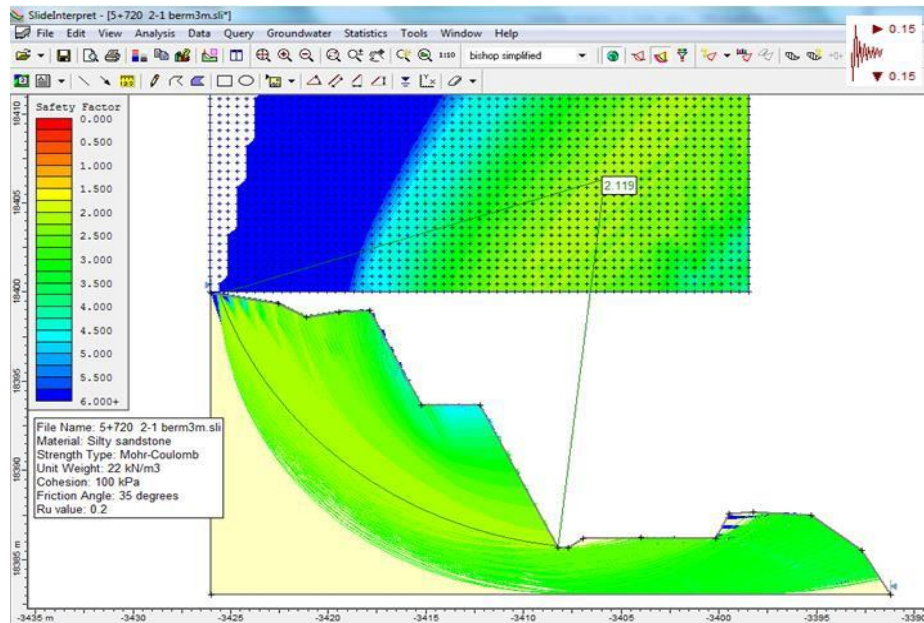

Figure 23. Cross section of left-side trench km 5+720, Pseudo-Static analysis

Based on all the field data and numerical modelling, as well as the topography of the area and road route, and the documents available on site regarding the condition of old culverts and what has happened to the trenches, especially on the valley side due to erosion and landslide, the best method for preserving the stability of the road route and trenches located along it is not to manipulate the existing condition of trenches and to build retaining walls in the necessary locations, especially on the valley side. Also, most of the widening should be done on the valley side due to being located in cross-sectional channels or landslides so that deforestation due to trenching can be prevented and minimum stability can be observed. Furthermore, to prevent road landslides due to improper maintenance of drainage channels and saturation of beds, most of the widening should be done on the valley side by retaining walls.

2.4.1 Retaining Walls

Unfortunately, in the initial estimates of the project, all protective walls were predicted to be concrete without considering the sensitivities of the area and its ecosystem. Fortunately, with the cooperation of all executive factors, these walls were changed to Gabion walls. In this section, we will discuss the types of retaining walls that can be implemented in forests, using available resources and materials as well as retaining walls in the Project.

➤ Mechanically stabilized earth structures

(MSES) are made by overlapping layers of soil reinforced with wire mesh and or geosynthetic materials (geotextile and geogrids) until reaching the needed wall height. Each layer is built using an appropriately shaped container and is infilled with compacted soil. The main advantages are the simple materials used, low cost and fast construction, minimal foundation preparation (typically), and that they can sustain large loads. The structure can be hydro seeded to look like a typical fill over time. The main disadvantages are the high amount of excavation required, the need for well-skilled operators, and the good quality of filling soil (compaction susceptibility).



Figure 24. MSES Retaining wall.

➤ Gabion structures

Gabion baskets and mattresses are systems of wire mesh containers filled with stones, rock, or rubble. They are used to build gravity walls that can support slopes and prevent erosion. They are especially useful when the slope angle is too steep or when the slope encroaches into a waterway. Gabion structures can be shaped to fit different situations, such as stepped, sloped, or vertical walls. Gabion structures allow water to drain through them, which reduces the pressure from seepage flows. To avoid losing fine particles from the fill, a geosynthetic filter fabric should be placed between the backfill and the basket. Gabion baskets and mattresses are more flexible and reliable than traditional boulders for gravity wall construction. Gabion baskets and mattresses are made of wire mesh and filled with rocks. They can bend and adapt to different situations, such as when the ground is soft or moves because of frost or other causes. They are good for protecting rivers and streams from erosion, supporting bridges and slopes, and holding heavy loads. Different sizes of gabion baskets can be bought from the market. They usually have a length of 2 m or 4 m, a width of 1 m, and a height of 0.5 m or 1 m. The wall is built by stacking the baskets on top of each other in steps. Gabions are often cheaper than other solutions because they use materials that can be found on-site, such as rubble, broken rock, or concrete. The main drawback of this solution is how it looks. Gabion baskets and mattresses can work together to make strong bridge abutments. Gabions can also help prevent erosion of existing abutments. Reno mattresses are a type of gabion mattress that is used to slow down the water flow and stop the waterway bed from being washed away, especially after a Ford or battery culvert. Mattresses are tied together to make a continuous layer over the waterway bed. Mattresses are 6 m long, 2 m wide, and either 240 mm or 300 mm thick. They are flexible and can fit the shape of the ground. If more erosion control is needed, the mattresses can be covered with concrete.

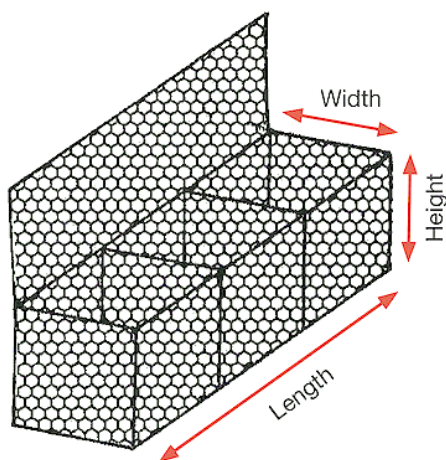

Figure 25. Gabion Basket



Figure 26. Gabion retaining wall km:3+200.

➤ Timber cribs.

Timber cribs are a traditional retaining wall choice in some parts of the world. The construction components are logs with high natural durability, stones, and spikes. The space between the layers is filled with stones and, where necessary, geotextiles and drainage pipes may also be used. The logs are connected with spikes 20-30 cm in length and 10-12 mm in diameter. The result is a highly water-permeable and cost-effective structure. When compared with a gabion, it is aesthetically more pleasing, and the construction materials are less expensive, but the construction is more laborious.

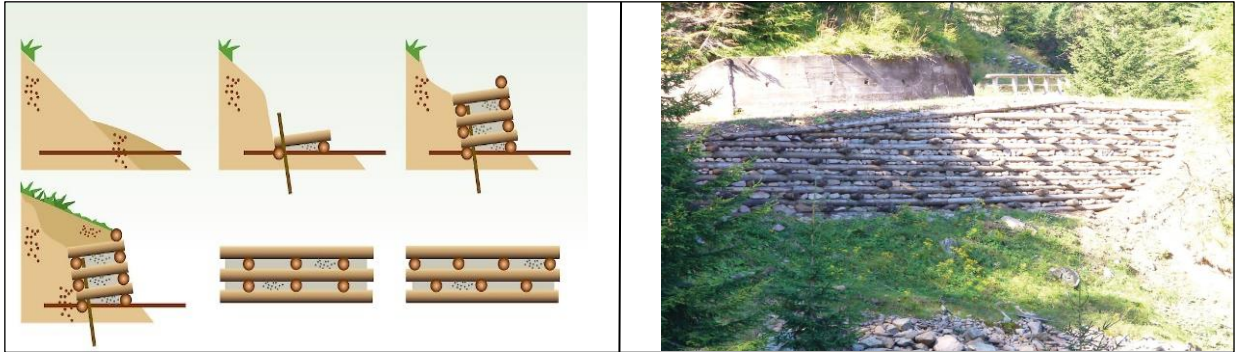

Figure 27. Timber crib.

➤ Timber cantilever pile wall.

Another common retaining wall design possibility is using vertical poles fixed in the ground that sustain horizontal logs or lumber containing the backfill soil. These are common outside forestry in New Zealand. The design should consider the bending resistance of the poles used and the pole depth into the soil. A rule of thumb is that the depth of the poles should be as the wall is high. Cantilever pile walls are a low-impacting solution with the major advantage being a low amount of excavation. However, on the ground with bedrock or soils with larger rock components, it may be difficult to drive piles to the necessary depth and other options need to be considered.



Figure 28. Timber pile wall.

It is most important to determine the source of factors influencing slope instability to be able to design proper control and rehabilitation measures. Very often a single measure may achieve the desired results but sometimes it may be necessary to combine measures to restore the stability of the slopes. For instance, on a seepage slope, it may only be necessary to drain off the water with open ditches or stone-filled drains. On other occasions, it may also be necessary to revegetate the slope to fix the slope surface because vegetation would not come back at all or it would take too long a time, and a retaining wall would be required. In a mountain road project in the USA (Idaho), it was noted that 60 percent of the surface erosion occurred within one year of the disturbance of the slope; thus, it is important to stabilize slopes at once, or shortly after the construction of a road.

Since old times in the region, the use of Gabion has been common for the stability of the slopes; it's very compatible with the ecosystem of the region. It's also cost-effective because we have a large volume of retaining walls on the road, and a principal issue in any Project is balancing the costs. For all these reasons we chose Gabion retaining walls for our Project.



Figure 29. Retaining wall construction km 7+500

3. RESULTS AND DISCUSSION

Given that the main goal of improving this road is to transfer raw coal from the Goliran mine and increase efficiency and reduce transportation costs alongside its effects on the people of the region, it is clear that heavy machinery traffic with the load on roads has destructive effects on the surface of the road and other structures along the route. Therefore, quality, durability, and operability as well as environmental issues are among the fundamental issues in improving and widening this road. Accordingly, observing all engineering principles while considering special regional issues such as reducing environmental impacts is one of the priorities of the employer and contractor and we have not spared any effort or effort to achieve the lofty goals of the project and help even a small step towards economic growth. Given that the project is still in its implementation stages, it is hoped that in the future, other research and articles that highlight the fundamental principles and benefits of the project will be prepared and compiled. Given the two rainy seasons and harsh winters in the highlands of the region, fortunately, no damage was done to the road body or route culverts. The ditches had an incredibly superior performance in collecting and discharging surface water throughout the route. It should be noted that during the entire rainy season, ditches and culverts were cleaned for free passage of surface water and prevention of flooding when necessary. Also, traffic on the entire length of the road has been improved compared to before and is now flowing smoothly and without problems and at high speed. This is a real model for testing and evaluating the performance of the improved route. It is worth mentioning that throughout the length of the road, due to its narrow width and simultaneous use of mining compressors, private cars, and all road construction equipment, and due to the lack of an alternative route, the route was never closed. This is a real model for evaluating the performance of the road and good working.

4. CONCLUSION

As a result, it is clear that all Drainage and Stabilizing implementations work together and it is impossible separating them in this case. It means that, if these types of roads built or reveal, it is needed to build Ditches, Culverts, and Retaining walls to be in harmony with each other. The drainage structures on a sample forest road should be visited and dredged periodically of course before Rain to ensure their proper functioning. Planning of all kinds of drainage structures used on forest roads should be done appropriately. Based on the calculations made as a result of field studies, measurements, and observant ions are especially important in determining the type, size, and location of the drainage structure. Drainage structures must be placed on the road route at an angle of 30° - 45° . This will improve system function; it should not be placed perpendicular to the road. Because erosion and accumulation of sediment can be observed in the place of structures, that are placed perpendicular to the flow direction. A 3-6% longitudinal slope should be applied to the interior of the culverts to prevent sedimentation inside the culvert. Particular attention should be paid to material selection for constructing drainage (Ditches and Culvers) and retaining structures.

Have to use natural materials and avoid using concrete especially exposed or as the cover of ditches. While deciding the places of culverts, the grades of fields and roads should be considered. When the grade of the entrance is higher than the exit, it surely causes sediment and water accumulation inside the culvert. Of course, most of the mountain routes drained into the valley and it's important that the culvert outlet is placed on the retaining wall and the drainage route stabilized. A cheaper way of stabilizing channels and outlets of water crossings is to provide rock riprap which in most cases gives satisfactory results.

The landings should be prepared in size of 90-100 cm before the entrances of culverts by Rock fill materials. Thus, sediment coming with water from dip drains will be massed on these landings and cleaned more easily during periodic maintenance. Also, bracket walls at the entrance are necessary to prevent erosion on the roadside. For each term, before and after forest field works, entrances, and exits of drainage facilities should be cleaned with the help of an excavator or laborer. When placing the drainage structures in the designated area, the foundation excavation of the structure should be made up of bedrock. If the foundation is not placed on solid ground, the culvert remains high and the water that should pass through the culvert can flow through the foundation of the culvert or should be built the foundation with the cutoff wall. The foundation or the first step of the Retaining wall should be placed on a Solid and reliable platform, at least 2 meters of the Gabion with a height of more than eight meters should be buried, and the inclination of the structure is toward the trench. It is recommended that the minimum width of the floor is equal to 60% of the height of the wall. Considering that a gabion is a flexible object, it adapts well to the forest environment, and in case of any settlement, it can continue its duties without losing its efficiency, and it's possible to restore and increase the height of the gabion wall. It's important to Choosing the right wire mesh according to the applied pressure and the use of restraining wires to strengthen the basket, as well as ensuring the complete elongation of the wires and mesh in a way that prevents any movement of stones, is one of the main factors in the construction of a gabion retaining wall that can have the necessary durability and stability.

Finally, in Projects in the forest or protected areas, the cooperation and consensus of forestry and natural resources officials are remarkably effective to make the implementation of the Project as easy as possible.



Figure 30. Km: 4+950 during construction



Figure 31. Km: 4+950 after construction and backfill



Figure 32. Retaining wall seen from the mountain peak, Km: 6+050

Acknowledgments

Thanks to the Consultant Engineer Company Argoman-Tarh especially Mr. Taher Fethulahi. Special thanks are also given to all the colleagues on this Project. Thanks to JNK as a Project contractor, especially Mr. H. Golabkesh and Mr. A. Nattaj (Chairman and member of the board of directors).

Funding

There are no financial interests in this study.

Declaration of Competing Interest

There is no conflict of interest in this study.

References

- [1] Standard Trail Plans and Specifications STD, USDA Forest Service 2014.
- [2] Forest Roads and Tracks, Grants & Regulations Note 25, Forestry Commission, England 2011.
- [3] L. Pancel, M. Köhl Tropical Forestry Handbook, Second Edition.
- [4] Ozturk, T., 2020 Temporal change of Drainage Structures in Forest Road. European Journal of Forest Engineering.
- [5] NZ Forest Road Engineering Manual 2020, NZ Forest Owners Association Inc.
- [6] R. Heinrich and O. Sedlack A Manual for the Planning, Design, and Construction of Forest Roads in Steep Terrain, FAO, 1998.
- [7] Boran, M., F. Tonelli, and J. Salleroni (2004), A physically based model of the effects of forest roads on slope stability, Water Resources.
- [8] Anonymous, 2009. How to Install a Forest Road Culvert. Forestry Services Division, Oklahoma Department of Agriculture, USA.
- [9] Rezvani, M., 2012. Investigation of Drainage Structure of Forest Roads in North of Iran. Global Journal of Bioscience and Biotechnology, 1(2): 220-222.
- [10] Ryan, T., Phillips, H., Ramsay, J., Dempsey, J, 2004. Forest Road Manual Guidelines for the Design, Construction, and Management of Forest Roads. National Council for Forest Research and Development, Ireland.
- [11] Schwab, J., 1994. Erosion Control: Planning, Forest Road Deactivation and Hillslope Revegetation. A Guide for Management of Landslide-Prone Terrain in the Pacific Northwest, Second Edition, Victoria, British Columbia.
- [12] Anderson, M. G. (1983), Road-cut slope topography and stability relationships in St. Lucia, West Indies.
- [13] Hydrological and Geological Studies of Improvement of Goliran Road to Goliran coal mine, Argoman Tarh consultant Engineering, Jun 2021, Tehran, Iran.



Determining the Appropriate Transportation Option with the Decision Tree

Ozan ATEŞ^a

^aAssistant Professor, Faculty of Engineering, Industrial Engineering Department, Turkey e-mail:ozan.ates@gedik.edu.tr

Abstract

Due to the fact that the population density in Turkey is concentrated in the Marmara region, many businesses are positioning their facilities in this region. For this reason, logistics companies, also called 3PL, serving these businesses are located in the same region. Logistics companies determine various transportation strategies according to the shipment volumes of the customers they serve. The main objectives of these strategies are based on cost minimization, productivity increase and improvement of customer service levels. In this publication, a decision tree was used to determine the transportation strategy of a customer of the logistics company whose case study was conducted. The costs of alternative options, including the current transportation option, were calculated and the transportation option with the lowest cost was preferred. In the study, real data was used and a case study was carried out in a logistics company serving in our country. The reason why the decision tree method is preferred is that it is easy to implement and can answer many basic logistics problems.

Keywords: Decision tree; transportation options; 3PL firms; logistics.

1. INTRODUCTION

Logistics companies, also known as third party logistics (3PL), the activities performed by outsourcing the logistics activities of the enterprises are called third party logistics. The reason why third party logistics is qualified as third can be understood by explaining first and second party logistics. The fourth party logistics emerged later.

- First-party logistics: Manufacturer, wholesaler, retailer or shipper,
- Second party logistics: It is the direct customer of the first party,
- Third party logistics: Logistics intermediaries; service provider, carrier, warehouse operator,
- Fourth party logistics: A logistics product is a business that coordinates and integrates information flow processes.

The international competitive environment forces businesses to transfer their activities outside of their areas of expertise to professional companies that are experts in their fields. Experienced logistics companies outside the company have great responsibilities in structuring this series of activities in a fast and economical way without disruption. In this understanding, called Third Party Logistics (3PL), the transportation of the raw material from the emergence to the factory, the internal processes and then the timely delivery of the finished products to the consumption centers and buyers requires a certain level of knowledge, experience and management skills. Third party logistics companies have the ability to provide services in material flow from the supplier industry to the enterprise, that is, in the physical supply stage, in the production processes, in the internal transactions stage, and in the material flow activities ranging from the enterprise to the buyers. Many manufacturers outsource

some or all of their supply chain management functions. It is possible to express the reasons for cooperating with third-party logistics service providers as follows [1]:

- Optimizing logistics capabilities,
- Reducing logistics costs,
- In order to increase customer satisfaction, to be more flexible towards customer requests and to have the capacity to respond to these expectations,
- Providing expertise and resources for talents that are not available,
- Concentrating on the company's core business,
- Avoiding employee problems and improving customer service,
- Developing core competencies for better service to customers,
- Developing operations,
- Avoiding tying capital,
- Avoidance of control, correction and new instruction costs,
- Gaining flexibility in the market and agility against the changing expectations of the market,
- Providing strategic solutions and obtaining strategic partners, apart from the advantages in operational activities,
- To meet demand fluctuations,
- Not having sufficient information and communication technology.

This study was carried out in a local 3PL company operating in Turkey. The company in question carries out transportation with 81 cities in Turkey and provides services with 27 logistics centers within the scope of domestic distribution operations. 25 logistics centers, excluding the logistics centers on the Anatolian and European Sides of Istanbul, distribute the products coming from these 2 logistics centers to the regions they are responsible for, and the products that are not received for various reasons are kept in the return area. When a certain vehicle occupancy is achieved, these returns are returned to one or both of the two logistics centers from which they came.

In these two logistics centers, there is more intensive work compared to other logistics centers. Due to the location of these two logistics centers, products from customers are accepted and these products are divided into lines according to the logistics centers they will go to. In front of the relevant line (for example, in front of the Adana line that will go to Adana Logistics Center), the products of the regions coming from all customers and entering the distribution network of Adana Logistics Center are kept.

This logistics network coming from customers and customer branches is called "Inbound Logistics (Supply Logistics)". The concept of supply logistics is at the stage before the physical production of the product or service; It refers to all the activities such as the selection of raw materials or semi-finished products, their planning and storage between the suppliers and the manufacturer. Supply logistics with a wide range; operates in areas such as food, health, industrial sector, military ammunition production. With supply logistics, answers are sought to questions such as which material will be ordered from where, how much, which purchasing tools will be purchased, and how the products will be stored [2].

Inbound logistics operations continue between 09.00-22.00 in the mentioned 3PL company. All incoming products between 22.00 and 07.00 are loaded on the vehicles of the relevant lines. Vehicle allocation is made according to the volume of the products accumulating on the lines in deci units. The distribution network from the Anatolian and European side logistics centers to the remaining 25 logistics centers is called "Outbound Logistics (Distribution Logistics)".

Distribution logistics, also called physical distribution, covers activities that involve the physical delivery of products to customers. Supply and distribution logistics can be called inter-enterprise logistics, and production logistics can be called intra-enterprise logistics [3].

Within the scope of inbound logistics operations, the products of many customers are collected together with their waybills during the day by Milk-Run vehicles, which make cyclical voyages, and are left to the relevant logistics center (Anatolian or European logistics center). Here, the products whose barcoding and system identification processes are completed are distributed to the relevant lines in the logistics center. This operation structure is determined for customers whose daily volume is relatively below a certain level and the share of this operation in the total operation is at the level of 30%.

A second operation within the scope of inbound logistics creates products from other warehouses of the said 3PL company. Some customers are provided with both storage and distribution services. The warehouse operation unit manages this operation of the customers who have storage, and the domestic distribution operations unit manages the distribution operation. The warehouse operation unit makes the products to be shipped according to the demands of the customer company. According to these demands, waybills are printed, products are barcoded and systematically defined. These products are distributed directly to the lines in the relevant logistics center without being barcoded again. The share of this operation in the total operation is around 15%.

Within the scope of inbound logistics operations, the third and final operation is the structure where branches are established for customers with high shipment volumes and dispatch, barcoding and systematic identification processes are carried out in these branches. Due to the fact that the circular voyage vehicles exceed the capacity, these volume shipments are carried out by ring vehicles that go between the branch and the logistics center. In this operation, which has a high share of 55% in the overall operation, branches are established for high-volume customers and the employees of the 3PL company working in this branch carry out the relevant processes of the products accepted from the customer.

The common point of all three types of operations within the scope of inbound logistics operations is that they require all products to visit logistics centers. However, in this study, it is aimed to direct some products directly to the target logistics center without visiting Anatolian or European Logistics centers by making an appropriate planning for the customers who have a branch of the 3PL company. Thus, one of the stages will be eliminated and it will be possible to eliminate the risk of damage caused by unnecessary handling, loss of time and unnecessary labor costs.

2. CASE STUDY

There are 18 customer branches affiliated to Anadolu Logistics Center and 25 customer branches affiliated to European Logistics Center of the 3PL company where the study was conducted. Since the products coming from these branches, the products collected by the circular voyage Milk Run vehicles and the products coming from the warehouse of the same 3PL company all come to these logistics centers, the density of these logistics centers reaches the line level. In this study, it is suggested that some bulky shipments go directly from the branch to the target logistics center, without visiting the logistics center, in order to both reduce the densities in these logistics centers and reduce the risk of damage and time-cost losses as mentioned before.

In Table 1, the volume information of a customer branch that is connected to the European Logistics Center and sends products there, according to January-November 2022 and their regions, is given in deci. The aim is to determine whether it is cost-effective to make shipments to the target branch without visiting the logistics center for the relevant branch. If a lower cost shipment is possible without visiting the logistics center, it will be possible to apply this situation to customer branches with other volume shipment values.

The customer served by the 3PL firm is expressed as "X" in Table 1. In this table, monthly shipment volumes of customer X by region between January - November 2022 are available in the table. For this customer, 4 different shipping regions have been determined according to their distances in the country. The location of customer X is in Kocaeli/Gebze, and the products are shipped from the branch of 3PL company in customer X to Anadolu Logistics Center and partial transportation is carried out by being shipped to the remaining 26 logistics centers by line vehicles.

Partial literally means part, not whole. Transportation services such as complete, partial, project and heavy transportation are offered in the transportation sector. The logistics of transporting the loads of different customers on the same route with the same truck, pickup truck or lorry is called partial transportation or partial goods transportation. The main purpose of partial cargo transportation is to bring the cargoes requested to be transported on the same route to an economical level by loading them on the same vehicle, even if the amount of cargo does not fill a complete vehicle [4]. Partial transportation can also be called LTL (Less Than Truck Load).

3PL companies offer various pricing options to their customers to whom they provide transportation and/or storage services. Factors affecting pricing can be listed as follows [5]:

- Vehicle - Equipment and Equipment Costs
- Transport Distances
- Vehicle Maintenance and Repair Costs
- Insurance Premium Expenses
- Warehouse - Warehouse Operation Expenses
- Communication Costs
- Material Handling Expenses
- Management Expenses
- Load Partition Status and Mandatory Waiting

As can be seen in Table 2, the 3PL company where the study was conducted offers the cost information of its customer named X in 4 different ways per deci, depending on the distance. As the distance from the first region to the fourth region increases, the cost also increases. According to Table 1 data, the products of this customer are shipped to the first and fourth regions at a rate of 26.2%, and to the second and third regions with a rate of 73.8%.

Table 1. Dispatch Volumes by Regions

CUSTOMER	DESTINATION	DATE	NUMBER OF TOURS	1. REGION DESI	1. REGION DESI RATIO	2. REGION DESI	2. REGION DESI RATIO	3. REGION DESI	3. REGION DESI RATIO	4. REGION DESI	4. REGION DESI RATIO	DESI TOTAL
X	ANATOLIANLC	JANUARY	21	6.960	5,31%	69.924	53,31%	37.729	28,77%	16.543	12,61%	131.157
X	ANATOLIANLC	FEBRUARY	51	31.854	7,51%	200.918	47,39%	138.744	32,73%	52.408	12,36%	423.924
X	ANATOLIANLC	MARCH	56	32.288	6,52%	190.927	38,57%	199.440	40,29%	72.335	14,61%	494.990
X	ANATOLIANLC	APRIL	38	19.633	6,02%	92.766	28,42%	143.879	44,08%	70.091	21,48%	326.369
X	ANATOLIANLC	MAY	33	11.040	4,74%	72.358	31,07%	107.404	46,12%	42.066	18,06%	232.868
X	ANATOLIANLC	JUNE	17	3.732	6,51%	25.731	44,87%	19.947	34,78%	7.935	13,84%	57.345
X	ANATOLIANLC	JULY	7	1.828	10,17%	4.435	24,69%	8.010	44,58%	3.693	20,56%	17.966
X	ANATOLIANLC	AUGUST	17	5.036	4,72%	27.346	25,64%	42.678	40,01%	31.611	29,63%	106.671
X	ANATOLIANLC	SEPTEMBER	31	33.319	16,46%	84.708	41,85%	61.537	30,40%	22.834	11,28%	202.398
X	ANATOLIANLC	OCTOBER	40	77.474	24,98%	95.038	30,64%	88.755	28,62%	48.871	15,76%	310.138
X	ANATOLIANLC	NOVEMBER	29	40.370	25,28%	62.132	38,91%	43.585	27,30%	13.586	8,51%	159.673
TOTAL			340	263.534	%10,7	926.283	%37,6	891.708	%36,2	381.973	%15,5	2.463.799

Table 2. Deci Fee by Regions

Region	1 Deci Fee (₺)
1. Region	1,5
2. Region	1,8
3. Region	2,1
4. Region	2,5

Deci is a unit of measurement used by customers who receive cargo service and sellers who want to send their products to their customers. Deci calculation process is closely followed by sellers and customers who are especially interested in e-commerce. Deci is especially used by cargo companies to calculate the cargo cost of the product, the calculation is made quite easily if the right methods are used. Regardless of the shipping method, every carrier develops packaging strategies to maximize their revenue. It may be useful to use the deci calculation formula for products that are sent or received. Three important points should be noted when using the deci calculation formula:

1. The width of the package to be shipped
2. The size of the package to be shipped
3. Height of the package to be shipped

Deci refers to the total size of a package, deci calculation will become much easier once you have the three required measurements. If the width, height and height dimensions of the cargo are multiplied in centimeters and the result is divided by 3000, the decis of the package is obtained [6].

In the current operation structure, products are transported in partial. In this method, the expense information (cost) of this operation will be obtained by using the deci volumes in Table 1 and the deci costs in Table 2. When the expense situations for the current and alternative operation options are revealed, the most appropriate option can be determined with the decision tree structure. The alternatives to be used in the decision tree are as in Table

The complete shipment mentioned in Table 3 can also be named as FTL (Full Truck Load). FTL means full truck load. The concept of full truckload is used when the capacity of the truck or container is full and a single product or similar products of the company are carried at this capacity. FTL complete transport; It is used in almost every mode of transportation such as road, air, sea. This transportation, which is carried out by full filling of a truck on the road or the container on the ship on the sea route; It is a more cost-effective and easier method for every business line working in the transportation process. This system, which is also called full load transportation, has some advantages and disadvantages. It is important for the company to evaluate these advantages according to its own products and system and examine whether it is suitable for itself [7].

Table 3. Transportation alternatives and expressions

Alternatives	Expression
Alternative 1	Partial continuation of the operation
Alternative 2	Realization of 1 st and 4 th region operations with partial shipment, 2 nd and 3 rd region operations with complete shipment
Alternative 3	Performing the operation with complete shipment

Table 4 shows the costs per vehicle for the truck according to the dispatch regions from customer X. Because of its capacity advantage in intercity transportation, trucks are mostly preferred as a vehicle. The truck capacity is 25.000 deci, and it is also preferred for inter-country transportation from time to time due to the possibility of transporting large volumes of material in one go.

Table 4. Costs per vehicle by regions

Regions	Costs per Vehicle (₺)
1. Region	13.000
2. Region	17.000
3. Region	21.000
4. Region	22.250

The calculations for each alternative are as follows and the decision tree is as in Figure 1. Calculations for a simple decision tree image are also made below.

- Alternative 1 = 1. Region Deci Amount x 1. Region Deci Cost + 2. Region Deci Amount x 2. Region Deci Cost + 3. Region Deci Amount x 3. Region Deci Cost + 4. Region Deci Amount x 4. Region Deci Cost (1)

$$A1 = 263.534 \times 1,5 + 926.283 \times 1,8 + 891.708 \times 2,1 + 381.973 \times 2,5 = \mathbf{4.890.130 \text{ TL}}$$

- Alternative 2 = 1. Region Deci Amount x 1. Region Deci Cost + 4. Region Deci Amount x 4. Region Deci Cost + (2. Region Deci Amount / 25.000) x 2. Region Vehicle Cost + (3. Region Deci Amount / 25.000) x 3. Region Vehicle Cost (2)

$$A2 = 263.534 \times 1,5 + 381.973 \times 2,5 + (891.708 / 25.000) \times 21.000 + (926.283 / 25.000) \times 17.000 = \mathbf{2.729.140 \text{ TL}}$$

- Alternative 3 = (1. Region Deci Amount / 25.000) x 1. Region Vehicle Cost + (2. Region Deci Amount / 25.000) x 2. Region Vehicle Cost + (3. Region Deci Amount / 25.000) x 3. Region Vehicle Cost + (4. Region Deci Amount / 25.000) x 4. Region Vehicle Cost (3)

$$A3 = (263.534 / 25.000) \times 13.000 + (926.283 / 25.000) \times 17.000 + (891.708 / 25.000) \times 21.000 + (381.973 / 25.000) \times 22.500 = \mathbf{1.859.720 \text{ TL}}$$

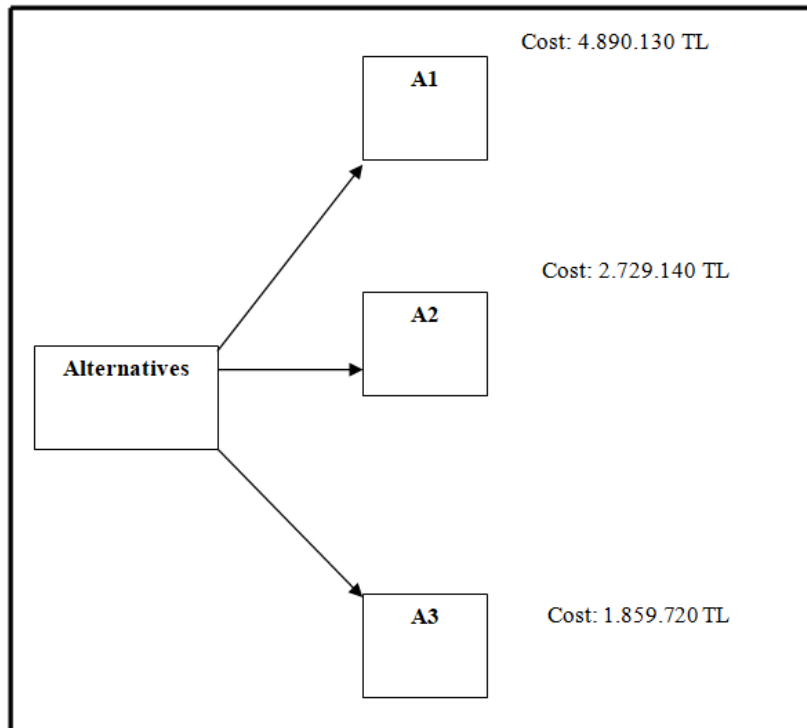

Figure 1: Decision tree

3. CONCLUSION

Due to the fact that the population in Turkey is concentrated in the Marmara region, many manufacturing companies are positioning their factories in these regions for the purposes of proximity to the market, ease of finding personnel and time-cost savings. In general, 3PL companies that provide B2B services also focus on the regions where their corporate customers are concentrated and place their facilities, personnel and transportation vehicles in these regions.

B2B, which is the abbreviation of business-to-business or frequently used English business-to-business phrase, is the name given to intercompany marketing or sales practices [8]. In order to provide better service to their customers, 3PL companies provide

services with storage facilities, customer-specific branches, large-sized distribution facilities and vehicle fleets in regions where their customers are concentrated and thus their shipment volumes increase.

In the 3PL company, where the study was carried out, a branch structure was designed for bulky customers, and the products received from the manufacturer are made suitable for transportation and then transferred to the transfer center on the Anatolian side of Istanbul by complete transportation. However, with the further growth of the said shipment volumes, the option of sending the products directly to the destination transfer center instead of transferring them to the transfer center on the Anatolian side with complete transportation has come to the fore.

Thus, the workload in the transfer center on the Anatolian side will decrease somewhat and the risk of damage to the products arising from unnecessary handling and cost will be eliminated. In order to test these options, the shipment volumes of a customer, whose name we did not give due to the confidentiality policy of the company named X, were examined for the January-November 2022 period. As a result of the investigations, a hybrid option was developed in which to continue the operation in the current order through the transfer center on the Anatolian side, to deliver direct complete transportation to the target regions and to apply these two methods together.

In order to evaluate the options, the costs per deci according to the dispatch region and the transportation costs by truck according to the dispatch region were obtained according to the data of that period and the cost of each option was calculated. As a result, the cost of the option named A3 is the lowest and the cost of the current operating structure is the highest. In the proposed option, it is more cost-effective to send all the products of the relevant customers to the destination transfer centers with complete transportation.

In the decision tree in Figure 1, there are 3 alternatives and their costs. Alternative 1 represents the current operating structure and a calculation has been made on the transportation costs per deci. The cost of this alternative, in which partial transportation is foreseen, was calculated by multiplying the deci amounts in Table 1 and the deci costs in Table 2. Alternative 2 is an alternative that envisages partial transportation of the first and fourth regions, and complete shipments of the second and third regions. The cost of the first and fourth zones was calculated by multiplying the deci amounts in Table 1 and the transportation charges per deci in Table 4. The cost of the second and third regions was calculated by dividing the deci amounts of the second and third regions in Table 1 by 25,000, which is the carrying capacity of a truck. Thus, it will be clear how many trucks will be needed. These numbers are multiplied by the truck transportation costs according to the regions in Table 4. Alternative 3 is an approach that requires all transportation to be done with complete vehicles. Accordingly, the deci capacity of a truck with 25,000 deci in Table 1 was divided by its deci capacity and the number of vehicles required for each region was revealed. These numbers were then multiplied by the vehicle costs according to the regions in Table 4.

Decision trees can be preferred in terms of providing easy solutions to many basic problems in logistics. The fact that it is both easy and promises a quick solution makes decision trees advantageous. As a matter of fact, most of the problems that arise in logistics operations and require decision-making are not overly complex and desired results can be achieved with easy methods.

However, it is obvious that more advanced mathematical models should be preferred in solving more complex problems. Decision making methods contain a series of mathematical models from static methods to advanced dynamic methods. As in our study, the basic decision-making methods are in a structure that will answer many basic problems in business life in general and in the logistics sector in particular, and their importance levels should not be ignored.

Declaration of Competing Interest

The author confirms that there is no known conflict of interest or common interest with any institution/organization or person.

References

- [1] Çancı, M, Erdal, M. *Loistics Management Freight Forwarder Handbook*, İstanbul: Utikad Publications; 2003.
- [2] Horoz Logistics, Horoz Blog, Access: 21.08.2023, <https://www.horoz.com.tr/tr/kurumsal/medya/blog/detail/tedarik-lojistik-nedir>
- [3] Kaya, S. C., Evaluation of risk factors in dangerous good logistics: Compressed natural gas sample, Bandırma Onyedü Eylül University, Social Science Institute, Master Thesis, 2022.
- [4] Borusan Logistics, What is partial transportation?, Access: 21.08.2023, <https://www.etasimacilik.com/blog/parsiyel-tasimacilik-nedir>
- [5] Güngörmez, H. *Transportation and Logistics Vocational Training Handbook*, Iğdır University Publications; 2022.
- [6] Horoz Logistics, Horoz Blog, Access: 21.08.2023, <https://www.horoz.com.tr/tr/kurumsal/medya/blog/detail/dec-nedir-nasil-hesaplanir>
- [7] Horoz Logistics, Horoz Blog, Access: 21.08.2023, <https://www.horoz.com.tr/tr/kurumsal/medya/blog/detail/ftl-komple-tasimacilik-nedir>
- [8] Wikipedia Free Encyclopedia, Business to business, Access: 21.08.2023, https://tr.wikipedia.org/wiki/%C4%B0C5%9Fletmeden_i%C5%9Fletmeye