

THE EURASIA  
PROCEEDINGS OF  
EDUCATIONAL &  
SOCIAL SCIENCES

**EPESS**

**VOLUME 28 IConSE CONFERENCE**

**e-ISSN: 2587-1730**

**ISBN: 978-605-72832-7-6**

**IConSE 2022: International Conference on Science and Education (IConSE)**

November 15 - 18, 2022

Antalya, Turkey

**Edited by:** Dr. Muhammad ZAYYAD (Chair) - Al-Qasemi Academic College of Education,  
Israel

©2022 Published by the ISRES Publishing

# IConSE 2022 NOVEMBER

Volume 28, Pages 1-91 (November 2022)

The Eurasia Proceedings of Educational and Social Sciences (EPESS)

e-ISSN: 2587-1730

©2022 Published by the ISRES Publishing

Address: Istanbul C. Cengaver S. No 2 Karatay/Konya/TURKEY

Website: [www.isres.org](http://www.isres.org)

Contact: [isrespublishing@gmail.com](mailto:isrespublishing@gmail.com)

Conference: IConSE 2022: International Conference on Science and Education (IConSE)

Conference website: <https://www.2022.iconse.net>

Dates: November 15 – 18, 2022

Location: Antalya, Turkey

Edited by: Muhammad ZAYYAD

## About Editor(s)

Dr. Muhammed Zayyad

Special Education, Al-Qasemi Academic College of Education, Israel

E-mail: [zayyadmm@qsm.ac.il](mailto:zayyadmm@qsm.ac.il)

## Language Editor(s)

Assoc. Prof. Dr. Kagan Buyukkarci

Department of English Language Education, Suleyman Demirel University, Turkey

E-mail: [kaganbuyukkarci@sdu.edu.tr](mailto:kaganbuyukkarci@sdu.edu.tr)

## CONFERENCE PRESIDENT

Dr. Muhammad ZAYYAD - Al-Qasemi Academic College of Education, Israel

## SCIENTIFIC BOARD

Ágnes Csiszárík-Kocsir - University of Óbuda, Hungary

Allan TARP - MATHeCADEMY, Denmark

Altay FIRAT - Near East University, Cyprus

Andrea DEBELJUH - University Juraj Dobrila of Pula, Croatia

Brahim FERDI - Bechar University, Algeria

Branislav POPOVIĆ - University of Kragujevac, Serbia

Chalavadi SULOCHANA - Gulbarga University, India

Dariga NURKESHEVA - Nazarbayev University, Kazakhstan

Elizabeth ADAMSON - Edinburgh Napier University, United Kingdom

Elizabeta Tomevska-Ilievska - Ss. Cyril and Methodius University, Macedonia

Farouq ALMEQDADI - Emirates College for Advanced Education (ECAE), U.A.E.

Fatima Dar - Oak Consulting, Pakistan

Gordana SAVIC - University of Belgrade, Serbia  
Henry David KATNIYON - Federal College of Education, Pankshin, Plateau state, Nigeria  
Hsin-Chih WU - National Taiwan Normal University, Taiwan  
János Varga - Óbuda University, Hungary  
Jessie BUSTILLOS - London Metropolitan University, United Kingdom  
Jin Su Jeong- University of Extremadura, Spain  
Milica PAVKOV HRVOJEVIĆ - University of Novi Sad, Serbia  
Mohammad Sarwar - Scialert, Dubai, United Arab Emirates  
Morteza BARIN - Farhangiyani University of Iran, Iran  
Muteb ALQAHTANI - Rutgers University, United States  
Ognyan B. MANOLOV - European Polytechnic University, Bulgaria  
Sanaa AL-DELAIFY - Mosul University, Iraq  
Shynar BAIMAGANBETOVA - Nazarbayev University, Kazakhstan  
Summer MOUALLEM - University of Central Lancashire, United Kingdom  
Tri Marhaeni PUDJI ASTUTI - Semarang State University, Indonesia

#### **ORGANIZING COMMITTEE**

Ágnes Csiszárk-Kocsir - University of Óbuda, Hungary  
Aliya MUSTAFINA - Nazarbayev University, Kazakhstan  
Arturo Tobias Calizon Jr.-University Of Perpetual Help System Dalta, Philippines  
Cemil AYDOĞDU - Hacettepe University, Turkey  
Danielle Gonçalves de Oliveira Prado-Federal Technological University of Paraná, Brazil  
Elizabeta Tomevska-Ilievska - Ss. Cyril and Methodius University, Macedonia  
Fatima Dar - Oak Consulting, Pakistan  
Halil SNOPE - South East European University, Macedonia  
Isabel Maria Allen-Agrupamento De Escolas Da Maia, Portugal  
Jaya Bishnu Pradhan-Tribhuvan University, Mahendra Ratna Campus, Nepal  
Jin Su Jeong- University of Extremadura, Spain  
Mariusz JAWORSKI - Medical University of Warsaw, Poland  
Mary M. CAPRARO - Texas A&M University, U.S.A.  
Mehmet OZASLAN - Gaziantep University, Turkey  
Mohammad SARWAR - Scialert, Dubai, United Arab Emirates  
Muhammad ZAYYAD - Al-Qasemi Academic College of Education  
Natela DOGHONADZE - International Black Sea University, Georgia  
Ossi AUTIO - University of Helsinki, Finland  
S. Ahmet KIRAY - Necmettin Erbakan University, Turkey  
Silvia MORARU - National High School Bucharest, Romania

#### **Editorial Policies**

ISRES Publishing follows the steps below in the proceedings book publishing process.

In the first stage, the papers sent to the conferences organized by ISRES are subject to editorial oversight. In the second stage, the papers that pass the first step are reviewed by at least two international field experts in the conference committee in terms of suitability for the content and subject area. In the third stage, it is reviewed by at least one member of the organizing committee for the suitability of references. In the fourth step, the language editor reviews the language for clarity.

### Review Process

Abstracts and full-text reports uploaded to the conference system undergo a review procedure. Authors will be notified of the application results in three weeks. Submitted abstracts will be evaluated on the basis of abstracts/proposals. The conference system allows you to submit the full text if your abstract is accepted. Please upload the abstract of your article to the conference system and wait for the results of the evaluation. If your abstract is accepted, you can upload your full text. Your full text will then be sent to at least two reviewers for review.

The conference has a double-blind peer-review process.

Any paper submitted for the conference is reviewed by at least two international reviewers with expertise in the relevant subject area. Based on the reviewers' comments, papers are accepted, rejected or accepted with revision. If the comments are not addressed well in the improved paper, then the paper is sent back to the authors to make further revisions. The accepted papers are formatted by the conference for publication in the proceedings.

### Aims & Scope

Traditionally, it is seen that change and transformation in the field of social sciences and education takes a little more time compared to fields such as health, technology and engineering. However, this situation seems to have started to change with the Covid-19 epidemic disease. It is expected that changes will occur in human and social behavior during and after the Covid 19 epidemic disease. These changes have started to show themselves in many fields related to social sciences, especially education, psychology, sociology and economy. For this reason, this conference focused on the changes and innovations in the field of social sciences that started with Covid 19. However, the organizing committee also recognizes the value of traditional knowledge in the social sciences and education. For this reason, the conference is also open to traditional studies in the field of social sciences and education.

The aim of the conference is to bring together researchers and administrators from different countries, and to discuss theoretical and practical issues in all fields of social sciences and education. At the same time, it is aimed to enable the conference participants to share the changes and developments in the field of social sciences with their colleagues.

Articles: 1-10

### CONTENTS

The Influence of Indirect Corrective Feedback on the Linguistic Accuracy of Adjectival Clauses in an EFL Context / Pages: 1-10

*Rasheed AL-JARRAH, Sayyah AL-AHMAD*

Oral Proficiency Interview (OPI) for the Assessment of Speaking / Pages: 11-18

*Ahmet ONAL*

Assemblage Art's Visual Stimulators Based on the Recycling of Musical Instruments as an Experimental Approach to Design / Pages: 19-35

*Nashwa HASSAN*

Opinions of Novice Mathematics Teachers on Improving the Teacher Induction Programme / Pages: 36-42

*Tuğba BARAN-KAYA, Sedef CELIK-DEMIRCI*

The Usefulness of Activity Evaluation and Feedback Tool (AEFT) and Its Potential to Evaluate and Give Feedback to Practitioners / Pages: 43-48

*Ali BOZKURT, Mehmet Fatih OZMANTAR*

Scientist Images of Secondary School Students / Pages: 49-53

*Sule EGUZ*

The Efficiency of Visual-Spatial Abilities (Memory Processes) Training through Multimedia Simulation for Soccer Strikers / Pages: 54-61

*Lorabi RADHOUANE, Belaid AKIL ABDELKADIR*

Comparison of Individuals' Computer Skills with Multi-Criteria Decision Making Methods: Turkey-European Countries / Pages: 62-68

*Orhan ECEMIS, Aysun COSKUN*

The Investigation of Future Expectations of Individuals Graduated from the Department of Child Development / Pages: 69-82

*Ibrahim BENEK*

An Overview Analysis of Debt Financing for Hungarian Enterprises and the Impact of Economic Crises / Pages: 83-91

*Agnes CSISZARIK-KOCSIR*

The Eurasia Proceedings of Educational & Social Sciences (EPESS), 2022

Volume 28, Pages 1-10

**IConSE 2022: International Conference on Science and Education**

## **The Influence of Indirect Corrective Feedback on the Linguistic Accuracy of Adjectival Clauses in an EFL Context**

**Rasheed AL-JARRAH**  
Yarmouk University

**Sayyah AL-AHMAD**  
Yarmouk University

**Abstract:** The goal of this research was to find out which corrective feedback technique would be most effective in some EFL context. Concisely, we wanted to find out whether the feedback techniques commonly used in this context (namely indirect feedback and oral meta-linguistic explanation) were structure-, learner-, and task-dependent. We chose to experiment with all the functional uses of one linguistic structure, namely adjective clauses. Whereas the experimental group received two types of feedback (indirect coded written corrective feedback and oral meta-linguistic feedback), the control group received no corrective feedback at all on the targeted features. Findings showed that the experimental group's linguistic accuracy in using adjectival clauses improved far better than that of the control group. However, this improvement, quite expectedly, declined gradually over the course of time; hence the experimental group's linguistic accuracy was a little better on the immediate posttest than on the delayed post-test. Our argument was that a combination of indirect feedback and meta-linguistic explanation would be rewarding for adult learners with low-proficiency levels probably because such feedback techniques require them to exert maximum cognitive, especially when getting engaged in a problem-solving process.

**Keywords:** Adjective, Clauses, Indirect, Corrective, Feedback

### **Introduction**

A number of corrective feedback techniques are always available to writing teachers. Feedback can be positive or negative, written or oral, direct or indirect, explicit or implicit, focused or unfocused, linguistic or meta-linguistic, etc. One major concern for almost all writing teachers is to find out the technique that is effective the most for each linguistic structure and for each group of learners in a given context. Researchers have been conducting field investigations to find out the relative effectiveness of these techniques whether independently or in combination. For example, negative, explicit, direct feedback was found to be more appropriate for student writers of low proficiency level (Ferris & Hedgcock, 2005; Ellis, 2009), but oral meta-linguistic explanations, though more time and effort consuming on the part of the instructor, may be more rewarding on the long run for learners of high proficiency levels (Sheen, 2010a, 2010b). Ferris (2002) have shown that indirect feedback options could lead to long-term learning by getting the learners engaged in a problem-solving process of detecting and correcting for themselves the errors they make.

However, a number of renowned researchers have challenged that the gains obtained from the provision of corrective feedback can stand the test of time. Classic work on feedback provision (Semke, 1984; Fathman & Whalley, 1990; Kepner, 1991; Sheppard, 1992) claimed that corrective feedback was only momentarily constructive. Truscott (1996) and his advocates (Polio et al., 1998; Fazio, 2001; Chandler, 2003; Truscott and Hsu, 2008) did not only cast doubt on the effectiveness of feedback provision, but they also dared to claim that it could be harmful. Researchers who have been trying to conciliate between the two sides involved in the

- This is an Open Access article distributed under the terms of the Creative Commons Attribution-Noncommercial 4.0 Unported License, permitting all non-commercial use, distribution, and reproduction in any medium, provided the original work is properly cited.

- Selection and peer-review under responsibility of the Organizing Committee of the Conference

© 2022 Published by ISRES Publishing: [www.isres.org](http://www.isres.org)

debate would argue that the positive effects of the feedback could be distorted in part (or on whole) by "inconsistencies in research design" (Ferris, 2004; Guénette, 2007) and by the confusion in using the technical jargon when conducting research in this area (Al-Jarrah & Al-Ahmad, 2013). Probably for all these, Guénette, (2007) stressed that the appropriate feedback should be "given at the right time and in the proper context" (p. 11).

Therefore, for a better understanding of feedback provision, attention needs to be turned to the writing practices in general and feedback provision techniques in particular in diverse sociolinguistic contexts outside, to use Leki's (2001) terms, 'the Inner Circle' such as the UK and the USA and more prominent nations in East Asia such as China and Japan and Eastern Europe like Poland, Turkey, and Ukraine. Hence, the socio-educational challenges that EFL teachers need to cope with in order to promote teaching writing at different educational levels are surely different in less prominent nations. A considerable portion of research (Leki, 2001; You, 2004a; Reichelt, 2005, 2009; Cimasko, et al., 2009) has shown how a host of factors (internal and external) could shape foreign language writing instructions and feedback practices in different international settings.

In this research endeavor, we try to bring evidence that contributes to the debate on the feedback technique that is most effective in a given context from one socio-cultural context that is still under-researched. Concisely, we chose to experiment in the \_\_\_\_ EFL context by providing the students in the experimental group with a combination of indirect feedback and some oral meta-linguistic explanation on all the functional uses of one linguistic structure, namely adjective clauses. One main reason why we chose to experiment with such types of feedback was that they are the most common error feedback techniques used in this learning environment. To illustrate, the practical constraints that teachers face (for example, large classes, heavy 15 workloads, and tight teaching schedules) make these feedback techniques most common in this learning environment (Al-Jarrah & Al-Ahmad, 2013). Another less driving force for our choice was that very few studies, to the best of our knowledge, have compared the effects of such feedback types on promoting acquisition of specific grammatical structures such as the adjectival clauses.

## **Literature Review**

A considerable portion of research in second language writing instruction (Lalande, 1982; Robb et al., 1986; Ferris & Roberts, 2001; Sheen, 2007; Sheen et al., 2009; Bitchener, et al., 2005; Bitchener, 2008; Bitchener & Knoch, 2009; Bitchener & Knoch, 2010a, 2010b) has been devoted to finding out the feedback techniques that should be used in different sociocultural contexts. Those researchers' main concern was to settle the dispute about which error correction technique is most effective for a group of learners in some socio-cultural contexts. To them, the problem then lies not only in what to correct but also on how to correct (Cohen & Robbins, 1976; Hyland, 2003, Bitchener et al., 2005); hence treatment of learners' errors is considered by Guénette (2007) "the crux of the matter" (p. 13). A quick survey of the related literature would immediately reveal that the findings of research in this area are still conflicting. For example, Robb, et al. (1986) and Ferris and Roberts (2001) who experimented with different types of indirect feedback found that all types of indirect feedback had relatively equal impact on improving learners' writing capabilities. Bruton (2009), on the other hand, contended, "there is no guarantee that the students' revisions will be correct if only indirect feedback was provided" (p. 30). Lalande (1982), Frantzen (1995), Ferris, et al. (2000), Ferris and Hedgcock (2005) argued that indirect feedback could be more effective than direct feedback. Chandler (2003), on the other hand, found evidence to the contrary. Still, Robb, et al. (1986), Semke (1984), and Ferris and Roberts (2001) found no significant differences between the two correction methods. In one of his experiments, Chandler (2003) found that all correction methods (including coded and uncoded) were relatively equally effective.

The effect of meta-linguistic feedback on improving students' writing performance was investigated in its own right and in combination with other types of feedback. For example, Lyster (2004) claimed that meta-linguistic feedback was more effective than recasts. Likewise, Sheen (2007) showed that oral meta-linguistic feedback was more effective than oral recasts. Concisely, he found that it was meta-linguistic corrective feedback (not oral recasts) that helped learners improve more on their use of English articles. This was, the argument goes, because learners put more cognitive effort when entreated to process information in this way. However, Sheen (2010) argued that both oral meta-linguistics and written meta-linguistic feedback were equally effective in facilitating the acquisition of English articles. Likewise, Ellis et al. (2006) found that meta-linguistic feedback (explicit feedback) was more effective than recasts (implicit feedback) in acquiring regular past tense.

When combined with other feedback techniques, the story was a bit different. For instance, Sheen (2007) compared some learners' performances after providing them with direct feedback alone and after providing

them with direct feedback in combination with some meta-linguistic explanation. She found that the combination approach was far more rewarding because the meta-linguistic feedback, she argued, triggered a deeper level of cognitive processing on the part of the learners (Sheen, 2007, p. 260). Li (2010) and Lyster and Saito (2010) reported higher effect size for explicit feedback type (e.g. explicit correction and meta-linguistic feedback).

What is more intriguing about research in this area is that the relative effect of the feedback technique is structure-specific, i.e. one type of feedback that could be effective for correcting one specific structure may not be equally effective for another. Bitchener et al. (2005), for instance, who stressed that the type of feedback was not equally effective for specific structures, found that those who received direct error correction and oral meta-linguistic explanation outperformed those who did not for the past simple tense and the definite article, but they failed to do so for prepositions. The only explanation that Bitchener and his contingent could provide for this thought-provoking finding was that the past tense and the definite article structures, their argument goes, are more “rule-based” than prepositional forms. However, Bitchener et al. (2005) never told the readers why prepositional forms were more idiosyncratic (Al-Jarrah & Al-Ahmad, 2012). Interestingly enough, Bitchener and Knoch (2009) found no differential effects for the different types of direct feedback on the linguistic accuracy of low intermediate ESL learners’ writing for two functional uses of the English article system (referential indefinite *a* and referential definite *the*). What is worth noting here is that Bitchener et al. (2005) and Bitchener and Knoch (2009) used the unfocused approach to feedback provision in that they chose to experiment with very few functional uses of each structure (probably the most salient functions). The question that arises immediately is: Did they adopt the focused approach to experiment with all of the functional uses of each structure, wouldn’t the definite article structures, for example, have been no less idiosyncratic? What concerns us most here is this: Would the effect of the feedback technique have then been structure-dependent?

To test this assumption, we used here the focused approach by providing feedback on all functional uses of one specific structure (namely adjective clauses) using a combination of indirect feedback and some oral meta-linguistic explanation. The choice of this approach will be defended in the methodology section below.

## Method

### Research Questions

The study was intended to address the following questions:

1. Were there any statistical differences at ( $\alpha=0.05$ ) in the means of the students’ performance in identifying and correcting errors in adjective clauses between the pretest and delayed posttest taken by the experimental and control groups due to provision of feedback (feedback/ no feedback)?
2. Were there any statistical differences at ( $\alpha=0.05$ ) in the means of the use of adjective clauses by the experimental group students on the pretest, immediate test, and posttest due to the feedback provided?

### Participants and Setting

Forty-three EFL second-year English majors taking a required writing course participated in this study over a semester of 16 credit hours. The subjects were divided into two groups (25 in the experimental group and 18 in the control group). By making reference to the Common European Framework, the researchers could tell that the subjects’ English language proficiency was rated as low-intermediate, judged to be homogeneous in a number of ways, including their previous language instruction in English as a foreign language and their approximately similar scores in the high school leaving examination which is an indispensable condition for their admission to the English program. As for their writing tasks, the participants had to meet in class three times a week.

During each meeting which lasted for 50 minutes, the experimental group received two types of feedback on the targeted structure: indirect coded written corrective feedback over the targeted (e.g. *rel.* for missing a relative pronoun) and oral meta-linguistic feedback. The control group, on the other hand, received no corrective feedback at all, but for ethical considerations, they were provided with general content feedback on the quality of their work.



The ‘adjectival clause’ was the targeted structure. This structure was chosen for at least two reasons. First, the researchers noticed that students in this learning environment made errors in using adjectival clauses when speaking in English and when composing in English. Second, the findings of recent written corrective feedback studies (Bitchener, 2008; Bitchener & Knoch, 2008a, 2008b, 2009, 2010; Ellis, et al., 2008; Sheen, 2007a; Sheen, et al., 2009) and oral corrective feedback studies (Carroll & Swain, 1993; Ellis et al, 2006; Muranoi (2000) showed that targeting a single specific linguistic form was probably the optimal approach when conducting a research like ours. However, it should be noted that previous research made a distinction between the focused approach and the unfocused approach to corrective feedback provision. Although the terms (focused and unfocused CF) were operationalized in different ways by different researchers, they traditionally differ in the number of errors that were targeted by the feedback. In a nutshell, whereas the unfocused approach targets the errors made by the learners on more than one structure simultaneously, the focused approach targets very few functional uses of some specific structure(s) at a given time. To illustrate, whereas some researchers selected one or two error types of some specific structure (e.g. the indefinite article for first mention and the definite article for subsequent mention), others experimented with a whole range of error types of seemingly unrelated structures (e.g. simple past tense, prepositions, articles). In our view, there were at least two major flaws in this approach. On the one hand, some researchers were fastidious in their choice of the functional uses for each specific target structure. On the other hand, some researchers dealt with the learners’ errors as if they were unrelated lists of grammatical features. For example, although Sheen et al. (2009) chose to target articles, past tense, and prepositions, they chose to provide corrective feedback on referential indefinite *a* and referential definite *the*, and for the past tense, they choose copula *be*, regular past tense *-ed* and irregular past tense, and for prepositions, they targeted only temporal and locative prepositions (namely at, in, on).

In the current study, we chose to use the focused approach which, following author (Al-Jarrah, 2016), was operationalized to refer to *all* the functional uses of *one* specific structure (namely adjectival clauses). The motivation for our choice was that the effect of the feedback should not only be noticeable in the improved accuracy rate on the targeted structure only, but also on a broader range of grammatical structures (Sheen et al., 2009: 259). What this basically means is that language acquisition involves subtle processes that require more than just a collection of discrete items. Roughly equivalent to Sheppard’s (1992) holistic comments, global approaches towards corrective feedback would establish a meaningful whole.

### **Data Collection Instruments**

Three tests were used to collect data for this study. A pretest which took place at the beginning of the semester, and an immediate posttest, which took place after the participants had received oral meta-linguistic explanation and finally a delayed posttest, which took place two weeks before the end of the semester. The experimental group and control group took both the pretest and delayed posttest, but the control group did not take the immediate posttest. The pretest and posttest consisted of twenty-five statements. Some of these statements had errors in using the adjective clause (e.g. a missing relative pronoun, an incorrect form of relative pronoun, or a misplaced relative pronoun, etc.), and others had adjective clauses correctly used. The participants were asked to find out whether these statements were correct or incorrect. If incorrect, the participants were asked to identify the errors and correct them. In the immediate posttest, only the experimental group was asked to write two coherent and cohesive untimed five-paragraph writing tasks with two drafts each on two different topics at two different times. In the delayed posttest, the two groups were given the same test and were asked to do what they did in the pretest.

### **Treatment**

Before the pretest, the participants were briefed on the study and were asked to sign a consent form if they were willing to participate in the study. On the first week of class, the pretest was administered for both the experimental group and the control group. After the pretest, the experimental group was given half an hour oral meta-linguistic explanation in which the researcher explained the rules that govern the use of the adjectival clauses in English as illustrated in Deborah Phillips’ Longman Preparation Course for the TOEFL. If needed, extra examples were given and discussed with students. A short controlled practice exercise consisting of 10 sentences on adjective clauses was administered shortly afterwards. Some of these sentences were correct and others had a problem in the structure of the adjective clauses. The students were asked to indicate whether the statements were correct or incorrect, and if incorrect they were asked to correct them. They were given 10 minutes to complete the task. On the other hand, the control group received no such feedback on the targeted feature.

Before starting the writing process, the participants in the experimental group were trained on process writing, the approach which consists of three stages of writing, namely pre-writing, writing, and post writing. For almost three weeks, the students were trained on how to write coherent, cohesive, and unified multiple drafts of well-organized essays. Then, the experimental group underwent an immediate posttest in which the participants were asked to write two five-paragraph essays, two drafts each. The writing task was started in the class and then completed at home. Ten days after being exposed to the oral meta-linguistic explanation, the student writers were given 3-4 days to complete the assignments. One of the researchers, as a writing instructor, provided written corrective feedback on the students' first draft in the form of symbols above the targeted error.

It was expected that errors might take place in at least three ways: (1) the relative pronoun is misplaced; (2) it is not used when it is necessary to be used; (3) and/or the inappropriate form of the relative pronoun is used (e.g. the subject pronoun is used instead of the object pronoun and vice versa). The students were asked to revise them in light of the comments provided on their writing tasks. After students handed in back their first draft, they were given enough time to revise the corrections made on their assignments and were given the opportunity to inquire about the errors they committed. The researcher instructor responded to the students' inquiries and drew their attention mainly to the (in)correct use of the linguistic structures (adjective clauses) they used in their first drafts and instructed them on how to avoid such errors when submitting their revised drafts of the assignment for scoring purposes. To motivate students to take the revision process seriously, the first draft was corrected and given nearly half of the total grade. Then, the students were asked to write the second draft and hand it back in in two days' time. This draft received the same treatment the first draft had received. Based on the student writer's positive use of the feedback provided on their first drafts, they were given the second half of the score. Both the experimental and control group were subjected to a delayed posttest two weeks before the end of the semester. The control group's writing assignments were not subjected to any formal instruction on the targeted structure but received instead some general feedback. The researcher instructor did not tell the participants that there would be a posttest lest they revise the corrections the instructor made previously.

### **Data Analysis**

One of the researchers, an experienced writing instructor, made error identification and correction on the students' texts. Another round of scoring took place a month later by the same researcher who scored the essays again to examine the reliability of the writing test. The essays were also scored by another experienced writing instructor. The inter-rater reliability was 92%. To account for descriptive and referential statistics, ANCOVA and ANOVA for repeated measures, and Bonferroni tests were implemented using Statistical Package for the Social 19 Sciences (SPSS).

### **Findings**

In this section, we try to report the findings gathered from the field on the two questions of the study.

R. Q. 1. Were there any statistical differences at ( $\alpha=0.05$ ) in the means of the students' performance in identifying and correcting errors in adjective clauses between the pretest and delayed posttest taken by experimental and control groups due to provision of feedback (feedback/ no feedback)?

To answer this question, means and standard deviations of the students' performance in identifying and correcting errors in the use of adjectival clauses on the pretest and delayed posttest were calculated, as shown in Table 1.

Table 1. Means and standard deviations of the students' performance in identifying and correcting errors in the use of adjectival clauses in the pretest and delayed posttest

Feedback provision	N	Errors in the use of adjectival clauses identified & corrected (Pretest)		Errors in the use of adjectival clauses identified & corrected (Delayed Posttest)	
		Mean*	Std. Dev.	Mean*	Std. Dev.
No feedback (Control group)	18	48.22	19.95	45.78	19.41
Feedback (Experimental)	25	32.96	11.15	61.76	14.33

Table 1 demonstrates that there were observed differences in the means of the students' performance in identifying and correcting errors in the use of adjectival clauses on the posttest due to the provision of feedback. To verify whether these observed differences were significant, the ANCOVA test was used, as shown in Table 2.

Table 2. ANCOVA test results of differences between the means of the two posttests

Source of Variance	Sum of Squares	df	Mean Square	F	Sig.	Partial $\eta^2$
<i>Feedback provision</i>	6429.92	1	6429.92	52.41*	0.00	0.5671
<i>Error</i>	6740.94	1	6740.94	54.94*	0.00	0.5787
<i>Total</i>	4907.75	40	122.69			
	14010.79	42				

\*Errors in the use of adjectival clauses identified & corrected (Covariate)

Table 2 shows that there was a statistically significant difference at ( $\alpha = 0.05$ ) between the means of the experimental and control groups posttests in identifying and correcting errors in the use of the adjectival clauses attributed to the type of feedback provided. To identify which group this significant difference was in favor of, the adjusted means and standard errors of the delayed posttest were calculated, as illustrated in Table 3 below.

Table 3. The adjusted means and standard errors of the delayed posttests of control and experimental groups

Group	Adj.	Std.	95% Confidence Interval	
	Mean	Error	Lower Bound	Upper Bound
Control	38.57	2.79	32.93	44.22
Experimental	66.95	2.33	62.24	71.65

Accordingly, we notice that the significant difference was in favor of the experimental group which received a combination of indirect coded feedback and meta-linguistic explanation compared with the control group which did not receive such feedback. This means that the experimental group's linguistic accuracy in using adjectival clauses improved significantly, while that of the control group did not.

R. Q. 2. Were there any statistical differences at ( $\alpha = 0.05$ ) between the means of the pretest, immediate posttest, and delayed posttest regarding the use of adjective clauses by the experimental group students?

To answer this question, means and standard deviations of the students' performance on the pretest, immediate test, and delayed posttest regarding the use of adjective clauses were calculated, as shown in Table 4.

Table 4. Means and standard deviations of students' performance on the pretest, immediate test, and delayed posttest

Measurement	N	Mean	Std. Dev.
Pretest	25	32.96	11.15
Immediate Posttest	25	95.10	9.14
Delayed Posttest	25	61.76	14.33

Table 4 demonstrates that there were differences in the means of the use of adjectival clauses on the pretest, immediate test, and delayed posttest by the students in the experimental group who received a combination of indirect coded corrective feedback and meta-linguistic explanation. To verify whether these observed differences were significant, ANOVA of Repeated Measures test was used, as displayed in Table 5.

Table 5. ANOVA of repeated measures of the means of the students' performance on the pretest, immediate posttest, and delayed posttest due to provision of feedback

Source of Variance	Sum of Squares	df	Mean Square	F	Sig.	Partial $\eta^2$
Between Groups	48357.58	2	24178.79	214.97	0.00	0.8996
Within Groups	5398.92	48	112.48			
Total	4522.87	24	188.45			

\*Tests of within-subjects effects (sphericity assumed; Mauchly's  $W=0.95$ , Approx.  $\chi^2=1.19$ ,  $df=2$ ,  $Sig.=0.55$ )

The figures in Table 5 show that there were statistically significant differences at ( $\alpha = 0.05$ ) in the means of the students' performance on the immediate posttest in using the adjectival clauses by students who received

indirect coded corrective feedback and oral meta-linguistic explanation. To identify which of the three tests the significance was geared to, Bonferroni test for post hoc was implemented, as shown in Table 6.

Table 6. Bonferroni test of means of students' use of adjectival clauses on the pretest, immediate test, and posttest

Measurement		Pretest	Posttest
[Bonferroni]	Adj. Mean	32.96	61.76
Delayed Posttest	61.76	28.80*	
Immediate posttest	95.10	62.14*	33.34*

We can say that the significant differences were in favor of: first immediate posttest in comparison with both the pretest and the delayed posttest respectively and second the delayed posttest compared with the pretest. What this means is that the students in the experimental group who received indirect coded corrective feedback and meta-linguistic explanation were much far better in improving their linguistic accuracy in the use of the adjectival clauses on the immediate posttest than on the delayed posttest. Additionally, but to a lesser extent, the experimental group students were better off in improving their linguistic accuracy on the delayed posttest than on the pretest. Comparing students' performance on the immediate with that on the delayed posttest, we can say that the students' linguistic accuracy improved much better on the immediate posttest than on the delayed posttest. This indicates that the students, to a lesser extent, were able to retain some of their linguistic accuracy improvement in the delayed posttest overtime, but not as much as it was in the immediate posttest.

## Discussion

Writing instructors in EFL/ESL context have been trying to find out which feedback correction technique would be most effective with the least processing effort on the part of the writing teacher. To lend those teachers a helping hand, researchers have been experimenting with all possible alternatives to find out which option is less costly and yet most rewarding. But the question that arises immediately here is: Do we really want the learners to gain the most with the least processing effort on their part? In other words, even if we agree that we want to reduce the effort put forth by the instructor, do we really want to reduce the effort exerted by the learners themselves? Not at all. We want the learners to exert maximum cognitive effort that is needed to process each piece of information provided by the instructor. For this, we chose to experiment with the feedback strategies that stimulate this individual mental processing behavior on the part of the learner. In this research, we tried to find out how adult learners (especially in EFL contexts) picked out what was relevant for them and process it productively. As we do not want to spoon-feed the learner, we can make sure that the gains obtained from the provision of corrective feedback can stand the test of time (Ashwell, 2000; Semke, 1984; Kepner, 1991). The question arises here as to how can we tell that some feedback technique(s) would be more rewarding in the long run?

Some previous research found that direct feedback techniques were more appropriate for student writers of low proficiency level (e.g. Ferris & Roberts, 2001; Ferris & Hedgcock, 2005; Ellis, 2009). The problem of these studies, we argue, was that they made no recourse to different age groups of learners. In this research, we brought some evidence that would cast doubt on such previous research findings. Concisely, we found that indirect feedback was more rewarding for learners with low-proficiency levels if they were mature learners.

Probably unlike young learners, adult learners could better work out the indirect feedback on their own. Therefore, we could argue that the division between direct and indirect feedback does not have to do with the level of proficiency but, more importantly, with the level of maturity. What this basically means is that the number of gains is divided by the effort invested to generate them. For young children, you would probably choose the approach which yield greater learning effects and, in the meantime, require less processing cognitive effort on their part. But this is not necessarily the case for adult learners.

As learners keep generating effective inferences while learning, error correction becomes part of the learner's thinking process. Once it becomes a cognitive activity, error correction cannot be comprehended apart from the social context where it takes place. For this, extraneous variables such as maturation of the population and the strategy of avoidance that some learners use cannot be marginalized when choosing the feedback strategy in some EFL context. Probably for this, research findings have shown how oral meta-linguistic explanations, though more time and effort consuming on the part of the instructor, may be more rewarding on the long run for learners of high proficiency levels (Ellis et al, 2006; Sheen, 2007; Sheen, 2010). Renowned researchers (Ferris, 2002.) would agree that both meta-linguistic explanations and indirect feedback options could lead to long-term

learning by getting the learners engaged in a problem-solving process of detecting and correcting the errors they make for themselves. Therefore, our findings substantiate a sizable portion of serious previous research. For example, although Ferris (2002) reported that direct error correction led to more correct revisions (88%) than indirect error feedback (77%), the story was a little different over the course of time. It was noted that learners who received indirect feedback reduced their error frequency ratios substantially more than those who received direct feedback. What seems to us most natural was that the gains of these approaches were more perceptible in the immediate post-test than on the delayed post-test.

This is probably so because adult learners are more likely to have semantic, not episodic, memories; hence their long-term memory is more likely to store abstract concepts and rules (a claim that has been subject to considerable amount of research in information processing, information retrieval and the workings of memory in human psychology). It is true that extra linguistic factors such as motivation, attention, interference and individual cognitive capabilities could all influence learners' retention, but the fact of the matter is that the age of the learners continues to be an independent decisive factor in the learning process. For this, the feedback strategies which proved to be effective for young EFL learners in primary and secondary schools may not be as effective for university students.

## Conclusion

All in all, in this research, we tried to bring evidence to writing teachers that the optimal types of corrective feedback (or combinations of different types) in EFL learning environments are the ones which cause the learners to exert maximum mental processing especially if they are adult learners. In simple terms, instead of providing explicit corrections, teachers should draw the attention of mature learners to their writing problems and let them resolve these problems on their own. For this, indirect feedback and metalinguistic explanation on all the functional uses of one structure should, we believe, be the viable options for the writing teacher at some point in time.

## Scientific Ethics Declaration

The authors declare that the scientific ethical and legal responsibility of this article published in EPSS journal belongs to the authors.

## Acknowledgements

\* This article was presented as an oral presentation at the International Conference on Science and Education ([www.iconse.net](http://www.iconse.net)) held in Antalya/Turkey on November 15-18, 2022

## References

- Al-Jarrah, R. S. (2016). A suggested model of corrective feedback provision. *Ampersand*, 3, 98-107.
- Al-Jarrah, R., & Al-Ahmad, S. (2012). An optimality-theoretic account of corrective feedback in process writing. *Asian EFL Journal*, 14(3), 10-40
- Al-Jarrah, R. S., & Al-Ahmad, S. (2013). Writing instruction in Jordan: Past, present, and future trends. *System*, 41(1), 84-94.
- Ashwell, T. (2000). Patterns of teacher response to student writing in a multiple-draft composition classroom: Is content feedback followed by form feedback the best method? *Journal of Second Language Writing* 9(3), 227-258.
- Bitchener, J.(2008). Evidence in support of written corrective feedback. *Journal of Second Language Writing* 17(2), 102-118.
- Bitchener, J., & Knoch, U. (2008a). The value of written corrective feedback for migrant and international students. *Language Teaching Research Journal*, 12(3), 409-431.
- Bitchener, J., & Knoch, U. (2008b). The value of a focused approach to written corrective feedback. *ELT Journal*, 63(3), 204-211.
- Bitchener, J., & Knoch, U. (2009). The value of a focused approach to written corrective feedback. *ELT Journal* 63(3), 204-211.

- Bitchener, J., & Knoch, U. (2010a). The contribution of written corrective feedback to language development: a ten month investigation. *Applied Linguistics* 31(2), 193-214.
- Bitchener, J., & Knoch, U. (2010b). Raising the linguistic accuracy level of advanced L2 writers with written corrective feedback. *Journal of Second Language Writing* 19(4), 207-217.
- Bitchener, J., Young, S., & Cameron, D. (2005). The effect of different types of corrective feedback on ESL student writing. *Journal of Second Language Writing* 14(3), 227-258.
- Bruton, A. (2009). Designing research into the effect of error correction in L2 writing: not so straightforward. *Journal of Second Language Writing* 18(2), 136-140.
- Carroll, S., & Swain, M. (1993). Explicit and implicit negative feedback. An empirical study of the learning of linguistic generalization. *Studies in Second Language Acquisition*, 15, 357-386.
- Chandler, J. (2003). The efficacy of various kinds of error feedback for improvement in the accuracy and fluency of L2 student writing. *Journal of Second Language Writing*, 12, 267-296.
- Cimasko, T., Reichelt, M., Im, J., & Arik, B. (2009). Principles and practices in foreign language writing instruction: the 2008 symposium on second language writing. *Journal of Second Language Writing* 18 (3), 209-213.
- Cohen, A., & Robins. M. (1976). Toward assessing interlanguage performance: The relationship between selected errors, learners' characters, and learners' explanations. *Language Learning*, 26, 45-66.
- Ellis, R. (2009). Corrective feedback and teacher development. *L2 Journal* 1(1), 3-18.
- Ellis, R., Loewen, S., & Erlam, R. (2006). Implicit and explicit corrective feedback and the acquisition of L2 grammar. *Studies in Second Language Acquisition*, 28, 339-368.
- Ellis, R., Sheen, Y., Murakami, M., & Takashima, H. (2008). The effects of focused and unfocused written corrective feedback in an English as a foreign language context. *System* 36(3), 353-371.
- Fathman, A., & Whalley, E. (1990). Teacher response to student writing: Focus on form versus content. In B. Kroll (Ed.), *Second language writing: Research insights for the classroom* (pp. 178-190). Cambridge: Cambridge University Press.
- Fazio, L. (2001). 'The effect of corrections and commentaries on the journal writing accuracy of minority- and majority-language students'. *Journal of Second Language Writing*, 10, 235-49.
- Ferris, D. R. (2002). *Treatment of error in second language student writing*. Ann Arbor: University of Michigan Press.
- Ferris, D. R. (2004). The "Grammar Correction" debate in L2 writing: Where are we, and where do we go from here? (and what do we do in the meantime...?). *Journal of Second Language Writing*, 13, 49-62.
- Ferris D., Chaney S., Komura, K., Roberts, B., & McKee S. (2000). *Perspectives, problems, and practices in treating written error*. Colloquium presented at TESOL Convention, Vancouver, Bc.
- Ferris, D. R., & Roberts, B. (2001). Error feedback in L2 writing classes: How explicit does it need to be? *Journal of Second Language Writing*, 10, 161-184.
- Ferris, D. & J. Hedgcock (2005). *Teaching ESL composition: Purpose, process, and practice*. Mahwah, NJ: Lawrence Erlbaum.
- Frantzen, D. (1995). The effects of grammar supplementation on written accuracy in an intermediate Spanish content course. *Modern Language Journal*, 79, 329-344.
- Guénette, D. (2007). Is feedback pedagogically correct? Research design issues in studies of feedback on writing. *Journal of Second Language Writing* 16(1), 40-53.
- Hyland, F. (2003). Focusing on form: Student engagement with teacher feedback. *System*, 31, 217-230.
- Kepner, C. G. (1991). An experiment in the relationship of types of written feedback to the development of second- language writing skills. *Modern Language Journal*, 75, 305-313.
- Lalande, J. F. (1982). Reducing composition errors: An experiment. *Modern Language Journal*, 66, 140-149.
- Leki, I. (2001). Material, educational, and ideological challenges of teaching ESL writing at the turn of the century. In R. Manchón (Ed.), *Writing in the L2 Classroom: Issues in research and pedagogy. Special Issue of International Journal of English Studies* 9(2), 197-209.
- Li, S. (2010). The effectiveness of corrective feedback in SLA: A meta-analysis. *Language Learning*, 60, 309-365.
- Lyster, R. (2004). Different effects of prompts and recasts in form-focused instruction. *Studies in Second Language Acquisition* 26(3), 399-432.
- Lyster, R., & Saito, K. (2010). Oral feedback in classroom SLA: A meta-analysis. *Studies in Second Language Acquisition* 32(2), 265-302.
- Muranoi, H. (2000). Focus on form through interaction enhancement: Integrating formal instruction into a communicative task in EFL classrooms. *Language Learning*, 50, 617 - 673.
- Polio, C., Fleck, C., & Leder, N. (1998). "If only I had more time:" ESL learners' changes in linguistic accuracy on essay revisions. *Journal of Second Language Writing*, 7, 43-68.
- Reichelt, M. (2005). English-language writing instruction in Poland. *Journal of Second Language Writing*, 14 (4), 215-232.

- Reichelt, M. (2009). A critical evaluation of writing teaching programs in different foreign language settings. In: Manchon, R., & Manchon, R. (Eds.), *Writing in foreign language contexts: Learning, teaching, and research* (pp. 183-206). Multilingual Matters, Clevedon.
- Robb, T., Ross, S., & Shortreed, I. (1986). Salience of feedback on error and its effect on EFL writing quality. *TESOL Quarterly*, 20, 83-93.
- Semke, H. D. (1984). The effects of the red pen. *Foreign Language Annals*, 17, 195 - 202.
- Sheen, Y. (2007). The effect of focused written corrective feedback and language aptitude on ESL learners' acquisition of articles. *TESOL Quarterly* 41(2), 255-283.
- Sheen, Y. (2010a). The role of oral and written corrective feedback in SLA. *Studies in Second Language Acquisition* 32(2), 169-179.
- Sheen, Y. (2010b). Differential effects of oral and written corrective feedback in the ESL classroom. *Studies in Second Language Acquisition* 32(2), 201-234.
- Sheen, Y., Wright, D., & Moldawa, A. (2009). Differential effects of focused and unfocused written correction on the accurate use of grammatical forms by adult ESL learners. *System* 37(4), 556-569.
- Sheppard, K. (1992). Two feedback types: Do they make a difference? *RELC Journal* 23(1), 103-110.
- Truscott, J. (1996). The case against grammar correction in L2 writing classes. *Language Learning*, 46, 327-369.
- Truscott, J., & Hsu, A.Y. (2008). Error correction, revision, and learning. *Journal of Second Language Writing*, 17(4), 292-305.
- You, X. (2004a). 'The choice made from no choice': English writing instruction in a Chinese university. *Journal of Second Language Writing*, 13(2), 97-110.

---

### Author Information

---

**Rasheed Al-Jarrah**

English Department, Yarmouk University  
Irbid/Jordan  
Contact e-mail: [drsakash@hotmail.com](mailto:drsakash@hotmail.com)

**Sayyah Al-Ahmad**

English Department, Yarmouk University  
Irbid/Jordan

---

**To cite this article:**

Al-Jarrah, R. & Al-Ahmad, S. (2022). The influence of indirect corrective feedback on the linguistic accuracy of adjectival clauses in an EFL context. *The Eurasia Proceedings of Educational & Social Sciences (EPESS)*, 28, 1-10.

The Eurasia Proceedings of Educational & Social Sciences (EPESS), 2022

Volume 28, Pages 11-18

**IConSE 2022: International Conference on Science and Education**

## Oral Proficiency Interview (OPI) for the Assessment of Speaking

**Ahmet ONAL**

Süleyman Demirel University

**Abstract:** The skill of speaking, arguably, plays the most essential role in the process of communication among people; thus, the teaching and assessment of speaking deserves special attention. The oral proficiency interview (OPI) has been utilized as a technique for the assessment of speaking for about 70 years and its traditional format has been revised and updated in line with the requirements of contexts and innovations in technology. Accordingly, this paper briefly introduces the OPI and discusses the advantages and disadvantages of the OPI. In addition, the reliability and validity of the OPI for the assessment of speaking skills has also been expounded on with specific reference to its strengths and weaknesses. More precisely, the paper argues that the OPI has the potential to assist foreign language teachers in teaching and testing the speaking skills of their learners as long as its weaknesses are compensated for, reliable rating scales are designed and raters are trained to score the performances reliably.

**Keywords:** Testing speaking, Assessment of speaking, Oral proficiency interview

### Introduction

Knowing a language involves being able to listen, read (and understand), speak and write using that language and these four skills are usually integrated in daily life. For instance, when a person gets a text message, s/he writes a reply or when s/he watches the news on television, s/he may talk about the news item to the person that accompanies him/her. However, being able to speak the target language fluently is the main aim of most people learning foreign languages (Gültekin, 2022; Richards, 2015) and speaking is regarded as the primary skill when compared to listening, reading or writing (Boeru & Cizer, 2021; Namaziandost & Ahmadi, 2019; Suwarno, 2017) because people ask ‘*Do you speak English?*’ rather than ‘*Do you listen to/read in/write in English?*’ when they meet a foreigner.

### Assessment of Speaking

Assessment of speaking skill is notorious for being time-consuming, resource-intensive and logistically-complex endeavor (Abi & Üstünel, 2018; Jankowska & Zielińska, 2015; Louma, 2004; Malone & Montee, 2010; Nakatsuhara et al., 2021; Namaziandost & Ahmadi, 2019; Önal, 2020) since it calls for the development and implementation of valid and reliable tests. Moreover, it has been argued that the best way of testing speaking is getting test-takers to speak (Fulcher & Davidson, 2007; Green, 2021) although it is also possible to assess speaking through indirect tasks (such as repetition and multiple-choice tests). However, as has been observed by Gültekin (2022), due to the challenges it presents, some teachers may tend not to teach and assess the skill of speaking and when they do teach and test speaking, they make use of traditional methods, which do not contribute much to the communicative competences of the learners. Consequently, foreign language learners complain that *they can understand but cannot speak* the target language.

### Oral Proficiency Interview

---

- This is an Open Access article distributed under the terms of the Creative Commons Attribution-Noncommercial 4.0 Unported License, permitting all non-commercial use, distribution, and reproduction in any medium, provided the original work is properly cited.

- Selection and peer-review under responsibility of the Organizing Committee of the Conference

© 2022 Published by ISRES Publishing: [www.isres.org](http://www.isres.org)



The term oral proficiency can be defined as “learners’ ability to converse with one or several interlocutors” (Sandlund et al., 2016, p. 16) and oral proficiency interviews (OPIs) have been increasingly and extensively used to assess learners’ oral proficiency levels since their introduction in 1952 (Abi & Üstünel, 2018; Brown & Abeywickrama, 2018; Chalhoub-Deville & Fulcher, 2003; Cho, 2004; Glisan et al., 2013; Green, 2021; Gültekin, 2022; Hırçın Çoban, 2017; Johnson, 2000; Kasper & Ross, 2007; Liskin-Gasparro, 2003; Louma, 2004; Malone, 2003; Malone & Montee, 2010; Nakatsuhara et al., 2021; Nakatsuhara et al., 2022; Richards, 2015; Staples et al., 2017; Swender, 2003; Thompson et al., 2006). OPI can be briefly defined as an interview between a trained tester and a test-taker “...designed to elicit a profile of the examinee’s oral proficiency through a sustained performance” (Malone, 2003, p. 491). The performance of the test-taker is then scored in line with the criteria in the rating scale employed (Malone & Montee, 2010). Thus, it would be safe to argue that the OPI is a criterion-referenced test in that it compares each test-taker’s performance to the assessment criteria rather than comparing the performances of the test-takers with each other (Swender, 2003).

In its traditional form, the OPI consists of four stages (Brown & Abeywickrama, 2018; Cho, 2004; Gültekin, 2022; Johnson, 2000; Malone & Montee, 2010):

- 1- *Warm-up*: The tester warms up the test-taker by getting acquainted with each other, introduces the test format and tries to relieve test-taker’s anxiety.
- 2- *Level check*: The tester tries to identify and confirm the proficiency level of the test-taker through a set of preplanned questions and tasks.
- 3- *Probe*: The tester aims to discover the upper limit (or *ceiling*) ability of the test-taker with the help of linguistically and cognitively challenging questions.
- 4- *Wind-down*: The tester ensures that the test-taker leaves the room with a feeling of achievement and satisfaction with the help of easier questions.

Basically, the OPI may be regarded as a kind of interaction between the tester and the test-taker. In this respect, when two or more interlocutors talk to each other, the process is referred to as interaction and involves such components as *turn management* (starting, maintaining and ending), *topic management* (initiating, extending, shifting and closing), *non-verbal behavior* (eye contact, facial expression and laughter), *breakdown repair* (joint utterance creation and recasts) and *interactive listening* (backchannelling, comprehension checks and continuers) (Galaczi & Taylor, 2021; Richards, 2015). As for the scoring of the OPI performances of the test-takers, global frameworks such as the American Council on the Teaching of Foreign Languages (ACTFL) Guidelines and the Common European Framework of Reference (CEFR) have been utilized to assess, identify, interpret and compare linguistic proficiency of individuals and OPI scores are linked to the ACTFL or CEFR (ACTFL, 2012; Glisan et al., 2013; Gültekin, 2022; Hırçın Çoban, 2017; Johnson, 2000; Isbell & Winke, 2019; Isbell et al., 2019; Kissau, 2014; Malone & Montee, 2010; Swender, 2003; Tschirner et al., 2012).

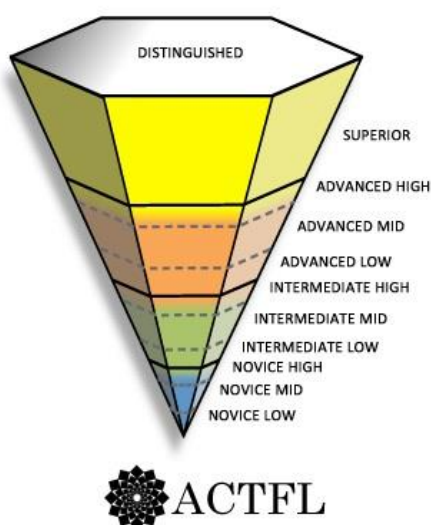

Figure 1. ACTFL proficiency guidelines–levels of proficiency (Source: <https://www.actfl.org/resources/actfl-proficiency-guidelines-2012>)

As can be seen in Figure 1, levels of proficiency in the ACTFL consist of 5 major levels and three of them (novice, intermediate and advanced) are further divided into three sub-levels (low, mid, and high) (ACTFL, 2012). As a result, the ACTFL features a total of 11-level structure (including the sub-levels) whereas the CEFR

consists of 6 main levels (i.e. A1, A2, B1, B2, C1, and C2). A comparison of ACTFL and CEFR levels has been presented in Table 1.

Table 1. Comparison of ACTFL and CEFR levels (Adapted from Tschirner et al., 2012; 12).

ACTFL	CEFR
Novice High	A1
Intermediate Low	A2
Intermediate Mid	B1(.1)
Intermediate High	B1(.2)
Advanced Low	B2(.1)
Advanced Mid	B2(.2)
Advanced High	C1
Superior	C2

Besides its traditional form, many different forms of OPI have been designed and implemented throughout the years. For example, *simulated oral proficiency interview* (SOPI) modeling the format of the OPI has been offered (Malone, 2000; Mikhailova, 2007; Sandlund et al., 2016) and supposed to feature certain practical, administrative and psychometric advantages over the traditional OPI (Stansfield, 1990). In a similar fashion, latest innovations in technology have made it possible to conduct OPIs through video-conferencing applications, which helps overcome geographical and temporal obstacles (Lim, 2018; Loranc-Paszyk, 2015; Marcum & Kim, 2020; Money Penny & Aldrich, 2016; Nakatsuhara et al., 2021; Rubio, 2015; Thompson et al., 2006; Tschirner et al., 2012). The computer-delivered version of the OPI, namely *Oral Proficiency Interview-computer* (OPIc), has also been gaining wider popularity (Isbell & Winke, 2019; Isbell et al., 2019; Marcum & Kim, 2020) since it may help alleviate challenges related to cost and time to be allocated for face-to-face implementation of the OPI (Isbell & Winke, 2019; Malone & Montee, 2010). High levels of correlation between the scores of the test-takers in the OPI and the OPIc has been reported (Isbell & Winke, 2019; Thompson et al., 2006; Tschirner et al., 2012) and OPI performances of the test-takers can be recorded and watched repeatedly to produce more accurate scoring and to give more precise feedback (Jankowska & Zielińska, 2015). Despite the benefits it offers, online implementation of the OPI and similar assessment methods raises issues related to test reliability, validity and security.

### Reliability & Validity of the OPI

Several concerns have been voiced as to the reliability and construct validity of the OPI (Chalhoub-Deville & Fulcher, 2003; Cho, 2004; Hırçın Çoban, 2017; Johnson, 2000; Kissau, 2014; Malone, 2003; Malone & Montee, 2010; Salaberry, 2000). To start with, it has been argued that the OPI functions as a proficiency test aiming to assess test-takers' speaking skills in comparison to language spoken by well-educated native speakers; however, definition of *well-educated* and *native speaker* is elusive and controversial (Chalhoub-Deville & Fulcher, 2003; Kasper & Ross, 2007; Liskin-Gasparro, 2003; Malone & Montee, 2010). In addition, the type of interaction occurring in the OPI hardly represents the natural and authentic conversation between speakers, which casts its validity into shadow (Malone, 2003; Malone & Montee, 2010). More specifically, interactions in real-life tend to be more symmetrical and two-way and the power relationship between the interlocutors is often less evident and influential, which is not the case in the OPI.

In line with this, two types of reliability are regarded as relevant for the assessment of speaking; *intra-rater* and *inter-rater* reliability. The former refers to the extent to which an individual rater agrees with him-/herself for scoring the same performance on different occasions whereas the latter signifies the level of correlation between two different raters in scoring the same performance (Louma, 2004). The OPI has been frequently criticized in terms of the potential problems as to the inter-rater reliability (Cho, 2004; Kissau, 2014; Liskin-Gasparro, 2003; Malone, 2003). Louma (2004) and Surface & Dierdorff (2003) maintain that well-trained raters and high-quality scoring tools and procedures are of utmost importance to achieve a high level of reliability in the assessment of speaking skills.

### Pros and Cons of the OPI

As has been aforementioned, the nature of interaction in a traditional oral interview is only one-sided (from the tester to the test-taker) or asymmetric (Brooks, 2009; Hırçın Çoban, 2017; Johnson, 2000) in that the tester strictly controls the course of the interview by asking questions that the test-taker is required to answer, which

rarely happens in an authentic conversation (Abi & Üstünel, 2018; Green, 2021; Johnson, 2000; Kasper & Ross, 2007; Liskin-Gasparro, 2003). Therefore, it can be argued that the tester plays a crucial role in the performance of the test-taker since the conversation is tightly controlled, delivered and co-constructed by the tester (Hırçın Çoban, 2017; Kasper & Ross, 2007). Put differently, *rater effects* that include consistency or inconsistency in a rater's elicitation techniques and scores, rater severity or leniency, illusory halo or horns and rater bias may lead to contamination of the assessment (Ahmadi & Sadeghi, 2016; Brooks, 2009; Brown & Abeywickrama, 2018; Chalhoub-Deville & Fulcher, 2003; Cho, 2004; Davis, 2022; Galaczi & Lim, 2022; Hırçın Çoban, 2017; Malone, 2003; O'Loughlin, 2002; Pill & Smart, 2021; Ross, 2012; Wigglesworth & Frost, 2017). As has been noted by Malone and Montee (2010), though OPIs are implemented by trained and certified testers, "...human error is inevitable and can be limited but not eliminated" (p. 978). In this regard, pairing or even grouping the test-takers and asking them to interact with each other may help remedy this weakness (Brooks, 2009; Brown & Abeywickrama, 2018; Green, 2021; Hırçın Çoban, 2017; Jankowska & Zielińska, 2015; Louma, 2004; Prasetyo, 2018; Sandlund et al., 2016) because, as has been reported by Ahmadi and Sadeghi (2016) and Brooks (2009), positive washback, more natural discourse and more various language functions can be attained and the workload of the rater in terms of time, effort and cost may be reduced. Moreover, when test-takers are paired or grouped, they tend to feel less anxious in comparison to the traditional OPI (Hırçın Çoban, 2017). Consequently, when a test-taker is paired with a friend, s/he tends to perform better (Brooks, 2009; O'Sullivan, 2002).

On the other hand, it should not go without saying that even when the interview is conducted in pairs or groups, the so-called *interlocutor effect* may emerge because each individual test-taker possesses his/her own socio-cultural identity and personal characteristics (Brooks, 2009; Brown, 2012; Nakatsuhara et al., 2022; Sandlund et al., 2016). Put differently, individuals tend to accommodate their speech in line with their interlocutors and variables such as test-takers' acquaintanceship, cultural and linguistic background, extroversion, talkativeness, gender and language proficiency may influence the course of interaction (Brooks, 2009; Galaczi & Taylor, 2021; O'Loughlin, 2002; O'Sullivan, 2002; O'Sullivan & Porter, 1996). As a result, an individual test-taker may tend to dominate the interaction and decrease other test-takers' chances of showing their real performances. In such cases, raters should closely monitor the course of interaction and present equal opportunities to the test-takers. Though paired/grouped OPIs present certain challenges, Brooks (2009) has concluded that test-takers exhibited better performance in paired format of the OPI, which resulted in more interaction, negotiation of meaning, complex output and consideration of the interlocutor.

It has been advocated that OPIs are good measures of test-takers' overall communicative competence and have some other side-benefits such as alignment of curricula, methods and classroom activities with a more focus on communication (Chalhoub-Deville & Fulcher, 2003; Kissau, 2014; Malone & Montee, 2010; Suwarno, 2017), implying that OPIs tend to yield positive washback. In this respect, Gültekin (2022) has reported that tertiary level students studying at English preparatory classes prefer OPI to traditional speaking tests since they get a chance to demonstrate their communicative skills in a realistic setting. Moreover, despite concerns over the reliability of the OPI, the reliability of OPI and its adaptability to self-assessment have been confirmed by Ma and Winke (2019). Similarly, Surface and Dierdorff (2003) demonstrated inter-rater consistency and agreement in the OPI for 19 different languages.

It would be safe to argue that assessment of speaking is already an anxiety-provoking experience for many test-takers (Marzec-Stawiarska, 2015; Sayın, 2015; Sullivan, 2011; Suwarno, 2017) and when it comes to the OPI (viewed by some as talking in a foreign language to a foreigner in a test format), the level of anxiety multiplies. It should be noted at this point that repeated practice may help individuals to overcome anxiety-provoking experiences and build their self-confidence, which implies that OPIs should also be utilized for instructional purposes in addition to assessment purposes with the aim of helping test-takers alleviate their anxiety.

### **Use of Rating Scales in the OPI**

In order to score any oral and/or written performance, a well-designed rating scale (or *rubric*) is essential to ensure reliability (Brown & Abeywickrama, 2018; Fulcher, 2012; Galaczi & Lim, 2022; Green, 2021; Namaziandost & Ahmadi, 2019; Wigglesworth & Frost, 2017). Either *holistic* or *analytic* scales are commonly used for scoring the speaking performance of the test-takers. In a holistic scale, a single number is awarded to a specific performance (Brown & Abeywickrama, 2018; Galaczi & Lim, 2022; Gültekin, 2022; Kuiken & Vedder, 2021; Louma, 2004) and that number is meant to signify the overall speaking ability of the test-taker (Fulcher & Davidson, 2007). It should be noted that though holistic scales are user-friendly, practical and fast to use, they do not provide the test-takers with any kind of feedback (Hamp-Lyons, 1991; Kuiken & Vedder, 2021). In contrast, in an analytic scale, multiple scores across a range of categories or criteria (such as fluency, vocabulary

use, pronunciation, interaction, content, etc.) are given to a single spoken performance and these scores may be added together to obtain an overall score (Brown & Abeywickrama, 2018; Galaczi & Lim, 2022; Green, 2021; Louma, 2004; Richards, 2015). Therefore, test-takers have the chance to get specific diagnostic feedback as to their strengths and weaknesses (Kuiken & Vedder, 2021). The main advantage of analytic scales is their flexibility of use in that differential weighting can be applied across the categories in line with the population and specific purpose of the assessment (Green, 2021). As can be surmised, both types of scales have their own strengths and weaknesses; thus, Namaziandost and Ahmadi (2019) suggest that making use of both types of scales may be more suitable since they can supplement each other and produce more reliable scores.

### **Rater Training for the OPI**

A well-designed rating scale may be regarded as the first step for a reliable assessment of speaking; however, the same scale may be interpreted differently by different raters since it is the rater that mediates between the rating scale and the performance of the specific test-taker (Davis, 2022; Galaczi & Lim, 2022; Pill & Smart, 2021). Therefore, the necessity of training the interlocutors and raters to attain high level of standardization (of the experiences of all the test-takers as much as possible) has been frequently underscored in the relevant literature (Brown, 2012; Davis, 2022; Fulcher & Davidson, 2007; Green, 2021; Hamp-Lyons, 1991; Hırçın Çoban, 2017; Kuiken & Vedder, 2021; Louma, 2004; Malone, 2000; Malone & Montee, 2010; Pill & Smart, 2021; Ross, 2012; Surface & Dierdorff, 2003; Wigglesworth & Frost, 2017). The focus of these trainings may be on the interpretation and implementation of the rating scale to be employed and, as has been underscored by Gablasova (2021), the threat of rater effect should also be covered in rater training sessions with the aim of minimizing it. Such training programs can even be conducted online thanks to web-conferencing technologies so that they become more accessible for those who are disadvantaged in terms of location and time (Brown, 2012).

### **Conclusion and Recommendations**

This paper has underscored the need to assess the skill of speaking by referring to the fundamental role it plays in the process of communication. In other words, if we really aim at improving our learners' communicative competences, we must teach and test their oral skills effectively. One way of achieving this aim is the OPI, which can be used both for instructional and assessment purposes. The paper has briefly introduced the traditional and updated formats of the OPI with reference to the benefits it offers and drawbacks it presents. Use of rating scales and training of the raters for the OPI have also been dealt within the paper and it has been suggested that no one best scale has the potential to satisfy all goals and contexts; thus, such factors as the purpose of the assessment, the construct to be assessed, the characteristics of the population and the interpretation of the test scores should be taken into account when choosing the specific rating scale to be employed (Kuiken & Vedder, 2021).

To conclude, suitability for purpose rather than best way of testing speaking needs to be sought for and the potential of technology in assisting us for the assessment of speaking skills should be taken into consideration (Nakatsuhara et al., 2022). As an example, web-conferencing technologies, which have become regular components of our daily lives since the outbreak of the Covid-19 pandemic, may be employed in the implementation of OPI. Similarly, with the help of technologies such as eye-tracking and natural language processing, it may become viable to better understand interlocutor/rater cognition and decision-making processes (Davis, 2022). In a similar fashion, automated scoring systems promise to support and even substitute raters by scoring oral performances faster and more reliably (Brown, 2012; Galaczi & Lim, 2022; Lim, 2018; Ross, 2012). As a final note, it should not be forgotten that the successful implementation of OPIs requires financial and personnel resources as well as time and meticulous planning (Isbell & Winke, 2019; Malone & Montee, 2010; Thompson et al., 2006) and when such requirements cannot be met, it would not be feasible to use OPIs for the assessment of speaking.

### **Scientific Ethics Declaration**

The author declares that the scientific ethical and legal responsibility of this article published in EPESS journal belongs to the author.

## Acknowledgements

\* This article was presented as an oral presentation at the International Conference on Science and Education ([www.iconse.net](http://www.iconse.net)) held in Antalya/Turkey on November 15-18, 2022

## References

- Abi, M. & Üstünel, E. (2018). Multiple questions in different sections of oral proficiency interviews. *ELT Research Journal*, 7(2), 91-103.
- ACTFL (American Council on the Teaching of Foreign Languages). (2012). *ACTFL proficiency guidelines 2012* [Electronic version]. Retrieved from <https://www.actfl.org/sites/default/files/guidelines/ACTFLProficiencyGuidelines2012.pdf>
- Ahmadi, A. & Sadeghi, E. (2016). Assessing English language learners' oral performance: A comparison of monologue, interview, and group oral test. *Language Assessment Quarterly*, 13(4), 341-358. <https://doi.org/10.1080/15434303.2016.1236797>
- Boeru, M. & Cizer, L. (2021). Tell, say, talk—speaking strategies and techniques to growing confident communicators for oral proficiency interviews in English. In Boldea, I., Sigmirean, C. & Buda, D.-M., *Reading Multiculturalism: Human and Social Perspectives*, 111-117. Arhipelag XXI Press.
- Brooks, L. (2009). Interacting in pairs in a test of oral proficiency: Co-constructing a better performance. *Language Testing*, 26(3), 341-366. <https://doi.org/10.1177/0265532209104666>
- Brown, H. D. & Abeywickrama, P. (2018). *Language assessment: Principles and classroom practices (3<sup>rd</sup> Ed.)*. Pearson Education.
- Chalhoub-Deville, M. & Fulcher, G. (2003). The oral proficiency interview: A research agenda. *Foreign Language Annals*, 36(4), 498-506.
- Cho, S. (2004). Oral proficiency interview: Pros and cons. *The Korean Language in America*, 9, 144-151.
- Davis, L. (2022). Rater and interlocutor training. In Fulcher, G. & Harding, L. (Eds.), *The Routledge handbook of language testing (2<sup>nd</sup> Ed.)*, 322-338, Routledge.
- Fulcher, G. (2012). Scoring performance tests. In Fulcher, G. & Davidson, F. (Eds.), *The Routledge handbook of language testing*, 378-392, Routledge.
- Fulcher, G. & Davidson, F. (2007). *Language testing and assessment: An advanced resource book*. Routledge.
- Gablasova, D. (2021). Corpora for second language assessments. In Winke, P. & Brunfaut, T. (Eds.), *The Routledge handbook of second language acquisition and language testing*, 45-53, Routledge.
- Galaczi, E. D. & Lim, G. S. (2022). Scoring performance tests. In Fulcher, G. & Harding, L. (Eds.), *The Routledge handbook of language testing (2<sup>nd</sup> Ed.)*, 495-510, Routledge.
- Galaczi, E. D. & Taylor, L.B. (2021). Measuring interactional competence. In Winke, P. & Brunfaut, T. (Eds.), *The Routledge handbook of second language acquisition and language testing*, 338-348, Routledge.
- Glisan, E. W., Swender, E. & Surface, E. A. (2013). Oral proficiency standards and foreign language teacher candidates: Current findings and future research directions. *Foreign Language Annals*, 46(2), 264-289. <https://doi.org/10.1111/flan.12030>
- Green, A. (2021). *Exploring language assessment and testing (2nd Ed.)*. Routledge.
- Gültekin, E. (2022). *The impact of American council on the teaching of foreign languages (ACTFL) oral proficiency interview on assessing speaking skill in English preparatory schools at higher education in Turkey*. Master's thesis, Maltepe University, Institute of Postgraduate Studies.
- Hamp-Lyons, L. (1991). Scoring procedures for ESL contexts. In Hamp-Lyons, L. (Ed.). *Assessing second language writing in academic contexts*, 241-276, Ablex.
- Hırçın Çoban, M. (2017). *Resolving interactional troubles in paired oral proficiency assessment in an English as a foreign language context*. Master's thesis, Hacettepe University, Graduate School of Educational Sciences.
- Isbell, D. & Winke, P. (2019). ACTFL Oral proficiency interview—computer (OPIc). *Language Testing*, 36(3), 467-477. <https://doi.org/10.1177/0265532219828253>
- Isbell, D. R., Winke, P. & Gass, S. M. (2019). Using the ACTFL OPIc to assess proficiency and monitor progress in a tertiary foreign languages program. *Language Testing*, 36(3), 439-465. <https://doi.org/10.1177/0265532218798139>
- Jankowska, A. & Zielińska, U. (2015). Designing a self-assessment instrument for developing the speaking skill at the advanced level. In Pawlak, M. & Waniek-Klimczak, E. (Eds.), *Issues in teaching, learning and testing speaking in a second language*, 251-265, Springer.
- Johnson, M. (2000). Interaction in the oral proficiency interview: Problems of validity. *Pragmatics*, 10(2), 215-231.

- Kasper, G. & Ross, S. J. (2007). Multiple questions in oral proficiency interviews. *Journal of Pragmatics*, 39(11), 2045-2070.
- Kissau, S. (2014). The impact of the oral proficiency interview on one foreign language teacher education program. *Foreign Language Annals*, 47(3), 527-545. <https://doi.org/10.1111/flan.12092>
- Kuiken, F. & Vedder, I. (2021). Scoring approaches: Scales/rubrics. In Winke, P. & Brunfaut, T. (Eds.), *The Routledge handbook of second language acquisition and language testing*, 125-134, Routledge.
- Lim, G. S. (2018). Conceptualizing and operationalizing second language speaking assessment: Updating the construct for a new century, *Language Assessment Quarterly*, 15(3), 215-218, <https://doi.org/10.1080/15434303.2018.1482493>
- Liskin-Gasparro, J. E. (2003). The ACTFL proficiency guidelines and the oral proficiency interview: A brief history and analysis of their survival. *Foreign Language Annals*, 36(4), 483-490.
- Loranc-Paszylk, B. (2015). Videoconferencing as a tool for developing speaking skills. In Pawlak, M. & Waniek-Klimczak, E. (Eds.), *Issues in teaching, learning and testing speaking in a second language*, 189-203, Springer.
- Louma, S. (2004). *Assessing speaking*. Cambridge University Press.
- Ma, W. & Winke, P. (2019). Self-assessment: How reliable is it in assessing oral proficiency over time?. *Foreign Language Annals*, 52(1), 66-86. <https://doi.org/10.1111/flan.12379>
- Malone, M. (2000). Simulated oral proficiency interviews: Recent developments. *ERIC Digest*, 1-7.
- Malone, M. E. (2003). Research on the oral proficiency interview: Analysis, synthesis, and future directions. *Foreign Language Annals*, 36(4), 491-497.
- Malone, M. E. & Montee, M. J. (2010). Oral proficiency assessment: Current approaches and applications for post-secondary foreign language programs. *Language and Linguistics Compass*, 4(10), 972-986. <https://doi.org/10.1111/j.1749-818x.2010.00246.x>
- Marcum, J. & Kim, Y. (2020). Oral language proficiency in distance English-language learning. *Computer Assisted Language Instruction Consortium (CALICO Journal)*, 37(2), 148-168. <https://doi.org/10.1558/cj.37788>
- Marzec-Stawiarska, M. (2015). Investigating foreign language speaking anxiety among advanced learners of English. In Pawlak, M. & Waniek-Klimczak, E. (Eds.), *Issues in teaching, learning and testing speaking in a second language*, 103-119, Springer.
- Mikhailova, J. (2007). Rethinking description in the Russian SOPI: Shortcomings of the simulated oral proficiency interview. *Foreign Language Annals*, 40(4), 584-603.
- Money Penny, D. B. & Aldrich, R. S. (2016). Online and face-to-face language learning: A comparative analysis of oral proficiency in introductory Spanish. *Journal of Educators Online*, 13(2), 105-133.
- Nakatsuhara, F., Inoue, C. & Khabbazzashi, N. (2021). Measuring L2 speaking. In Winke, P. & Brunfaut, T. (Eds.), *The Routledge handbook of second language acquisition and language testing*, 285-294, Routledge.
- Nakatsuhara, F., Khabbazzashi, N. & Inoue, C. (2022). Assessing speaking. In Fulcher, G. & Harding, L. (Eds.), *The Routledge handbook of language testing* (2<sup>nd</sup> Ed.), 209-222, Routledge.
- Namaziandost, E. & Ahmadi, S. (2019). The assessment of oral proficiency through holistic and analytic techniques of scoring: A comparative study. *Applied Linguistics Research Journal*, 3(2), 70-82. <https://doi.org/10.14744/alrj.2019.83792>
- O'Loughlin, K. (2002). The impact of gender in oral proficiency testing. *Language Testing*, 19(2), 169-192.
- O'Sullivan, B. (2002). Learner acquaintanceship and oral proficiency test pair-task performance. *Language Testing*, 19(3), 277-295.
- O'Sullivan, B. & Porter, D. (1996). Speech style, gender, and oral proficiency interview performance. *Paper presented at the Annual Meeting of the Southeast Asian Ministers of Education Organization Regional Language Center Seminar*, Singapore.
- Önal, O. (2020). Automated scoring of productive skills in language assessment. In Çelik, S. (Ed.), *Preparing teachers for a changing world: Contemporary issues in EFL education*, 103-114, Vizetek.
- Pill, J. & Smart, C. (2021). Raters: Behavior and training. In Winke, P. & Brunfaut, T. (Eds.), *The Routledge handbook of second language acquisition and language testing*, 135-144, Routledge.
- Prasetyo, H. (2018). Paired oral tests: a literature review. *LLT Journal: A Journal on Language and Language Teaching*, 21(Suppl), 105-110. <https://doi.org/10.24071/lt.2018.Suppl2110>
- Richards, J. C. (2015). *Key issues in language teaching*. Cambridge University Press.
- Ross, S. J. (2012). Claims, evidence, and inference in performance assessment. In Fulcher, G. & Davidson, F. (Eds.), *The Routledge handbook of language testing*, 223-233, Routledge.
- Rubio, F. (2015). Assessment of oral proficiency in online language courses: Beyond reinventing the wheel. *The Modern Language Journal*, 99(2), 405-408.
- Salaberry, R. (2000). Revising the revised format of the ACTFL Oral Proficiency Interview. *Language Testing*, 17(3), 289-310.

- Sandlund, E., Sundqvist, P. & Nyroos, L. (2016). Testing L2 talk: A review of empirical studies on second-language oral proficiency testing. *Language and Linguistics Compass*, 10(1), 14-29. <https://doi.org/10.1111/lnc3.12174>
- Sayın, B. A. (2015). Exploring anxiety in speaking exams and how it affects students' performance. *International Journal of Education and Social Science*, 2(12), 112-118.
- Stansfield, C. W. (1990). A comparative analysis of simulated and direct oral proficiency interviews. *Paper presented at the Annual Meeting of the Regional Language Centre Conference*, Singapore.
- Staples, S., Laflair, G. T. & Egbert, J. (2017). Comparing language use in oral proficiency interviews to target domains: Conversational, academic, and professional discourse. *The Modern Language Journal*, 101(1), 194-213. <https://doi.org/10.1111/modl.12385>
- Sullivan, J. H. (2011). Taking charge: Teacher candidates' preparation for the oral proficiency interview. *Foreign Language Annals*, 44(2), 241-257.
- Surface, E. A. & Dierdorff, E. C. (2003). Reliability and the ACTFL Oral Proficiency Interview: Reporting indices of interrater consistency and agreement for 19 languages. *Foreign Language Annals*, 36(4), 507-519.
- Suwarno, P. (2017). The importance of oral performance: what makes a successful proficiency-based foreign language program. *ISLLAC: Journal of Intensive Studies on Language, Literature, Art, and Culture*, 1(1), 1-18.
- Swender, E. (2003). Oral proficiency testing in the real world: Answers to frequently asked questions. *Foreign Language Annals*, 36(4), 520-526.
- Thompson, G. L., Cox, T. L. & Knapp, N. (2016). Comparing the OPI and the OPIc: The effect of test method on oral proficiency scores and student preference. *Foreign Language Annals*, 49(1), 75-92. <https://doi.org/10.1111/flan.12178>
- Tschirner, E., Bärenfänger, O. & Wanner, I. (2012). *Assessing evidence of validity of assigning CEFR ratings to the ACTFL oral proficiency interview (OPI) and the oral proficiency interview by computer (OPIc)*. Technical Report 2012-US-PUB-1. Retrieved from <http://www.languagetesting.com/wpcontent/uploads/2014/02/OPIc-CEFR-Study-Final-Report.pdf>
- Wigglesworth, G. & Frost, K. (2017). Task and performance-based assessment. In Shohamy, E., Or, I. G. & May, S. (Eds.), *Language testing and assessment (3<sup>rd</sup> Ed.)*, 121-134, Springer International Publishing.

---

### Author Information

---

**Ahmet Önal**

Suleyman Demirel University

Isparta, TURKEY

Contact e-mail: [ahmetonal@sdu.edu.tr](mailto:ahmetonal@sdu.edu.tr)

---

### To cite this article:

Önal, A. (2022). Oral proficiency interview (OPI) for the assessment of speaking. *The Eurasia Proceedings of Educational & Social Sciences (EPESS)*, 28, 11-18.

The Eurasia Proceedings of Educational &amp; Social Sciences (EPESS), 2022

Volume 28, Pages 19-35

IConSE 2022: International Conference on Science and Education

## Assemblage Art's Visual Stimulators Based on the Recycling of Musical Instruments as an Experimental Approach to Design

Nashwa HASSAN  
Alexandria University

**Abstract:** Assemblage, doubtlessly, is a special form of art that still holds a culture of rapid age which shows a big change in an artist's attitude towards the society he lives in, as well as his persistent desire to change and experiment. It was started when *Schwitters* added discarded objects to his "Merz" series manifesting reality to his artistic plain. Meanwhile, *Picasso* was taken by deconstructing shapes and re-embodying them in cardboard. Perhaps the visual appeal motive of recycling used materials has a lot of passion and joy unexpectedly resulting each time a new life is given to throwaway objects. According to the Art Education culture and its dedicated objectives of recycling and achieving sustainable development of artwork, in addition to the fact that Design is a fertile field to employ many types of art, this paper and research utilized used and damaged musical instruments as creative inputs and starting points to Artwork Design Composition.

**Keywords:** Assemblage art, Design values, Recycling, Sustainable development, Visual art

### Introduction

Design in the context of artwork represents its visual formula, or it's the special formulation of points of interest in the sum of its components of shapes, colors, lines and all other appealing physical presence of materials forming it. An artwork could take a flat or sculptural form for which the elements composed on its surfaces are represented, thus creating spatial and cognitive contradictions either imaginary or real, which precondition our acceptance of the visual stimuli available in it. Assemblage art is characterized as a turning point in the history of arts by addressing the raw material on the painting's surface, which according to the point of view of the designer, adheres to compositional or formative relationships.

Those relationships relate to the frequency of the surface that combine the values of design with the aesthetics of other artistic fields such as painting, sculpture or many others. This led to the emergence of works of art loaded with characteristics of other art forms where each art form enriches the elements of the others. Although each art form has its own specific language, the arts in general share the same characteristics and artistic principles so that no work of art will lack rhythm, unity or balance. Art forms may differ in their way of addressing senses, especially after the emergence of many hybrid works of art under the definition of "Visual Arts", as it's the most accurate term to describe the artistic achievements which combined Plastic Arts with all its applications, Applied Arts, Musical Arts, Theatre, Media Arts and others.

The term "Visual Arts" isn't new. As the relationship which units Art and Music for example; is demonstrated by the pioneer of abstraction "*Wassily Kandinsky*" (1866-1944), who went further in his vision beyond the relationship of shape to color. He wanted to recall sound through the sense of sight and then find an artistic equivalent to a symphony that would not only excite the eye, but also the ear. Like many artists who later followed Kandinsky, searching for that relationship that units Art with Music, this applied study is seeking in its collective assembled artworks which were exhibited in a solo exhibition under the title "*In the presence of a tune*", to discover the visual stimuli in Assemblage art and what resulted from it in terms of design values that brings the senses closer to feeling music through recycling components of some ruined musical instruments.

---

- This is an Open Access article distributed under the terms of the Creative Commons Attribution-Noncommercial 4.0 Unported License, permitting all non-commercial use, distribution, and reproduction in any medium, provided the original work is properly cited.

- Selection and peer-review under responsibility of the Organizing Committee of the Conference

© 2022 Published by ISRES Publishing: [www.isres.org](http://www.isres.org)



## **Method**

Design is the process of translating an idea into an art (fact) ,” in its broadest sense, design is preparing for action: planning and organizing.” (Pipes, 2008).The artist/designer has the skill of thought and visual planning, as well as the ability to reformulate the components and parts of his artwork to achieve the goal of his design which in turn, makes the role of the designer and the design process, of great importance in the creation of any work of art whether it’s related to painting, sculpture, architecture, or other art forms.

Many artistic movements such as “Arts & Crafts”, “Art D’eco” and “The Bauhaus School”, agreed on the importance of the functional aspect of design and on the need to link art forms to each other. In addition, a great deal of attention was paid to the deployment of material in the artwork which later led to the introduction of the term “Visual Arts” that combined plastic arts with applied arts, so that the boundaries between the artistic fields become more flexible. By doing so, it became possible to describe a work of art combining Design with Music, or Painting with Theater Arts, or Sculpture with Environmental Art, among others.

The reciprocal relationship between the visual arts of all kinds has been, and continues to be, a fertile field for artistic creativity.” As in the relationship between visual arts and music, there are also common terms such as composition, rhythm and range in relation to design and music.” (Olgen, 2019). This study is based on the employment of common visual values between design and music as a basis for creation of the assemblage panels. The author’s vision here is represented in employing the art of assemblage based on recycling of musical instruments, as an experimental approach to design. This study is also relying on a conceptual premise that corresponds with the artistic achievements of assemblage artists in search of what effect, viewing a musical instrument in assemblage artwork, has in terms of meanings, memories, and feelings associated with sound and melody in the collective memory of individuals.

My hypothesis here can be summarized as follows:

- The emergence of Assemblage art is due to the clear shift in artists’ attitude towards the society’s developments and daily life events.
- The established relationship between Art and Music in some artistic movements, attests to the portrayal of a musical instrument in different assembled styles.
- Assemblage art is the first nucleus of “Recycling” in art.
- An experimental approach to design can achieve sustainability for used materials and produce creative artworks.

### **The Art of Assemblage between Technique, Material, and Semantic Links**

Technique has a fundamental role and a direct effect in any artwork as it represents the artist’s ability to adapt his material and implement his ideas. Technique is a complex process which requires the artist to visualize the aesthetic beauty of his creative idea, to make some decisions relating to a diverse selection of materials and techniques, then, adapting them to his stylistic imprint in an artistic product characterized by independence and individuality.

Materials of all kinds are the physical medium through which the elements of an artwork are organized. Depending on the extent to which the artist is successful in employing materials to serve form and content, the aesthetic value of an artwork is achieved. Materials have sensory and compositional properties that serve as creative stimuli which constitute a visual attraction factor that is free from common formative molds. The internal energy of the material which relates to its density and qualitative weight, emphasizes its formative abilities. The artist relies on those abilities to determine which structural preferences to use for his compositions based on what a certain material would give him versus another.

The broad artistic achievements of Modern Art from the late nineties and early twentieth century, are a clear testimony to what’s mentioned above concerning the emergence of raw materials and unfamiliar techniques which coincided with the industrial revolution accompanying the emergence of many scientific discoveries and philosophical theories that came as a result of WWI and WWII. Research and discovery in a variety of materials and technical practices became a method of experimentation suitable with contemporary intellectual dimensions. While keeping in line with the cultural age of freedom and advances in many art fields to the degree which it was described as the age of rebellion over traditional inherited ideas, or the age of raw material conquest over a painting’s surface. This conquest of material over a painting’s surface appeared with the beginning of Cubism

when *George Braque* and *Pablo Picasso* used layers of newspaper, magazines and wallpaper combined with “Collage” techniques, to stay in contact with the rapid transformations in art, science, and the ensuing social, political, and economical changes.

The law inherent in “Cut & Paste” style of objects as a visual language summarizing abstract shapes through stylistic methods, opened up a broad scope for experimenting. This was characterized by a deconstructive vision of elements with cubists. Paper Collage or Photography Collage which was known as the “Photomontage” technique, continued to express the actual existence of objects, and images that transform its meaning to another meaning through Juxtaposition. “In which an image is placed in one context with adjacent images to form the idea of an artwork, or placing an idea in the context of another idea to form a topic.” (Ragheb, 2017).

Collage as such took a conceptual form that developed concretely with the works of Dada artists, with the likes of *Hana Hoch* and *Raoul Housman*, when its was used as a way to portray or to oppose certain policies and critical issues in their societies. However, with the development of the concept of “Pasting” into the assembly of stereoscopic and protruding materials, the allegorical capacity of glued materials increased. *Fergonzi* states, “That collected and reused objects with an inherit potential for expression, worked on the extremely subtle borderline between iconoclasm and the re-semanticisation of form” (Fergonzi, 2007). Therefore, the responsibility of delivering the intellectual content or philosophy of an artwork as a whole, lies with the use of raw materials on a painting’s surface.

Collage evolved into a three-dimensional form with Assemblage Art, with which the artist got rid of the restrictive concepts of art. Collage served as a new variable that expresses the clear shift in a liberated artist’s position to express his artistic message. Thus, creating a language of dialogue that deliberately represents the exact reality by adding what it represents of materials and ready-made objects on the surface of the painting.

Object art or the assembly art was known as “Assemblage Art” by *Peter Selz* and *William Seitz*, when the latter defined it according to the works exhibited at a gallery held in 1961.” It was defined as; firstly, compositional works uncolored, not drawn nor framed, nor decorated. Secondly, its compositional elements are either wholly or partially composed of natural material and/or manufactured pre-formed material, or parts of an entire object which were not intended to be artistic materials.” (Soliman, 2021). “Using societal Costoffs in the Assemblage art has a long history in works by Dada artists like *Marcel Duchamp* and *Kurt Schwitters* and later in the early 1940s by *Joseph Cornell*, whose boxed assemblages creates a new way to present the art. (Maurer-Mathison, 2007).

The technical diversity of the assembled use of objects, and the rejection of the aesthetic concept of artists at that time, was based on rebellion not against form, but against traditional ideas in the expression of society in addition to focusing on chance as a factor, with its positive connotations in representing reality. A reality associated with spontaneity or absurdity of the elements captured from it in its raw form, and used against its connotations. Surrealist *Daniel Spoerri* used tableware to record a moment of human daily life in his collection of assemblage works known as ‘Trap’ or ‘Snare’ Pictures. “In which he fixes the chance arrangement of mobile domestic situations, especially meals, and then tips them through 90 degrees to transform a quotidian surface into a pictorial thing”. (Taylor, 2006). At the same time, *Max Ernst*’s works combined oil painting on the painting’s surface with the assembly of some stereoscopic elements added to its surface to give a surreal tint to the drama of the scene. From it, we gained a tangible sense of the taste and texture of the material in its symbolic connotations. The idea of assemblage adopted many artistic movements that emerged in the mid-twentieth century and that in one way or another, suited the social changes and consumer culture. It also expanded the use of discarded or thrown-away objects with “PopArt” artists and the emergence of New Realism. American artist *Robert Raschenberg*’s proven skill in removing barriers between two-dimensional and three-dimensional objects, along with incorporating the meanings included in his assembly paintings based on “Relief” known as “Combines or Combine Paintings”.” One might describe them as the icons of the day, or as visual mnemonics.” (Osterwold, 2007).

This research study found that the huge diversity in the works of assemblage artists cannot be fully addressed within it and that some of what was presented previously, demonstrates how the art of assemblage as an experimental practice in art, has not been separated from reality with all its variables.

Assemblage art in many of its connotations, was used to establish artistic models that mostly arouse the elements of astonishment and surprise in the formulation of artwork, which varied according to the offerings of the natural and industrial environment. Whether these offerings were organic natural materials such as (foliage, wood, bones, sand, stone) and/or with industrial materials such as (glass, ropes, wires, etc).”However, if the

artist purifies these objects from the functions assigned to them in their production, these objects will be separated from the axis of 'reality', and will regain identity with different codes in the context of the artist's thoughts and idea." (Susuz & Ozturk, 2019). It is worth noting that assemblage works have taken more than one artistic form which can be classified according to the technical development on the surface of the painting, and the diversity of its materials to:

### First: Assemblage Works Associated with the Surface of the Painting

Meaning works that combine more than one added, and readily made, material that occur prominently on the surface of the painting so that the angle to view the work is optimal at 180 degrees, which are in turn divided into:

- Synthesis works whose technical performance is characterized by the use of materials in their natural colors without interfering with the material of color. This is evidenced in the works of artists like *Enrico Prampolini*, *Josef Albers*, and Egyptian artist *Efat Naghi*.



Figure 1. Enrico Prampolini-Béguinage, 1918



Figure 2. Josef Albers-Untitled, 1921

- Synthesis works whose technical performance is characterized by the use of materials painted or formed by the artist. Materials in these works appear to have lost their basic significance of shape or color, and have taken a monochrome or multi-colored figurative form. This form of three-dimensional materials installed on the painting and integrated with the elements of composition, are shown in the works of artists like *Louise Nevelson* and *Hans Arp*.



Figure 3. Hans Arp-Plant Hammer, 1916



Figure 4. Louise Nevelson-Royal Tide II, 1961-1963

- Assemblage works linking the fields of photography and sculpture. By composing the assembly works in such form, we cannot describe them as an oil painting or a sculpture work. The models on the surface of the work are blurred by color in some of its parts in order to mix with the background of an artwork in a pictorial style. Then return to make changes and contrasts on the fabric of the artwork with its compound structure, so that it is difficult to classify.

There is a so-called sculptural photography and color sculpture (Relief), like the works of *Sam Gilliam* (1933-2022) and *Frank Stella*. I would also like to refer here to the works of Egyptian artists such as *Abdel Rahman Elnashar* and *Ahmed Nawar*.



Figure 5. Frank Stella-Kastura 1979

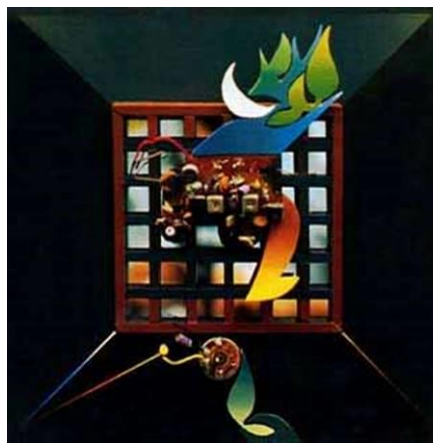

Figure 6. Ahmed Nawar-Human and energy, 2004

## Second: Three-Dimensional Assemblage Works

These types of work are characterized by the application of the technical assembly and installation of parts, used equipment, industrial waste and junk. Along with the use of raw materials and waste to configure installation works or "Constructions", which is a constructive technique based on the creation of three-dimensional bodies that can be viewed at 360 degrees. As shown in the works of *Jean Tinguely*, *Fernández Arman*, and Egyptian artist *Abd Elsalam Eid*.



Figure 7. Jean Tinguely-Baluba No. 3, 1961  
1.42×54×64 cm



Figure 8. Abd-Elsalam Eid-Horizons in a Changing World,  
2008

This study with its applied aspect is consistent with the first type, whose assemblage works are related to the surface of the painting. As it recycles used musical instruments through the methods of design formulation, relying on the physical presence of the actual musical instrument's body. Combined with the formation method of some specific media, this demonstrate the sense of sound and tonal rhythm of music as materials that do not have a tangible physical presence.

The artistic output as such is consistent with the concept of sustainability, that preserves part of the cultural and artistic heritage by developing its available neglected or used resources in the production of creative bodies.

## **Assemblage and Recycling in Art as a Starting Point for Sustainable Development.**

This current study demonstrates the Art of Assemblage in such way that recycles used or perished materials with all its kinds as the first nucleus of the emerging idea of recycling, that has growing needs in our current society with the adoption of the term “Recycling”. Recycling in general, involves collecting discarded, used and throw-away materials with the intention of transforming them into new products. Generally, recycling involves collecting discarded, used and throw away materials to convert them in transformation process for making a new product.

Some of the opinions see that “most recycling is actually downcycling; it reduces the quality of a material over time” (McDonough & Braungart, 2002). From this point of view we need to improve the way we perceive recycling to match the concept of “better than eternally reusing materials at the same quality, we can improve the quality of materials through use. Instead of downcycling, we upcycle, making used materials more valuable.”.(McDonough & Braungart 2002). This obtained value is the link that explain why assemblage art is considered as an upcycling process. Nevertheless, “Recycled Art has been organized to demonstrate the creative use of recycled materials and found objects in contemporary regional art” (Mansour et al., 2018) .

Assemblage makes use of waste, used objects and discarded materials. “ The incorporation of waste materials into artworks follows trends that predate the emergence of sustainability as a theme for artistic practice” (Thompson, 2021). In “1987, the United Nations Brundtland Commission defined sustainability as “meeting the needs of the present without compromising the ability of future generations to meet their own needs.” Here, sustainable art is defined broadly as “creative activity that takes its relationship to social and ecological domains into consideration throughout each phase of the creative process” . (Thompson, 2021).This concept is consistent with the practices of assemblage artists, but their artwork has often been associated with many concepts through their symbolic methods that satirically summarize their interaction with reality in many artworks.

If sustainability is a drive for survival, assemblage also is a survival skill which reused discarded materials and objects in accordance with the considerations of sustainable development. As well as from an economic point of view in terms of its’ use of recyclable materials and objects. Also, from an environmental point of view through the possibility of dismantling perishable products with the aim of facilitating their recycling, and lastly, from a social point of view as an art that elevates human feelings and respects the human right to enjoy life. Assemblage art has an instinct for survival, which took more sustainable forms when its effect extended to many of the recent modern arts during the twentieth century such as the movements of “Environmental Art” or “Green Art”, where environmental friendly materials were used in many artworks in a assembled manner. There is a substantial need for innovation and creativity where sustainable design enforces its importance in both visual and application arts. “Design has a unique key role to play in achieving sustainability through building architecture, service/product design, and graphic design” (Ivanaj et al., 2012). This research demonstrates a point of view which reconfirms the importance of experimental approach in Design to achieve sustainability in assemblage artwork. In addition to the importance of design in many types of visual arts, one of which is addressed by this study. According to what this research paper dealt with on the different formulas of assemblage artworks through concepts that bring it closer to the novelties of life and the variables of reality, and other concepts that may intentionally or unintentionally guarantee the cause for sustainability.

The role of design is also made clear through this study. A role aimed at reformulating many valuable used musical instruments in the production of assemblage work, in which design is preoccupied with the search for the sensory values underlying the design relationships and harmonies of material and shape on a painting’s surface as visual stimuli. Experimental input is taken from the art of assemblage which rediscovers the aesthetics of musical instruments through the composition and distribution of its parts.

### **Musical Instrument in Assemblage**

The relationship between Visual Arts and Music varies a lot, and takes several forms and artistic styles in many artistic movements, all of which unite in their power to evoke an emotional response. Visual art and music have numerous parallels because they share elements such as harmony, balance, rhythm, and repetition. These elements transcend the sense of sight and hearing, and awaken in one’s self a multitude of sensory and human experiences. This dates back to 1910 with the emergence of a special kind of relationship between art and music in the works of the abstract artist *Wassily Kandinsky*, that opened a space for mutual metaphors between art and music when he named his paintings after certain symphonies, and called colors with special analogies to musical vocabulary.

*Kandinsky* also discovered the importance of rhythm and geometric construction in the repetition of tones. As well as the introduction of movement of shape and colors in his abstract artworks with the purpose of satisfying the spiritual aspect of the artist and the viewer. He stated in his book "*Spirituality in Art*" published in 1911 and later translated to Arabic in 1914, "that relationships in the artwork are not necessarily relations in the external form only but relationships based on internal empathy for meanings."

The musical instrument was used as a medium in the assemblage works combining both music with its material sound, and art with its material form, through the composition of its parts. The first appearance of the musical instrument in its raw material was in *Picasso's* collage works that later evolved into three-dimensional structures of metal and paper reproductions. *Picasso* constructed a guitar out of cardboard sheet creating negative and positive forms. "Other guitar reliefs vary the strings and the resonator board, have zig-zag folds or play with the appeal of variously colored cardboard. The unified surface of the image is surmounted, as is the imitative or imaginative modeling of mass" (Schneckenburger, 2005). The Cyrillic artist "*Man Ray*" used in his assemblage works just one part of a musical instrument, with the complete absence of the remainder of its parts. Along with the addition of shapes or materials that are completely contradictory to the musical context in order to provoke different surreal concepts, approximations between apparatus and the anthropomorphous, the aggressive, menacing, dissecting cruelty of the anatomic cut, floating and oscillating. Indeed, in comparison to his controversial epigrammatic objects. Arman Fernandez with his large productions of musical instruments and their parts in many artworks that combine flat canvas and sculptural assembly work with a massive use of materials, plastics and fiberglass resin.



Figure 9. Pablo Picasso-Guitar, 1912



Figure 10. Man Ray-Emak Bakia, 1927



Figure 11. Arman, Abacale Guitar, 1994



Figure 12. Arman, Colère de Violon, 1966

While the destruction of a single object such as a musical instrument conveys pathos imbued with the memory of sound reconceptualized in a pictorial arrangement (O'Neill, 1996). The Appearance of musical instrument continued in the assemblage practices of many artists, some artists used the surface of the musical instrument occasionally as an alternative to a painting's surface and added to it many materials. Other artists used the method of dismantling and reconstructing its parts either for an aesthetic or philosophical purpose, or as an artistic practice that may have been devoid of content.

## **Results and Discussion**

The Author of this research study has organised a solo art exhibition under the title "*In The Presence of a Tune*", which was held in the exhibition hall at the Faculty of Specific Education – Alexandria University, Egypt. The exhibition included 13 works of art, 5 of which were gifted to decorate the floor of the Department of Music Education inside the faculty. The design formulation of the artwork is relying on the experimental approach based on the recycling of used musical instruments through one of the technical methods of the Assemblage art. All artworks emphasised the surface of the painting as an assembly frame for the components and elements of the artwork's design, to achieve an optimal vision of the artwork when viewed at 180 degrees.

The diversity in the formulation of artworks is due to the designer's choices in the pictorial organization of musical instrument's parts. As well as the preferences of composition, symmetries of visual values, and the spatial positions of the varied formative elements available. All gathered up to establish a visual stimulus which leads to the realization of the conceptual value of the artwork. Abdel Hamid states that: "A fully comprehensive design in the fundamental mean to reach orchestral composition among elements within an artwork" (Abdel Hamid, 2001).

The possibility of combining Design and Assemblage art is realised from a technical standpoint due to the physical presence of materials, and from a conceptual standpoint as an art which holds many clues and connotations behind its deployment of material. And lastly from an economical standpoint in terms of its dependence on low-cost used musical instruments that can be recycled into new artistic forms (moulds).

### **The Collection of Artworks in This Research Study Focused on:**

**Ideological Perspective:** That examines the relation between Design and Music, and its association with sensory meanings and experiences of its recipients.

**Experimental Perspective:** That depends on the technical use of materials through the art of Assemblage.

**Visual Perspective:** That is achieved through the composition, structural axes and design values resulting from the addition of three-dimensional materials on a painting's surface.

The choice of some types of used musical instruments is up to the designer, utilising what's available in the vicinity of his environment. Those choices could vary between the use of stringed instruments such as Oud, Guitar and Violin, or woodwind instruments such as Accordion, or percussion instruments such as Drums and Tambourine.

Design formulation of artworks depends on the musical instrument as a fundamental element in design through:

- Machine Fragmentation (fig.13,14,15,23,24)
- The presence of the entire instrument (fig.16,17,19,20,21,22)
- Suggestion using an instrument (fig.25)
- Complete absence of an instrument (fig.18)

The author of this study used discarded musical instruments in composition as it conforms with the three main principles of the ideology of form in constructivist thought. First of tectonics, or the functional use of industrial material; then construction, or the Communist functionality of tectonics; and finally faktura, now in the somewhat altered meaning of 'the conscious choice of material and its appropriate utilization without impeding the dynamics of construction or of tectonics It is made clear in the subsequent collection of assemblage artworks the use of analysis method based on revealing the role of visual values and design foundations, resulting from the designer's choices in his distribution of elements and the structure of composition.

The peak of visual excitement is achieved through the special arrangement of major points of interest present in the musical instrument, as opposed to the lesser points of interest in the background of the painting. The spatial relationships and orientations in both the instrument's holographic form and the added elements involved, play an important role in the structural composition and the sense of movement. Through which, flow the sensory feelings implicit in the sensation of tone or rhythmic vibration of sound.

Composition is the pleasant arrangement of elements within a frame which give the most powerful ability to attract the eye, and to keep it exploring within the frame for as long as possible (Kadry, 2017).



Figure 13. Oud I (120x96 cm)

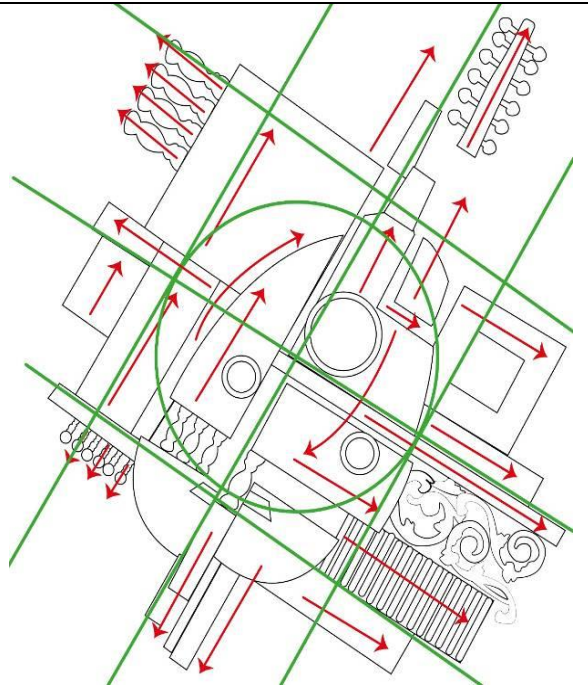

Figure 13-1. Main axis of design structure

Figure 13. Oud I

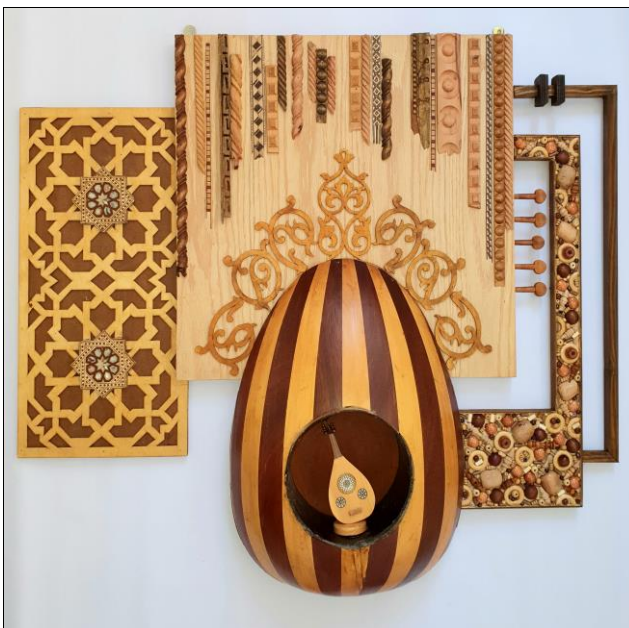

Figure 14. Oud Ribs ( 80x90 cm )

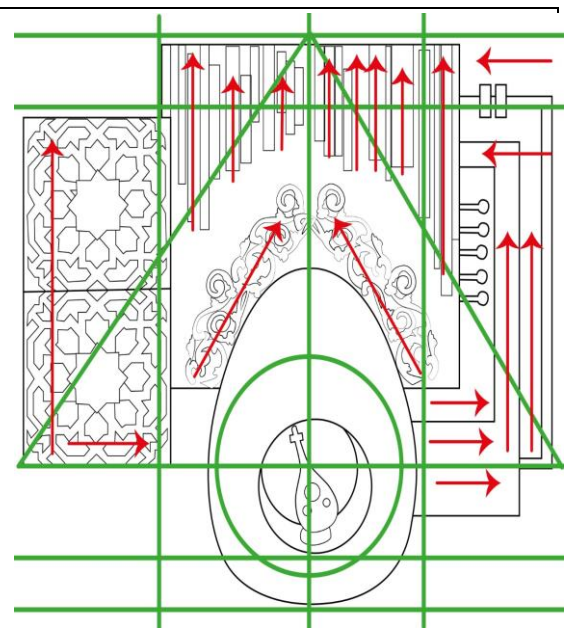

Figure 14-1. Main axis of design structure

Figure 14. Oud ribs



The Oud was split vertically into two parts, and its back was separated from its front and then used in another artwork. The body of the Oud was also entirely separated into 8 pieces. The Oud was then fixed at approximately 45 degree angle. Gaps were introduced between separated pieces, with upward or downward adjustments, in a symmetrical manner in order to create space for movement to imply sound being released. The protruding Islamic decorative units which were fixed on the surface of the painting had varied height to imply the oriental tones released from it. The void depth was achieved between the actual spaces on the instrument's body to strengthen the sensation of lost depth from lacking the Oud's back part. Tilted axis contribute to the sensation of movement while geometrical spaces on the Oud's background balances the decorative density and increases the artwork balance.

The concave back part of the Oud was used after a round hollow space was carved out at its center, with a miniature Oud model instrument fixed inside it. The incomplete body of the Oud instrument was suspended from above opposite a square panel decorated with wooden columns of variable length. A rectangular arket wooden space, decorated with Islamic patterns, was added to the left hand side to achieve balance with the hollowed space to the Oud's right. A rough texture along with some ornate pegs repeated in a decorative manner, was used on the right hand side. The geometrical ornaments adorning the top of the Oud, was arranged to resemble a crown with its peak pointing towards the wooden columns. The miniature Oud model fixed inside the circular hollow space is an attempt to clarify the source of melody emission. The oriental decorative rhythm emphasizes the authenticity of the Arabic melody.



Figure 15. Accordion I ( 90x78 cm )

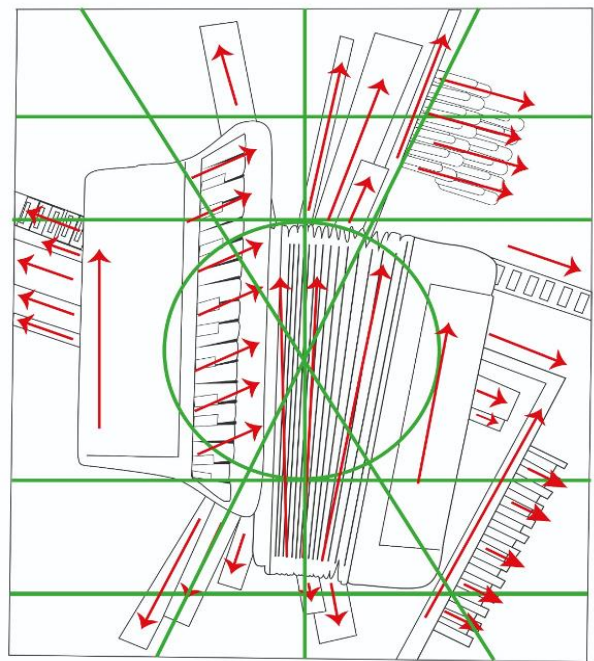

Figure 15-1. Main axis of design structure

Figure 15. Accordion I

The instrument is split into two parts, with the orientation of one part reversed so that its keys are facing upwards toward the spectator. Some of the Bass and Treble Reed block sets were used with rhythmic repetitions while the background's surface underneath was spread on inclined axes. Perpendicular slides in the center of the instrument were used to draw attention to the Bellows, and the release of the air leading to producing audible music. The Accordion native colors were also used in the artwork background. Specific orientation of lines increase the emphasis on the release of sound in space

This assemblage artwork has no frame, and the Guitar position is pinned perpendicular to the axial shapes behind it. This assemblage artwork combines the Guitar's material, materials of the mosaic and stained glass. The pale silver color along with the crumbled texture of the instrument and the luster of the added materials, all have a visually appealing richness of texture. The golden stains on the surface of the Guitar and in its sound hole, provoke in the viewer a sense of nostalgia for his pleasant memories. The gradual prominence of shapes has also different silhouette values.

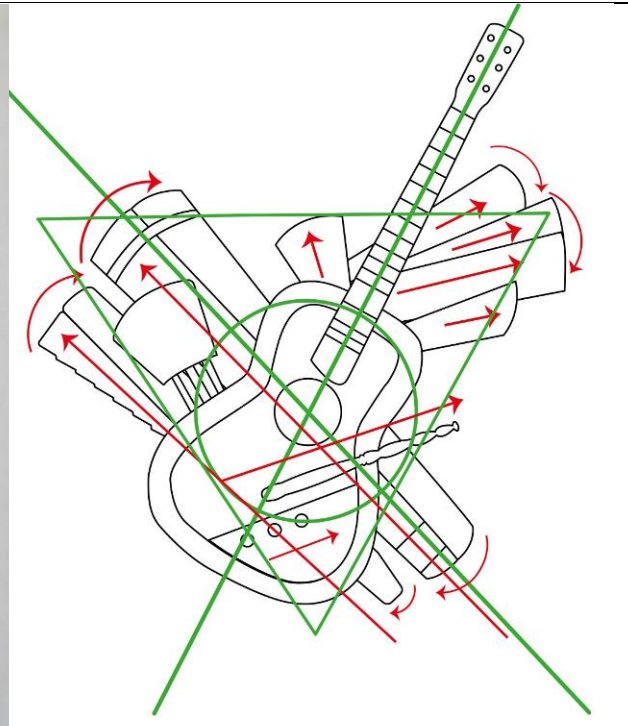

Figure 16. Guitar I ( 95x77 cm )

Figure 16-1. Main axis of design structure

Figure 16. The guitar I

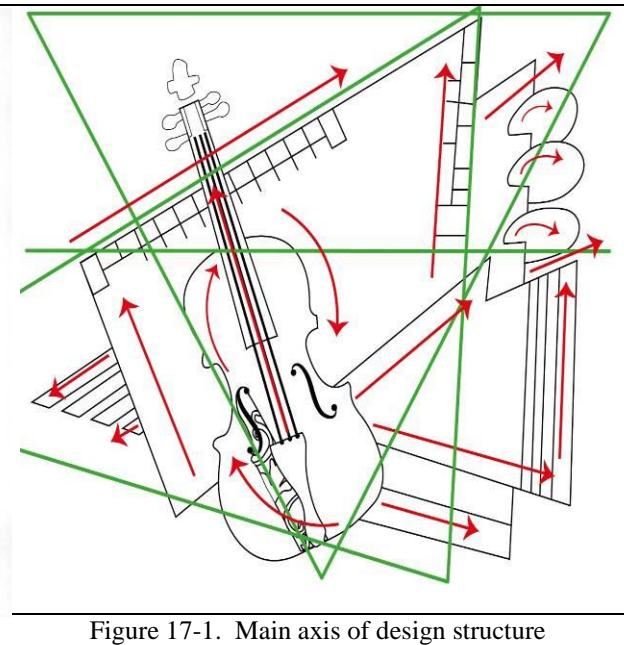
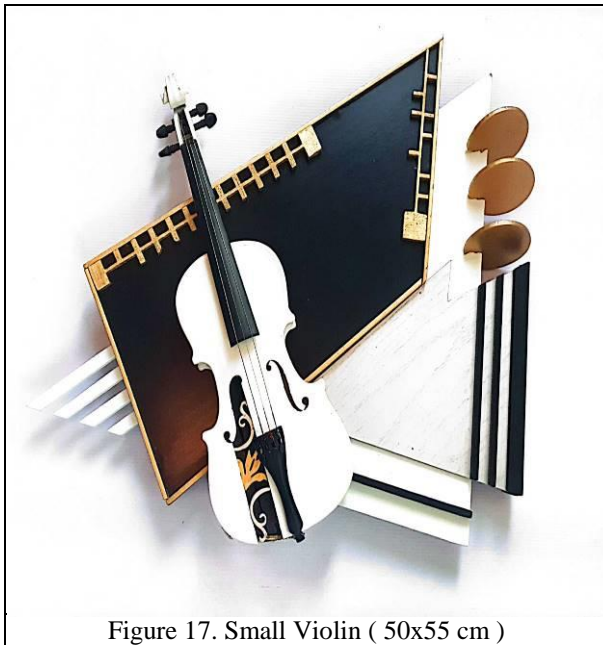

Figure 17. Small Violin ( 50x55 cm )

Figure 17-1. Main axis of design structure

Figure 17. The small violin

The instrument here is tilted against a multi-level background with the semi-rectangular shape fixed above the triangular space. Some simple organic motifs are employed in the broken notch. There are also linear repetitions of various thickness surrounding the violin's perimeter.

The repetition of the three circles in a semi-vertical position breaks up the sharpness of the artwork's square edge. The repetitive decorative tone in the intersecting lines has a tactile richness while the decorations apparent in the broken space emit a sense of tonality. Lines facing left outside the shape give the tone a wider space to spread.

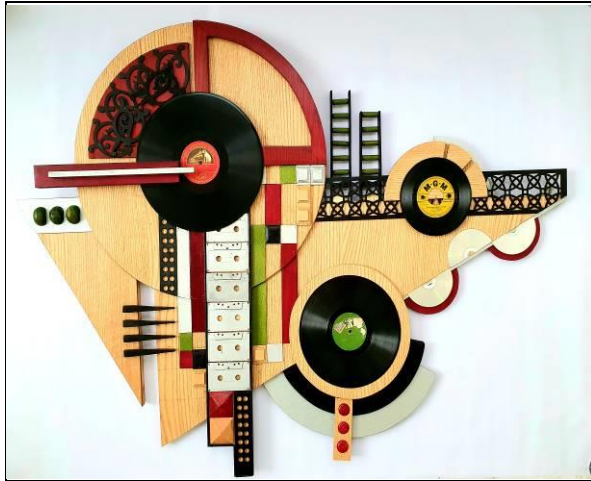

Figure 18. Music Media ( 100x120 cm )

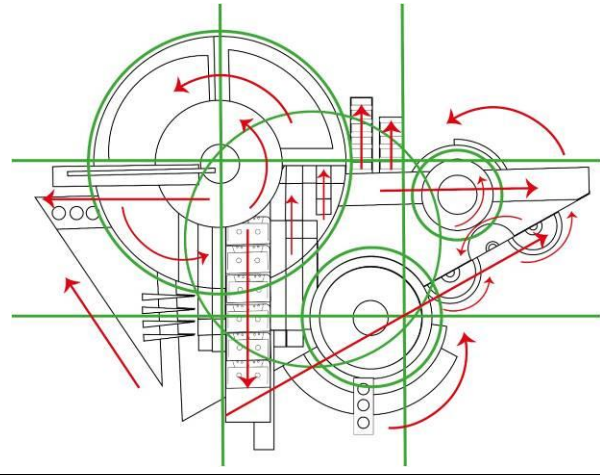

Figure 18-1. Main axis of design structure

Figure 18. Musical media

The compositional materials of acoustic media like CDs, vinyls and cassette tapes are frames to preserve music. The instrument disappeared from the artwork and left its effect to forever be in multimedia. The design structure with its perpendicular vertical and horizontal lines, signify the purity and quality of sound. The frameworks of varied thickness surrounding the three vinyls have regenerating dynamic movement. The lateral gradient of the two raised platforms points to the gradient rhythm of the vinyls. The rhythm of the multi textured ornaments appear as selections of oriental music.



Figure 19. The Guitar II ( 105x120 cm )

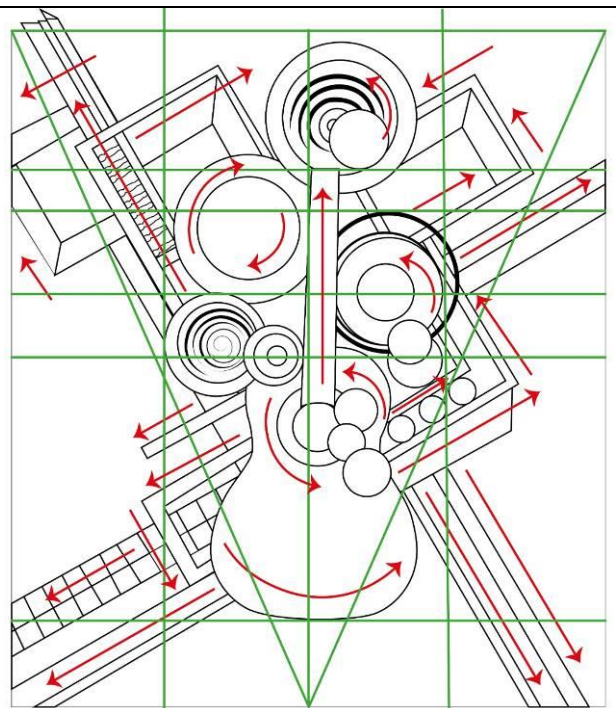

Figure 19-1. Main axis of design structure

Figure 19. The Guitar II

The structural composition of the Guitar's background includes linear paths of various geometrical shapes. Flat shadowy spaces underneath protruding linear paths adds illusionary depth to the real depth. The black neck of the guitar appears as a magnet that polarized an array of circles around it. Those multi-level circles contain diameters of smaller size circles with a spectral depth which suggests leveled musical notes frequencies. The leaning ascending and descending decorated lines at the painting floor, are orchestral background tunes which through it, a musical symphony is complete. The leaping stereoscope on the panel's surface has an appealing visual effect.

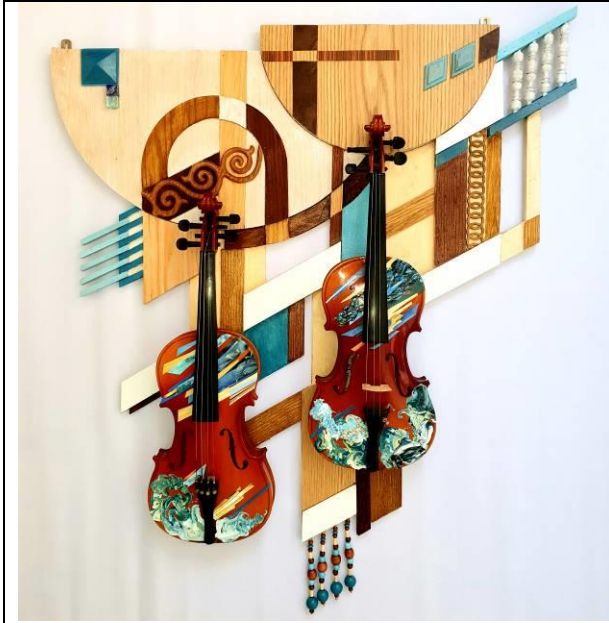

Figure 20. 2 Violins ( 100x82 cm )

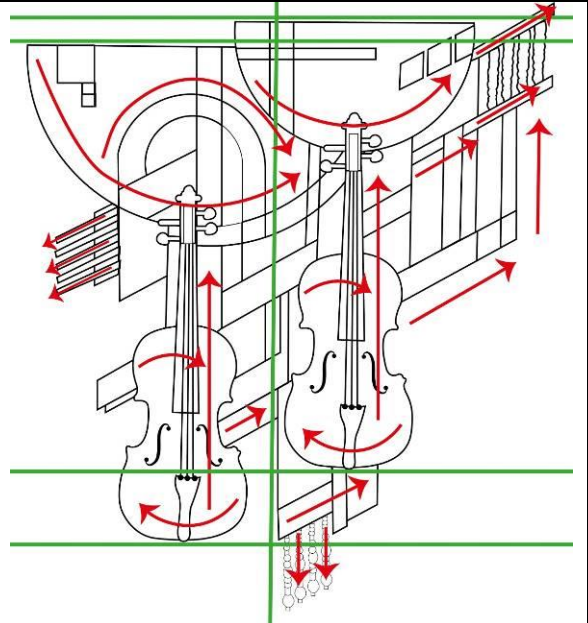

Figure 20-1. Main axis of design structure

Figure 20. Violins

This Artwork features two Violins with one of them placed higher than the other. Half round circles can be found above each Violin as if they were halos granting a share of distinguish and specificity. The background is designed on tilted and vertical axis with distinct geometrical composition. The front of the Violin was decorated with layers of paper applied according to collage technique, and with colours applied according to Marbelling technique. There are some groups of repeated beads lines placed at the bottom, right and left of the painting. The pictorial repetitions of the Violins and half circles gives an impression of mutual musical dialogue. The organic lines in the curves of the Violins's shape facilitates the flow of rhythm around space. This Artwork can be classified as an interactive panel where the spectator can pull the strings and enjoy the sound.



Figure 21. The Guitar III ( 122x106 cm )

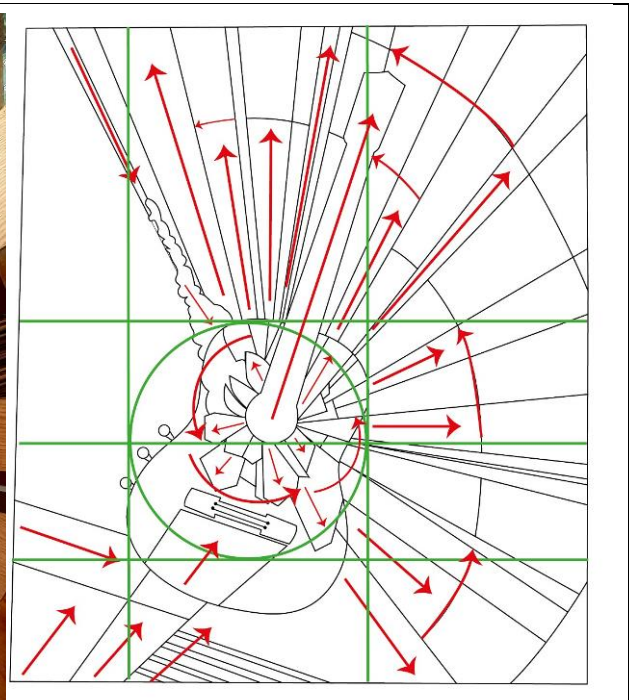

Figure 21-1. Main axis of design structure

Figure 21. The Guitar III

All lines and spaces emerge outward from the sound hole to the exterior of the design. The radiating composition point emanates as well from the sound hole. The repetition of dark and light color gradients in the Guitar's background, accompany the rise and fall of tone emanating from the center of guitar's cavity. The sensation of the time distances carrying the tones appears through the illuminated space in contrast to the dark and repetitive spaces. Stained glass and spilled colors attract the eye to the depth of the sound hole. Some stained-glass balls are glued inside the sound hole to reflect the tone outwards while some simple linear repetitions from the bottom of one corner head inward simulating external tones.



Figure 22. The Twin ouds ( 85x95 cm )

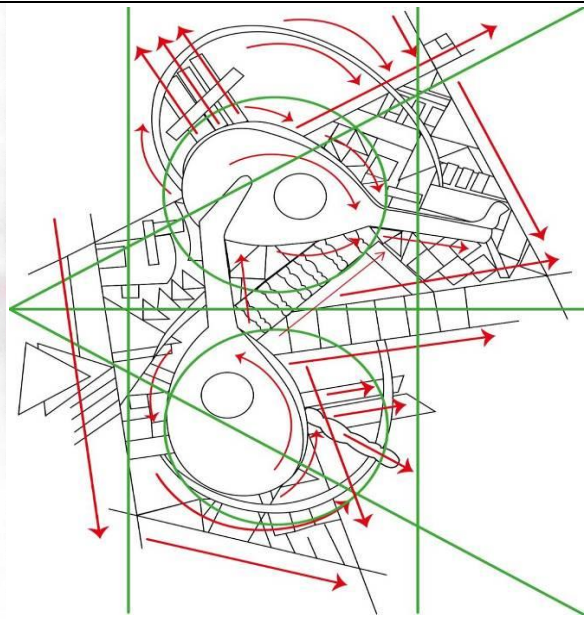

Figure 22-1. Main axis of design structure

Figure 22. The twin ouds



Figure 23. Oud III (100x95 cm )

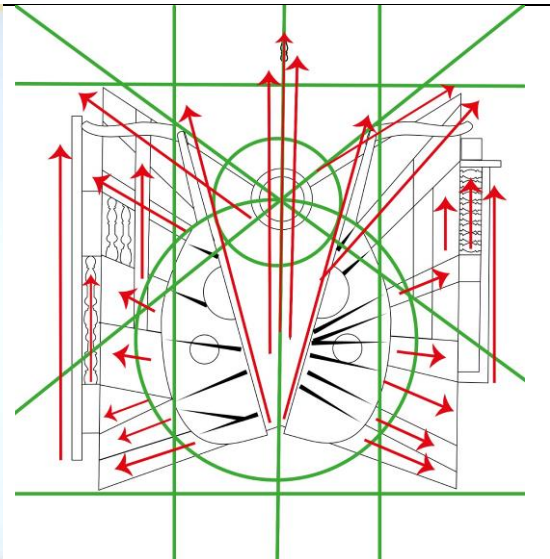

Figure 23-1. Main axis of design structure

Figure 23. The oud III

The components of the artwork here are in a vibrating and continuous movement through shape, line, and texture. The two small Ouds are fixed at different angles of inclination. The contrast in color and the doubled instruments, are paired duos aimed at equalizing the visual weights. Textures are achieved through the diversity of shapes on the artwork's background. The curved arcs around the instruments emphasizes the vitality of the

movement while the dynamics of shapes and movement of the dual Ouds in the design construction, suggest a dancing tone. Irregular color stains on the two Ouds' surface in silver and gold colors are purposely placed to add a royal touch to the authentic instrument.

The Oud here is split into two symmetrical halves; the radiant organization is illustrated by the Oud and the division of spaces on the painting's floor. The two halves of the Oud are fixed with distance between them widening at the top. The small circle in the upper half heads outward as if it were on a journey into space while the two halves of the Oud are filled with Arabesque pieces to enrich the oriental nature.

The balance appears through the semi-symmetrical design and the equal distribution of elements and spaces. The depth of space between the Oud's two halves is caused by the elevation of the Oud's body off the surface. The axis at the center of the artwork and the small circle above, increase the sense of tone emanating among the arabesque pieces.



Figure 24. The Accordion II ( 105x95 cm )

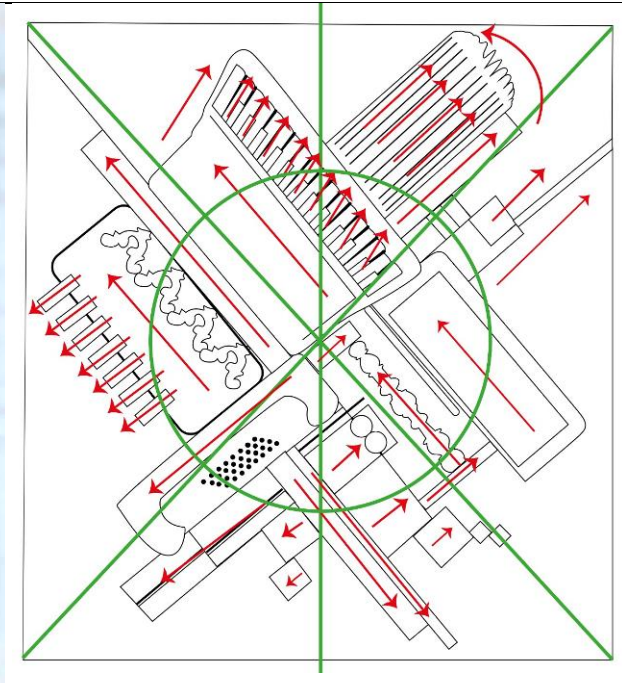

Figure 24-1. Main axis of design structure

Figure 2. The Accordion II



Figure 25. Drum ( 80x75 cm )

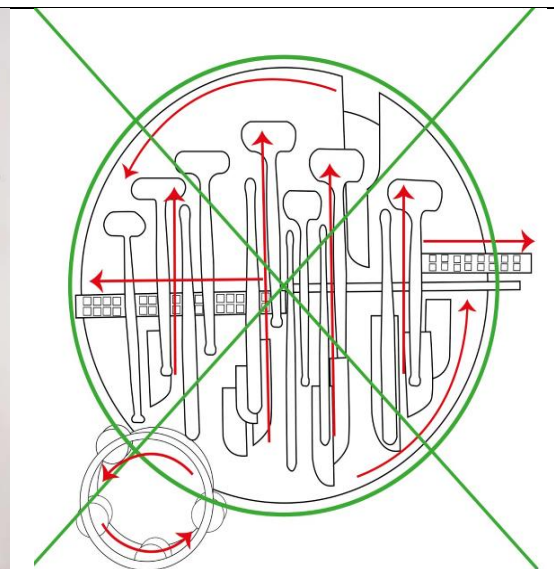

Figure 25-1. Main axis of design structure

Figure 25. Drum

The structural formula in the artwork relies on the rearrangement of the Accordion parts and its internal components. The Accordion is divided into 4 parts with some added wooden ornaments and materials such as a mirror, ceramic pieces, and some metal pieces. The variable heights from the surface along with some cavities, achieve visual pleasure. The textures appear through pattern in geometric and decorative formations. Inclined and intersecting axis rise and fall as if they were time distances necessary for the musical melody to occur. The built structure of the artwork portray total presence of a circular dynamic shape. The smaller circle of the Tambourine is fixed at the bottom left of the circle, and benefits from an interactive aspect through its brass Jingles.

The absence of the drum which the circular shape substitute for, is a deceiving trick to stimulate the senses. The different shape drumsticks are placed vertically with its head facing up at various heights. Some empty spaces in the surface of the circle reveal a golden coloured circle fixed beneath it. The special depth resulting from both circles allows space to echo the drum rhythm for the spectators ears. Some grey pieces were also added to the lower half of the circle painted in black to multiply the shadowy values of drumsticks. The color contrast between white and black in the center of the circle reinstates a rhythmic unity of contrasting strength. The golden hollow layers on either side of the circle, has one elevated slightly higher than the other as if it was affected by the sound vibration. The luxurious golden color reminds us of the drum rolls associated with welcoming royalty.

## **Conclusion**

This study made it possible to identify some of the assemblage artists' styles and different techniques in the art of Assemblage, and their conceptual connotations that often indicate the artist's interaction with reality and life. Assemblage art practices the recycling of used objects and facilitates the production of artworks that have the attribute of sustainability.

This applied study presented a set of assemblage artworks that relied on one of the techniques of Assemblage art which allows the artwork to be viewed at an angle of 180 degrees and recycled some used and ruined musical instruments with a conceptual design vision. According to the findings of this study, it became apparent that Assemblage Art can be considered an experimental approach in design that reveals several visual stimuli, resulting from the employment of materials and techniques. Which in return, led to the elevation of design values and the achievement of visual and sensory pleasure for the viewer.

## **Recommendations**

Encouragement of artists or designers to practice Assemblage Art which facilitates linking the conceptual, visual, and functional aspects. It also provides many opportunities for artistic practices based on recycling of used and discarded materials to reach more sustainable creative results. Researching and experimenting in more artistic practices in the reformulation and recycling of discarded musical instruments because of their sensory and visual components. The linking of Visual Arts and Design is an important experimental approach to enrich the artist's experience and discover many more visual stimuli in the relationship that units various art forms as well as to each other. Directing researchers to track the artistic development of Assemblage Art in artists' artworks, and its impact on other art forms such as Green Art and Environmental Art, to reach new research advances in the field of visual design.

## **Scientific Ethics Declaration**

The authors declare that the scientific ethical and legal responsibility of this article published in EPESS journal belongs to the authors.

## **Acknowledgements or Notes**

\* This article was presented as an oral presentation at the International Conference on Science and Education ([www.iconse.net](http://www.iconse.net)) held in Antalya/Turkey on November 15-18, 2022

## References

- Abdel Hamid, S. (2001). *Aesthetic preference* (p.272). The World of Knowledge, Al-Qahera,
- Albers, J. (1921). Catalogue, *glass, color and light* (pp. 39-40). The Internet Archive.
- Eid, A. (2011). *Abdel Salam Eid* (p.334). Farsi Foundation For Arts & Culture Sponsors.
- Fergonzi, F. (2007). *Collage collages from cubism to new dada* (p. 327). Electa, Milan.
- Fernandez, A. P. (1994). *Abacale guitar*. <https://www.artsy.net/artwork/arman-abacale-guitar#:~:text=His%20work%20has%20sold%20for,of%20Art%2C%20among%20other%20institution>
- Fernandez, A. P. (1996). *Colère de violon*. <https://www.artsy.net/artwork/arman-colere-de-violon-7>
- Kadry, A. (2017). The role of composition in advertising design, *Journal of Applied Arts & Science, Domietta University* (p. 2). Egypt.
- Mansour, H., Al-yahyai, F., & Heiba, E. (2018). The recycling concept in art education at Sultan Qaboos University. *Journal of Education and Social Development*, 82-87.
- Maurer–Mathison, D. (2007). *Collage, assemblage and altered art* (p. 77). Watson-Guption, New York.
- Mc Donough, W. & Braungart, M. (2002). *Cradle to cradle. Redesigning the way we do things* (p. 56). North Point Press, USA.
- Moroz, S. (2019). Plant hammer, *The Nature of Arp*, 7.
- Nawar, A. (2004). Human and energy. <http://www.fineart.gov.eg/eng/cv/works.asp?Ids=580&whichpage=1&pagesize=6>
- Nevelson, L. (1961-1963). *Royal tide II*. <https://whitney.org/collection/works/428>
- Olgen, B. (2019). The projection of relation between design and music in space, *The Projection of Relation between Design and Music in Space*, 66.
- O'Neill, R. (1996). *Arman conceptual perception*. Solo Exhibition Catalog.
- Osterwold, T. (2015). *Pop art* (p. 150). Taschen, Kolen.
- Pipes, A. (2008). *Foundation of art and design* (p.9). Laurence King Publishing Ltd, UK.
- Prampolini, E. (1918). *Béguinage*. <https://www.pinterest.com/pin/enrico-prampolini-it-18941956-bguinage-1918--326229566761746064/>
- Ragheb, Y. N. (2017). Experimental approaches in the education of contemporary visual arts (pp. 5). *Seventh Scientific Conference of the Faculty of Art Education*. Helwan University, Egypt.
- Ray, M. (1926-1970). *Emak Bakia*. Retrieved from <https://www.imj.org.il/en/collections/194400-0>
- Schneckenburger, S. (2005). *Art of the 20th century* (Vol. 2, p. 429). Taschen, New York.
- Shrivastava, P., Ivanaj, V. & Ivanaj, S. (2012). Sustainable development and the arts. *Int. J. Technology Management*, 60, Nos.
- Soliman, A. E. (2021). Assemblage as a source for the developing contemporary painting technique, *AMESEA*, 7(25), 448.
- Susuz, M. & Ozturk, M. S. (2019). Art in industrialization process: Change and transformations in art after 20th century. *The Eurasia Proceedings of Educational & Social Sciences (EPESS)*, 13, 85.
- Taylor, B. (2006). *Collage the making of modern art* (pp. 34 & 165). Thomas & Hudson Inc, New York.
- Thompson, P. B. (Jan, 2021). *Sustainability: What everyone needs to know* (p. 207). Oxford University Press, UK.
- Thompson, P. B. (Jan, 2021). *Sustainability: What everyone needs to know* (p. 209). Oxford University Press, UK.
- Tinguely, J. (1961). *Baluba No.3*. <https://www.artsy.net/artwork/jean-tinguely-baluba-no-3>
- United Nations. (n.d.). *Sustainability, academic impact*. <https://www.un.org/en/academic-impact/sustainability>

---

## Author Information

### Nashwa Hassan

Faculty of Specific Education, Alexandria University.  
14 Mohamed Amin Shohib, Mostafa Kamel, Egypt  
Contact e-mail: [nashwa.mohamed@alex-speduc.edu.eg](mailto:nashwa.mohamed@alex-speduc.edu.eg)

---

### To cite this article:

Hassan, N. (2022). Assemblage art's visual stimulators based on the recycling of musical instruments as an experimental approach to design. *The Eurasia Proceedings of Educational & Social Sciences (EPESS)*, 28, 19-35.



The Eurasia Proceedings of Educational & Social Sciences (EPESS), 2022

Volume 28, Pages 36-42

**IConSE 2022: International Conference on Science and Education**

## Opinions of Novice Mathematics Teachers on Improving the Teacher Induction Programme

**Tuğba BARAN-KAYA**  
Kirikkale University

**Sedef CELIK-DEMIRCI**  
Artvin Coruh University

**Abstract:** Teacher induction programs are education systems designed to improve the knowledge, skills and mental structures of novice teachers. If we look at the induction program in Turkey, in March and October 2016, some radical changes took place in the induction process. With this change, the number of studies on the induction process has increased, and studies reflecting the views of novices on the induction program, regardless of field, have taken their place in the literature. However, as it is known, the field-specific needs and problems of novice teachers in different fields may change. In particular, it has been revealed that novices in the field of science and mathematics have more special needs than novices in other fields. Based on this idea, in this study, the views of novice mathematics teachers on the development of the induction program are discussed. For this purpose, 27 novice mathematics teachers who have just completed their induction processes were asked to make suggestions for the improvement of the induction program, taking into account their own experiences. The case study method was used in the study and the data were analyzed using the content analysis technique. Findings are presented in the form of MAXQDA maps, and quotations from teacher responses are also included. It has been revealed that the majority of novice mathematics teachers want support for the field. In addition, they stated that there should be mentors from the same field as the novices in the school and in the region, and that opportunities should be offered for them to develop themselves.

**Keywords:** Induction program, Novice mathematics teachers, Program development

### Introduction

Teacher induction programmes are official or semi-official programmes that aim to support the teachers who are in their early years having completed the pre-service training (Beijaard, Buitink & Kessels, 2010). Various studies have demonstrated that well-thought and well-implemented teacher mentoring and induction training programmes are successful in increasing the professional satisfaction and effectiveness of novice teachers (Ingersoll and Smith, 2004). Having looked at the induction programme in Turkey from 1995 to 2015, it is found that it was carried out within the scope of the "Regulation on the Training of Novice Officials" of the Ministry of National Education. Then, in March 2016 and October 2016, some radical changes took place in the induction system. With these changes, the number of studies on the novice teacher training process has also increased (Cam-Tosun & Şimşek, 2018; Gökulu, 2017; Gül, Türkmen, & Aksel, 2017; Hangül, 2017; Kılıç, Babayigit, & Erkuş, 2016; Kozikoğlu & Çökük, 2017; Naillioğlu Kaymak & Sezgin, 2021; Nayır & Çetin, 2017; Önder, 2018; Özen, Kılıçoğlu, & Kılıçoğlu, 2019; Ulubey, 2018). These studies mostly include the opinions of novice teachers about the induction process, in other words, the evaluation of the process. However, induction systems are professional development programmes and they need continuous improvement. Moreover, it is known that the content of professional development programmes ought to be updated within the framework of teachers' changing needs and diversifying conditions (Özen et al., 2019). However, in Turkey, professional development activities for teachers are usually carried out with courses or seminars (Bümen, Ateş,

- This is an Open Access article distributed under the terms of the Creative Commons Attribution-Noncommercial 4.0 Unported License, permitting all non-commercial use, distribution, and reproduction in any medium, provided the original work is properly cited.

- Selection and peer-review under responsibility of the Organizing Committee of the Conference

© 2022 Published by ISRES Publishing: [www.isres.org](http://www.isres.org)

Çakar, Ural, & Acar, 2012). It is known that the induction programme, which is still considered anew, provides support to novices mainly in the context of seminars and mentoring (Baran-Kaya, 2019).

Considering the current induction system, the idea is that once a teacher is assigned, they will somehow learn the competencies of the profession over time is quite prevalent (Buldu, 2014). In addition, the current induction system is for all novice teachers, and given the qualifications that novices gain, it is possible to say that issues such as legislative knowledge, some personal characteristics and classroom management come to the fore. Opportunities to improve the knowledge of teaching the field are almost non-existent (Baran-Kaya, 2019). However, as known, novice teachers from different fields have different needs and difficulties, and novice mathematics teachers have some peculiar ones (Kralik, 2009). Parr and Papakonstantinou (2016) argue that, among these needs, the knowledge necessary for teaching comes to the fore. Apart from this, novice mathematics teachers have work-related needs, professional development needs, environmental needs, social cohesion and need to know their legal rights, which are similar to other novice teachers' needs (Faltado & Faltado, 2014). This study aims to address the proposals of current novice mathematics teachers to improve the induction system in order to meet the needs of future novice mathematics teachers, since it is needed to understand how the induction programme operates for novice teachers and to identify the problems and disruptions experienced (Özen et al., 2019). Thus, when necessary, some revisions in the induction system can be made in the context of these needs and suggestions.

## **Method**

In this study, the case study method as a qualitative research method was used. As it is known, case studies are studies conducted in the form of an in-depth description and analysis of a circumscribed situation (Merriam, 2013). The case study method was used in this research, as the suggestions that novice teachers provided for the induction system based on their own experiences were analysed in-depth.

### **Study group**

27 lower-secondary mathematics teachers who completed their induction training in the 2018-2019 academic year participated in the study. All of the participants work in schools affiliated with the Turkish Ministry of National Education. Easily accessible sampling method was used to determine the participants. Participation in the study is voluntary and participants' identities remain confidential. While the excerpts were presented, the teachers were named as Ö1, Ö2, ..., Ö27.

### **Data Collection and Analysis**

The data of the research was collected in the written format. Firstly, questions about what could be done to improve the induction training programme were sent to mathematics teachers, whose induction had been completed, in the written format as well. Teachers wrote their answers in the spaces below the questions. Then, the data was analysed through content analysis. Thus, codes with meaning were generated from the data, then themes emerged from interrelated codes, and contextually reiterative and valid outputs tried to be accessed. Thus, the data is presented under 5 themes, which will be discussed in detail in the findings, including support for the field, seminars, professional interaction, providing various facilities and opportunities for development beyond the existing ones. In the analysis of the data, the MAXQDA programme as one of the qualitative data analysis programmes was used and the findings were presented in the form of a MAXQDA map.

## **Results**

The findings of this study address the suggestions of novice mathematics teachers based on their own experiences on how the induction process can run better, and are presented in brief in Figure 1 below. As can be seen in Figure 1, when the support that the novice mathematics teachers required based on their own induction experiences in the induction training is examined, it is seen that those suggestions are presented in 5 dimensions, namely the support for the field (f=24), professional interaction (f=23), seminars (f=17), and the provision of various facilities (f=15), and development opportunities other than the existing ones (f=12). The participants predominantly made suggestions about giving support to the field and field teaching (f=24).

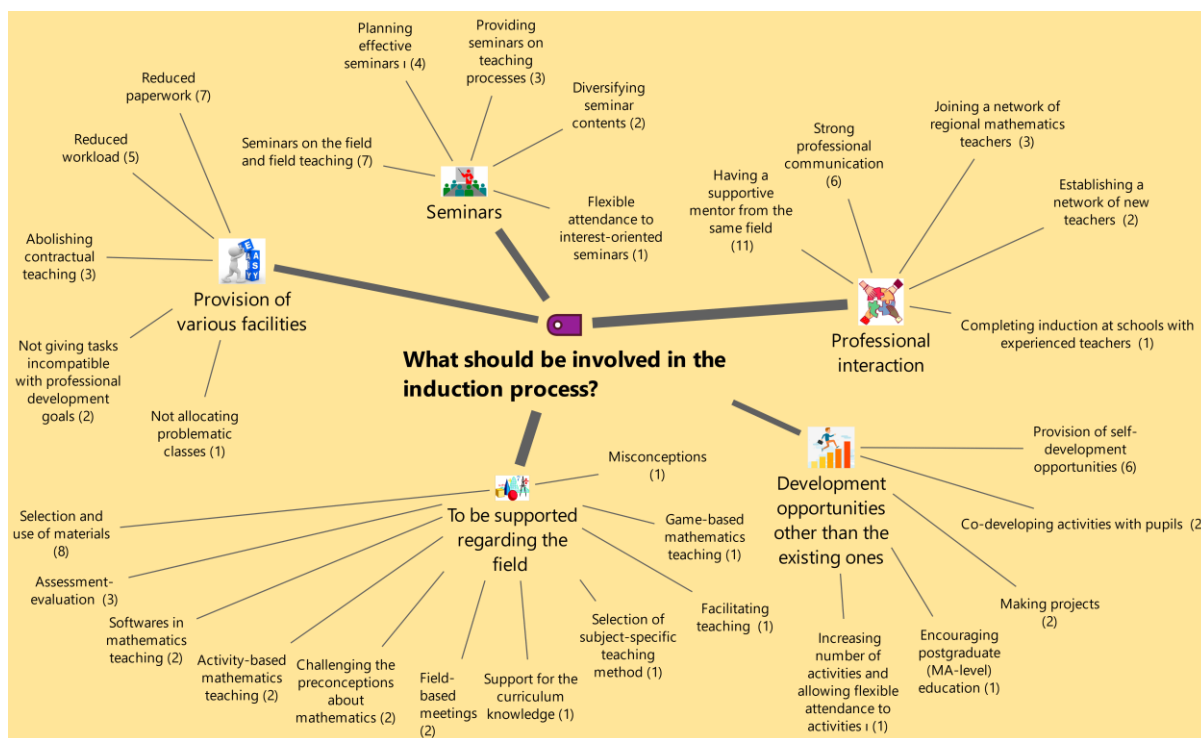

Figure 1. Suggestions of novice mathematics teachers regarding the induction process

The novice mathematics teachers expressed that they needed support in such areas as selection and use of materials in mathematics teaching ( $f=8$ ), assessment-evaluation ( $f=3$ ), activity-based ( $f=2$ ) or game-based ( $f=1$ ) mathematics teaching, challenging preconceptions about mathematics ( $f=2$ ). Among these teachers, T11 underlined the need of support to the field by stating that “*Training for programmes such as material education and Geogebra could be provided*”. T7 also underlined that need and stated that “*We could have received more academic support in terms of teaching. We generally received support on education, but various presentations and activities related to mathematics could have been provided. It would have been even better if these activities were in a way that we could use them in our classes*”.

Another prominent dimension is the professional interaction dimension. T17 stated that “*An mentor should be chosen from those who are experienced in their own branches. If this cannot be achieved, an mentor from another school should be invited*” and addressed the importance of having an mentor from the same field during the induction process. T4 stated that “*I think we should interact more with our experienced [senior colleague] teachers, excluding unnecessary details [during those interactions]. We should get more information about delivery, student behaviours, etc. The important thing is to benefit from their experiences and add something to [our knowledge]*”, and drew attention to the importance of making strong professional communication with experienced teachers. T32 emphasised the same concern with, “*More effective things could have been done in cooperation with the administration, the mentor, and the novice teacher*”. T14 stressed the need to develop cooperation particularly among newly appointed teachers and stated that “*To support new teachers, a group of new teachers in the same region can be established. If there is a separate group for each region or town, meetings can be held on certain days of the week, in which teachers can share their experiences and activities with each other, and such topics as how we can be more useful for pupils can be discussed*”.

Participants also made some suggestions regarding seminars, which is an important component of the induction process in Turkey. Particularly, having seminars for the field and field teaching has been most commonly emphasised issue in this dimension. In this regard, T6 argued that there needs to be seminars on misconceptions and solution suggestions in mathematics whilst T20 mentioned that there is a need to have seminars for mathematics-specific teaching methods and applications. T18 emphasised that seminars need to be delivered by experts of the field stating that “*The seminars we attended should have been about the field of teaching mathematics and these seminars needed to be given by really competent and equipped people*”. Another participant T9 stated that “*The first year at job is really overwhelming. We attended seminars all year long, both on Saturdays and on Sundays, which exhausted me. There should not be trainings in such frequency and the programmes prepared for the induction process in the local national education [presidencies] were quite useless, was a waste of time. More efficient trainings should be planned for future novices*”. In this regard, they

pointed out that the efficiency of seminars ought to be given due diligence rather than giving importance to their frequencies.

Some of the novice mathematics teachers also stated that various facilities need to be provided with the novices in order to alleviate the responsibilities of the first year of teaching. Some novice teachers mentioned that filling out documents and forms requires long periods of time and hence, such requirement needs to be moderate ( $f=7$ ). T36 supported this suggestion stating that *“It would have been supportive [for new teachers] if the paperwork burden that they borne would be lowered so that they could have been facilitated for focusing on pupils and their attainment”*. T19 also stated that school administrations usually gave the problematic classes to novice teachers, and suggested to get rid of this practice for the following years. T1 underlined the importance of lowering the workload of novice teachers by stating that *“Instead of giving them a lot of work and making them feel burnt-out, they can be treated in a more encouraging manner. Because we were contract-based and novice teachers, we were always exploited”*. T20 and T30 specifically emphasised the workload allocated by the administration, which was incompatible with the professional development goals, and mentioned that this needs to be eliminated. T20 supported this idea stating that *“The administration should not put everything on the shoulders of the new teacher. Is this person going to deliver a class or do a watch or deal with administrative documents? Especially if it is a subject teacher, it is time for them to solve questions [coming from pupils] during the breaks. Everyone should perform their own tasks, not throw them on novice teachers”*.

Some of the participant novice teachers stated that there ought to be other development opportunities in order to develop professionally. For instance, T2 said that *“We partially learned how other countries achieved success in the Comparative Education modules at the university [education]. But it will be more effective to learn by going [to those countries] and seeing [them] in person, by undertaking and living their practices [at first-hand]”*. In other words, T2 suggested to send novice teachers abroad to contribute to their personal development with such opportunities provided with them and that this could be more effective. T3 stressed that activities about pupils could be organised and stated that *“In order to support new teachers, many activities can be organised where teachers can spend more time with pupils. Thanks to these activities, teachers will have the opportunity to get to know their pupils better”*. In addition, T25 stated that the variety of activities in the induction programme ought to be increased whilst T23 stated that novice teachers could be encouraged to obtain a Master's degree.

## **Discussion and Conclusion**

This study examines the suggestions of novice mathematics teachers for the development of the induction process, and the results of this study suggest that the novices mostly prefer to receive support for the teaching of the field. Many studies addressing the needs of novice teachers also support this result (Burn, Hagger, & Mutton, 2015; Feiman-Nemser, 2003; Grossman, 1990). It is found that the participants need support regarding the teaching of the field, particularly the selection of materials for the subject of mathematics, how to use these materials, and the use of technology in the field of teaching. Faltado and Faltado (2014) have similarly showed that the work-related needs of novice teachers are more related to the use of technology and materials. In addition, there were novice teachers who stated that they needed to be supported in terms of curriculum knowledge, as shown by Mundt (1991) in his study in the context of field teaching. Novice teachers stated that they needed professional development opportunities other than the existing ones in order to improve themselves in the teaching of the field and in other subjects. As it is known, education in the current induction system in Turkey is mostly carried out through seminars and mentoring practices. However, there are studies showing that both these seminars (Baran-Kaya, 2019; Ulubey, 2018) and mentoring practices (Baran-Kaya, 2019; Özan & Nanto, 2018) are insufficient. In this study, too, novice mathematics teachers point out that opportunities to improve themselves ought to be included in the induction programme. While these opportunities are such activities as promoting postgraduate education and making projects for some, they can also involve in increasing the variety of activities for some others.

In studies on seminars, which are one of the prominent activities of the induction system in Turkey, it is found that novice teachers tend to be sceptical about this practice since, for them, seminars do not contribute to the field (Baran-Kaya, 2019; Ulubey, 2018), the content is insufficient (Baran-Kaya, 2019), and the seminar programme is too intense (Baran-Kaya, 2019; Yılmaz, 2017). In this study, following on the aforementioned concerns, novice mathematics teachers draw attention to the need for seminars to be field-oriented, to cover teaching processes, and to diversify their contents. At the same time, it was also stated that the seminar programme ought to be planned in a more efficient way, as it was too intense in the current state.

It is also known that similar to many other countries in the world, induction programme in Turkey too is full of duties incompatible with professional development (Baran-Kaya, 2019; Ulubey, 2018), documents and forms to be filled (Baran-Kaya, 2019; Dağ & Sarı, 2017; Nayır & Çetin, 2017; Ulubey, 2018; Yanık, Bağdat, Gelici, & Taştepe, 2016), and demanding workloads with seminars to attend, books to read, and films to watch, etc. Therefore, novices feeling overwhelmed with such demanding workload suggested that they needed to be facilitated with opportunities such as reduced paperwork, eased workload, and not allocated with the tasks and problematic classes that did not directly match with their professional development goals. In the literature, it is supported that some facilities ought to be provided with the novices so that they could find time for induction activities (Bleach, 2012; Mcbride, 2012).

In Baran-Kaya's (2019) research, there are novice mathematics teachers who stated that they lost certain rights and were discriminated against by tenured teachers and school administrations, since those novices were contractual. Some other novice mathematics teachers who were the participants of this research also stated that contractual teaching must be abolished for similar reasons and they liked to be in the same position as their tenured colleagues, since effective communication with colleagues is of great importance in being a teacher as known (Colgan, 2004; Fox, Wilson., & Deaney, 2011; Ngang, 2013). Mathematics teachers, who were the participants of this research, also mentioned that they had professional communication difficulties, as found in Baran-Kaya's (2019) research, and made some suggestions to avoid these difficulties in the future. Most of the participants emphasised that it was important to have a supportive mentor from the same field. It has also emerged in other studies that an mentor from the same field can contribute more to the novice (Desimone et al., 2013; Smith & Ingersol, 2004). Apart from this, they stated that activities that would bring experienced and novice mathematics teachers together not only in the assigned school but also in the assigned region could be beneficial. Moreover, there are studies showing that such an interaction is beneficial (McAleer, 2008). Another important interaction voiced by the participants is a network to be established among novice teachers. It was stated that opportunities for novice teachers to share their experiences with each other could be provided through some meetings where they would be brought together. For example, in New Zealand, which is a country that has come to the fore with its induction system, there are activities that specifically encourage such a network among novices. In addition, Gellert and Gonzales (2011) also revealed that such an interaction could be beneficial, especially in induction-related issues.

## **Recommendations**

The present study presents the suggestions to better shape the induction system for novice mathematics teachers. For this reason, it is important that the suggestions of the participants are taken into account by the Turkish Ministry of National Education. Mathematics teachers who have personally experienced the induction process have emphasised that they especially prefer to receive support for the field when discussing seminars, professional interaction, and professional development. This situation brings to mind that it may be beneficial to revise the induction system in a way that is aimed at the field.

After the change of the induction system in 2016, although there has been an increase in the number of studies on the induction process in Turkey, it can be said that there has been a decrease in recent years. However, the increase in the number of studies on the first years of teaching, which is the most critical time of teaching, will give an idea to the planners and practitioners about the revisions of the induction system. This research was conducted with mathematics teachers who had just completed their induction. It should also be taken into account that teachers from different fields may have different problems and hence, different suggestions.

## **Scientific Ethics Declaration**

The authors declare that the scientific ethical and legal responsibility of this article published in EPESS journal belongs to the authors.

## **Acknowledgements**

\* This article was presented as an oral presentation at the International Conference on Science and Education ([www.iconse.net](http://www.iconse.net)) conference held in Antalya/Turkey on November 15-18, 2022

## References

- Baran-Kaya, T. (2019). *Evaluation of novice elementary mathematics teachers' experiences in the induction program* (Unpublished doctoral dissertation). Trabzon: Trabzon University.
- Beijaard, D., Buitink, J., & Kessels, C. (2010). Teacher induction. In P. Peterson, E. Baker, and B. McGraw (Eds.), *International Encyclopedia of education* (pp. 563- 568). Oxford: Elsevier.
- Bleach, K. (2012). *Induction and mentoring of newly qualified teachers: A new deal for teachers*. London: David Fulton Publishers.
- Buldu, M. (2014). Öğretmen yeterlik düzeyi değerlendirmesi ve mesleki gelişim eğitimleri planlanması üzerine bir öneri. *Milli Eğitim Dergisi*, 44(204), 114-134.
- Burn, K., Hagger, H., & Mutton, T. (2015). *Beginning teachers' learning: Making experience count*. Norwich: Critical Publishing.
- Bümen, N. T., Ateş, A., Çakar, E., Ural, G., & Acar, V. (2012). Türkiye bağlamında öğretmenlerin mesleki gelişimi: Sorunlar ve öneriler. *Milli Eğitim Dergisi*, 42(194), 31-50.
- Cam-Tosun, F., & Şimsek, M. (2018). Candidate teacher education program confusion in Turkey. *European Journal of Educational Research*, 7(2), 407-419.
- Colgan, C. (2004). Is there a teacher retention crisis?. *American School Board Journal*, 191(8), 22-25.
- Dağ, N., & Sarı, M. H. (2017). Areas of mentoring needs of novice and preservice teachers. *International Electronic Journal of Elementary Education*, 10(1), 115-129.
- Desimone, L. M., Hochberg, E. D., Porter, A. C., Polikoff, M. S., Schwartz, R., & Johnson, L. J. (2013). Formal and informal mentoring: Complementary, compensatory, or consistent?. *Journal of Teacher Education*, 65(2), 88-110.
- Faltado, R. E., & Faltado, A. T. (2014). Needs assessment of novice teachers: Basis for a model assistance program. *Journal of Educational Policy and Entrepreneurial Research*, 1(2), 117-129.
- Feiman-Nemser, S. (2003). What new teachers need to learn. *Educational Leadership*, 60(8), 25-29.
- Fox, A., Wilson, E., & Deane, R. (2011). Beginning teachers' workplace experiences: Perceptions of and use of support. *Vocations and Learning*, 4(1), 1-24.
- Gellert, L., & Gonzalez, L. (2011). Teacher collaboration: Implications for new mathematics teachers. *Current Issues in Education*, 14(1), 1-38.
- Gökulu, A. (2017). Aday öğretmenlerin Türkiye'deki aday öğretmenlik eğitim süreci ile ilgili görüşleri. *International Journal of Social Sciences and Education Research*, 3(1), 111-123.
- Grossman, P. (1990). *The making of a teacher*. New York: Teachers College Press.
- Gül, İ., Türkmen, F., & Aksel, N. (2017). Aday öğretmen görüşlerine göre aday öğretmen yetiştirme sürecinin değerlendirilmesi. *Hitit Üniversitesi Sosyal Bilimler Enstitüsü Dergisi*, 10(1), 365-388.
- Hangül, Ş. (2017). An evaluation of the new teacher induction program in Turkey through the eyes of beginning teachers. *Journal of Education and Practice*, 8(10), 191-201.
- Ingersoll, R. M., & Smith, T. M. (2004). Do teacher induction and mentoring matter?. *NASSP Bulletin*, 88(638), 28-40.
- Kılıç, D., Babayiğit, Ö., & Erkuş, B. (2016). Aday öğretmenlerin adaylık eğitimine ilişkin görüşleri. *Ekev Akademi Dergisi*, 20(68), 81-91.
- Kozikoğlu, İ., & Çökük, K. (2017). Aday öğretmenlerin adaylık eğitimini atandıkları ilden farklı bir ilde tamamlamaları: aday öğretmenlerin görüş ve deneyimleri. *Ankara Üniversitesi Eğitim Bilimleri Fakültesi Dergisi*, 50(2), 167-200.
- Kralik, J. M. (2009). *Does one size fit all? A study of beginning science and mathematics teacher induction* (Unpublished doctoral dissertation). University of Pennsylvania, Philadelphia.
- McAleer, S. D. (2008). *Professional growth through mentoring: A study of experienced mathematics teachers participating in a content-based online mentoring and induction program* (Unpublished doctoral dissertation). Montana State University, College of Education, Health ve Human Development, Bozeman.
- McBride, C. P. (2012). *Components of effective teacher induction programs and the impact of experienced mentors* (Unpublished doctoral dissertation). University of Arkansas, Arkansas.
- Merriam, S. B. (2013). *Nitel Araştırma [Qualitative Research]*. Translated by Selahattin Turan. Ankara: Nobel.
- Mundt, J. P. (1991). The induction year: A naturalistic study of beginning secondary teachers of agriculture in Idaho. *Journal of Agricultural Education*, 32(1), 18-23.
- Naillioğlu-Kaymak, M., & Sezgin, F. (2021). Danışman mentorluk rolleri: Aday öğretmen yetiştirme sürecinde aday ve danışman öğretmenlerin görüşleri. *Gazi Üniversitesi Gazi Eğitim Fakültesi Dergisi*, 41(1), 307-345.
- Nayır, F., & Çetin, S. K. (2017). Opinions of teacher candidates on mentor teacher program (example of Muğla). *Journal of Education and Future*, 12, 137-155.

- Ngang, T. K. (2013). Teaching as collective work: What are the needs of novice teachers?. *Procedia-Social and Behavioral Sciences*, 93, 195-199.
- Nielsen, D. C., Barry, A. L., & Addison, A. B. (2007). A model of a new-teacher induction program and teacher perceptions of beneficial components. *Action in Teacher Education*, 28(4), 14-24.
- Önder, E. (2018). Prospective teacher training program according to prospective teachers' opinions. *Kuram ve Uygulamada Eğitim Yönetimi*, 24(1), 143-189.
- Özan, M. B., & Nanto, Z. (2018). Okul yöneticilerinin aday öğretmenlik süreci ile ilgili görüşleri. *Kırıkkale Üniversitesi Sosyal Bilimler Dergisi (KÜSBD)*, 8(1), 187-202.
- Özen, H., Kılıçoğlu, G., & Yılmaz-Kılıçoğlu, D. (2019). Aday öğretmenlerin aday öğretmen yetiştirme programına ilişkin görüşleri: Nitel bir araştırma. *Marmara Üniversitesi Atatürk Eğitim Fakültesi Eğitim Bilimleri Dergisi*, 49(49), 99-120.
- Parr, R., & Papakonstantinou, A. (2016, April). *Techniques that support novice and struggling mathematics teachers*. Paper presented at the Annual Conference of the National Council of Supervisors of Mathematics, Oakland, CA.
- Smith, T. M., & Ingersoll, R. M. (2004). What are the effects of induction and mentoring on beginning teacher turnover?. *American Educational Research Journal*, 41(3), 681-714.
- Ulubey, Ö. (2018). Aday öğretmen yetiştirme programının değerlendirilmesi. *Hacettepe Üniversitesi Eğitim Fakültesi Dergisi*, 33(2), 480-502.
- Yanık, H. B., Bağdat, O., Gelici, Ö., & Taştepe, M. (2016). Göreve yeni başlayan ortaokul matematik öğretmenlerinin karşılaştıkları zorluklar. *Mustafa Kemal Üniversitesi Sosyal Bilimler Enstitüsü Dergisi*, 13(36), 130-152.
- Yılmaz, M. (2017) Aday öğretmen yetiştirme sürecinde karşılaşılan sorunlar ve çözüm önerileri. *21. Yüzyılda Eğitim ve Toplum Eğitim Bilimleri ve Sosyal Araştırmalar Dergisi*, 6(16), 135-155.

---

### Author Information

---

**Tuğba Baran Kaya**

Kırıkkale University Faculty of Education,  
Kırıkkale/Turkey  
Contact e-mail: [tugbabaran@kku.edu.tr](mailto:tugbabaran@kku.edu.tr)

**Sedef Çelik Demirci**

Artvin Çoruh University Faculty of Education,  
Artvin/Turkey

---

**To cite this article:**

Baran-Kaya, T. & Celik-Demirci, S. (2022). Opinions of novice mathematics teachers on improving the teacher induction programme. *The Eurasia Proceedings of Educational & Social Sciences (EPESS)*, 28, 36-42.

The Eurasia Proceedings of Educational & Social Sciences (EPESS), 2022

Volume 28, Pages 43-48

**IConSE 2022: International Conference on Science and Education**

## **The Usefulness of Activity Evaluation and Feedback Tool (AEFT) and Its Potential to Evaluate and Give Feedback to Practitioners**

**Ali BOZKURT**  
Gaziantep University

**Mehmet Fatih OZMANTAR**  
Gaziantep University

**Abstract:** Activity and activity-based learning is one of the important fields of study that remains up-to-date in the mathematics education community. In the context of activity-based learning, it makes it necessary to evaluate the quality of the design and implementation of activities. Within this framework, Bozkurt, Özmantar, Ağaç and Güzel (2022) developed the Activity Evaluation and Feedback Tool (AEFT). The purpose of this study is to examine the usefulness of the AEFT tool and its potential to provide evaluation and feedback to practitioners. Within the scope of the tool, the activity text and application processes, which are the basis for activity-based teaching, were dimensioned and indicators related to each dimension were created. The study was carried out in the fall semester of the 2021-2022 academic year. The study group consists of 12 secondary school mathematics teachers. Teachers were asked to apply this activity in their classrooms by choosing or developing an activity. Then, they were asked to evaluate these design and implementation processes with AEFT. According to the findings obtained from the research, AEFT has been found to be useful and has the potential for evaluation and feedback. It has also been seen that AEFT offers a clear performance target for agreed standards. The AEFT provides an opportunity to evaluate and give feedbacks to the users on activity scripts and on the implementation process along with the mathematical potential of both dimensions. As a result, it can be said that the performance criteria in AEFT can be used by mathematics teachers to evaluate the quality of activity processes.

**Keywords:** Mathematical activity, AEFT, Activity-based learning

### **Introduction**

Studies in the field of mathematics education have given special importance to the method and quality of mathematics teaching for many years. It is being worked on to construct a meaningful teaching approach and to ensure the permanence of learning. In this context, one of the methods and approaches adopted by mathematics educators is activity-based learning. Activity and activity-based learning is one of the important fields of study that remains up-to-date in the mathematics education community. So much so that in 2015, ICMI (International Commission on Mathematical Instruction), one of the important congresses of the field, focused on activities. At the congress, they presented a book titled "Task design in Mathematics Education", both as a supplementary and as a guide for further studies in the field (Watson & Othani, 2015). In short, activity and activity-based learning continues to be a topic of interest on a global scale.

An evaluation of the design and implementation of the activities that stand out in the context of activity-based learning is required. The evaluation process plays a key role in determining the quality of the teacher's activity design and implementation process, determining the steps to be taken and the decisions to be taken to improve the process. In addition, in the light of the evaluations made, it is necessary to provide feedback on the design and implementation of the activity. Feedback, which is used to give information about a certain behavior and

---

- This is an Open Access article distributed under the terms of the Creative Commons Attribution-Noncommercial 4.0 Unported License, permitting all non-commercial use, distribution, and reproduction in any medium, provided the original work is properly cited.

- Selection and peer-review under responsibility of the Organizing Committee of the Conference

© 2022 Published by ISRES Publishing: [www.isres.org](http://www.isres.org)



practice (Wiggins, 2012), has an important place in the learning process. Feedback is conceptualized as information provided by an agent (e.g., teacher, peer, book, parent, self, experience) about another person's performance or understanding (Hattie & Timperley, 2007).

### Activity Evaluation and Feedback Tool: AEFT

AEFT, which was introduced by Bozkurt et al. (2022), is an evaluation tool that can be used to determine the quality of mathematical activity text and its applications separately. Based on these evaluations, it is aimed to use the text of the mathematical activity to give feedback to the users about the strengths and developmental aspects of the performance that emerges in the application of the activity. AEFT, which was developed for this purpose, was prepared as an analytical rubric. It is used when it is necessary to determine the components that make up the analytical rubric performance and to make a detailed evaluation about each component. One of the important benefits of using analytical rubrics is that they allow specific feedback on each of the components that make up the performance according to the scoring criteria. In the evaluation with the analytical rubric, it is possible to obtain more detailed information about the strengths and weaknesses. In addition, dividing holistic judgments about performance into more manageable parts is seen as a way to increase clarity and achieve objectivity in scoring (Sadler, 2009). This increases the confidence in the evaluation results. Evaluation with the analytical rubric is done separately for each component, and then the scores from each component are added to obtain a total score. Therefore, since the AEFT is prepared as an analytical rubric, it allows the assessment to be made in a more detailed and customized manner. It is also possible to produce a score related to activity design and implementation by summing the scores assigned for each component in the evaluation made with AEFT.

In order for AEFT to be used functionally, concrete indicators and observable criteria were taken as basis in its structuring process. It is aimed that AEFT will serve a reliable scoring as well as valid results. It has been developed to evaluate the AEFT activity text and activity implementation processes. The activity text is a concrete tool that can be found in various sources or produced as a document prepared by the teacher himself, and has observable qualities. The application, on the other hand, emerges based on the interaction between the student-teacher-content trios in the real classroom environment and has observable features. The dimensions and components of the AEFT are presented in Figure 1.

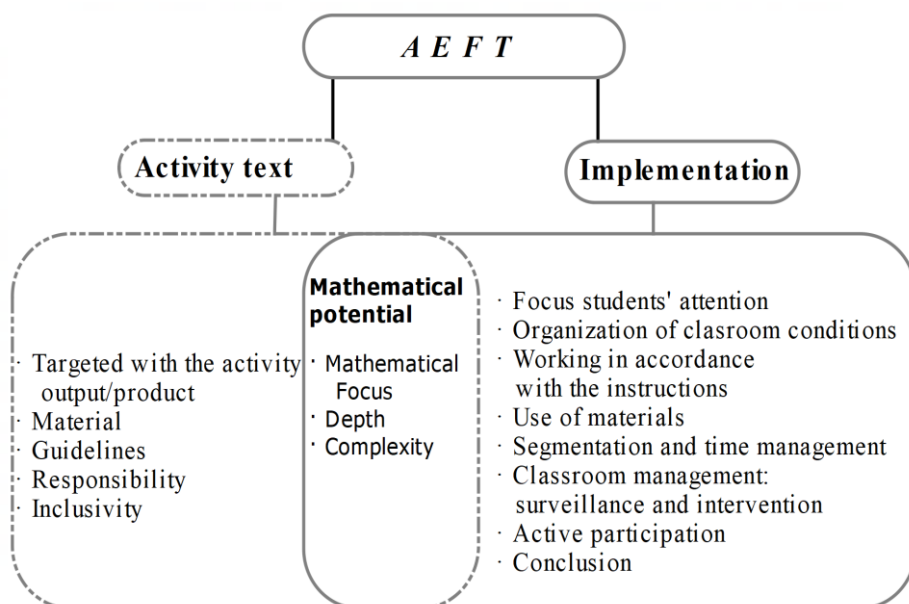

Figure 1. Dimensions and components of AEFT (Bozkurt et al., 2022)

As seen in Figure 1, the activity text has a total of 8 components and the application has a total of 11 components. Both the activity text and the application also include an evaluation in terms of mathematical potential (MP). The MP includes components for the activity text and the mathematical characterization of the application. The quality of the mathematical phenomenon, which was aimed to be developed with the activity, was evaluated over three components: mathematical focus, depth and complexity. Each of the activity text and

activity implementation dimensions, which AEFT is based on in the evaluation, are designed to be handled together with the MP.

The components in the AEFT are rated over 4 score types (0: Very low; 1: Low; 2: Medium; 3: High). Scores that can be produced in an assessment with AEFT are in the range of 0-24 points as minimum-maximum for the 8-component activity text dimension. The 11-component activity is in the range of 0-33 points as a minimum-maximum for the application dimension. According to these indicators, it is possible to determine the quality of any activity text and implementation processes. In order to fill these gaps identified in the literature, it is important to reveal the quality of activity-based teaching, to give feedback to practitioners, and to develop a tool with practical value built on theoretical foundations that will serve to structure the activity design and implementation processes in detail.

In this study, the usefulness of the AEFT tool, which was built on theoretical foundations, in examining the activity text and the quality of the application was investigated. It is also aimed to look at the tool's potential to provide evaluation and feedback to practitioners. In this context, answers to the following questions were sought within the scope of the research:

- Do the teachers differ in their personal evaluations of the strengths and weaknesses of the activity practices and in their evaluations using AEFT?
- Did the teachers have any difficulties in using AEFT in evaluating the activity text and its implementation?
- According to the teachers, does AEFT contribute to increasing the quality of the design and implementation of the activities?

## **Method**

The data of the study were obtained within the scope of the project (TUBITAK 119K773) carried out by adopting a design-based research pattern. In design-based research (DBR) studies, it is recommended to try the first applications through confident practitioners (Anderson & Shattuck, 2012). In this way, it will be possible to observe more dimensions related to the expected model (AEFT). At this point, it seems that there are two reasonable options for the continuation of the study:

1. Creating groups of teachers who are known to be experts in activity design and implementation
2. Providing professional development trainings to a group of teachers and making them specializing in activity design and implementation.

The second option was chosen within the scope of the research.

## **Participants**

The study group consists of 12 secondary school mathematics teachers whose professional experience ranges from 1 to 12 years in the fall semester of the 2021-2022 academic year. It was noted that these teachers were not involved in the previous stages of the development of the tool. The participants were graduate students in mathematics education and were also secondary school mathematics teachers. The trainings were conducted face to face and recorded. These teachers were given training on the use of AEFT and were asked to evaluate the design and implementation of sequential activities with AEFT.

## **Data Collection Process**

12 middle school mathematics teachers who participated in the training were asked to choose an activity text and apply this activity in their classrooms. They were then asked to evaluate both the activity they chose and the quality of their practice. While making the assessment, they were asked to make a personal assessment first and then to make an assessment using the AEFT tool. 11 teachers made the desired evaluations. A teacher did not evaluate because he could not train the application. The codes and frequencies obtained from the analysis of the participants' evaluations are given in the findings section.

## Results

### Findings on Teachers' Personal Evaluations of the Strengths and Weaknesses of Activity Practices and the Points They Differed in Their Evaluations with AEFT

It was determined that almost all of the teachers stated that they could not see the point that they differed with AEFT in determining the strengths and weaknesses of the activity applications. In addition, a teacher stated that the practices of evaluating with AEFT identified the deficiencies of their own evaluations. For example, a teacher used the following expression:

*"I had to slightly support the focus phase of the students' attention. I should have talked about things that might be of some interest to them. I also think that I should have repeated the output many times while finishing the activity."* (T2)

From this statement, it is seen that the teacher expressed some issues that he determined through AEFT in order to increase the quality of the activity implementation. Therefore, it can be said that AEFT provides guidance to the teacher in order to give feedback and increase the quality of its implementation.

### Findings on the Parts Where Teachers Have Difficulty in Using AEFT in Evaluating the Activity Text and Practices

6 of the participants stated that there were no parts that they had difficulty in using AEFT in evaluating the activity text and applications. It is understood from the statements of the teachers that using the tool contributes to an objective evaluation. Some participants stated that they had difficulty scoring the components. For example, two participants stated that they were between 2 and 3 points while scoring in the depth component and they were undecided about which direction to use points. Likewise, one participant each stated that they had difficulty in scoring in components such as mathematical focus, conclusion, responsibility, and material use. On the other hand, the teacher, who stated that she only had difficulties in the mathematical focus component of the mathematical potential dimension, expressed this situation as follows:

*"In the Mathematical Focus section, I do not think that the student's immediate awareness of the output is due to the activity, but I was undecided between 2-3 points due to the direct access of the students to the output."* (T6).

It is seen that the teacher is also undecided in the scoring due to the direct access of the students to the output. It cannot be said that there is an instability caused by the vehicle here. Because the tool indicates that 3 points should be given if the student has reached the mathematical output. The indecision here can be considered as a personal concern of the teacher.

### Teachers' Thoughts on the Potential of AEFT to Provide Feedback to Improve Its Quality after Activity Implementations

According to the findings obtained from the answers given about AEFT's contribution to increasing the quality of the activity's later applications, it was seen that almost all of the teachers (n=9) agreed that AEFT contributed to increasing the quality of the activity implementation and subsequent applications. One participant's opinion is as follows:

*"First of all, it definitely makes you more selective. It makes me think a lot while trying to organize the process"* (T7).

From the statements of the teachers, it can be said that he helped the teachers who he guided in the stages of choosing the activity, adapting it to the class and applying it. In addition, teachers stated that the use of AEFT contributed to their professional development in activity design and implementation (n=6). In addition, it contributes to raising awareness about the components of AEFT regarding activity design and implementation, such as ending the activity (n=5), active participation (n=3), classroom management (n=2), and teacher intervention style (n=2).

## **Discussion**

The usefulness of a measurement tool is related to its ease and affordability to obtain, prepare, develop, implement and score. During the development of AEFT, it was important to ensure that this tool is user-friendly. In order to ensure the usefulness of AEFT, indicators and example cases related to each component are reflected in the tool. In addition, sequential improvement studies were carried out within the scope of AEFT's competence, functionality and usefulness. However, within the scope of scoring, feedback was received from the teachers throughout the process and the parts in the scoring that were not understood or took time were emphasized. Thus, it has been tried to ensure that the tool is easy and economical in terms of development, implementation and scoring. Teachers' evaluations on the usefulness of AEFT also indicate that success has been achieved in this regard. Teachers stated that they found AEFT useful and useful. They stated that the use of it did not force them, they got used to the use of the tool after a few evaluations, that the evaluations made with AEFT did not take long and they found it memorable. All these indicate that the tool was found useful by teachers.

The most important criticism expressed regarding the use of AEFT from the teachers who evaluated the usefulness of AEFT was the difficulties experienced in scoring some degrees of some components, albeit in a limited number. Apart from this, no deficiencies were expressed about the difficulties experienced in use. Therefore, it has been understood that it is important to review the indicators and criteria that form the basis of scoring for a small number of components, to add explanations and to make directions for raters to draw attention to distinctive features.

The opinions of the teachers who made the evaluation that AEFT was effective in giving feedback came to the fore. It is understood from the explanations of the participants that AEFT has made practical contributions to their professional development regarding the activity design and implementation processes. Therefore, the potential of AEFT in providing feedback has been expressed by teachers and it has been a common point that the awareness it brings to them will guide their instructional decisions.

## **Conclusion and Recommendations**

It has been seen that AEFT is a tool that can be used for understanding and structuring activity applications in activity-based mathematics teaching. In this respect, it has a guiding feature for the successful selection and implementation of activities to be used in mathematics teaching. The performance criteria in the AEFT can be used by mathematics teachers to evaluate the quality of activity processes. AEFT provides clear performance targets for agreed standards. Therefore, teachers and academics can use AEFT to determine the quality of the designed and implemented activity.

## **Scientific Ethics Declaration**

The authors declare that the scientific ethical and legal responsibility of this article published in EPSS journal belongs to the authors.

## **Acknowledgements**

\* This study was presented as an oral presentation at the International Conference on Science and Education ([www.iconse.net](http://www.iconse.net)) conference held in Antalya/Turkey on November 15-18, 2022.

\*This study was produced within the scope of the research project supported by TUBITAK (project no: 119K773).

## **References**

Anderson, T., & Shattuck, J. (2012). Design-based research: A decade of progress in education research?. *Educational Researcher*, 41(1), 16-25.

- Bozkurt, A., Özmantar, M.F., Ağaç, G., & Güzel, M. (2022). *Activity design and applications in mathematics teaching: An evaluation framework*, Ankara: Pegem Academy [In Turkish].
- Hattie, J., & Timperley, H. (2007). The power of feedback. *Review of Educational Research*, 77(1), 81-112.
- Sadler, D. R. (2009). Indeterminacy in the use of preset criteria for assessment and grading. *Assessment & Evaluation in Higher Education*, 34(2), 159-179.
- Watson, A., Ohtani, M., Ainley, J., Frant, J. B., Doorman, M., Kieran, C., & Yang, Y. (2013). Introduction. In C. Margolinas (Ed.), *Task design in mathematics education. Proceedings of ICMI Study 22* (pp. 9–16). Oxford, England: ICMI.
- Wiggins, G. (2012). Seven keys to effective feedback. *Feedback*, 70(1), 10-16.

---

### Author Information

---

**Ali BOZKURT**

Gaziantep University

Gaziantep, TURKEY

Contact e-mail: [alibzkrt@gmail.com](mailto:alibzkrt@gmail.com)

**Mehmet Fatih OZMANTAR**

Gaziantep University

Gaziantep, TURKEY

---

**To cite this article:**

Bozkurt, A., & Ozmantar, M.F. (2022). The usefulness of activity evaluation and feedback tool (AEFT) and its potential to evaluate and give feedback to practitioners. *The Eurasia Proceedings of Educational & Social Sciences (EPESS)*, 28, 43-48.

The Eurasia Proceedings of Educational & Social Sciences (EPESS), 2022

Volume 28, Pages 49-53

**IconSE 2022: International Conference on Science and Education**

## **Scientist Images of Secondary School Students**

**Sule EGUZ**  
Inonu University

**Abstract:** The importance of scientific knowledge is increasing day by day. In this sense, the role of the scientist who directs science and scientific activities is increasing day by day. In particular, stereotypical images play an important role in influencing the interests and attitudes of individuals. In this study, five different aspects of secondary school students' images of scientists were investigated. The research was designed in accordance with the qualitative research method and in this direction, the phenomenology model was taken as a basis. Maximum diversity sampling method was used to maximize the diversity of individuals who may be a party to the problem studied in the determination of the participants. In this direction, the study was conducted with a total of 72 secondary school students, 18 participants from each grade level. The research data were collected in written form in the spring term of the 2021-2022 academic year through a standardized open-ended interview form. Content analysis technique was used in the analysis of the data obtained in the research. At the end of the research, students' mental images of scientists, their physical images, the source of the image, the scientists around them and their favorite scientists were revealed.

**Keywords:** Science, Scientist, Secondary school students, Image

### **Introduction**

Science is an effort to understand the universe and what is going on in the universe. This effort to establish harmony between the factual world and our expectations includes processes such as observation, experimentation and measurement on the one hand, and creative and critical thinking processes in the way of forming and examining hypotheses or theories that explain the determined phenomena, on the other hand. At its core is intellectual interest; It is based on a passion for knowing, learning and explaining (Yıldırım, 1979).

The function of science is to continually expand our knowledge of the phenomena of nature, to give us insight into the complex relationships of phenomena or the concepts used to interpret these phenomena (Ramirez & Cayón-Peña, 2017). The only condition for understanding science or scientific knowledge is to understand the scientists who produce scientific knowledge. But we must never forget that knowledge is inevitably constructed in interaction with the neural activity of the knower, and every scientist has his own values, priorities, and may also have all sorts of cognitive biases or speculations (Ramirez & Cayón-Peña, 2017).

A scientist is someone who has expertise or conducts research in a particular field of science. There are many different types of scientists, and their tasks are different. Some scientists spend all day working in the lab with chemicals and microscopes. Some work outside, maybe on the beach looking for sea turtle eggs. There are also scientists who specialize in the ocean and work on water (Buskovitz & Wood, 2022). Although the fields of specialization change, the general qualifications of the scientist remain the same.

Scientists generally have analytical skills, are detail-oriented and very organized. Scientists are also open-minded and unbiased, which enables them to accept results that disprove their hypotheses and change their hypotheses when necessary (Buskovitz & Wood, 2022). The role of scientists who direct science and scientific activities is increasing day by day. As it is known, especially cliché images play an important role in influencing

---

- This is an Open Access article distributed under the terms of the Creative Commons Attribution-Noncommercial 4.0 Unported License, permitting all non-commercial use, distribution, and reproduction in any medium, provided the original work is properly cited.

- Selection and peer-review under responsibility of the Organizing Committee of the Conference

© 2022 Published by ISRES Publishing: [www.isres.org](http://www.isres.org)

the interests and attitudes of individuals. In this context, Kelly (1987) emphasized that it is important for students to have positive images and attitudes towards scientists when they need to make decisions about their future careers. As a matter of fact, the exact impact of students' stereotypical scientist perceptions in shaping their career goals is unknown, but it is believed that students with negative perceptions of science and scientists are less likely to choose science as a career in the future (Mason, Kahle & Gardner, 1989). In this study, five different aspects of secondary school students' images of scientists were investigated. In this context, in parallel with the studies of Song and Kwang-Suk (2010), answers to the following questions were sought throughout the research:

Participants;

- What are their mental images of scientists?
- What are their physical images?
- What are the sources of the images?
- Who are the scientists around them? and
- Who are their favorite scientists?

## **Method**

The research was carried out according to the qualitative research methodology. Qualitative research includes knowledge generation processes to understand people's lifestyles, stories, behaviors, organizational structures and social change (Strauss & Corbin, 1990). The research was designed with phenomenology, one of the qualitative research models. In the phenomenology design, it is aimed to reveal common practices and to define and explain the meanings created by the participants (Annells, 2006).

## **Study Group**

Maximum diversity sampling method was used in order to maximize the diversity of individuals who may be a party to the problem studied in the determination of the participants. In this direction, the research was carried out with a total of 72 secondary school students, 18 participants from the 5th, 6th, 7th and 8th grade levels.

## **Data Collection and Analysis**

The research data were collected in written form in the spring term of 2021-2022 academic year through a standardized open-ended interview form. In the process of developing the form, the relevant literature was used to ensure content validity. The standardized interview is a type of interview in which the "interview plan", which determines in the most detailed way how the previously prepared questions will be asked and how the data will be collected, is applied exactly. The freedom of movement left to the interviewer is minimal. Digitizing and checking the answers is easy in this type of interview (Karasar, 2005).

For the reliability of the prepared interview form, the formula  $\text{Reliability} = \frac{\text{Consensus}}{\text{Consensus} + \text{Disagreement}} \times 100$  was used (Miles & Huberman 2016). According to this formula, the researcher and another academician coded the written data separately. The agreement between the two encoders was calculated as 92 percent. In line with the phenomenological research tradition, the analysis process of the study was carried out in parallel with the content analysis in accordance with the steps of 'bracketing', 'phenomenological reduction', 'imaginary variation', 'synthesis of meaning and essences' (Giorgi, 2009). In the content analysis, the data were first divided into sections and these sections were compared by examining them.

## **Findings**

The research findings were analyzed under the headings of 'Participants' mental and physical images of scientists', 'The source of the images created by the participants', 'Scientists around the participants and their favorite scientists'.

## Participants' Mental and Physical Images of Scientists

In order to reveal the mental and physical images of the participants towards scientists, they were asked to 'write the first word that comes to mind when the scientist is mentioned'. The distribution of the answers given to the participants is given in Table 1.

Table 1. Mental images of secondary school students for scientists

Mental image created	Frequency (f)	Percent (%)	Mental image created	Frequency (f)	Percent (%)
1. Information	9	13	22. Number	1	1,3
2. Laboratory	6	9	23. Writing	1	1,3
3. Magnifying Glass	5	8	24. Old	1	1,3
4. Glasses	4	6	25. Documentary	1	1,3
5. Experiment	4	6	26. Famous	1	1,3
6. Computer	3	4	27. World	1	1,3
7. Apron	3	4	28. Potion	1	1,3
8. Book	3	4	29. Tired	1	1,3
9. Invention	2	3	30. Flower	1	1,3
10. Animal	1	1,3	31. Prize	1	1,3
11. Library	1	1,3	32. Nature	1	1,3
12. Hardworking	1	1,3	33. Herb	1	1,3
13. Paper	1	1,3	34. Bouquet	1	1,3
14. Success	1	1,3	35. Ancient	1	1,3
15. Sculptor	1	1,3	36. Robot	1	1,3
16. Formula	1	1,3	37. Bald	1	1,3
17. Pencil	1	1,3	38. Wizard	1	1,3
18. Leaf	1	1,3	39. Bomb	1	1,3
19. Microscope	1	1,3	40. Ant	1	1,3
20. Bottle	1	1,3	41. Bee	1	1,3
21. Liquid	1	1,3	42. Sleepless	1	1,3

As seen in Table 1, a total of 42 metaphors for the concept of "scientist" were developed by the students participating in the research. It is seen that 13% (f=9) of the participants liken the scientist to knowledge. As a reason for this, they stated that the scientist has a "knowledge-producing" feature. Again, 9% (f=6) of the participants focused on the "laboratory" image. Students with this view explained the reason why they liken scientists to a "laboratory" because their "workspace is laboratory". Other than that, "magnifying glass 8% (f=5), glasses 6% (f=4), experiment 6% (f=4), computer 4% (f=3), apron 4% (f=3), book %4 (f=3) and invention 4% (f=3) were metaphors frequently used by students. When the resulting images were examined, it was seen that the physical images were limited to glasses, apron, fatigue, old and bald images.

## The Source of Images Created by the Participants

The distribution of the image sources of the participants by class levels is given in Table 2.

Table 2. Distribution of the image sources created by the participants by grade levels

Source of images	5th grade (n=18) f (%)	6th grade (n=18) f (%)	7th grade (n=18) f (%)	8th grade (n=18) f (%)
School	9 (50%)	8 (44%)	8 (44%)	7 (39%)
Social media	3 (17%)	4 (22%)	5 (28%)	10 (55,5%)
TV	4 (22%)	1 (5,5%)	1 (5,5%)	
Book	1 (5,5%)	3 (17%)	3 (17%)	1 (5,5%)
Family	1 (5,5%)	1 (5,5%)	1 (5,5%)	
Friend		1 (5,5%)		

When Table 2 is examined, the image sources of the students at the 5th, 6th and 7th grades are mostly "school"; at the 8th grade level, it was revealed that 'social media' constituted the most. It was seen that the sources of 'family' and 'friend' were preferred as the least image source at all grade levels. 'Television' and 'book' were other preferred image sources.



## Scientists around the Participants and their Favorite Scientists

First of all, students were asked to identify someone who could be considered a scientist in their daily lives and to state the reason for their choice. The distribution of the answers given is shown in Table 3.

Table 3. Scientists around middle school students

Scientists around	5th grade (n=18) f (%)	6th grade (n=18) f (%)	7th grade (n=18) f (%)	8th grade (n=18) f (%)
Teachers	15 (83%)	12 (67%)	9 (50%)	10 (56%)
No one	3 (17%)	5 (28%)	2 (11%)	6 (33%)
Doctors		1 (5%)	7 (39%)	2 (11%)

When Table 3 is examined, 46 participants (63%) mostly defined their teachers at all grade levels as scientists around them. The rate of students who stated that there is no scientist around them is 22% (f=16). The rate of students who claimed that doctors were around as scientists was 14% (f=10). Again, under this heading, students were asked to name the scientist they liked and respected the most. Table 4 contains details of the answers.

Table 4. The scientist that secondary school students love and respect the most

Most loved and respected scientists	Frequency (f)	Percent (%)
Aziz Sancar	37	51
Yunus Emre	11	15
Ibn Sina	8	11
Farabi	7	10
Khwarezmi	3	4
Piri Reis	2	3
Newton	2	3
Edison	1	1
Galileo	1	1

When Table 4 is examined, it has been determined that the students mostly (f=37, 51%) love and respect Aziz Sancar. Yunus Emre, Ibn Sina and Farabi were the other names most frequently mentioned by the participants. Edison and Galileo were sung by only one student.

## Results and Discussion

Science broadens our knowledge of nature, giving us an insight into complex relationships. Scientists must not only follow scientific methods, but also find ways to get the most out of their research and study plans. To take risks, to find new avenues, methods and fields of study, they have to take some risks. In addition, scientists have obligations such as observation, curiosity, creativity, skepticism, objectivity, and up-to-dateness. At the end of the research, students' mental images of scientists, their physical images, the source of the image, the scientists around them and their favorite scientists were revealed. In the determinations made, it was determined that they reflect stereotypical perceptions towards scientists.

A total of 42 metaphors for the concept of "scientist" were developed by the students participating in the research. It was revealed that the participants compared the scientist to knowledge the most. Apart from this, images of laboratory, magnifying glass, glasses, experiments, computers, aprons, books and inventions were frequently used by students. When the resulting images were examined, it was seen that the physical images were limited to glasses, apron, fatigue, old and bald images. These results are in line with the research of Çakıcı (2018) and Monhardt (2003).

At the 5th, 6th and 7th grade levels, the image resources of the students are mostly the school; at the 8th grade level, it was revealed that social media constituted the most. It has been seen that family and friend resources are preferred as the least image resource at all grade levels. Television and books were other preferred image sources. These results show parallelism with the findings of Çakıcı (2018) and Song and Kwang-Suk (2010). 46 participants defined their teachers most at all grade levels as the scientists around them. The rate of students who state that there is no scientist around them is 22%. The rate of students claiming that doctors are around as scientists was 14%. In the study, it was also determined that the students most loved and respected Aziz Sancar.

Yunus Emre, Ibn Sina and Farabi were the other names most frequently mentioned by the participants. Edison and Galileo were sung by only one student.

## Scientific Ethics Declaration

The author declares that the scientific ethical and legal responsibility of this article published in EPESS journal belongs to the author.

## Acknowledgements

\* This article was presented as an oral presentation at the International Conference on Science and Education ([www.iconse.net](http://www.iconse.net)) held in Antalya/Turkey on November 15-18, 2022.

## References

- Buskowitz, D., & Wood, D. (2022). What is a scientist? *Qualities, Traits & Values*. Retrieved from <https://study.com/learn/lesson/characteristics-scientist-overview-traits-examples.html>
- Çakıcı, E. (2018). *Farklı öğretim kademelerindeki öğrencilerde bilim insanı algısının belirlenmesi*. (Unpublished master thesis). Mersin University, Mersin.
- Giorgi, A. (2009). *The descriptive phenomenological method in psychology: A modified husserlian approach*. Pittsburgh: Duquesne University Press.
- Huberman, M. A. & Miles, M. B. (2016). *Nitel veri analizi*. (S. Akbaba-Altun & A. Ersoy, Trans.). Ankara: Pegem Akademi.
- Karasar, N. (2002). *Bilimsel araştırma yöntemi*. Ankara: Nobel Yayıncılık.
- Kelly, A. (1987) Why girls don't do science. In A. Kelly (Ed.), *Science for girls* (pp.12-17). Milton Keynes: Open University Press.
- Monhardt, R. M. (2003). The image of the scientist through the eyes of navajo children. *Journal of American Indian Education*, 42(3), 25-39.
- Mason, C., Kahle, J. B., & Gardner, A. (1989). Draw-a-scientist test: Future implications. *School Science and Mathematics*, 91(5), 193-198.
- Ramirez, J. M., & Cayón-Peña, J. (2017). The role of scientists in a human-centered society. *CADMUS*, 3(2), 113-130.
- Song, J., & Kwang-Suk, K. (1999) How Korean students see scientists: the images of the scientist. *International Journal of Science Education*, 21(9), 957-977.
- Strauss, A., & Corbin, J. (1990). *Basics of qualitative research: Grounded theory procedures and techniques*. New Delhi: Sage Publications.
- Yıldırım, C. (1979). *Bilim felsefesi*. İstanbul: Remzi Kitabevi.

---

## Author Information

---

### Şule Egüz

Inonu University  
Education Faculty, Department of Social Studies Education  
Turkey  
Contact e-mail: [suleeguz@gmail.com](mailto:suleeguz@gmail.com)

---

### To cite this article:

Eguz, S. (2022). Scientist images of secondary school students. *The Eurasia Proceedings of Educational & Social Sciences (EPESS)*, 28, 49-53.

The Eurasia Proceedings of Educational & Social Sciences (EPESS), 2022

Volume 28, Pages 54-61

**IConSE 2022: International Conference on Science and Education**

## **The Efficiency of Visual-Spatial Abilities (Memory Processes) Training through Multimedia Simulation for Soccer Strikers.**

**Lorabi RADHOUANE**

University of Djilali Bounaama

**Belaid Akil ABDELKADER**

University of Djilali Bounaama

**Abstract:** The main aim of our work is to test the efficiency of visual-spatial abilities (memory processes) training through the multimedia simulation of soccer strikers under 23 years of age ( $N = 20$ ;  $M$  age =20.85 years;  $SD = 1.15$ ), who have at least 5 years of experience ( $M$  experience=6.1 years;  $SD=1.11$ ), and the reflection of this process on soccer strikers' comprehension of the different offensive tactical situations. We created a training program (experimental approach using the unique sample with pre- and post-testing design) for soccer strikers, based on the theory of cognitive load that can provide guidelines to help present information in a way that encourages the learner to activities that improve intellectual performance. The methodology demonstrated a noticeable improvement in the player's visual-spatial abilities, and that helped the soccer striker to improve his VSA perception, and the time of responsiveness on the different playing strategies that they had practiced before. In addition to improving the psychomotor-sensory coordination in which visual-spatial perception plays an essential role, by improving it, the player's performance develops at multiple levels (cognitive, sensory, psychological, and executive performance).

**Keywords:** Visual-spatial abilities, Multimedia simulation, Soccer strikers, Soccer

### **Introduction**

Scientific research is witnessing major developments in the field of sports in general and soccer, in particular, significant developments coinciding with developments in the technological field and nearby science fields like neurobiology, and neuropsychology (Kalbfleisch & Gillmarten, 2013; Mangus et al., 2004; Witol & Webbe, 2003). However, most of the research started and focused on the practical field side, and at the same time neglected the adoption of theoretical frameworks which are considered the natural basis for starting any scientific research, as Karl Popper asserts (Popper, 2005).

The efforts exerted in the field of sports training have achieved progress in soccer. Despite that, there are still persistent problems related to the training process that requires practical scientific solutions that fall on the shoulders of coaches and specialists in soccer, as it requires research on the means and methods of modern and scientific technology enhanced by experiences (Ben Mahfoudh & Zoudji, 2022, p. 20; Lorains et al., 2013; Valls-Serrano et al., 2022) that help to raise the level of tactical intelligence of the soccer player, and thus better understanding and implementing of the various problems and situations that face us in preparing and managing the competition. Perhaps one of the major scientific developments in the field of sports training in soccer is the exploitation of multimedia as an effective means or tool to develop the various mental and skill aspects of players (Khacharem et al., 2013), and it has taken a great deal from the field of thinking of coaches and specialists in the field of training because of its importance and its effectiveness during the training process.

---

- This is an Open Access article distributed under the terms of the Creative Commons Attribution-Noncommercial 4.0 Unported License, permitting all non-commercial use, distribution, and reproduction in any medium, provided the original work is properly cited.

- Selection and peer-review under responsibility of the Organizing Committee of the Conference

© 2022 Published by ISRES Publishing: [www.isres.org](http://www.isres.org)

The interest of trainers at the high level has lately been based on the development of mental aspects more than other aspects (physical and skill), which has become a routine matter inevitable, and attention to mental and cognitive aspects during the training process is what makes the difference during the competition, similar to perception (Coutinho et al., 2018). The visual-spatial, which occupies a central role concerning the mental and cognitive state of the player and the soccer striker in particular, on one hand, this role appears in the player's perception of his position on the field, his movement with the ball, and without a ball, anticipating the playing process, and the dynamism that he must act according to the requirements of the plan and the playing strategies that have been made, practice it beforehand (Kamble et al., 2019). In addition to improving the psychomotor-sensory coordination in which visual-spatial perception plays an essential role, by improving it, the player's performance develops at multiple levels (cognitive, sensory, psychological, and executive performance). Through the above, we wanted to know the contribution of training through multimedia simulation to the development of visual-spatial perception, and its reflection on the player's perfection of tactical situations, and by building a tactical training program based on the theory of cognitive load that can provide instructions to help provide information in a way that encourages the learner to engage in activities that improve intellectual performance (Dehn et al., 2020). It is based on a cognitive architecture consisting of a finite working memory, with partially independent processing units (Visual-spatial Scratchpad, Phonological loop) providing visual and auditory information, which interacts with unlimited long-term memory. According to the theory, it is possible to circumvent the limitations of working memory by encoding multiple elements of information as one element in the cognitive scheme, and by automating rules, and using more than one view (Ginns & Leppink, 2019).

General hypothesis: Simulation (multimedia) training affects the development of the strikers' visual-spatial abilities in soccer. Partial hypothesis: Simulation (multimedia) training affects the development of visual-spatial abilities, and that helps the soccer striker to improve his VSA perception. The development of soccer strikers' visual-spatial perceptual ability in soccer contributes to a greater the time of responsiveness on the different tactical situations. Objectives of the study: 1. Knowing the impact of simulation training (multimedia) on the development of the visual-spatial perception of soccer strikers. 2. Knowing the extent to which the soccer strikers' visual-spatial perception ability in soccer contributes to a greater the time of responsiveness on the different tactical situations.

The importance and capabilities of training through multimedia technology in enhancing the cognitive abilities of the offensive soccer strikers, especially the visual perception of spatial relationships that occupy a central role concerning the mental and cognitive state of the player and the group of strikers. On the other hand, this role appears in the player's awareness of his position on the field, his movement with the ball and without the ball, the prediction of the playing process, and the dynamics according to which he must act according to the requirements of the plan and the tactical situations that were previously trained. In addition to improving the psycho-sensory coordination in which the visual perception of spatial relationships plays a fundamental role (Garel, 2005), by improving it, the player's performance develops at multiple levels (cognitive, sensory, psychological, and executive functioning). On the other hand, the topic occupies an essential role in strengthening communication between the group of soccer strikers and improving their spatial positions in relation to each other and concerning vacant spaces in addition to the position and direction of the ball (Kamble et al., 2019), which will have fundamental repercussions on several levels (the success of the coach's tactical style, the psychological state of the team and the player, anticipating different situations, knowing the appropriate behavior, and facilitating and quickly making a decision).

## **Method**

In this study, we used the experimental method (experimental approach using the unique sample with pre and post-testing design), by conducting a pre-measurement consisting of a test battery. and then we applied a program (visual-spatial, memorization, decision making, Techno-Tactical training) through multimedia on a sample of 20 players. We choosed it intentionally, then conduct telemetry on the sample and study the differences between the two measurements (that will be determined by the SPSS program) to arrive at an answer to the study's questions. We used the students T test to determine the results. We also considered a set of conditions: The limited functionality of the cognitive system (age, years of experience, visual-spatial abilities, responsiveness time), The complexity of contains (numbers, speed, interactions), the organization of contains (the presentation format, segmentation, Etc..), the Conditions of the location of the experiment: Screen size, Brightness, Distance of the player on the screen.. etc.

## **Participants**

The experiment was conducted on 20 soccer player under 23 years of age (M age = 20,85 ; SD = 1,18). The sample size is less average compared to previous studies that analyzed the effect of visual-spatial abilities when using visualizations for experienced soccer players (Khacharem et al., 2014), and have playing experience of at least 5 years (M experience =6.1 years; SD =1.11), all players actively playing in various soccer clubs (the professional Algerian soccer leagues, 60% of players had participated in official games at the Algerian first professional league, 40% had participated in official games at the Algerian second professional league), and they had been playing soccer for an average of 6.1 years (SD = 1.11) and trained or played for an average of 570 min (SD = 126) per week. Participants affirmed that this was their first time participating in a laboratory experiment that included a recall reconstruction-test of soccer animations to prevent familiarity. They had no vision problems, otherwise, it was corrected with glasses or lenses. Finally, they volunteered to participate and provided informed consent. Approval for this project was granted by the local ethics committee.

Table 1. Descriptive Statistics of the sample characteristics

N	Age (years)	Experince (years)
M	20,85	6,1
SD	1,18	1,11

### Instruments

One computerized test was created and displayed on a TOSHIBA Portege Z30-B laptop with a 14-inch screen. The control test consists of a test battery that contains a test of the visual-spatial perception ability (visual-spatial rotation tests) and also contains a multimedia questionnaire (Quiz) designed by a quiz maker program, that contains specific tactical situations (2D pictures, FIFA videos, animations) prepared by Clipdraw, dartfish, and the tactical pad program, with two expert soccer coaches (with over 10 years' experience, licensed by the 3rd Algerian degree of coaching football and the CAF A), one task decision making situations (videos), where we will determine the cognitive readiness and awareness of the players and the visual-spatial on memorization performance. The display was in a full 14-inch screen, with 100% screen Brightness, and a 75 cm distance of the player on the screen with a 45° viewing angle (Khacharem et al., 2014).

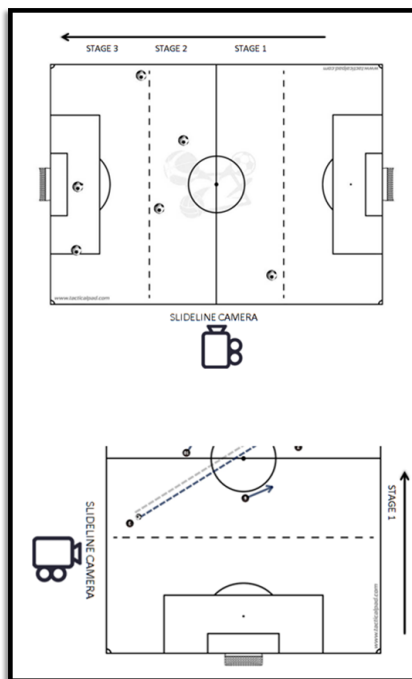

Figure 1. Schematic presentation of the empty soccer play, position of camera side-line and the direction of the play, position of passes and the stages on the soccer paly.

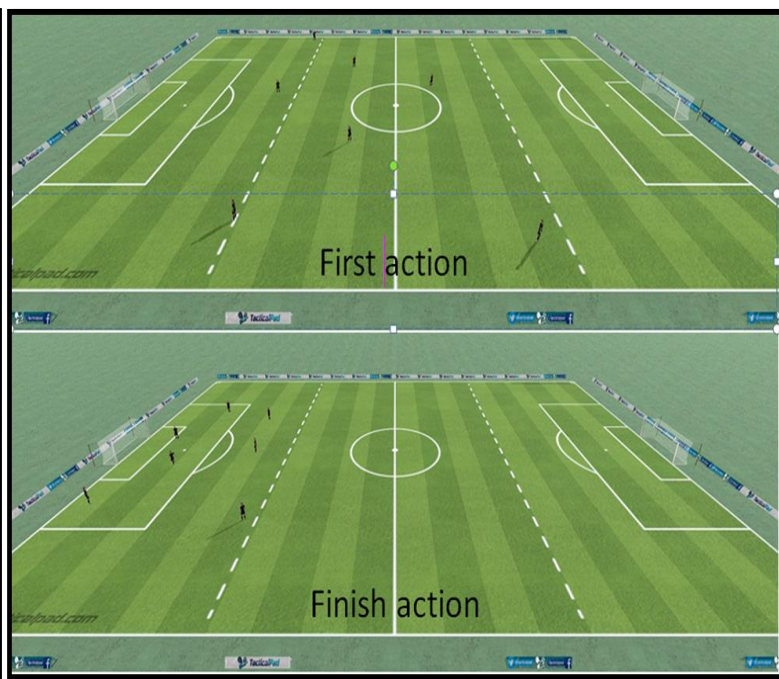

Figure 2. Schematic Representative diagram of the first and the finish 3D animation dynamic scene to memorise

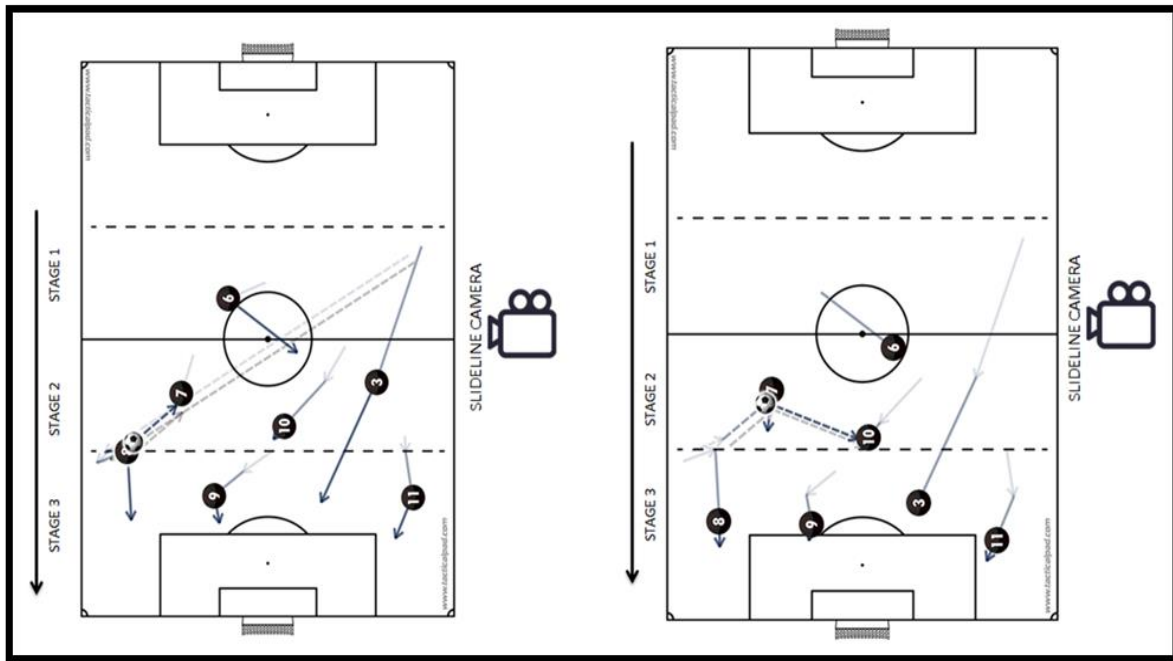

Figure 3. Schematic representative diagram of the dynamic scene to memorise at the STAGE 2. discontinuous arrows represent ball passes and continuous arrows presents players' movements.

Before selecting the offensive tactical situations 3D animations and 2D animations and schema pictures, the construction of the animations, FIFA official games videos, 2D animations and the 2D pictures, coaches were asked to create counterattack scenes that involved seven players who should carry out a tactical combination composed of five passes towards the opponent's court before a shot on goal was taken. During each pass, each player should move concerning the ball and the teammates' positions to offer an appropriate solution to the ball carrier. Each pass corresponded to a new stage made up of multiple offensive actions carried out by the players. Each animation was captured as if it was recorded by a side-line camera in an elevated position of 25°. This camera position enabled the entire field of play to be viewed (Khacharem et al., 2014).

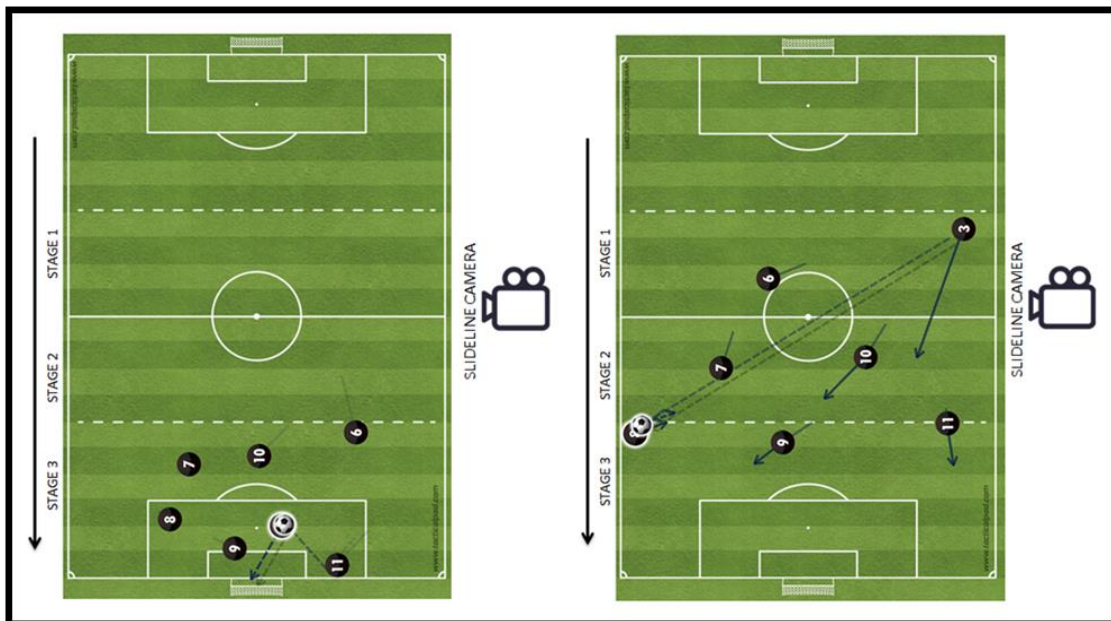

Figure 4. Schematic diagram 2D of the first and the last animation.

Subsequently, a static scene was generated from each animation that included six still frames representing the three main stages of the play, as defined by the same two coaches (i.e., who developed the scenes of the play).

These frames were displayed simultaneously in the same picture. The duration of all scenes of the play was 15 s (2s for each frame).

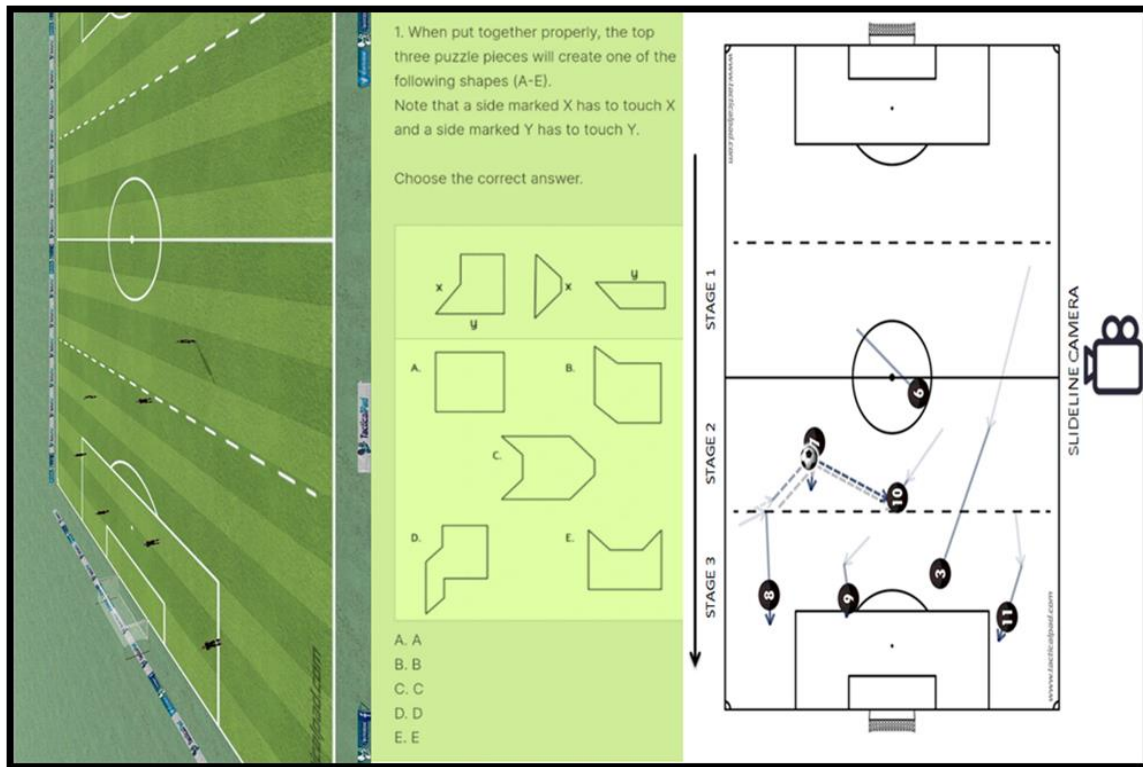

Figure 5. Representative diagram represent the different steps of the battery test.

## Results and Discussion

### Control Test

We arranged all the components in the form of a multimedia quiz that contains four sequences arranged and consecutive, where each series consists of ( $\leq 5$  s video, rotation task, and 3D animation). when the player presses the start button, the time starts counting down and the time is set at 300 seconds (five minutes). After watching the video of an official FIFA game video, the soccer strikers were asked to press the button corresponding to the answer he deems appropriate, A, B, or C, to collect the largest possible score, where we set a total of 10 points for the strong answer, 5 points for the medium answer and 3 points for the weak answer. After the video is finished, the player presses the NEXT button to show him another screen containing a rotation task to select the correct answers only, where for each question there are two correct answers out of four answers, we set 5 points for each correct complete answer that does not accept the partial answer (0 or 5), either Concerning the 3D animation, the player watches the 3D animation (non-returnable) to answer one of the three correct answers out of the three that appear in the form of a 2D other animations or images, so the player collects a total of 10 points for the correct answer. finally the player gets a total of 100 points for the maximum answer score ( video test 40/4 points, rotation test 20/4 points, animation test 40/4) and 24 tenths as a minimum.

Immediately after the pre-measurement, we calculated the strength of the relationship between the level of experience (years) and the visual-spatial perception abilities (score1), by using the Pearson coefficient formula:

$$r = \frac{\sum(x_i - \bar{x})(y_i - \bar{y})}{\sqrt{\sum(x_i - \bar{x})^2 \sum(y_i - \bar{y})^2}}; r = 0.85.$$

In our study the numerical value of correlation of coefficient ( $r=0.85$ ) was between (-1 & + 1). and It is known as real number value, also the 'r' approaches to the side of (+ 1) and that means the relationship is strong and in a positive state.

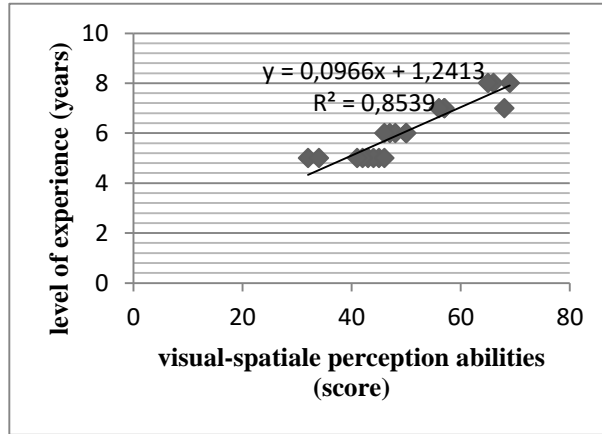

Figure 6. Linear curve represent the strength of the relationship between the level of experience (y) and the visual-spatial perception abilities (x)

The results revealed that there are statistically significant differences between the pre and post-test of the experimental group and in favor of the post-test due to the multimedia simulation training on visual-spatial abilities.

Table 2. Descriptive statistics and differences for visual-spatial abilities battery test.

Test	Pre-test		Post-test	
Variables	Score1 (points)	Time1 (s)	Score2 (points)	Time2 (s)
M	50,3	218,2	64,1	198,9
SD	10,70	22,47	9,18	23,35
t test	0,000283%		0,0034%	

The difference between pre and post-test for score; M score1=50,3 point and a SD=10,70 point in the pre-measurement, while M score2 = 64,1 and SD =9,18 in the post-measurement, and the T value was 0.00028 at a degree of freedom (19) and a level of significance (0.05), and the significant value was sig (0.00), and by comparing the significant significance with the level of significance, we find that sig = 0.00 < α = 0.05, and this is statistically significant, and through the previous results, it can be said that there are statistically significant differences between the pre-measurement and the post-measurement of the sample in testing the visual-spatial abilities score for soccer strikers under 23 years old.

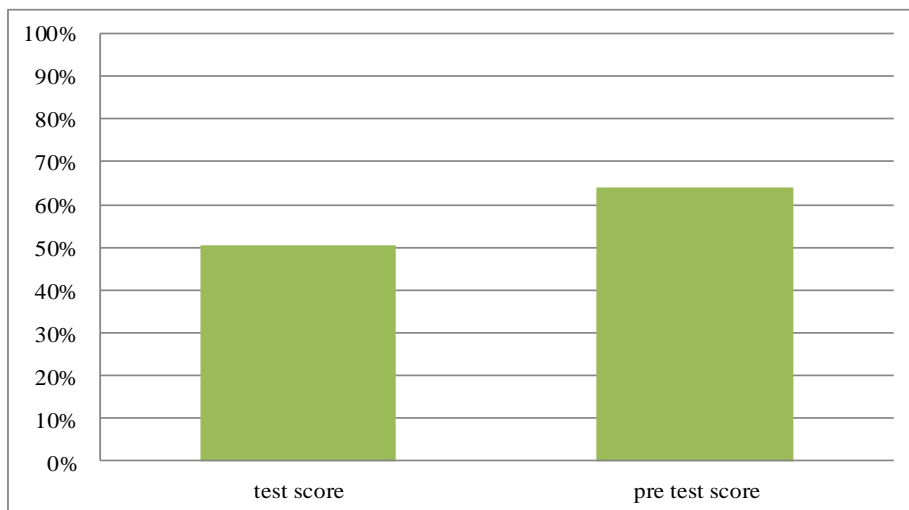

Figure 7. Arithmetic mean of the score between the pre and post-test of the sample, testing of the visual-spatial abilities of soccer strikers under 23 years old.

The difference between pre and post-test for time; M time1 =218.2 s and a SD= 22.47 s in the pre-measurement, while M time2 = 198.8 s and SD =23.35 s in the post-measurement, and the T value was 0.0034 at a degree of freedom (19) and a level of significance (0.05), and the significant value was sig (0.00), and by comparing the



significant significance with the level of significance, we find that  $\text{sig} = 0.00 < \alpha = 0.05$ , and this is statistically significant, and through the previous results, it can be said that there are statistically significant differences between the pre-measurement and the post-measurement of the sample in testing the visual-spatial abilities answer time for soccer strikers under 23 years old.

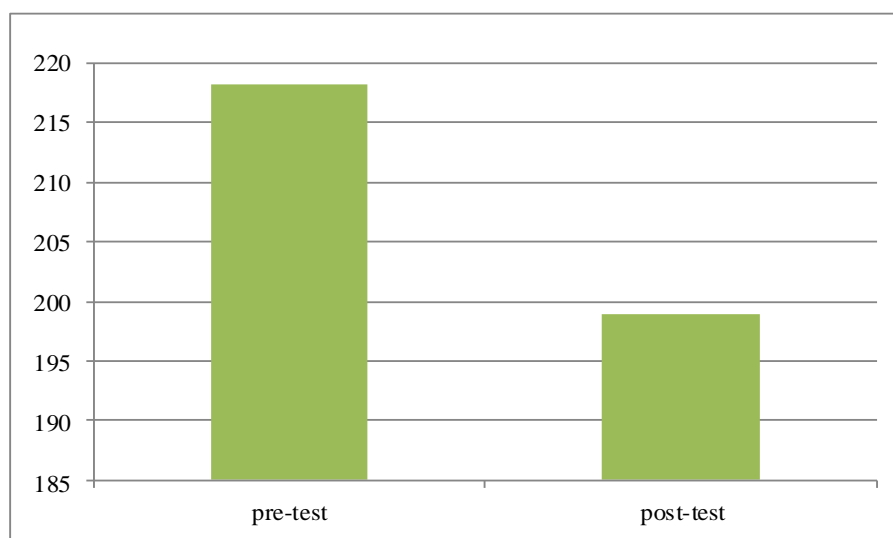

Figure 8. Arithmetic mean of the answer time between the pre and post-test of the sample, testing of the visual-spatial abilities of soccer strikers under 23 years old.

## Conclusion

In this study, we investigated the effect of the efficiency of visual-spatial abilities (memory processes) training through the multimedia simulation of soccer strikers under 23 years of age who have at least 5 years of experience. The control test confirmed that the post-test showed a good improvement in terms of visual-spatial abilities. As expected, our results are in line with previous studies (Khacharem et al., 2013, 2014, 2015) which also reported better learning efficiency scores expert players. These results can be explained by the Simulation (multimedia) training affecting the development of the strikers' visual-spatial perception in football, which is positively reflected in the perfection of memorizing tactical situations. Finally, alongside adapting their tactical instructions, coaches can perform the multimedia simulation training to improve visual-spatial abilities to help the soccer players generally and soccer strikers in particular to improve their perception of their position on the field, his movement with the ball, and without it, anticipating the playing process and the dynamism that they must act according to the requirements of the plan and the playing strategies that they had practiced before. In addition to improving the psychomotor-sensory coordination in which visual-spatial perception plays an essential role, by improving it, the player's performance develops at multiple levels (cognitive, sensory, psychological, and executive performance).

Finally, we recommend to the researchers and soccer community to use the training via multimedia simulation and similar tools as video games, smartphone multimedia applications and more digital devices and games to enhance visual-spatial abilities.

## Scientific Ethics Declaration

The authors declare that the scientific ethical and legal responsibility of this article published in EPSS journal belongs to the authors.

## Acknowledgements

\* This article was presented as an oral presentation at the International Conference on Science and Education ([www.iconse.net](http://www.iconse.net)) held in Antalya/Turkey on November 15-18, 2022.

## References

- Ben Mahfoudh, H., & Zoudji, B. (2022). The role of visuospatial abilities and the level of expertise in memorising soccer animations. *International Journal of Sport and Exercise Psychology*, 20(4), 1033–1048. <https://doi.org/10.1080/1612197X.2021.1940240>
- Coutinho, D., Gonçalves, B., Wong, D. P., Travassos, B., Coutts, A. J., & Sampaio, J. (2018). Exploring the effects of mental and muscular fatigue in soccer players' performance. *Human Movement Science*, 58, 287–296. <https://doi.org/10.1016/j.humov.2018.03.004>
- Dehn, L. B., Piefke, M., Toepper, M., Kohsik, A., Rogalewski, A., Dyck, E., Botsch, M., & Schäbitz, W.-R. (2020). Cognitive training in an everyday-like virtual reality enhances visual-spatial memory capacities in stroke survivors with visual field defects. *Topics in Stroke Rehabilitation*, 27(6), 442–452. <https://doi.org/10.1080/10749357.2020.1716531>
- Garel, J. P. (2005). Adaptations à la dyspraxie visuo-spatiale en Éducation physique et sportive. In *Bilan neuropsychologie et démarches pédagogiques* (pp. 22-27).
- Ginns, P., & Leppink, J. (2019). Special issue on cognitive load theory: Editorial. *Educational Psychology Review*, 31(2), 255–259. <https://doi.org/10.1007/s10648-019-09474-4>
- Kalbfleisch, M. L., & Gillmarten, C. (2013). Left brain vs. right brain: findings on visual spatial capacities and the functional neurology of giftedness. *Roeper Review*, 35(4), 265–275. <https://doi.org/10.1080/02783193.2013.829549>
- Kamble, P. R., Keskar, A. G., & Bhurchandi, K. M. (2019). A deep learning ball tracking system in soccer videos. *Opto-Electronics Review*, 27(1), 58–69. <https://doi.org/10.1016/j.opelre.2019.02.003>
- Khacharem, A., Zoudji, B., & Kalyuga, S. (2015). Perceiving versus inferring movements to understand dynamic events: The influence of content complexity. *Psychology of Sport and Exercise*, 19, 70–75. <https://doi.org/10.1016/j.psychsport.2015.03.004>
- Khacharem, A., Zoudji, B., Kalyuga, S., & Ripoll, H. (2013). The expertise reversal effect for sequential presentation in dynamic soccer visualizations. *Journal of Sport and Exercise Psychology*, 35(3), 260–269. <https://doi.org/10.1123/jsep.35.3.260>
- Khacharem, A., Zoudji, B., Spanjers, I. A. E., & Kalyuga, S. (2014). Improving learning from animated soccer scenes: Evidence for the expertise reversal effect. *Computers in Human Behavior*, 35, 339–349. <https://doi.org/10.1016/j.chb.2014.03.021>
- Lorains, M., Ball, K., & MacMahon, C. (2013). Expertise differences in a video decision-making task: Speed influences on performance. *Psychology of Sport and Exercise*, 14(2), 293–297. <https://doi.org/10.1016/j.psychsport.2012.11.004>
- Mangus, B. C., Wallmann, H. W., & Ledford, M. (2004). Soccer: Analysis of postural stability in collegiate soccer players before and after an acute bout of heading multiple Soccer balls. *Sports Biomechanics*, 3(2), 209–220. <https://doi.org/10.1080/14763140408522841>
- Popper, K. R. (2005). *The logic of scientific discovery*. Routledge.
- Valls-Serrano, C., De Francisco, C., Vélez-Coto, M., & Caracuel, A. (2022). Visuospatial working memory and attention control make the difference between experts, regulars and non-players of the videogame League of Legends. *Frontiers in Human Neuroscience*, 16, 933331. <https://doi.org/10.3389/fnhum.2022.933331>
- Witol, A. D., & Webbe, F. M. (2003). Soccer heading frequency predicts neuropsychological deficits. *Archives of Clinical Neuropsychology*, 21.

---

## Author Information

---

### Radhouane Lorabi

Djilali Bounaama University  
Road of teniat el had Ain Defla 44225  
Algeria  
Contact e-mail: [radhouane.lorabi@univ-dbkm.dz](mailto:radhouane.lorabi@univ-dbkm.dz)

### Belaid Akil Abdelkader

Djilali Bounaama University  
Road of teniat el had Ain Defla 44225  
Algeria

---

### To cite this article:

Lorabi, R. & Abdelkader, B.A. (2022). The efficiency of visual-spatial abilities (memory processes) training through multimedia simulation for soccer strikers. *The Eurasia Proceedings of Educational & Social Sciences (EPESS)*, 28, 54-61.

The Eurasia Proceedings of Educational & Social Sciences (EPESS), 2022

Volume 28, Pages 62-68

**IConSE 2022: International Conference on Science and Education**

## **Comparison of Individuals' Computer Skills with Multi-Criteria Decision-Making Methods: Turkey-European Countries**

**Orhan ECEMIS**  
Gaziantep University

**Aysun COSKUN**  
Gazi University

**Abstract:** Great changes have occurred in today's society in the last 50 years. Information has become the most important resource. With the spread of individual computer ownership since the 1990s, the transformation into an information society has accelerated. With the development of multimedia tools, especially with the creation of the internet infrastructure, not only difficulties have arisen in accessing information, but also conditions suitable for the production of new information have been provided. These developments accelerated the economic and social developments of societies. In this context, computer skill levels, which should be in qualified manpower, have also been a subject of interest in the academic field. In this study, multi-criteria decision-making methods and individual computer skill levels of Turkey and European countries are discussed. The data set used in the study was obtained from the individual computer skills level research on the European Statistical Office website. The criteria in the data set are weighted by the Entropy method. Comparison of individual computer usage levels by countries was carried out with the ARAS method. Considering the limitations of the research and the findings obtained by the Aras method, it can be said that Iceland, Finland and the Netherlands, which were found to be the most successful in the ranking of individual computer skills, were followed by other countries.

**Keywords:** Computer skills, Multi-criteria, Decision making

### **Introduction**

The information age we live in can be thought of as a period that information and communication technologies manage and direct. In this period, every work done, every process developed and every product produced is developed by using information and communication technologies (Güner, 2020). In this context, when we evaluate today's processes in terms of efficiency, it can be thought that it is necessary to develop individuals' computer skills. Developments in information technologies have affected many sectors. With Industry 3.0, where nanotechnology, biotechnology, new materials and recycling technologies lead, machine learning, data-cyber physical systems-3 D printers etc. Industry 4.0 technologies, which show themselves with titles, produce new technological breakthroughs in the 21st century (Haseski, 2019). Developing digital skills is seen as a prerequisite for the realization of digital transformation and economic growth in the world, increasing the welfare level of citizens and creating a digital economy strategy(Gülbahar and Kalelioğlu,2018). Individuals' attitudes towards information technologies are important for the development of digital skills. In this study, individual computer skill levels of Turkey and European Countries were compared with Entropy and ARAS methods.

The studies conducted in the literature to compare countries with multi-criteria decision-making methods are as follows. Ayçin and Çakın (2019) evaluated the innovation performance of countries with Entropy and MABAC

---

- This is an Open Access article distributed under the terms of the Creative Commons Attribution-Noncommercial 4.0 Unported License, permitting all non-commercial use, distribution, and reproduction in any medium, provided the original work is properly cited.

- Selection and peer-review under responsibility of the Organizing Committee of the Conference

© 2022 Published by ISRES Publishing: [www.isres.org](http://www.isres.org)

methods. Tunca et al. (2016) examined OPEC country performances using Entropy and MAUT methods. Çakır and Perçin (2013) discussed the R&D performances of EU countries with Entropy and TOPSIS methods.

## Method

The aim of the study is to compare the individual computer usage skills, which are one of the criteria of the information society, between Turkey and EU countries. The criteria in the data set created in the study were weighted by the entropy method. The ARAS method, which is one of the multi-criteria decision-making methods, was used to compare individual usage skills according to countries.

### Entropy Method

The concept of entropy was first proposed by Rudolf Clausius in 1865 and is known as a criterion of disorder and distribution in thermodynamics. Entropy, which is one of the methods that determines criterion weights in Multi-Criteria Decision-Making Problems, produces objective results based on the values of alternatives without the need for decision makers' evaluations. Entropy method process steps (Ömürbek, et al. 2016):

- Creating the Decision Matrix
- Obtaining the Normalized Decision Matrix
- Calculating the Degree of Differentiation of Information ( $d_j$ )
- Calculation of Entropy Criterion Weights

### Additive Ratio Assessment (ARAS) Method

Additive Ratio Assessment (ARAS), one of the Multi-Criteria Decision Making methods, was presented as a new approach to its solution by Z. Turskis and E. K. Zavadskas. Generally, the structure of a MCDM problem is related to the problem of ordering a finite number of decision alternatives clearly defined by different decision criteria. According to the ARAS method, the value of the utility function, which determines the complex relative efficiency of a viable alternative, is directly proportional to the relative effect of the decision criteria values and weights considered in the problem.(Turskis and Zavadskas, 2010). ARAS method operation steps:

- Creating the Decision Matrix: Determining the optimization direction of the criteria and preparing the alternatives in matrix form according to the criteria.
- Generating the Normalized Decision Matrix: Eliminating the inconsistencies in different measurement units between the criteria.
- Construction of the Weighted Normalized Decision Matrix: Rearrangement of the normalized decision matrix according to the criterion weights.
- Calculation of Optimality Function Values: In the last step of the ARAS method, the optimality function value is calculated for each alternative and the evaluation of the alternatives is performed.  $S_i$ , i. optimality of the alternative function value,  $S_o$  is the optimal function value,  $K_i$  is ( $S_i / S_o$ ) the utility value. Alternatives are ranked in descending order of  $K_i$  value.

Table 1. Criteria and explanations used in the study

ID	Criteria	Unit	Benefit/Cost
C1	Individuals who have written code in a programming language	%	Benefit
C2	Individuals who have copied or moved files between folders, devices or on the cloud	%	Benefit
C3	Individuals who downloaded or installed software or apps	%	Benefit
C4	Individuals who changed the settings of software, app or device	%	Benefit
C5	Individuals who used word processing software	%	Benefit
C6	Individuals who have created files integrating elements such as text, pictures, tables, charts, animations or sound	%	Benefit
C7	Individuals who used spreadsheet software (3 months)	%	Benefit
C8	Individuals who used advanced features of spreadsheet software to organise, analyse, structure or modify data	%	Benefit
C9	Individuals who edited photos, video or audio files	%	Benefit

## Data Collection

The data used in the study were obtained from the Individuals' computer skills level survey on the European Statistical Office website. Based on the annual survey of ICT use by households and individuals since 2002, the EU survey aims to collect and disseminate consistent and comparable information on ICT use by households and individuals. Information on the criteria included in the study is given in Table 1.

## Data Analysis

In the analysis of the data, applications of entropy and intermediate methods were carried out in Microsoft Excel program.

Table 2. Decision matrix

Country	C1	C2	C3	C4	C5	C6	C7	C8	C9
Belgium	5	50	45	18	56	45	44	21	27
Bulgaria	1	39	25	19	28	20	14	6	19
Czechia	5	57	48	17	53	30	40	20	28
Denmark	11	64	65	53	46	58	48	29	32
Germany	5	53	44	25	47	24	34	25	31
Estonia	6	55	50	39	50	36	42	26	34
Ireland	8	63	60	46	59	51	47	26	45
Greece	3	56	41	24	53	30	36	16	19
Spain	8	65	61	45	54	48	42	25	41
France	6	69	58	45	59	49	44	23	41
Croatia	4	81	43	35	41	27	67	46	23
Italy	6	51	49	42	42	39	33	21	29
Cyprus	5	54	50	40	53	33	40	19	15
Latvia	5	58	46	38	44	34	33	16	23
Lithuania	5	53	45	40	46	32	40	16	37
Luxembourg	9	65	58	41	58	47	45	26	44
Hungary	4	49	35	30	47	26	36	21	23
Malta	9	53	60	31	53	39	45	34	35
Netherlands	10	71	71	60	71	55	54	32	45
Austria	10	65	55	45	60	49	46	26	46
Poland	5	51	44	36	43	34	28	10	24
Portugal	7	38	35	18	51	43	38	18	38
Romania	1	34	25	17	21	25	19	5	17
Slovenia	6	49	41	31	55	39	33	15	27
Slovakia	4	65	39	27	52	36	40	21	24
Finland	10	71	70	60	70	54	51	33	54
Sweden	10	62	65	49	67	49	45	18	34
Iceland	10	65	74	57	78	48	67	48	43
Norway	12	63	75	58	77	63	56	27	38
Switzerland	9	81	62	43	66	43	53	24	40
Montenegro	7	79	49	22	58	34	33	21	21
North Macedonia	3	36	26	8	23	19	8	5	9
Albania	6	22	27	7	18	15	11	5	21
Serbia	2	61	49	31	50	25	24	8	20
Turkey	3	28	34	23	15	16	14	7	24
Bosnia and Herzegovina	2	55	31	16	37	23	18	6	10

Source: Eurostat Data Browser

## Results and Discussion

### Criteria Weights

The criteria used in the study were calculated by the entropy method given in Table 3. When Table 3 is examined, the three most important criteria are respectively (C8;C1;C4), people who use advanced features of

spreadsheet software to organize, analyze, configure, or manipulate data (19.6%); people who write code in a programming language (17.9%); people change software, application, or device settings (14.1%).

When other criteria weights are examined, use of spreadsheet software is 11.4% (C7), editing photos, video or audio files 10,2% (C9), created files integrating elements such as text, pictures, tables, charts, animations 8.4% (C6), word processing software using 7.5% (C5), using downloaded or installed software or applications 6.2% (C3), handling files copied or moved on folders, devices or the cloud 4.2% (C2).

Table 3. Criterion weights

Value	C1	C2	C3	C4	C5	C6	C7	C8	C9	
$E_j$	0,966	0,991	0,988	0,974	0,986	0,984	0,979	0,963	0,981	Sum
$D_j$	0,034	0,009	0,012	0,026	0,014	0,016	0,021	0,037	0,019	0,187
$w_i$	0,179	0,047	0,062	0,141	0,075	0,084	0,114	0,196	0,102	1

### Comparison of Country Performances

In the comparison of country performances, the decision matrix, which is also the data set, is normalized (Table 4).

Table 4. Normalized decision matrix

Country	c1	c2	c3	c4	c5	c6	c7	c8	c9
Optimal Value	0,051	0,346	0,321	0,256	0,333	0,269	0,286	0,205	0,231
Belgium	0,021	0,214	0,192	0,077	0,239	0,192	0,188	0,090	0,115
Bulgaria	0,004	0,167	0,107	0,081	0,120	0,085	0,060	0,026	0,081
Czechia	0,021	0,244	0,205	0,073	0,226	0,128	0,171	0,085	0,120
Denmark	0,047	0,274	0,278	0,226	0,197	0,248	0,205	0,124	0,137
Germany	0,021	0,226	0,188	0,107	0,201	0,103	0,145	0,107	0,132
Estonia	0,026	0,235	0,214	0,167	0,214	0,154	0,179	0,111	0,145
Ireland	0,034	0,269	0,256	0,197	0,252	0,218	0,201	0,111	0,192
Greece	0,013	0,239	0,175	0,103	0,226	0,128	0,154	0,068	0,081
Spain	0,034	0,278	0,261	0,192	0,231	0,205	0,179	0,107	0,175
France	0,026	0,295	0,248	0,192	0,252	0,209	0,188	0,098	0,175
Croatia	0,017	0,346	0,184	0,150	0,175	0,115	0,286	0,197	0,098
Italy	0,026	0,218	0,209	0,179	0,179	0,167	0,141	0,090	0,124
Cyprus	0,021	0,231	0,214	0,171	0,226	0,141	0,171	0,081	0,064
Latvia	0,021	0,248	0,197	0,162	0,188	0,145	0,141	0,068	0,098
Lithuania	0,021	0,226	0,192	0,171	0,197	0,137	0,171	0,068	0,158
Luxembourg	0,038	0,278	0,248	0,175	0,248	0,201	0,192	0,111	0,188
Hungary	0,017	0,209	0,150	0,128	0,201	0,111	0,154	0,090	0,098
Malta	0,038	0,226	0,256	0,132	0,226	0,167	0,192	0,145	0,150
Netherlands	0,043	0,303	0,303	0,256	0,303	0,235	0,231	0,137	0,192
Austria	0,043	0,278	0,235	0,192	0,256	0,209	0,197	0,111	0,197
Poland	0,021	0,218	0,188	0,154	0,184	0,145	0,120	0,043	0,103
Portugal	0,030	0,162	0,150	0,077	0,218	0,184	0,162	0,077	0,162
Romania	0,004	0,145	0,107	0,073	0,090	0,107	0,081	0,021	0,073
Slovenia	0,026	0,209	0,175	0,132	0,235	0,167	0,141	0,064	0,115
Slovakia	0,017	0,278	0,167	0,115	0,222	0,154	0,171	0,090	0,103
Finland	0,043	0,303	0,299	0,256	0,299	0,231	0,218	0,141	0,231
Sweden	0,043	0,265	0,278	0,209	0,286	0,209	0,192	0,077	0,145
Iceland	0,043	0,278	0,316	0,244	0,333	0,205	0,286	0,205	0,184
Norway	0,051	0,269	0,321	0,248	0,329	0,269	0,239	0,115	0,162
Switzerland	0,038	0,346	0,265	0,184	0,282	0,184	0,226	0,103	0,171
Montenegro	0,030	0,338	0,209	0,094	0,248	0,145	0,141	0,090	0,090
N.Macedonia	0,013	0,154	0,111	0,034	0,098	0,081	0,034	0,021	0,038
Albania	0,026	0,094	0,115	0,030	0,077	0,064	0,047	0,021	0,090
Serbia	0,009	0,261	0,209	0,132	0,214	0,107	0,103	0,034	0,085
Turkey	0,013	0,120	0,145	0,098	0,064	0,068	0,060	0,030	0,103
Bos. and Herz.	0,009	0,235	0,132	0,068	0,158	0,098	0,077	0,026	0,043

With the weights obtained from the entropy method, the normalized decision matrix is transformed into a weighted normalized decision matrix (Table 5). The optimal function values (Si) and utility degrees (Ki) of the alternatives (countries) are calculated and given in Table 6. The rankings of countries are presented in Table 6 in descending order of utility degrees.

Table 5. Weighted normalized decision matrix

Country	c1	c2	c3	c4	c5	c6	c7	c8	c9
Optimal Value	0,009	0,016	0,020	0,036	0,025	0,023	0,033	0,040	0,023
Belgium	0,004	0,010	0,012	0,011	0,018	0,016	0,022	0,018	0,012
Bulgaria	0,001	0,008	0,007	0,011	0,009	0,007	0,007	0,005	0,008
Czechia	0,004	0,011	0,013	0,010	0,017	0,011	0,020	0,017	0,012
Denmark	0,008	0,013	0,017	0,032	0,015	0,021	0,023	0,024	0,014
Germany	0,004	0,011	0,012	0,015	0,015	0,009	0,017	0,021	0,013
Estonia	0,005	0,011	0,013	0,023	0,016	0,013	0,021	0,022	0,015
Ireland	0,006	0,013	0,016	0,028	0,019	0,018	0,023	0,022	0,020
Greece	0,002	0,011	0,011	0,014	0,017	0,011	0,018	0,013	0,008
Spain	0,006	0,013	0,016	0,027	0,017	0,017	0,021	0,021	0,018
France	0,005	0,014	0,015	0,027	0,019	0,018	0,022	0,019	0,018
Croatia	0,003	0,016	0,011	0,021	0,013	0,010	0,033	0,038	0,010
Italy	0,005	0,010	0,013	0,025	0,014	0,014	0,016	0,018	0,013
Cyprus	0,004	0,011	0,013	0,024	0,017	0,012	0,020	0,016	0,007
Latvia	0,004	0,012	0,012	0,023	0,014	0,012	0,016	0,013	0,010
Lithuania	0,004	0,011	0,012	0,024	0,015	0,011	0,020	0,013	0,016
Luxembourg	0,007	0,013	0,015	0,025	0,019	0,017	0,022	0,022	0,019
Hungary	0,003	0,010	0,009	0,018	0,015	0,009	0,018	0,018	0,010
Country	0,007	0,011	0,016	0,019	0,017	0,014	0,022	0,028	0,015
Malta	0,008	0,014	0,019	0,036	0,023	0,020	0,026	0,027	0,020
Netherlands	0,008	0,013	0,015	0,027	0,019	0,018	0,023	0,022	0,020
Austria	0,004	0,010	0,012	0,022	0,014	0,012	0,014	0,008	0,010
Poland	0,005	0,008	0,009	0,011	0,016	0,015	0,019	0,015	0,017
Portugal	0,001	0,007	0,007	0,010	0,007	0,009	0,009	0,004	0,007
Romania	0,005	0,010	0,011	0,019	0,018	0,014	0,016	0,013	0,012
Slovenia	0,003	0,013	0,010	0,016	0,017	0,013	0,020	0,018	0,010
Slovakia	0,008	0,014	0,019	0,036	0,023	0,019	0,025	0,028	0,023
Finland	0,008	0,012	0,017	0,029	0,022	0,018	0,022	0,015	0,015
Sweden	0,008	0,013	0,020	0,034	0,025	0,017	0,033	0,040	0,019
Iceland	0,009	0,013	0,020	0,035	0,025	0,023	0,027	0,023	0,017
Norway	0,007	0,016	0,016	0,026	0,021	0,015	0,026	0,020	0,017
Switzerland	0,005	0,016	0,013	0,013	0,019	0,012	0,016	0,018	0,009
Montenegro	0,002	0,007	0,007	0,005	0,007	0,007	0,004	0,004	0,004
N.Macedonia	0,005	0,004	0,007	0,004	0,006	0,005	0,005	0,004	0,009
Albania	0,002	0,012	0,013	0,019	0,016	0,009	0,012	0,007	0,009
Serbia	0,002	0,006	0,009	0,014	0,005	0,006	0,007	0,006	0,010
Turkey	0,002	0,011	0,008	0,010	0,012	0,008	0,009	0,005	0,004
Bos. and Her.	0,009	0,016	0,020	0,036	0,025	0,023	0,033	0,040	0,023

## Conclusion

In this study, the computer skills levels of individuals in Turkey and European countries were compared with multi-criteria decision making methods. The criteria used in the study were weighted by the entropy method. According to the findings obtained by the entropy method, advanced use of spreadsheet software to analyze and configure data, writing code in a programming language, and realizing software, application or device type come to the fore. This situation coincides with the order of importance in today's computer education issues. In the findings obtained by the ARAS method, it can be said that Iceland, Finland and the Netherlands are the three most successful countries, respectively.

Table 6. Calculation of optimal function values and ranking

Si	Ki	Rank	Country	Rank	Country
0,2255	1				
0,1216	0,539330373	19	Belgium	1	Iceland
0,0629	0,279121058	33	Bulgaria	2	Finland
0,1145	0,507755248	26	Czechia	3	Netherlands
0,1676	0,743288399	5	Denmark	4	Norway
0,1159	0,514002447	24	Germany	5	Denmark
0,1384	0,613776461	15	Estonia	6	Switzerland
0,1639	0,72686551	7	Ireland	7	Ireland
0,1059	0,46963676	28	Greece	8	Austria
0,1563	0,692957365	11	Spain	9	Luxembourg
0,1560	0,691844026	12	France	10	Sweden
0,1559	0,691217792	13	Croatia	11	Spain
0,1269	0,562671713	16	Italy	12	France
0,1228	0,544752191	18	Cyprus	13	Croatia
0,1164	0,516078501	22	Latvia	14	Malta
0,1257	0,557630127	17	Lithuania	15	Estonia
0,1584	0,702293698	9	Luxembourg	16	Italy
0,1098	0,487069058	27	Hungary	17	Lithuania
0,1488	0,65982652	14	Malta	18	Cyprus
0,1921	0,851968114	3	Netherlands	19	Belgium
0,1635	0,72488618	8	Austria	20	Montenegro
0,1059	0,469573611	29	Poland	21	Slovakia
0,1151	0,510427778	25	Portugal	22	Latvia
0,0610	0,270598587	34	Romania	23	Slovenia
0,1161	0,514652405	23	Slovenia	24	Germany
0,1199	0,531643942	21	Slovakia	25	Portugal
0,1944	0,862309009	2	Finland	26	Czechia
0,1578	0,699676932	10	Sweden	27	Hungary
0,2085	0,924777559	1	Iceland	28	Greece
0,1905	0,844661597	4	Norway	29	Poland
0,1655	0,733806961	6	Switzerland	30	Serbia
0,1211	0,537104366	20	Montenegro	31	Bos. and Herz.
0,0474	0,210385243	36	N. Macedonia	32	Turkey
0,0502	0,222777276	35	Albania	33	Bulgaria
0,0976	0,43267873	30	Serbia	34	Romania
0,0644	0,285784694	32	Turkey	35	Albania
0,0687	0,30475035	31	Bosn. and Herz.	36	N. Macedonia

## Recommendations

In future studies, comparisons can be made with multi-criteria decision-making methods different from the methods used in this study. Relationships between other variables in computer software and individual computer use skills can be investigated by country.

## Scientific Ethics Declaration

The authors declare that the scientific ethical and legal responsibility of this article published in EPESS journal belongs to the authors.

## Acknowledgements

\* This article was presented as an oral presentation at the International Conference on Science and Education ([www.iconse.net](http://www.iconse.net)) held in Antalya/Turkey on November 15-18, 2022



## References

- Ayçin, E. & Çakın, E. (2019). Ülkelerin inovasyon performanslarının ölçümünde entropi ve MABAC çok kriterli karar verme yöntemlerinin bütünleşik olarak kullanılması. *Akdeniz İİBF Dergisi*, 19(2), 326-351. <https://doi.org/10.25294/aiiibfd.649275>
- Çakır, S., & Perçin, S. (2013). AB ülkeleri'nde bütünleşik entropi ağırlık-topsis yöntemiyle Ar-Ge performansının ölçülmesi. *Uludağ Journal of Economy & Society*, 32(1).
- Eurostat. (2022). *Individuals' level of computer skills (2021 onwards)*. Retrieved from [https://ec.europa.eu/eurostat/databrowser/view/ISOC\\_SK\\_CSCL\\_I21\\_\\_custom\\_3578892/default/map?](https://ec.europa.eu/eurostat/databrowser/view/ISOC_SK_CSCL_I21__custom_3578892/default/map?)
- Gülbahar, Y., & Kalelioğlu, F. (2018). Bilişim teknolojileri ve bilgisayar bilimi: Öğretim programı güncelleme süreci. *Milli Eğitim Dergisi*, 47 (217), 5-23. Retrieved from <https://dergipark.org.tr/en/pub/milliegitim/issue/39632/462315>
- Güner, O. (2020). Bilgi toplumu göstergeleri bağlamında Avrupa Birliği ülkeleri ve Türkiye'ye dair bir değerlendirme. *İşletme Ekonomi ve Yönetim Araştırmaları Dergisi*, 121-143.
- Haseski, H. İ. (2019). Bilişim teknolojileri dersi: Öğretmen adaylarının bakış açısından bir değerlendirme. *Trakya Eğitim Dergisi*, 9(4), 666-679. <https://doi.org/10.24315/tred.494705>
- Ömürbek, N., Karaatlı, M., & Balcı, H. F. (2016). ENTROPİ temelli MAUT ve SAW yöntemleri ile otomotiv firmalarının performans değerlendirilmesi. *Dokuz Eylül Üniversitesi İktisadi ve İdari Bilimler Fakültesi Dergisi*, 31(1), 227-255.
- Tunca, M. Z., Ömürbek, N., Cömert, H. G., & Aksoy, E. (2016). OPEC ülkelerinin performanslarının çok kriterli karar verme yöntemlerinden Entropi ve Maut ile değerlendirilmesi. *Süleyman Demirel Üniversitesi Vizyoner Dergisi*, 7(14), 1-12.
- Zavadskas, E. K., Turskis, Z., & Vilutiene, T. (2010). Multiple criteria analysis of foundation instalment alternatives by applying Additive Ratio Assessment (ARAS) method. *Archives of Civil and Mechanical Engineering*, 10(3), 123-141.

---

## Author Information

### Orhan ECEMIS

Gaziantep University, Department of Computer Technologies  
Gaziantep/TURKEY  
Contact e-mail: [oeemis@gantep.edu.tr](mailto:oeemis@gantep.edu.tr)

### Aysun COSKUN

Gazi University, Department of Computer Engineering  
Ankara/TURKEY

---

## To cite this article:

Ecemis, O. & Coskun, A. (2022). Comparison of individuals' computer skills with multi-criteria decision-making methods: Turkey-European countries. *The Eurasia Proceedings of Educational & Social Sciences (EPESS)*, 28, 62-68.

**The Eurasia Proceedings of Educational & Social Sciences (EPESS), 2022**

**Volume 28, Pages 69-82**

**IConSE 2022: International Conference on Science and Education**

## **The Investigation of Future Expectations of Individuals Graduated from the Department of Child Development**

**Ibrahim BENEK**

Turkish Ministry of National Education

**Abstract:** The purpose of this study is to identify the future expectations of graduates who have graduated from the child development undergraduate department and who are not currently assigned to their profession. Phenomenological pattern, a qualitative research method, was utilized in the study. The study was conducted with 14 graduated from the department of child development, 13 of whom were female and 1 male, who were preparing for the Public Personnel Selection Examination (KPSS) in a private teaching institution located in the Eastern Anatolia Region of Turkey. Participants were chosen using criterion sampling, one of the purposive sampling methods. The research data was collected through semi-structured interviews. Descriptive and content analysis methods were used to analyze the data. The gathered data were coded, categorized into themes, and evaluated. When the opinions of the individuals who graduated from the child development department about their future expectations are examined; it is detected that the participants chose to study in this department for various reasons, including a fondness for children, the ease of getting a job, and having studied the same subject in their previous educational life, they have fears for the future, they want to be in a positive social environment in the future, they have professional and career objectives for their field, desire a prosperous economic future, question the criteria for appointment or finding a job in their field, have a tendency to come up with alternate solutions for getting hired or finding a job, place importance on personal growth in order to live a good life, and have various plans for their personal life.

**Keywords:** Future expectation, Child development, Finding a job, Good life, Fondness for children

### **Introduction**

From an early age, people make an effort to have a better future. So much so that investing in the future is in human nature. The modern way of living necessitates people to improve their living conditions and secure their future. Efforts must be commenced now to have a better and more peaceful future. In line with this purpose, people make plans for the future and attempt to implement those plans as time goes by. The ability to set goals for the future and work towards that vision is a significant accomplishment. However, each individual's future-oriented ideas, activities, and investments vary from person to person. Then, what kind of future do we envision for ourselves, and what are our future expectations? The fact that people have different worldviews and different understandings regarding the meaning of life makes their answers to these questions also different. People with different life philosophies also have different expectations for the future regarding their careers, titles, financial well-being, private and family lives, academic attainment, and other aspects of their life. Then, what is this "future expectation"? The definition of the word "expectation" is "what is expected to occur" or "a person's forecast about the forms that particular events and situations would take or what is expected of him" (TDK, 2022). Expectations are future-oriented. Future expectations are the person's future goals and the road maps that lead to those goals (Koçak & Çepni, 2017). In order to realize their goals for the future, young people engage in efforts that foster growth and transformation. Certainly, the challenges young people face and their expectations for the future are significant in terms of their mental well-being and happiness, as well as the development and evolution of the environment in which they belong (Yavuzer et al., 2005: 94).

---

- This is an Open Access article distributed under the terms of the Creative Commons Attribution-Noncommercial 4.0 Unported License, permitting all non-commercial use, distribution, and reproduction in any medium, provided the original work is properly cited.

- Selection and peer-review under responsibility of the Organizing Committee of the Conference

© 2022 Published by ISRES Publishing: [www.isres.org](http://www.isres.org)

A person's expectation of the future is a complicated and multi-directional process. The future expectations of an individual are influenced by various factors, including their knowledge of the surrounding environment, the viewpoints of those with whom they interact, their past experiences, their social, psychological, and financial situation, as well as their drive for success. Another characteristic of the human mind and behavior is an orientation to future events and outcomes (Nurmi, 1991). This orientation is a natural process in which humans engage, and it is necessitated by the modern way of living. In recent years, psychological theories have focused on future orientation (Nurmi, 1991). A person who does not think about or plan for the future may come to regret it after a certain time. Various studies have reported that children and adolescents with optimistic future expectations and plans are less likely to experience psychological and social problems later in life (McCabe & Barnett, 2000).

For young people, in particular, it is crucial to think ahead and make future-oriented plans (Nurmi, 1991). The future expectations of young people have been the subject of many national and international studies (Aktaş, 2016; Alagöz, 2018; Avar, 2019; Başkonuş et al., 2011; Cunningham et al., 2009; Daigle & Hoffman, 2018; Ege, 2018; Iovu et al., 2018; İleri, 2019; McCabe & Barnett, 2000; Michael, 2019; Savcı, 2016; Schmid et al., 2011; Stoddard & Pierce, 2015; Şahin, 2021; Topaktaş, 2015; Tuncer, 2011; Türkön, 2019). The sample populations of these studies include young people at risk, young people who have experienced violence, high school students, and college students. When the literature is reviewed, it is observed that studies have been conducted on the future expectations of Turkish students. These studies include secondary school students (Baş, 2019), high school students (Alagöz, 2019; Avar, 2019; Ege, 2019; İflazoğlu et al., 2021; Savcı, 2016; Selek Şahin, 2021; Şimşek, 2012; Türkön, 2019), university students majoring in tourism (Davras & Alili, 2019), engineering faculty, economics faculty, law faculty (Koçak & Çepni, 2017), associate degree students (Akbaşlı et al., 2017; İleri, 2019; Tekin & Akgemci, 2018; Üzüm & Uçkun, 2015), business administration majors (Aytaç & Soylu, 2019), education faculty majors (Başkonuş et al., 2011), and students majoring in the faculty of administrative and managerial sciences. As can be seen, studies have been conducted on the future expectations of Turkish university students enrolled in a variety of departments.

Depending on their expectations of financial gain and ease of assignment/employment, young people in Turkey may have different preferences for the university they want to attend and the department they wish to study at. These preferences are also influenced by a variety of other factors, such as the cost of living in the city where the university they wish to attend is located; the university's prestige; social opportunities; family; role models; geographical location; cultural values; past experiences; and similar factors; as well as financial gain and the ease of finding a job or assignment. The individual's decision as to which institution he will attend and which major he will pursue there will have an impact on determining his future professional life and career (Topoğlu & Topoğlu, 2018). In recent years, the department of child development has risen to prominence among the departments preferred by young people in Turkey. This may have been influenced by the launch of department-specific distance education programs, the ease of assignment/finding a job, and the broad employment opportunities (nursery, nursing home, hospital, and so on).

The education on child development is provided at the secondary, vocational (two-year), and undergraduate (four-year) levels. Moreover, there are undergraduate child development departments affiliated with faculties of health sciences, health colleges, schools of health sciences, open education, and open and distant education faculties in our country (Doğan-Keskin & Bayhan, 2020). The Child Development Department conducts studies on the health and education of children (Doğan-Keskin & Bayhan, 2020). The department of child development (high school, associate degree, and undergraduate) is one of the departments in which young people have a great deal of interest. Individuals who graduated from the relevant department can find employment in various private and public institutions, including hospitals, social service organizations, and educational institutions. Graduates of the department can find employment in private day nurseries, kindergartens, nurseries, playschools, hospitals, and day-care centers. Additionally, graduates from undergraduate programs who complete initial teacher training are eligible to work as teachers in public or private institutions. Those who graduate from this department and wish to work in government institutions must pass the Public Personnel Selection Examination (KPSS) with a sufficient score. Every year, thousands of students graduate from this department. Therefore, it has become an important issue to determine the future thoughts and plans of the individuals who have graduated from the department. As a result of the review of the relevant literature, no study investigating the future expectations of child development department graduates in our country was detected. Accordingly, we believe this study will fill this gap in the literature. Moreover, we believe that the findings of this study will contribute to the relevant literature.

The present study investigates the future plans and expectations of individuals who graduated from the department of child development at the universities. In line with this objective, the answer to the following question was sought:

What are the future expectations of individuals who graduate from the child development department?

## **Method**

### **Research Design**

This study aims to shed light on the feelings, thoughts, understanding, and expectations of individuals who graduated from the department of child development. Moreover, this study aims to investigate the perspectives held on the concept of "future expectations" by individuals who have graduated from the department of child development. To achieve this objective, a qualitative research method was utilized in this study. In qualitative research, perceptions and events are presented in a natural setting realistically and holistically (Yıldırım & Şimşek, 2018). This form of research incorporates certain philosophical orientations and approaches (Merriam, 2013). Qualitative researchers collect data through document analysis, behavior observations, and participant interviews (Creswell, 2013). In accordance with the qualitative research methodology, in-depth interviews with the participants were conducted for this study.

### **Participants**

This study, which aims to identify the future expectations of the participants, was carried out with individuals preparing for the Public Personnel Selection Examination (KPSS) in a private teaching institution in the Eastern Anatolia Region of Turkey. The participants were selected using criterion sampling, one of the methods of purposive sampling. Conditions that meet a number of predetermined criteria by the researcher are addressed using the criterion sampling method (Yıldırım & Şimşek, 2018). Since this research aims to identify the future expectations of child development graduates, the primary criterion for selecting participants is that they must have graduated from the department of child development and be preparing for the Public Personnel Selection Exam. The research was conducted with a total of 14 graduates of child development, consisting of 13 females and one male. The ages of the participants ranged from 23 to 34, with a mean age of 27,3. During this process, five of the participants (K2, K4, K5, K10, K11) are working at a private institution, while nine (K1, K3, K6, K7, K8, K9, K12, K13, K14) of them are unemployed. The primary objective of all participants is to take the KPSS exam and be appointed to government staff. Twelve of the participants live with their parents, while the other two live alone. One of the participants is married (P13) and the others are single.

### **Data Collection Tool, Data Collection and Ethic**

The data was gathered using the interviewing method in line with qualitative research designs (Merriam, 2013). Interviews provide a direct source for quoting the thoughts, feelings, and experiences of the participants being interviewed. (Patton, 2014). In this regard, the research employed a semi-structured interview form. During the process of preparing the questions that will be included in the interview form, the previous studies investigating the future expectations of individuals were reviewed in order to serve the purpose of the research, (Booth, et al., 2020; Daigle & Hoffman, 2018; Davras & Alili, 2019; Ilgar & Cihan, 2019; İflazoğlu, et al., 2021; Michael, 2019) and a total of twelve open-ended questions were generated. Expert opinion was taken to determine the suitability of the prepared questions for the intended purpose. In light of the feedback from the experts, some questions were eliminated from the form, and some were reintroduced with revisions. Consequently, an eight-question semi-structured interview form was developed. Before conducting the interview, a pilot application was carried out with two pre-service teachers preparing for the KPSS to assess whether the questions were intelligible; it was concluded that they were understandable. The participants were informed of the purpose of the research, how the data would be used, the study's ethical guidelines, and its commitment to confidentiality before the interview commenced. The participants' consent was taken for the interview, and they were informed that they could terminate the interview at any moment and that the data collected would be used solely for scientific purposes. In addition, participants were coded as Participant-1 (P1), Participant-2 (P2), and so on to ensure their confidentiality.

## Data Analysis

The gathered data was analyzed using descriptive and content analysis. During the interviews, the participants' responses were initially transmitted to a computer environment, and then the data entered into the computer was revised. Using the obtained data, codes were generated. Then, the related codes were identified and grouped according to particular themes. In the data analysis, two independent researchers concurrently developed a code list, and the codes were then compared. The points of disagreement between the two independent researchers were discussed, and subsequently, a consensus was reached. The Miles and Huberman (1994) reliability calculation formula was employed to establish the reliability of the coding. As a result of the calculation, the reliability between coders was determined to be 91.5%.

## Validity and Reliability

In order to ensure the validity and reliability of the study, certain measures were taken. In qualitative research, various methods are used to improve validity and reliability (Merriam, 2013). Some of the findings gathered through data analysis were shared with a group of participants, and their accuracy was confirmed. Data were collected from fourteen participants. The researcher collected data from various participants, and when it was observed that the data fell into repetition after fourteen participants, it was determined that the saturation point for the data had been achieved, and the data collection process was terminated. The semi-structured interview form utilized in the interviews with the participants was submitted for expert review. During the data analysis phase of the study, a second independent researcher was utilized, and discussions were conducted with this researcher. The data obtained in the study are described in detail. Additionally, some participants' views were directly quoted.

## Results

The findings of this study, which explores the future expectations of child development graduates, are presented under themes developed based on the participant's responses to the survey questions.

### Examining the Opinions of Child Development Graduates Regarding Reasons for Choice of the Department of Child Development

Table 1 presents the themes and codes derived from the responses of graduates of the department of child development regarding their reasons for choice of the department they study.

Table 1. Opinions of child development graduates on the department they study

Theme	Code	f
Reasons for choosing the department	Affection towards children	3
	Interest in children/department	2
	Ease of assignment/finding a job	2
	Having studied the department during the previous educational period	2
	Having effective communication with children	1
	Popularity	1
	To be a better parent	1
	Not my choice	1

When Table 1 is examined, it becomes clear that the participants' reasons for choosing the child development department were varied. Three participants stated that they chose this department due to their affection for children, the pleasure of spending time with children, and the positive feelings associated with spending time with them. In this context, P6 stated, *"I study in this department because I enjoy caring for children, teaching them, and spending time with them. Caring for them is like therapy for me. Yes, I adore children and enjoy what I do for a living—looking after children at work is like therapy for me."* On the other hand, P14 stated, *"I studied the department of child development with passion and affection. I love children very much. I really enjoy spending time with them. Honestly, I chose this department in order to start a nursery and spend time with the children in the future."*

Two participants indicated that they chose this department due to their interest in child development. For example, while P8 stated, *"I purposefully chose this department because I was interested in children's development.* P9 stated, *"I chose this department since I was interested in it and believed it to be a familiar field for me."*

Two of the participants stated that they chose this department because they believed its graduates could easily obtain employment or be assigned. In this context, P3 explained her preference for the department in question as follows: *"I chose this department since it is a department that offers good opportunities and provides ease of assignment and finding a job."* On the other hand, P4 stated, *"The year I decided which university to attend, I was drawn to the department of child development because it offered successful assignment rates. The fact that the assignment status is not favorable at this time has given me some regret."*

Two participants stated they chose this department since it was the department they studied in throughout high school. The opinions of those who formed these codes, P7 and P4, are as follows: *"I studied this department in high school and realized I would enjoy working in this sector."*, *"I chose the child development department voluntarily." Since I studied the department of child development in a vocational high school, I already had some background knowledge on that subject. Since I am quite fond of children, I felt this department was a good fit for me."*

One participant (P8) reported that she communicated well with children and stated, *"My interaction with children is also quite successful, and I can communicate with adults, mainly parents, very effortlessly."* One of the participants (P1) stated that she chose this department because it was popular and stated the following: *"When I chose the department of child development, it was a department in great demand. Considering that everyone eventually starts a family, it only seems sense that everyone should be knowledgeable about child development. It should be expected of all adults in our society to have some familiarity with child development, but in reality, this topic is given considerably less importance than it deserves in our country. I hope this perception will change and the department of child development will be given more attention."* One of the participants (P5) stated that she chose this department to educate her daughter better and be more helpful to her. She also shared the following opinions: *"I have a daughter. I decided to study in this department to benefit my daughter's education and upbringing."* In addition, one participant (P2) pointed out that she did not choose this department on her own, but that her teachers did, and she voiced the following opinion: *"To be honest, I desired to study in a different department, but my score was not sufficient to get in. So, I let my professors decide for me. My teachers thought this department was a good fit for me."*

### Examining Child Development Graduates' Opinions About Future Concerns

Table 2 displays the themes and codes derived from the opinions of child development department graduates about their future concerns.

Table 2. Child development graduates' opinions about future concerns

Theme	Code	f
Concern about future	Failure to have a job/failure to be assigned	6
	Failure to give a suitable upbringing for a child	2
	Reliance on the private sector	1
	The gradual diminution of the department's advantages	1
	Uncertainty	1
	Inhumane living conditions	1

Examining Table 2 reveals that the participants have different concerns about their future lives. Six participants were concerned that they would be unable to find employment or be appointed in the future. Regarding this topic, P7 stated, *"Concern for the future, the thought of what I would do if I am not appointed."* On the same topic, P8 stated, *"I am quite concerned about the current state of affairs. Unfortunately, I have anxiety over not finding employment."*

Two participants stated that when they have their children, they fear being unable to raise them properly, provide them with a good education, or teach their children the values they were taught. In this regard, P2 stated, *"When it comes to my children, I worry that I won't be able to put into practice my professional experience, practice, and learning outcomes."* while P8 stated *"Once we become parents, I am concerned about the quality of education and upbringing we will be able to provide our children."*

One of the participants (P2) stated that he feared not being appointed to the government in the future and becoming reliant on the private sector, expressing his opinion as *"I worry about always being dependant on the private sector."* One of the participants (P4) expressed concern that the child development department's advantages might gradually diminish, expressing her opinion as follows: *"Currently, this department's graduates can easily find employment. This is a benefit, but I'm concerned that it come to an end."* One of the participants (P5) stated that she feared that her future was uncertain, adding, *"I worry that my future is uncertain and that I will not have a clear path."* Lastly, one of the participants (P1) stated that she feared she would not be able to live a humane life in the future, saying, *"I have mainly anxieties about not being able to live a humane life."*

### Examining the Opinions of Child Development Graduates on the Social Environment/Life They Desire in the Future

Table 3 presents the themes and codes derived from the opinions of child development department graduates regarding the social environment/life they desire in the future.

Table 3. The opinions of child development graduates on the social environment/life they desire in the future

Theme	Code	f
The social environment/life they desire in the future	Simple/normal/ordinary life	3
	An environment where I can put my plans into action	1
	Application area of specialization	1
	A better environment than today	1
	An environment where I can help others	1
	In the midst of nature, far from technology	1
	Being well-known in one's profession	1
	A fair life	1
	An environment with a high social status	1
	An environment where I can educate children	1

Examining Table 3 reveals that the participants have different expectations regarding their future social lives and environments. Three of the participants expressed a desire to live in a social environment that is simpler, normal, and more ordinary in the future. In this regard, P1 stated, *"I desire a life of simplicity. I want simple and ordinary individuals to be around me. To be more precise, I would like to go back to my village. I care about the village's environment and strong bonds of friendship and affection. This is what everyone desires eventually and the best social circle is where you belong. I hope to find this, however, it does not seem likely."* P1 desired to be in a simple group environment in the future, although it appears she had concerns. Within the scope of this code, P3 states, *"The future environment I desire is a simple, minimal life with real people, as far away as possible from unneeded, complex, and harmful individuals. I desire self-actualization in that life."*

One of the participants (P2) desired an environment where she could put her plans into practice and said: *"I want a fulfilling social life that allows me to fully realize my objectives. Specifically, a social environment where I can implement my plans would be ideal."* K4 echoed this view, expressing a need for a more private environment in which to apply her field-specific knowledge and expressed her opinion as follows: *"In the future, I would like to be in a place where I can put into practice what I have learned about this department and where I can fully practice my child development expertise."* One of the participants (P6) stated that she would like to live in a more social environment in the future and said, *"I mean, it can be better than what I have now. In other words, we want the life to which we are entitled—a normal and humane life."* One of the participants (P7) mentioned that she desired to live in an environment where she could help others and said, *"I want to have a social life where I can help myself and others, where I can reach out to as many people as possible and provide a little joy to their day and a smile to their face."* Within the scope of this theme, one participant (P8) stated that she wanted to live in an environment far from technology and in the midst of nature, adding *"I desire an environment where children may grow up without the influence of mobile phones, tablets, computers, and the internet. I want children to have an environment where they can play games and learn to love animals and nature. I would like to be in a peaceful family environment."* One of the participants (P9) indicated that she desired to be a well-known figure in her are of profession and stated, *"I want to be very successful and well-known figure in my field. I want to be known for my work."* Meanwhile, one participant(P11) desired a fair life by adding, *"A fairer life where I can live in peace with people."*, one (P13) desired to live in an environment with high social status by adding, *"I want to be part of a more educated environment with a vision that goes*

beyond a diploma.”, one (P14)desired an environment suitable for raising children by adding, *“My first social plan for my future job is to spend time with children in the nursery.”*

### Examining Child Development Graduates' Opinions on Their Future Career and Professional Advancement

Table 4 presents the themes and codes derived from the opinions of child development department graduates regarding their future careers and professional advancement.

Table 4. Child development graduates' opinions on their future career and professional advancement

Theme	Code	f
Career and career advancement	Being appointed	7
	Studying for master degree	2
	Starting a business related to the field	2
	Despair	1
	Writing a book	1
	Working as a manager in a children's institution	1

Examining Table 4 reveals that child development graduates have different plans for their future careers and professional advancement. Within the scope of this theme, seven participants stated appointment as their primary objective in their related field. In this regard, P6 stated, *“My biggest dream is to be appointed..”* and P7 stated *“I desire to get appointed and serve as a source of hope for my students and their families by participating in training in my profession”*, P8 stated, *“As a career objective, I wish to be appointed in the field of child development and to offer assistance to those who study and reside in institutions related to child development.”* and P14 stated, *“My primary goal is to be appointed....”*

Two participants stated that they desired to study for a master's degree in their field, and P4 added, *“In the future, I plan to pursue a master's degree in my department. I wish to become more knowledgeable and become a specialist in the field of child development.”* On the same subject, P14 stated *“After getting appointed, completing a master's degree in this department is one of my top priorities.”*

Within the scope of this topic, two participants expressed their intent to start a business in their relative fields. In this regard P6 stated *“I plan to establish a new kindergarten that will be educationally and structurally different from the existing kindergartens.”* while P14 stated *“I want to start an institutional nursery.”*

In keeping with this theme, one participant (P3) expressed having a desire for career and professional advancement in the future but that she lacked confidence that this would materialize, stating: *“I have career plans in the future, but I don't know how, or when they will take place. In truth, I do not see a bright future for myself.”* On the same subject, one participant stated, *“I intend to become an expert in my field and write a book.”*, another participant (P11) wanted to be a manager in a children's institution, stating, *“I want to be a manager in an institution for children, such as a kindergarten, nursery, or care house.”*

### Examining Child Development Graduates' Opinions on Their Future Financial Situation

Table 5 presents the themes and codes derived from the opinions of child development department graduates regarding their financial situation in the future.

Table 5. Child development graduates' opinions on their financial situation in the future

Theme	Code	f
Financial future	Low expectation	7
	High expectation	2
	Concerned	1

Examining Table 5 reveals that individuals who graduated from the department of child development have varying opinions regarding their financial situation in the future. Seven of the participants seem to have low expectations for their financial situation in the future. In this regard, P1 stated *“There's a good chance I won't do well financially. It has nothing to do with me; it's just how the system works. There is nothing to do. We have to get used to this situation.”*, P4 stated, *“I desire to be wealthy, but I have little faith that it will come true given*



the current circumstances.”, and P6 stated, “If things keep going the way they are, I don't think things are going to end well for us financially. I can not even buy gummy bears anymore!”

Two of the participants have high expectations about the financial situation in the future. As part of this code, P11 stated, “I have high hopes that my financial situation will improve in the future” while P14 stated, “Things will not always play out this way. That's what I think. I believe I will be in a much better position financially.”

In addition, one of the participants (P2) expressed concern for the future financial situation if the current conditions persisted, stating, “In addition, one of the participants (P2) expressed concern for the future financial situation if the current conditions persisted, stating, “I am concerned that if things keep going the way they are, my future financial situation would not be good. I fear I will be unable to stop living off my father's money with the way things are.”

### Examining the Opinions of Child Development Graduates Regarding Future Employment/Appointment

Table 6 presents the themes and codes derived from the opinions of child development department graduates regarding their status of future assignment and finding employment.

Table 6. Opinions of child development graduates regarding future employment/appointment

Theme	Code	f
Appointment/employment	Alternative plans	5
	Hopeful	4
	Despair	2

Examining Table 6 reveals that the individuals who graduated from the department of child development had differing opinions on getting appointed and finding employment. As can be seen, five of the participants came up with alternative solutions for finding employment and getting appointed. Accordingly, these participants want to be appointed to state institutions, but if this does not work out, they will seek employment in private organizations that are related to their fields. In this context, P4 stated “I am thinking of trying for another year or two to be appointed. If I am not appointed to state institutions, I will continue to work for private ones.”, while P8 stated “Even though working in the private sector is very challenging, it is a good alternative when there isn't an opening in the government. We are lucky in this regard, because we can also work in the private sector”. On the same subject, P14 stated the following: “If I am not appointed, I plan to work at a rehabilitation center or a kindergarten in the future.”

On the other hand, it was determined that four of the participants were optimistic about finding employment and getting appointed within the scope of this theme. On this matter, P3 stated, “I will get appointed, have a good job, and be a respected woman in my profession.”, P7 stated, “In the future, I will be appointed as a teacher and rejoined with my students and career.” and P10 stated, “I consider my chance of appointment to be high.”

Two of the participants expressed pessimism regarding their chances of getting appointed or finding employment. In this regard, P1 stated “I have no hope of getting appointed and finding an employment, as the department I am studying is not given the importance it deserves. This being the case, it is difficult to be optimistic about getting appointed. That's why it's hard to find a job.” On the same subject, P12 stated, “It used to be a department with a high rate of appointment, but now it has become difficult to find a job for those who graduated from this department.”

### Examining the Opinions of Child Development Graduates on Their Future Private and Family Lives

Table 7 presents the themes and codes derived from the opinions of child development department graduates regarding their future private and family lives.

Table 7. Opinions of child development graduates on their future private and family lives

Theme	Code	f
Private life/family life	A happy family life	5
	Traveling / Vacation	2
	Not getting married	2
	Getting married and having children	1

Examining Table 7 reveals that the graduates of the department of child development have varying opinions on their future private and family lives. Within the scope of this topic, five respondents expressed a desire to have a happy and peaceful family in the future. Accordingly, P1 stated *“As a child developer, I want a happy life with my spouse and children. I would like to move my family to the village and live there.”* Meanwhile, P6 stated *“I desire to live a peaceful, modest life with my family. I envision a future in which we can spend every moment together, unwind, and enjoy life side by side.”* and P7 stated *“I desire a more peaceful life with my family. I intend to be a caring mother to my spouse and children.”*

Two individuals (P6, P8) expressed a desire to travel and see new places in the future, as well as to explore new destinations. In this regard, P3 stated *“Once appointed, I will travel regularly. I have certain plans and places to travel in mind. I have to go and see them.”* while P5 stated *“I wish to explore and travel many places. I want to see places that I do not know and have not been to before.”*

It is seen that two of the participants (P3, P5) do not intend to marry, however one participant (P14) wants to marry and start a family. In this regard, P3 stated *“I do not intend to get married in the future.”*, P5 stated *“If I earn enough money, I will never marry. Though I will not get married even if I don't earn enough.”* and P14 stated *“My primary future objective is to be appointed. Then I want to get married and have at least two children since I am so passionate about this field. I want to be a mother and experience this feeling.”*

### Examining Child Development Graduates' Opinions on Their Desire to Study in a New Department in the Future

Table 8 presents the themes and codes derived from the opinions of child development department graduates regarding their desire to study in a new department in the future.

Table 8. Child development graduates' opinions on their desire to study in a new department in the future

Theme	Code	f
Studying in a new department in the future	Special education	2
	Faculty of law	1
	Speech and language therapist	1
	Classroom teaching	1
	Art teaching	1
	Journalism	1
	Psychology	1

Examining Table 8 reveals that graduates of the department of child development are interested in studying departments unrelated to their fields in the future. Two participants (P7, P12) reported interest in special education, one (P3) in law school, one (P5) in speech and language therapy, one (P9) in classroom teaching, one (P10) in art teaching, one (P11) in journalism, and one (P14) in psychology. In this regard, P7 stated *“In the future, I wish to study special education and become more competent in this field.”*, P12 stated, *“I will study in the special education department.”*, P3 stated, *“I want to study in the faculty of law in the future. I believe that I should study in this department because it is my dream job.”*, P5 stated, *“I would like to be a speech and language therapist in the future. Since I feel like I'm lacking in this area, I'd like to get some training and improve myself in this field.”*, P9 stated *“After getting my life in order, I intend to study in the department of classroom teaching.”*, P10 stated, *“I want to study in the art teaching department. I was studying in this field, but I had to drop out due to personal reasons. Mine was an unfulfilled dream.”*, P11 stated, *“I'm planning to study journalism. It's a dream that will take a long time to realize, but it will.”*, lastly, P14 stated, *“I will take the university exam again and this time I am planning to study psychology.”*

### Discussion and Conclusion

This study was conducted to identify the future expectations of individuals who graduated from the department of child development. Fourteen (14) graduates of a child development program in a province in eastern Turkey participated in this study. These students were receiving education in a teaching institution that provides preparation courses for KPSS. The study revealed the participants' reasons for choosing the department they are currently enrolled in, their concerns about their future lives, the social environment they want to be part of, the social life they desire to lead, their goals for their professional advancement and career steps, and financial situations they envision for themselves, their plans for getting appointed and finding employment, the family

structures they hope to have in the future/their private lives, and their opinions on the departments they wish to study in the future. It has been determined that the participant's choice of the child development department was influenced by various factors, including their affection for children, being more interested in children, a sense of familiarity with the department, the high potential of getting appointed and finding employment upon graduation, having completed their high school education on the same subject, having a good level of communication with children, the department's popularity among young people in our country, and their desire to raise their children more effectively with the help of the education they received. In addition, it was found that one of the participants did not choose this department on his own. On this basis, it was determined that individuals who graduated from the Department of Child Development chose this department for various reasons.

In the study conducted by Tezcan (2018) with university students, it was determined that the participants had different tendencies when it came to their career decisions, being principled, unplanned, and passive. Previously, we mentioned that one of the participants (P2) did not choose this department voluntarily; this was not the department he desired to study. However, his score on the university entrance exam did not qualify him for the department he wanted to study, and he chose this department with the guidance of his teachers. It has been observed that young people's expectations for the future decrease if they do not make career decisions based on their own preferences (Tezcan, 2018). Upon examination of this participant's (P2) responses to additional interview questions, it was determined that she exhibited future-related fears and concerns. This conclusion is comparable to the scenario described by Tezcan (2018).

As a result of examining the opinions of the participants, it was determined that they had differing views regarding the future social environment or social life they desire. It was observed that participants' ideas on the subject were as follows: an environment where they can put their plans into action, where they can use their expertise in the field of child development, a better environment than their current one, an environment where they can help people, close to nature and away from technology, an environment that provides a fair life, one with good social standing, and one in which children can be educated. After graduation, young people in our country may not easily find employment and get appointed. Long-term preparation for KPSS may be required to get appointed to the state staff. They can be subjected to more criticism from those around them as the exam preparation process prolongs. In order to avoid these negative criticisms, many individuals choose to pursue simpler and easier options. One of the findings of Ilgar and Cihan's (2019) study with students in the department of sports management suggests that the participants are displeased with their social environment and believe that their problems stem from there. Moreover, Aytar and Soylu's (2019) study with students in the business administration department revealed that families are the primary contributors to the problems and stress faced by young people today.

It has been determined that the opinions of child development department graduates on professional advancement and careers are predominantly to be appointed to government positions. In addition, it has been found that they have aspirations such as taking a master's degree, opening a business related to their profession (nursery, kindergarten, and so on), authoring a book, and working as management at a children's institution. In addition, it was determined that one participant lacked optimism for professional advancement and career development. Due to the increase in university graduates in our country, their professional and economic problems begin while they are still in school and only once they leave school and start the job hunt (Musayev & Akcan, 2022). Similarly, Çay and Akpınar (2022) concluded in their study that the employment opportunities and future expectations of people studying in the social services department significantly impacted feelings of despair. One other finding of the present study is that the participants are concerned about the future. It is observed that participants had varying concerns, such as the inability to be appointed to any state institution, failure to raise good children, dependency on the private sector, the gradual decrease in the advantages of the child development department, concern about what the future holds, and anxiety about living inhumanely. Young adults appointed to state institutions believe they have a more secure economic future. It is believed that young individuals whose financial status is poor or who suffer financial crises have negative future expectations. The study by Iovu, Hărăguș, and Roth (2018) conducted with young people in Romania revealed that girls who do not experience economic difficulties, have a positive self-perception, exhibit less depressive symptoms, and have a high degree of optimism had higher life expectancies than their peers.

In order to have a secure financial future, a large number of people begin a demanding work/study schedule at a young age. That is, individuals try to build their futures with the income they earn at a young age. The present study concluded that the majority of the participants in our study were pessimistic about their future financial status. It was observed that the participants showed low levels of expectations about their future economic situation, and one participant expressed concern over this matter. Failure to find a job and get appointed to state

institutions impacts the anxiety level of young people. In fact, unemployment and anxiety appear to have a negative impact on life satisfaction (Turaç & Bayın Donar, 2018). In addition, the study by Sevim and Altun (2017) found that participants had a high level of concern about their professional future. The present study revealed that some of the participants whose opinions were consulted in our study had various alternatives in terms of appointment or employment. The participants' primary objective is to be appointed to state institutions with KPSS scores. In the event that this does not occur, they will seek employment in a private children's institution. Young people getting appointed or finding employment affects their future economic situation. On this matter, it was observed that some participants had high expectations, while some had low expectations. We believe that an increase in the number of individuals studying or graduating from any university department has a negative impact on the future expectations of those who study or graduate from that department. For instance, the rapid increase in the number of graduates from the department of social services, the limited number of appointments carried out through KPSS, and the decrease in employment opportunities have intensified the level of concern and despair of students studying in this department (Cebeci et al., 2020). It was observed that one of our participants, P2, supported this view, stating *"It used to be a department with a high rate of appointment but now it has become difficult to find a job in this department."* As stated previously, the primary objective of the participants is to pass the KPSS and get employment in government institutions. Tezcan's (2018) study reached a similar conclusion and reported that the participants desire a future that is away from uncertainty and intends to work in the government as much as possible. Although some of the participants in our study are currently working in the private sector, it was observed that they were preparing for the exam in a private teaching institution that provides preparatory training for KPSS to be appointed to state institutions. Additionally, Türköz et al. (2021) concluded in their study that individuals place value on continuing their education and personal development to reduce their future anxiety. Within the scope of this theme, it was observed that some participants had optimistic views for the future and looked forward with hope. In their study with Spanish and Portuguese adolescents, Verdugo, Freire, and Sánchez-Sandoval (2018) concluded that the participants' future expectations were optimistic despite the current financial state. Moreover, Stoddard and Pierce (2015) reported in their study that greater hope and purpose generate a more optimistic view of the future.

Moreover, it was found that the participants had opinions regarding their private and familial life in the future. In this regard, it was determined that some participants desired a happy and peaceful family life, some desired to go to the places they wanted to see, others desired to remain single without marrying, and some desired to marry and start a family. In addition, it was determined that the participants desired to study new departments in the future, including special education, law, language and speech therapy, classroom teaching, art teaching, journalism, and psychology, and that they wanted to improve themselves in these fields.

## **Recommendations**

This study investigated the future expectations of individuals who graduated from the child development department. At the conclusion of this study, it was determined that these individuals have different future viewpoints. It has been observed that the participants had different viewpoints on the social life they envision for themselves in the future, their future financial situation, starting a family, getting appointed, finding a job, and working for the government or private institutions. The present study explored the future expectations of the participants. Future studies can be conducted to examine the future anxiety and optimism levels of individuals who have graduated from the department of child development. The study by Sevim and Altun (2017) conducted with the students of the social services department revealed that the increase in the number of departments and the number of students caused the students to be concerned about their future careers. The department of child development is a popular department among young people in Turkey. Precautions can be taken to ensure that young people studying in this department do not experience concerns about their future professions. The present study determined that some of the individuals who graduated from this department have negative expectations for the future. Researchers can conduct experimental studies that increase the future expectations of individuals who study or graduate from this department.

## **Scientific Ethics Declaration**

The authors declare that the scientific ethical and legal responsibility of this article published in EPESS journal belongs to the authors.

## Acknowledgements

\* This article was presented as an oral presentation at the International Conference on Science and Education ([www.iconse.net](http://www.iconse.net)) held in Antalya/Turkey on November 15-18, 2022

## References

- Akbaşı, S., Kubilay, S., & Durnali, M. (2017), Investigation on the future expectations of students attending associate degree programs, *Journal of Human Sciences*, 14(4), 4678-4693.
- Aktaş, E. (2016). *Psychological durability of adolescents and relationship with future expectations*. (Master's thesis), Institute of Education Sciences, Ondokuz Mayıs University, Samsun.
- Alagöz, E. (2018). *The effect of the society demographic characteristics of the students who learned in special professional and technical anatolian high school in Istanbul on the future expectations*. (Master's thesis). Institute of Health Sciences, Marmara Universty, Istanbul.
- Avar, F. (2019). *The relationship between perceived attitudes of parents of high school students on their future expectations and academic success*. (Master's thesis). Institute of Social Sciences, Üsküdar Universty, İstanbul
- Aytar, O., & Soylu, S. (2019). Perceptions on today and future of university students: a research on students of business administration. *Academic Review of Economics and Administrative Sciences*, 12(3), 328-337.
- Baş, N. (2019). *The role of the quality of school life and commitment to school in explaining the future expectations on the middle school students*. (Master's thesis). Institute of Graduate Education, Trabzon University, Trabzon.
- Başkonuş, T., Akdal, D., & Taşdemir, M. (2011). Ahi Evran Üniversitesi eğitim fakültesi son sınıf öğrencilerinin gelecek beklentileri. *2 nd International Conference on New Trends in Education and Their Implications*. (pp. 1512-1521). Antalya-Turkey.
- Booth, P., Walsh, P. J., & Stahlmann-Brown, P. (2020). Drought intensity, future expectations, and the resilience of climate beliefs. *Ecological Economics*, 176, 106735.
- Cebeci, F., Artan, T., & Karaman, M. (2020). Group work towards reducing finding a job anxiety of department of social work interns. *Turkish Studies*, 15(3), 1721-1738.
- Creswell, J. W. (2013). *Nitel araştırma yöntemleri: Beş yaklaşıma göre nitel araştırma deseni* (M. Bütün & S. B. Demir, Çev.). Ankara: Siyasal Yayın Dağıtım.
- Cunningham, M., Corprew, C. S., & Becker, J. E. (2009). Associations of future expectations, negative friends, and academic achievement in high-achieving African American adolescents. *Urban Education*, 44(3), 280-296. doi:10.1177/0042085908318715
- Çay, M., & Akpınar, B. (2022). A research on social work students job finding concerns and hopelessness levels. *Journal of Society & Social Work*, 33(3), 707- 734. <https://doi.org/10.33417/tsh.981945>
- Daigle, L. E., & Hoffman, C. Y. (2018). Violent victimization and future expectations: Results from a longitudinal study of at-risk youth. *Victims & Offenders*, 13(6), 798-813.
- Davras, G. M., & Alili, M. (2019). A research on future expectations of university students who are tourism education. *International Journal of Global Tourism Research*, 3(1), 40-52.
- Doğan-Keskin, A., & Bayhan, N. P. (2020). The past, present, and future of child development. *Journal of Early Childhood Studies*, 4(3), 881-900.
- Ege, A. (2018). *Examining the effects of adolescents's problems and perceived social support on the future expectations: Altındağ Example*. (Doctoral Dissertation). Graduate School of Social Sciences. Hacettepe University.
- İlgar, E. A., & Cihan, B. B. (2019). Examination of sectoral expectations, professional uncertainty and future anxiety of students of sports management programs: A phenomenological analysis. *Journal of Sports Education*, 3(1), 81-92.
- Iovu, M. B., Hărăguş, P. T. & Roth, M. (2018). Constructing future expectations in adolescence: relation to individual characteristics and ecological assets in family and friends. *International Journal of Adolescence and Youth*, 23(1), 1-10.
- Iflazoglu, N., Can, İ. I., Nur, M., & Cevent Nisani, E. (2021). A research on future expectations and perceptions towards the tourism sector of the adolescents' receiving tourism education during the Covid 19 pandemic: The case of Hatay. *Journal of Turkish Tourism Research*, 5(3), 1982-2001. <https://doi.org/10.26677/TR1010.2021.830>
- İleri, M. (2019). *The effect of school of physical education and sport students' academic self competences on their future expectations*. (Master's thesis). Sosyal Bilimler Enstitüsü, Karamanoğlu Mehmetbey University.

- Koçak, O., & Çepni, S. (2017). The evaluation of the expectations of the students towards working life: Yalova University sample. *E-Journal of the Faculty of Economics and Administrative Sciences*, 6(1), 241-265.
- McCabe K., & Barnett D. (2000). First comes work, then comes marriage: Future orientation among African American young adolescents. *Family Relations*, 49(1), 63-70.
- Merriam, S. B. (2013). *Qualitative research: A guide to design and implementation* (S. Turan, Trans.). Ankara: Nobel Akademik Yayıncılık.
- Michael, R. (2019). Self-efficacy and future career expectations of at-risk adolescents: The contribution of a tutoring program. *Journal of Community Psychology*, 47(4), 913-923.
- Miles, M. B., & Huberman, A. M. (1994). *Qualitative data analysis* (2nd ed.). Thousand Oaks, CA: Sage.
- Musayev, İ., & Akcan H. K. (2022). Finding employment anxiety of students enrolled in higher religion education: a case study of Hakkari University Faculty of Theology. *Turkish Journal of Religious Education Studies*, 13, 47-66.
- Nurmi, J. E. (1991). How do adolescents see their future? A review of the development of future orientation and planning. *Developmental Review*, 11, 1- 59.
- Patton, M. Q. (2014). *Qualitative research and evaluation methods* (M. Bütün and S. B. Demir, Trans.). Ankara: Pegem.
- Savcı, H. (2016). *Investigation of relationship between childhood trauma experiences and future expectations of adolescents*. (Master's thesis). Graduate School of Educational Sciences, Atatürk University, Erzurum.
- Schmid, K. L., Phelps, E., & Lerner, R. M. (2011). Constructing positive futures: modeling the relationship between adolescents' hopeful future expectations and intentional self regulation in predicting positive youth development. *Journal of Adolescence*, 34(6), 1127-1135.
- Selek Şahin, Ü. (2021). *The relationship between cognitive distortions related to academic achievement and future expectations of high school students*. (Master's thesis). Department of Educational Sciences, Gaziantep University, Gaziantep.
- Sevim, K. & Altun, F. (2017). Professional and academic expectation for the future of students of social work. *ACU International Journal of Social Sciences*, 3(2), 51-65
- Stoddard, S. A., & Pierce, J. (2015). Promoting positive future expectations during adolescence: the role of assets. *American Journal of Community Psychology*, 56(3-4), 332-341. <https://doi.org/10.1007/s10464-015-9754-7>
- Şimşek, H. (2012). Future expectations of high school students in southeastern Turkey: factors behind future expectations. *Journal of Theoretical Educational Science*, 5(1), 90-109.
- TDK (2022). *Güncel Türkçe sözlük*. Retrieved from <https://sozluk.gov.tr/>
- Tekin, İ. Ç., & Akgemci, T. (2018). A research on the future expectations of the call center services department students: Selçuk University sample. *Journal of Humanities and Social Sciences*, 11, 151-164.
- Tezcan, F. (2018). Career choice and future expectations of university youth: case of faculty of letters of Akdeniz University. *International Journal of Society Researches*, 8(1), 27-57
- Topaktaş, B. (2015). *Adölesanlarda algılanan sosyal desteğin gelecek beklentisi ve ruhsal belirti düzeyleri ile ilişkisi*. (Uzmanlık Tezi). Tıp Fakültesi, Ondokuz Mayıs University, Samsun.
- Topoğlu, O., & Topoğlu, E. E. (2018). Investigating the reasons for university choice of faculty of education music education department students (sample of Aegean Region). *Electronic Turkish Studies*, 13(27).
- Tuncer, M. (2011). Adaptation of adolescent future expectations scale. *International Periodical for The Languages, Literature and History of Turkish or Turkic*, 6(3), 1265-1275.
- Turaç, İ. S., & Bayın Donar, G. (2018). Determination the factors affecting unemployment worries and life satisfaction of health management students, *Research Journal of Politics, Economics and Management*, 1(5), 119-127.
- Türkön, H. (2019). *The relationship between attachment styles and future expectations and self-level of control in adolescents (14-18) case of Kayseri*. (Master's thesis). Department of Psychology, Çağ University, Mersin.
- Türköz, O., Bektaş, M., & Çiçek, H. (2021). Future anxiety in graduate education individuals. *Journal of Bucak Business Administration Faculty*, 4(2), 132-152.
- Üzüm B. & Uçkun S. (2015). Office management and executive assistant students; demographic characteristics and measurement of career future expectations: Kocaeli vocational sample. *Elektronik Mesleki Gelişim ve Araştırmalar Dergisi*, 3(1), 71-80.
- Verdugo, L., Freire, T., & Sánchez Sandoval, Y. (2018). Understanding the connections between self perceptions and future expectations: A study with Spanish and Portuguese early adolescents. *Revista de Psicodidáctica*, 23, 39-47.
- Yavuzer H., Demir, İ., Meşeci, F., & Sertelin Ç. (2005). Günümüz gençliğinin gelecek beklentileri. *Hasan Ali Yücel Eğitim Fakültesi Dergisi*, 2, 93-103
- Yıldırım, A. & Şimşek, H. (2018). *Sosyal bilimlerde nitel araştırma yöntemleri* (11th Ed.). Ankara: Seçkin Yayıncılık.

---

### **Author Information**

---

**İbrahim Benek**

Ministry of Education

Turkey

Contact e-mail: *ibrahimbenek11@gmail.com*

---

#### **To cite this article:**

Benek, I. (2022). The investigation of future expectations of individuals graduated from the department of child development. *The Eurasia Proceedings of Educational & Social Sciences (EPESS)*, 28, 69-82.

The Eurasia Proceedings of Educational & Social Sciences (EPESS), 2022

Volume 28, Pages 83-91

**IconSE 2022: International Conference on Science and Education**

## An Overview Analysis of Debt Financing for Hungarian Enterprises and the Impact of Economic Crises

Agnes CSISZARIK-KOCSIR  
 Óbuda University

**Abstract:** There are two main ways of financing businesses, equity and debt. Debt financing, including debt financing, is vital for many economic operators and is thus a key to their survival. Businesses can obtain the funds they need quickly and easily from the financial markets, mainly in the form of credit products. However, excessive indebtedness carries a number of risks in the short, medium and long term. For all economic entities, it is crucial to determine their optimal level of indebtedness and their level of credit. The debt financing of companies and businesses is heavily influenced by macroeconomic developments. In all cases, the changes brought about by the crisis, global economic anomalies, rising interest rates and inflation have a negative impact on the exposure of businesses to credit providers. This is particularly true for Hungarian businesses. The prevalence of foreign currency lending before the 2008 downturn and the difficulties that followed the crisis have led many small and medium-sized enterprises and large companies to bankruptcy or to the brink of closure. This crisis has been a very big learning lesson for all economic actors, including the corporate and entrepreneurial sector. Despite the fact that lending standards and conditions have tightened considerably in recent years, there are still many risks associated with debt financing, especially when it is used for operations rather than investment. The aim of this paper is to illustrate the changes in corporate lending from the 2008 crisis and the coronavirus crisis to the present day, using the example of the Hungarian business sector. The study will also shed light on the changes in lending and the change in the attitudes of firms, which will provide a measure of the level of corporate financial culture and its manifestation in financial decisions.

**Keywords:** Credit financing, SME, Hungary

### Introduction

Small and medium-sized enterprises dominate among operating enterprises in all countries, including Hungary. According to the generally accepted definition, the SME sector is defined along the following thresholds:

Table 1. Size categories of SMEs

	Number of employees (in annual workforce units):	Annual turnover	Annual balance sheet total
Micro enterprise	< 10	≤ 2 million EUR	≤ 2 million EUR
Small enterprise	< 50	≤ 10 million EUR	≤ 10 million EUR
Medium enterprise	< 250	≤ 50 million EUR	≤ 43 million EUR

Source: European Commission, 2020

Despite the fact that the SME sector lags behind large enterprises in terms of both productivity and competitiveness, it still employs the majority of workers and accounts for the vast majority of enterprises in operation (99.9%), as illustrated in the figure below. A common criticism of the sector is that it makes little investment because it lacks resources. The number of active enterprises is strongly influenced by the macroeconomic environment, the operating conditions it provides and the general state of the business cycle.

- This is an Open Access article distributed under the terms of the Creative Commons Attribution-Noncommercial 4.0 Unported License, permitting all non-commercial use, distribution, and reproduction in any medium, provided the original work is properly cited.

- Selection and peer-review under responsibility of the Organizing Committee of the Conference



The number of SMEs operating in Hungary has grown in line with the growth of the economy since the recession following the 2008 crisis, and according to the 2020 statistics. While in 2014 there were only 652,000 SMEs (based on available data), by 2020 this number will have increased by almost a third to more than 891,000. This illustrates their dominant role in the Hungarian economy, and also the anomalies related to their financing.

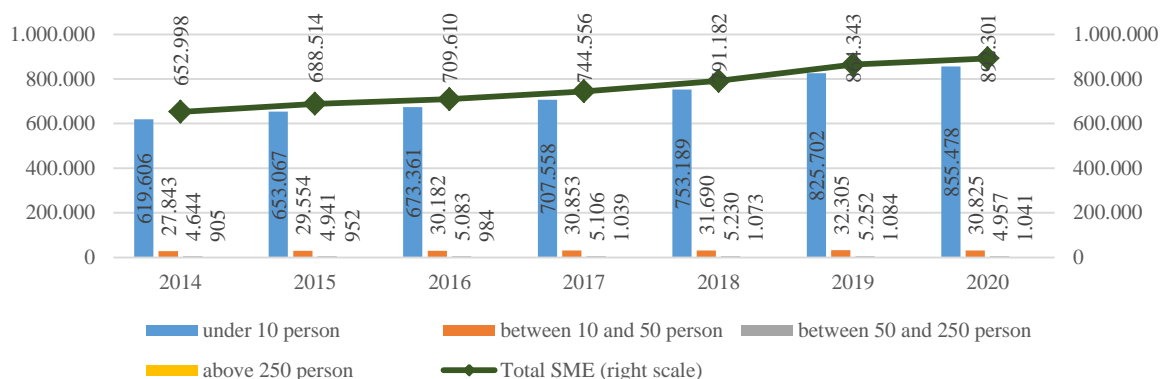

Source: Hungarian central statistical office, 2022

Figure 1. Number of Hungarian small and medium-sized enterprises

## Systematic Literature Review

The financing of enterprises is discussed in textbooks and literature from two perspectives. On the one hand, a distinction is made between internal sources, i.e. sources from the operation and existence of the enterprise, and external sources, i.e. sources from outside the enterprise, from the money and capital markets. On the other hand, we also talk about short-term sources, i.e. within the year, and long-term sources (beyond the year). How these sources fit into the operation of a company and how to find the right balance between them has long been of interest to those working in the field. One thing is certain, however: there is no declarable ratio for any pair of resources that can be clearly applied to all businesses in a given sector and size category. There is a different need and mix of resources for smaller enterprises, which do not want to grow or do not want to grow because of funding anomalies, and a different mix of resources for older enterprises, which are able to access different types of resources because of their professional experience and entrepreneurial networks (Cabra-Mata, 2003). Credit plays a key role in financing, particularly in terms of boosting and reviving the economy. Beck (2012) lists the ways in which lending can affect economic growth: it can boost entrepreneurship and the size of existing firms, increase exports and hence the revenues from them, and improve the effectiveness of economic policy instruments. Although there are already some trends that emphasise the possibility of a creditless recovery (Abiad et al, 2011), this is inconceivable in the current financing situation in Eastern Europe and is already refuted by Biggs, Mayer and Pick in 2009. The prominent role of credit in corporate finance received particular attention in the years after the regime change, when foreign-owned banks started to appear in the 1990s, not only in Hungary but also in the region. In addition to their liquidity, the foreign subsidiaries brought with them their practices and methods, which unfortunately in the Eastern European region were not combined with the kind of host-side knowledge that would have enabled them to manage loans in the appropriate place in the financing structure. In many cases, this has been due to over-indebtedness and irresponsible borrowing, which was fundamentally rewritten by the Lehman bankruptcy of 2008 (Banai, 2016). This is why it is important to focus on economic sustainability (Zéman et al. 2016).

Based on banking practice, corporate lending is the segment most able to respond quickly to economic crises. Crises are an inevitable feature of modern economies and we are forced to adapt and prepare for them. The causes of the 2008 crisis have been the subject of numerous articles and studies. Some blame the demand side (households, firms, governments), some blame the supply side (banks, financial institutions), and some blame regulators (supervisors, central banks) for the escalation of the problems (Lentner et al, 2011). The problems of the financial intermediation system are first to be seen in the drying up of resources and the reduction in risk-taking. Falling corporate revenues due to the crisis and shrinking markets also reduce the value of available cash flows, making it difficult to service debt, which will become a barrier to further borrowing in the short term. It is important to note, however, that this is the most accessible and usable external source for the SME sector in European countries, after the use of internal sources. Thus, the credit crunch also preserves the financing difficulties for the SME sector.

The functioning of the economy has always been constrained by cycles. By cycle we mean the potential fluctuations of GDP, i.e. its movements between the boom and bust phases of the economy (Matuskova, 2022). Increased optimism in the boom phase has a positive impact on all sectors of the economy, increasing investment and consumption. Banks' lending activity moves with the performance of the economy, rising in the booming phase and falling or even freezing in the event of a downturn or possible crisis (Papp - Zágonyi, 2017). Prosperous phases also increase the willingness of firms to borrow, so they tend to take on high debt in the hope of positive messages in the future, which all take the form of risk in the event of the next crisis. Lending to Hungarian SMEs was expansionary in the years preceding the crisis, due to the circumstances described earlier (Balog - Nagy, 2014), which was completely interrupted by the spill-over of the crisis. The cheap and mostly foreign funding that had been available before the crisis resulted in huge debt positions, and the credit boom injected huge risk into the Hungarian economy (Hegedűs - Schmidt, 2022).

The drying up of bank funds forced the sector to use up its reserves and reduce its capacity in order to survive. Due to the survival reaction to the crisis, the necessary investments were not made, leading to a further lagging behind larger competitors. The cautious behaviour of banks after the crisis led to an unprecedented decline in corporate sector credit at the international level (Bauer - Oláh, 2016). As several studies have pointed out, the lending of Hungarian companies was particularly late to start following the crisis, mainly due to supply-side decisions (Sóvágó, 2011). We should pay particular attention to the municipal system and the capital structure of firms within it (Zéman - Hegedűs 2016) As the study cited above confirms, Hungary has experienced the largest decline in lending in the region, although the surge in lending before the crisis was not particularly high. Even in 2013, the decline in lending did not stop (Fábián, 2014). Fear of credit led SMEs to increasingly seek alternative adjustment options, cut back on investment and production, which further worsened their creditworthiness, and all these negative effects on banks' lending potential slowed down the recovery process from the crisis (Bodnár, et al, 2017). In 2012, the Magyar Nemzeti Bank announced an interest rate reduction campaign to reverse this trend, which improved the lending situation of enterprises, but did not have a breakthrough effect, as market-based lending did not take off or took off very slowly (Bauer, 2016). This situation was helped by the Growth Loan Programme announced by the Magyar Nemzeti Bank, which provided loans at preferential interest rates to the SME sector, which was already facing significant financing problems. There is also evidence from the literature (Antal-Pomázi, 2011) that financing, i.e. limited access to finance and, in many cases, its very high cost, plays a crucial role in limiting SME growth. In the absence of finance, the sector is unable to grow, as the post-crisis years fully demonstrate. At its inception, the programme focused mainly on investment lending, as investment is crucial to kick-start growth and put the economy on a growth path. The loan programme has made a significant contribution to the health of the Hungarian economy after the 2008 crisis.

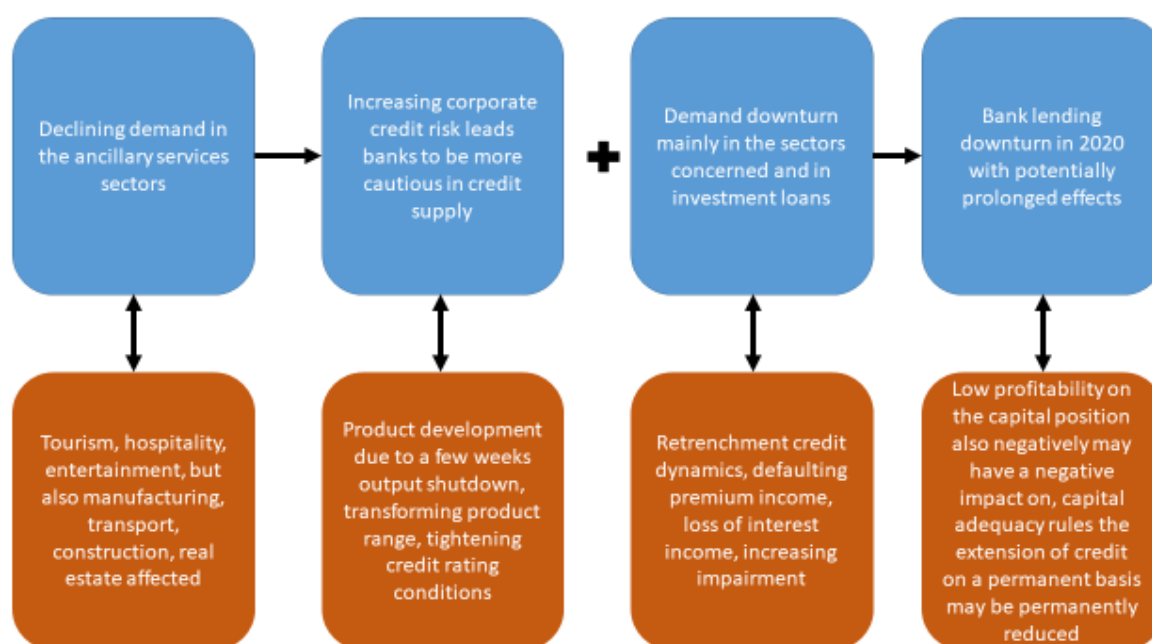

Source: Hegedűs - Schmidt, 2022 based on own editing

Figure 2. Potential direct impact of COVID-19 on corporate lending

Over the years, the instrument has become increasingly stimulative and has been effective in helping to tackle the coronavirus crisis in 2020. The programme has been expanded, offering Hungarian businesses more favourable conditions and a wider coverage area. The arrival of the coronavirus epidemic in 2020 brought another slice of the crisis to life. Closures due to the epidemic hampered supply chains. Mass illnesses caused labour shortages and disruption to processes. A number of businesses found themselves in a difficult situation, which was dealt with either by raising additional funding or by cutting costs, in many cases by laying off workers. Disruptions in supply chains caused stock problems and a fall in production, exacerbated by a fall in demand and a change in the consumption space, which also led to a change in consumer habits. The difficulties brought about by these changes were first of all liquidity problems for businesses, followed by investment problems and the halting of investments. These problems were quickly recognised by the Hungarian National Bank, which adapted its already well-functioning instrument to the conditions. The re-tailored Growth Loan Programme has provided a good basis for crisis management, providing effective tools to help businesses survive.

## Material and Methods

The figures presented in this paper are taken from the business lending statistics of the Magyar Nemzeti Bank. The Hungarian central bank has been collecting data on the functioning of the national economy by surveying domestic commercial banks on a regular basis for several years, and regularly publishes them on its website. The study presents an analysis of annual data on the credit stock of Hungarian enterprises from 1995 to 2021. In the course of the work, I have used stock data at the end of the period, which are presented in millions of forints. In the study I analyse the topic using stock data and base and chain ratios. In the present study, I have analysed the stock of HUF and foreign currency loans taken by enterprises.

## Results and Discussion

The changes in the borrowing of Hungarian businesses can be perfectly mapped using the databases maintained by the Magyar Nemzeti Bank. The borrowing that literature sources and show fluctuates considerably and is always determined by crises. The 2008 crisis and the subsequent smaller crises, followed by the 2020 crisis, have clearly left their mark on the credit financing of Hungarian enterprises. However, there is no doubt that it is impossible to operate without credit, which is necessary to bring investments forward and to overcome the various liquidity problems. Hungarian businesses have faced many challenges in the past, but they will not be spared in the future. If we look at the borrowing of Hungarian enterprises from 1995 onwards, we can observe a number of peculiarities. After the shock of 1995, following the change of regime, the corporate lending market began to recover. While in 1995, the level of debt financing was negligible compared to today's figures, this has changed significantly due to various factors. The shock of regime change kept many businesses away from debt, but as the Hungarian economy settled into the functioning of a market economy, credit became an increasingly important source. It can also be observed that initially only forint loans tended to dominate, which changed significantly around 2003 and 2004 thanks to the inflow of foreign currency sources. Prior to the 2008 crisis, foreign currency loans were the overwhelming predominant source of credit for businesses, due to their promised cheapness and lower prices, which posed a serious risk of the crisis materialising and escalating. The lack of awareness of the risks of foreign currency lending was due to a general lack of financial literacy, which was a serious problem for individuals and businesses alike. Following the 2008 shock, an increasing number of businesses tried to get rid of their accumulated foreign currency loan portfolio.

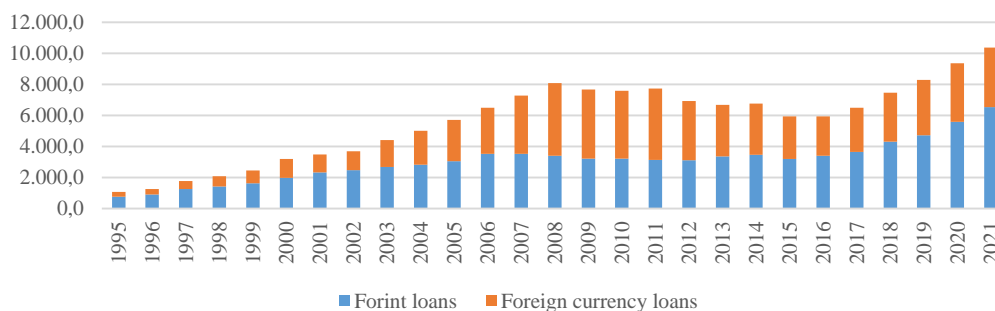

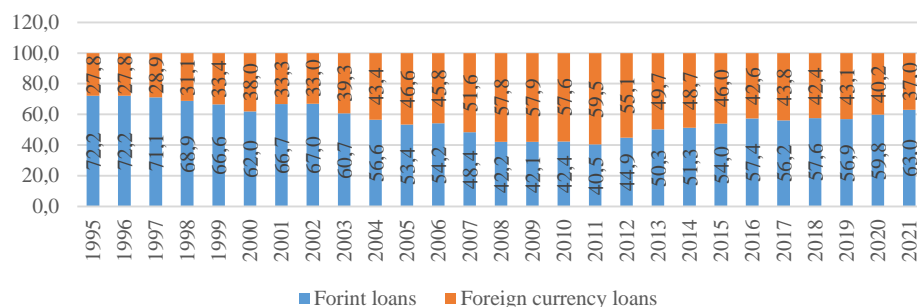

Source: Own editing based on data from the Hungarian Central Bank

Figure 3. Value and ratio of HUF and foreign currency loans of Hungarian enterprises in the years under review (billion HUF and %)

The reversal of this trend is expected to take place in 2013, coinciding with the launch of the Growth Loan Programme. Thereafter, the share of foreign currency loans in the debt financing structure of Hungarian enterprises has been steadily declining. Nowadays, it can be seen that foreign currency sources account for slightly more than one third of forint loan sources. In 2008, this ratio was close to 58%, which represented a huge risk in the system, as illustrated in Figure 3.

In the following, we focus on the sources of forint credit. The above bird's eye view shows that before the 2008 crisis, forint loans were not in vogue, were perceived as expensive and inflexible by borrowers, who turned to foreign currency sources of credit because of their promised cheapness. However, it should be remembered that foreign currency lending is nothing more than speculation on exchange rates. Borrowers are constantly speculating that the foreign currency's position against the Hungarian forint will permanently improve. However, this was disproved by the 2008 crisis. Within forint lending, the dominance of over-the-year loans is welcome. However, prior to the 2008 crisis, the share of overdrafts was just over 50%. In 2007, this share had already fallen to 50%, which deteriorated further until 2012. In the present case, too, the change is due to the introduction of the 2013 loan programme.

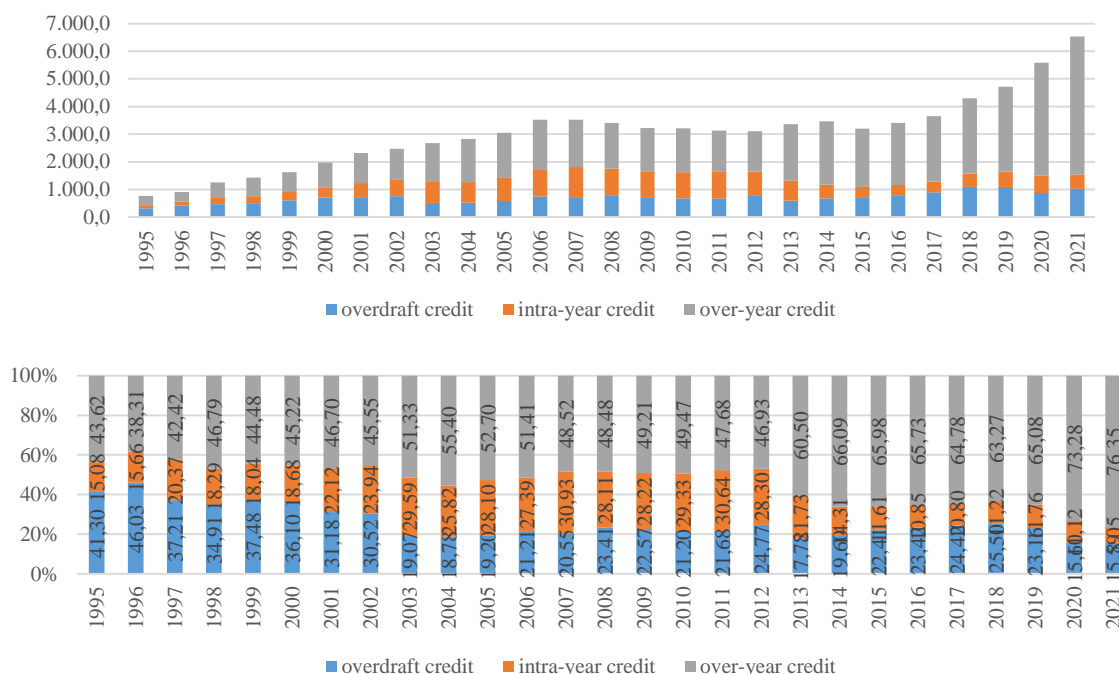

Source: Own editing based on data from the Hungarian Central Bank

Figure 4. Composition of Hungarian enterprises' forint loans and the share of each type in the years under review (billion HUF and %)

The share of loans over one year to be used for investment increased dramatically compared to the previous stock figures, i.e. to more than 60%. Thereafter, the share of these loan types in forint lending has shown an increasing trend year on year, with minimal declines. This is certainly welcome and should be underlined, as

investment is the driving force of the economy and a significant factor of economic growth. Therefore, it is very important that loans are used for items that will generate a return. This cannot be expected from liquidity loans, only investment loans can do this. Thus, it can be said that the structure of forint lending has taken a positive turn, with Hungarian SMEs preferring to invest these credit sources in the form of various investments and capital expenditure in order to ensure their future viability and competitiveness.

It is worth taking a look at the evolution of forint lending measured on a 2000 and 2008 basis. If we consider the turn of the millennium as the base year, we can see that after the 2008 crisis there was a significant decline in lending, mainly in overdrafts. Only from 2015 onwards has the overdraft lending rate gone above the 2000s base rate on a sustained basis, but from 2018 onwards it has been quite high. Intra-year forint lending also shows a fairly high increase, with a 238% increase in 2012 compared to the 2000s base. Thereafter, the growth rate has steadily eroded, with short-term credit sources now representing the same value as overdrafts. In contrast, there has been a huge increase in the value of overdrafts, which rose to over 200% from 2013, again thanks to the credit programme, reaching 300% in 2018, rising to over 400% in 2020 and reaching 559% in 2021 compared to the 2000 base, which is also a huge change on the face of it. If we measure the data against a 2008 base, we see similar changes, but the scale is not the same. Again, the biggest change compared to 2008 is in the overdue loans, which are 300% according to the latest data. Overdrafts are at 127%, yet, interestingly, intra-year loans ended the last year under review at 55%, half the 2008 figure.

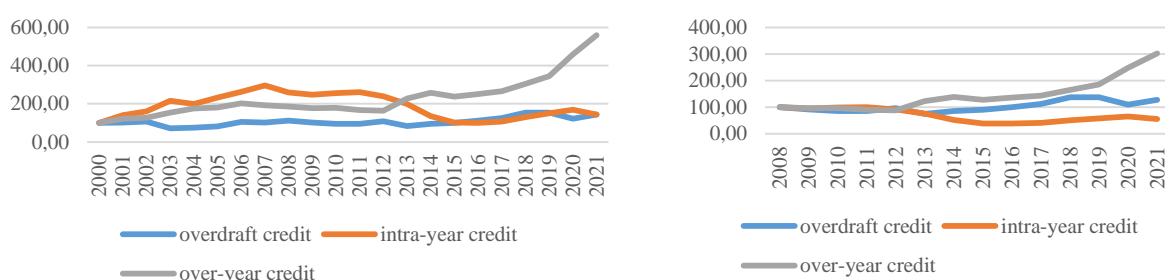

Source: Based on data from the Hungarian Central Bank

Figure 5. Changes in the HUF loan amounts of Hungarian enterprises in 2000 and 2008

Foreign currency lending as a concept in the Hungarian economy is, with little exaggeration, a buzzword. The financial difficulties caused by foreign currency lending have taught households and businesses at household and enterprise level the risks of foreign currency lending for life. The low level of financial literacy and ignorance of basic concepts have led to many bad decisions and their long-term negative consequences. Foreign currency lending started to increase at the turn of the millennium and became a major risk factor in the system, both before and after the 2008 crisis.

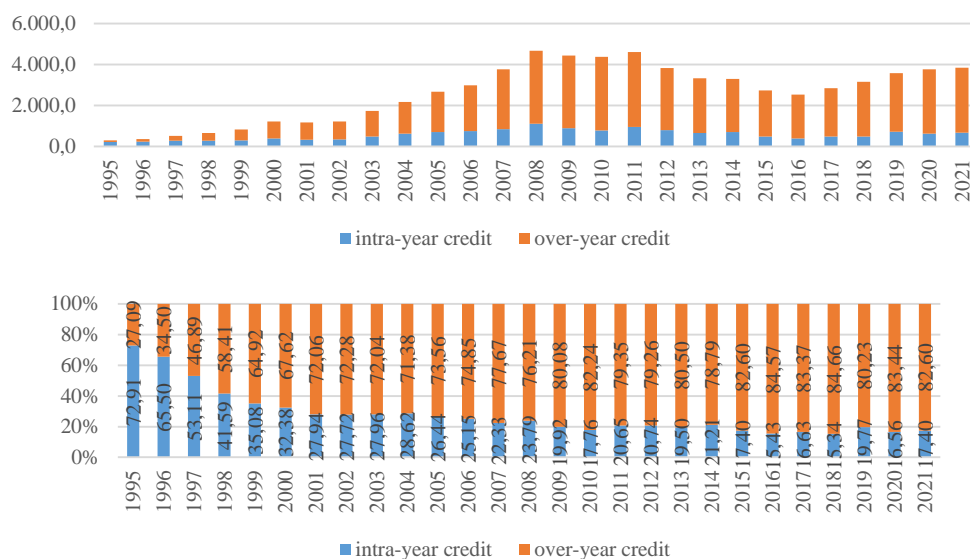

Source: Own editing based on data from the Hungarian Central Bank

Figure 6. Composition of foreign currency loans of Hungarian enterprises and the share of each type in the years under review (billion HUF and %)

Businesses and households tried by all means to get rid of these toxic loans, the principal and repayments of which were steadily increasing due to deteriorating macroeconomic conditions. However, foreign currency lending is still an active player in the financing of businesses today. Even though households have almost completely got rid of foreign currency denominated loans, it is still around 80% for businesses. This is higher than during the 2008 crisis. This could be due to the fact that businesses have easier access to credit from the parent company or to foreign currency denominated loans. Thus, foreign currency lending is still an active player in the life of enterprises today, as shown in Figure 6.

Foreign currency loans are grouped as over-the-year and intra-year loans. If we look at the change in values on a 2000 basis, we can see that there was a significant dip in the value of foreign currency loans after the crisis. This means that after a significant jump of 283% in 2016, the value has returned to the 2000 level. Even today, the share of foreign currency loans compared to 2000 is still below 200%, with the last year under review closing with 170% of loans within the year. The situation is different for intra-year loans. The peak for Hungarian enterprises compared to the 2000 base year was reached in 2011, when foreign currency loans over the year stood at 445%. This has been steadily declining due to macroeconomic factors. The year with the most significant low was 2016, when foreign currency loans outstanding were 261% of the 2000s base. Thereafter, there has been a steady increase, but the trend has far outpaced the increase in intra-year loans and we currently ended the last year under review at 387%.

If we look at the evolution of foreign currency lending in the financing of enterprises on a 2008 basis, we get a fully nuanced picture. It can be seen that intra-year foreign currency lending is nowhere near the 2008 base, it has been steadily declining and after bottoming out in 2016, it has shown a minimal increase and currently stands at 60%. The same is true for out-of-year loans, which have been steadily declining since 2008, with the highest trough in this case also in 2016, where they stood at 60%, and are currently only 89% of the 2008 base. The base ratio figures clearly confirm the cautious approach to foreign currency loans, the reluctance to use them and the shift towards domestic sources.

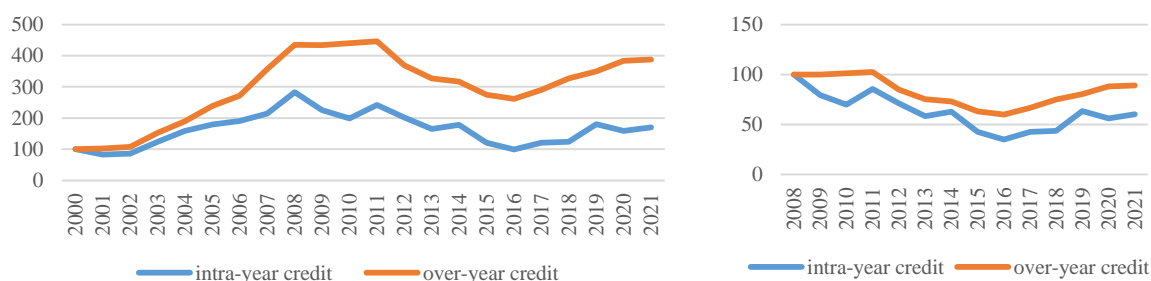

Source: Based on data from the Hungarian Central Bank  
 Figure 7. Change in foreign currency loans to Hungarian enterprises in 2000 and 2008

## Conclusion

After examining the debt financing of businesses, a number of messages can be decoded. It can be clearly stated that credit sources cannot be written off from business finance in Hungary or in any other country. If managed rationally and raised consciously, credit sources can contribute a lot to the development of enterprises and thus to the growth of national economies. Early investment and timely development bring competitive advantage and help to win and retain markets. However, it is very important that credit resources are always used carefully, from the moment they are requested to the moment they are borrowed and repaid. The higher the loan-to-value ratio, the greater the risk for businesses, not only in times of crisis but also in normal times. The risk of non-repayment can lead to bankruptcies and financial difficulties, which is why it is very important to monitor them consciously and continuously. This is where the much talked about concept of financial literacy and financial awareness comes into play, which is particularly important not only at the level of individuals but also in the life of businesses. The financial awareness of individuals feeds into the financial awareness of businesses, which also improves the financial awareness of the whole economy. There are a lot of interesting things to observe in the financing of credit in the Hungarian economy. The credit boom that preceded the 2008 crisis, the long-term credit freeze, which only the National Bank's lending programme could help, has many lessons to teach. On the one hand, it has taught businesses which types of credit to prefer, which is reflected in the analysis of the data. The predominance of overdrafts is a kind of guarantee for appropriate borrowing. It can also be seen that foreign currency sources of credit are still present in the lives of businesses, but that they show significant changes when compared to the baseline. Overall, it can be said that Hungarian enterprises have learned a lot from the

crises in terms of borrowing and it can also be said that the positive orientation and activity of the national bank has a major role to play in the current evolution of credit financing. However, the impact of the 2020 crisis cannot yet be fully assessed on the basis of the data presented here. However, the reported data are encouraging in that previous crises have provided a significant degree of immunity to businesses to adequately deal with similar situations.

## Scientific Ethics Declaration

The authors declare that the scientific ethical and legal responsibility of this article published in EPESS journal belongs to the authors.

## Acknowledgements

\* This article was presented as an oral presentation at the International Conference on Science and Education ([www.iconse.net](http://www.iconse.net)) held in Antalya/Turkey on November 15-18, 2022

\*This paper was supported by the Széll Kálmán Public Finance Research Centre of the National University of Public Service.

## References

- Abiad, A., Dell'Arricia, G., & Li, B. (2011). *Creditless recoveries*. IMF Working Paper, WP/11/58, <https://www.imf.org/external/pubs/ft/wp/2011/wp1158.pdf>, letöltve: 2019.06.07.
- Antal-Pomázi, K. (2011). A finanszírozási források szerepe a kis- és középvállalkozások növekedésében. *Közgazdasági Szemle, LVIII. évf., március*, 275.-295. pp.
- Balog, Á., Nagy, M. (2014): *Már nemcsak nálunk fontos a vállalati hitelek ösztönzése*. Magyar Nemzeti Bank, [http://www.mnb.hu/Root/Dokumentumtar/MNB/Kiadvanyok/szakmai\\_cikkek/hitelezeshp/Szakmai\\_cikk\\_Balog\\_adam\\_Nagy\\_Marton\\_Mar\\_nemcsak\\_nalunk\\_fontos\\_a\\_vallalati\\_hitelek\\_ostonzese.pdf](http://www.mnb.hu/Root/Dokumentumtar/MNB/Kiadvanyok/szakmai_cikkek/hitelezeshp/Szakmai_cikk_Balog_adam_Nagy_Marton_Mar_nemcsak_nalunk_fontos_a_vallalati_hitelek_ostonzese.pdf) letöltve: 2019.09.12.
- Banai, Á. (2016). A banki hitelezést meghatározó tényezők – középpontban a bankok helyzete és a makrokörnyezet, *Közgazdasági Szemle, LXIII. évf, február*, 137-161. pp.
- Bauer, P. (2016). *A növekedési hitelprogram 2013.-2015. évi makrogazdasági hatásai, növekedési hitelprogram – a Magyar Nemzeti Bank hitelösztönző eszközének tapasztalatai*, <https://www.mnb.hu/letoltes/novekedesi-hitelprogram-a-magyar-nemzeti-bank-hitelosztonzoz-eszkozene-k-tapasztalatai.pdf>, letöltve: 2019.09.12.
- Bauer, P., & Oláh, Zs. (2016). *Milyen veszélyeket rejt a hitelezési piac és a hitelközvetítés befagyása? Növekedési Hitelprogram – a Magyar Nemzeti Bank hitelösztönző eszközének tapasztalatai*, <https://www.mnb.hu/letoltes/novekedesi-hitelprogram-a-magyar-nemzeti-bank-hitelosztonzoz-eszkozene-k-tapasztalatai.pdf>, letöltve: 2016.12.10., 9.-20. pp.
- Beck, T. (2012). Finance and growth: Lessons from the literature and the recent crisis. <https://pdfs.semanticscholar.org/10da/04fd7c447e210a36c094483595cf53dc2e3f.pdf>, letöltve: 2017.03.05.
- Biggs, M., Mayer, T., & Pick, A. (2009). *Credit and economic recovery*, DNB Working Paper No. 218., [https://www.dnb.nl/binaries/Working%20paper%202018\\_tcm46-220409.pdf](https://www.dnb.nl/binaries/Working%20paper%202018_tcm46-220409.pdf), letöltve: 2020.04.19.
- Európai Bizottság (2020). Felhasználói útmutató a kkv-k fogalommeghatározásához, [file:///C:/Users/Csisz%C3%A1rik%20Szabolcs/Downloads/sme\\_definition\\_user\\_guide\\_hu-2.pdf](file:///C:/Users/Csisz%C3%A1rik%20Szabolcs/Downloads/sme_definition_user_guide_hu-2.pdf), letöltve: 2022.04.15.
- Fábián, G. (2014). *Az NHP megfordította a hitelszűke negatív spirálját*, Magyar Nemzeti Bank, [http://www.mnb.hu/Root/Dokumentumtar/MNB/Kiadvanyok/szakmai\\_cikkek/hitelezeshp/Szakmai\\_cikk\\_Fabian\\_Gergely\\_NHP.pdf](http://www.mnb.hu/Root/Dokumentumtar/MNB/Kiadvanyok/szakmai_cikkek/hitelezeshp/Szakmai_cikk_Fabian_Gergely_NHP.pdf) letöltve: 2021.06.15.
- Hegedűs, S. & Schmidt, B. (2022). Az NHP evolúciója – rugalmas igazodás a változó körülményekhez, in: *Hitelezési fordulattól a zöld átmenetig (szerk: Pulai, Gy.)*, Magyar Nemzeti Bank, 7–25. pp.
- Hegedűs, Sz., & Zéman, Z. (2016). Tőkeszerkezeti elméletek érvényesülésének vizsgálata a hazai önkormányzati tulajdonú gazdasági társaságok körében, *Statisztikai Szemle, 94*, 10, 1032-1049. pp.
- Lentner, Cs., Szigeti, C., & Borzán, A. (2011). New dimension of banks social responsibility, In: Szente V, Szendrő K, Varga Á, Barna R (szerk.) *Abstracts of the 3rd International Conference of Economic Sciences: Sustainable Economics - Community Strategies*, Kaposvár, Magyarország, 19-.20. pp.

- Lentner, Cs., & Zéman, Z. (2016). Handling crisis – Role in the economy = Manipulace s krizi - role v ekonomice. *Modern Science / Moderni Veda* 45-58. pp.
- Matuskova, E. (2022). A szlovák gazdaság és a többi visegrádi négy ország gazdasági ciklusainak összehasonlítása. *Pénzügyi Szemle*, 2022/3, 463-481. pp.
- Sóvágó, S. (2011). *Keresleti és kínálati tényezők a vállalati hitelezésben*, MNB tanulmányok 94., Magyar Nemzeti Bank, <https://www.mnb.hu/letoltes/mt94.pdf>, letöltve: 2021.09.12.
- Zéman, Z., Gábor, Á., Gál, Zs., & Bárczi, J. (2016). *The role of controlling in sustainable development - In the information support of strategic management*, In: Štefko, R; Frankovsky, M; Fedorko, R (szerk.) Presov, Szlovákia : University of Prešov 344-350. pp.

---

### Author Information

---

**Ágnes Csiszárík-Kocsir**  
Óbuda University, Hungary  
[kocsir.agnes@kgk.uni-obuda.hu](mailto:kocsir.agnes@kgk.uni-obuda.hu)

---

#### **To cite this article:**

Csiszárík-Kocsir, A. (2022). An overview analysis of debt financing for Hungarian enterprises and the impact of economic crises. *The Eurasia Proceedings of Educational & Social Sciences (EPESS)*, 28, 83-91.