



Bio-Inspired Pilot Design Approach based on Genetic Algorithm for OFDM-IDMA Scheme

Necmi Taşpınar¹, Şakir Şimşir^{2*}

¹ Erciyes Üniversitesi, Mühendislik Fakültesi, Elektrik-Elektronik Mühendisliği Bölümü, Kayseri, Türkiye (ORCID: 0000-0003-4689-4487)

² Nevşehir Hacı Bektaş Veli Üniversitesi, Müh.-Mim. Fakültesi, Elektrik-Elektronik Mühendisliği Bölümü, Nevşehir, Türkiye (ORCID: 0000-0002-1287-160X)

(First received 5 May 2020 and in final form 16 June 2020)

(DOI: 10.31590/ejosat.732528)

ATIF/REFERENCE: Taşpınar, N. & Şimşir, Ş. (2020). Bio-Inspired Pilot Design Approach based on Genetic Algorithm for OFDM-IDMA Scheme. *European Journal of Science and Technology*, (19), 466-474.

Abstract

It is well known that the efficiency of a channel estimator employing the strategy of comb-type pilot placement can be controlled by adjusting the positions of pilot tones. In this paper, by considering this situation, in order to maximize the estimation precision of the least squares (LS) algorithm utilized as a channel estimator in orthogonal frequency division multiplexing – interleave division multiple access (OFDM-IDMA) scheme, the genetic algorithm (GA) possessing a wide range of uses due to its powerful problem solving capability was utilized in the optimization of pilot positions. Besides, the computational load of mean square error (MSE) which is used as the objective function of GA was avoided by employing its upper bound during the optimization process. The upper bound of MSE was achieved by utilizing the Gershgorin disc theorem. In the simulations, the suggested pilot arrangement strategy based on the GA was compared to the conventional techniques like equispaced and random pilot placements in point of two criteria known as bit error rate (BER) and MSE. Simulation results put forth that GA-based pilot design strategy establishes a very clear superiority over the other considered methods by providing significant MSE and BER performances.

Keywords: Channel Estimation, Genetic Algorithm, OFDM-IDMA, Pilot Tones Design.

OFDM-IDMA Sistemi İçin Genetik Algoritmaya Dayalı Biyo-İlhamlı Pilot Dizayn Yaklaşımı

Öz

Tarak-tipi pilot yerleştirme stratejisi kullanan bir kanal kestiricisinin veriminin, pilot tonların pozisyonlarının ayarlanarak kontrol edilebileceği iyi bilinmektedir. Bu makalede, bu durum dikkate alınarak, dikgen frekans bölmeli çoğullama-serpiştirme bölmeli çoklu erişim (OFDM-IDMA) sisteminde kanal kestiricisi olarak kullanılan en küçük kareler (LS) algoritmasının kestirim hassasiyetini maksimuma çıkarmak amacıyla, güçlü problem çözme yeteneğinden dolayı geniş bir kullanım yelpazesine sahip olan genetik algoritma (GA), pilot tonların optimizasyonunda kullanılmıştır. Bunun yanı sıra, GA'nın amaç fonksiyonu olarak kullanılan ortalama karesel hatanın (MSE) hesaplama yükünden, optimizasyon işlemi boyunca ilgili fonksiyonun üst sınırı kullanılarak kaçınılmıştır. MSE'nin üst sınırı, Gershgorin disk teoreminden faydalanılarak elde edilmiştir. Simülasyonlarda, önerilen GA'ya dayalı pilot yerleştirme stratejisi, eşit aralıklı ve rastgele pilot yerleştirme gibi geleneksel yöntemler ile, bit hata oranı (BER) ve MSE olarak bilinen iki adet kriter bakımından karşılaştırılmıştır. Simülasyon sonuçları, GA tabanlı pilot dizayn stratejisinin, kayda değer bir MSE ve BER performansı sağlayarak, dikkate alınan diğer yöntemler üzerinde çok açık bir üstünlük kurduğunu ortaya koymuştur.

Anahtar Kelimeler: Kanal Kestirimi, Genetik Algoritma, OFDM-IDMA, Pilot Ton Dizaynı.

* Corresponding Author: Nevşehir Hacı Bektaş Veli Üniversitesi, Müh.-Mim. Fakültesi, Elektrik-Elektronik Mühendisliği Bölümü, Nevşehir, Türkiye, ORCID: 0000-0002-1287-160X, sakirsimsir@nevsehir.edu.tr

1. Introduction

Interleave Division Multiple Access (IDMA) was developed by Ping et al. (2006) with a view to fulfill the demands of future wireless technology. The IDMA system, which is a type of multiple access schemes, not only possesses low-complex decoding capability, but also has quite high power efficiency that can be achieved by optimizing the power of multiple users. It is unavoidable for the multiple access systems to employ complex multiuser detectors (MUDs) for a satisfying performance. Because, the occurrence of multiple access interference (MAI) doesn't let the low-complex single user detectors to show a great performance as MUDs do. On the other hand, it is possible for the IDMA system to eliminate the MAI through its turbo-type MUD mechanism in a low-cost manner without any compromise on the performance. Moreover, the number of users doesn't affect the complexity of decoding at the receiver side of IDMA scheme. However, when it comes to transmitting the signals over the multipath channels, the increase in the number of taps belonging to the related channel leads to the increase of computational load at the IDMA receiver. In order to resolve this problem arising from the fading effects of the multipath channel, orthogonal frequency division multiplexing (OFDM) scheme was integrated to the IDMA to maintain the low-decoding complexity of IDMA for multipath fading channels as well. By doing so, the new hybrid system called OFDM-IDMA (Ping et al., 2007) has become more resistant to the multipath fading effects than the simple IDMA scheme. For this reason, OFDM-IDMA scheme comprising the benefits of not only OFDM but also IDMA system is considered as being one of the candidate transmission technologies which can be able to deal with both MAI and inter symbol interference (ISI) drawbacks in mobile transmission. The operation of chip by chip multiuser detection (CBC MUD) carried out in iterative manner on the basis of IDMA principle and the usage of multicarrier-based transmission scheme make the OFDM-IDMA system robust against both MAI and ISI, respectively (Dang et al., 2013; Ping et al., 2006). By eliminating these two common drawbacks complicating the wireless communication, the following appealing features are yielded by the OFDM-IDMA system (Ping et al., 2007):

- It is possible to achieve higher throughput via the OFDM-IDMA compared to the other existing multiple access technologies like simple code division multiple access (CDMA) and OFDM-CDMA.
- In case of allocating the resource of the whole bandwidth to a single user, by utilizing a method of superposition coding, a very high throughput can be achieved via the OFDM-IDMA scheme for the single user case. It is really hard to approach the similar throughput by the OFDM-CDMA or the plain CDMA schemes.
- OFDM-IDMA is capable of ensuring multiuser gain in fading channel conditions.

In spite of many advantages owned by the OFDM-IDMA scheme, the receiver side of the related system needs the channel state information (CSI) to utilize in removing the fading effects of the wireless channel. Therefore, a channel estimation procedure based on comb-type pilot placement strategy can be an effective way of acquiring channel coefficients (Coleri et al., 2002). In the related pilot arrangement strategy, pilots are distributed from beginning to the end of each OFDM symbol, uniformly (Hsieh and Wei, 1998). On the other hand, the distribution pattern of pilot tones has a remarkable impact on the accuracy of channel estimation. Namely, the estimation errors can be minimized by optimizing the pilot locations. To this end, in this study, we suggest a GA-based pilot design scheme for the OFDM-IDMA.

Some studies of pilot optimization using intelligent optimization algorithms are available in the literature (Seyman and Taşpınar, 2011; Vidhya and Shankarkumar, 2013; Seyman and Taşpınar, 2012; D'orazio et al., 2010; Seyman and Taşpınar, 2013). In (Seyman and Taşpınar, 2011) and (Vidhya and Shankarkumar, 2013), particle swarm optimization (PSO) algorithm was suggested for the design of pilot tones in multiple-input multiple-output – OFDM (MIMO-OFDM) scheme. In (Seyman and Taşpınar, 2012), as well as the position optimization of pilot tones, their powers were optimized via differential evolution (DE) algorithm. In (D'orazio et al., 2010), the authors carried out the performance enhancement process in the operation of minimum mean square error (MMSE)-based channel equalization by benefiting from PSO and GA. In (Seyman and Taşpınar, 2013), artificial bee colony (ABC) algorithm was proposed for optimizing the pilot locations in MIMO-OFDM and the comparisons were made with PSO, random and orthogonal-based pilot optimization methods in point of bit error rate (BER) and mean square error (MSE) criteria. In (Taşpınar and Şimşir, 2019), (Şimşir and Taşpınar, 2017) and (Şimşir and Taşpınar, 2018), the pilot design schemes based on PSO, grey wolf optimizer (GWO) and harmony search (HS) algorithms were developed for the OFDM-IDMA system, respectively.

The article is planned in the following way: In Section 2, the OFDM-IDMA scheme is introduced. In Section 3, the information about GA and its implementation to the problem of pilot optimization is yielded. Section 4 offers the simulation results. In Section 5, the article is completed with the conclusions.

2. System Description

The block diagram in Fig. 1 demonstrates the OFDM-IDMA structure. As it is evident in the Fig. 1, in the first place, the groups of binary bits in K users are subjected to forward error correction (FEC) coding process. Each of the encoded bit groups is then spread through the same spreading sequence. Subsequent to the spreading operation, the resultant bit sequences are interleaved via K different interleavers each of which is generated in a random way. After that, the modulation of interleaved bit sequences, insertion of pilot tones and inverse fast Fourier transform (IFFT) operations are carried out in order, and finally, the resultant signal is given to the channel.

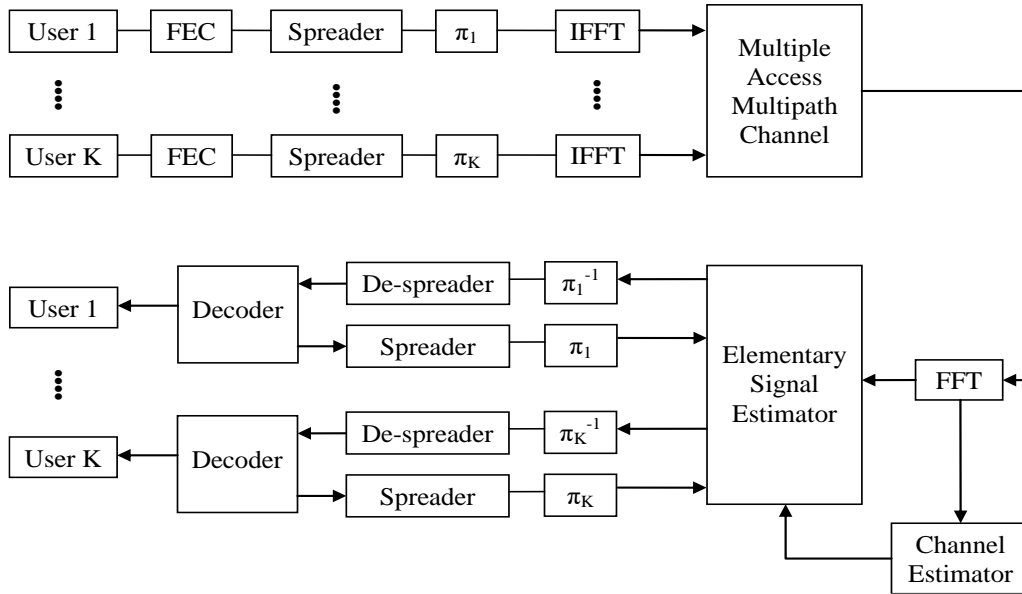

Fig. 1. OFDM-IDMA transceiver.

At the receiver side, fast Fourier transform (FFT) process is executed to transform the received signal to the frequency domain and then, the resulting $N \times 1$ signal denoted by $\mathbf{Y}(n)$ is attained (Taşpınar and Şimşir, 2017; Şimşir and Taşpınar, 2015):

$$\mathbf{Y}(n) = \sum_{k=1}^K \mathbf{X}_k^{diag}(n) \cdot \mathbf{F} \cdot \mathbf{h}(n) + \mathbf{W}(n) \quad (1)$$

where $N \times 1$ transmitted symbol, additive white Gaussian noise (AWGN) and channel impulse response (CIR) are represented by the vectors of $\mathbf{X}_k(n)$, $\mathbf{W}(n)$ and $\mathbf{h}(n)$, respectively. While n specifies the subcarrier indices, k signifies the user indices. \mathbf{F} symbolizes the unitary discrete Fourier transform (DFT) matrix with the size of $N \times N$:

$$\mathbf{F} = \frac{1}{\sqrt{N}} \begin{bmatrix} 1 & 1 & \dots & 1 \\ 1 & e^{-j2\pi/N} & \dots & e^{-j2\pi(N-1)/N} \\ \vdots & \vdots & \ddots & \vdots \\ 1 & e^{-j2\pi(N-1)/N} & \dots & e^{-j2\pi(N-1)(N-1)/N} \end{bmatrix} \quad (2)$$

It is possible to state $\mathbf{X}_k(n)$ as the combination of two vectors in the following manner:

$$\mathbf{X}_k(n) = \mathbf{S}_k(n) + \mathbf{P}_k(n) \quad (3)$$

where $\mathbf{S}_k(n)$ and $\mathbf{P}_k(n)$ specify the $N \times 1$ data and pilot vectors. So, the (1) is reformulated as:

$$\mathbf{Y}(n) = \sum_{k=1}^K \mathbf{S}_k^{diag}(n) \cdot \mathbf{F} \cdot \mathbf{h}(n) + \sum_{k=1}^K \mathbf{P}_k^{diag}(n) \cdot \mathbf{F} \cdot \mathbf{h}(n) + \mathbf{W}(n) \quad (4)$$

The expression of the (4) in a simple manner is given below:

$$\mathbf{Y} = \mathbf{G} \cdot \mathbf{h} + \mathbf{A} \cdot \mathbf{h} + \mathbf{W} \quad (5)$$

where the matrix \mathbf{G} and matrix \mathbf{A} have the size of $N \times N$. $N \times 1$ CIR vector symbolized by \mathbf{h} is given below:

$$\mathbf{h} = [h_1, h_2, h_3, \dots, h_N]^T \quad (6)$$

Herewith, CIR of the wireless channel is achieved by utilizing least squares (LS) algorithm in the following way:

$$\hat{\mathbf{h}} = \mathbf{G}^t \cdot \mathbf{Y} = \mathbf{h} + (\mathbf{G}^H \cdot \mathbf{G})^{-1} \cdot \mathbf{G}^H \cdot \mathbf{W} = \mathbf{h} + \mathbf{G}^t \cdot \mathbf{W} \quad (7)$$

where $\hat{\mathbf{h}}$, $(\cdot)^H$ and $(\cdot)'$ correspond to the estimated CIR, Hermitian and the pseudo inverse matrixes, respectively (Taşpınar and Şimşir, 2019; Şimşir and Taşpınar, 2017; Şimşir and Taşpınar, 2018).

After the acquisition of CIRs, the signals in frequency domain are fed to the elementary signal estimator (ESE) and CBC MUD operation starts. In the related operation, the channel coefficients estimated through the LS algorithm supported by the GA-based pilot optimization are exploited to get rid of fading effects of the wireless channel. In CBC MUD process, initially, ESE produces extrinsic log-likelihood ratio (LLR) sequences from its output for each user. These data sequences are then subjected to de-interleaving and de-spreading operations, respectively previous to being given to the inputs of decoder (DEC) blocks. The signals obtained from the DEC outputs are respread and reinterleaved, respectively and applied to the ESE inputs again. By doing so, one loop of CBC MUD operation comes to an end. This cycle is renovated for a certain number of times and for each repetition, both the DEC outputs and LLR streams are renewed. More exhaustive explanation of CBC MUD procedure can be found in (Ping et al., 2007; Ping et al., 2006).

2.1. The MSE Expression Owned by the LS Estimator

The MSE calculation for the LS-based channel estimating in the OFDM-IDMA scheme is given below:

$$MSE = \frac{1}{N} \cdot \varepsilon \left\{ \left\| \hat{\mathbf{h}} - \mathbf{h} \right\|^2 \right\} = \frac{1}{N} \cdot \varepsilon \left\{ \left\| \mathbf{G}' \cdot \mathbf{W} \right\|^2 \right\} = \frac{1}{N} \cdot tr \left\{ \mathbf{G}' \cdot \varepsilon \{ \mathbf{W} \cdot \mathbf{W}^H \} \cdot \mathbf{G}'^H \right\} \quad (8)$$

where $\varepsilon(\cdot)$ and $tr(\cdot)$ correspond to expectation and trace operator, respectively. If the zero mean white Gaussian noise is taken into account, $\varepsilon\{\mathbf{W} \cdot \mathbf{W}^H\}$ can be rewritten as $\sigma^2 \cdot \mathbf{I}_m$, where \mathbf{I}_m and σ^2 symbolize the identity matrix with the size of $M \times M$ and noise variance, in order. With reference to this, MSE can be reduced to the following equation:

$$MSE = \frac{1}{N} \cdot tr \left\{ (\mathbf{G} \cdot \mathbf{G}^H)^{-1} \right\} \quad (9)$$

In case of providing the equivalence of $\mathbf{G} \cdot \mathbf{G}^H = P \cdot \mathbf{I}_N$, the minimum MSE can be obtained in the following way:

$$MSE = \frac{\sigma^2}{P} \quad (10)$$

where the constant power value of the pilot tones is denoted by P (Taşpınar and Şimşir, 2019; Şimşir and Taşpınar, 2017; Şimşir and Taşpınar, 2018).

3. Genetic Algorithm (GA) Based Pilot Design Technique

As an evolutionary based optimization algorithm, the GA presented by John Holland in 1960s mimics the biological evolution process for finding optimal solutions to various engineering problems. In GA, the candidate solutions optimized during the iterations are represented by the chromosomes. For each iteration, the population members are exposed to three main bio-inspired mechanisms such as crossover, mutation and selection to get fitter individuals for the next generation. The flowchart of the GA is given in Fig. 2 (Goldberg, 1989; Bhatia et al., 2016; Goldberg and Deb, 1991; Ölgün and Tilki, 2020; Özoğlu et al., 2019). In our pilot optimization problem, each chromosome corresponds to D -dimensional solution vector like $\mathbf{C}_i = (c_i^1, c_i^2, c_i^3, \dots, c_i^D)$. The genes belonging to chromosomes denote the dimensions from 1 to D corresponding to the pilot positions to be optimized. In our simulation, restriction process is performed for each dimension of the i th solution vector by defining lower and upper bounds as illustrated in Table 1.

In the optimization phase, the simulation process starts with giving random values to the population members by providing lower and upper bounds for each dimension. Afterwards, fitness values of the initialized solutions are calculated by using objective function in (14). Considering the fitness values, two of the population members called parents are selected by using tournament method (Goldberg and Deb, 1991) and then, one random number is generated in the range [0,1]. If randomly generated number is smaller than the predefined crossover rate, the crossover operation is performed for these selected members and the two new members called children are produced for being transferred to the next generation. Otherwise, the selected parents are directly transferred to the next generation without being exposed to crossover which is performed by determining one point for the parent solution vectors and exchanging the parts beyond that point. Following the transfer operation, the random numbers in the range [0,1] are produced for each gene of the transferred members in the next generation. If randomly generated number is smaller than the predefined mutation rate, the related gene is mutated by generating random number between the lower and upper bounds defined in Table 1 for the related gene. Therefore, the first two members are obtained for the next generation. These operations are carried out until completing population number of the next generation and thus, one iteration of the optimization process is fulfilled. The operations performed for one iteration is repeated until meeting the stopping criteria which is appointed as 100 iterations in this paper. Subsequent to the end of the iterations, the solution possessing the best fitness value is appointed as the positions vector of the pilot tones.

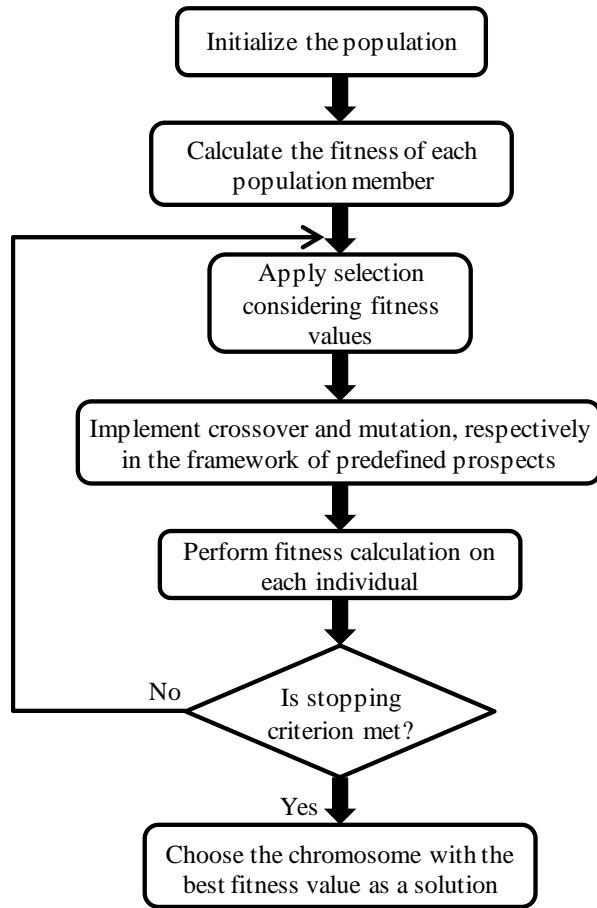

Fig. 2. Flowchart of GA.

Table 1. Definition of lower and upper bounds for the solution vectors.

<i>Dimensions</i>	c_i^1	c_i^2	c_i^3	c_i^4	c_i^5	c_i^6	c_i^7	c_i^8	c_i^9	c_i^{10}	c_i^{11}	c_i^{12}	c_i^D
Lower Bound (Lb)	1	9	17	25	33	41	49	57	65	73	81	89	$8D-7$
Upper Bound (Ub)	8	16	24	32	40	48	56	64	72	80	88	96	$8D$

3.1. Objective Function of Genetic Algorithm

The MSE given in (10) can be used as the objective function in GA for the optimization process. However, matrix inversion process required in (10) enhances the computational load of the GA-based pilot optimization. Therefore, since the eigenvalues of the matrix $G \cdot G^H$ are positive and real, Gershgorin circle theorem can be benefited for obtaining the upper bound of MSE in order to get rid of computational complexity (Horn and Johnson, 1985). The upper bound of MSE is achieved in the following manner:

$$tr\{(G \cdot G^H)^{-1}\} = \sum_{i=1}^N \frac{1}{\lambda_i} \leq \begin{cases} \frac{N}{P - R_{max}} & , P > R_{max} \\ + \infty & , P \leq R_{max} \end{cases} \tag{11}$$

In (11), $\lambda_i (i=1,2,\dots,N)$ denotes the eigenvalues belonging to the $G \cdot G^H$ matrix given below:

$$G \cdot G^H = \begin{bmatrix} P & x_{1,2} & x_{1,3} & \dots & x_{1,N} \\ x_{2,1} & P & x_{2,3} & \dots & x_{2,N} \\ x_{3,1} & x_{3,2} & P & \dots & x_{3,N} \\ \vdots & \vdots & \vdots & \ddots & \vdots \\ x_{N,1} & x_{N,2} & x_{N,3} & \dots & P \end{bmatrix} \tag{12}$$

where the values of P located on the diagonal line are equal to each other. In (11), $R_{max} = \max(\mathbf{R}_i)$ denotes the maximum radius of the Gershgorin disc, where $\mathbf{R}_i(i=1,2,\dots,N)$ specifies the sum of the i th row's off-diagonal components in the $\mathbf{G} \cdot \mathbf{G}^H$ matrix. The expression of \mathbf{R}_i is as follows:

$$\mathbf{R}_i = \sum_{j=1, j \neq i}^N |x_{ij}| \tag{13}$$

where $x_{ij}(i=1,2,\dots,N; j=1,2,\dots,N)$ denotes the matrix components of $\mathbf{G} \cdot \mathbf{G}^H$. Eventual objective function can be obtained as follows:

$$objective\ function = \frac{R_{max}}{P} \tag{14}$$

4. Simulation Results

In this Section, in order to measure the effectiveness of the suggested GA-based pilot optimization procedure, its performance is compared to two well-known conventional methods called equispaced and random-based pilot arrangements in point of MSE and BER criteria. In the simulations, we perform the FEC coding operation by using the convolutional encoders having a rate of 1/2. On the other hand, the spreading sequence rate is determined as 1/8. The other parameters used for the simulation of OFDM-IDMA system and the GA control parameters are yielded in Table 2 and Table 3, respectively.

Table 2. OFDM-IDMA simulation parameters.

Subcarrier number	128
FFT size	128
Number of pilots	16
Frequency of sampling	3.5 MHz
Sampling period (T_s)	285.71 ns
Symbol part duration	$128T_s = 36.57 \mu s$
Cyclic prefix length	FFT/4 = 32
Type of modulation	QPSK
Channel Model	Six tap ITU "Vehicular"

Table 3. GA parameters.

Size of population	10
Iteration number	100
Mutation rate (Mr)	$Mr = 0.005$
Crossover rate (Cr)	$Cr = 0.8$

The three different placements of pilot tones considered in this study are as follows:

- i. Random arrangement.
- ii. Equispaced arrangement demonstrated in Fig. 3.
- iii. GA-supported pilot positioning demonstrated in Fig. 4.

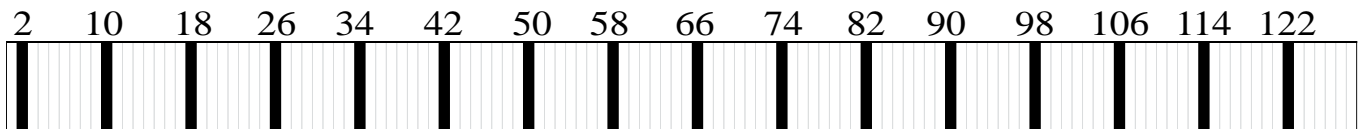

Fig. 3. Equispaced pilot placement.

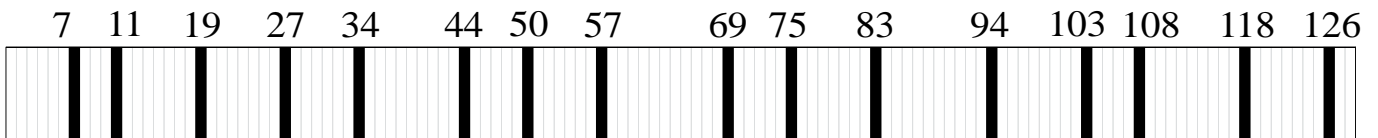

Fig. 4. Optimized pilot arrangement through genetic algorithm.

In Fig. 5, the proposed GA-based strategy is compared to the classical methods considered in this paper with regard to BER performance. While the user number is appointed as 6, the other parameter values of OFDM-IDMA and GA are determined as in Table 2 and Table 3 for this simulation. It is obviously observed in the Fig. 5 that the proposed pilot design strategy based on GA outperforms both random and equispaced pilot placement methods by creating considerable difference in terms of BER performance. At each E_b/N_0 value, our proposed technique shows better BER results compared to the considered classical methods. For example, in case of taking the 8 dB value in the horizontal axis as a reference E_b/N_0 point, whereas the BER of the suggested GA-based technique is 3.13×10^{-4} , equispaced and random placement methods have 1.4×10^{-3} and 1.8×10^{-2} BER values, respectively.

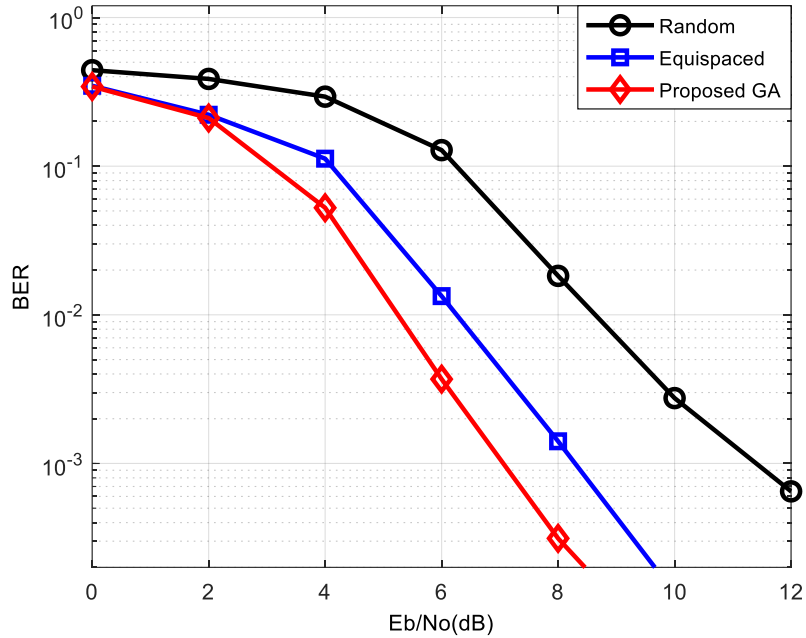

Fig. 5. BER achievements of the considered techniques.

In Fig. 6, the performances of the considered methods are analyzed with regard to another criteria called MSE. The MSE graph is acquired via computing the estimation errors of LS estimator in order to investigate the influence of considered strategies on the estimation performance separately. According to the Fig. 6, our proposed scheme used by LS estimator in the OFDM-IDMA provides the least estimation errors among the considered methods at each E_b/N_0 value. Especially at elevated E_b/N_0 values, the performance gap between the GA and the other methods is getting larger. For instance, at 14 dB E_b/N_0 value, while the MSE values of the conventional schemes based on random and equispaced pilot placements are equal to 3.72×10^{-1} and 2.56×10^{-1} , the MSE of our proposed GA-based strategy is equal to 1×10^{-1} .

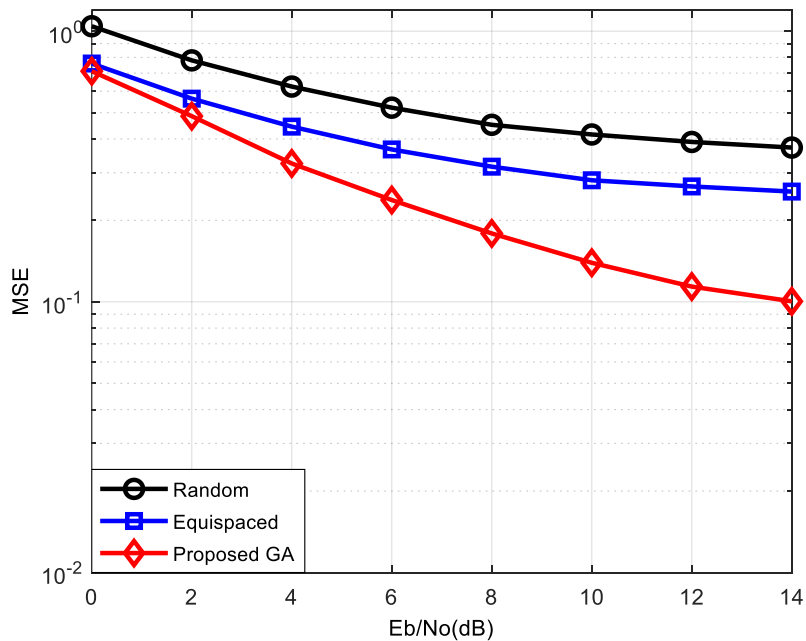

Fig. 6. MSE achievements of the considered schemes.

In Fig. 7, the convergence capability of the genetic algorithm is demonstrated. According to the Fig. 7, the MSE value of the GA starts to decline rapidly from the first iteration and the algorithm reaches its optimal solution at 63rd iteration.

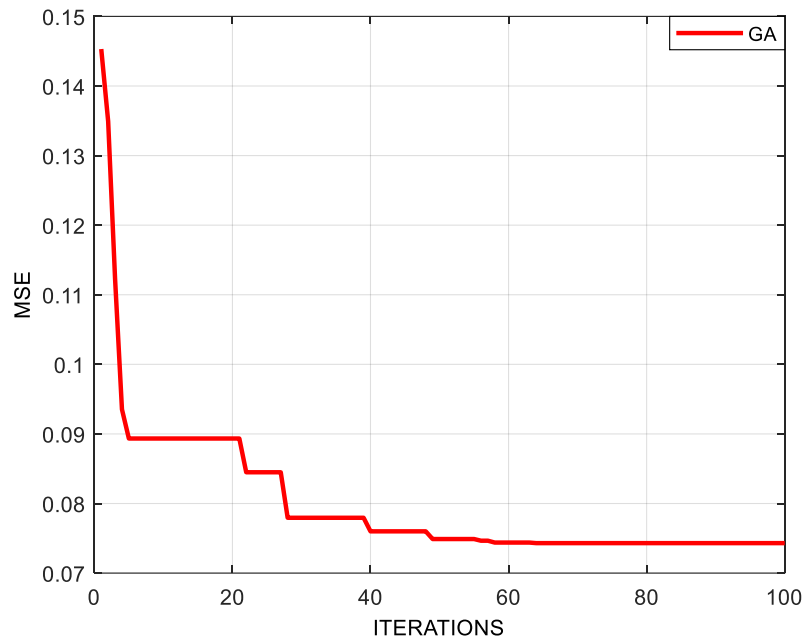

Fig. 7. The convergence performance of the genetic algorithm.

In Fig. 8, the OFDM-IDMA performance is measured with regard to BER criteria for each method under varied number of users. The BER curves are obtained under the number of 6, 7 and 8 users for each pilot placement method. It can be comfortably perceived from the Fig. 8 that, the BER of OFDM-IDMA scheme, in which any of the considered strategies is employed for pilot arrangement, escalate at each Eb/No value in case of elevating the number of users. For instance, if the BER performance of the GA at 8 dB is taken into consideration, the BER values achieved through the proposed scheme for 6, 7 and 8 users will be read from the Fig.8 as 3.13×10^{-4} , 3×10^{-3} and 5.6×10^{-2} , respectively. If it is focused on the BER results of the related schemes for each user number at 8 dB Eb/No value, it will be seen that the BER values of random, equispaced and GA-based pilot design schemes are equal to 1.83×10^{-2} , 1.41×10^{-3} and 3.13×10^{-4} for K=6; 1.78×10^{-1} , 1.56×10^{-2} and 3×10^{-3} for K=7; 3.58×10^{-1} , 1.48×10^{-1} and 5.6×10^{-2} for K=8, respectively.

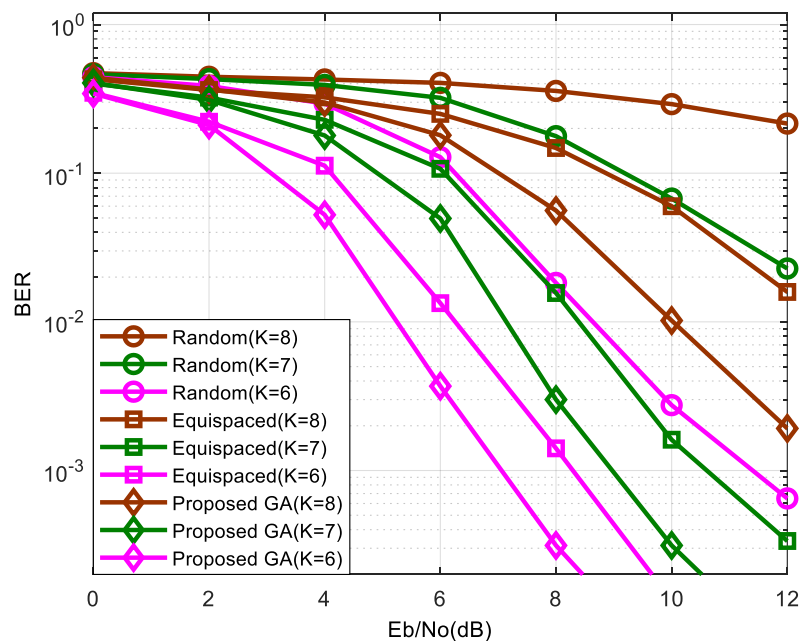

Fig. 8. BER performance of each technique for different user numbers.

5. Conclusion

In this study, a pilot design scheme based on GA was developed for the OFDM-IDMA with a view to achieve optimal pilot distribution possessing a significant influence on the estimation capability of LS estimator. The capability of the suggested strategy is compared to the conventional placement methods like equispaced and random placements in point of MSE and BER criteria. It is verified via the simulations that, GA-based pilot positioning procedure surpasses the other considered methods by ensuring a considerable advancement in the BER and MSE performance of the OFDM-IDMA scheme.

Acknowledgement

Scientific and Technological Research Council of Turkey (TUBITAK) funded this work [Grant No: 115E653].

References

- Bhatia, T., Kansal, S., Goel, S., & Verma, A. K. (2016). A genetic algorithm based distance-aware routing protocol for wireless sensor networks. *Computers and Electrical Engineering*, 56(2016), 441–455.
- Coleri, S., Ergen, M., Puri, A., & Bahai, A. (2002). Channel estimation techniques based on pilot arrangement in OFDM systems. *IEEE Transactions on Broadcasting*, 48(3), 223–229.
- Dang, J., Zhang, W., Yang, L., & Zhang, Z. (2013). OFDM-IDMA with user grouping. *IEEE Transactions on Communications*, 61(5), 1947–1955.
- D'orazio, L., Sacchi, C., & Doneli, M. (2010, September 13–14). *Adaptive channel estimation for STBC-OFDM systems based on nature-inspired optimization strategies* [Conference presentation]. International Workshop on Multiple Access Communications (MACOM2010), Barcelona, Spain.
- Goldberg, D. E. (1989). *Genetic Algorithms in Search, Optimization and Machine Learning*. Addison-Wesley.
- Goldberg, D. E., & Deb, K. (1991). A comparative analysis of selection schemes used in genetic algorithms. In G. J. E., Rawlins (Ed), *Foundations of Genetic Algorithms* (pp. 69–93). Morgan-Kaufman.
- Horn, R. A., & Johnson, C. R. (1985). *Matrix Analysis*. Cambridge University Press.
- Hsieh, M. H., & Wei, C. H. (1998). Channel estimation for OFDM systems based on comb-type pilot arrangement in frequency selective fading channels. *IEEE Transactions on Consumer Electronics*, 44(1), 217–225.
- Ölğün, M., & Tilki, U. (2020). Neural network based sliding mode controller with genetic algorithm for two link robot manipulator. *European Journal of Science and Technology*, (Special Issue), 120–129.
- Özoğlu, B., Çakmak, E., & Koç, T. (2019). Clarke & Wright's savings algorithm and genetic algorithms based hybrid approach for flying sidekick traveling salesman problem. *European Journal of Science and Technology*, (Special Issue), 185–192.
- Ping, L., Guo, Q., & Tong, J. (2007). The OFDM-IDMA approach to wireless communication system. *IEEE Wireless Communications*, 14(3), 18–24.
- Ping, L., Liu, L., Wu, K. Y., & Leung, W. K. (2006). Interleave-division multiple-access. *IEEE Transactions on Wireless Communications*, 5(4), 938–947.
- Seyman, M. N., & Taşpınar, N. (2011). Particle swarm optimization for pilot tones design in MIMO-OFDM systems. *EURASIP Journal on Advances in Signal Processing*, 2011(10), 1–11.
- Seyman, M. N., & Taşpınar, N. (2012). Optimization of pilot tones using differential evolution algorithm in MIMO-OFDM systems. *Turkish Journal of Electrical Engineering and Computer Sciences*, 20(1), 15–23.
- Seyman, M. N., & Taşpınar, N. (2013). Pilot tones optimization using artificial bee colony algorithm for MIMO-OFDM systems. *Wireless Personal Communications*, 71(1), 151–163.
- Şimşir, Ş., & Taşpınar, N. (2015). Channel estimation using radial basis function neural network in OFDM-IDMA system. *Wireless Personal Communications*, 85(4), 1883–1893.
- Şimşir, Ş., & Taşpınar, N. (2017). Pilot tones design using Grey Wolf Optimizer for OFDM-IDMA system. *Physical Communication*, 25(1), 259–267.
- Şimşir, Ş., & Taşpınar, N. (2018). Advanced pilot design procedure based on HS algorithm for OFDM-IDMA system. *IET Communications*, 12(10), 1155–1162.
- Taşpınar, N., & Şimşir, Ş. (2017). Channel estimation using an adaptive neuro fuzzy inference system in the OFDM-IDMA system. *Turkish Journal of Electrical Engineering and Computer Sciences*, 25(1), 352–364.
- Taşpınar, N., & Şimşir, Ş. (2019). Pilot tones design using particle swarm optimization for OFDM-IDMA system. *Neural Computing and Applications*, 31(9), 5299–5308.
- Vidhya, K., & Shankarkumar, K. R. (2013). Channel estimation and optimization for pilot design in MIMO OFDM systems. *International Journal of Emerging Technology and Advanced Engineering*, 3(2), 175–180.