

AN EARLY CHALCOLITHIC BUILDING FROM KÖŞK HÖYÜK

ALİYE ÖZTAN - EROL FAYDALI

Excavations at Köşk Höyük, which were interrupted upon death of our dear colleague, Prof. Dr. Uğur Silistreli, have been re-initiated in the name of Niğde Museum in 1995. The architecture and small finds recovered by Prof. Dr. Silistreli during his excavations will be published in Köşk Höyük I final report which is under preparation by our team for his memory. The subject of the current article is a building with two phases and its finds which were uncovered in 1995-1996 seasons¹.

ARCHITECTURE :

This building, which is fairly regular for Köşk Höyük and its related era, is located in adjacent to a previously excavated building to south². The building which shares a wall with its neighbor building (phase 1) was destroyed by fire after a while, and another one was built on it within the same period (phase 2). The buildings locating in the square G/11-12 according to new topographical map, posses different characteristics in respect of dimensions, plan and inner decoration.

Phase 1:

The building is an irregular rectangular in shape having 9.00 x 6.75 m dimensions during the first building period. This irregular plan is due to careless construction of the walls in different dimensions. Of the walls, the western one is 54-74 cm in thickness while the northern, eastern and southern walls are 60-90 cm, 55-74 cm and 44-50 cm respectively. The

¹ Archaeological excavations are being carried out under direction of Erol Faydalı, the director of Niğde Museum with participation of Prof. Dr. Nimet Özgüç and A. Öztan. The attendants of the 1995-1996 seasons were Fazlı Açıkgöz and Mahmut Altuncan from Niğde Museum, Dr. Hatçe Baltacıoğlu, Associate Professor Dr. Süleyman Özkan, Deputy Associate Professor Dr. S.Yücel Şenyurt, Research Assistant M. And Atasoy, the archaeologists Nurperri Ayengin, Nilgün Gökalp, Nimet Demirci, Leyla Gül, Cem Düzgün, Ebru Tüter, Emrah Çankaya, Ebru Sırma and Mutlu Bozkurtlar.

² Silistreli 1986: 136, The building in the square Y/5-6 on plan 2.

northern wall that it shares with its neighbor was partially destroyed (Ill.1)³. For the construction of the outer walls, broken stones in 10 x 20 x 8, 20 x 30 x 12 cm dimensions were used. The relatively smooth part of the stones were placed either looking out or in and the intervals were filled with small stone pieces. The material used for the construction of the walls are limestone and mud mortar as in the rest of Köşk Höyük. It is observed that the masonry is finer at the corners and the stones were considerably fixed into each other. The outer face is without plaster in three directions (east, south and west). However the fine plaster on the inner side were renewed many times and reached to 15 cm. thickness in some parts.

The entrance of the building is through the middle of the western wall. The door way narrowing toward inner part is 80 cm width. Threshold is 10 cm higher than the floor. It is also built of compacted soil and carefully plastered as the floor (Ill.2). A part having 1.5 m width in front of the doorway was intently smoothed in order to create a nice area before entering into the house. In this part, to northwest of the entrance, a small supporting wall having 54 cm width was connected to main wall of the building with a curved end. This wall connects to west wall of the neighboring structure which extends toward west more following the topography of the settlement (Plan.1).

The building consists of a main room and a store to northeast. At the inner face of the entrance, the wooden remains of the door frame, some of which were buried into the wall, were preserved. A mud plastered workshop having 20 cm height and 180 x 110 cm dimensions, starts by the one of the beams of above doorframe to north and extends parallel to the room wall. In a corner of the workshop is the tandır /pit oven of the house. The top and inner part of the tandır were destroyed together with the north wall (Ill. 1-2).

At the western wall of the room between door and room corner there is an oval niche of 80 x 40 cm dimensions built into the wall at 60 cm height from the floor. The inner part of the niche was also carefully plastered as the walls. In the southwestern corner, there is a clay-made partition in shape of box on the floor with 50 x 40 cm dimensions. Its top is partially covered

³ Cause of this destruction is the water pipe that was passed through here in order to transfer the water of sounding opened on the prehistoric mound by DSI (State Water Works).

(Ill.2). Within and on this partition, the horns of cattle and sheep/goats were piled up and an obsidian tool was left under these⁴.

Near center of room there is a hearth with 1.20 m diameter. The hearth was perforated by four holes with 20 cm diameter each bearing burnt wood remains (Ill.3). The wooden supports placed into these holes, which are relatively at same distance to the main walls, were used to carry the super structure. The bench which had an important function within the building leans on the storing partition to east and the main wall to south. The square shaped bench is 1.5 m long and 63 cm high (Ill.3-4). The corner was curved and the upper and lateral parts were carefully plastered. There is another niche (dimensions: 40x 25 cm) (presumably used as lamb base) built into the main wall as 1.09 m high from the bench (Ill.4). Irregular shaped, clay made three pot places in front of the bench, on and in front of the workshop are other features of the rooms.

The store/bin situated to east of the building was separated from the main room by means of a thin wall and silo (Ill.5). This wall (thickness: 25 cm) running parallel to the eastern wall was built of mud mortared small stones. This wall, extending until the same axis with the entrance of the building, was turned toward inside of the building and stopped with an curved end. From the remains uncovered in the part where it connects to main room, it is possible to assume that the original height of this thin wall was until the level of the niche over the bench and covered with a doomed ceiling super-structure (Ill.3-4). The preserved height of the room used as store is 2.30 m. The store was provided with two wooden supports situated respectively 60 cm and 1.80 m far from southeastern corner of the eastern wall. The coal-choral remains of the beams which were partially buried into the wall, were only preserved in parts near the floor (Ill.6). Just in front of these beams, two holes (with 20 cm diameter) were perforated into the thin wall at 1 m high from the floor. Many burnt wooden remains discovered in this area should have belonged to a wooden shelve probably tied into above mentioned holes from the beams. Some of the intact vessels uncovered in this area must have been put on such shelve. The dried mud remains with reed and wood impressions encountered above such vessels are denser to

⁴ %95 percent of the tools recovered in the building and all of the weapons were made of obsidian. The tools and weapons as well as core, blades and flakes shall be published by Deputy Associate Professor Doctor C. Ereğ.

north of the silo and should belong to ceiling structure. Under the above shelf and around the part near to the entrance many vessels were found in situ (Ill.5-6). The larger ones were leant against the wall. The bases of the pithoi were slightly buried into ground and the floor surrounding them was smoothed. The silo which makes the northern border of the store has an irregular oval shape. The silo with two compartments to south is smaller and completely made of mud. The northern compartment leaning on the wall is slightly higher. It was made quite thinner, the upper part was rounded and inner and outer surfaces were well plastered (Ill.5). A curious feature with three divisions, situated 20 cm higher than floor as adjacent to silo and northern wall of the room, are probably to place pot inside them.

The finds recovered in situ due to fire that it suffered, help us a lot to understand the functions of the households. The distribution of the finds within the building is as follows: a plate, a mother-goddess figurine and a ground stone on the workshop; a large plate, two jars, a vase, a tripod feet (oven feet), three burnishing stone; a bead piece, a vase, two ryhtons, a pin and an arrow head on the bench; two plates, two vases, a seal and three pins in front of the bench; a large bowl in front of the threshold; a bowl to north of the hearth; two vases and grinding stones before the silo; an arrow head within the largest division of the silo; an animal figurine in front of the store; two bowls, five vases, four pithoi, one mug, one small cup, one lid, two hearth legs, two awls, one stone bowl, one mortar pestle and grinding stone.

2nd Phase:

It has been understood that the room, which is located slightly in a higher elevation due to natural slope of the mound and was called as Room 1 simply because the excavation in 1995 had been first started in this point, was the part of the building that was used in the second phase of the structure (Ill.1,7; Plan.2). After the destruction of the first phase of the building by fire, a second phase building was built on the remains of the former one by reusing its eastern wall and the other ones in north and south directions in parts. For this new building, only an irregularly put up wall having 75-90 cm. width lying in west direction was a new element added in the same technique with the remaining walls (Ill.7). This wall extends until the pot places adjacent to the silo through the middle of the bench of the first phase. Thus, the new building was reduced to an area of 6.75 x 3.60 m. The entrance is from the west (Ill.7,8). However, it was slightly moved

towards south compared to one in the first phase. An area having 1.20 m width in front of the building entrance was smoothed in order to obtain a flat surface before the entrance. In this part, there is a hearth leaning on the outer wall of the building. Its bottom was paved with grinding stones (Ill.9).

In this period again, only the outer surface of the western wall, which bears the inner walls and the entrance, was plastered. The width of the door is 62 cm. The threshold is higher than the floor as it was in the preceding phase. A number of burnt wooden remains, uncovered within the building, should belong to ceiling. The plastered earth floor lying under 40-60 cm of the deposit of burnt woods had collapsed in places. There are two hearths in the building; one leaning on the eastern wall and other near the western wall in front of the former one (Ill.7). Of these, the western one was built of old and broken grinding stones. One in front of the eastern hearth and another next to the southern wall, two pot places were prepared. On the floor within the building, two bowls, one jar, eight vases, one pithos, one mug, one mother-goddess figurine, two spindle-whorls, three awls, two needles, two handles, one burnishing stone and a number of ground and grinding stones were discovered while a bowl and one grinding stone were found in the threshold and two jars and one bowl next to the heart outside of the building. Obsidian tools or arrow heads numbering between 2 and 5 were left either within or immediate outside of almost all pots.

The burnt wooden remains collected from both phases of the building were examined by P. I. Kuniholm and his team. Their works have indicated that at least 54 trees of oak and pine species, were used in the construction. Between the cutting years of the woods used in 1st and the 2nd phases, there is a time difference of 53 years. This suggests that the building was rebuilt by the same inhabitants after it was destroyed by fire 53 years after its original construction. During the new building process, some woods of the ex-building in good condition were re-used. The samples taken from the woods of the second phase, to which dendrochronological measurements were also applied, were dated via C 14 method. The date that dating method gives us is 4883±120 BC⁵. As a result of combination of these two dating method, it is possible to suggest 4890±120 BC for the 2nd phase and 4943± 120 for the 1st

⁵ Kuniholm 1998: 54; The revised radiocarbon and dendrochronological dates obtained while this article was submitted provide a date of 4911+102/-58 B.C. for Level I. Kuniholm - Newton 2002:275-276. Other dates should be revised accordingly.

building phase. This result indicates that Ist Building Level of Köşk Höyük belongs to Early Chalcolithic Period as relatively mentioned by U. Silistreli earlier.

I. POTTERY

The pottery recovered from both phases of this building at Köşk Höyük are enough in number and quality for a self-sufficient house. The pottery for daily-use ranging from storage pithoi to cooking pots, from middle size bowls to small cups, are in majority. In addition to these, there are also pots in the shape of animal (rython) or ones with double spouts which might have served for cult practices. Due to fact that if the sherds recovered from the levels were added to current evaluation, it would extremely enlarge the scope of the present article, here we could only mention their general characteristics and rather concentrated on the intact ones which are similar thereof.

The technique and shapes of the pottery are same in both phases. The majority is buff ware. This is followed respectively by brown, black, gray and red-tile colored ware. Lime and sand temper exist in all pottery. Beside these, mica and grit varying in size depending on the size of the related pottery were also tempered. Pottery, which is all hand-made, has usually thin wall. The small sized pots are very well fired. However the larger ones are more brittle due to their temper. The fact that the potters of Köşk Höyük could not control the fire properly, is obvious from the gray-black, brown-buff and red-purple variegation that can be observed on the inner and outer surfaces of various pots. In such examples there are principally black or dark gray core.

Almost half of the pottery were left in their paste color. A part of such pottery left in its original paste color was washed when they were unfired. Others have usually a thick slip in the same color with their paste color. A small number of pottery was slipped black at outer and buff at inner surface. The slipped ware is always well burnished and such pots had gained almost a metallic appearance.

In both phases, there isn't any painted piece. If a very few number of two pottery group with painted decoration that is known from other excavated sites and imported to Köşk Höyük is left aside, this is a general characteristic for the Ist level. However in both phases, a part of the ceramics

is relief decorated. Such decoration which is usually in the form of ox horn, was applied to various pots notwithstanding their sizes. Another decoration is eyebrow and eye motives applied on the handles of the large pithoi.

Majority of the ceramics are in shapes that are already well known from the 1st Level of Köşk Höyük. Still a few number of additional forms helps to enrich the pot assemblage. Straight, long necks are typical for all forms other than bowls. In many pots, the junction of the neck to the body was indicated by a thin groove. Majority of the pots have flat base, the middle of which were depressed. Sometimes the edge of such bases are consciously thickened in order to create almost a ring base. The horizontally or vertically attached handles have frequently oval section. Some of the horizontally attached strap handles were flatten at junctions to body and their ends were rounded (Ill. 24,27,44,47; Fig.8,20,23). This handle kind is typical for the Köşk Höyük Level I.

In the second phase, there are some interesting repairing traces. The method used for repairing can be best observed on one of the pithoi discovered in the store. Here, the cracks occurred during the usage are filled with pitch⁶ and are additionally supported by adhering shells on such filling (Ill.29b). The smaller pots such as bowl or vase were strengthen only by filling pitch. It is already known that pitch or bitumen have been used in production of various households since the Aceramic Neolithic Period in Anatolia⁷. It is relatively easy to think that the Köşk Höyük people used this material knowing its insulation characteristic. The nearest pitch/bitumen sources to the site are located in Çamardı (şeyl with bitumen) and Karaisalı just to south of former one (bitumen and asphalt)⁸. For the repairing, the material from either one of such sources should have been used.

POTTERY OF THE 1ST PHASE

1. Bowls: One of the most popular shapes of Köşk Höyük. The inner and outer surfaces are slipped and bright burnished. The bowls are separated into two groups as ones with and without handles.

⁶ The sample taken from the black colored material used as filling was examined in the laboratories of MTA Directorate. We thank Dr. Selami Toprak and Ergun Kaptan very much for their valuable contribution. The report that they submitted can be found in annex 1-2 hereto.

⁷ Rosenberg-Peasall 1998: 199, Fig. 7; Stein *et alii* 1998: 158 ff.

⁸ The related sources can be seen on the TPAO map prepared by Prof. Dr. İ. Akarsu.

a. Bowls without handles. They are separated into three groups depending on the body and base forms. First is the ones with round shoulder and body. This is the commonest type that can be seen in all sites through all periods. The bowls of the second group is distinguished from others with their pedestal-like high bases. Such pedestal was perforated through three holes locating at equal distances from each other. The same type bowls are also known from Early Chalcolithic of Hacılar and Kuruçay as well as Demircihöyük⁹. The third group of the bowls have slightly carinated shoulder located near base and flat base with hollow center and thick rim.

b. Bowls with handles. They are large pots having similar shape to first group of the bowls without handles. The nearest similar examples of such large bowls, which are amongst the new forms of Köşk Höyük, exist in Level XXIV of Yümüktepe while the examples for the smaller ones are known from Kuruçay Höyük¹⁰.

- Kş. 95.167 (Ill.10).

Height: 10, Mouth Diameter: 24.4, Base Diameter: 8 cm.

From over the workshop within the room.

The brown¹¹ paste (5 Y 4/2) is lime, calcareous and mica tempered. Inner and outer surface is black re-fired. Simple rim, round body and flat base.

- Kş.95.166 (Fig.1)

h.6.5, m.d.14.3, b.d. 2.8 cm.

From north of the hearth in the middle within the room.

The brown paste (5 Y 4/2) is lime, sand and mica tempered. Wet wiped. Half inner and outer surface is black re-fired. Simple rim, round body and slightly hollowed base.

- Kş.95.174 (Fig.2)

h.7, m.d.12.7, b.w. 12.4, b.d. 3.5 cm.

From in front of the bench within the room.

⁹ Mellaart 1970: 112, Fig.64/9, 90/33; Duru 1994a: 40,43,46, Lev. 108/21, 143/9, 164/7; Secher 1978: 90, Tafel 16/17

¹⁰ Garstang 1953: Fig.34; Duru 1994a: 41-42,A3, B3, Lev. 120/2, 122/5.

¹¹ The number of the mentioned color at Munsell 1975 were given in parenthesis.

Buff paste (10 YR 5/3) is abundantly sand, lime and mica tempered. The brown, black and gray variegated surface is wet wiped. Simple rim, slightly carinated shoulder locates near base, flat base with hollow center.

- Kş.96.48 (Ill.11)

h.4.9, w. 10.2, m.d. 10.6 cm.

From the store, the 4 numbered pot.

The black paste is fine sand tempered. The inner and outer surface are slipped and burnished. Simple rim, slightly everted and carinated shoulder and flat base with hollow center.

- Kş.95.165 (Fig.3)

h.6.2, m.d.13.5, b.d. 5.7 cm.

From northwestern corner of the bench within the room.

The black paste is lime, sand, mica and middle size girt tempered. Slipped and burnished in paste color. Simple rim, conical body, the conical base with three holes.

- Kş.95.60 (Ill.12)

h.7.5, m.d.17.5, b.d. 6 cm.

From the store, the 8 numbered pot.

The black paste is fine and middle size sand and lime tempered. Inner and outer surface are black slipped and bright burnished. Simple rim, conical body, the conical base with three holes.

- Kş.96.58 (Ill.13;Fig.4)

h.24, m.d.64, b.d. 11.5 cm.

From between the door and workshop of the room.

Buff paste (10 YR 5/4) is abundantly lime and sand tempered. The outer surface and only under the rim at the inner surface are black slipped and bright burnished. Simple rim, body narrowing toward base, base with hollow center. The double handle emerging under the rim and connecting to the shoulder has oval section.

- Kş.98.6 (Ill.14)

h.29, m.d.52, b.d. 11 cm.

From in front of the workshop in the room.

Dirty buff colored paste (10 YR 5/4) is sand and lime tempered. Slipped and burnished in paste color. Inner and outer surface is re-fired. Simple rim, round shoulder, flat base with hollow center and thickened rim. Handles connected right under the rim straightly have round section.

2. *Jar*: The only restorable jar that was recovered from the 1st phase building at Köşk Höyük is a cooking pot type with handles.

- Kş.96.59 (Ill.15; Fig.5)

h.22.5, m.d.27 cm.

From in front of the workshop in the room.

Buff colored paste (7.5 YR 5/4) is sand and lime tempered. Left in paste color, outer surface is gray-black variegated due to fire. Simple rim, round body and base. The vertical handles in opposition over the shoulder have oval section.

3. *Vase*: The vases which are one of the most popular forms of Köşk Höyük, have always vertical neck and round body. Both types with and without handles are known. All of the vases discovered within the house of the 1st phase are with handles. Of these, one is distinguished having a gazelle head decoration on its handle (Ill.16; Fig.6). The closest parallels for this vase other than unusual shape of the handle can be seen in Güvercinkayası¹². Another vase group represented by four examples, has four vertical handles divided in two separate groups tied close to each other and located in opposite sides (Ill.18-21; Fig.7-8). Other vases are types with double handles either tied horizontal or vertical. In two vases, there are relief decorations in the shape of horn emerging from the upper connection of the handle (Ill.24; Fig.10). The handles having the same sort of decoration are known from the Early Chalcolithic Period of Kuruçay¹³.

- Kş.95.175 (Ill.16; Fig.6)

h.13.5, m.d.12.2, b.w. 15 cm.

Felt in front of the workshop in the room.

Buff colored paste (10 YR 5/4) is lime, sand and mica tempered. Slipped and bright burnished in its paste color. More than half part was darken due to fire. Simple rim, cylindrical neck, a thin groove at the

¹² Gülçur 1999:61-62, Fig 23, 25/1

¹³ Duru 1994a: Lev. 197/2,4.

junction of neck and body, carinated body, slightly hollow base. The handle was made in shape of a gazelle head with neck emerging out of body plain and horns connecting to rims. Eyes on the head which was roughly shaped on the handle carination, were depicted with relieves. In opposite side of the handle, there are two nipple decorations on the body plain.

- Kş.97.7 (Ill.17)

h.22.1, m.d.14.2, b.w. 20.4 cm. b.d. 7.3 cm

From in front of the bench in the room.

Buff colored paste (7.5 YR 5/4) is lime and sand tempered. Black slipped and bright burnished. Simple rim, conical neck narrowing slightly downward, thin groove at the bottom of the neck, slightly hollowed flat base. Two connections of handles near each other under the rim were preserved. Probably this has also a handle in the shape of a gazelle as the former one.

- Kş.96.56 (Ill.18; Fig.7)

h.42.5, m.d.19.4, body/b.w. 34.2 cm.

Near silo in the room.

Dirty buff colored paste (10 YR 5/4) is lime and sand tempered. Outer surface is gray-black variegated, slipped and burnished. Simple rim, cylindrical neck, egg-form body is rough, flat base with hollow center. Four vertical handles with oval section on the belly width, handles were grouped in two located near to each other.

- Kş.98.2 (Ill.19)

h.44.6, m.d.19, b.w. 33.5 cm.

5 numbered pot from the store.

Dirty buff colored paste (10 YR 5/4) is lime and middle size girt tempered. Variegated slipped in its paste color and burnished. Outer surface was gray-black variegated due to fire. Simple rim, cylindrical neck, swollen body, flat base with hollow center. Four vertical handles with oval section on the belly width, handles were tied in two groups located near to each other.

- Kş.98.3 (Ill.20)

h.41.8, m.d.20.3, b.w. 35.5 cm.

7 numbered pot from store.

Light buff colored paste (7.5 YR 7/4) is fine sand and small grit tempered. Slipped in its paste color and burnished. Outer surface is gray-

black variegated due to fire. Simple rim, cylindrical neck, swollen body, flat base with hollow center. Junction of neck and body is grooved. Four vertical handles with oval section on the belly width, handles were grouped in two located near to each other.

- Kş.97.1 (Ill.21)

h.46, m.d.19.7, b.w. 35.5, b.d. 6.6 cm.

From in front of the workshop in the room.

Buff paste (5 YR 8/4) is lime and sand tempered. Slipped and bright burnished in its paste color. A great part was blacken due to fire. Simple rim, cylindrical neck, carinated belly, slightly hallowed flat base. Junction between neck and the body was indicated by a groove. The vertical handles located in opposite sides on the belly plain have oval section.

- Kş.98.4 (Ill.22)

h.41.5, m.d.23.7, b.w. 35.4 cm.

3 numbered pot from store.

Light buff colored paste (7.5 YR 7/4) is sand and lime tempered. Slipped and burnished in its paste color. Outer surface is grayed in places due to fire. Simple rim, cylindrical neck, swollen body, small flat base with hollow center. Junction of neck and body is grooved. The handles with oval section on the belly width are connected vertically. On the handles, there are relief decorations in the shape of horns curving toward the rim.

- Kş.96.54 (Fig.8)

Preserved h.24.5, b.w. 29 cm.

From in front of the bench in the room.

Buff paste (5 YR 6/4) is lime and sand tempered. Outer surface is black variegated, slipped and burnished. The upper part of the neck from beginning is broken. Swollen belly, flat base with hollow center. Handles are horizontally connected to belly plain. The junctions of these handles with the body are exaggeratedly flatten and the middle were carinated.

- Kş.98.5 (Ill.23)

h.44.6, m.d. 22.5, b.w. 42 cm.

11 numbered pot from the store.

Buff paste (10 YR 6/4) is lime and sand tempered. Slipped and burnished in paste color. Gray and black variegated due to fire. Simple rim,

neck narrowing slightly toward mouth, swollen belly, hallowed small flat base. Junction of neck to the body is grooved. Junction of the horizontal handle on the belly plain to the body is pressed.

- Kş.97.5 (Ill.24)

Preserved h.31.5, b.w. 33, b.d. 8.7 cm.

6 numbered pot from the store.

Buff paste (10 YR 7/3) is lime and sand tempered. Outer surface is black and dark gray variegated, slipped and burnished. Junction of neck to the body is grooved, swollen belly, small flat base. One of the horizontal handles with oval section on the belly plain was attached more vertically.

4. *Pithoi*: The pithoi having the shape of a large vase, exist in almost every house of Köşk Höyük. They vary in respect of relief decoration depicted on their handles in form of horn or eyebrow and eyes. The pottery having such decoration are widespread since Neolithic Period in Anatolia¹⁴.

- Kş.96.47 (Fig.9)

h.62, m.d.34, b.w. 52.5 cm.

From west of the silo in the room.

Brown paste (10 YR 5/3) is lime and sand tempered. Outer surface is buff, gray and black re-fired, changed color due to fire. Wet wiped. Simple rim, short cylindrical neck, rough egg-shaped body, slightly smoothed round base. There are four vertical handles group in two near to each other with oval section on the belly plain. The cracked vase was reused after repaired by bitumen.

- Kş.96.53 (Ill.25)

h.57.5 m.d.22 b.w. 40 cm.

From in front of the bench in the room.

Brown paste (7.5 YR 6/4) is lime and sand tempered. Outer surface is buff-black variegated, slipped and burnished. Simple rim, cylindrical neck slightly narrowing toward the rim, swollen belly, flat base. Junction between neck and the body was indicated by a groove. The vertical handles located in

¹⁴ Mellaart 1970: 106 ff., Fig 56/1,3; Alkım 1986:122-123. For the period and distribution areas of other parallels, please look ibid: 123, footnote 17-27; Gülçur *et al* 2000: 58, Çizim.2:2; 3:5; 4:1.

opposite sides on the belly plain have oval section. There is a decoration in the shape of horn on the upper connection of the handle.

- Kş.96.55 (Ill.26a,b; Fig.11)

h.52, m.d.31, b.w. 47.5 cm.

9 numbered pot from the store.

Buff paste (10 YR 5/3) is lime, sand and mica tempered. Outer surface is black slipped and burnished. Simple rim, vertical neck, swollen belly, round base. Decorated with two crescent motifs in relief emerging over the vertical handles with oval section on the belly plain. There are eyebrow and eye depictions like small bubbles on these decorations.

- Kş.97.13 (Ill.27)

Preserved h.57.6, b.d. 63, b.d. 10.7 cm.

10 numbered pot from the store.

Light buff paste (10 YR 7/3) is abundant sand and medium size grit tempered. Left in past color. Outer surface was wiped wet. A great part got blacken due to fire. Upper part of the neck is broken. Connection part of neck and body is deep grooved. Swollen body, round base, small base with hallow center. The end of the horizontally connected handles with oval section where they are attached to the pot were flatten and the sides were rounded. Two crescent motifs in relief, one tip of which are connected to the handles, are probably representing ox horns.

- Kş.97.14 (Ill.28)

Preserved h.73.2, b.w. 75 cm.

2 numbered pot from the store.

Light buff paste (10 YR 7/3) is sand and middle sized grit tempered. Slipped and burnished in paste color. Outer surface is gray-black variegated due to fire. The upper part is missing from bottom of the neck. Swollen body, pointed base. The handles vertically connected to belly plain have round section.

- Kş. 01.1 (Ill.29a,b)

h. 97, m.d.47.5, b.w. 80 cm.

1 numbered pot in the store.

Buff paste (10 YR 5/3) is sand and middle sized grit tempered. Outer surface is black slipped and bright burnished. Simple rim, short vertical

neck, swollen body and pointed base. The vertical handles on the belly plain have oval section. The cracks on the neck and the body were repaired by filling with bitumen. The part with bitumen was buffered by shell fragments (Please look at the reports in Annex 1-2).

5. Animal Shaped Pot: Two pots in the shape of turtle¹⁵ adds a new type to the repertoire of animal shaped pots hitherto known in Anatolia. They were made in a completely different understanding from the turtle shaped pots discovered in level VIII of Eridu in Mesopotamia (Dating to 3rd and 4th phases of Ubeid Period)¹⁶. The pots that seem to have been preserved on the bench of the house, have similar characters despite some differences in color and details. The upper part of the body which was formed naturally, is in shape of a vase with vertical neck. In the one, the head of which was preserved, the eyes are obsidian incrustated. The same application that can also be observed in various animal or human shaped pots as well as some figurines during Chalcolithic Period in Anatolia, should have been done to give a vigorous appearance¹⁷.

- Kş.96.50 (Ill.30; Fig.12)

h.11.6, w. 18.5 x 15.5 cm.

From over the bench.

The black paste is fine sand, mica and lime tempered. Outer surface is black slipped and bright burnished. Simple rim, short cylindrical neck, the junction between neck and body is indicated by a groove. The joint of the short, thick legs which were made together with the low oval body, were depicted in relief. The tortoise-shell is indicated in relief emerging out of the front legs and connecting to the neck. It has short neck and slightly pointed chin. The round eye cavities were worked in relief with obsidian pieces. The mouth is depicted as a small hollow. Throat is clearly indicated. The front left leg steps forward while the right one stays a little bit back. The rear right leg is ahead of the left one, clearly in order to give impression that it is walking. In harmony with such action of walking, the head of the animal leans toward left. Tail was depicted as a small relief on the bowl part of the pot. Inner part of the foot were left empty. The vertical handles in opposite

¹⁵ During the season 1990, a similar pot was recovered in fragments.

¹⁶ Safar *et alii* 1981: 156, Fig. 73, 82 9, 105.

¹⁷ Mellaart 1970: Pl.172, 176; Silistreli 1985:32-33, Resim. 7; Duru 1994a:189/3, 192/12, 194/2, 195/3.

directions connect the lower part of the rim with the body. They have oval section.

- Kş.96.51 (Ill.31; Fig.13)

h.10.1, w. 13.7 cm.

From over the bench.

The buff paste (10 YR 5/3) is fine sand, mica and lime tempered. Left in paste color and wet wiped. Simple rim, short cylindrical neck and suppressed oval body. Joints were clearly depicted in front and rear legs which were made close to each other. The head and the loop-handle on the rim over the head are broken. The tail is represented by a small relief between the rear legs. As in the previous example, the joint parts of the opposite handles were preserved.

6. *Mug*: Of the rarely known mugs in Köşk Höyük , just one example was recovered in this house.

- Kş.96.49 (Ill.32; Fig.14)

h.11.4, m. d. 9, w. 11 cm.

From the store.

The buff paste (10 YR 7/4) is lime and sand tempered. Left in paste color and wet wiped. The inner and outer surface were red, gray and black re-fired due to fire. Simple rim, short cylindrical neck and round body. The rough base was slightly hallowed toward inside. The handle which connects the lower part of the rim to shoulder plain, has oval section.

7. *Cup*: The only cup that recovered is very small sized and roughly shaped.

- Kş.96.39 (Fig.15)

h.3.8, m. d. 3.8 cm.

From the store.

The buff paste (10 YR 5/3) is lime, sand and mica tempered. Left in paste color. Simple rim, irregular round body and pointed base. The rim was thinned by pressing from outside. The handle on the shoulder plain is broken.

8. *Lid*: This is a new type to add to various known lid shapes of Köşk Höyük. However this is in miniature dimensions. Parallels can be seen in Kuruçay Höyük, Höyücek and Güvercinkayası¹⁸.

- Kş.96.36 (Fig.16)

h.2,7, w. 6.5 cm.

From the store amongst the pithoi.

The black paste is fine sand and mica tempered. Gray-black variegated, slipped and burnished. The part that sits on the pot was rounded. It is in shape of a conical bowl with hallowed center. There is a curving hole a top.

9. *Pot Stand*: The three rough, bowl-like pots uncovered in the store of the house have a wide base which is unfamiliar in other ceramics of Köşk Höyük. We suggest that these bowls were used for the transportation of the vase with globular body and round base and other pithoi that were found together with them.

- Kş.96.40 (Fig.17)

h.15, m.d. 26 cm.

From the store, next to the bottom of the 10 numbered pot.

The reddish brown paste (10 YR 7/4) is medium size grit, sand and lime tempered. Left in paste color. The inner and outer face is re-fired. Simple rim, conical body narrowing slightly toward large and flat base.

- Kş.96.41

h.14.5, m.d. 25.5 cm.

From the store.

The reddish brown paste (10 YR 7/4) is medium size grit, sand and lime tempered. Left in paste color. The inner and outer face is re-fired. Simple rim, conical body narrowing slightly toward large and flat base. The rim is damaged.

- Kş.96.42 (Ill.33)

h.16, m.d. 28.5 cm.

From the store.

¹⁸ Duru 1992: 558, Lev.23/3; Duru 1994a: 20, Lev. 56/3, 98/5 (Late Neolithic); Gülçur 1999:62, Fig. 23/3; the pot that was defined as funnel.

The brown paste (7.5 YR 6/4) is medium size grit, sand and lime tempered. Left in paste color. The inner and outer face is re-fired and darkened. Simple rim, conical body narrowing slightly towards large and flat base. The rim is damaged.

10. *Andirons*: The andirons recovered from the room and the store of the building have two types.

a. The first type feet have flat base, one end of which are pointed in the shape of a horn. At the slightly rounded back part, there is a handle or hole.

- Kş.95.176 (Ill.34; Fig.18)

h.26, w. 26.5, th. 17.5 cm.

From in front of the workshop in the room.

The buff paste (10 YR 7/4) is medium size grit and sand tempered. Left in paste color. Re-fired in places. The part on which the pots would sit are in shape of pointed horns. The base is in shape of triangle with rounded corners. The hole perforated near the corner corresponding to outer part of the foot, ends in immediate upper part of the base.

- Kş.95.46 (Ill.35)

h.20, w. 32, th. 12 cm.

In the store, leaning against the 1 numbered pithos.

The brown paste (7.5 YR 6/4) is lime and sand tempered. Left in paste color. Outer surface is re-fired in places. Two tips were relieved in shape of horn. There is a horizontal loop-handle in the middle of the slightly swollen outer surface. The inner face and the bottom are flat.

b. The second type pedestal has roughly shaped cylindrical form. The upper part is slightly hollowed.

- Kş.96.45 (Ill.36)

Preserved h.12.5, w.10.3

In the store, from the east of silo.

The buff paste (10 YR 7/4) is abundantly lime and sand tempered. Left in paste color. Irregular cylindrical shaped. The bottom is flat, the upper part is slightly hollowed.

POTTERY OF THE 2ND PHASE

1. Bowls: Represented by the bowls with and without handles of the previous phase.

- Kş. 97.11 (Ill.37)

h. 15.2, m.d. 37, b.d. 10.6 cm.

From next to the hearth out of the building.

Dirty buff paste (7.5 YR 6/4) is sand tempered. Left in paste color. The inner and outer surface were black re-fired. Simple rim, round body and slightly hallowed flat base. The crack in the rim was filled with bitumen in time.

- Kş. 97.12 (Ill.38)

h. 14.5, m.d. 32.2, b.d. 8.1 cm.

From the room.

Light buff paste (10 YR 6/2) is sand tempered. Left in paste color. Slipped and burnished. The outer surface was re-fired in places. Simple rim, round body and slightly hallowed high flat base.

- Kş. 97.9 (Ill.39)

h. 17.4, m.d. 43.4, b.d. 12 cm.

From threshold of the room.

Reddish brown paste (2.5 YR 5/6) is sand, lime and small grit tempered. Slipped in paste color, the outer surface is burnished. The outer and inner surface were brown and black re-fired. Simple rim, round body and slightly hallowed flat base. The handles with oval section connecting the lower part of the rim to shoulder were attached vertically. Cracks were filled with bitumen and fragments of shells were adhered on these parts.

- Kş. 97.10 (Ill.40)

h. 15.1, m.d. 43, b.d. 10.4 cm.

From the room.

Buff (10 YR 6/4) is sand tempered. Left in paste color. The outer and inner surfaces were brown and black re-fired. Simple rim, round body and slightly hallowed flat base. The handles with oval section connecting the lower part of the rim to shoulder were attached vertically. Both sides of one of the handles and body that cracked in time of original usage were repaired with bitumen filling .

2. *Jars*: Represented by types with or without handles. In the ones without handle, there is a horn decoration in relief on the belly plain. The closest parallels for this type can be found in the Late Neolithic layer of Can Hasan¹⁹. Decoration in one of the jars has been enriched by a rectangular relief located between the horns.

- Kş.95.171 (Ill.41; Fig.19)

h. 21, m.d. 26.5, w. 30.5 cm.

In the room, the 8th pot.

Buff colored paste (7.5 YR 5/4) is lime, mica and small grit tempered. Left in paste color, outer surface is gray-black and buff variegated. Simple rim, carinated shoulder and hallowed flat based. A couple of ox horns in relief were depicted as decoration in opposite locations on the shoulder carination.

- Kş.97.6 (Ill.42)

h. 21, m.d. 26.5, w. 30.5 cm.

Next to the hearth out of the building.

Buff colored paste (7.5 YR 5/4) is lime, sand and small grit tempered. Slipped and burnished in paste color. Outer surface is gray-black variegated. Simple rim, carinated shoulder and high hallowed flat based. A couple of ox horns in relief were depicted as decoration in opposite locations on the shoulder carination. Between these decorations, a rectangular relief extending from lower part of the rim down to shoulder was put.

- Kş.95.169 (Ill.43)

h. 21, m.d. 26.5, w. 30.5 cm.

Next to the hearth out of the building.

Dark gray paste (10 YR 4/1) is lime and sand tempered. Left in paste color. Outer surface is gray-black variegated. Simple rim, short necked, carinated belly, and hallowed flat based. The handles with round section, connecting the lower part of the rim to the shoulder were tied vertically.

3. *Vases*: The vases which vary from 9.7 to 50 cm height as in the 1st Phase, are represented by the examples with or without handles. A vase having two mouth emerging from the same body, represent a new form for

¹⁹ French 1968: 52, Fig.5.

Köşk Höyük. Even though not in exact form, some similar pots with double mouths are known from the Late Chalcolithic of Kuruçay²⁰.

- Kş.95.172 (Ill.44; Fig.20)

h. 27.5, m.d. 10.3, b.w. 26 cm.

1st pot in the room.

Brown paste (7.5 YR 6/4) is lime and sand tempered. Slipped and burnished in the same color. Outer surface is gray-black variegated due to fire. Simple rim, cylindrical neck, swollen belly, hallowed flat based. The necks were attached to each other by means of a thin groove on the narrowing upper part of the belly. The oval sectioned handles were horizontally attached next to the necks on the belly width. The part of the handles connected to the body were flatten and rounded.

- Kş.95.164 (Ill.45; Fig.21)

h. 9.7, m.d. 7.5, b.w. 10, b.d. 3.8 cm.

9th pot in the room.

Black paste is lime and mica tempered. Black slipped and bright burnished. Simple rim, conical neck slightly narrowing downward. There is a thin groove at the bottom of the neck. Carinated belly, slightly depressed flat base. Horns in relief were depicted in opposite directions on the belly carination.

- Kş.95.168 (Ill.46; Fig.22)

h. 12.8, m.d. 10.2, b.w. 13 cm.

7th pot in the room.

Gray paste (5 YR 7/2) is lime, sand and mica tempered. Slipped and burnished in paste color. Simple rim, vertical neck. There is a thin groove at the bottom of the neck. Round belly, slightly depressed flat base. The loop-handles located in opposite directions on the belly carination were horizontally connected. Horns in relief were depicted in opposite directions on the belly carination between the handles.

- Kş.97.2 (Ill.47)

h. 40, m.d. 20, b.w. 32, b.w. 8.2 cm.

2nd pot in the room.

²⁰ Duru 1983: 28, Lev.20/16, 27/3; Umurtak 1996: 491, 496 ff.

Dark brown paste (7.5 YR 5/6) is lime and sand tempered. Black slipped and bright burnished. Simple rim, cylindrical neck. There is a thin groove at the bottom of the neck. Round belly, slightly depressed flat base. There is a horn decoration in relief, curving upward next to the horizontally connected handles on the belly carination.

- Kş.97.3 (Ill.48)

h. 38.5, m.d. 23.2, b.w. 31.3, b.d. 8.5 cm.

5th pot in the room.

Buff paste (7.5 YR 5/4) is lime and sand tempered. Slipped and burnished in paste color. Black and gray variegated due to fire. Simple rim, cylindrical neck. There is a thin groove at the bottom of the neck. Round belly, slightly depressed flat base. There is a horn decoration in relief curving upward next to the horizontally connected handles on the belly carination.

- Kş.95.173 (Fig.23)

h. 50, m.d. 28, b.w. 40 cm.

4th pot in the room.

Buff paste (7.5 YR 5/4) is mica, sand and medium size grit tempered. Black slipped and bright burnished. Simple rim, cylindrical neck. There is a thin groove at the bottom of the neck. Round belly and flat base. The horizontal handles on the belly carination were bound by flattening.

- Kş.97.4 (Ill.49)

h. 37.3, m.d. 26.4, b.w. 3, b.d. 7.7 cm.

3rd pot in the room.

Dark brown paste (7.5 YR 5/6) is sand and medium size grit tempered. Black slipped and bright burnished. Simple rim, cylindrical neck. There is a thin groove at the bottom of the neck. Round belly and slightly depressed flat base. The horizontal handles on the belly carination were bound by flattening.

- Kş.98.1 (Ill.50)

h. 34, m.d. 20.5, b.w. 32.3, b.d. 7.5 cm.

From the room.

Buff paste (7.5 YR 5/4) is sand, lime and medium size grit tempered. Slipped and burnished in paste color. Simple rim, cylindrical neck. There is

a thin groove at the bottom of the neck. Round belly and slightly depressed flat base. The oval sectioned handles on the belly carination were vertically bound. Eye decorations consisting of eye-brows in relief in both sides with dots within each curve were depicted over the handles.

4. *Pithos*: The only pithos recovered in this phase is one of the biggest artifacts of Köşk Höyük.

- Kş.95.15 (Ill.51; Fig.24)

h. 105, m.d. 47.5, b.w. 80 cm.

6th pot next to the eastern wall in front of the door in the room.

Dirty buff paste (10 YR 7/4) is lime, sand and medium size grit tempered. Outer surface is buff slipped and burnished. Black and gray variegated in places due to fire. Simple rim, cylindrical neck with slightly concave rim. The egg-shaped body is asymmetric. Pointed base. The vertical handles in opposite directions on the shoulder plain have oval section.

5. *Mug*: The only mug of the house is identical of the others found in previous phase.

- Kş.97.8 (Ill.52)

h. 14.7, m.d. 10, b.w. 15.3, b.d. 5.5 cm.

From the room.

Brown paste (10 YR 5/3) is lime and sand tempered. Slipped in paste color and bright burnished. Black variegated due to fire. Simple rim, short cylindrical neck, swollen belly and slightly depressed flat base. Junction between the body and the neck is expressed by a thin groove. The handle binding the lower part of the rim to belly width has oval section.

II. SMALL FINDS

The small finds were made of terra-cotta, bone and stone in both phases. To these, the shells in the first phase and other small finds made of horn in the second were added.

1ST PHASE

1. *Terra-cotta/Baked clay finds*:

Various human and animal figurines and a seal are the terra-cotta finds of this phase.

A. Goddess Figurine:

The only human figurine is a seated goddess, left on the bench during the first phase of the building. The exaggeration in hips and upper part of the legs and sitting position giving the weight of body on one leg has similarities with the figurine found in Level II at Köşk Höyük and several examples from Höyücek²¹. On the other hand, it still differs from others having more stylistic form. Such stylization has been maintained by not defining the arms, leaving the shoulder and head blunt as well as unexaggerated depiction of belly and breasts.

-Kş.95.39 (Ill.53a,b;Fig.25)
 preserved h. 2.3, w. 2.5, th. 2.2 cm
 From over the bench in the room.

The dark gray paste is lime and mica tempered. Left in paste color. Head is missing by the neck. Having broad shoulder, the arms were not depicted. Shoulder tips were left blunt. Sitting on knees giving the weight of body over right side. The belly, leg, hip and waist contours were defined. Bottom is slightly depressed.

B. Animal Figurine:

The animal figurines are represented by a few examples in Köşk Höyük. It is difficult to define their species due to their rough shape. The figurine that was uncovered in this building, can be defined as a goat with its broken horns, short and vertical tail and a kind of beard. If the fact that many goat horns were stored within a clay box in the southwestern corner of the room in the same building is taken into consideration, it might be possible to suggest that this figurine was a votive object left consciously.

Kş.96.38 (Fig.26)
 Preserved h. 4.5, l. 5.4, w. 2.7 cm
 In front of the silo in the entrance of the store.

The buff colored paste (5 YR 6/4) is medium sized sand and grit tempered. Left in paste color. The horns are broken, eyes were depicted in different heights, the holes in the long nose were made as dots. Mouth is

²¹ Silistrelı 1989: 498-499, Lev. II, 3-4; Duru 1994b: 733, 740, Lev.24, 33/2.

depicted with a line. The beard is defined. Tail is small and blunt. Stout body, of the short and blunt feet only the front right one was preserved.

C. Stamp Seal:

The only example recovered in this house had been studied in detail together with other seals of Köşk Höyük by S. Özkan²². It has common features with other seals found in Level II and III of Köşk Höyük.

Kş.95.74 (Ill.54)

h. 1.7, d. 1.8 cm

In front of the bench in the room.

Conical shaped, the top is rounded. The upper part of the horizontal string hole which covers almost half of the body, is broken. The space between the arms of cross on the circular sealing face was filled by parallel lines.

2. Bone Objects

Totally six pins that can be categorized as borer, were discovered in the house. All were made of sheep or goat bones. Technically they do not differ from other examples found during the early excavations at Köşk Höyük, which had been studied by S. Özkan in detail²³. Current examples are identical of the Ib-d types of Özkan's categorization.

-Kş. 95.2 (Fig. 27)

Preserved l. 6.2, w. 0.9 cm

From the room.

A bone was broken in the middle and one end was pointed.

-Kş. 95.72 (Fig. 28)

l. 5.9, w.1.6 cm

From the room.

One end of a bone was cut and pointed toward the end.

-Kş. 95.73 (Fig. 29)

l. 4.2, w. 1 cm

From the room.

²² Özkan 2001: 18-19, Kş.95-74.

²³ Özkan 2002: 510-511, Fig. 1-11.

One end of a bone was cut and pointed toward the end.

-Kş. 95.104 (Fig. 30)

Preserved l. 8.7, w. 1 cm

Over the bench in the room.

A bone was cut in the middle and one end was pointed.

-Kş. 96.10 (Fig. 31)

l. 9.5, w. 1.6 cm

From the store.

One end of a bone was cut and pointed toward the end.

-Kş. 96.11 (Fig.32)

Preserved l. 9.7, w. 2.2 cm

From the store.

One end of a bone was cut and pointed toward the end.

3. An Object made of shell:

The only find in this group is a bead.

-Kş. 96.16 (Fig. 33)

1.1 x 0.1 cm.

On the bench in the room.

Made of shell, rounded like a button, the center was perforated.

4. Stone Objects:

The stone objects made of various stone types, are represented by stone bowl, finishing stone, mortars and grinding stones.

A. Stone Bowl:

The basalt bowl found amongst the pithoi in the store, was roughly shaped. It is not different from any stone bowl being used since Aceramic Neolithic period.

-Kş.96.44 (Ill.55; Fig.34)

h. 4, Mouth d. 8.9, Base d. 5.7 cm.

The 12 numbered bowl amongst the 1st and 2nd numbered pithoi in the store.

The rim was rounded. The body was roughly shaped. Base is irregular and flat. Inside was hallowed in form of a shallow bowl.

B. Polishing Stones:

These stones that should have been used to polish the tools, have various shapes. There are three examples made of sandstone and green colored river-stone.

-Kş. 95.29 (Ill.56)

h. 6.3, w. 3.1, th. 1.6 cm.

In front of the workshop in the room.

In form of a rectangular prism. The bottom was corroded unjustly due to rubbing. A handle was made in the middle of the upper part.

Kş. 95.30 (Ill.57)

4.5 x 4.6 x 3.2 cm.

From the room.

In the shape of a trapezoid prism. The corners were rounded. The four sides are shining due to utilization.

Kş. 95.31 (Ill.58)

8.1 x 3.7 x 2.7 cm.

From the room.

Irregular shape, both ends were rounded.

C. Mortar :

The only mortar in basalt so far discovered was slightly worked in one end to make a handle for its purposes. The beating face is slightly curved.

Kş. 96.43 (Ill.59)

h. 18, w. 7.5 cm.

From the store.

Cylindrical body with slightly conical upper end. The Oval shaped beating face became flat due to over-use.

D. Grinding and Rubbing Stones:

Of the total 5 grinding stones, made of gray and white porous sandstone, one was found on the workshop, three between the tandır and silo and one in northern part of the store. They are in dimensions varying

from 58 x 25 x 22 to 31 x 18 x 14 cm. Two small ones with flatter and more oval usage surface should have been used as upper part while the larger and more concave ones were used as lower part.

2nd PHASE:

1. Terracotta Objects:

The terracotta objects of this phase are one goddess figurine and spindle-whorls.

A. Goddess Figurine:

This was made in a quite different style than other known figurines of Köşk Höyük. It has a rather schematic appearance with its bell-shaped body, just one arm depicted as small relief and other works of nose, mouth and eye. However its conical cap and work of face details are similar to the figurine discovered in the Level I of Köşk Höyük²⁴.

- Kş. 95.25 (Ill.60; Fig.35)

h. 2.7, w. 1.6 cm.

Next to the jar with double neck (1st pot) in the southeastern corner of the room.

The dark gray paste, slipped in paste color. The conical cap is leaning back. The part covering the head was defined on the forehead. The eyebrows in shape of bow depicted in relief were connected with the nose and divided the face into two parts. The middle/pupil of the eyes which were depicted as circular relieves, are hollow. The circular mouth is represented by a hollow. Short neck and conical body. The bottom part was left rough. The left arm was depicted as a small projection in the upper part of the body.

B. Spindle Whorls:

Of the two recovered spindle whorls, one was made of sherd. Both have suppressed, cylindrical shape.

- Kş. 95.23 (Fig.36)

h. 1.1, d. 4.1, Hole d. 0.9 cm.

From the room.

²⁴ Silistreli 1991: 96, Resim. 3.

The dirty buff (10 YR 6/4) paste is lime, sand and mica tempered. Left in paste color. The surface became grayish due to fire. Irregular cylindrical shape.

- Kş. 95.24 (Fig.37)

h. 0.7, d. 4.1, Hole d. 0.7 cm.

From the room.

The dark gray (10 YR 4/1) paste is fine sand and mica tempered. Re-made of a sherd, the inner and outer surfaces of which are reddish brown (7.5 YR 6/4) slipped. The edges were rounded and smoothed.

2. Bone Objects:

The bone objects of this phase consist of pin and needles, the two types of borers. The techniques and shapes are not different from the previous phase.

A. Pins:

They are represented by three examples in Özkan I c and d type²⁵ all were also seen in the previous phase.

- Kş. 95.1 (Fig.38)

Preserved h. 5.3, w. 1.2 cm.

From the room.

One end of the bone was cut and pointed toward the tip.

-Kş. 95.36 (Fig.39)

h. 7.9, w. 2.4 cm.

From the room.

One end of the bone was cut and pointed toward the tip.

- Kş. 95.7 (Fig.40)

Preserved h. 4, w. 0.5 cm.

From the room.

Bone was cut in the middle and one end pointed.

²⁵ Özkan 2002: 511, Fig. 6-9.

B. Needles:

These are borers with two pointed ends.

- Kş. 95.4 (Fig.41)

Preserved h. 7.4, w. 1.7 cm.

From the room.

Bone was cut in the middle and one end pointed while the other was rounded and smoothed.

- Kş. 95.6 (Fig.42)

Preserved h. 7.2, w. 0.5 cm.

From the room.

Bone was cut in the middle and one end pointed. Other end is broken away.

2. Objects made of horn:

There are two handles that can be categorized in this group. Both are pieces cut from the horn, somewhere near the tip. The outer surfaces of the beds carved in each end are to fit the tools inside the handles²⁶.

- Kş. 95.26 (Ill.61)

l. 5, th. 1.5-1 cm.

From the room.

Both ends of a horn were cut and beds/bearings were carved in each tip, one is 1.7 other 0.7 cm. depth. Cracked.

- Kş. 95.27 (Ill.62)

l. 7.5, th. 1.8-1.3 cm.

From the room.

Both ends of a horn were cut and beds/bearings were carved in each tip, one is 2.5 other 1.8 cm. depth. Broader end is damaged.

4. Stone Objects:

The stone objects of this phase consist of one polishing stone and a number of rubbing and grinding stones.

²⁶ Özkan 2002: 515, Fig. 26.

A. Polishing Stone:

- Kş. 95.33 (Ill.63)

l. 8.8, w. 5, th. 3.3 cm.

From the room.

Irregular in shape, one edge is flat, other is convex. The side surfaces are bright due to over-use.

B. Rubbing and Grinding Stones:

Quite similar of the examples from previous phase.

ANNEX: 1

Three materials that were deemed to be organic in origin, found in Köşk Höyük excavations, were submitted to MTA Museum of Natural History to be studied.

Dimensions: 3.4 x 0.4 cm., 1.0 x 0.5 cm., 1.4 x 0.5 cm.

The materials, which were first macroscopically observed, are mat black colored, dry, fragile and hard residues. On these, some fragments of shells belonging to mollusca were detected. These were proven to be pelesipod shells by the paleontologists.

The three main material were understood to be a residue in type of asphalt made of heavy raw petrol/oil (Annex 2).

24th February 1998

Ergun Kaptan

General Directorate of MTA
Museum Natural History, ANKARA

As a result of the petrographical and micro-chemical analysis, it has been determined that the organic material in subject is a petrol/oil (asphalt type) originated material in general. There are also a small quantity of charcoal fragments where plant tissues can be observed (approximately in 5-60 micron size) within the sample.

23rd January 1998

Geology Senior Engineer Dr. Selami Toprak
General Directorate of MTA, Department of MAT
Organic Petrography Specialist.



Res. 1/Fig. 1



Res. 2/Fig. 2



Res. 3/ Fig. 3



Res. 4/ Fig. 4



Res. 5/ Fig. 5



Res. 6/ Fig. 6

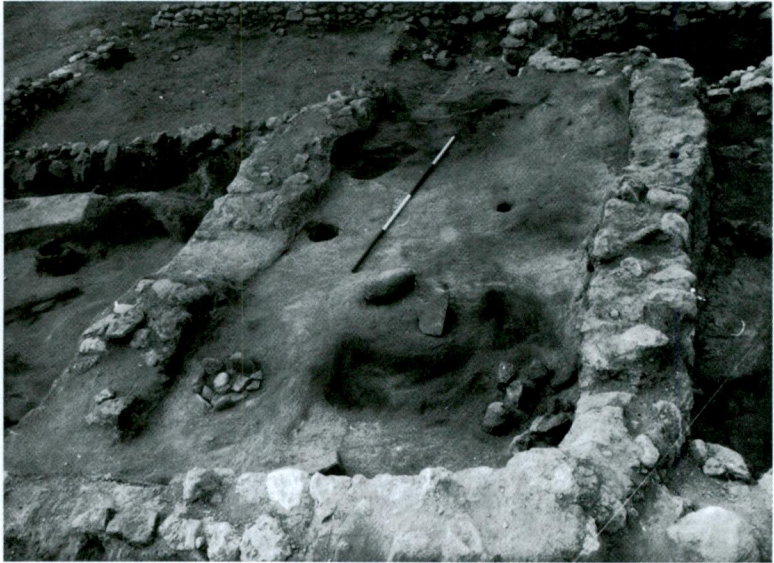

Res. 7/ Fig. 7



Res. 8/ Fig. 8



Res. 9/Fig. 9



Res. 10/Fig. 10

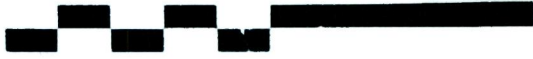
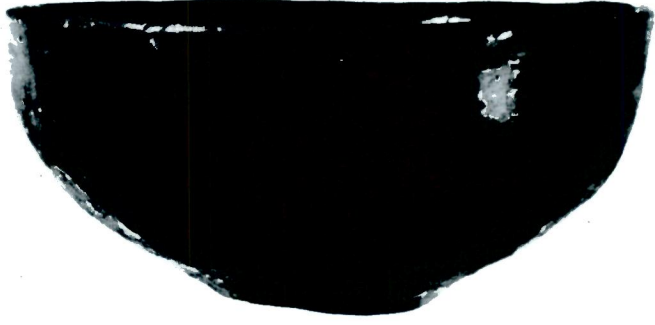

Res. 11/Fig. 11



Res. 12/Fig. 12



Res. 13/Fig. 13

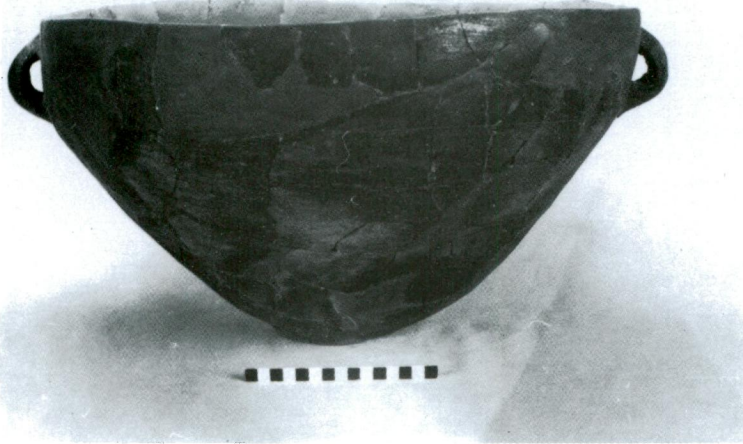

Res. 14/Fig. 14



Res. 15/Fig. 15



Res. 16/Fig. 16



Res. 17/Fig. 17



Res. 18/Fig. 18



Res. 19/Fig. 19



Res. 20/Fig. 20

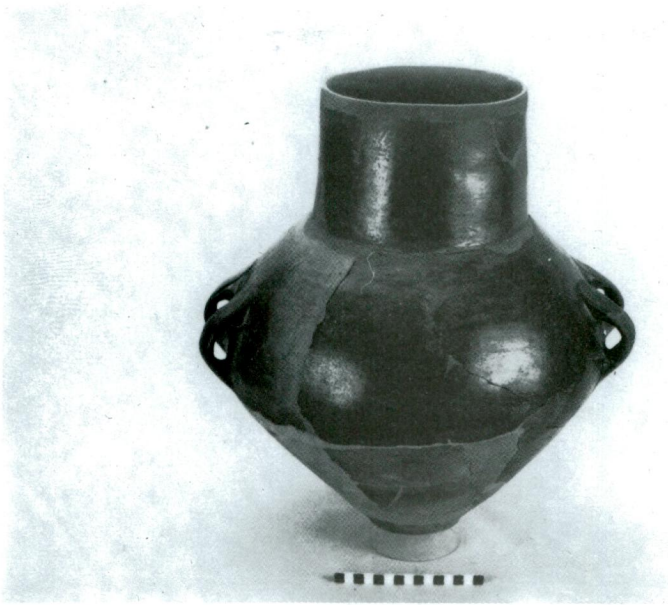

Res. 21/ Fig. 21



Res. 22/ Fig. 22



Res. 23/Fig. 23



Res. 24/Fig. 24

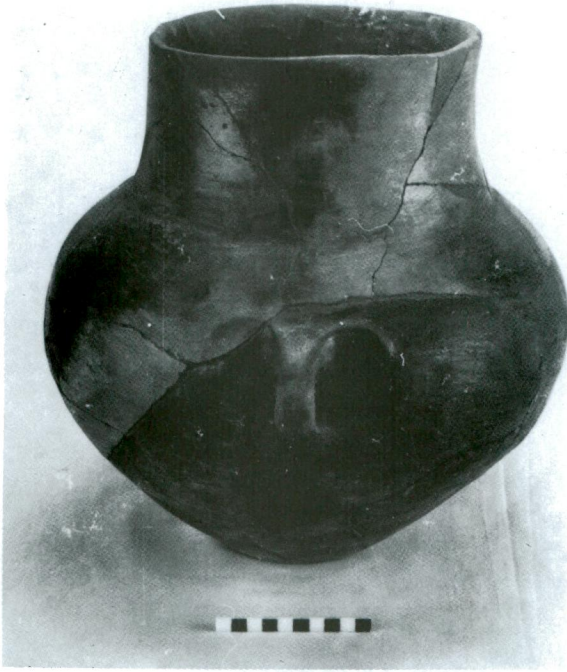

Res. 25/Fig. 25



Res. 27/Fig. 27



Res. 26a/ Fig. 26a



Res. 26b/ Fig. 26b



Res. 28/Fig. 28



Res. 29a/Fig. 29a



Res. 29b/ Fig. 29b



Res. 30/ Fig. 30



Res. 31/Fig. 31



Res. 32/Fig. 32



Res. 33/Fig. 33

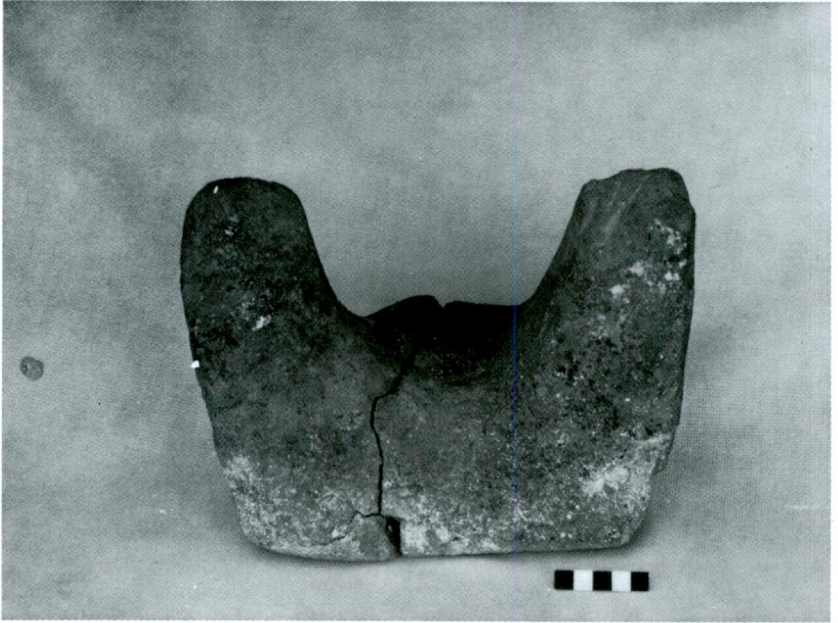

Res. 34/Fig. 34

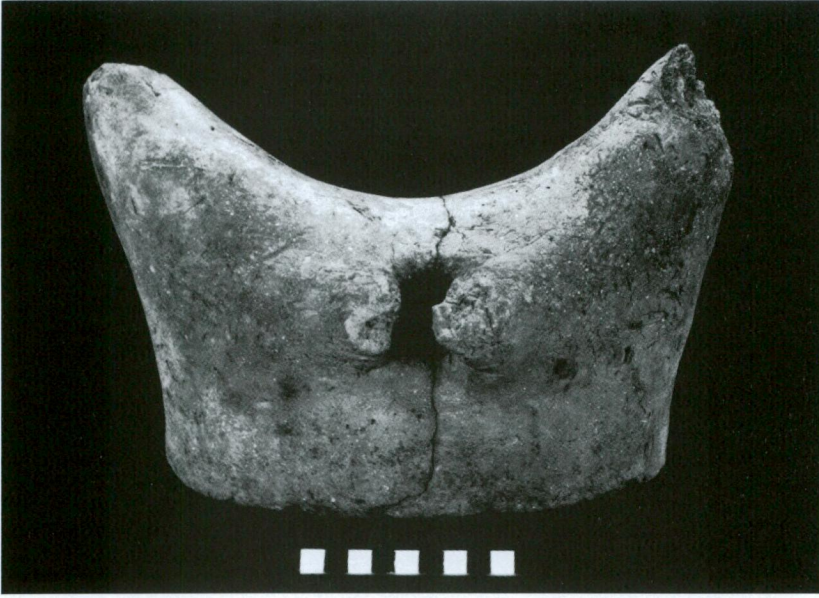

Res. 35/ Fig. 35

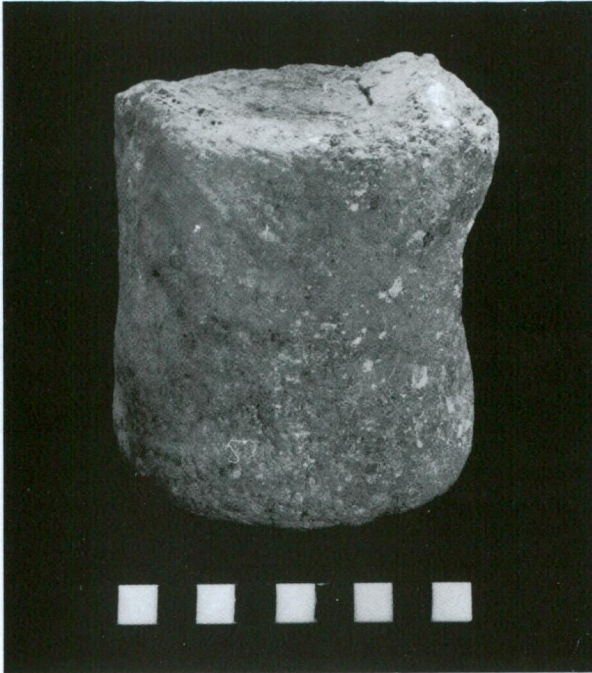

Res. 36/ Fig. 36



Res. 37/Fig. 37



Res. 38/Fig. 38



Res. 39/ Fig. 39



Res. 40/ Fig. 40



Res. 41/Fig. 41



Res. 42/Fig. 42



Res. 43/ Fig. 43



Res. 44/ Fig. 44

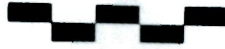

Res. 45/Fig. 45

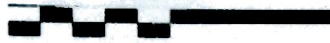
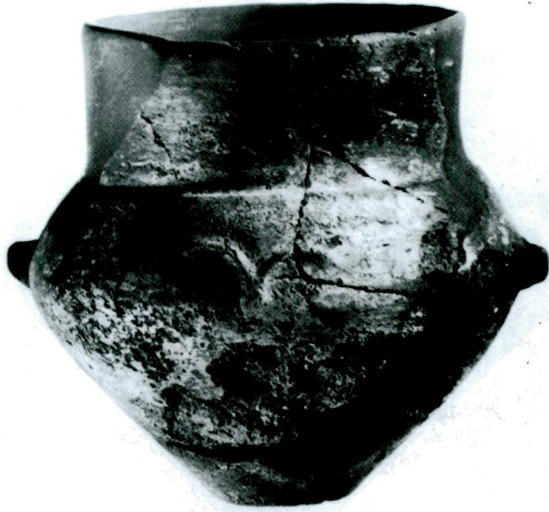

Res. 46/Fig. 46



Res. 47/ Fig. 47



Res. 48/ Fig. 48

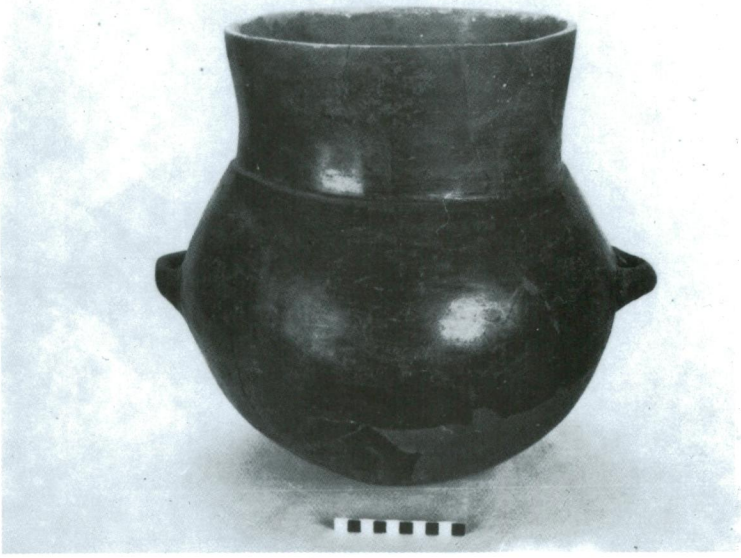

Res. 49/Fig. 49



Res. 50/Fig. 50

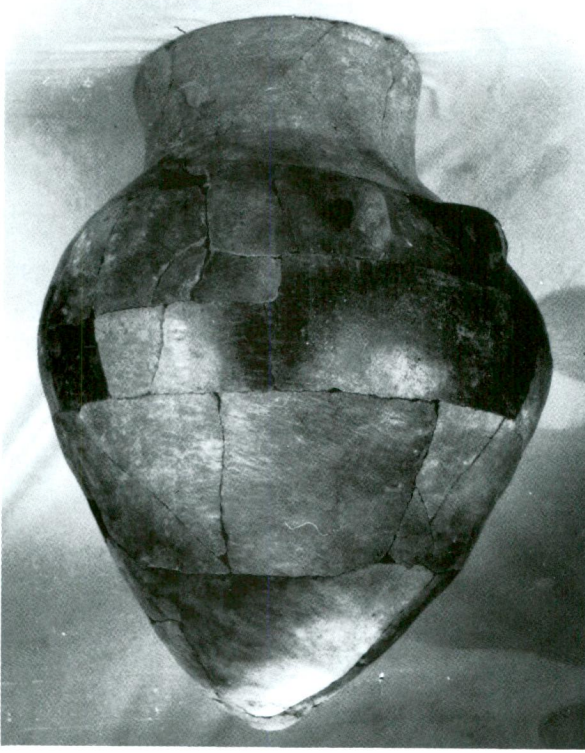

Res. 51/Fig. 51



Res. 52/Fig. 52

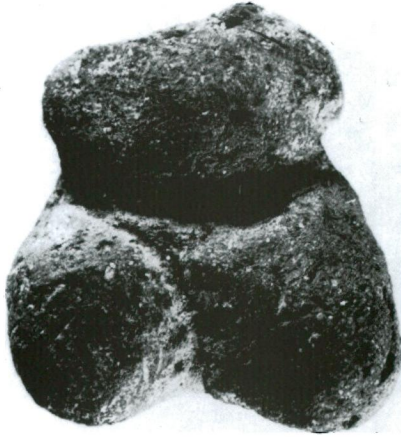

Res. 53a/Fig. 53a



Res. 53b/Fig. 53b

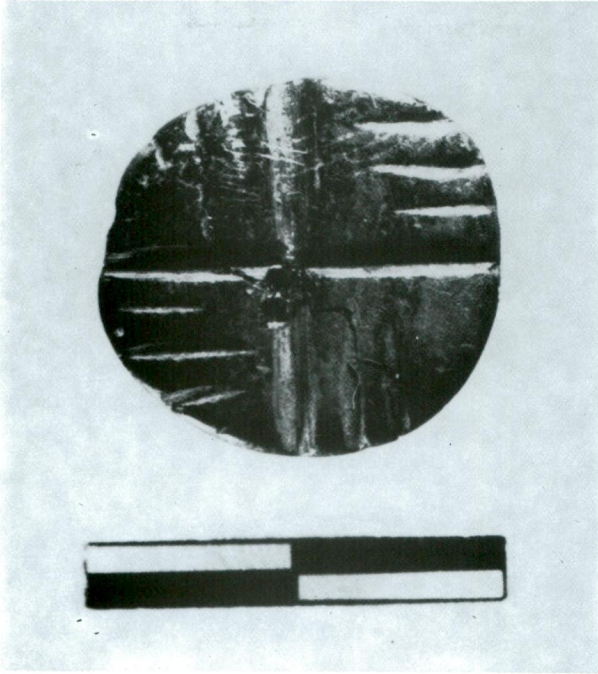

Res. 54/Fig. 54



Res. 55/Fig. 55

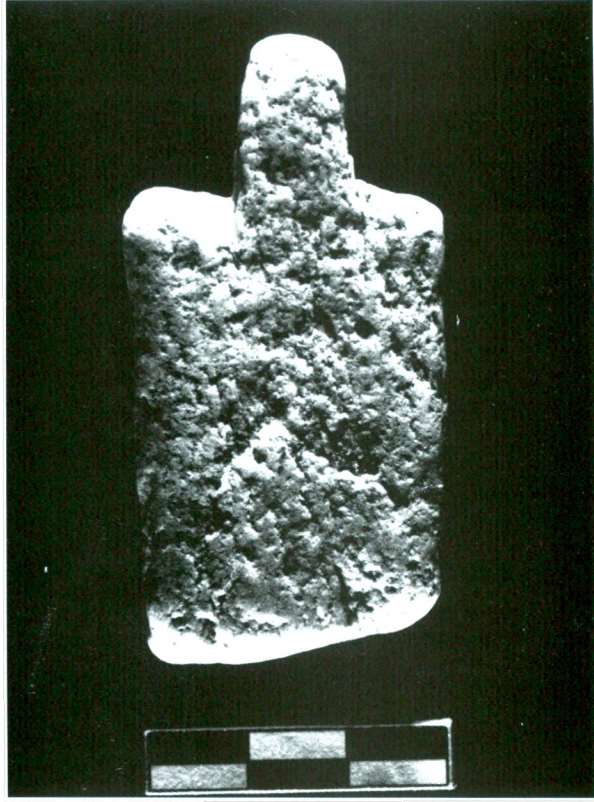

Res. 56/Fig. 56

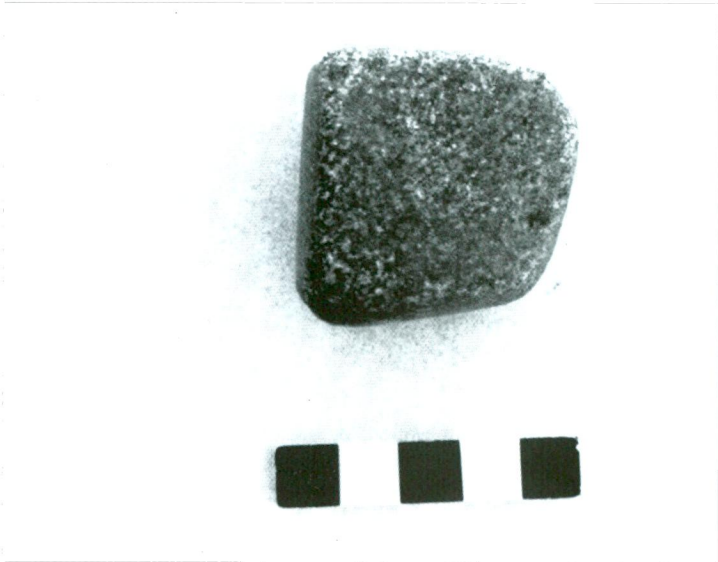

Res. 57/Fig. 57

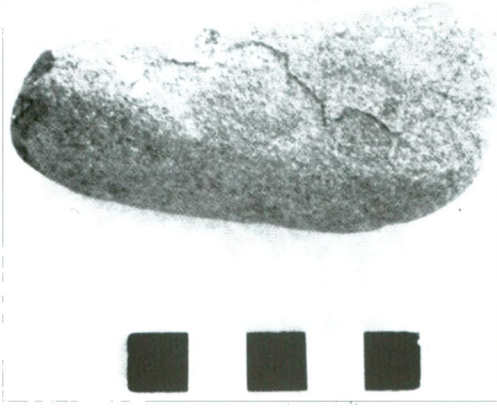

Res. 58/Fig. 58



Res. 59/Fig. 59



Res. 60/Fig. 60



Res. 61/Fig. 61



Res. 62/Fig. 62



Res. 63/Fig. 63

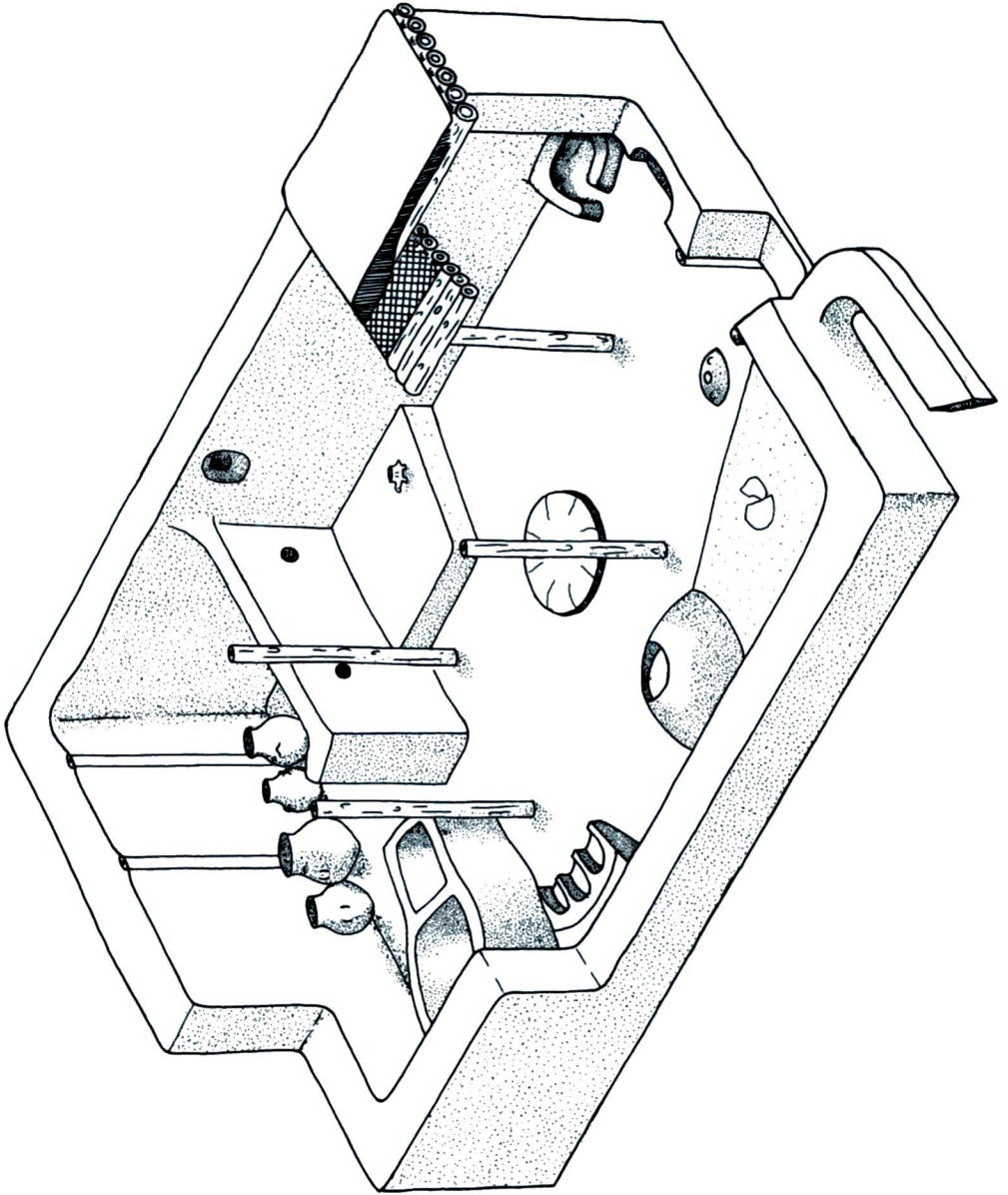

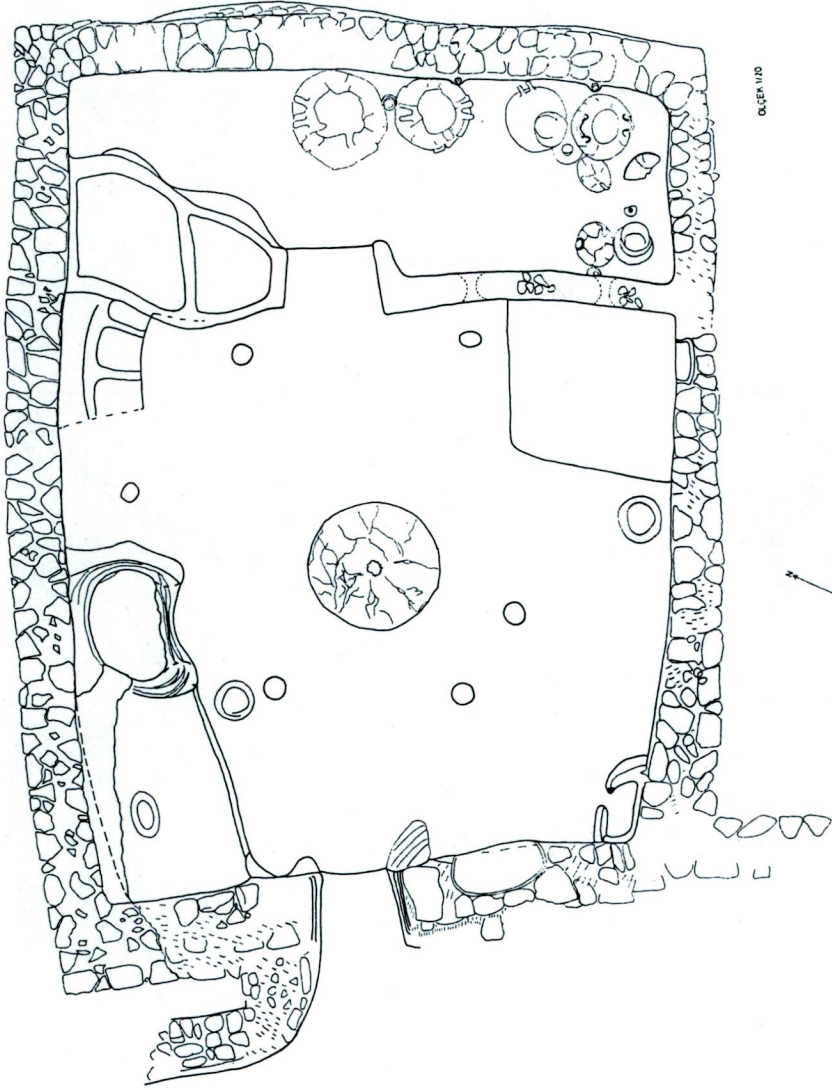

0,45m x 1,20

Köşk Höyük I. kat evi

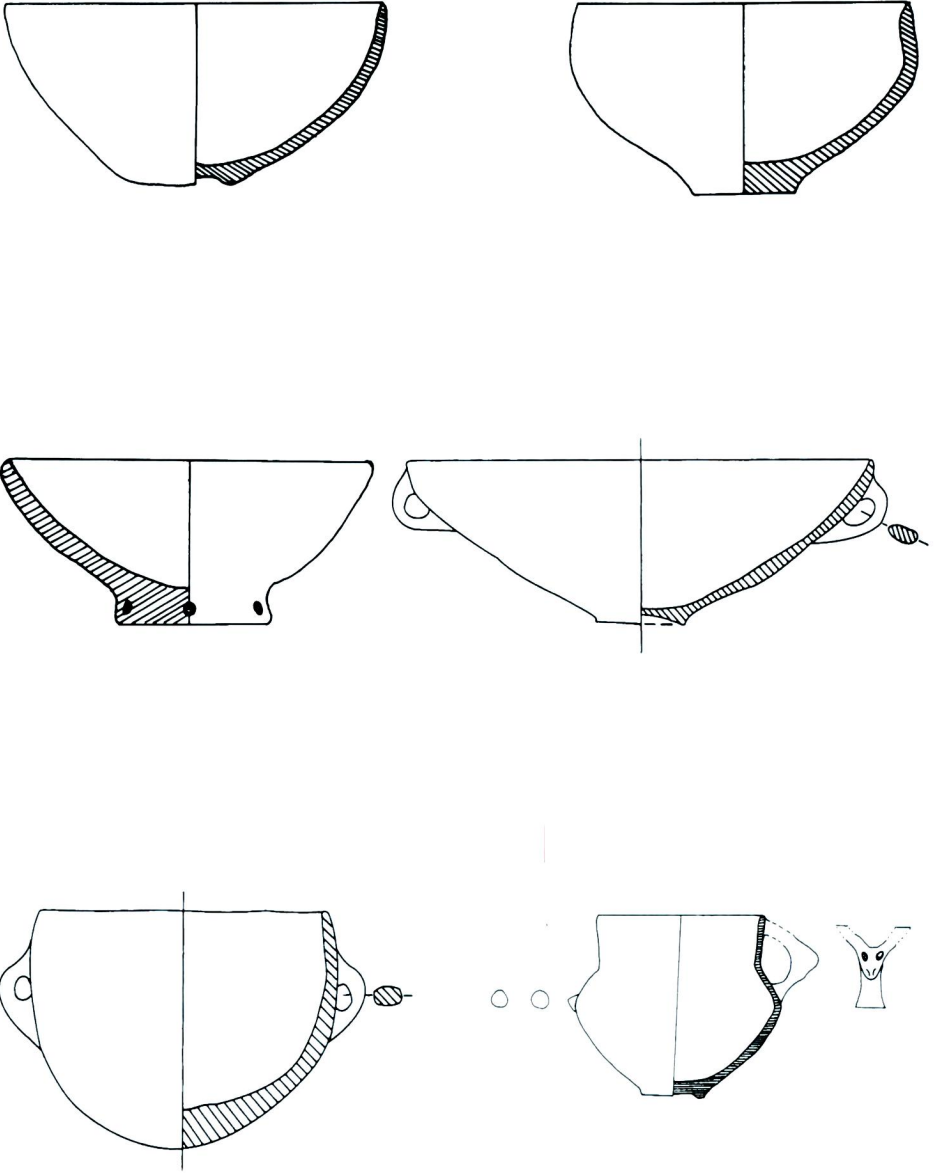

Çiz./Fig. 1-6

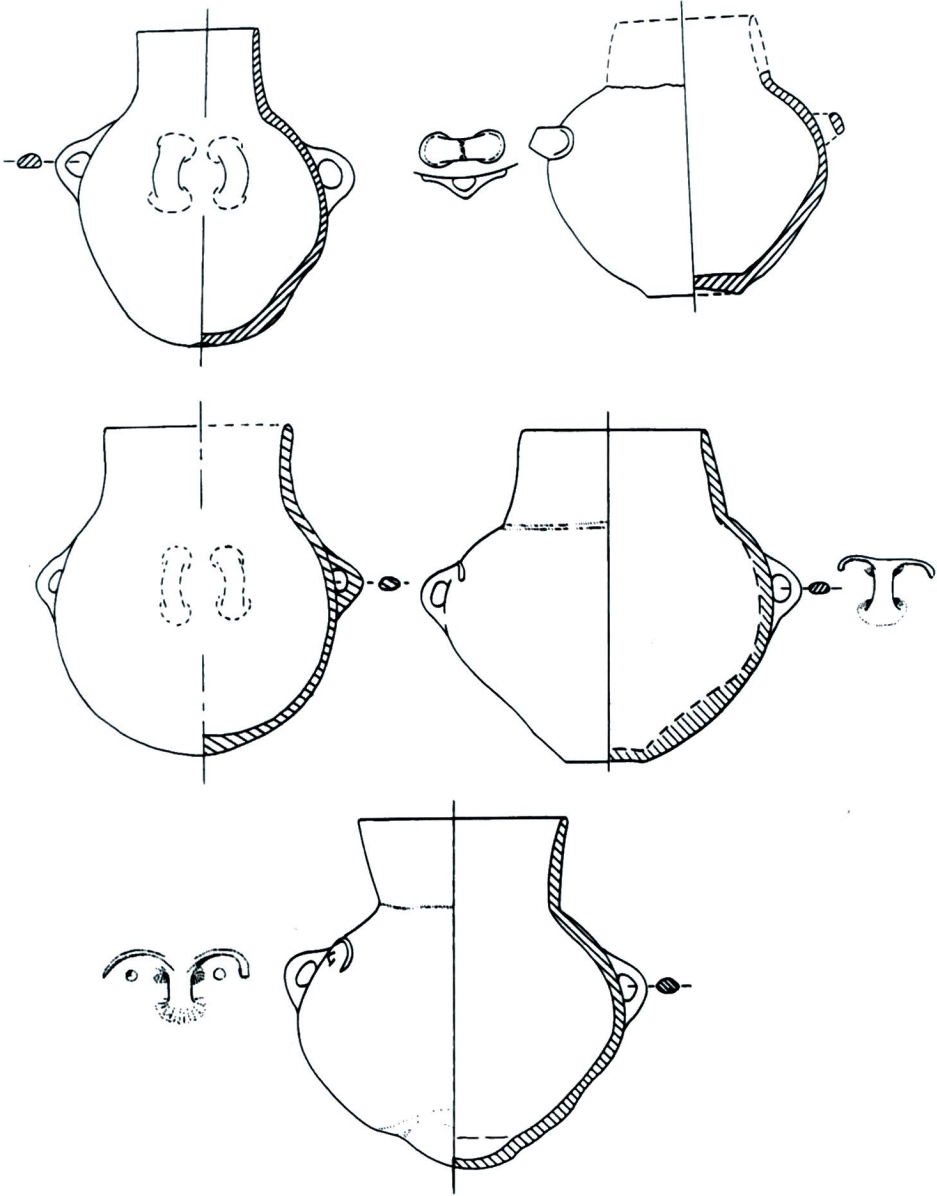

Çiz./Fig. 7-11

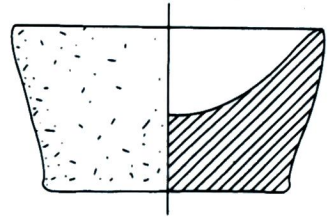
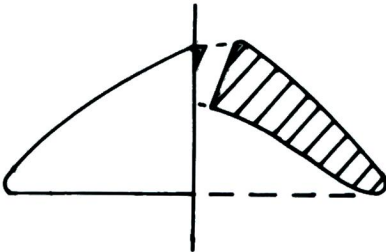
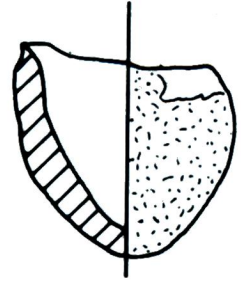
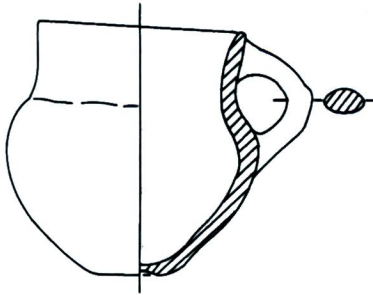
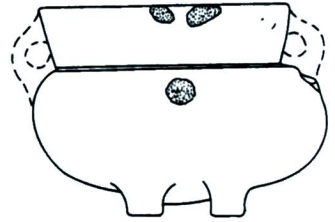
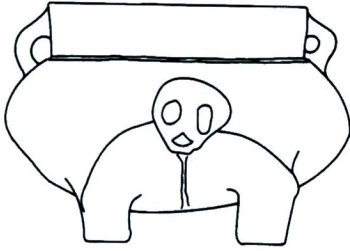
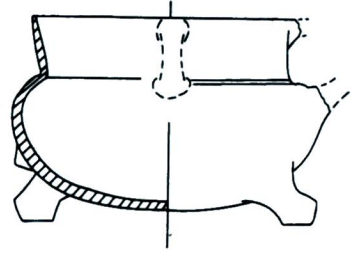
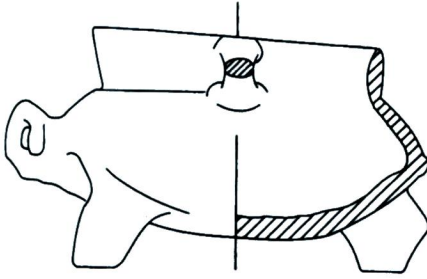

Çiz./Fig. 12-17

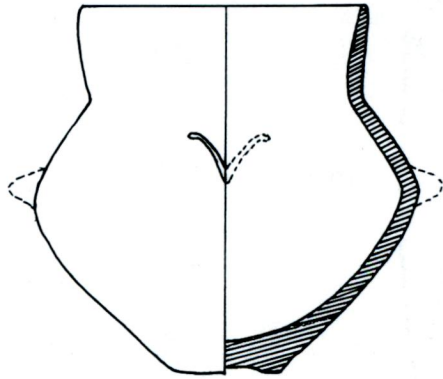
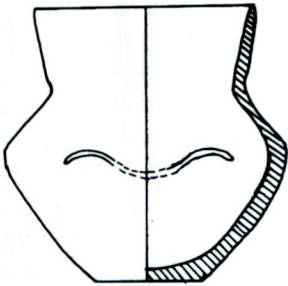
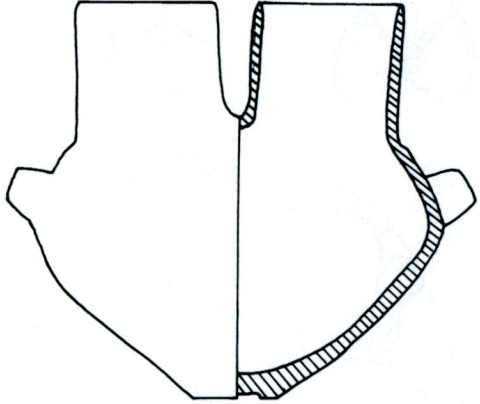
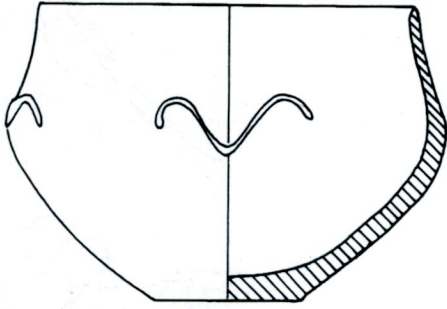
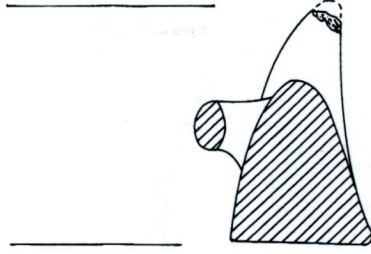
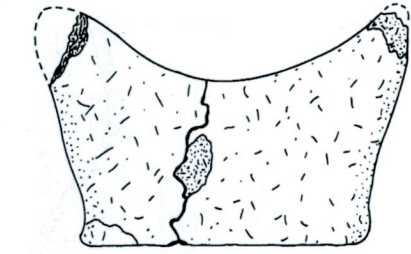

Çiz./Fig. 18-22

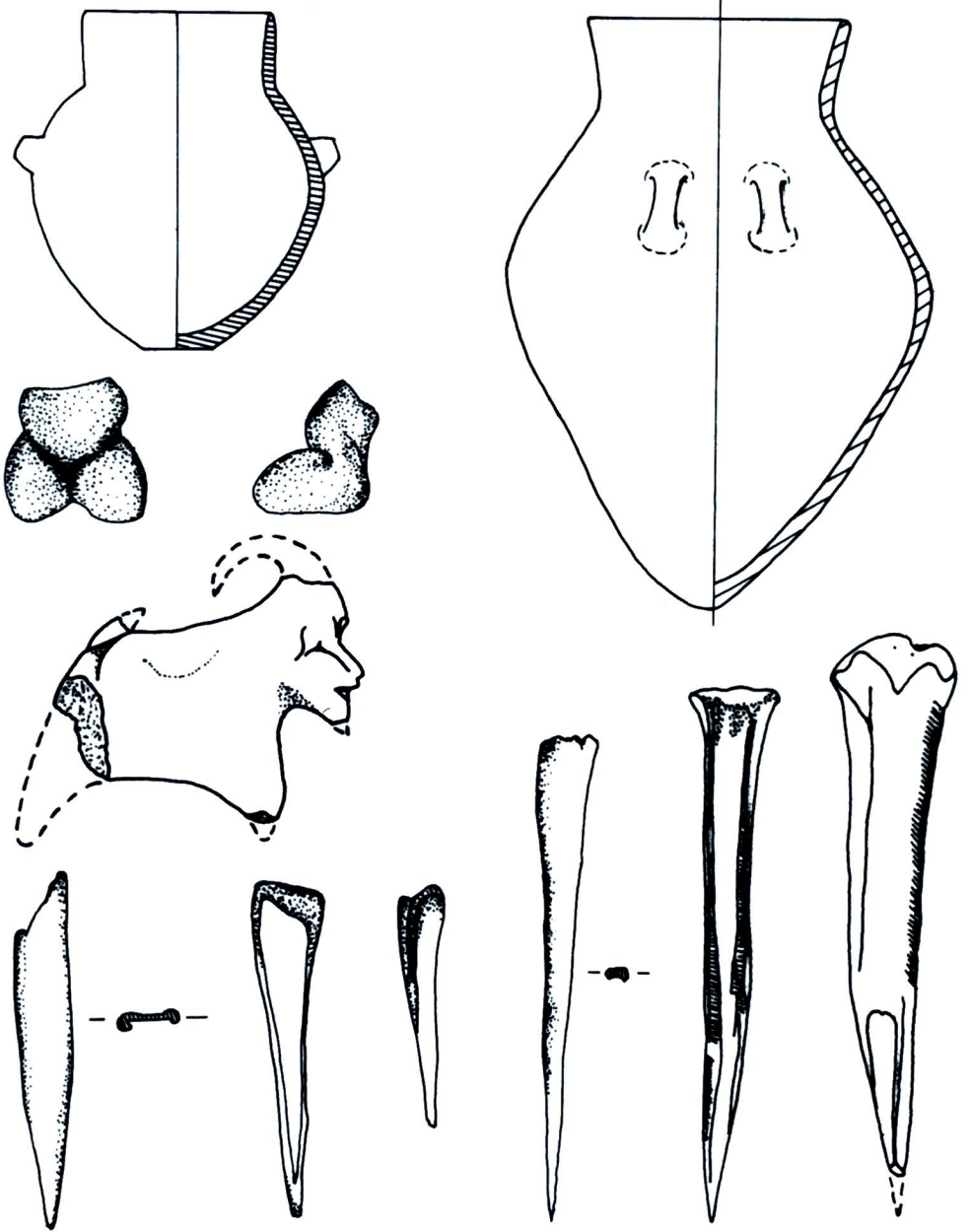

Çiz./Fig. 23-32

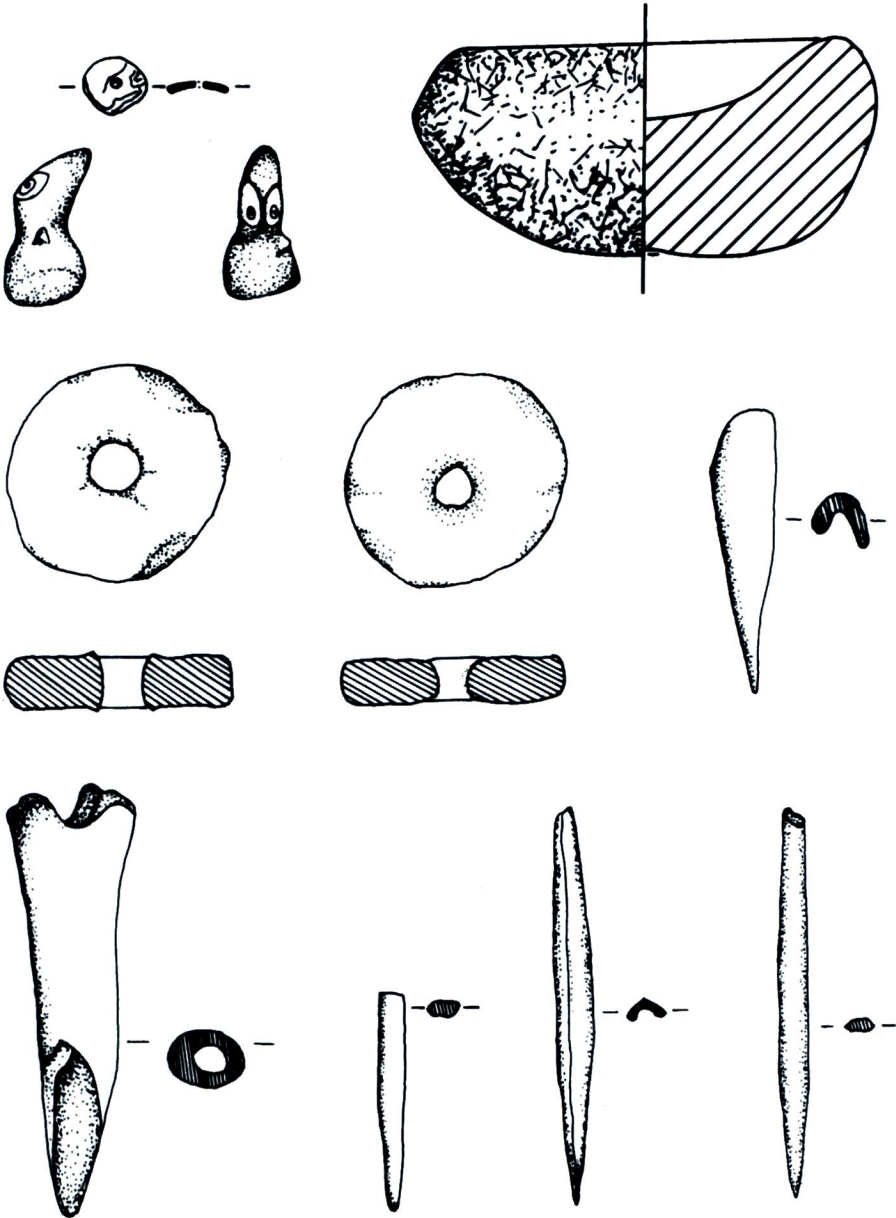

Çiz./Fig. 33-42

