

Research Paper

**The Thermal Effects on the Self-Compacting Concrete Beams
Exposed to the Fire "Experimental Case Study"**

Ammar TAWASHI^{1a}, Soleman ALAMOUDI^{2b}

¹Structural Engineering Department, Faculty of Civil Engineering, Al-Baath University, Homs, Syria

²Structural Engineering Department, Faculty of Civil Engineering, Al-Baath University, Homs, Syria
atawashi@albaath-univ.edu.sy

Received: 24.11.2022

Accepted: 11.04.2023

Abstract: Self-compacting concrete (SCC) is one of the most important technological developments in the field of construction materials, Its use has increased significantly in the construction industry in recent years due to its high properties in workability such as the filling and passing ability. The performance of elements made of SCC mixtures is largely unknown. In this work, beams made of (SCC) were produced in the laboratory and exposed to external fire at different reference times (30/60/90/120) min with two cooling methods (subjective, water). Selecting and evaluating three reaction stages (thermal transfer progress, spalling, surface microstructure). The results show that the damage of the loaded beam is interesting and corresponds to the characteristics of the cracks formed in the concrete section in the bending zone, which was documented photographically. The progress of thermal transfer has large values during (5-20) minutes in the heating phase and assumes different values (10-30%) in the beam height, where the curve is closer to the line.

Keywords: Self-compacting concrete (SCC), Concrete Beam, Fire Scenario, Curves, Heat transfer rate

1. Introduction

Since ancient times, fire has been a source of comfort and fear for people, it is a destructive force that causes thousands of deaths and massive property damage. Fire disasters can occur under or on the ground and sometimes in the most unexpected circumstances and considered one of the most serious potential disasters for most structures [1]. The widespread use of concrete as a building material has led to the need for a comprehensive understanding of fire effects and strengthening of affected concrete structures [2].

As the fire directly affects the microstructure of the reinforced concrete element, and the capacity of the element to transfer the interfacial shear [3] and the flexural capacity. Since the first attempts to apply fire protection, significant progress has been made in understanding structural fire protection [4]. The study of structural fire protection began in the second half of the eighteenth century, and then a scientific approach to the study of structural fire resistance began at the end of the nineteenth century, after the establishment of the British Fire Protection Committee (BFPC), in 1932 was published the first standard British (BS 476:1932) related to fire, which specified the fire resistance test.

The use of self-compacting concrete (SCC) in construction as a substitute for classical concrete (RC) is considered one of the good and interesting things, to produce concrete with desirable specifications and high functionality. After its use was limited only to concrete maintenance, and despite the great scientific progress in the field of production of (SCC) to use it in in-situ concrete and fresh concrete, however, there is no specific fixed method and reference, that studied proportions of materials used

How to cite this article

Tawashi A., Alamoudi S., "The Thermal Effects on the Self-Compacting Concrete Beams Exposed to the Fire," El-Cezeri Journal of Science and Engineering, 2023, 10 (2), 268-283.

ORCID: ^a0000-0002-7114-5819; ^b0000-0001-7013-3616

in the production of (SCC) such as gravel, cement, and other additives, reliance on experimental ratios of previous research, and special studies by conducting (SCC) mixtures for the production of this type of concrete, to achieve good quality at the lowest cost and the highest possible strength [5]. Which was based on the optimum proportions of materials needed for the production of (SCC), vary depending on the specifications of the selected materials themselves, without taking into account the effects of the environment.

Therefore, self-compacting concrete has been considered a controversial aspect, because the wrong choice of materials and inappropriate proportions lead to faulty and undesirable results, and failure in production of concrete with specific specifications, and properties that achieve the required strength. Despite the many advantages enjoyed by (SCC), the available data and research on the effects of various disasters (fire, earthquake, explosion, oxidation, etc) on the concrete elements made from it are still limited and less comprehensive.

2. Background

2.1. Progress of Thermal Transferring

In the process of thermal transfer, various thermal mechanisms depend on two processes [6], which are the main causes of spallation:

2.1.1 Thermohydraulic Process

This process is associated with the movement of water in the form of liquid and vapor. The rapid rise in temperature in the concrete leads to the evaporation of free, and bound water (mixed water) near the surface of the concrete element. This evaporation creates pressure in the pore network with some of the evaporated water, passing through the pore cracks to the hot surface, and from there to the surrounding atmosphere of the concrete element while the rest migrates to the less hot interior, where the temperature is still low and condenses there. The gas near this area is called "moisture stagnation", the pressure reaches a maximum, resulting in a large pressure that causes the concrete to crack while the condition of the rest of the element remains unchanged [7], Fig. 1 illustrates this process.

2.1.2 Thermo-mechanical Process

This is related to the thermal area in the concrete element, since the thermal expansion, if prevented, generates strong stresses perpendicular to the damaged surface, resulting in different deformations between the cement paste and the aggregate represented by the shrinkage of the cement paste and the expansion of the aggregate. This is the different thermal behavior one of the main reasons for the deterioration of the cement matrix. The spalling results from the simultaneous combination of the two mechanisms mentioned above, namely the tensile stress caused by the thermal expansion, and the increase of the interstitial pressure between the internal pores and the formed membrane.

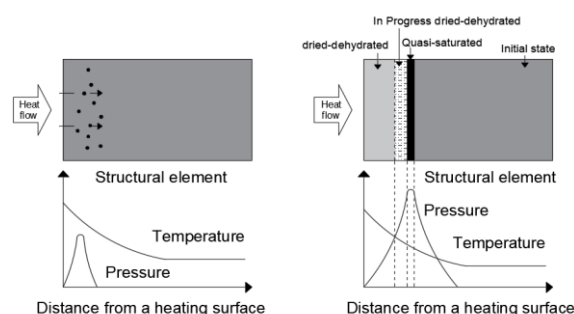

Figure 1. Thermo-hydraulic process

2.2. Spalling

When concrete is exposed to high temperatures, two phenomena can cause material loss. Gradual and explosive spalling:

Gradual spalling: involves many sequential processes, beginning with aggregate spalling, corner separation, surface fragmentation [8], spalling, and spalling after cooling as shown in Figure 2. Explosive spalling of concrete blocks is characterized by a sudden release of energy, this phenomenon may occur during the first 30 minutes of fire, and is characterized by a large or small piece of concrete violently ejected from the surface accompanied by a loud noise, where explosive spalling of concrete has been observed under fire test conditions.

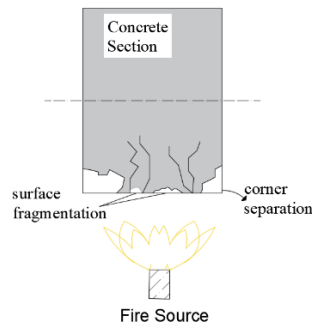

Figure 2. The phenomenon of spalling

2.3. Surface Microstructure

There are many influences that affect the microstructure of the concrete surface exposed to fire, including the rate of heating, the shape, and dimensions of the cross-section, moisture content, permeability, type and size of aggregates, resistance, and compressive stress.

This leads to changes in the microstructure of the concrete surface, starting with a gradual increase in temperature, and later leading to a loss of free water and mixed water.

The onset of thermal stresses with the appearance of capillary cracks, and the expansion of the crack width [9] Figure 3, then cracks appear in other places far from the source of the fire.

The advanced stages of the thermal effect begin with a temperature rise along the cross-section height, until the temperature of the reinforcing bars rises, creating a noticeable thermal gradient between the cover and the reinforcing bars, that leads to the breakup and separation of the cover, and damage to the surface of the concrete element.

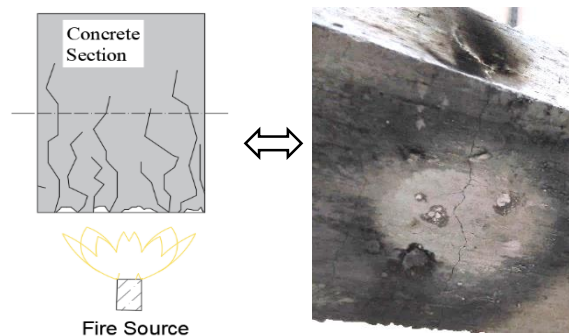

Figure 3. The Surface microstructure

3. Scope of Work

Concrete is a material that has excellent intrinsic behavior when exposed to fire, it is considered a non-combustible material and has a very high thermal resistance [8], which results in a significant slowdown of heat propagation through the concrete cross-section. In fact, in most fires, only the outer concrete surface layer is damaged, which is about (3 to 5) cm thick, and which allows us to carry out restoration and reinforcement works, that contribute to the reuse of many concrete buildings that have been exposed to fire. In general, concrete is considered to have good fire resistance, but high temperatures affect the strength of concrete through explosive fragmentation [10], which in turn affects the safety of the concrete structure.

Many researchers have studied the fire behavior of concrete elements, their studies included the evaluation and analysis method of reinforced concrete, by exposing a structure or member to experimental fire independently and then analyzing the results [9]. and there are several studies that have focused on the effects of fire on reinforced concrete members made of classical concrete (RC), and their behavior in this disaster [11]. However, this research aims to conduct an experimental study on the thermal behavior of reinforced concrete beams, made of self-compacting concrete (SCC), exposed to a fire flame system by discussing some cases, and evaluating the effects of fire at different reference times, using two cooling methods, and simulating the fire disaster by getting as close as possible to the actual conditions, normally encountered in structures by applying them experimentally to the SCC beams.

The reinforced concrete beams were made of SCC based on clear and accepted ratios of the components, involved in the fabrication recommended by ASTM [12], and met the requirements of the Syrian Arab Code [13].

It was adopted the model of service loading concrete beam, by applying an external concentrated force generated from a hydraulic actuator operating at oil pressure, the force distributed into two concentrated forces with an iron beam, the divided forces located in the middle third of the concrete beam Figure 4, which ensures that measure the thermal behavior of the concrete beam on the bending.

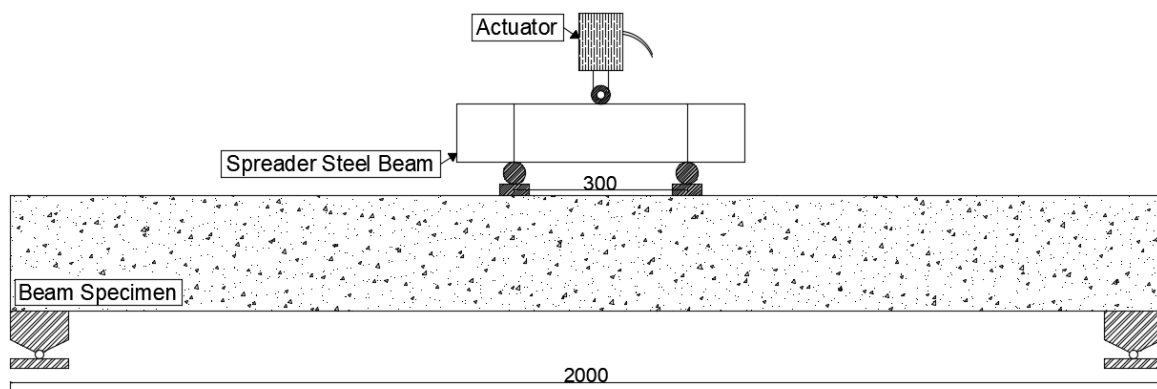

Figure 4. The Applied Loading Model “all the dimensions in mm”

Then the element is exposed to an external fire flame, and a thermal analysis is performed to evaluate the behavior of the element under the effects of the disaster.

4. Materials and Methods

4.1. Concrete Mixtures Manufacturing

Obtaining an eco-friendly SCC mixture incorporating waste is essential at the present time [14] when

the appropriate conditions are available to know its properties in the fresh and mechanical state and the mechanism of its breaking in the solid state. In this research, three types of (SCC) mixes were prepared from the availability of local materials, without relying on materials from abroad, as there were no options for them: coarse aggregates of limestone with a maximum size of 12.5 mm [15], and two types of fine aggregates including sand (Al-Kayrawani sand, crushed sand).

Portland cement of class 32.5 N/mm² according to Syrian Standard Specification-1 No. 3800 of 2015, was used as fine base material instead of using other improved materials, such as fly ash and others in the mix, with different values (450, 500, 550) kg/m³ to check the effects of cement content on concrete strength and mix performance [15].

Three types of high-quality chemical plasticizers were used, coded as (HRW, Sikament NN, and S) with two proportions (2% and 2.5%) of cement weight to achieve the required functionality in (SCC):

Table 1. SCC mixture of raw materials and plasticizers ratios

Mixture	Cement Grade (kg/m ³)	W/C	Plasticizer (%)	Coarse Aggregates (kg/m ³)	Fine Aggregates (kg/m ³)
SCC	550	0.390	2.0	625	1000
	500		2.5		
	450		2.5		

The tests of fresh concrete properties were carried out [15] as shown in Figure 5.

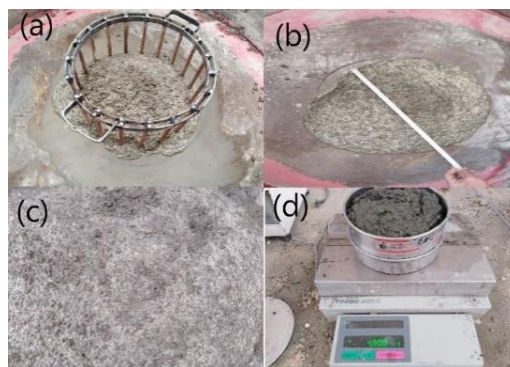

Figure 5. SCC-HRW fresh properties tests (a): J-ring Test, (b): Slump Flow (SF) and T_{50} (sec) Test, (c): Visual Stability Index (VSI), (d): Segregation Test (SR).

It was found that the mix with one type of cement (550 kg/m³), and a plasticizer coded as HRW had the preferred workability properties, and good strength in the solid state. While the mix with one type of cement (450 kg/m³), did not have any of the workability properties required for this type of concrete as shown in Table 2 below:

Table 2. SCC- HRW fresh properties

Mixture	Cement Grade (kg/m ³)	W/C	Plasticizer (%)	Slump Flow SF(cm)	T_{50} (sec)	J-ring (DJ %)	Segregation Test (SR%)
SCC-HRW-550	550	0.39	2.0	58	5.40	86	6.42
SCC-HRW-500	500	0.39	2.5	52	4.86	96	4.06
SCC-HRW-450	450	0.39	2.5	-	-	-	-
Allowed				55-65	-	≥80%	≤15%

The results of laboratory tests of cylindrical SCC specimens produced locally under axial compression[13] show the contribution of plasticizer by reducing the W/C ratio up to 13%, thus improving the SCC concrete in terms of stress-strain behavior.

By fracture testing of cylindrical specimens of SCC Figure 6, the compressive strength of concrete is related to the cement type, and the percentage of plasticizer in the mix composition with the type of plasticizer and the W/C ratio, where the compressive strength increases with a higher percentage of cement type, the plasticizer decreases and the W/C ratio becomes lower.



Figure 6. SCC Cylindrical Samples

According to laboratory tests, found an increase in the strength of concrete with plasticizer as HRW by 2% of the cement weight, up to 12% compared to the reference sample without plasticizer. The plasticizer in the concrete mixes contributed to an increase in workability and a decrease in W/C ratio, but the percentage increase in strength was due to the type of cement used, the type of plasticizer, the percentage of plasticizer and the W/C ratio. The decrease in compressive strength was observed due to the use of a lower type of cement with a higher percentage of plasticizer. This can be explained by the change in the molecular structure of SCC mixtures when the W/C ratio is stable [14], so it is better to use a higher cement type for a lower plasticizer percentage and stability by a ratio of W/C.

The following Table 3 shows the increase in cylindrical compressive strength, as a function of the cement type and the percentage of plasticizer:

Table 3. The compression strength of SCC Mixture

Mixture	Cement Grade (kg/m ³)	W/C	Plasticizer (%)	Compression Strength (MPa)	Strength Increase Ratio (%)
SCC-HRW-550	550	0.39	2.0	37.616	12
SCC-HRW-500	500	0.39	2.5	28.249	1.9
SCC-HRW-450	450	0.39	2.5	24.890	0.01

Thus, using the mixture with plasticizer coded as HRW, it is possible to produce SCC only with cement as representative of other fine fillers, and obtain a self-compacting, functional, cohesive, and homogeneous concrete mixture, with high strength in the solid state.

4.2. Reinforced Concrete Beams

The beams were made with SCC mix as mentioned in the previous section. The following issues were considered in the design of the beam:

- Loading due to pure bending forces ($L/h \geq 10$).

- Simple support system.
- The minimum cross-section for fire resistance.
- Achievement of minimum thickness of the cover to resist fire.
- Achieving minimum and maximum reinforcement ratios.

The reinforced concrete beam is subjected to bending stress by external forces (distributed or concentrated), which leads to bending in the middle of the element, and to the formation of cracks, accompanied by the generation of tensile and compressive stresses, where the tensile stresses are distributed to the lower layer, and the compressive stresses to the upper layer of the concrete section. To simulate the critical situation in the design of the beam section, the minimum dimension of the section was used to resist the fire, assuming the dimensions ($b=150$, $h=200$) mm.

The minimum thickness of the cover for reinforced concrete beams was also assumed, assuming that the concrete is without additional protection, and is exposed to a fire of at least one hour, so that the thickness of the cover layer for the area exposed to direct fire is not less than 25 mm from the outer surface of the reinforcing bar.

The reinforcing bars were distributed in the cross-section to achieve the required reinforcement ratios. For this reason, tension bars (2T12 mm) and compression bars (2T10 mm) were chosen. in addition to struts (C6 mm/15 cm). Figure 7 shows the details of the beam.

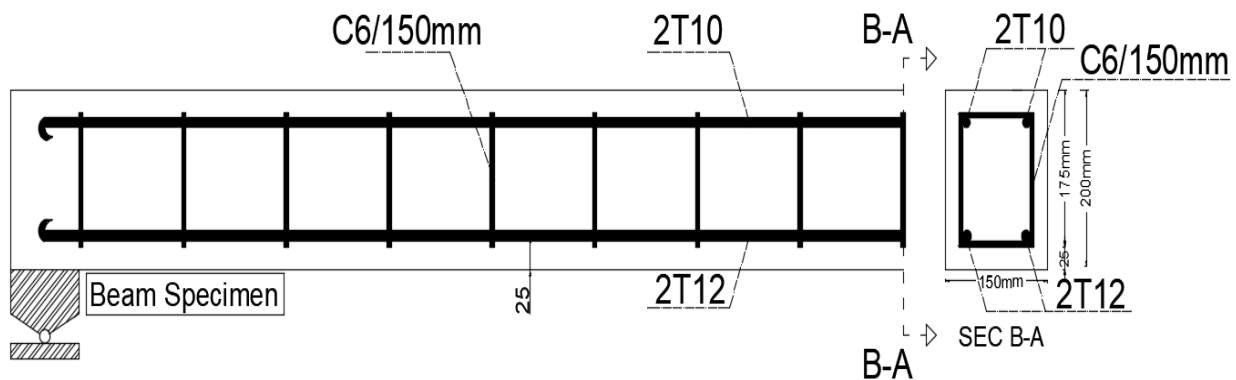

Figure 7. SCC beam details

Nine beam samples were casted in the laboratory and used to perform the thermal analysis, one sample of which was broken to determine the approximate service load (Figure 8), and then all elements were subjected to the same load so that they approximated the actual situation of the building in use.

The results showed that the breaking load is 49 kN, and that the value of the service load is 28 kN, which is 57% of the maximum capacity.

4.3. Experimental Fire Procedures

In order to perform the fire tests on reinforced concrete beams made of SCC, it is necessary to follow clear and safe procedures, that meet the requirements of the fire design strategy and protection requirements [17], and allow us to perform the thermal analyses as follows:

- Selection of the designed fire scenario "Fire Flame Applying Model".
- Measurement of the selected fire scenario "Experimental Fire Curves".
- Analysis of the temperature at the level of the concrete element "Thermal Transfer Curves".



Figure 8. SCC beam fractured test.

4.3.1 The Designed Fire Scenario

The selection of the model to apply the fire flame was made by finding a clear method to study the effects of fire on beams and simulating the fire catastrophe, through realistic tests of the fire catastrophe by applying a direct fire flame to the elements. Although in many cases the fire conditions cannot be exactly simulated [5], as they are as close as possible to the actual circumstances. In Figure 8, the flame is generated from a household gas cylinder and subjected to real ventilation conditions. Subjectively cooled both gradually and suddenly with water, simulating the work of firefighting units at the disaster scene.

4.3.2. Equipment and Tools

Flame application system: In order to subject the concrete beams loaded in service to a direct fire flame, a special fire model for this type of test has been designed, Figure 9 with dimensions (2000,1200) mm, and a height of 1400 mm, which is a base of metal of a main tube (80 * 38 * 2.8) mm, on which walls on both sides of the sheet with a thickness of 2.8 mm, the width is (85 mm) with glass wool inside, which achieve thermal insulation around the perimeter of the tested sample, and the safety of students of potentially volatile materials during the test.

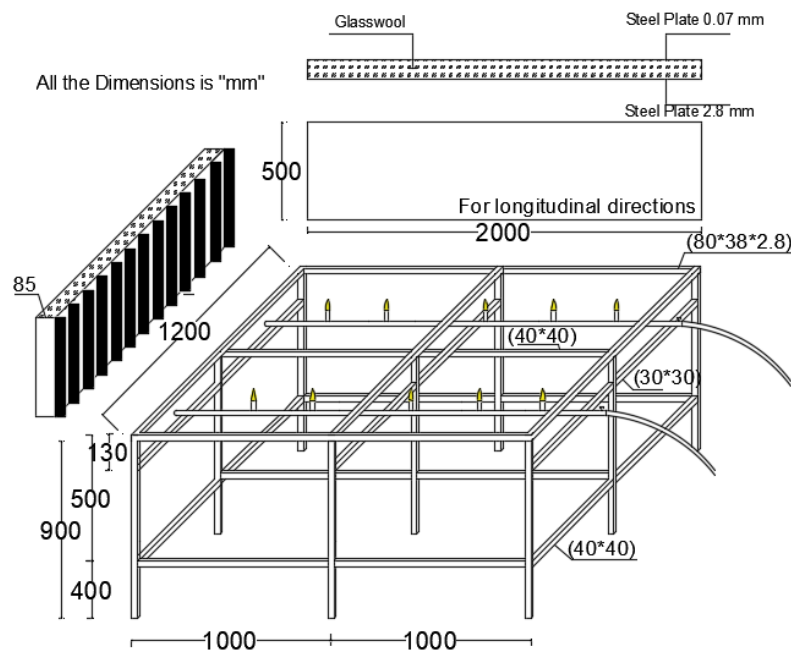

Figure 9. Fire flame applying model.

The two walls in the long direction were designed to be movable according to the dimensions of the tested sample (beam or slab), and the lower and upper part of the model remained open to the surrounding atmosphere, and ventilation was exposed to get closer to the actual situation of fire disaster when it occurred and allows to monitor and evaluate the tested sample.

This model was provided with two burners, a pipe of mercury iron equipped with a safety valve, and thermal flasks come out of it, each also contains a safety valve distributed throughout the length of the pipe. Thus, the triangle fire was formed for the laboratory tests [7]:

- Oxygen.
- Flammable materials "The household gas".
- The source of fire flame.
-

Temperature gauges: To specify the temperature of the tested sample, and the heat of fire source along of experiment duration, two types of temperature gauges were used:

- Laser infrared thermometer.
- Thermal sensor type-k.

4.3.3. Experimental Fire Curves

The concrete elements were placed in the fire flame application system, the lower surface was exposed to the direct fire flame for the reference times, as shown in Figure 10, during the test the thermal behavior was evaluated, the steps of the test were documented with the important information and observations according to the following points:

- Exposing all the beam specimens to the fire flame for the reference times, the diameter of the fire flame spread touching the concrete surface was equal to 20 cm at all the fire sources.
- Monitoring the direct effects of the fire flame on the specimens, and recording the temperature every five minutes throughout the duration of the test, Figure 11.

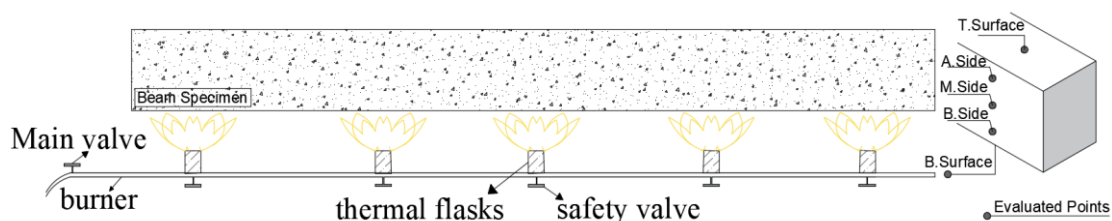

Figure 10. Fire flame applying system and the evaluated points.



Figure 11. Monitoring the effects of fire flame

- Recording the temperature for all the evaluated points on the specimen surface, Figure 12, at the flame source and a spot between the fire flasks.



Figure 12. Recording the temperature at the evaluated points.

- Cooling the specimens according to the chosen method for each sample, gradually subjective or suddenly using the water.
- Illustration of the thermal results graphically through the curves of temperature-time, temperature-element height for all surfaces of the evaluated points.

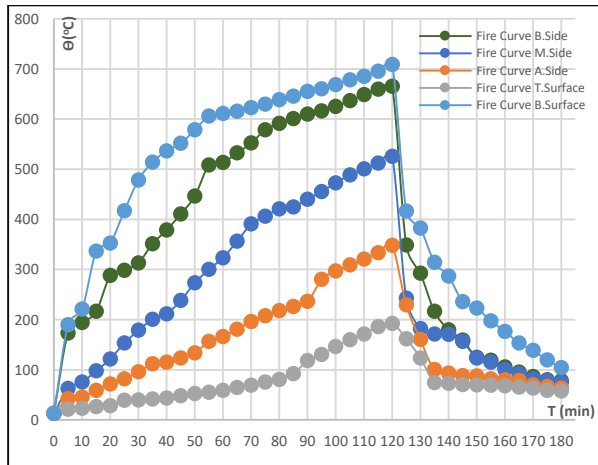

Figure 13. Temperature-time curves at the fire source

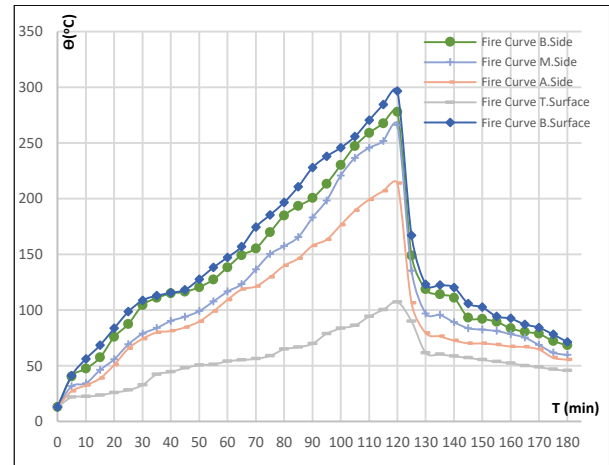

Figure 14. Temperature-time curves at the spot between the flasks

Figs 15 and 16 show the temperature- height curves for the same sample.

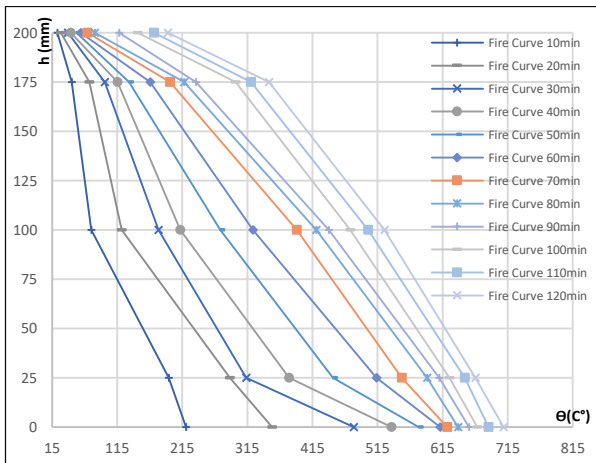

Figure 15. Temperature- height curves at the fire source

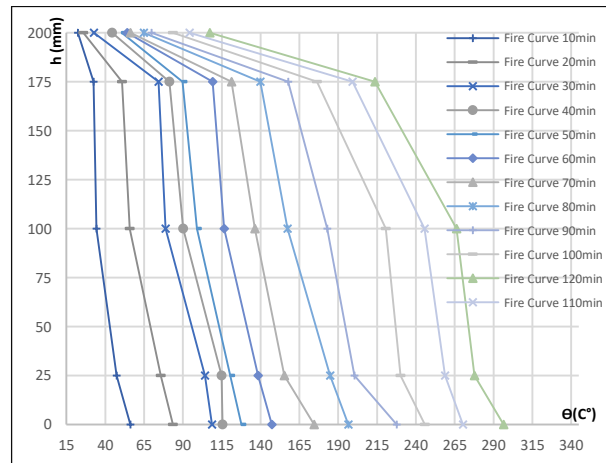

Figure 16. Temperature- height curves at the spot between the flasks

Figures 13 and 14 show the temperature-time curves of the sample exposed to fire for 120 mins, and the gradual subjective cooling at the fire source, and at the point between the flasks. For the element suddenly cooled by water as shown in Figure 17, the temperature-time curves of the sample exposed to fire for 120 mins at the fire source, and at the point between the flasks are given in Figures 18 and 19.



Figure 17. Cooling suddenly using the water

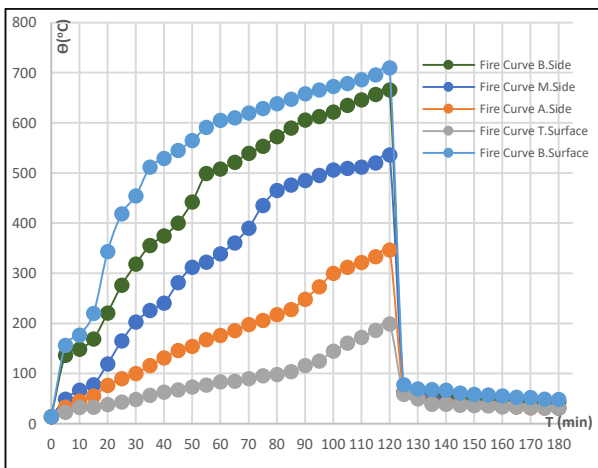

Figure 18. Temperature-time curves at the fire source

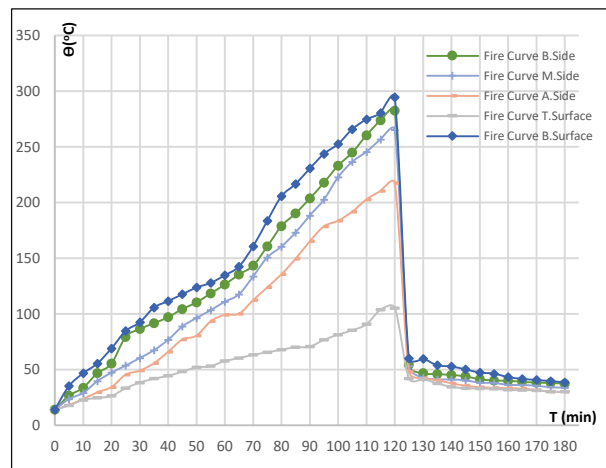

Figure 19. Temperature-time curves at the spot between the flasks

Figures 20 and 21 show the temperature- height curves for the same sample.

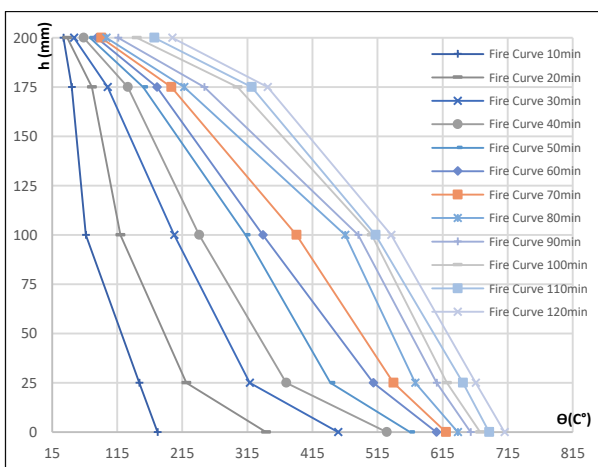

Figure 20. Temperature- height curves at the fire source

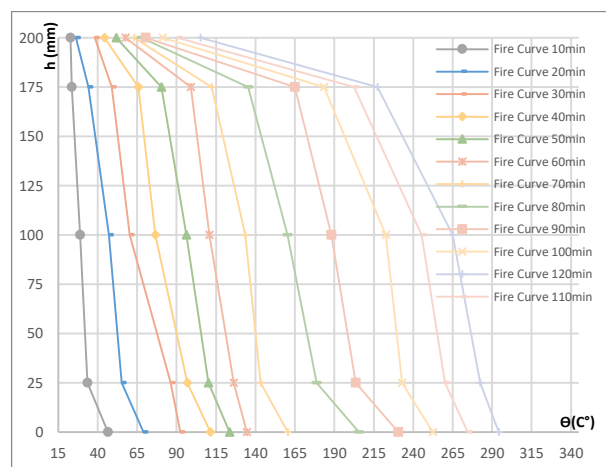

Figure 21. Temperature- height curves at the spot between the flasks

4.3.4. Heat Transfer Rate

Exposure of the specimens to the high temperature of the flame, caused changes in the internal structural composition, resulting from thermal stresses acting directly at certain points and indirectly at others. As for the thermal behavior, it could be expressed by the rate of heat transfer in the concrete cross-section, extracted by processing the above-mentioned laboratory data, from which curves were derived expressing the rate of average heat transfer, at the level of the concrete cross-section. Using these curves, it was possible to express the rate of heat transfer, and the temperature of the section at an arbitrary time for an arbitrary point, where a unit ($^{\circ}\text{C}/\text{sec}$) was given for the rate of heat transfer, while the height of the concrete section was expressed as a relative quantity (cm/cm). The expression $V_{(ta,inc)}$ was given for the heating phase at the flame source in Figure 22, and the expression $V_{(ta,inc)}$ for the point between the pistons in Figure 23 below:

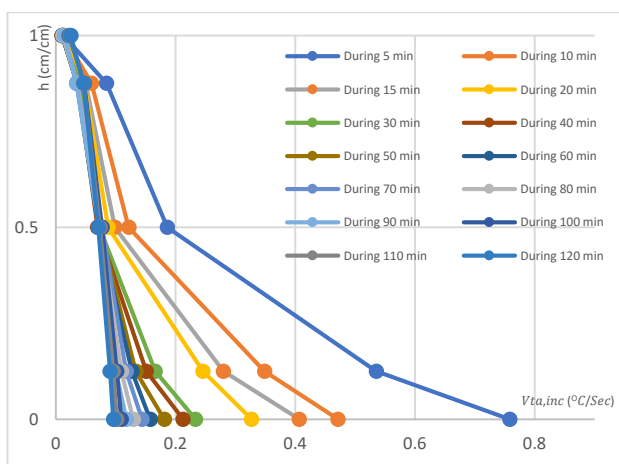

Figure 22. Thermal transfer rate – section height curves at the fire flame source

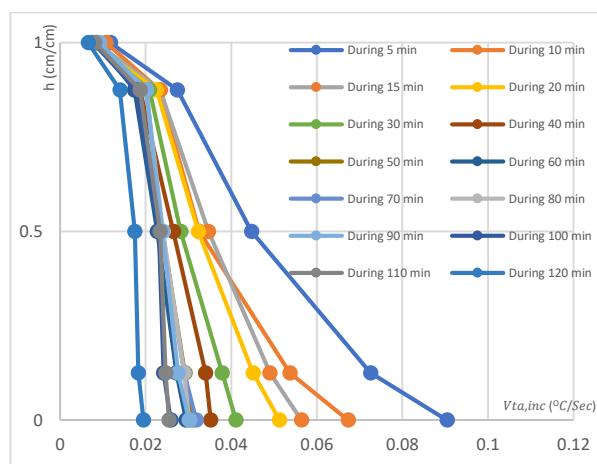

Figure 23. Thermal transfer rate – section height curves at the spot between the flasks

The temperature of concrete depends mainly on the duration of exposure to fire on the element, and the rate of heat transfer is influenced by the mechanical properties of the element, and materials as well as the distance of the heat source.

On the other hand, the expression of thermal behavior by direct mathematical analysis is considered an important matter, which allows specifying the heat transfer rate, and the temperature of the concrete section directly by a simple process of a mathematical formula, which could be derived by using the basic variables, to find the optimal formula for each case that gives the best correlation coefficient and the smallest standard error.

The results showed that the most suitable mathematical formula for heat transfer rate is the formula of the Hoerl model, whose general form is as follows:

$$y = ab^x x^c \tag{1}$$

y: heat transfer rate, takes the expression $V_{(ta,inc)}$.

x: duration of exposure to fire, takes the expression T (min).

a, b, c: equation constants.

In order to verify the convergence of the theoretical values, derived from the previous equation with the laboratory values, the values of the constants from the CurveExpert 1.4 software were used to plot the theoretical curves, Whereas, the values of the constants are as shown in the table 4 below:

Table 4. Values of the Equation Constants

Constant	Fire Source	Spot Between Fire Flasks
a	1.901	0.183
b	0.997	1.000
c	-0.570	-0.439

The results are as follows: Figure 24 shows the time-heat transfer rate curves at the fire source and Figure 25 for the point between the fire flasks:

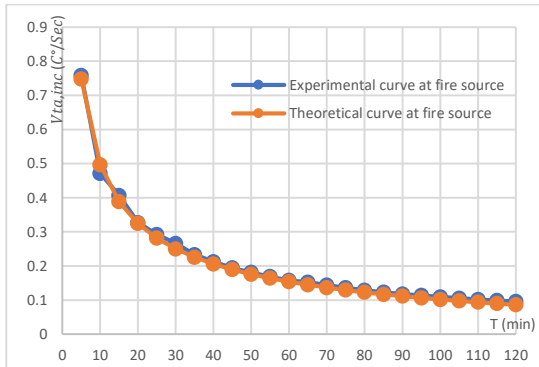

Fig. 24. Experimental vs Theoretical curves at the fire source

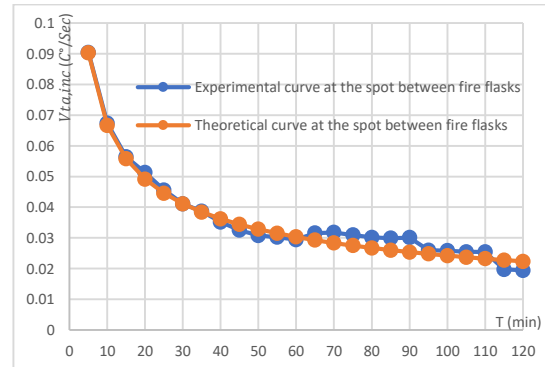

Fig. 25. Experimental vs Theoretical curves at the spot between the fire flasks

5. Results and Discussion

Under the conditions of the laboratory test, the following points were observed:

- Internal explosion sounds were heard, resulting in surface spalling, with some fine pieces flying off the surface of the sample.
- Transpiration the water of the sample and then boil on the surface, which has the free water in the places of the service cracks are located, and more clearly at the points of the fire flame source, where the water took the easiest path to getout of the sample, after then the water of the concrete mixture began to move as the same way of free water, Figure 26 below:



Figure 26. Transpiration and boiling the water of the sample.

- The transpiration and boiling of water due to direct exposure to fire led to the formation of micro-cracks and the generation of residual thermal stresses, which led to an increase in the width of the cracks, Figure 27:



Figure 27. Expansion of the crack's width

- The surface of the concrete at the fire source has discolored and charred, where the temperature raised more than of the other points, and this change persisted after the test, that's explaining the complete drying from the water and the effect of the fire on the internal microstructure of the concrete, as shown in Figure 28.



Figure 28. Surface changed color and charred

The temperature rises sharply in the first 10 minutes after the start of the experiment, slows down after the first 30 minutes, and the maximum temperature value is relatively close after 30 and 60 minutes.

The heating part of the temperature-time curve shows a steep increase at the surface directly exposed to the flame, but it decreases at the other evaluated points. However, the temperature-height curves exhibit a quasi-stable slope as the linear shape of the curve increases as it gets closer to the sample surface.

The temperature of the tested sample remained high for a little time after the end of the experiment in the case of gradual cooling, while it dropped sharply in the case of water cooling. One can see the convergence of the heating part of the temperature-time curves in both cooling cases, but the change is clear in the cooling part, where in the case of sudden cooling the temperature drops at the first 5 minutes up to 25% of the value of gradual cooling.

The temperature of the point exposed to direct fire increases on average 2-4 times the other points Figs 13,14 and Figs 18,19, and the range of variation of temperature change over the height of the concrete section is between 10-30% Figs 15,16 and Figs 20,21.

As the specimen temperature raises, the raise in pore pressure is greater than the tensile strength, which leads to thermal cracks, It was observed that the service cracks which exposed to thermal stresses, returned to their approximately normal state in the case of gradual cooling, while the expansion continues to be noticeable after sudden cooling, this can be explained the thermal

incompatibility between concrete and steel bars, and this sharp temperature gradient caused permanent expansion of the cracks.

6. Conclusions

The objective of this study was to evaluate the effects of direct fire flames on beams made of self-compacting concrete SCC while understanding the thermal behavior through the graphical and visual analysis. And the main results of this study are presented below:

- The direct fire flame setup used in this study was able to elucidate the thermal behavior with time before and after cooling, through both heat distribution and spallation intensity. The increase in thermal damage to the SCC elements was also recorded, highlighting the need to distinguish between the duration, and type of construction material used in new concrete mixes.
- The results collected in this study indicate that the severity of the effects of the fire flame on the SCC elements increases with exposure duration, which was verified using the laboratory data and the extracted formula.
- Although the fire flame was most active during the first 30 minutes of the test, reaching 68% of the heat capacity reached after 120 minutes, the visible damage effect was small compared to the effect of maximum capacity flames.
- The total duration of flame exposure, the concrete constituents used, and the method used to terminate the catastrophe play a significant role in assessing the thermal behavior, and damage of the specimens. This was clearly observed in these laboratory tests, especially when crack extension remains at a higher level during sudden cooling.
- Overall, the fire resistance of the SCC component depends on the original concrete properties and the thermally induced damage to the concrete. This was observed in the expansion and cracking tests. Further investigation of the mechanical properties is required to understand the effects of damage to SCC beams.

Authors' Contributions

Both authors read and approved the final manuscript.

Competing Interests

The authors declare that they have no competing interests.

References

- [1]. A. Helmy, K. Morsy, and S. A. Nasr, "Structural Behaviour of R.C. Beams Subjected to Fire and Retrofitted Using Advanced Composite Materials," *ICPCM*, 2003, pp. 2-10.
- [2]. M. E. Mathews, N. Anand, D. Andrushia, T. Kiran, and K. Al-Jabri, "Flexural behavior of fire damaged self-compacting concrete beams strengthened with fiber reinforced polymer (FRP) wrapping," *Journal of Structural Fire Engineering*, vol. 12, no. 4, pp. 486-509, 2021.
- [3]. M. E. Mathews, N. Anand, É. Lubl6y, and T. Kiran, "Effect of elevated temperature on interfacial shear transfer capacity of self-compacting concrete," *Case Studies in Construction Materials*, vol.15, e00753, 2021.
- [4]. M. Petru, "Design of Reinforced Concrete Elements Under Fire," *Gheorghe Asachi, Technical University*, Jassy, Romania, Fasc, vol. 3, pp. 24-32, 2008.

- [5]. BIBM, CEMBUREAU, EFCA, EFNARC, ERMCO, "The European Guidelines for Self-Compacting Concrete Specification, Production and Use," *SCC European Project Group SCC 028 European Federations*, pp. 1-63, 2005.
- [6]. G. Guergah, M. Salah, M. Dimia and Guenfoud, "Numerical Modelling of The Fire Behaviour Of Reinforced Concrete Beam Integrating The Concrete Cover Lost By Spalling," *J. Materials and Environmental Science*, vol. 8, no. 10, pp. 3690-3705, 2017.
- [7]. A. De Wit, "Behaviour and structural design of concrete structures exposed to fire," *Master of Science Thesis*, Stockholm, Sweden, pp. 5-22, 2015.
- [8]. L. Bodnarova, J. Valek, P. Petr Novosad, "Testing of Action of Direct Flame on Concrete," *Hindawi Publishing Corporation, the Scientific World Journal*, Article ID 371913, pp. 1-8, 2015.
- [9]. A. F. Izzet and Z. H. AL-Dulffy, "Effect of High Temperature (Fire Flame) on the Behavior of Post-tensioned Concrete Beams," *Association of Arab Universities Journal of Engineering Sciences*, vol. 25, no. 3, pp. 49-68, 2018.
- [10]. M. M. Kadhum, "Fire resistance of reinforced concrete rigid beams," *Journal of Civil Engineering and Construction Technology*, vol. 5, no. 5, pp. 35-48, 2014.
- [11]. M. M. Kadhum, "Effect of Burning by Fire Flame on the Behavior of Reinforced Concrete Beam Models," *J. Babylon University Engineering Sciences*, vol. 21, no. 5, pp. 1486-1506, 2013.
- [12]. ASTM, "Standard Terminology of Fire Standards," *American Society for Testing and Materials*, West Conshohocken, PA, United States, 2001a, ASTM E176.
- [13]. The Syrian Arab Code, "The design and implementation the construction by reinforced concrete," *Syrian Engineers Association, Fourth Edition*, Damascus, Syria, vol. 402, pp. 57-69, 2012.
- [14]. A. Hasan-Ghasemi, M. Nematzadeh, and H. Fallahnejad, "Post-fire residual fracture characteristics and brittleness of self-compacting concrete containing waste PET flakes: Experimental and theoretical investigation," *Engineering Fracture Mechanics*, vol. 261, 108263, 2022.
- [15]. A. Tawashi, and S. Alamoudi, "The Mechanical Behavior of Self-Compacting Concrete SCC Samples Locally Produce," *J. Engineering Sciences and Information Technology, AJSRP*, vol. 6, no. 2, pp. 148-169, 2022.
- [16]. W. TIMO, "Fresh Properties of Self-Compacting Concrete (SCC)," *Otto – Graf Journal*, vol. 14, no. 10, pp. 179-188, 2023.
- [17]. ASTM, "Standard Test Methods for Fire Tests of Building Construction and Materials," *American Society for Testing and Materials*, West Conshohocken, PA, United States, 2000, ASTM E119.