



Research Article

Performance analysis and exergy assessment of an inertance pulse tube cryocooler

Prateek MALWE^{*}, Bajirao GAWALI^{*}, Mahmadrifik CHOUDHARI^{*}, Rustam DHALAIT^{*},
Nandkishor Sheshrao DESHMUKH^{*}

*Department of Mechanical Engineering, Walchand College of Engineering Sangli, Shivaji University,
Maharashtra, 416415, India*

ARTICLE INFO

Article history

Received: 10 March 2021

Accepted: 6 May 2021

Keywords:

Energy Conservation; Exergy Analysis; Inertance Pulse Tube Cryocooler; Exergy Efficiency

ABSTRACT

The world is facing the problems of the energy crisis. Thermal analysis and energy conservation of the engineering devices help to improve their performance. This paper conducted an experimental investigation for the performance analysis and exergy assessment of an Inertance Pulse Tube Cryocooler (IPTC) that uses working fluid - helium operated between 80 K cold end side temperature and room temperature. The variation of the different performance parameters like the effect of charge pressure, pulse tube volume, pulse tube length, etc., and its effect on the refrigerating effect is described graphically. Exergy analysis involves the use and concepts of energy and exergy balances, enthalpy, entropy, and exergy calculations at various stages in the system. Exergy analysis identifies the zones of key exergy destruction that occurs inside the system, which afterward can be subjected to its minimization to amend the system performance. The actual exergy efficiency value calculated for the overall system is 21.30 %. The decreasing order of exergy efficiency among the different components is a compressor (38.79 %), a hot end heat exchanger (6.19 %), regenerator, pulse tube and inertance tube (6 %), and cold end heat exchanger (2.70 %).

Cite this article as: Malve P, Gawali B, Choudhari M, Dhalati R, Deshmukh N S. Performance analysis and exergy assessment of an inertance pulse tube cryocooler. J Ther Eng 2023;9(1):1–11.

INTRODUCTION

Energy is outlined as the capability to execute the work. It is of two types. One is available energy, from which maximum extract of work is obtained, which is called availability or exergy. Another part from which no work

is obtained is called anergy. Energy has a quantity only. In 1955, Dr. Z. Rant first introduced the concept of 'Exergy'. Exergy has both – quantity and quality. Thus, exergy and energy analyses are governed by the second and first laws

*Corresponding author.

*E-mail address: prateek.malwe@walchandsangli.ac.in

*This paper was recommended for publication in revised form by Regional Editor
Hussein A. Mohammed*



of thermodynamics respectively (Dincer & Rosen, 2012). Exergy usually implies an available energy work function. In the area of power-consuming devices, it is defined as the minimum amount of work supply needed to process a system from the present to that of dead state conditions. A branch of engineering science that allocates with the design, development, and maintenance of extreme-low temperatures (of the order of below $-150\text{ }^{\circ}\text{C}$ or 123 K) system is called Cryogenics. An ideal cryogenic fluid should have lower liquefaction temperatures and hence, cryogenics uses hydrogen, helium, nitrogen as the working fluids. Cryogenics is used for numerous purposes like medical innovation, food freezing, the transportation field, and so on. It requires to have the preservation and transfer of such cryogenic fluids. A cryocooler is used to do the same. One system that embodies the cryogenics phenomena in engineering applications is the PTC reported (Gifford & Longworth, 1963). Out of all, PTC is the highly used one (Gifford & Longworth, 1964). It belongs to the class of robust and strengthens refrigeration system that operates without moving parts operating at the low-temperature side (Mikulin, Tarasov, & Shkrebyonock, 1984). They possess the capacity to reach lower temperatures. IPTC is best suited for applications like space vehicles, to improve their thermal performance. PTCs are refrigerators capable of cooling to temperatures below 123 K (Zhu, Wu, & Chen, 1990), (Zhu, Zhou, Yoshimura, & Matsubara, 1997).

For the regenerator of a cryocooler, (Shad & Kamran, 2016) used CFD to validate the thermal performance; which gets influenced by the characteristics of cryogens and the parent material. The analysis of various cycles like Linde-Hampson, etc. for a fixed operating condition for a cryocooler using EES is performed (Yilmaz, Cetin, Ozturkmen, & Kanoglu, 2019). Various parameters like COP, exergy efficiency, etc. are calculated for each of these cycles. Among them all, the Kapitza and Claude emerge as the best performing systems over the others.

The thermal performance of shell and tube heat exchanges for a cryogenic application is analyzed (Nadi, Aliehyaei, Ahmadi, & Turgut, 2021). The heat transfer rate reduces with an increase in the pitch ratio of the pulse tube; thereby causes cost reduction (Zhu & Chen, 1993). The analysis of PTRs and theoretical modelling is executed through numerous analyses - nodal, cyclic, phasor (Atrey, Bapat, & Narayankhedkar, 1990), (Gawali, Atrey, & Narayankhedkar, 2003). These models do not sufficiently reflect the heat transfer and flow features even though they are easy and well-suited to use. The simulation of the entire PTC or the regenerator is performed using the computational models established newly (Ju, Wang, & Zhou, 1998). The use of CFD software helps to perform the simulation of a complete PTCs system. 3D simulations and axis-symmetric of OPTCs, and BPTCs by keeping the effects of orientation and gravity on the performance of the system is implemented (Hozumi, Shiraishi, & Murakami, 2004).

An axis-symmetrical examination of OPTC and BPTC, by making use of a CFD package - Fluent commercial, and pointed out the existence of the streaming effects and recirculation arrays in their modeled pulse tube is shown (Flake & Razani, 2004). A study of multidimensional flow and the effects of heat transfer, and simulation of IPTC using fluent is analyzed (Cha, Ghiaasiaan, Desai, Harvey, & Kirkconnell, 2006). A methodology has been developed to analyze the IPTC system using the exergy analysis technique. The IPTC is the closed system consisting of various assessment techniques (Figure 1) and the geometrical components (Figure 2) (Gawali & Narayankhedkar, 2006).

Exergy analysis of the Stirling cycle cryogenerator is carried out. Results show that the performance of the cycle affects due to finite heat temperature difference and refrigerating effect loss of the system. The second law efficiency for the system is 15.10% (Narayankhedkar, 1998). Exergy analysis of the Gifford McMahon cycle is done under various operating conditions (Thirumaleshwar & Subramanyam, 1986).

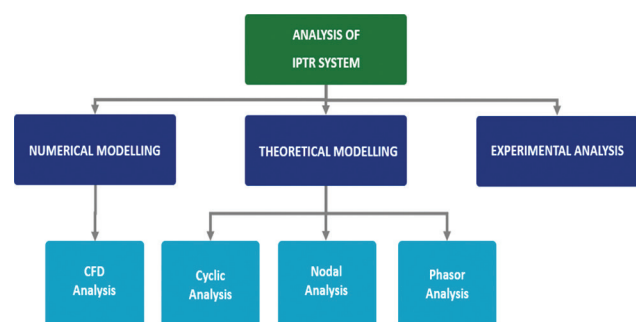

Figure 1. Techniques used in the assessment of the IPTC system.

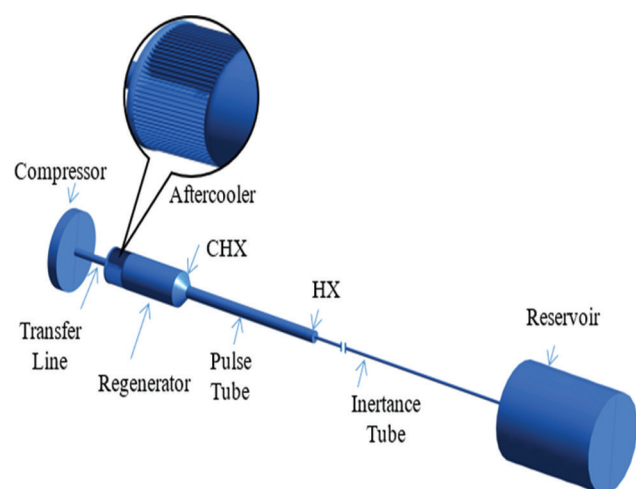

Figure 2. A CFD model for geometrical part components of an IPTC (Choudhari, Gawali, & Malwe, 2021).

In the second law assessment for OPTR, the major exergy destruction cause is obtained for orifice. Input exergy is supplied work to compressor and output exergy is refrigerating effect available across cold end heat exchanger. As pressure ratio increases, exergy efficiency decreases for given cold end and hot end temperatures (Razani, Flake, & Yarbrough, 2004). Regenerator optimization with help of REGEN 3.2 software is done. This type of heat exchanger is one of the major sources of irreversibility and exergy destruction in Pulse tube refrigerators and Stirling. The reason for this is due to the mass flow phase shift variation and its cold end side pressure (Lopez, Dodson, & Razani, 2008). An experimental analysis and performance behavior at a low-temperature of Gifford McMahon and pulse tube cryocooler (using helium) is done (Waele, 2015).

The thermodynamic diagram explains the relationship dependence of temperature concerning time for a cryocooler. Additional to this, the performance considerations and their enhancements are also suggested (Wang, et al., 2008). The input power conditions are varied from 100 W to 200 W, and an effective coaxial single-stage PTC at 60 K is investigated (Mishra & Kumar, 2017). An uppermost value of the Carnot efficiency (relative) of the order of 15.9 % is attained for a coaxial PTC for a 6 W input cooling power (Mohammed, 2009). A computational analysis of hydrogen liquefaction is carried out for 15 bar compressor pressure. The components used in this process are less efficient, which thereby makes this process a costlier one. However, using exergy analysis, for an exergy efficiency of around 20 %, it is found that, system performance diminishes for a corresponding rise in compressor pressure (Thirumaleshwar, 1979). From the heat transfer point of view, the performance assessment can further be improved using the case of nonlinear heat transfer. Different formulae for calculating heat transfer, etc. for temperature-dependent variables are elaborated (Turkylmazoglu M. , 2015). A similar kind of analysis is presented using exact solutions for natural convection phenomenon inside a closed-loop (Turkylmazoglu M. , 2019). A model is proposed (Turkylmazoglu M. , 2016) for a footbath wherein the movement of the foot is considered as a variable parameter that governs the comfort and thermal insulation required during physiotherapy.

Motivation and Objective

At present, the scenario in energy conservation reveals that the world is facing a problem of energy crises. It is because all real processes and systems are not 100 % efficient. Thus, there is an indeed need to look for this challenge of the energy crisis. It has been very well said that energy conserved is what energy saved. From this consideration, in an inertance pulse tube cryocooler operating at low temperatures in the order of 80 K, there is a possibility for leakages inside the system from

atmospheric conditions. To overcome this, a vacuum jacket is installed. Towards justifying the high cost of the system, their performance needs to be improved. This is the driving force that urges to carry out an exergy analysis to quantify the system's thermal performance. The basic objective is to find out exergy destruction across each component present in the system. This throws a light on the area of highest exergy destruction, which later on subjected to its minimizations by adapting remedies over it. The next objective is to compute the overall system's exergy efficiency.

EXPERIMENTAL SETUP

In most PTCs, the working fluid used is helium, primarily since it has the least critical temperature when contrasted with further available gases and helium has larger volumetric heat capacity and thermal conductivity. Helium gas temperature reduces to the atmospheric conditions once it passed on through the aftercooler. Heat transmission concerning the heat exchanger mesh and used fluid takes place. As the gas circulates through the pulse tube cryocooler, a refrigerating effect is produced due to the phase difference mechanism of the working fluid. Lastly, helium gas flows across the heat exchanger (hot end) so throwing out the heat to the surroundings. An inertance tube lowers the working fluid pressure to an average value. This way, the cycle of operation for a PTC gets completed. In an OPTC, suppose the orifice is substituted by an inertance tube, it becomes an IPTC. Consequently, inside the pulse tube, the workflow increases correspondingly for mass flow rate (on a per-unit basis). Concerning the inertance tube's length, a variation in the pressure wave (phase angle) across the pulse tube cold end side and the mass flow. An investigational arrangement developed to examine pulse tube models and is extended with required instrumentation like power source, vacuum pump, temperature indicator, etc.

Components Used

The different systems in the test set-up are vacuum system for unit purging, vacuum system for evacuation of the vacuum chamber which envelops the cold tip, power supply circuit, and instrumentation for vacuum measurement, temperature measurement, heater load supply, and measurement and pressure measurement. Figure 2 and Figure 3 depict various features and details of IPTC and the same is tabularized in Table 1 and Table 2 mentioned underneath.

Table 3 describes various components used.

METHODOLOGY

Exergy is usually available in three forms in any thermal systems and is given as follows (Table 4):

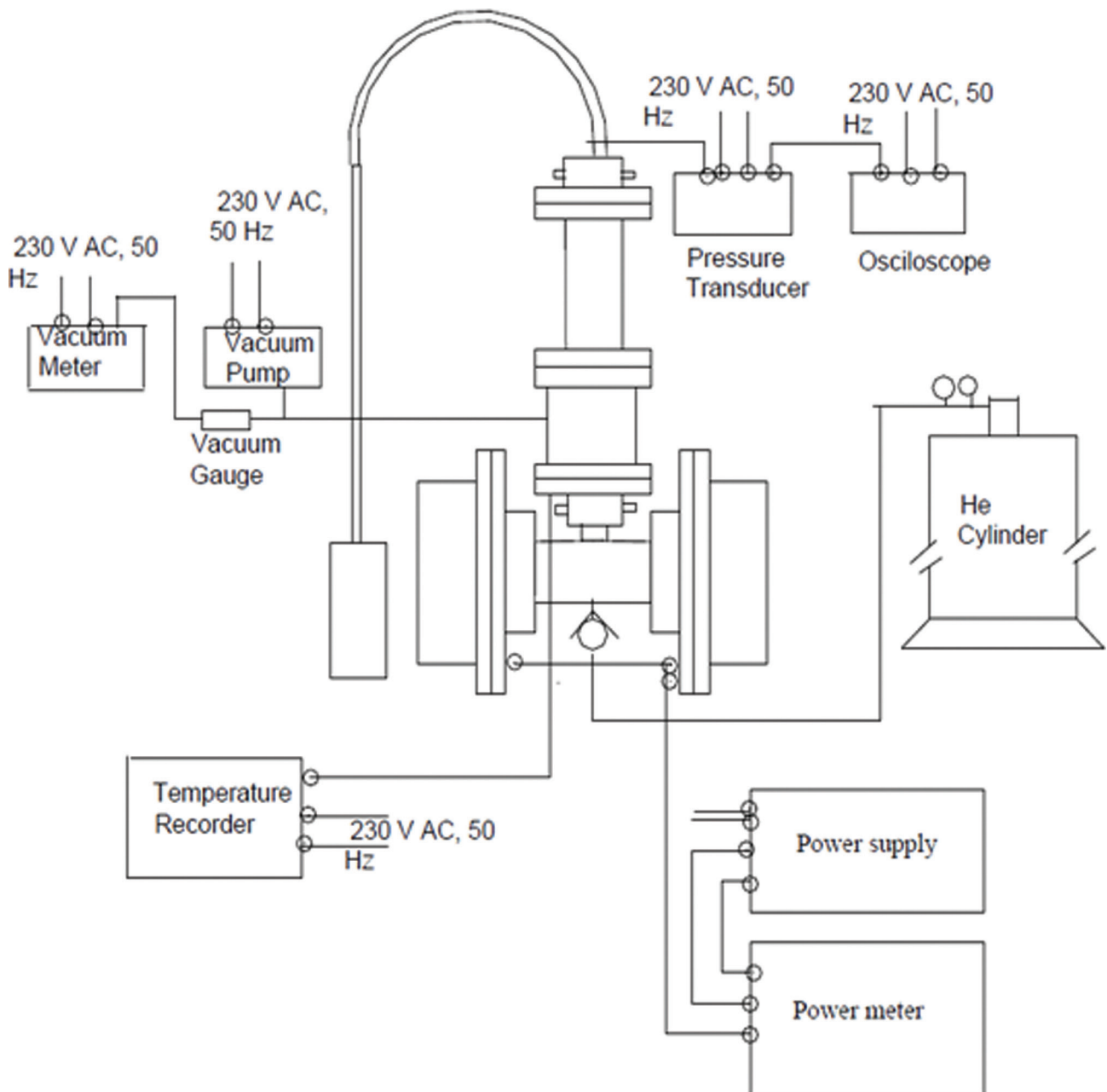

Figure 3. Modified experimental set-up for prototype.

Exergy Analysis

Certain specific assumptions need to be done for performing exergy analysis for considering any practical difficulties that may be encountered during the actual analysis. Subdivide a given system into multiple subsystems. Exergy destruction is calculated across each component. The outcome of this gives the area of major exergy destruction among all components, which can be subjected to its minimizations by ensuring proper remedies over it. The for-mulae for exergy calculations are shown in.

For any system working between initial state and final state, we can write exergy balance as:

$$e_{f1} + e_{q1} + W_1 = e_{f2} + e_{q2} + W_2 + \Delta e \quad (3)$$

RESULTS AND DISCUSSIONS

The pulse tube cryocooler was analyzed and optimized for 70 K at 15 W load condition. Results are given in the form of a net refrigerating effect and power input. The performance

of PTC depends on the phase difference between mass flow and pressure pulse at the cold end of the pulse tube and this phase difference depends on the dimensions of the inertance tube. So, parameters like refrigerating effect and power input are plotted for various geometrical and operational parameters. Figure 4 shows the temperature variation that takes

Table 1. Geometrical parameters of IPTC

Component	Radius (m)	Length (m)
Compressor	0.03090	0.01300
Transfer line	0.00300	0.03796
Aftercooler	0.01400	0.0107
Regenerator	0.01400	0.05400
Cold end heat exchanger	0.01400	0.00879
	0.0096	
Pulse tube	0.00480	0.12850
Hot end heat exchanger	0.00500	0.009
Inertance tube	0.00125	2.00000
Reservoir	0.03889	0.10000

Table 2. Specifications of IPTC

Component Parameter	Unit	Value
Compressor swept volume	cm ³	30
Operating frequency	Hz	50
Transfer line length	mm	36.96
Warm heat exchanger volume	cm ³	5.3
Warm heat exchanger thickness	mm	0.1
Regenerator diameter	mm	28
Regenerator length	mm	54
Regenerator thickness	mm	0.1
Heat exchanger (cold end) thickness	mm	0.1
Heat exchanger (cold end) volume	cm ³	1.8
Pulse tube diameter	mm	12.45
Pulse tube length	mm	70
Thickness of the pulse tube	mm	0.15
Warm heat exchanger 2 volume	cm ³	0.45
Inertance tube diameter	mm	2.5
Volume of the reservoir	cm ³	500
Inertance tube length	mm	2

Table 3. Description of the components used

Component	Description
Compressor	It compresses the gas in the closed chamber and supply to the system accordingly. The compressor used here is a reciprocating type with a double opposed - piston
Warm end heat exchangers	It is meant to captivate and discharge all the heat generated inside the volume of the compressor cylinder during the compression.
Regenerator	It is one of the most crucial components of the IPTC. During the forward stroke, heat gets intake from the inflowing gas stream, and supply the same back to the gas stream during return.
Cold end heat exchanger	It functions the same as that of an evaporator in a refrigeration cycle. Hence, the refrigerating effect in the system soaks up by the cold end side heat exchanger.
Pulse tube	It is supposed to bear and relocate the chilled end side for a corresponding warm end utilizing enthalpy flow is merely a vacant pipe (cylindrical) fabricated of a thin-walled steel tube.
Inertance tube	Steel-made pipe maintains and amends the phase change mass flow and pressure wave.
Reservoir	It's a closed storage reservoir made up of sufficient volume to inculcate small variations in pressure that arise from the oscillating behavior of the mass flow.

Table 4. Forms of exergy

Exergy Type	Description	Formula
Exergy of mass flux	It is caused by the energy part of a flowing stream involving mass flux working between state (1) and ambient (0) conditions given as:	$e_{f1} = (h_1 - h_0) - T_0 (s_1 - s_0)$ (1)
Exergy of heat	It is due to the temperature difference associated with a process. It has always a negative value because work input needs to be supplied for power-consuming systems given:	$e_q = Q \times \left(1 - \frac{T_0}{T}\right)$ (2)
Exergy Balance		
Exergy of work	This is equal to work itself as there are as such no thermodynamic constraints on its usefulness.	---

Table 5. Formulae used for exergy analysis

Exergy Calculations

Exergy supplied is equal to compressor work and is given by:

$$W_{iso} = (e_2 - e_1) \quad (4)$$

Assuming $\eta_{iso} = 60\% = 0.60$

$$W_{act} = \frac{W_{iso}}{\eta_{iso}} \quad (5)$$

Exergy of refrigeration produced is given by:

$$e_{ql} = Q_l \left(1 - \frac{T_0}{T_5} \right) \quad (6)$$

$$Q_l = (h_{12} - h_{11}) \quad (7)$$

Component wise exergy losses

$$\Delta e_{comp} = (W_{act} - W_{iso}) \quad (8)$$

$$\Delta e_{reg} = [(e_2 + e_{11'}) - (e_3 + e_{12})] \quad (9)$$

$$\Delta e_{chx} = [(e_3 + e_{10'}) - (e_4 + e_{11}) + e_{ql}] \quad (10)$$

$$\Delta e_{pt} = [(e_4 + e_9) - (e_5 + e_{10})] \quad (11)$$

$$\Delta e_{hhx} = [(e_5 + e_8) - (e_4 + e_{11}) + e_{qh}] \quad (12)$$

$$\text{where, } e_{qh} = Q_h \left(1 - \frac{T_0}{T_6} \right) \quad (13)$$

$$Q_h = (h_5 - h_6) \quad (14)$$

$$\Delta e_{it} = (e_7 - e_6) \quad (15)$$

$$\Delta e_{unacc} = W_{act} - [e_{ql} + \Delta e_{comp} + \Delta e_{reg} + \Delta e_{chx} + \Delta e_{pt} + \Delta e_{hhx} + \Delta e_{it}] \quad (16)$$

COP & Exergy Efficiency

Ideal and Carnot COP for IPTC are given by:

$$COP_i = \frac{T_c}{T_H} \quad (17)$$

$$COP_{carnot} = \frac{T_c}{T_H - T_c} \quad (18)$$

Ideal exergy efficiency is given as follows:

$$\eta_i = \frac{COP_i}{COP_c} \quad (19)$$

Actual exergy efficiency is given as follows:

$$\eta_{ex} = \frac{RE}{W} = \frac{e_{QL}}{W_{act}} \quad (20)$$

$$\text{Exergetic figure of merit} = \frac{\eta_{ex}}{\eta_i} \quad (21)$$

place during the forward and backward flow along the length of PTC for one cycle of operation. It is shown by dark line and dotted line to visualize and clarify the phase shift.

Cool-down Characteristics

An important performance criterion of the unit is the time it takes from the start-up, to achieve the design temperature of 70 K. This is called cool-down time. The cold-tip “cool-down” from ambient to cryogenic conditions at zero loads is shown in Figure 5. Initially, the cooling is fairly rapid but as time proceeds, thermal losses increase, and taper off and stabilize after a while. For no-load condition, the cyclic steady temperature at CHX is achieved as 39 K for compressor work of 292.8 W.

Effect of Charge Pressure

To study the effect of charge on pulse tube cryocooler performance, experiments were conducted. Three sets (12 bar, 14 bar, and 16 bar) were tested. Compressor supply power is maintained at about 340 W. The variation of cooling load with power input and temperature of the cold end is depicted in Figure 6. Refrigerating effect intensifies with a proportional rise in the charging pressure. For 70 K at 15 W IPTC, optimized charge pressure is 16 bar for pulse tube diameter and length of 9.6 mm and 128.5 mm respectively.

Load Characteristics

To review the influence of refrigeration load variation on the functioning of pulse tubes, experiments were

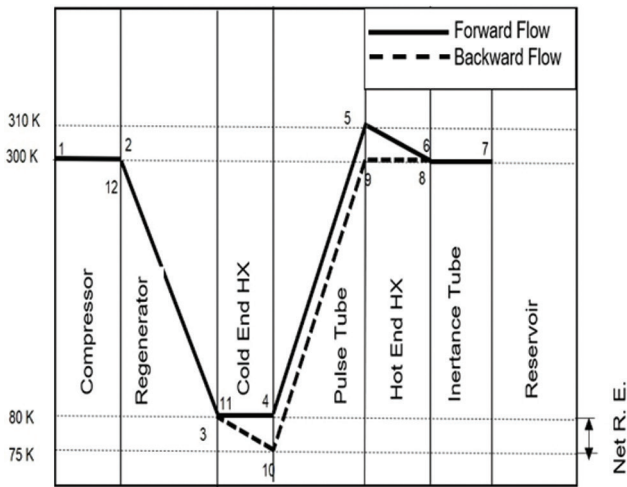

Figure 4. Temperature Variation in Inertance Pulse Tube Cryocooler.

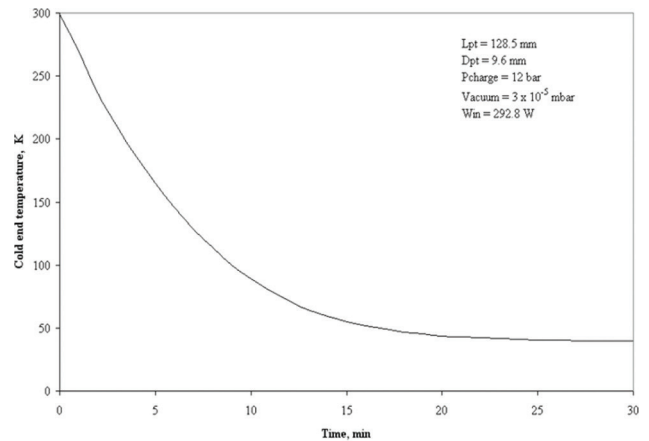

Figure 5. Cool-down characteristics.

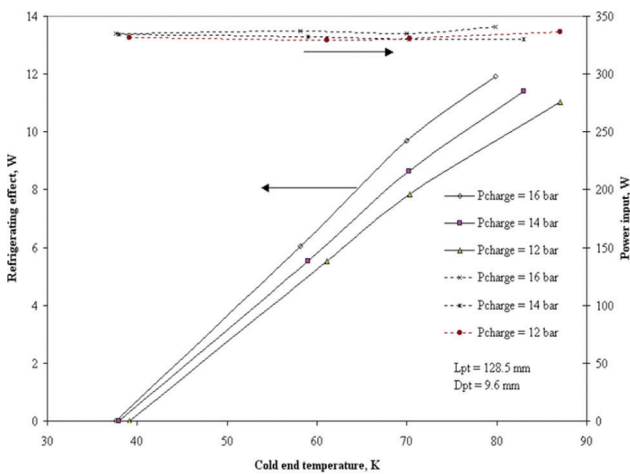

Figure 6. Effect of charge pressure.

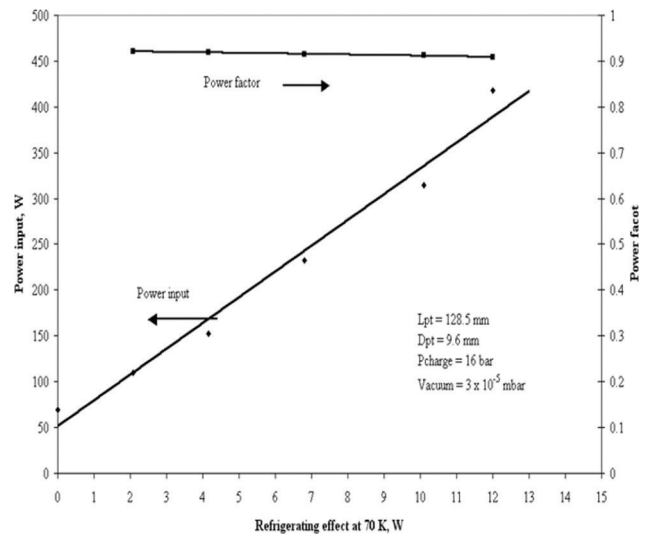

Figure 7. Effect of Load characteristics.

conducted. The cold end temperature was upheld at 70 K. After reaching a steady state, 2 W of the electric load was given and the cryocooler end was allowed to attain a steady-state at 70 K. This process is repeated for loads of 6 W, 8 W, 10 W and 12 W. Maximum cooling of 12 W (heater load) was measured with 418 W of input power. The conduction heat leakage through the thermocouple lead wires and electric wires was estimated to 2.95 W. The load curve and variation in power factor are shown in Figure 7. It shows that there is a marginal variation in the power factor. After accounting for the heat leakages through lead wires refrigerating.

Effect of Pulse Tube Volume

Figure 8 indicates a dependence of the PTC accomplishment on the pulse tube volume. In all the tests, the balance of the geometrical and operating considerations is retained

constantly. The length of the pulse tube varied in the range of 70 mm to 120 mm. The most competent pulse tube verified is 80 mm long for the 12.2 mm diameter.

Effect of Pulse Tube Length

Figure 9 indicates the refrigerating effect plot with the pulse tube length for numerous temperatures maintained across the cold end. Thus, the pulse tube volume reduces refrigerating effect increases and it reaches the maximum and then decreases. It is because as the length reduces the pressure ratio increases. The pulse tube with 80 mm length performs better than any other for the specified condition.

From enthalpy – exergy charts for helium (10 K to 300 K temperatures and 1 to 150 bar pressures), enthalpy, entropy, and exergy state values are estimated (Table 6). Table 7 and Table 8 show different parameters that are estimated using formulae. Table 8 shows component-wise

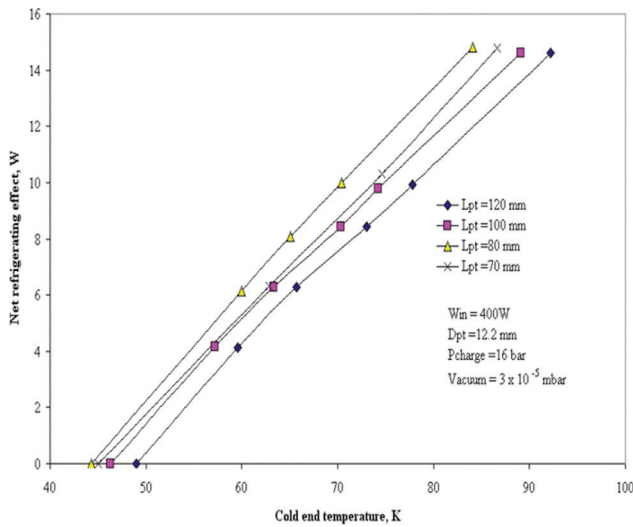

Figure 8. Effect of volume of pulse tube.

Table 6. Thermodynamic properties at various states

State	h (cal/g)	s (cal/g-K)	e (cal/g)
1	385	6.12	420
2	390	6.02	470
3	105	4.28	680
4	105	4.28	680
5	395	6.10	445
6	390	6.02	445
7	387	6.08	450
8	385	6.12	425
9	385	6.12	420
10	95	4.42	650
11	100	4.52	630
12	385	6.12	410

Table 8. Summary of exergy calculations

Parameter	Unit	Value
Ideal COP	-	0.266
Carnot COP	-	0.363
Ideal exergy efficiency	%	73.27
Actual exergy efficiency	%	21.30
Exergetic figure of merit	-	0.29

exergy distribution; the highest exergy efficiency (39 %) is obtained for compressor and least value (6 %) for the heat exchangers and pulse tube. Exergy efficiency varies inversely with the pressure ratio in the compressor. Additionally, the performance assessment reveals the ideal

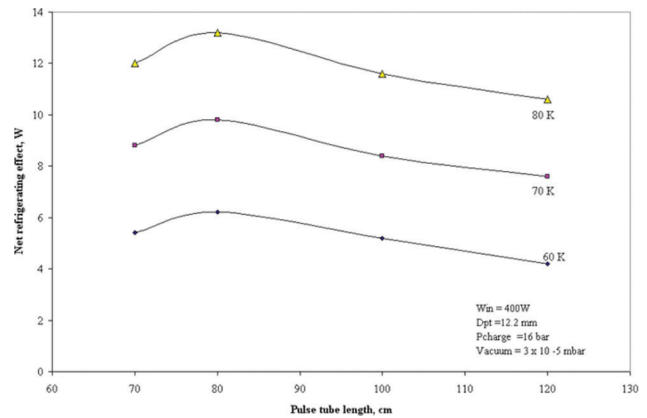

Figure 9. Influence of pulse tube length.

Table 7. Component-wise exergy destruction values

Parameter	Exergy (J/g)	Exergy supplied (%)
Exergy supplied	349.98	100
Exergy utilized	74.55	21.30
Exergy losses	275.85	78.70
Compressor	135.78	38.79
Regenerator	21	6
HX (hot end)	21.67	6.19
Pulse tube	21	6
HX (cold end)	9.45	2.70
Inertance tube	21	6
Unaccounted	45.52	13.02

and actual exergy efficiencies values calculated for the overall system are 73.27 % and 21.30 % respectively. This implies actual exergy destruction or unaccounted exergy of 78.70 % for the overall system. This value obtained is nearer to the value obtained for the case of helium cryorefrigerator (20 %) (Thirumaleshwar, 1979). The unaccounted exergy suggests a loss thereby causing a significant impact on the exergy utilization of the system; hence, it is highly recommended to run the system at as low-pressure ratio as possible. This however may decrease the possible refrigerating effect obtainable. Exergetic figure of merit of 0.29 is calculated. This term signifies the performance of the system and hence, a higher value is always desired.

As the temperature is lowered, a reduction in exergy is observed due to fixed temperature difference at cold end heat exchangers and is worth to be taken into consideration. The distribution of exergy efficiency among various components is shown in Figure 10. Of the total exergy supplied, 21.30 % exergy is utilized as the obtainable refrigerating effect power output. The remaining (78.70 %) signifies exergy destruction or irreversibility. Among all the components, the decreasing order of exergy efficiency is like

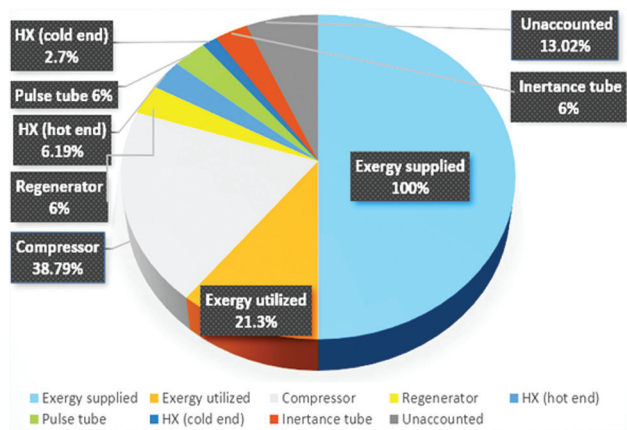

Figure 10. A Sankey diagram for exergy distribution in an IPTC.

compressor (38.79 %), a hot end heat exchanger (6.19 %), regenerator, pulse tube and inertance tube (6 %), and cold end heat exchanger (2.70 %).

CONCLUSION

This paper performed a performance analysis followed by the energy and exergy assessment of an IPTC. The variation of the performance parameters and its effect on the refrigerating effect obtained is explained. From the energy analysis, the ideal and actual COP values of 0.266 and 0.363 respectively are obtained. The variation in these ideal and Carnot COP values is expressed in terms of an ideal exergy efficiency for which the value calculated is 73.27 %. The actual exergy efficiency value calculated for the overall system is 21.30 %. This triggers to improve the system's thermal performance by using an oscillating flow heat exchanger, which may improve the convective heat transfer coefficient and consequently, the performance improves. Exergy utilization of the system varies linearly with cold end temperature. This ultimately reduces exergy destruction losses and increases exergy efficiency. The decreasing order of exergy efficiency among various components is like compressor (38.79 %), a hot end heat exchanger (6.19 %), regenerator, pulse tube and inertance tube (6 %), and cold end heat exchanger (2.70 %). Exergy destruction varies inversely with exergy efficiency. Entropy generation across these components causes loss of available energy, which results in exergy destruction.

NOMENCLATURE

IPTC	Inertance Pulse Tube Cryocooler
PTC	Pulse Tube Cryocooler
PTR	Pulse Tube Refrigerator

CFD	Computational Fluid Dynamics
OPTC	Orifice Pulse Tube Cryocooler
BPTC	Basic Pulse Tube Cryocooler
E	Specific exergy (kJ/kg)
H	Specific enthalpy (kJ/kg)
T	Temperature (K)
S	Specific entropy (kJ/kg-K)
Q	Heat (kJ/kg)
W	Work (kJ/kg)
Δe	Change in exergy (kJ/kg)
η	Efficiency
COP	Coefficient of Performance
RE	Refrigerating Effect (kJ/kg)

Greek Symbols

f	Flow
1	Inlet/suction
0	Dead state conditions
q	Heat
2	Outlet/discharge
<i>iso</i>	Isothermal
<i>act</i>	Actual
ql	Refrigeration load
<i>comp</i>	Compressor
<i>reg</i>	Regenerator
<i>chx</i>	Cold end heat exchanger
<i>pt</i>	Pulse tube
<i>hhx</i>	Hot end heat exchanger
qh	Heat hot end side
<i>it</i>	Inertance tube
<i>unacc</i>	Unaccounted
<i>i</i>	Initial
<i>H</i>	Hot
<i>ex</i>	Exergy

ACKNOWLEDGMENT

This research was performed under the Heat Power Engineering program. The authors would like to confess the encouragement and support given by the Director, TEQIP-III, and HoD - Mechanical Engineering, Walchand College of Engineering, Sangli.

AUTHORSHIP CONTRIBUTIONS

Authors equally contributed to this work.

DATA AVAILABILITY STATEMENT

The authors confirm that the data that supports the findings of this study are available within the article. Raw

data that support the finding of this study are available from the corresponding author, upon reasonable request.

CONFLICT OF INTEREST

The author declared no potential conflicts of interest with respect to the research, authorship, and/or publication of this article.

ETHICS

There are no ethical issues with the publication of this manuscript.

REFERENCES

- [1] Atrey MD, Bapat SL, Narayankhedkar KG. Cyclic simulation of Stirling cryocoolers. *Cryogenics* 1990;30:341–347. [\[CrossRef\]](#)
- [2] Cha JS, Ghiaasiaan SM, Desai PV, Harvey JP, Kirkconnell CS. Multi-dimensional flow effects in pulse tube refrigerators. *Cryogenics* 2006;46:658–665. [\[CrossRef\]](#)
- [3] Choudhari MS, Gawali BS, Malwe P. Numerical analysis of inertance pulse tube refrigerator. *Optimization Techniques and Recent Innovations in Mechanical Engineering (ICOTRIME 2020)*; 2020 Dec 11–12; Ghaziabad, India: IOP Publishing Ltd; 2020. pp. 1–8.
- [4] Dincer I, Rosen MA. *Exergy: Energy, Environment and Sustainable Development*. 2nd ed. Amsterdam: Elsevier Science; 2012. [\[CrossRef\]](#)
- [5] Flake B, Razani A. Modeling pulse tube cryocoolers with CFD. In Waynert J, Barclay J, Breon S, Daly E, Demko J, DiPirro M, et al. editors. *Advances in Cryogenic Engineering, Transactions of the Cryogenic Engineering Conference*; 2003 Sept 22–26; Anchorage, Alaska: American Institute of Physics; 2003. pp. 1493–1499.
- [6] Gawali BS, Narayankhedkar KG. Performance prediction and experimental investigations on integral pulse tube cryocooler for 15 W at 70 K using indigenously developed linear compressor. In Weisend JG, Barclay J, Breon S, Demko J, DiPirro M, Kelley JP, et al. editors. *Advances in Cryogenic Engineering, Transactions of the Cryogenic Engineering Conference (CEC)*; 2005 Aug 29– Sept 2; Keystone, Colorado: American Institute of Physics; 2005. pp. 11–18. [\[CrossRef\]](#)
- [7] Gawali BS, Atrey MD, Narayankhedkar KG. Performance prediction and experimental investigation of orifices pulse tube cryocooler. In Baguer GG, Seyfert P, editors. *Proceedings of the 19th International Cryogenic Engineering Conference*; 2002 Jul 22–26; Grenoble, France: Narosa Publishing House; 2002. pp. 391–394.
- [8] Gifford WE, Longworth RC. Pulse-tube refrigeration. *J Eng Ind* 1964;86:264–268. [\[CrossRef\]](#)
- [9] Gifford WE, Longworth R. Pulse-tube refrigeration progress. *Adv Cryogenic Eng* 1965;10:69–79.
- [10] Hozumi Y, Shiraishi M, Murakami M. Simulation of thermodynamics aspects about pulse tube cryocooler. In Waynert J, Barclay J, Breon S, Daly E, Demko J, DiPirro M, et al. editors. *Advances in Cryogenic Engineering, Transactions of the Cryogenic Engineering Conference*; 2003 Sept 22–26; Anchorage, Alaska: American Institute of Physics; 2003. pp. 1500–1507.
- [11] Ju YL, Wang C, Zhou Y. Numerical simulation and experimental verification of the oscillating flow in pulse tube refrigerator. *Cryogenics* 1998;38:169–176. [\[CrossRef\]](#)
- [12] Lopez A, Dodson C, Razani A. Second-Law analysis and optimization of regenerators using Regen 3.2. In Weisend JG, Barclay J, Breon S, Demko J, DiPirro M, Kelley JP, et al. editors. *Advances in Cryogenic Engineering, Transactions of the Cryogenic Engineering Conference (CEC)*; 2007 Jul 16–20; Chattanooga: American Institute of Physics; pp. 720–727. [\[CrossRef\]](#)
- [13] Mikulin EI, Tarasov AA, Shkrebyonock MP. Low-temperature Expansion Pulse Tubes. In Fast RW, editor. *Advances in cryogenic engineering*. 1st ed. New York: Springer; 1984. pp. 629–637. [\[CrossRef\]](#)
- [14] Mishra RS, Kumar D. Thermodynamic (energy-exergy) analysis of hydrogen liquefaction system. *Int J Res Eng Innov* 2017;1:9–24.
- [15] Mohammed SN. Theoretical experimental and exergy analysis of a single stage orifice pulse tube refrigerator. Thangal Kunju Musaliar College of Engineering, Kollam, University of Kerala, Department of Mechanical Engineering. Kollam: Shodhganga. Last Accessed Date: March 12, 2021. Available at: <https://shodhganga.inflibnet.ac.in/handle/10603/73161>
- [16] Nadi M, Ehyaei MA, Ahmadi A, Turgut OE. Multi-objective particle swarm optimization of the k-type shell and tube heat exchanger (case study). *J Therm Eng* 2021;7:570–583. [\[CrossRef\]](#)
- [17] Narayankhedkar KG. (1998). Exergy Analysis of Stirling Cycle Cryogenerator. In Kittel P, editor. *Advances in cryogenic engineering*. 1st ed. Boston: Springer; 1998. p. 1863–1870. [\[CrossRef\]](#)
- [18] Razani A, Flake B, Yarbrough S. Exergy flow in pulse tube refrigerators and their performance evaluation based on exergy analysis. In Waynert J, Barclay J, Breon S, Daly E, Demko J, DiPirro M, et al. editors. *Advances in Cryogenic Engineering, Transactions of the Cryogenic Engineering Conference (CEC)*; 2003 Sept 22–26; Anchorage, Alaska: American Institute of Physics; 2003. pp. 1508–1518.

- [19] Shad M, Kamran MA. Investigation of the thermal performance of cryogenic regenerator as a porous structure. *J Therm Eng* 2016;2:962–970. [\[CrossRef\]](#)
- [20] Thirumaleshwar M. Exergy method of analysis and its application to a helium cryorefrigerator. *Cryogenics* 1979;19:355–361. [\[CrossRef\]](#)
- [21] Thirumaleshwar M, Subramanyam SV. Exergy analysis of a Gifford-McMahon cycle cryorefrigerator. *Cryogenics* 1986;26:248–251. [\[CrossRef\]](#)
- [22] Turkyilmazoglu M. Nonlinear heat transfer in rectangular fins and exact solutions with temperature dependent properties. *J Therm Sci Technol* 2015;35:29–35.
- [23] Turkyilmazoglu M. Heat transfer from warm water to a moving foot in a footbath. *Appl Therm Eng* 2016;98:280–287. [\[CrossRef\]](#)
- [24] Turkyilmazoglu M. MHD natural convection in saturated porous media with heat generation/absorption and thermal radiation: Closed-form solutions. *Arch Mech* 2019;71:49–64.
- [25] De Waele ATAM. Cryocoolers near their low-temperature limit. *Cryogenics* 2015;69:18–25. [\[CrossRef\]](#)
- [26] Wang N, Zhao M, Ou Y, Zhu Q, Wei L, Chen H, et al. A high efficiency coaxial pulse tube cryocooler operating at 60 K. *Cryogenics* 2018;93:48–50. [\[CrossRef\]](#)
- [27] Yilmaz C, Cetin TH, Ozturkmen B, Kanoglu M. Thermodynamic performance analysis of gas liquefaction cycles for cryogenic applications. *J Therm Eng* 2019;5:62–75. [\[CrossRef\]](#)
- [28] Zhu SW, Chen ZQ. Isothermal model of pulse tube refrigerator. *Cryogenics* 1994;34:591–595. [\[CrossRef\]](#)
- [29] Zhu SW, Zhou SL, Yoshimura N, Matsubara Y. Phase shift effect of the long neck tube for the pulse tube refrigerator. In Ross RG, editor. *Proceedings of the 9th International Cryocooler Conference*; 1996 Jun 25–27; Waterville Valley, New Hampshire: Springer; 1996. pp. 269–278. [\[CrossRef\]](#)
- [30] Zhu S, Wu P, Chen Z. A single-stage double inlet pulse tube cryocooler capable of reaching 42 K. In Ross RG, editor. *Proceedings of the 13th International Cryocooler Conference*; 2004 Mar 29–Apr 1; New Orleans, Louisiana: Springer; 2004. pp. 256–261.