

## Investigation of Diffuser Augmented Wind Turbine Technologies

Beşir ŞAHİN<sup>\*1</sup>, Akın İLHAN<sup>1</sup>, Mehmet BİLGİLİ<sup>2</sup>

<sup>1</sup>Çukurova Üniversitesi, Mühendislik Mimarlık Fakültesi, Makine Mühendisliği Bölümü, Adana

<sup>2</sup>Çukurova Üniversitesi, Ceyhan Mühendislik Fakültesi, Makine Mühendisliği Bölümü, Adana

Geliş tarihi: 09.01.2017

Kabul tarihi: 14.03.2017

### Abstract

Renewable energy technologies play an important role in contribution of global energy demand as well as conservation of the environment. Researchers have realized that wind turbines combined with a diffuser increase efficiency and start generating electricity with a lower wind speed. It is also expected that increasing efficiency of wind turbine results in reduction of energy generation cost. In this respects, designing wind turbine running with high efficiency with a lower wind speed needs further research and development. In this study, performance indicators of variety geometrically structured horizontal and vertical axis wind turbine technologies which their output power augmented through utilization of diffusers were investigated in detail.

**Keywords:** Diffuser, Renewable energy, Wind turbine

## Yayıcı ile Güçlendirilmiş Rüzgar Türbini Teknolojilerinin İncelenmesi

### Öz

Küresel enerji ihtiyacının temin edilmesi ve çevrenin korunumu üzerine katkının sağlanmasında, yenilenebilir enerji teknolojileri önemli rol oynamaktadır. Araştırmacılar, yayıcı ile birleştirilmiş rüzgar türbinlerinin verimliliği artırdığını ve daha düşük rüzgar hızlarında elektrik üretimine başladıklarını fark etmişlerdir. İlaveten, rüzgar türbinine ait verimin artırılması, enerji üretim maliyetinin düşmesine sebep olmaktadır. Bu bakımdan, yüksek verimde ve daha düşük rüzgar hızında çalışan rüzgar türbinlerinin tasarımı ilave araştırma ve geliştirmeye ihtiyaç duymaktadır. Bu çalışmada, yayıcı ile güçlendirilmiş yatay ve dikey eksenli türbin teknolojilerinin farklı geometrilereki performans göstergeleri detaylı bir şekilde incelenmiştir.

**Anahtar Kelimeler:** Rüzgar türbini, Yayıcı, Yenilenebilir enerji

---

\* Sorumlu yazar (Corresponding author): Beşir ŞAHİN, [bsahin@cu.edu.tr](mailto:bsahin@cu.edu.tr)

## 1. INTRODUCTION

Wind power generation systems have been in use more than 3000 years and several different types of wind-mills have been invented 3000 years ago by the appearance of the ancient Persian vertical axis wind-mills. A starting point of wind power generation system started to be used in electrical power generation in late 1800s and early 1900s. Wind turbines mainly started to spread across the world in last three decades as reported by Sørensen [1]. A wind turbine generates power from the wind with the cube of the wind speed, defined by  $P=0.5\rho AV^3$ . Namely, minor rise in wind speed can induce a large increase in wind power generation. For that reason, developing new technologies can considerably accelerate the approaching wind speed is the desired fact. In this respect, augmenting wind turbines with diffuser (DAWT) was first proposed by Lilley and Rainbird [2] in 1956. This work was followed by many other studies such as Oman et al. [3], Igra [4], Foreman et al. [5], Gilbert et al. [6], Igra [7], Gilbert and Foreman [8], Phillips et al. [9], Hansen et al. [10], Bet and Grassmann [11], Jafari and Kosasih [12] and Shonhiwa and Makaka [13].

According to the Betz limit, the maximum possible ideal conversion of wind power is  $C_{Pmax} = 0.593$  [14]. There have been several different designs of wind turbines which cannot generate power beyond the Betz limit as seen in Figure 1. Ilhan performed the processing of the real annual power output data of an installed wind farm where in the case of bare wind turbines, the average monthly power coefficient,  $C_p$  of the identical wind turbines in farm were calculated to be lower than Betz limit [15].

## 2. DEVELOPMENTS OF WIND TURBINE CAPACITY AND INSTALLATIONS

The capacity of wind turbines increased significantly in last two decades and they were classified with different categories by Tummala et al. [17] as presented in Table 1. The leading companies have started to manufacture wind

turbines with the capacities of 7.5-8 MW. It is also known that there are projects for developing wind turbines for offshore installations with the power capacity of 10-20 MW.

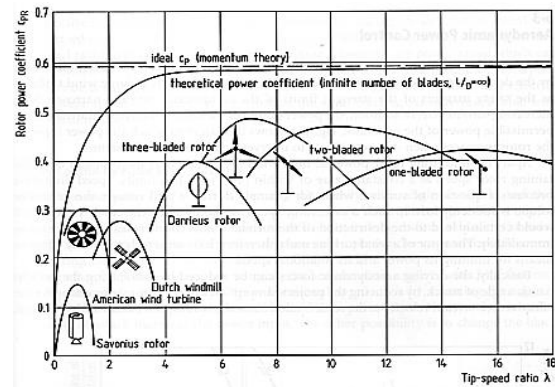


Figure 1. Power coefficient,  $C_p$  of different wind turbine designs, Hau [16]

The global concentration of  $CO_2$  increased from 277 ppm in 1950 to 398 ppm in 2014 which corresponds to 43% [18] due to mostly fossil fuel consumptions. Whole world is very anxious about the impact of  $CO_2$  emissions on the environment. One of the alternatives in the reduction of  $CO_2$  generation is the wind power energy. In this respect, technological development, progress in energy efficiency and considerable growth of energy generation from renewable energy sources are the three among several factors caused this percentage reduction in increase of  $CO_2$  emissions [19].

The global wind power capacity has been growing rapidly for last 10 years as shown in Figure 2. It seems that wind energy generation is one of the most crucial alternatives of reducing fossil fuel consumption which is the main source of  $CO_2$  emissions [20]. In last decade, the cost of initial investment of wind turbines has been declined considerably due to the progress of manufacturing technologies and a high rate of demand on wind turbines resulted of this reduction. In connection with these reasons, global wind power cumulative capacity has grown up significantly. In the near future, the rate of wind power installations is going to be substantially increased worldwide.

**2.1. Wind Turbines with Diffuser**

Shrouding of wind turbines is one of the most important ways of increasing the output power and reducing the cost of power generation. That is to say, an important way of enhancing the wind turbine output power under low wind speed can be achieved through concentrating of air by shrouding geometry. This involves the rotor with diverging and converging ducts to convey the air mass flow rate through the wind turbine at a higher rate. Studies demonstrated that better performance under low free-stream wind speed,  $U$  was observed with concentrating shroud utilization compared to a conventional horizontal or vertical axis wind turbine [13].

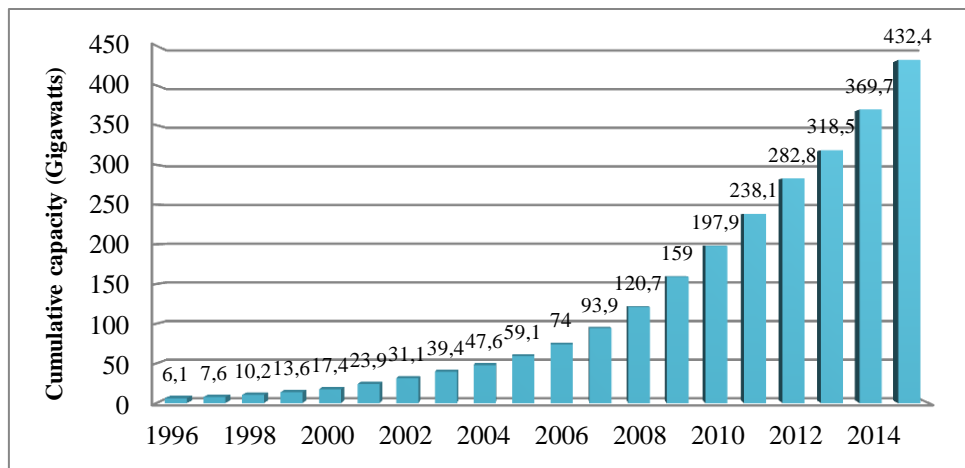
In performance of diffuser augmented wind turbines, most effective design parameters are mainly diffuser cone angle,  $2\theta$ , diffuser length,  $L$  and inlet diameter,  $D_1$  and outlet diameter,  $D_2$ . Three different geometric configurations of

diffusers as shown in Figure 3a were selected by Disterfano et al. [21] measured the axial velocity distributions along the diffuser under variations of diffuser cone angles,  $2\theta$  and lengths,  $L$ . As reported in Figure 3b, the highest velocity,  $u/U = 1.48$  takes place at a location very close to the diffuser entry for the smallest cone angle,  $2\theta = 10^\circ$  and the longest diffuser length ratio,  $L/D = 2.32$  symbolized as diffuser 2. However, Ohya and Karasudani [22] also obtained maximum speed ratio,  $u/U = 1.75$  experimentally, at a location very close to the diffuser entry with opening angle  $2\theta = 8^\circ$  and diffuser length ratio,  $L/D = 7.7$  as seen in Figure 3c.

Innovative and original aspects of ongoing research works focus on ensuring the optimization of a casing system around the turbine consisting of nozzle-diffuser-flange combination or lens is used in order to enhance the performance of small scaled conventional wind turbines having moderate capacity.

**Table 1.** Classification of horizontal axis wind turbines with rotor diameters and power rating, Tummala et al [17]

Type of wind turbine	Rotor diameter (m)		Swept area (m <sup>2</sup> )		Standard power rating (kW)		
Small scale	Micro	0.5	1.25	0.2	1.2	0.004	0.25
	Mini	1.25	3	1.2	7.1	0.25	1.4
	Household	3	10	7.1	79	1.4	16
Small commercial	10	20	79	314	25	100	
Medium commercial	20	50	314	1963	100	1000	
Large commercial	50	100	1963	7854	1000	3000	
Largest commercial	100	160	7854	20106	3000	8000	
Under development [16]	160	220	20106	38013	8000	20000	



**Figure 2.** Global wind power cumulative capacity [19]

In the case of nozzle-diffuser-flange casing system, instead of having a straight diffuser wall, it is better to have a curved wall like an airfoil geometry as seen in Figure 4. Illustration of the axial velocity profile along the central axis of diffuser without wind turbine given by Rio Vaz et al. [23] demonstrates that axial velocity is maximum close to the inlet section of the curved wall diffuser. This presents the importance of curved shrouding on the velocity enhancement.

Conical diffusers as seen in Figure 5a have main parameters of dimensionless length,  $L/D$  and dimensionless flange height,  $H/D$  which effect power coefficient,  $C_p$  significantly. For example, having a small value of dimensionless length based on diffuser exit diameter,  $L/D_2$  causes high cone angle,  $2\theta$  resulting in flow separation in the diffuser which can cause considerable reduction in the overall power coefficient,  $C_p$  as reported by Jafari and Kosasih [12]. Several diffuser geometry performances in terms of wind speed enhancement as presented in Figure 5b were examined by

Shives and Crawford [24], numerically. The diffuser inlet-outlet area ratio,  $D_1/D_2$  or cone angles,  $2\theta$  significantly influence the degree of boundary layer separations from the surface of diffusers to deteriorate the performance of wind turbine which is characterized by a reduction in the diffuser efficiency. In summary, turbine rotor blades initially placed in a diffuser, later a flange was combined with the diffuser, presently, a casing system consisted of a nozzle, diffuser and a flange are used to further upgrade the wind turbine performance by obtaining an increase of air mass flow rate and wind speed passing through turbine blades. Diffuser augmented wind turbine improves the power coefficient,  $C_p$  significantly as seen in Figure 6. Since the conical diffuser of Disterfano et al. [21] is very lengthily, thus, it may not be practical to use for high rate of wind loading due to receiving high wind loading. Considering these reasons, optimized diffuser length,  $L$  is to become shorter in commercially manufactured wind turbines.

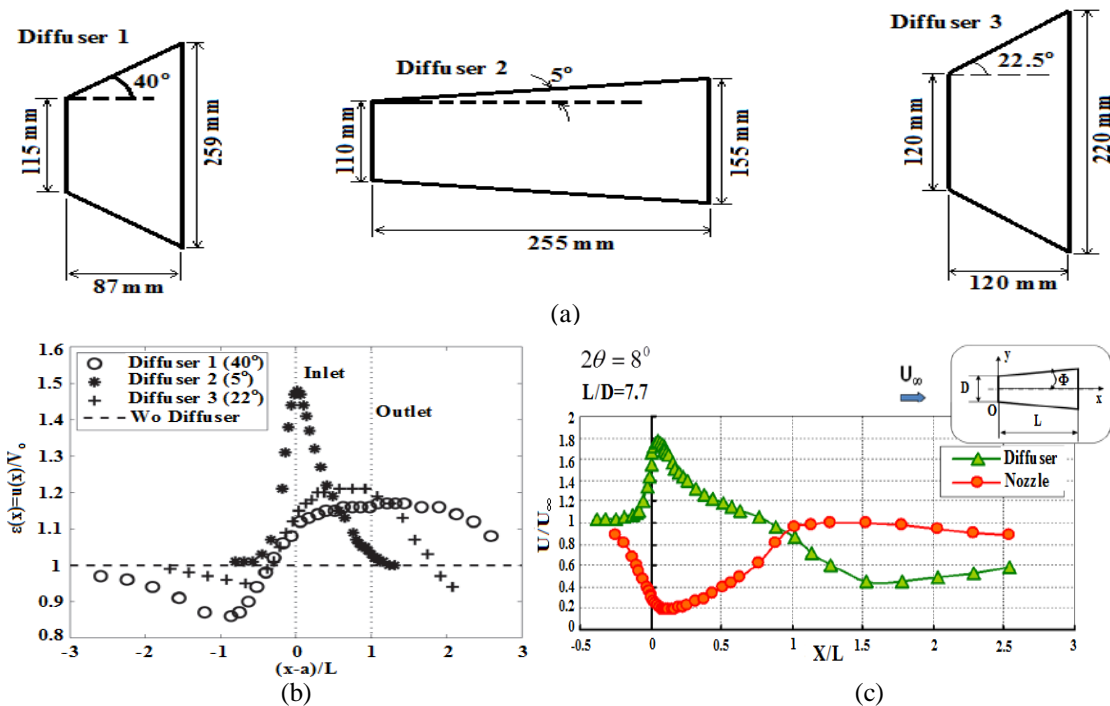
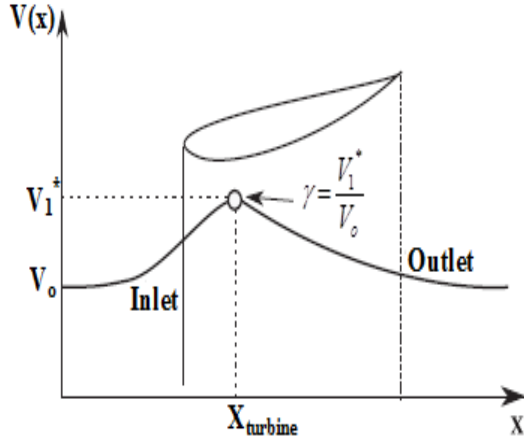


Figure 3. a) Diffusers with different dimensions, b) Velocity distributions along the axis of diffusers [21], and c) Velocity distributions along the axis of diffuser [22]

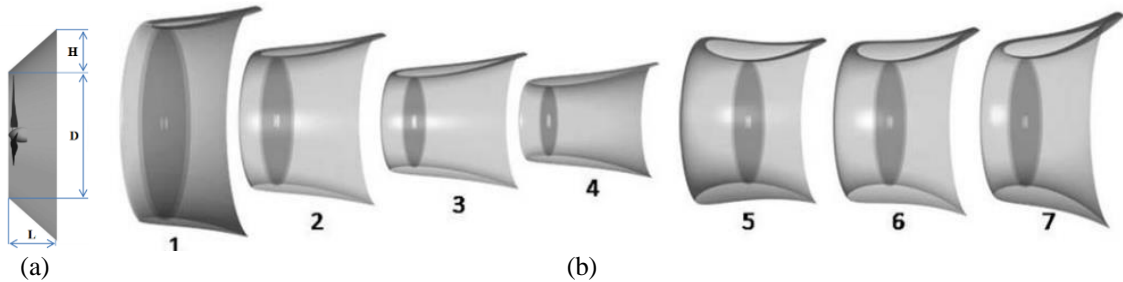


**Figure 4.** Illustration of the axial velocity profile on the symmetry axis of a diffuser without wind turbine [23]

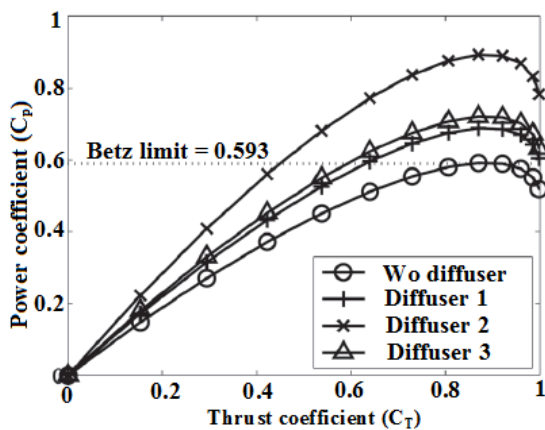
### 2.2. Wind Turbine with Nozzle-Diffuser-Flange

Ohya and Karasudani [22] constructed a diffuser geometry with dimensions of  $L/D= 1.47$  and  $h/D= 0.5$  as shown in Figure 7. Here,  $L$  is the length of the diffuser and  $D$  is the diffuser diameter where turbine is located and  $h$  indicates the height of the flange.

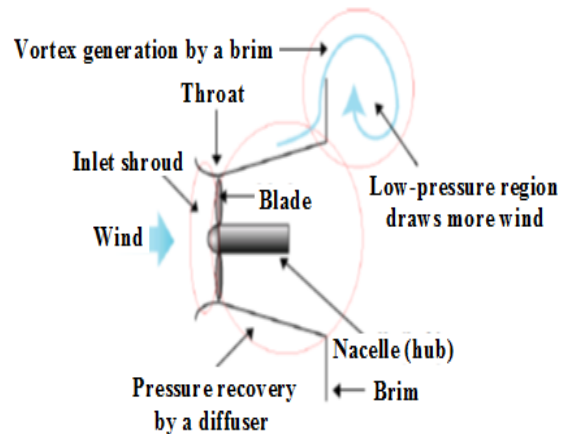
As presented in Figure 7, Ohya and Karasudani [22] reported that flange inclusion to the diffuser increases the output power around 4–5 times that of a conventional wind turbine. The experimental results of Ohya et al. [25] presented that the power coefficient,  $C_p$  of the wind turbine combined with flanged diffuser is  $C_p = 1.4$ , whereas, the power coefficient,  $C_p$  for bare wind turbines is only  $C_p = 0.35$ .



**Figure 5.** a) Diffuser geometry with straight wall [12] and b) Blade profiled diffusers for wind turbines [24]

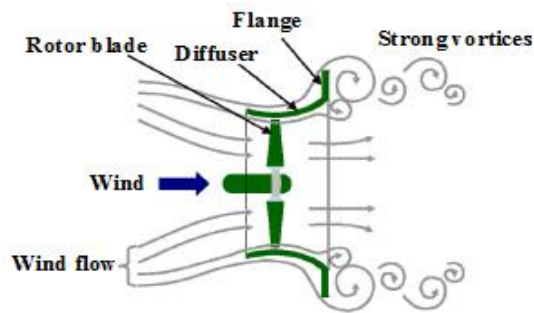


**Figure 6.** Computed power coefficient,  $C_p$  for a rotor in a diffuser given as a function of the thrust coefficient,  $C_T$ , [21]



**Figure 7.** Flow around a wind turbine with brimmed diffuser (nozzle-diffuser-flange), [22]

Ohya and Karasudani [22] combined a shorter curved diffuser with a flange to the outlet periphery of the diffuser and formed a curved nozzle as inlet shrouding attached to the entrance of the diffuser as seen in Figure 8. This flange named as *brim* develops vortices and shedding of these vortices causes a low-pressure region downstream of the diffuser and curved nozzle at the entrance results in higher mass flow rate of air through the wind turbine rotor blades [26].



**Figure 8.** Illustration of curved nozzle-diffuser casing structure including brim [26]

Because of high rate of drag force,  $F_D$ , the axial length of the nozzle-diffuser-flange type casing was constrained.



**Figure 9.** Propeller placed inside the shrouding form of double airfoil structures [11]

Bet and Grassmann [11] concluded that one can increase power generation by a factor of 2 comparing to the bare wind turbine when an optimum length of diffuser consisted of a couple of wind profiles as shown in Figure 9 that has an area equal to the swept area of the rotor. Similar numerical work was also conducted by Kannan et

al. [27] using two diffusers with straight walls as a casing for wind turbine.

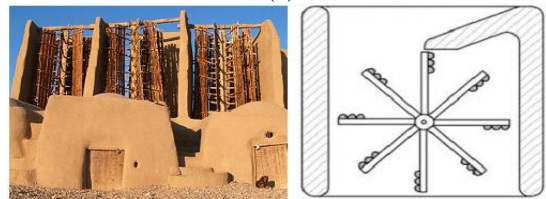
### 2.3. Vertical Axis Wind Turbine

Presently, reviewed turbines are capable of producing electricity generation in lower wind speeds; they attain to their maximum power values with lower wind speeds as well and also result of generating higher efficiencies. On the other hand, a few samples of vertical axis wind turbines are shown in Figure 10a. However, it is worth to mention that the earliest known vertical axis windmills built by Persians in Nashtifan which is in the east of Khorasan of Iran approximately 2500-3000 years ago for the purpose of grinding grains and those had a concentrator as shown in Figure 10b. The diffuser shaped shroud as seen in Figure 11, along with a few other changes, are able to significantly improve the power generated by the vertical axis turbine which corresponds to a rise of about 2.5 times the power coefficient,  $C_p$ .

In recent years; numerical, analytical and all experimental works are also performed by several other researchers to optimize design parameters of vertical axis wind turbines.



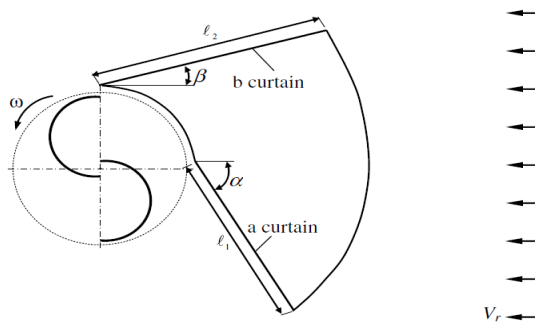
(a)



(b)

**Figure 10.** a) Samples of vertical axis wind turbines, b) The earliest known vertical axis windmills built by Persians in Nashtifan located in the east of Khorasan of Iran

The studies of Altan et al. [28] introduce a new concentrator arrangement to improve the performance of Savonius type vertical axis wind turbines. The diffuser type concentrator was placed in front of the rotor preventing the negative torque opposite the rotor rotation. The geometrical parameters of guide vanes conveying the air into VAWT rotor were optimized to generate an optimum performance. They found that maximum power coefficient,  $C_p$  of the Savonius type vertical axis wind turbine is increased to about 38.5%.



**Figure 11.** Geometrical parameters optimized for the entrance arrangement of vertical axis wind turbine ( $L_1= 45$  cm,  $L_2= 52$  cm,  $\alpha= 45^\circ$ ,  $\beta= 15^\circ$ ) [25]

### 3. CONCLUSIONS

In this regards, renewable energy technologies play an important role in contributing global energy demand and conservation of the environment. Researchers have realized that wind turbines that are combined with a diffuser structure result increase of the efficiency and those start generating of electricity at lower wind speed values. Thus, usage of lens around a wind turbine can also serve in exceeding of the Betz limit. Also, system components manufactured with lighter materials such as carbon fiber cause reduction of the overall weight of the system. Prevailing with these new types and utilization from the moderate capacity wind turbines globally increase the total installed wind capacity of the world. Namely, total area of the constructed wind farms expands with these new technologies. Eventually, wind turbines combined with diffuser increase efficiency and

those start generating electricity at lower wind speed values.

### 4. ACKNOWLEDGEMENTS

The authors wish to thank the office of Scientific Research Projects of Cukurova University for funding this project under Contract No. FED-2016-7128.

### 5. REFERENCES

1. Sørensen, J. N., 2011. Aerodynamic Aspects of Wind Energy Conversion, *Annu Rev Fluid Mech.*, 43, p. 427-448.
2. Lilley, G. M., Rainbird, W. J., 1956. A Preliminary Report on the Design and Performance of Ducted Windmills; Report 102; College of Aeronautics Cranfield: Cranfield, UK.
3. Oman, R. A., Foreman, K. M., Gilbert, B. L., 1975. A Progress Report on the Diffuser Augmented Wind Turbine, In Proceedings of the 3<sup>rd</sup> Biennial Conference and Workshop on Wind Energy Conversion Systems, Washington, DC, USA, 8(12), p. 829–826.
4. Igra, O., 1977. Compact Shrouds for Wind Turbines, *Energy Conversion and Management*, 16, p. 149–157.
5. Foreman, K. M., Gilbert, B., Oman, R. A., 1978. Diffuser Augmentation of Wind Turbines, *Solar Energy*, 20, p. 305–311.
6. Gilbert, B. L., Oman, R. A., Foreman, K. M., 1978. Fluid Dynamics of Diffuser-Augmented Wind Turbines, *Journal of Energy*, 2, p. 368–374.
7. Igra, O., 1981. Research and Development for Shrouded Wind Turbines, *Energy Conversion and Management*, 21, p. 13–48.
8. Gilbert, B. L., Foreman, K. M., 1983. Experiments with a Diffuser-Augmented Model Wind Turbine, *Trans. ASME, Journal of Energy Resources Technology*, 105, p. 46–53.
9. Phillips, D. G., Richards, P. J., Flay, R. G. J., 2002. CFD Modelling and the Development of the Diffuser Augmented Wind Turbine, *Wind and Structures*, 5, p. 267–276.

10. Hansen, M. O. L., Sørensen, N. N., Flay, R. G. J., 2000. Effect of Placing a Diffuser Around a Wind Turbine, *Wind Energy*, 3, p. 207–213.
11. Bet, F., Grassmann, H., 2003. Upgrading Conventional Wind Turbines, *Renewable Energy*, 28, p. 71–78.
12. Jafari, S. A. H., Kosasih, B., 2014. Flow Analysis of Shrouded Small Wind Turbine with a Simple Frustum Diffuser with Computational Fluid Dynamics Simulations. *Journal of Wind Engineering and Industrial Aerodynamics*, 125, p. 102–110.
13. Shonhiwa, C., Makaka, G., 2016. Concentrator Augmented Wind Turbines: A Review, *Renewable and Sustainable Energy Reviews*, 59, p. 1415–1418.
14. Bilgili, M., Yasar, A., Ilhan, A., Sahin, B., 2015. Aerodynamic Characteristics of a Horizontal Axis Wind Turbine in Belen-Hatay, Turkey, *International Journal of Natural and Engineering Sciences*, 9 (1), p. 54-58.
15. Ilhan, A., Efficiency Analysis of an Installed Wind Farm, MSc Thesis, Cukurova University, Institute of Natural and Applied Sciences, Adana, 2014.
16. Hau, E., 2006. *Wind Turbines: Fundamentals, Technologies, Application, Economics*, Springer, Germany.
17. Tummala, A., Velamati, R. K., Sinha, D. K., Indraja, V., Krishna, V. H., 2016. Review on Small Scale Wind Turbines, *Renewable and Sustainable Energy Reviews*, 56, p. 1351-1371.
18. Renewable Energy Policy Network for the 21<sup>st</sup> Century, Renewables, Global Status Report, 2016. Available from <http://www.ren21.net/status-of-renewables/global-status-report/>
19. Global Wind Energy Council, Global Wind Statistics, 2015. Available from [http://www.gwec.net/wp-content/uploads/vip/GWEC-PRstats-2015\\_LR.pdf](http://www.gwec.net/wp-content/uploads/vip/GWEC-PRstats-2015_LR.pdf)
20. Bilgili, M., Ozbek, A., Sahin, B., Kahraman, A., 2015. An Overview of Renewable Electric Power Capacity and Progress in New Technologies in the World, *Renewable and Sustainable Energy Reviews*, 49, p. 323-334.
21. Disterfano, L. M., Jerson, R. P. B., Savio, W. O. V., Oliveira, E. F. M., Erb, F. S. L., Lins, S. E. F., Mesquita, A. L. A., 2015. An Investigation of a Mathematical Model for the Internal Velocity Profile of Conical Diffusers Applied to DAWTs, *Annals of the Brazilian Academy of Sciences*, 87(2), p. 1133-1148.
22. Ohya, Y., Karasudani, T., 2010. A Shrouded Wind Turbine Generating High Output Power with Wind-Lens Technology, *Energies*, 3, p. 634–649.
23. Rio Vaz, D. A. T. D., Mesquita, A. L. A., Vaz, J. R. P., Blanco, C. J. C., Pinho, J. T., 2014. An Extension of the Blade Element Momentum Method Applied to Diffuser Augmented Wind Turbines, *Energy Conversion and Management*, 87, p. 1116–1123.
24. Shives, M., Crawford, C., 2011. Developing an Empirical Model for Ducted Tidal Turbine Performance Using Numerical Simulation Results, *Proc. Inst. Mech. Eng., Part A, Journal of Power and Energy*, 226(1), p. 112-125.
25. Ohya, Y., Karasudani, T., Sakuraib, A., Abeb, K., Inouec, K., 2008. Development of a Shrouded Wind Turbine with a Flanged Diffuser, *Journal of Wind Engineering and Industrial Aerodynamics*, 96, p. 524–539.
26. Wang, W. X., Matsubara, T., Hu, J., Odahara, S., Nagai, T., Karasutani, T., Ohya, Y., 2015. Experimental Investigation into the Influence of the Flanged Diffuser on the Dynamic Behavior of CFRP Blade of a Shrouded Wind Turbine, *Renewable Energy*, 78, p. 386–397.
27. Kannan, T. S., Mutasher, S. A., Kenny Lau, Y.H., 2013. Design and Flow Velocity Simulation of Diffuser Augmented Wind Turbine Using CFD, *Journal of Engineering Science and Technology*, 8(4), p. 372-384.
28. Altan, B. D., Atilgan, M., Ozdamar, A., 2008. An Experimental Study on Improvement of a Savonius Rotor Performance with Curtaining, *Experimental Thermal and Fluid Science*, 32, p. 1673–1678.