

EXCAVATIONS AT KÜLTEPE 1954 FINDS ON LEVEE Ib

TAHSİN ÖZGÜÇ

I

The excavations at Kültepe-Kaniş and the karum of Kaniş, conducted on behalf of the Turkish Historical Society and the General Direction of Antiquities and Museums, were continued in 1954 during the months of July, August, and September. The staff was the same as in 1953, with the addition of Dr. KEMAL BALKAN, who returned from Chicago at the beginning of the season, and of Dr. KADRIYE YALVAÇ. These two colleagues of ours thus had the opportunity to study the tablets at the site itself. The 1954 excavations were carried on with two aims :

- a) To arrive, in the light of the level Ib tablets, at a better understanding of the relation between the two building levels through an investigation of both levels I and II over as wide an area as possible.
- b) To open the graves under the floor level of the level II buildings previously excavated in squares N, O, P, R/18-21¹.

On level Ib our staff discovered in squares U and V/23, 24, 25 many houses and graves containing tablets, house-hold articles and burial presents, and in squares Z-aa/26-27 a workshop opening on the street². The objects found in the houses and graves of both levels were of such great quantity and variety that it is impossible to discuss all of them within the limits of one preliminary report. For this reason we have found it expedient to publish the results of the 1954 excavations in two reports, the first dealing with level Ib, the second with level II. Thus, it will be possible to offer the results of the karum

¹ The excavations carried on in squares E-F/5 and ee/41-42 have illuminated some points which had remained obscure during the 1953 excavations.

² We shall not discuss this workshop here since we published it separately.

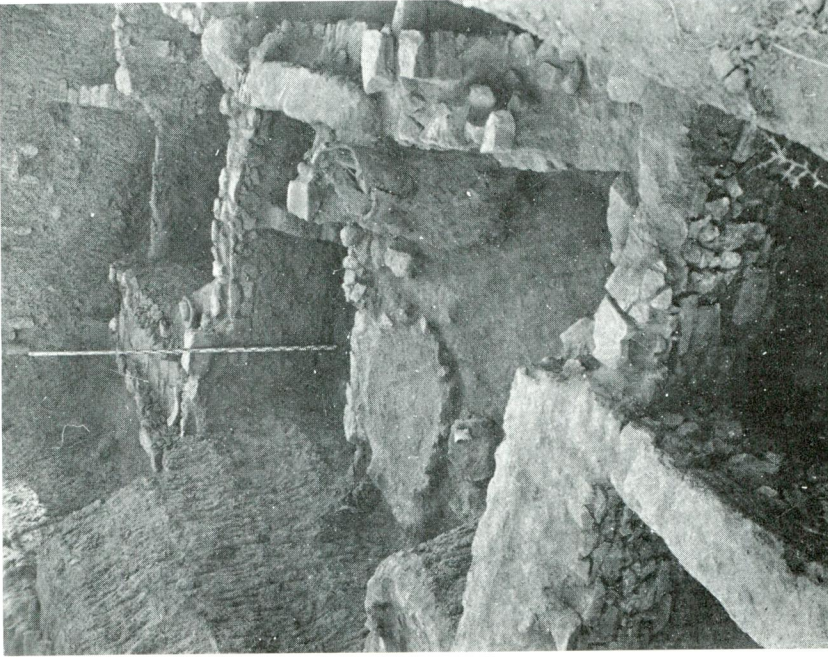

Res. 2 — Fig. 2

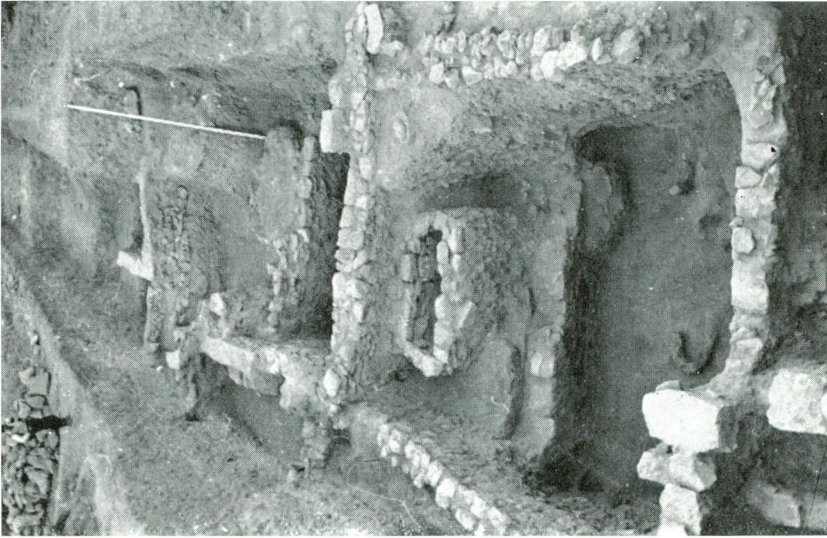

Res. 1 — Fig. 1



Res. 3 — Fig. 3

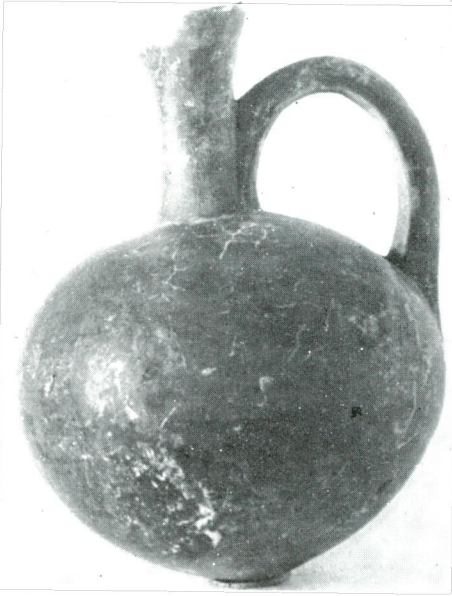

Res. 4^a — Fig. 4^a



Res. 4^b — Fig. 4^b



Res. 5 — Fig. 5



Res. 6 — Fig. 6



Res. 7 — Fig. 7



Res. 8 — Fig. 8



Res. 9a — Fig. 9a

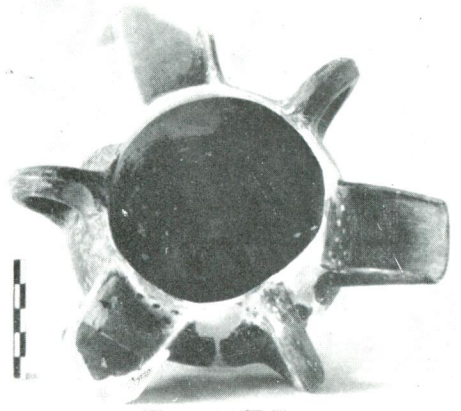

Res. 9b — Fig. 9b



Res. 10a — Fig. 10a

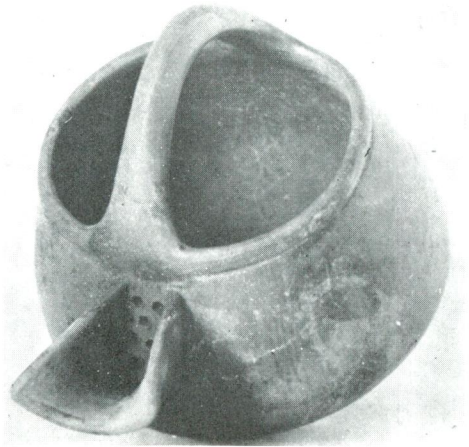

Res. 10b — Fig. 10b



Res. 11 — Fig. 11



Res. 12 — Fig. 12



Res. 13 — Fig. 13

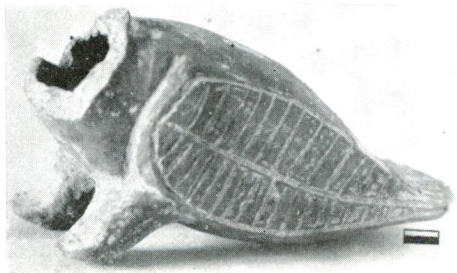

Res. 14 — Fig. 14



Res. 17 — Fig. 17

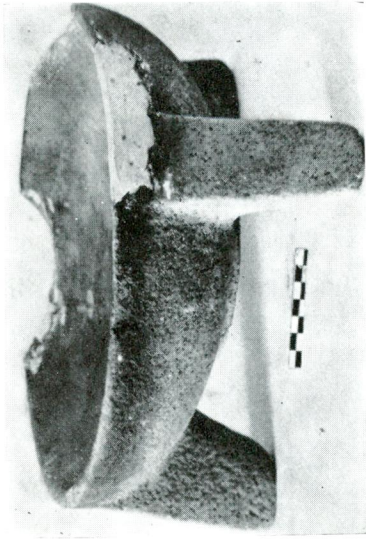

Res. 15 — Fig. 15

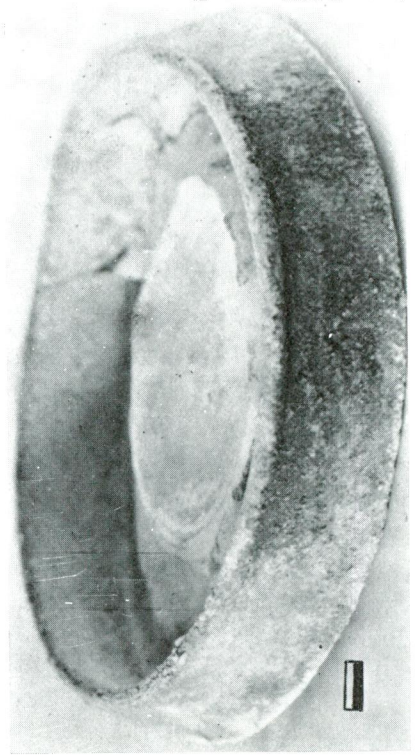

Res. 18 — Fig. 18

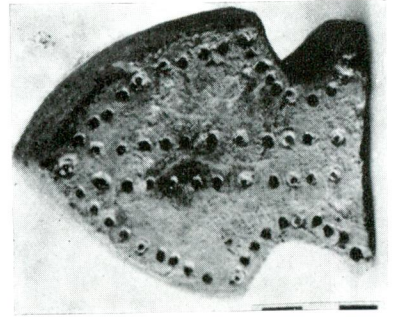

Res. 16 — Fig. 16



Res. 19 — Fig. 19

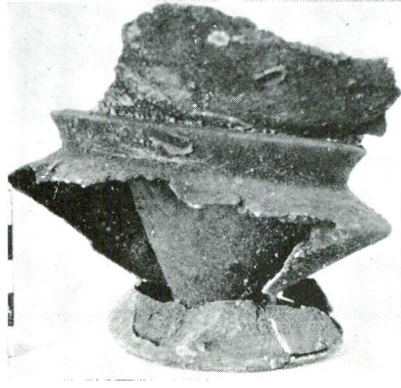

Res. 20a — Fig. 20a

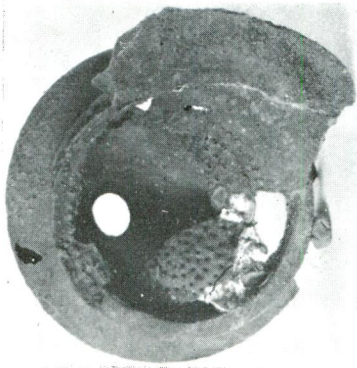

Res. 20b — Fig. 20b

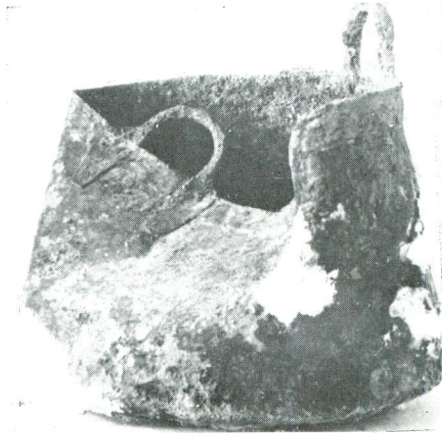

Res. 21 — Fig. 21

T. Özgüç

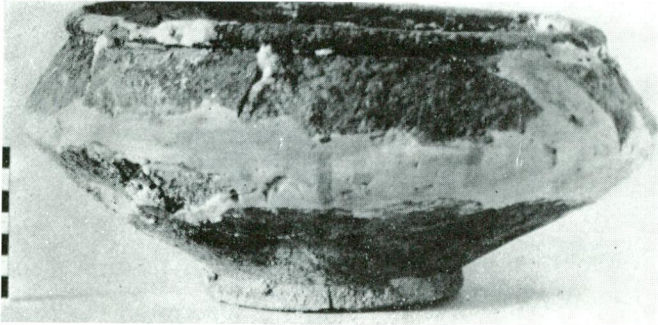

← Res. 22
Fig. 22

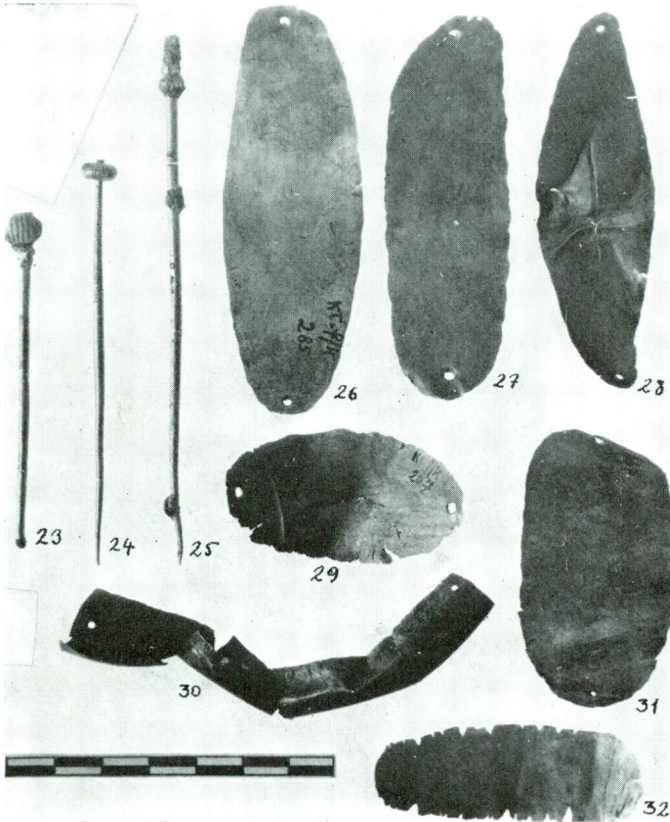

← Res. 23-32
Fig. 23-32

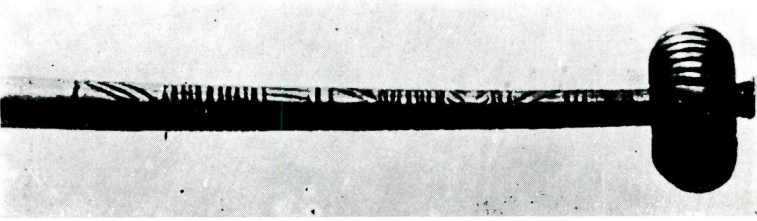

Res. 33 — Fig. 33

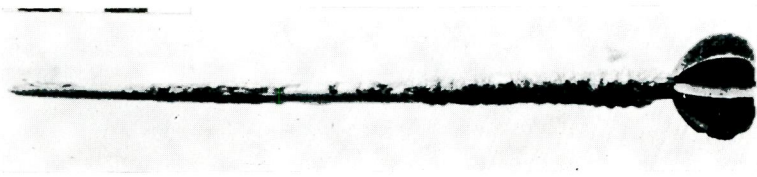

Res. 34 — Fig. 34

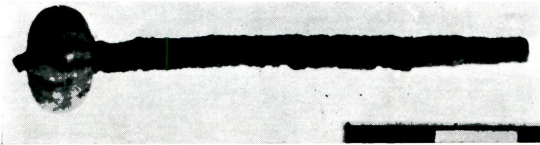

Res. 35 — Fig. 35



Res. 36 — Fig. 36

T. Özgüç



Res. 37a — Fig. 37a

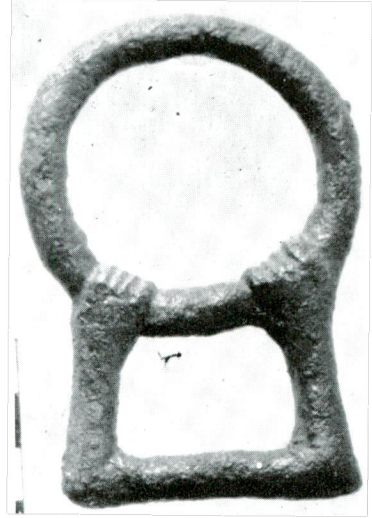

Res. 37b — Fig. 37b

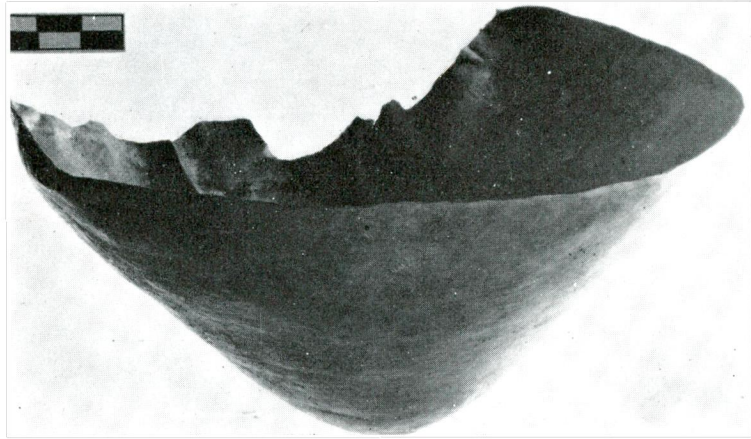

Res. 38 — Fig. 38

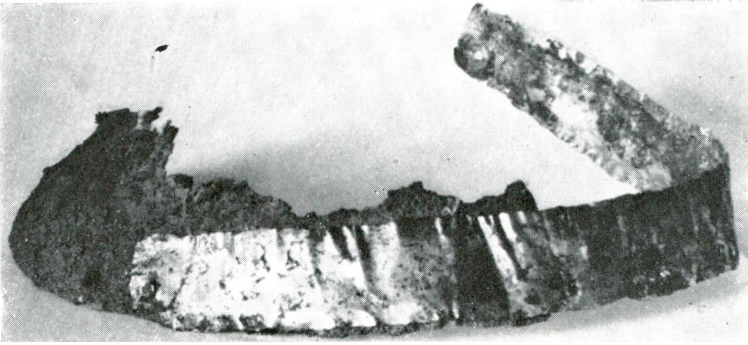

Res. 39^a — Fig. 39^a

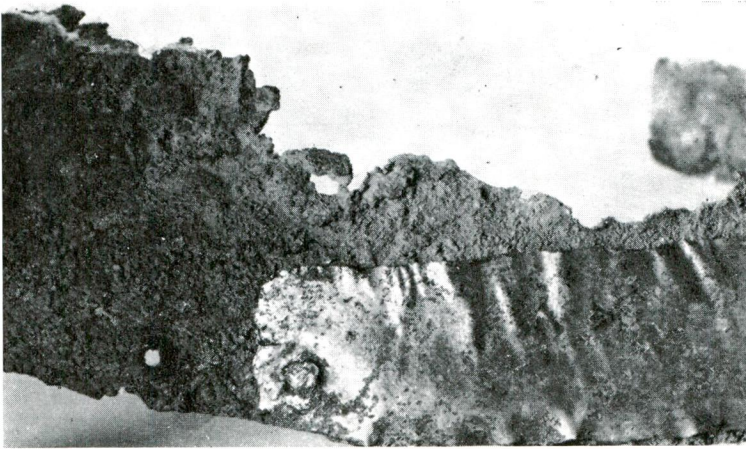

Res. 39^b — Fig. 39^b

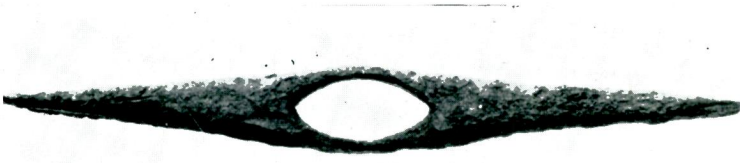

Res. 41^b
Fig. 41^b



Res. 41^a
Fig. 41^a



Res. 40^b
Fig. 40^b

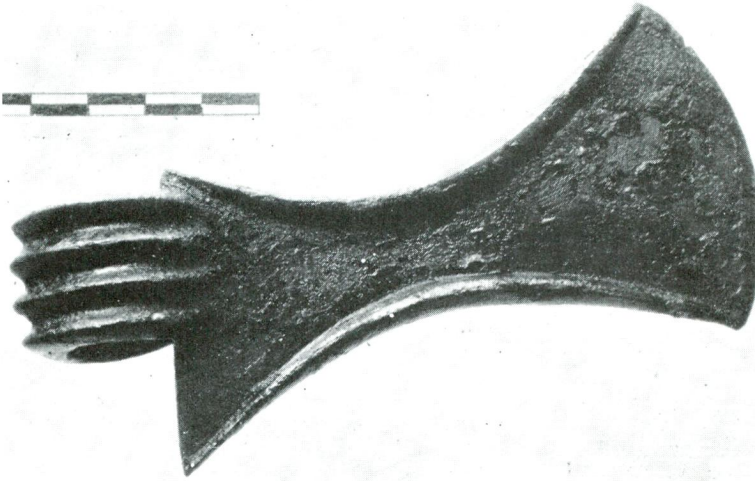

Res. 40^a — Fig. 40^a

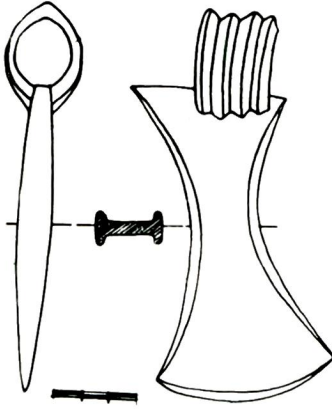

Res. 42 — Fig. 42

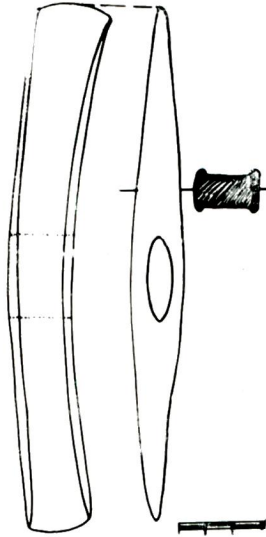

Res. 43 — Fig. 43

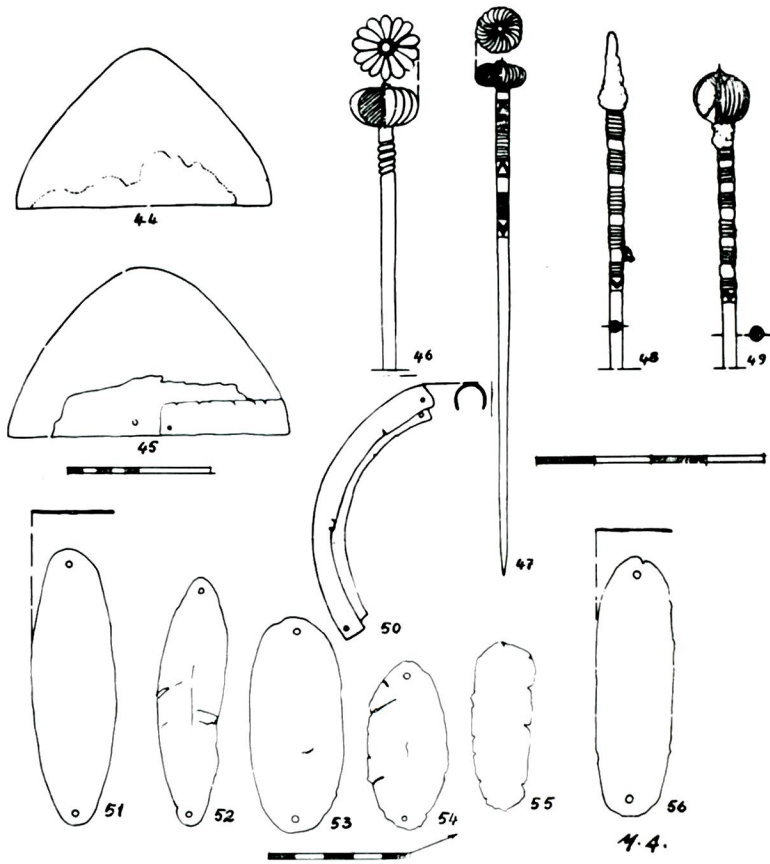

Res. 44 - 56 — Fig. 44 - 56

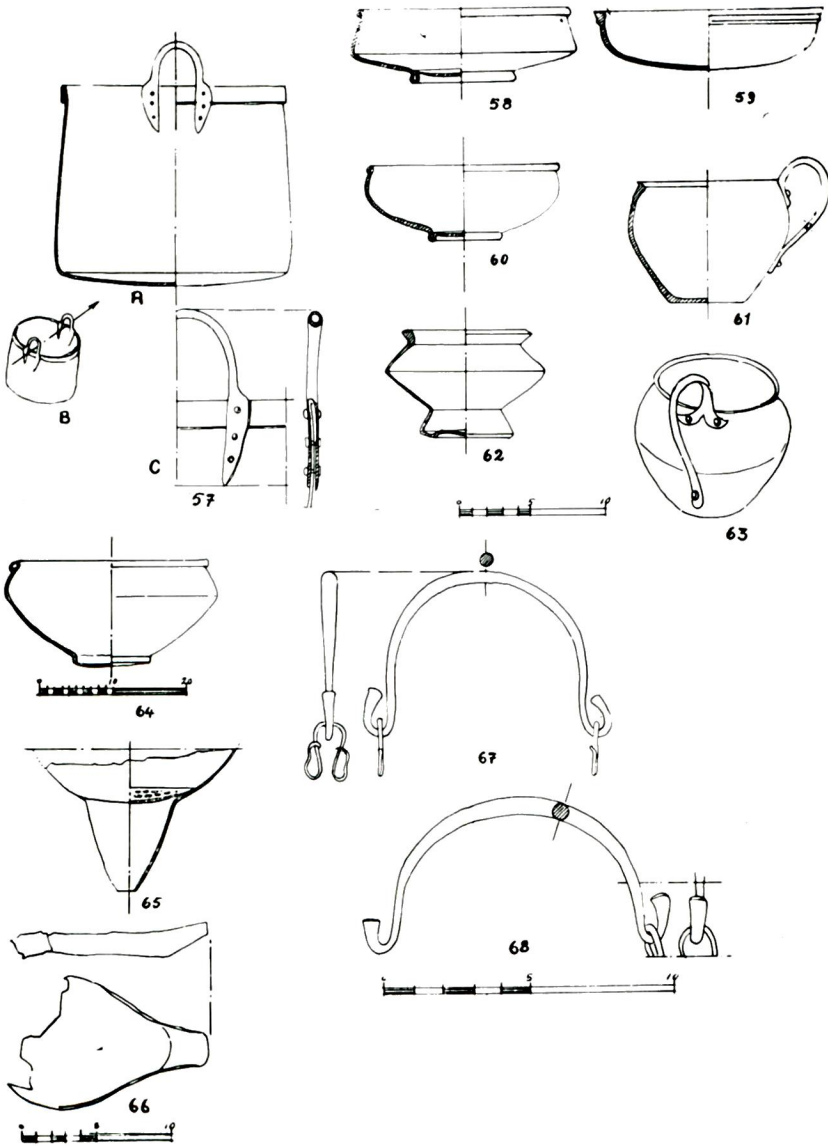

Res. 57 - 68 — Fig. 57 - 68

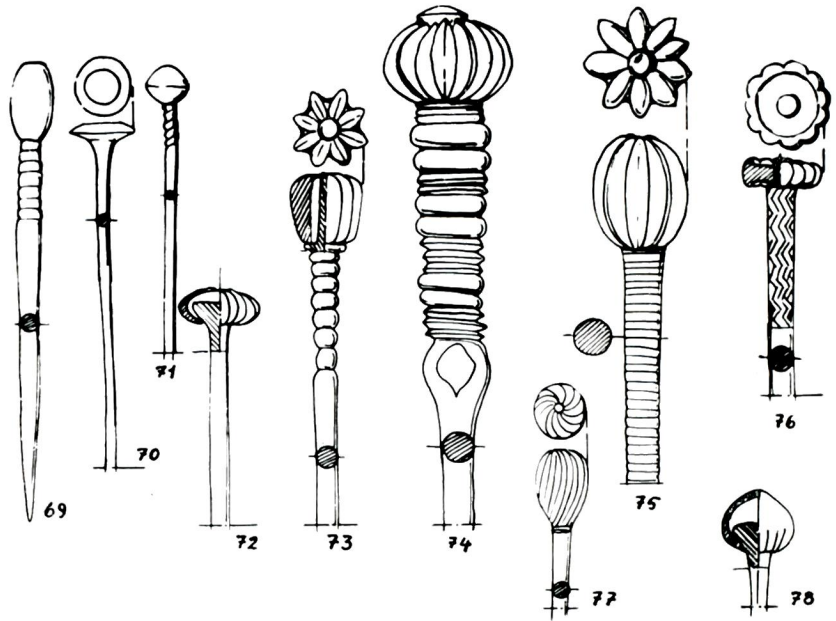

Res. 69 - 78 — Fig. 69 - 78

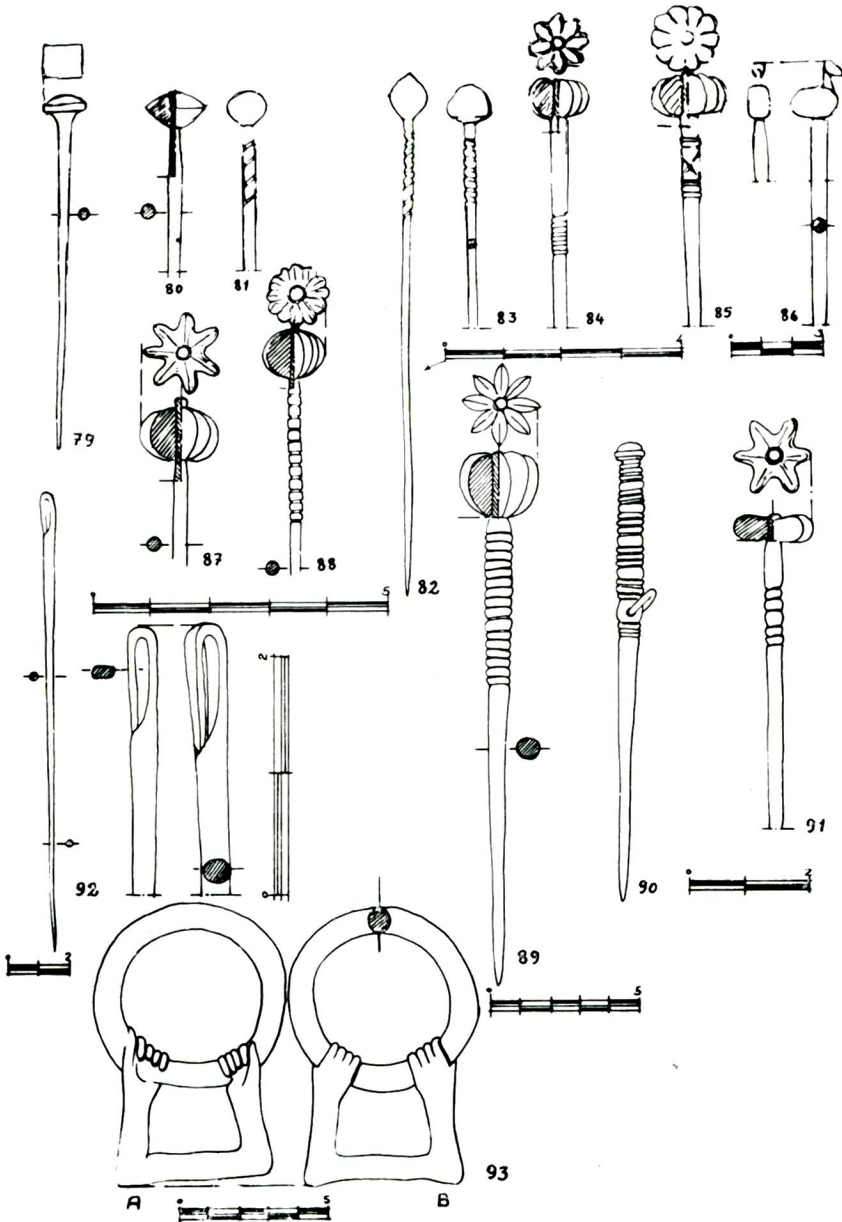

M. 4. 1953

Res. 79 - 93 — Fig. 79 - 93

excavations, which are shedding light on one period of Anatolian archaeology, supported by a greater wealth of material.

The buildings excavated in squares U and V/23, 24, 25 were well preserved and the household articles were found *in situ* (Plan 1). We hope to finish in 1955 the excavation of the building in squares V/23-24, with floor level at a depth of 2.48 m., of which we have so far partially opened two rooms. The south wall of the building to the west of it, the two rooms of which can be seen in U-V/23-24, has not yet been excavated. In the middle of this 8 m. long building there is an oven, of which only the floor has been preserved (Fig. 1-2). The stone wall adjoining the oven to the west divides the building into two parts. Jars and hand-mill stones are placed around the oven and at the foot of the walls (Fig. 2). The oven with its floor at a depth of 2.84 m. belongs to the Ia stone walls which, in some parts of this area, have been built on top of the Ib mud-brick walls.

That rooms nos. 5, 6, 7 in U-V/24-25 are part of the building in U-V/23-24 (rooms nos. 1-4) can be seen from the facts that their floor levels are at the same depth and that the large room no. 5 is separated by a double wall from the building discussed above (Plan 1; Fig. 3). In the rectangular rooms nos. 1-4 the mud-bricks on top of the stone foundations have been preserved. The size of these bricks is 28-30×30-32×7-9 cm. Mud-brick walls up to a height of 1.25 m. from the floor level have been preserved (Fig. 3). Upright beams were not used in these Ib buildings. One of a pair of hand-mill stones was found *in situ* in the small room no. 6, while the other has been displaced and is now in the adjoining room no. 5 (Fig. 2). In this phase small rooms were reserved for the hand-mill stones. These buildings also have been burned. However, the fire appears to have been less intense than on level II, the mud-bricks here being less red and merely blackened by smoke and hardened. The characteristics of this building—the narrow and longish work-room with a floor of flat stones (no. 7), the small room for the hand-mills (no. 6), the plan of the whole house, the technique of masonry foundations and mud-brick walls, the system of adjoining construction—are in no way different from those of the many previously excavated Ib buildings³. The floors of the rooms are earthen. We were unable to dis-

³ TAHSİN ÖZGÜÇ und NİMET ÖZGÜÇ, *Ausgrabungen in Kültepe 1949*, Ankara 1953, p. 114.

cover the location of the doors. Parallel to the east wall of room no. 5 and built in a north-south direction, there is a stone cist-grave which has been robbed, the precious objects having been taken away and the skeleton disturbed (Fig. 1). In the room were found examples of typical Ib pottery, bronze objects, a duck-shaped weight imported from Mesopotamia and, especially in room no. 1, tablets, one of them bearing a cylinder seal impression. Of the small quantity of Ib tablets hitherto brought to light the newly found ones are the best preserved. Under the floors of rooms nos. 1, 2 and 3 seven stone cist-graves and two pot-graves were discovered. Of the former only one has been entirely and another partially robbed. The stone cist-graves are built at right angles to each other, in north-south and east-west directions. The burial gifts, made of various metals, of (rooms clay, and of stone, are rich and characteristic. This area of graves no. 1, 2, 3) is the most densely built one discovered up to this time in the karum. The pits for the graves have been dug into the layer of refuse covering the level II houses, many of them reaching down to their mud-brick walls and some even disturbing their floors. In the spot in U/23 designated by (×) the foundation of a house has been built across a grave (Plan 1). Taking into consideration this circumstance and the manner in which the level II houses were destroyed, we have reached the conclusion that, after the fire in level II, this area was, for a short period, left in ruins and used as a cemetery and that the Ib settlers then built their houses on it and thus disturbed the cist-grave discussed above. Therefore all the graves belong to level Ib, some being older than the houses, some contemporary with them.

II

Many of the clay, stone, and metal objects found on level Ib represent new types⁴. The greater part of them are burial gifts. The pottery has been put into the graves quite new and without having been used. Most of it could not have served for household purposes and must therefore have been made especially for burial gifts. The

⁴ We shall not publish here the cream-colored, beek-spouted pitchers from Ib graves, nor the red-slipped, round-mouthed pitchers, most of them again being burial gifts. Cf. *Ausgrabungen in Kültepe 1949*, p. 156.

most beautiful of the grave objects are: a red-slipped pitcher with mirror-like polish, round body, long neck, and rounded mouth⁵ (Fig. 4a-b); a dark grey-slipped, polished pitcher with two handles and beak-spout with sieve (Fig. 5); a pitcher with an unproportionally long upright beak-spout with sieve, light red slip, very thin walls, and narrow base⁶ (Fig. 6); cream-slipped pitchers with large triangular mouths facing the handles⁷ (Fig. 7-8); and, finally, a red-slipped jug with ring-base, thick walls, basket handle, and beak-spout with sieve⁸ (Fig. 10a-b). A dark grey-slipped, highly polished jug with pedestal and three spouts with sieve opposite its three handles must also belong to some grave which has been disturbed (Fig. 9a-b). One need not be a specialist in the field of Hittite archaeology to see that this highly original pottery is characteristic of this particular period.

The most important of the objects found on the house floors are: a cup with one handle and clover-leaf orifice (Fig. 13); a red-slipped kantharos⁹ (Fig. 12); a vase with wide mouth, round body, four handles and a neck long in proportion to its body (Fig. 11); a well-made basalt tripod (fig. 15); and the first example from Kültepe of a bird-shaped drinking-cup (Fig. 14). The neck and head of the bird are missing. The wing and tail feathers are represented by deep parallel strokes. The legs are thick, the slip dark grey. The body of the wide-mouthed vase mentioned above has a brown slip, and large portions of its neck and mouth with a cream-colored slip have been painted brown in the Ib technique¹⁰ (Fig. 11). In the holes on one side of the stone toy found in room no. 1 traces of lead can be seen (fig. 16). Metal pins with animal and other heads were stuck into these holes, and the stone thus served as a base for the whole toy.

⁵ OIP 29, p. 188, Fig. 193, e 28. This also is a burial gift.

⁶ This pitcher cannot possibly have been used in daily life.

⁷ CARL W. BLEGEN, L. CASKEY, M. RAWSON, J. SPERLING, *Troy II*, 2, Fig. 162a-b. This characteristic, as we have pointed out before, has a Troian origin (*Ausgrabungen in Kültepe 1949*, s. 159).

⁸ AJA, 51, 2, Fig. 2, Al. c. 564.

⁹ This two-handled vessel with pedestal base differs with respect to its body from all other kantharoi of the karum, which are, as we know, confined to level Ib. Cf. *Ausgrabungen in Kültepe 1949*, p. 171.

¹⁰ TAHSİN ÖZGÜÇ, *Ausgrabungen in Kültepe 1948*, Ankara 1950, p. 191.

III

The greatest part of the grave objects of level Ib is made up of metal vessels and ornaments. The importance of Kaniş becomes clearly apparent when one considers that, with the 8 bronze vessels of Ib together with those of II, it possesses a unique wealth of such objects, and that, moreover, it is the only center from which we can gain an idea of the metal-craft of the first centuries of the second millenium B.C. Most of the vessels are bowls, either with a ring base or smooth (fig. 18-19, 58-60). Their rims are somewhat thickened. The handles of the cups are riveted with one rivet at the lower end and with two at the upper (Fig. 17, 61, 63). A funnel-shaped vessel with a built-in sieve was found placed into a vessel with ring-base and sharp projections (Fig. 20a-b, 62, 65). The former is badly damaged and we have been unable to restore it. The same is true for a vessel with a long spout (Fig. 66). In our opinion it is not a lamp.

It is appropriate to mention here a bronze cauldron (Fig. 21, 57a, b, c) and another bronze vessel (Fig. 22, 64) found in 1950 in a cist-grave under the floor of a room (no. 2)¹¹ situated in square O/19 of level II. The rim of the cauldron has been bent over and thus doubled to a width of 3.3 cm. The handles are riveted to the cauldron by their flattened ends. This cauldron, wider at the base than at the opening, had been placed in a corner of the grave, at the feet of the corpse. The second vessel has a ring-base, and is deep and without handles.

The handles of the wooden vessels found in the graves of level II are made of bronze, bow-shaped, and bent over at the ends (Fig. 67-68). Preserved traces of wood were found at the ends of one of these handles. It is always possible to find in levels Ib and II pottery with shapes similar to those of the metal vessels enumerated above. The clay vessels imitated the shapes of the metal ones.

This year we have attempted to make a comprehensive collection of the different types of bronze pins found in the houses and graves of level Ib. In order to facilitate their comparison, we are also publishing at this time some specimens discovered in previous years. The heads of the pins are cylindrical, conical, and spherical, and in most cases fluted (Fig. 69, 70, 71-73, 79, 81-85, 88). The

¹¹ *Belleleten* 65, Fig. 1.

upper part of the shank is also frequently fluted. The fluted heads are often surmounted by a disc-cap. Some of the specimens are very rare even in the karum. We are also publishing here seven pins from level II, five of them with fluted heads (Fig. 75-77, 87, 91), the others with heads in the shape of double cones (Fig. 78, 80). With the exception of the pins made entirely from one piece of metal, the manufacturing technique was to pierce the head of the pin and to pass the upper part of the shank through the hole in the head. The needles from level II show us the technique of making an eye by bending over the top part of the shank and introducing its sharp end into a hole made for that purpose¹² (Fig. 92). All the pins are circular in section. It is worth discussing in some detail two of the types of pins found in the Ib graves. The first is 17.8 cm. long, has a head with eight leaves, and a shank fluted in the upper part (Fig. 34, 89). It is very similar to the pin discovered in grave BM at Alacahöyük¹³. Of the second type we possess two examples. One is broken off near the point and is 13.6 cm. long, the other is intact and 15.5 cm. long. A little more than 1/3 of the length of these pins is fluted. They are perforated near the middle and silver rings have been put through the holes (Fig. 90). Other perforated bronze and silver pins of the same type have been found at the karum, but without their rings¹⁴ (Fig. 74). At this time they appear to be confined in Inner Anatolia to the karum of Kaniş. It is worthy of notice that among all the pins from Alişar not a single one belonging to this type has been met with¹⁵.

The most important of the burial gifts is a shaft-hole axe, found in the cist-grave under the floor of the room containing tablets in U/23 (Fig. 40a-b, 42). The socket of this axe has four ribs, and

¹² For the similarity of the Alişar and the Kültepe pins Cf. *OIP* 29, Fig. 279-282, 284-285. These pins, which at first sight sometimes appear insignificant, after cleaning and on enlarged drawings show different characteristics according to their periods.

¹³ REMZİ OĞUZ ARIK, *Alacahöyük Hafriyatı 1935*, Ankara 1937, Pl. 167.

¹⁴ *Ausgrabungen in Kültepe 1949*, Fig. 550 and 619-620.

¹⁵ PROF. M. E. L. MALLOWAN, who found this type at Chagar-Bazar, points out its scantiness and mentions the other specimens (*Iraq IV*, 2, p. 133, Fig. 12,9). The copper pin found in level I of Chagar-Bazar constitutes a parallel to the Kültepe specimen from the point of view of its ring, its ornamentation, and its shape (The pin published in *Ausgrabungen in Kültepe 1949*, p. 196, Fig. 550 was also found in level Ib). As we shall mention below in another connection, there can be no doubt

under it there is a sharp projection of the blade in the direction of the shaft. As can be seen from the section, the sides of the blade are ridged and the middle parts of both faces form a slight depression. The most nearly similar piece has been found at level I at Chagar-Bazar¹⁶. In spite of small differences in detail between them, there can be no doubt that they both belong to the same type, which was used in North-Mesopotamia-North-Syria and Anatolia. The Kültepe axe confirms the date proposed by Professor M.E.L. MALLOWAN for the axe discovered at Chagar-Bazar. On the other hand, Professor C. SCHAEFFER has dated one of the two axes of the same type found by him at Ugarit at 1450—1365 B.C¹⁷. Dr. RACHEL MAXWELL-HYSLOP mentions that the area of distribution of her 18 th type, to which these axes belong, extends to Dalmatia and Albania¹⁸. In this connection we would like to discuss briefly a copper (?) battle axe (Fig. 41a-b, 43). After cleaning, the length of this axe was found to be 18.3 cm. and its width 2 cm. The shaft-hole of this long and narrow axe is in the middle and oval in form. The sides of the blade are ridged and the middle parts of both faces slightly depressed. In contrast with the axe found in the Alacahöyük grave¹⁹, its slightly widening two ends are both sharp. This Kültepe axe is obviously not a hammer-axe, but a true battle-axe. It constitutes a metal example of similar stone-axes. The discovery of this copper axe was made in a cist-grave²⁰ under the floor of a room containing many tablets (no. 10) in square O/20, i.e. in the period of the highest development of the colony (level II)²¹.

that narrow relations, confirmed by metal objects and pottery, existed between Kültepe (level Ib) and the Habur-area. Dr. KEMAL BALKAN, in a work now in print, has proved that level Ib was contemporaneous with Shamshi-Adad I. This view, confirmed as it is by stratigraphical and archaeological evidence, is further strengthened by the relations between Chagar-Bazar I and Kültepe Ib.

¹⁶ *Iraq IX, 1, p. 85, Pl. 41, 1 and IX, 2, p. 87*. Prof. MALLOWAN here emphasizes especially the area of distribution of this axe-type and mentions the specimens belonging to it. The Kültepe axe, measured after cleaning, is 9 cm. shorter than the Chagar-Bazar and Nimrud specimens.

¹⁷ C. SCHAEFFER, *Stratigraphie comparée*, fig. 44

¹⁸ *Iraq XI, 1, s. 107*.

¹⁹ HAMİT KOŞAY, *Les Fouilles d'Alacahöyük, Ankara 1951. Pl. 166,1.*

²⁰ *Belleten 65, Fig. 1.*

²¹ I shall not discuss here S. FUCHS' theory attempting to establish a connection between the existence of battle-axes in Western Anatolia and the *Völkerwan-*

The gold and silver objects of level Ib are of equal importance with those of bronze. In the graves many gold leaves pierced at the ends, which served to close the mouths of the dead, have been found²² (Fig. 26-31, 50-56). In some graves two of these leaves were encountered, the larger ones having been used to cover the eyes. The leaves must have been tied to the head with strings put through the holes at their ends. A gold leaf different in shape from those just discussed, which appears to have been wrapped around and nailed to some object, was doubtless used for a different purpose (Fig. 30, 50). A massive gold pin (8.9 cm. long) is skillfully ornamented on its upper part (Fig. 33, 47). Like some of the bronze pins, this pin has a pierced fluted head which has been set on the shank. Some pins have a bronze core covered with gold plating (Fig. 48-49). Under the influence of oxidation the bronze of the core has broken through thin spots in the ornamented gold plate. One pin has a bronze head (Fig. 48), another one a head of lapis-lazuli decorated with thin flutings (Fig. 49). One silver pin has a head in the form of a perched bird (Fig. 36, 86), like some of the Alişar specimens²³, the other one has as its head a white, brilliant, fluted stone²⁴ (Fig. 35, 46).

Although they belong to level II, it is impossible to ignore in an article in part devoted to gold and silver objects two head-dresses, one of gold, the other one of silver. The gold head-dress was found on the skull in the grave in O/19 mentioned above. Its diameter at the rim is 20 cm., its height 11 cm. (Fig. 38, 44). The pointed head-dress is familiar to us from the representative art of the Colony Period, but this specimen, the precise nature of which is made obvious by its being found on a skull, in the only concrete example of it discovered in Anatolia.

The silver head-dress was found in a grave in square O/20 of level II. It too was discovered on a very badly preserved skull which

derungen (S. FUCHS, *Die Griechischen Fundgruppen der frühen Bronzezeit, und ihre auswärtigen Beziehungen*, Berlin 1937, p. 117-125). For, as Prof. K. BITTEL has clearly shown, the chronology and area of distribution of the Anatolian and Near-Eastern battle-axes makes it impossible to accept this often repeated theory (K. BITTEL, *Grundzüge der Vor- und Frühgeschichte Kleinasiens*, 2. Aufl. p. 56-57).

²² Similar gold leaves were also found in the course of previous excavations (*Ausgrabungen in Kültepe 1948*, p. 201, Fig. 393-394 and *Ausgrabungen in Kültepe 1949*, s. 199, Fig. 588).

²³ OIP 29, p. 253, Fig. 283, e945 and Fig. 134, d2418. These also are burial gifts.

²⁴ OIP 19, p. 162, Fig. 203.

could not be removed. Large portions of it were missing, but it was possible to effect a restoration from the remaining pieces. The rim diameter is 20 cm., the height 12 cm. (Fig. 39 a-b, 45). The shape is the same as that of the gold head-dress. A 2.3 cm. wide gold strip was fastened with two nails to the rim of the head-dress. While one of the ends of the gold strip is still held in place by a nail, the other one is no longer attached to the silver since the second nail has fallen out. These outstanding finds, which show the high development of the metal-craft of the Colony period, give us a promise of further valuable discoveries in the same area. Those finds only one part of which we have attempted to publish in this preliminary report best illuminate the richness of the period immediately following the Alcahöyük graves, which constitutes the second flowering of Anatolian metallurgy.

In the waist region of the dead in the grave in O/19 a copper (!) belt-buckle was discovered. The buckle is in the shape of a ring held by two arms which are connected together by a bar at the height of the elbows (Fig. 37a-b, 93a-b). This moulded belt-buckle is unique. The grasping of the ring, the execution of the fingers and especially of the thumbs, the representation of the palms and of the backs of the hands, demonstrate the skill of the master and the height reached by the metal-craft of this period ²⁵.

The differences between the two phases of the Colony period, i.e. levels II and Ib, which have been worked out on the basis of stratigraphy, architectural remains, and small finds, were confirmed by the rich materials brought to light in the last excavations. We shall revert to them in the report on level II, which will follow the present article. The differences between the earlier (level II) and later (level Ib) phase of the Assyrian Colony period will then become clearer, and it will be possible to give some indications about the interval separating the late phase of the Colony period from the Old Hittite period, or rather the *Labarna Culture*.

²⁵ The shape of the hands and arms holding the spool discovered in level II in 1950 is the same as that of the newly discovered buckle (*The Illustrated London News*, October 6, 1951, p. 547; and *Archiv für Orientforschung*, XVI. P. 150, Abb. 15). Although this spool was not found in a grave, we conclude from the location where it was discovered that it must have been displaced from a near-by disturbed grave. These two finds show that objects of this type were confined to the early phase of the Colony period and were not used in the Ib phase.