

Harmonics elimination of seven phase uncontrolled rectifiers driving Dc motor

Myasar Salim Alttar^{1*}, Firas Ahmed Aldurze²

¹MechatronicsDepartment, Mosul University, Mosul

ORCID No: <https://orcid.org/0000-0001-8725-0448>

² MechatronicsDepartment, Mosul University, Mosul

ORCID No: <https://orcid.org/0000-0001-7709-6731>

Keywords	Abstract
uncontrolled rectifier THD seven phase filters dc drive	Conventional three-phase electrical power systems have great application in industrial and home appliances. An increasing demand for power by consumers has led to the consideration of using different types of power generation units such as solar, wind, and thermal, can be individually used or connected with main the idea network. This driven has engineers to create a modern electrical system with more than three which phases, such as five, six, seven, nine, and more. Using this type of schematic mode helps to achieve better performance of the system in transmitting power, reliability, and stability. Despite these benefits, a generation of harmonics problem appears in the network when using different types of converters such as AC-DC (rectifiers) or DC-AC (inverters). To overcome this problem, a filter design is introduced to eliminate harmonics. In a paper, MATLAB R2020b is used to simulate a seven-phase uncontrolled rectifier driving a DC shunt motor, and a filter is designed and connected with the DC drive. This research presents an analysis of input/output voltage and current waveforms with the THD value of an input current before and after the filter is connected.
Research Article Submission Date : 14.04.2023 Accepted Date : 21.05.2023	

1.Introduction

Multi-phase systems receive wide interest in various domestic and industrial uses. They also have the main role in generation and transmission systems of electric power, especially after the expansion of uses for alternative energies, including solar and wind. Among these three, five, seven, etc. systems, the second type is considered the first development after the traditional triple, where attention has been paid By designing special generators for generating it, as well as designing variables and power converters for changing them into a direct current system, as well as many attempts were made to improve their performance and raise their efficiency through the development of the controlled rate circuit, then the Seven appeared, which consists of seven phases, with a phase difference of 51.428 between them Attention has also increased in many topics related to reducing the harmonics resulting from the rectification process towards the design of different types of active or reactive filters for different types of rectifiers with multiple phases,raising the efficiency of the system (H. Rashid 2001)(Masoud,2015).(HeJun,2022).In Figures 1 and 2, different types of multi-phase systems are shown.

*Resp author; myasalarattar@uomosul.edu.iq

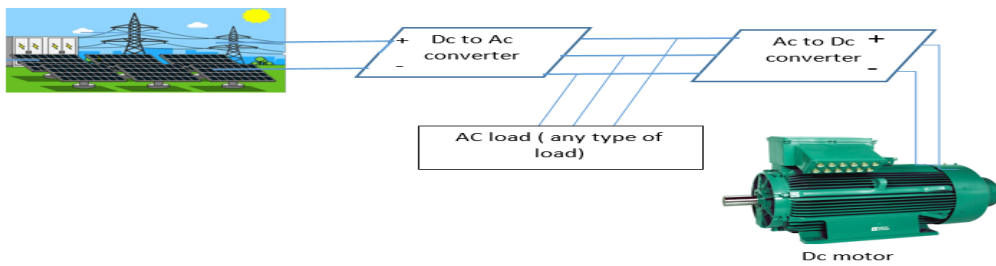

Figure 1. solar schem connected to multiphase system

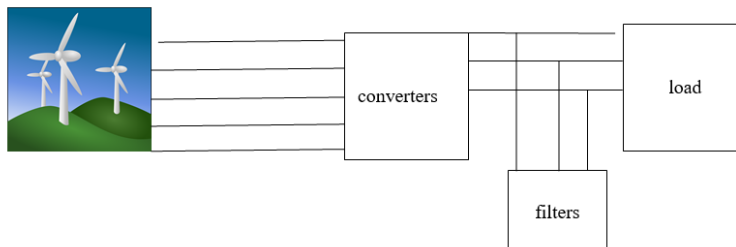

Figure 2. wind turbine schem with multiphase system

2.Model structure:

The studied model in this search consists of multiple stages of components as shown in Figure 3. It can be classified into four parts. The first represents three to seven phase source supply, consisting of a traditional three-phase source connected to a new assembly of transformer winding grouping as three sets. The next presents an alternating to direct current converter (rectifier) which consists of an uncontrolled third part, a DC shunt motor acting as a load connected to the rectifiers. Finally, the last is a filter designed and linked with a circuit to eliminate harmonics generated by power electronic switches in the converter and transformer.

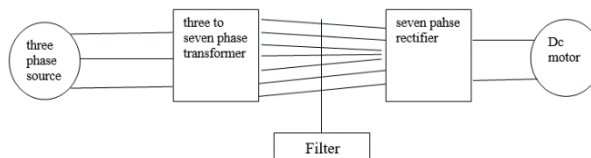

Figure 3. Block diagram of model structure

2.1.Innovative seven phase system using transformer-winding modification

Transformers play a major role in electrical power circuits by changing the number of their turns or the way their coils are wound. Many circuits of power electronics devices depend on traditional three-phase transformers. Because of the need for a three-phase system in transmitting lines, high power converters, DC and AC drives, in recent applications, as a result of the increasing demand for energy and the difficulty of generating electric power with more than three phases, the need to use renewable energies arose, and to complete the process of transferring power and investing it over long distances, the need to create a multi-phase system that exceeds three appeared, such as five, six, seven or more. Transformers were used as an aid to change the shape of the connection as well as increase the number of phases by using innovative methods of connecting the coils. Figure 4-a represents the schematic diagram of the transformer used in the model with modifications to transform the phases from three (Y) connection to seven phases, while 4-b presents an implementation of the transformer mentioned in the figure above using MATLAB Simulink (Simscape) and its phasor diagram showing the suitable mode for connecting for increasing phases to seven (Chandramohan,2017)

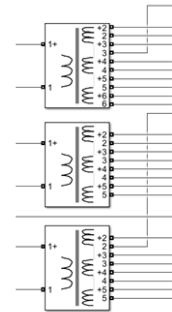
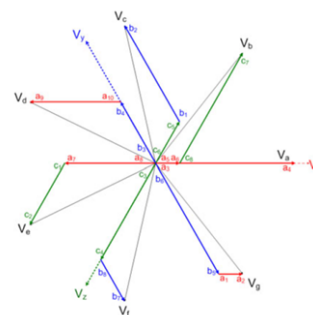
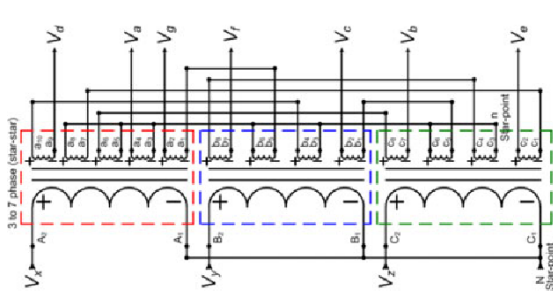

Figure (4-a) represent the schematic diagram of transformer circuit

Figure (4-b) block diagram of transformer in matlab Simulink and its phasor diagram

2.2.Rectifier circuit’s scheme

The studied rectifier shown in paper, in this Figure 5, consists of uncontrolled power electronic switches (diodes) acting on seven legs representing all phases with 51.428° electrical degree. Its output voltage has fourteen pulses generated by diodes named D1-D7, which denote the upper converter, while D8-D14 refer to the lower, as follows Moinoddin(Shaikh, 2012). (Tabrez, 2017)

- $V_{pha1} = V_p \sin (wt)$ (1)
- $V_{pha2} = V_p \sin (wt-2\pi/7)$ (2)
- $V_{pha3} = V_p \sin (wt-4\pi/7)$ (3)
- $V_{pha4} = V_p \sin (wt-6\pi/7)$ (4)
- $V_{pha5} = V_p \sin (wt-8\pi/7)$ (5)
- $V_{pha6} = V_p \sin (wt-10\pi/7)$ (6)
- $V_{pha7} = V_p \sin (wt-12\pi/7)$ (7)

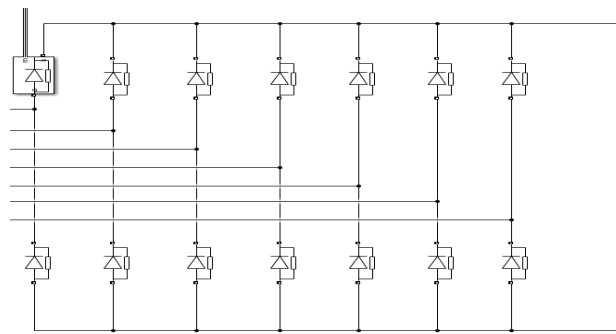

Figure (5). seven-phase rectifier circuit

2.3.Circuit Load

With different types of loads may be connect to rectifiers dc motor is the common type in many application . In this search dc shunt motor is used as a load shown in figure (6)

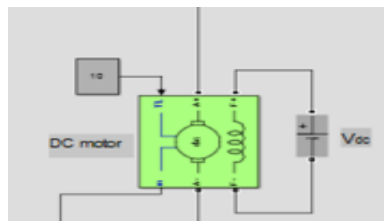

Figure (6) .dc shunt motor (load)

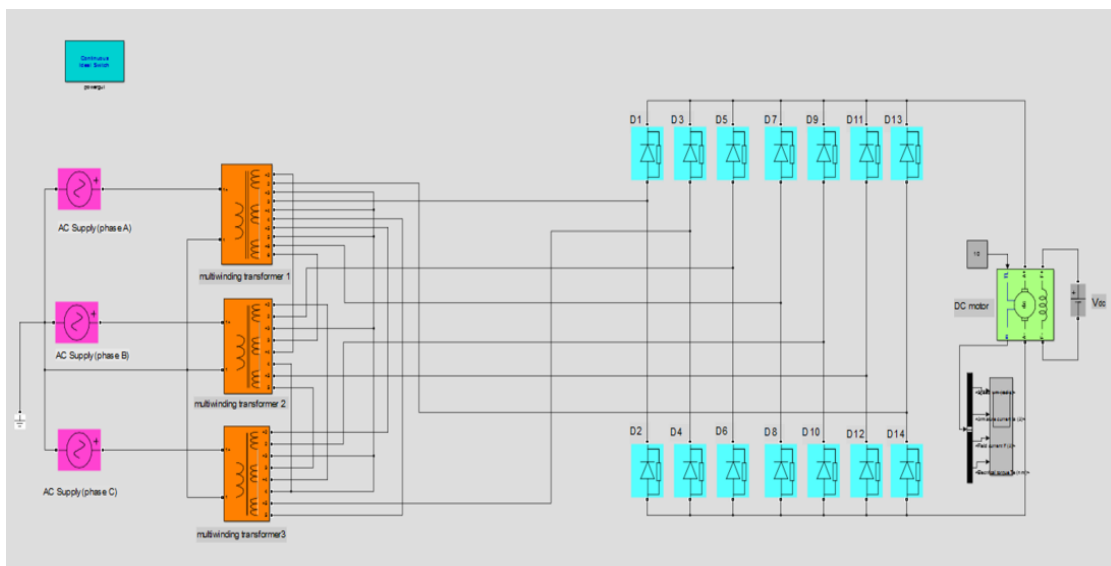

Figure (7). complete circuit model

3.Simulation results The results of this research are divided into two main parts: the first depends on the initial case without any additions, and the second depends on adding a filter to the circuit and its effect on reducing or eliminating harmonics.

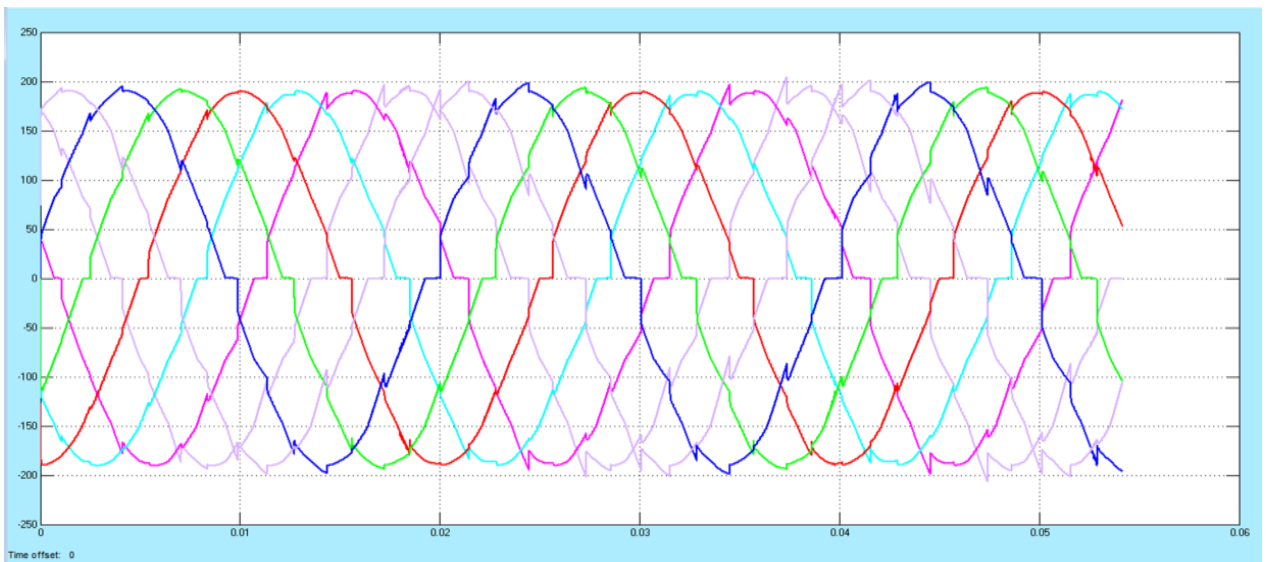
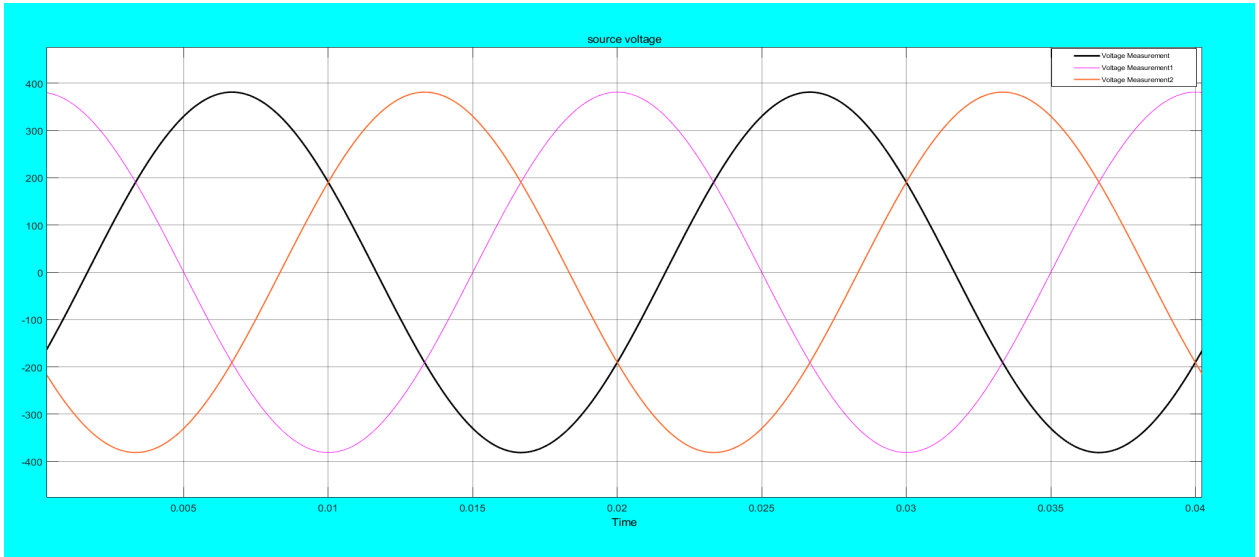

Figure (8).three-phase source voltage

Figure (9).transformer output voltage

The figure 8 shown represents the main three sources responsible for generating the base voltage feeding the transformer sets; these output voltages are purely sine waves. However, the output voltages from the transformers in figure 9 have many harmonic components due to the high reactance in circuits, which leads to unsuitable operating conditions in rectifiers, causing the DC motor to run with unacceptable vibration. The current in figure 10 consists of a seven-wave form with 51.428° electrical degrees, supplying the rectifier with shapes similar to a square wave; this form is due to the effect of circuit and motor reactance.

Figure (10).transformer output current

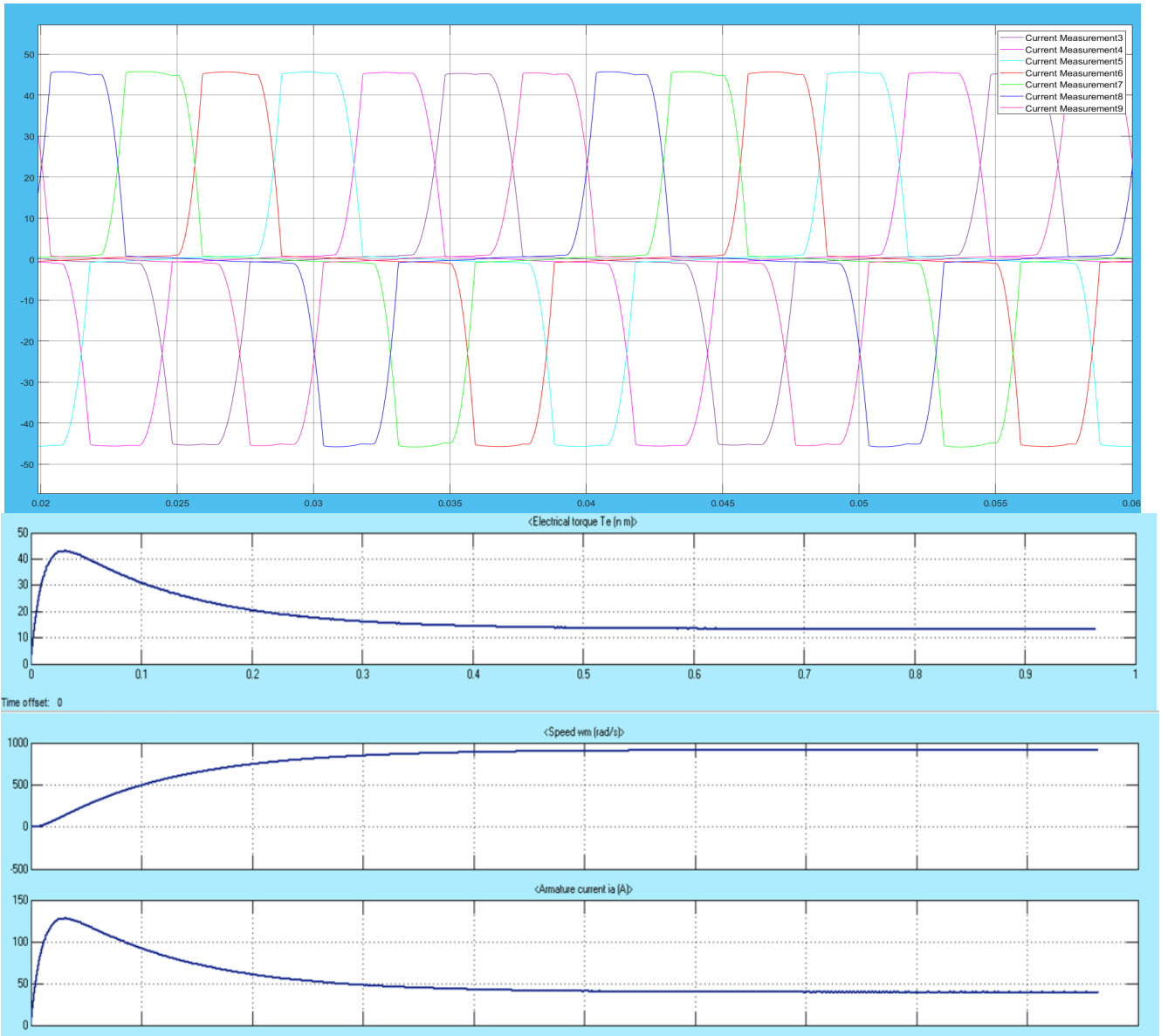

Figure (11).speed, armature current and torque of dc motor

The figure (11) displayed the motor performance, which described by speed in rpm, armature current and torque in Newton. Meter

3.1.Total harmonics distortion

Total harmonic distortion (THD) represents the amount of distortion in each current or voltage wave in power electronics circuits or power circuits as a result of the presence of harmonic components of the sine wave of a frequency of more than 50 Hz as its multiples or at lower frequencies as its parts.

The calculation of THD can be known as the relation between root mean square for current or voltage. It includes all components of frequencies (nth) form, higher than the second to the main component of frequency of the mentioned signals. The following equation presents the

$$THD = \frac{\sqrt{\sum_{n=2}^{\infty} V_n^2}}{V_1} \tag{8}$$

mathematical form of this relation.

Vn : represent the all component of voltage higher than main (all values in rms)

V1 : represent the main component of voltage (rms)

In the last equation it can generalize the previous equation to current instead of voltage and for the same definition

$$THD = \frac{\sqrt{\sum_{n=2}^{\infty} I_n^2}}{I_1} \tag{9}$$

In : represent the all component of current higher than main (all values in rms)

I1 : represent the main component of current (rms) (H. Rashid, 2001)

the following figure represented the total harmonics distortion appear on current wave form supplied by transformer to rectifier circuit , it can be shown the effect of high reactance on shape of signal beside the high value of distortion on it .where the odd harmonics component are the dominant ,third and fifth harmonics

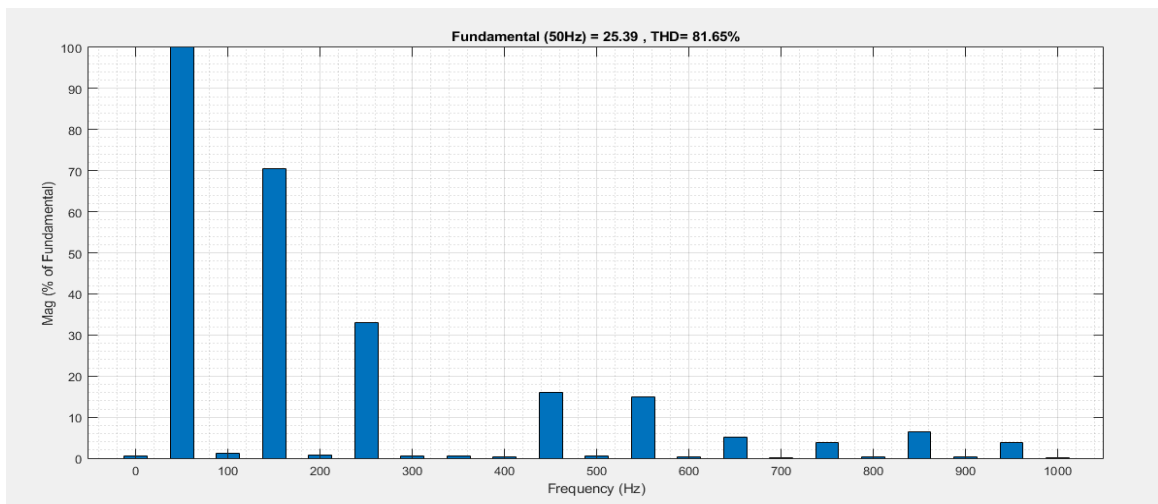

Figure (12). total harmonics distortion (THD) in phase A

The dominant and largest values are followed by the ninth and eleventh, with the seventh disappearing and while the ones vanishing. even This result can be used to eliminate or reduce these harmonics as much as possible, which can be achieved by designing and connecting filters to the circuit. Many types of filters are used for this purpose, which can be classified as

into many types according to their type; it may be active depending on designing an to inverter work a filter as or passive associated with the passive and active elements an in electric circuit such as resistors, inductors and capacitors. In this research, passive filters are used to eliminate the There are two kinds of them, harmonics. the of which first will used

3.2.Types of passive filter

Types of passive filter: be 1- Band-Pass Filters: used to reduce the odd harmonics an electric circuit; these types are in used for eliminating one frequency for each circuit (mono-tone filters) or two frequencies (dual-tone filters). designed 2- High-Pass Filters: used for high harmonics. They order also classify into three types (single, dual, high-pass triple) filter. 13 shows the filter types. Figure Represents (a) the single mono-type, or (b) points the to dual band.

The equations needed to design the filter can be written in the following form

$$f_o = \frac{1}{2\pi\sqrt{LC}} \tag{10}$$

$$Qc = (\sqrt{L/C})/R \tag{11}$$

Where

fo target frequency needed to design filter

QC quality factor ,that can be define as the ratio between the maximum stored energy and dissipated power at resonance frequency (I.Zynal Hussein & A.Fadeel Bashar.(2014)

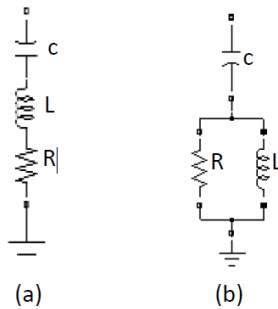

Figure (13). (a) single or monotype. (b) Dual band

The filter designed using previous equation connected to model circuit at transformer side gave result showing the effect of filter total circuit performance by improving the value of total harmonic distortion which decreasing by 8.8%

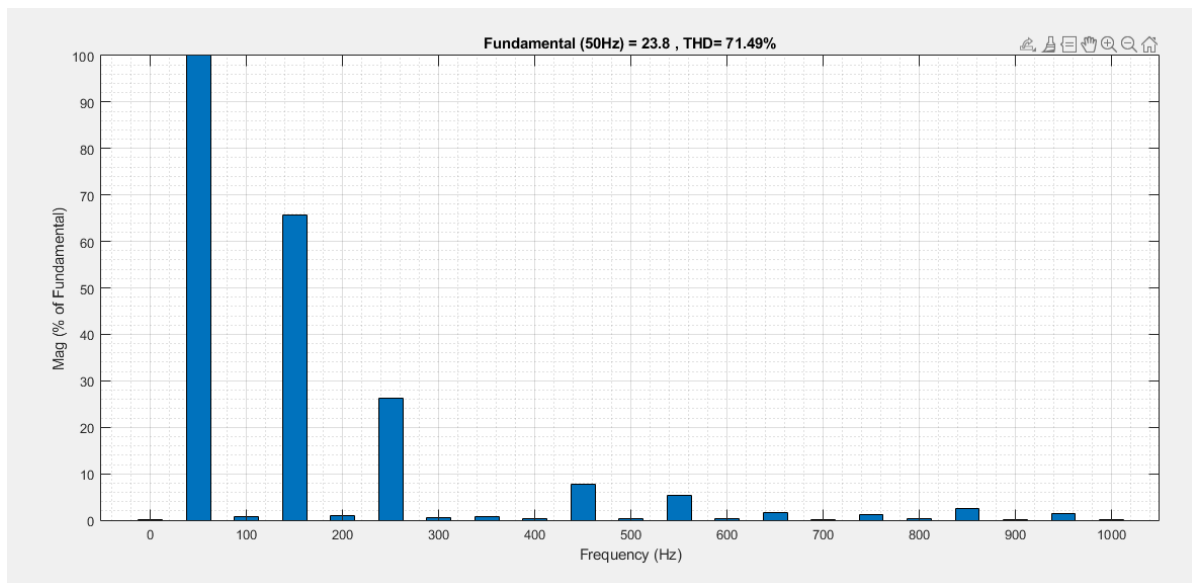

Figure (13) total harmonics distortion (THD) in phase A after filtering

4. Conclusion

The research deals with the operation of a DC motor driven by a rectifier circuit, which consists of a modified three-to-seven-phase transformer. The system suffers from a high amount of harmonic orders due to the high reactances of the circuit and the rectification process. To reduce this amount of THD, a filter was used, in the form of a package of filters (dual band) connected to the transformers for all lines. These packages improved the total harmonic distortion (THD) in the drive circuit by reducing the overall ratio by 8.8%, where before filter insertion it was 81.65%, while after insertion it became 71.49%, decreasing the greatest orders (third and fifth) as main components by 8% and 12.5%, respectively. As a result, the other odd orders were also reduced by 50% at the ninth order and 30% at the eleventh order. For future work to improve circuit performance an active filters can be used to cover more orders of harmonics elimination

Conflict of Interest

Authors declare that there is no conflict of interest

5. References

- Chandramohan Kalaivani & Padmanaban Sanjeevikumar (2017). Grid Synchronization of a Seven-Phase Wind Electric Generator Using d-q PLL. *www.mdpi.com/journal/energies* . 10, 926; [doi:10.3390/en10070926](https://doi.org/10.3390/en10070926)
- H. Rashid Muhammad, *Power Electronics Handbook*, Academic Press, 2001.
- Hu HeJun, Wang JunJia, Huang YiYun & Chen Hui. (2022) Analysis and Suppression of Harmonic Characteristic for Multi-pulse Rectifier Based on Phase-shifting Transformer. *Conference Series* 2237. [doi:10.1088/1742-6596/2237/1/012003](https://doi.org/10.1088/1742-6596/2237/1/012003)
- I. Masoud Mahmoud. (2015). Fully controlled 5-phase, 10-pulse, line commutated rectifier. *Alexandria University Alexandria Engineering Journal*, Volume 54, Issue 4, Pages 1091-1104. [doi: 10.1016/j.aej.2015.07.004](https://doi.org/10.1016/j.aej.2015.07.004)

I.Zynal Hussein & A.Fadeel Bashar.(2014). Analysis and Design of Passive Filters to Reduce Line Current Harmonics for Controlled Rectifiers Al-Rafidain Engineering Vol.22 No. 1

Moinoddin Shaikh, Iqbal Atif, Abu-Rub Haitham & Ahmed Sk. Moin .(2012). Three-Phase to Seven-Phase Power Converting Transformer. IEEE TRANSACTIONS ON ENERGY CONVERSION, VOL. 27, NO. 3.
doi: [10.1109/TEC.2012.2201483](https://doi.org/10.1109/TEC.2012.2201483)

Salim Alattar Myasar & A.Salih Asef.(2022).Analysis of a novel seven phase uncontrolled rectifier system International Research Journal of Engineering and Technology (IRJET). 2395-0056 Volume: 09 Issue: 08

Tabrez M.& Iqbal A. (2017). A Novel Three Phase to Seven Phase Conversion Technique Using Transformer Winding Connections. Engineering, Technology & Applied Science Research. Vol. 7, No. 5, 1953-1961 1953.
<https://doi.org/10.48084/etasr.1190>