

The Mosaics of Conimbriga (Prov. Lusitania, Portugal). New Observations on the Activity of their Workshops and on their Decorative Programs

Conimbriga Mozaikleri (Lusitania Eyaleti, Portekiz). Atölyelerin Aktiviteleri ve Dekoratif Programlarıyla İlgili Yeni Gözlemler

Virgílio Hipólito CORREIA*

(Received 03 December 2016, accepted after revision 18 May 2017)

Abstract

With over 100 years of study and dissemination, the mosaics from Conimbriga are an outstanding group of this Roman decorative art in the extreme West of the Empire.

Recent research on the domestic architecture of the town as allowed for those studies to be put in a general perspective and some conclusions drawn on the activity of the local workshops over the span of five centuries (1st BC - IVth AD).

These conclusions respect both to technical and artistic matters, such as the volume of the activity, the public or private nature of the decorated buildings and the style of those mosaics, and to ideological issues, such as the figurative motifs preferred in the decorative programs, where everyday life, heroic cycles and broad mythological themes have an important presence.

Keywords: Conimbriga, Lusitania, Roman mosaic, heroic cycles, Romanization.

Öz

Yüz yılı aşkın bir süredir gerçekleştirilen araştırma ve yayın çalışmaları sayesinde, Roma İmparatorluğu'nun en batısında bulunan Conimbriga mozaiklerinin Roma dekoratif sanatları içerisinde ön plana çıkan bir grubu oluşturdukları anlaşılmıştır. Kasabanın yerel mimarisi üzerine yapılan son araştırmalar, bu çalışmaların genel bir perspektif içinde ele alınmasını ve beş asır boyunca yerel atölye çalışmalarıyla ilgili bazı çıkarımların yapılmasını sağlamaktadır (İÖ 1. - İS IV. yüzyıl). Bu sonuçlar, hem etkinlik hacmi, hem de dekore edilmiş yapıların kamusal veya özel nitelikleri ile bu mozaiklerin tarzı gibi teknik ve sanatsal konulara ve dekoratif programlarda tercih edilen gündelik hayatın, kahramanca döngülerin ve geniş mitolojik temaların yer aldığı figüratif motifler gibi ideolojik meselelere önem vermektedir.

Anahtar Kelimeler: Conimbriga, Lusitania, Roma mozaiği, kahramanlık hikayeleri, Romanizasyon.

1. Introduction

Conimbriga (prov. Lusitania, currently Condeixa-a-Nova municipality, district of Coimbra, Portugal) is a Roman city of indigenous origin, known since the XVI century and object of excavations and publications since 1890 and,

* Virgílio Hipólito Correia, Museu Monográfico e Ruínas de Conimbriga, Condeixa-a-a-Velha 3150-220 Condeixa - Portugal.
Centro de Estudos Clássicos e Humanísticos, Un. Coimbra, Research Developed under the Project UID/ELT/00196/2013, funded by the Portuguese FCT – Foundation for Science and Technology. E-mail: virgiliocorreia@mmconimbriga.dgpc.pt

since 1930, systematically excavated. These excavations have exposed the site and preserved a major Roman site in the Iberian Peninsula.

Among the various research projects developed in the meantime, reference will here be made to a recent one, which dealt with the systematic study of domestic architecture of the town (Correia 2013: 47-51).

This architecture, although often referenced, particularly because of the preserved mosaics, had never been the subject of systematic treatment. This is a paradoxical situation: the investigation of *Conimbriga* archeology began with the domestic architecture. This is a feature that *Conimbriga* shares with cities such as *Pompeii*, *Herculaneum* and *Ostia*, but not many other archaeological sites in the orb of the empire.

The first four moments of research in the town, namely the small excavations following chance findings in 1873, the first major excavations of 1899, the excavation of the site by the Faculty of Letters in 1930 and the excavations of the DGEMN from 1929 to 1944, all of them exposed - the first two temporarily, the others on the basis of permanent exhibition of the remains - domestic architectural fragments, namely mosaics (DGEMN 1964: *passim*), and none of them public monuments of substance (on the excavations of 1873, Gonçalves 1903: 359-365; for the remaining excavations, DGEMN 1948: 5-29 and Correia 1941: 257-267). The Late Empire city wall, a remarkable public monument itself, was never the subject of thorough investigation, his chronological interpretation was always based on the misunderstanding of its identification with the true limit of the city and its restoration itself was carried without an archaeological investigation worthy of that name (DGEMN 1948: 31 (V) and references on pp. 7-9).

In fact, up to the French-Portuguese excavations started in 1964 (Alarcão - Etienne 1977: 65-84, 135-142, 155-164), the domestic architecture was all that was known of *Conimbriga*, but from that moment onwards this has been relegated to a secondary role in the investigation of the city.

After the French-Portuguese excavations, the archeological research in *Conimbriga* stagnated. In the late seventies and throughout the eighties of the XX century, some small scale interventions were carried out, but none was part of a real research project, and has never been the subject of systematic publication (cf. Correia 2004b: 265-277).

This however, didn't stop the Museum of *Conimbriga* being involved in research, namely of the mosaics, with the first publication of the Portuguese Corpus of Mosaics and the organization of major international congresses on the theme, (ICCM in 1994 and AIEMA in 2005).

However, it was the complete study of the residential buildings known, totally or partially, in the town, that allowed for the mosaics to be understood in their general urban setting, which is the main object of this paper.

2. Problems of chronology

The history of research of the domestic architecture of *Conimbriga* strongly determines the context in which the mosaics can be studied mainly due to a factor: the extent and detail of our knowledge of the chronology of each of the buildings.

The date of construction of a building is not the main thing to study, but the chronological framework of urban development and genetic relationship between the elements that comprise it are an indispensable element in understanding the

underlying social and development of urban dynamics and, to the case in point, of significant trends like the decoration of residences of substance with mosaics. The overview of this issue in *Conimbriga* is not particularly encouraging.

Until 1944, the archaeological excavations carried out in *Conimbriga* had no stratigraphic record of note. As a rule, the excavation was limited to expose the Roman buildings to the height of their pavements (determined by preliminary surveys). The collection of materials, whose rigor is unknown, but appears to have been limited to certain objects deemed curious, systematically neglected the collection of small ceramic fragments, with no provenance per compartment or building. Chronology of these buildings, hence, is unsure.

From 1953 onwards, excavations started to be provided with a process of collecting materials, registering them and their contexts, and conservation in identifiable sets. However, a stratigraphic registration system was not adopted and the difficulty in managing the chronological data is still very significant, for the excavations of this date.

Only from 1962 onwards modern excavation processes were adopted, but no mosaics were found then, which leaves current research in a somewhat dismal situation.

This does not mean, however, that a rigorous approach to the date of mosaics installation in the town cannot be developed, as shall be demonstrated further on.

2.1. The investigation of the domestic architecture of the city and its mosaics

In 2010 the present author concluded the systematic study of domestic architecture of the city, which analyzed in depth the twenty-seven residential buildings known in whole or in part (Correia 2013: 53-175).

This study allowed for a comprehensive approach to mosaics known in the city from the perspective of mosaic art as a technical program associated with residential construction as a whole, but also a renewed look on the ideological expression of the decorative programs. These approaches are published here.

The study of the mosaics of *Conimbriga* can rely on previous information that allow for its division in two main groups: i) the mosaics of the house of the fountains, published in the respective volume of the *Corpus dos Mosaicos Romanos de Portugal*; ii) the mosaics kept *in situ* in other buildings of the town. The latter are not systematically studied from a stylistic point of view, which somewhat diminishes the possibility of analyzing them in depth on the first approach to be made (relating to the activity of the workshops) and, on the whole, their mostly geometric character does not allow for deep insights into their ideological expression (the second approach to be made), but this distinction is germane to the very nature of the evidence dealt with here, and one has to proceed with it.

3. The activity of mosaicist's workshops in Conimbriga

The evidence shows that the introduction of Roman decorative arts in *Conimbriga* started in public works, namely the construction of the South baths in its first, Augustan phase. This building uses the two major techniques that will dominate the decoration of *Conimbriga* domestic architecture throughout the period in which it is recognizable: mosaic and painting; mosaic art is the one that gives us a larger sampling in time span and area applied, that allow for a meaningful approach (Oliveira 2008: 183-195).

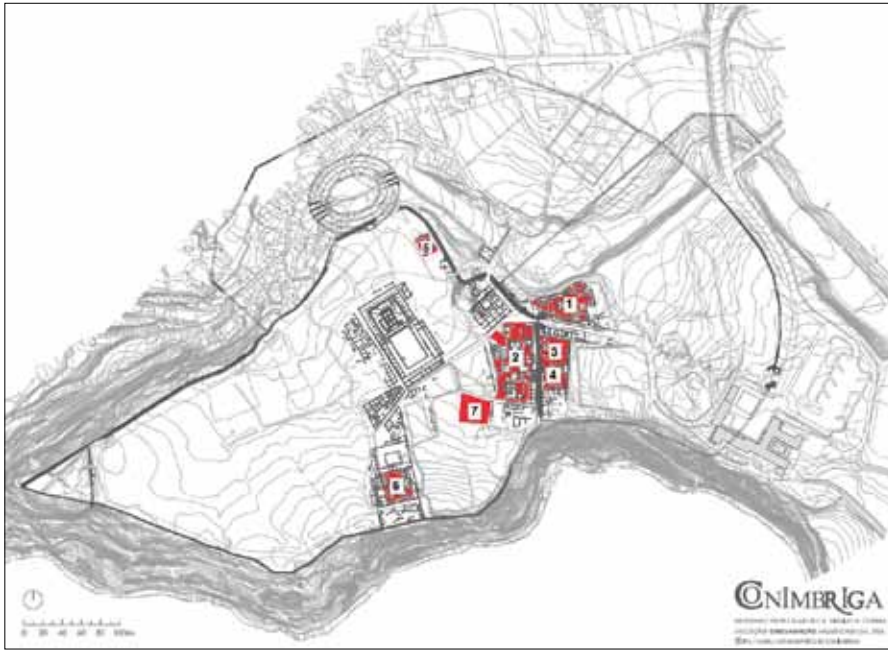

Figure 1
Location of buildings with mosaics in Conimbriga. 1 – House of the fountains, 2 – House attributed to Cantaber, 3 – House of the swastika, 4 – House of the skeletons, 5 – House of the trident and the sword, 6 – Southern baths, 7 – Probable location of the building excavated in 1899.

Six domestic buildings in the city were decorated with mosaics (Fig. 1).

In the house attributed to *Cantaber* about 895 m² of mosaics were applied in the main part of the residence, although much of this mosaic extension is currently reduced to trace remains. In the absence of a thorough study, the references given by J. M. B. Oleiro on several occasions may point out an extended chronology from the beginning of the II century, perhaps even to the last quarter of the I (Oleiro 1986: 115; Oleiro 1994a: 43-44; Oliveira 2005: 48-68). Other mosaics totaling 77 m² correspond to the late-imperial post-wall addition, and should be dated in the second quarter of the IV century.

From another building of which nothing known and can be located only approximately, mosaics were removed in the excavation of 1899. Considering that only 50% was actually recovered, this building would have at least about 58 m² of mosaics installed. The chronology proposal is late Antoninian (Oleiro 1973: 92-154; Oliveira 2005: 84-86.), i.e. mid II century.

In the house of the trident and the sword 48 m² of mosaics are known in the three sequential compartments in the northern part of the house (a *schola*. Cf. Correia 2016) and other 23 m² corresponding to cubiculum mosaic of the south wing (Oliveira 2005: 71-74).

The chronology proposal for these mosaics needs further examination. The chronological proposals for buildings other than the house of the fountains, made by C. Oliveira (2005: *passim*) refer to a communication instrument where the question must be judged insufficiently treated and too simplified and should not be accepted without further examination. Such an examination will not fail to be made in the publication of a second issue of the *Corpus of Roman Mosaics of Portugal* dedicated to Conimbriga, when such work is carried out (cf. Correia 2013: 208 n 234).

For the matter at hand the mosaics of the house of the trident and the sword are the least studied of the city, and only from internal comparisons is it possible to propose a chronology. This internal comparison would show they can be stylistically placed between the aforementioned 1899 mosaics and the oldest

mosaics of the house of the fountains; their dating up fall in the second half of the II century.

As for the house of the fountains, the likely overlap of partially surviving decorative programs, or any extensions of the program in the northern area of the house, which seem possible, can at this point be neglected. The extent of mosaics is 673 m² and its chronology goes from the last quarter of the II century to Severan times, mid III century (Oleiro 1992: 168-170).

In the house of skeletons there is a mosaic with 24 m² in the independent unit of the southern part of the house and the rest of the calculation (249 m²) assumes an original complete decoration of the peristyle with mosaics, today completely lost due to post-depositional phenomena associated with the necropolis that overlapped the house. The chronology of the mosaics is the second half of the III century (Oleiro 1986: 117-125; Oleiro 1994a: 44; Oliveira 2005: 43-47).

As for the house of the swastika, all mosaics, a total extent of 454 m², may correspond to a program also dated in the second half of the III century (Oleiro 1986: 117, 125; Oleiro 1994a: 44; Oliveira 2005: 31-41). The evolution of the architecture of the house, as interpreted by J. Alarcão (2010: 47-63) would not support an assignment to a single moment, but this does not alter the present analysis.

This set of data allows a quantified scheme of the chronological distribution of the mosaic workshops activities to be drawn (Fig. 2). This analysis has to be restricted to the activity in the urban center, for what is known of that activity in the surrounding territory is not sufficient for a similar exercise (Pessoa 2005: 363-401).

The single most important fact to be understood from this analysis is the consistency of the level at which the workshops would have been working throughout the II and III centuries, has is demonstrated by the graphic in fig. 3, which distributes the observed extent of mosaic proportionately to their chronology, as

Figure 2
Chronology of mosaic decorations and respective extent (Correia 2013, 211, fig. 100).

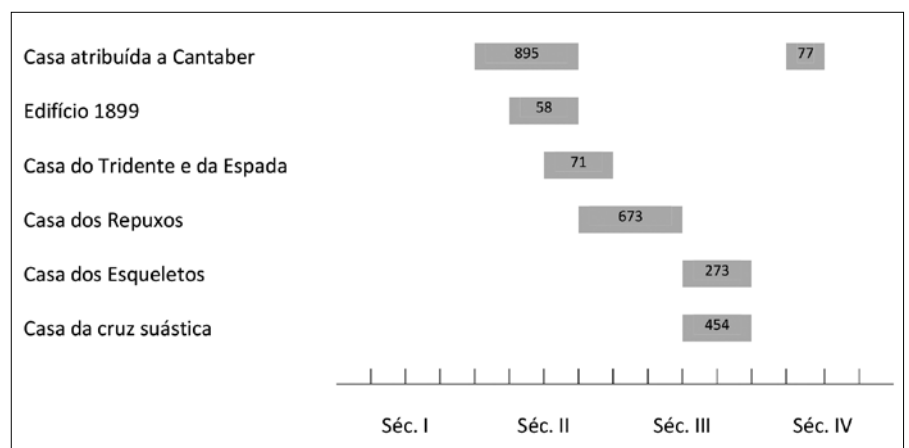
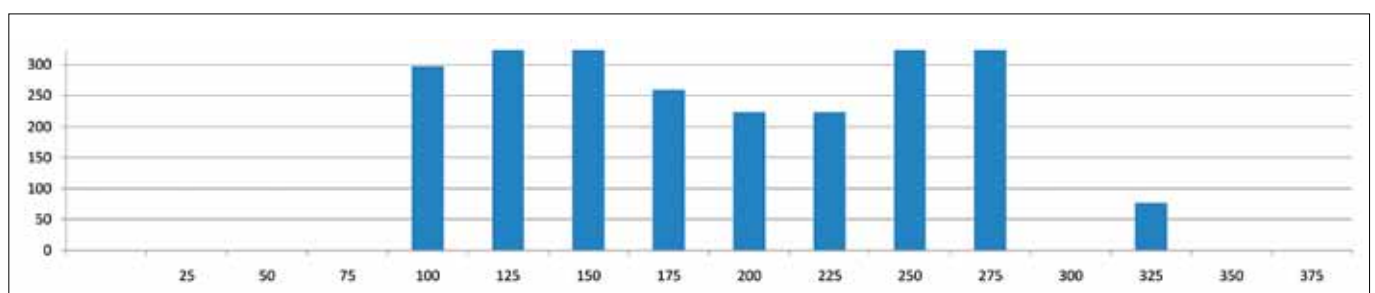

Figure 3
Quarter-century distribution of mosaic workshops in Conimbriga (in m². Correia 2013: 212 fig. 101).



a means to have an approximation to the amount of mosaic work executed, in quarter centuries intervals.

4. Other issues on the activity of mosaicist's workshops in Conimbriga: origins and disappearance

The earliest mosaic of *Conimbriga* is the white monochrome mosaic of the *frigidarium* of the South baths (Fig. 4). Unfortunately, we have only limited evidence for the rest of the mosaic decoration of this building (including of the Flavio-Trajanian phase. Cf. Oliveira 2008: 183-195), but the fragments remaining allow only for an understanding of the expression adopted by the workshops then, and give some support to the stylistic analysis to be made on the later, mainly domestic, musive works. But the reconstruction of the decorative program of the South baths (Oliveira 2005: 77-79; Oliveira 2008: loc. cit.) is insufficient to complete the graph in fig. 3 with the early I century distribution.

The use of mosaic in the first phase of the South bath, even allowing for the modesty of the work, is nevertheless a relevant element for the luxurious character of the building and raises an hypothesis of such a work having echoes of the programs of Agrippa in the province of Lusitania (on the mosaics and the activity of Agrippa vd. for example the references in Lavagne 1983: 259-264).

The use of mosaics during the I century include other examples of which, unfortunately, only meager fragments remain which perhaps carried on without interruption in Flavio-Trajanian programs (these completely lost and impossible to reconstruct in the original extension). There may have existed a situation of dependence of the private works on the availability of an activity primarily occupied by public work through most of the I century.

In this sense, the identification of Flavio-Trajanian construction of the grand South baths as the last great work of civil and public nature in the town (Correia 2004b: 280), wins a special acuity, to the extent that it is possible that from



Figure 4
Plain white mosaic in the *frigidarium* of the augustan phase of the Southern Baths (Photo Danilo Pavone ©Mediaprimer/MMC-DGPC).

there the concentration of building activity in domestic, private works, may have been due, perhaps in equal parts to a socio-ideological mutation that devalued the evergetism as a civic attitude and the fact that *redemptores* and their teams were scarce to simultaneously implement programs in both private and public domains (issue already discussed in Correia 2004b: 280-1).

It is also essential to refer the end of the activity of the mosaic workshops of Conimbriga. This has been placed in the IV century, when evidence of them in the town disappears, and the existence of an itinerant workshop that would have been the responsible for the works of the Rabaçal *uilla* mosaics (Oleiro 1986: 126; Lancha 2004: 92; Pessoa 2005: 391-392) has been proposed as a matter of fact. In light of the evidence presented here, the sudden end of the town's workshops is unlikely and would require more elaborate explanations. On the other hand the recent findings of Santiago da Guarda (Pereira 2008: 171-181), eminently comparable to Rabaçal (Pessoa 1998: 22-40), would indicate that the itinerancy of the supposed workshop would have been greatly reduced, having to deal with decorating not just one but indeed two whole *uillae* in the territory of the *civitas*. In fact the logic seems to impose the explanation that the mosaics of Rabaçal and Santiago da Guarda correspond precisely to the activity of the workshops of mosaicists from Conimbriga who, in the period after the construction of Late-Imperial wall, moved their activity to the rural areas, responding to the new demands of an architecture of prestige required by the property owners actually abandoning the town for their country houses. This would have been done with a new artistic language, which the workshops developed on the basis of their ancestral technical knowledge (earlier on this topic Correia 2004a: 50).

5. The iconographic programs

A single residence in Conimbriga is decorated with mosaics that survived in an extent such as their complexity and iconographic information allows an in-depth analysis of the relationship between the expression of ideological values in architecture and in decoration: it is obviously the house of the fountains. Another residence, the so-called house of *Cantaber*, offers much less preserved evidence (about the lost extension of mosaics: house of *Cantaber* - Correia 2001: plan 3; house of the fountains - Oleiro 1992: est. 75).

There is a very significant post-depositional phenomenon among residences left extramural of the Late-Imperial wall, which were demolished and precisely for that reason retained most of their mosaic floors and those buildings inside the Late-Empire-wall, including the house of *Cantaber*, which, because they were continuously occupied until the Middle Ages, lost many of their mosaics, largely reduced to only marginal traces in most cases.

However, this fact is not enough to blur the assertion that the identification of iconographic programs, and the strictly limited nature of their dispersion, coincide almost exactly with the presence of the elements of greater rarity in the construction of architectural scenarios - indeed the same two residences show the full range of compartments theoretically allocated for activities of rarified intellectual elaboration and provide evidence of decorative programs with high-level erudite references - this allows for the definition of some residential buildings of Conimbriga as houses of exception (on the *Wertbegriffe* associated with aristocratic residences in Conimbriga, Correia 2013: 247-288).

5.1. The mosaic decoration of the house of the fountains

Extensive and minutely studied, the mosaics of the house of the fountains require, however, a comprehensive presentation for the very abundance of dedicated studies incurs in the difficulty of proliferation of interpretative hypotheses. It seems correct to census these interpretations and to explore the background common to all of them. This needs to be integrated in a holistic analysis of the building, in the search for a sociological interpretation, historically informed, about the intentionality of expression of underlying ideological values in the choice of the iconographic program.

The fundamental archaeological problems that the study of the house faces deal with the fact that the house as we know is the product of a remodeling dated to the first half of the II century, which substantially makes use of parts of a previous building. The mosaics date back to between the end of this century and the end of III. The construction of the Late-Imperial wall makes it unlikely any mosaics had been set on the house throughout the IV century.

The adoption of this evolution model of the house, first proposed by J. M. Bairrão Oleiro (1965: 262-263; 1992: 25-26) forces one to doubt some of the proposals made by I. Morand (1996: 207-222, recovered substantially in id., 2005: 13-36; all references will be made to the latter) about the iconographic program. It is especially problematic and disturbing to try to make an assessment, even preliminary, of the impact that the chronological question (mosaics of II-III c. according to Oleiro, but of the IV c. according to I. Morand) has on the credibility of the underlying ideological reconstruction of the iconographic program, because the cultural gap that can be imagined to have existed between pre- and post- constantinian dates could have been significant, even if in provincial context. The issue, requiring a treatment of enormous erudition, is far beyond the limits of the intended exercise on the expression of the iconographic program of the house of the fountains and the jurisdiction of this author. As for the dating of the remodeling of the house in the first half of the III century (López 1990: 200) it must be a misinterpretation of the dating of the mosaics as the date of building refurbishment, an unfortunately recurring lapse.

The quality of successive projects, whether construction or decorative, attests very clearly the investment made in the recurrent interventions on the house, but the very coincidence of all these projects in one building, the respect for pre-existences (natural or constructed), the adaptation of those new interventions to them prior, raises two important suggestions:

- First, the preservation of pre-existences must not be attributed to any economic calculations. Modesty of expenditure must correspond to a deliberate attitude to preserve the main character of space and urban image the house possess; the decision to maintain an imposing urban presence as it happens in the house of the fountains whilst making it suffer a profound renewal of character and morphology, derives necessarily from a choice of deep historical significance for the owner family. This choice is interesting by contrast with the situation of the insula of the aqueduct, a building of the same type and original construction date where a similar decision never occurred, for reasons impossible to determine. In fact, such profound changes in the morphology of the buildings are more typical of public architecture, very well known in Conimbriga thanks to the examples of the Flavian intervention in the forum and the Flavio-Trajanian South baths; it should not be dismissed that an intentional imitation of the public decisions – *aemulatio Caesaris* (Bowman et al. 1996: 524) - for the renewal of private dwellings might have existed. The house of *Cantaber* offers, between its

phases I and II an example of an entire city-block reconstruction that perhaps corresponds to another set of intentions, possibly a material modification of the nature of the urban insula, with parallel examples in Ostia where a secondary construction ward for the forum is transformed into a residential insula encompassing several residences of various types (De Laine 1995: 82-84). The early phase of the house of *Cantaber* is insufficiently known for a rigorous comparative analysis between this building and the house of the fountains, but the urban unity of the area of the *vicus novus* of *Conimbriga* (Correia 2004b: 273-275) is striking and hence striking is the variability of individual histories of the buildings that compose it.

- Secondly, this intention has to be seen in relation with the specific situation of the town in its ability to develop. This certainly was not constrained by shortage of space, because the perimeter of the high-imperial wall provided it with abundance and it is demonstrable that in fact it was never fully occupied. It could, however, be constrained by the shortage of urban space of quality - quality being defined by the social environment perceived by the inhabitants; by location, in a word - which might have determined, for reasons that today cannot be immediately identified by archaeological and topographical methodologies, the natural scope of the *vicus novus* as prestigious.

These suggestions are important to remove the study of iconography and its relationship with the surrounding architectural framework from any a narrow frame of interpretations. This should act as a *caveat* stating that iconography and architecture depend on other ideological spheres, which impinge upon the inner life of the building and simultaneously on other external and extrinsic spheres of influence that affect a particular residence urban environment, of which each construction is a building element.

It is of no importance, within these constraints, to make an especially thorough and in-depth analysis of the supposed meaning of figured myths, or the specific form of its figuration chosen when making decisions about the house decor; intention of the owner and ability of mosaicists must have been present in those decisions in parts perhaps uneven but always decisive, being very important to recognize, in the duration of the execution of the decorative programs, the possibility of changing intentions and decisions, as suggested by J. Lancha (2004: 81).

The choice of location of motifs, however, certainly was intentional. The iconographic motifs are placed in a given architectural framework in focal points: the center of the compartments, the peristyle angles, the center of portico aisles or, better still, the point in the aisle opposite the opening of a major room, centered with the *antae* that delimit it.

This focus is strengthened by the systematic use of the *tondo*, which calls for attention, focusing on a single pitch of summarized information, sometimes reduced to an allegory. But even this simple scheme is availed to multiply the references using the interstitial spaces where the filling motifs have references to the Dionysian cycle through the representation of the *cantharus* and or of elements of the marine *thyasos*, like fish and tridents. This does not preclude the anecdotal use of small out-of-discourse motifs, of apotropaic or merely playful significance by the mosaicist, but the rigor of the original scheme is essential.

In Severan times, the contrast between *tondo* and geometric carpet punctuates *statio* points in the *ambulatio* in the house (to stay in a room, to wait on its threshold *versus* passing through the corridor or along an aisle of the peristyle) in this way responding to formulas, well known from mural paintings, about the distribution of plastic values in Roman domestic architecture.

It is precisely in compartments of longer *statio* that the *tondo* is abandoned: *xenia* in the grand *triclinium*; hunting friezes in the *auriga* room (a *diaeta*) and, in the same room, the diagonal scatter of seasons and figures of nature; the allusion to the *thyasos* in the *exaedra*. Even the great deer hunt, although inscribed in a *tondo*, is cleverly split into two non-orthogonal symmetrical sets, which plastically reproduce a continuous frieze applied to a dome, as perceptively observed by J. Lancha (2004: 86-87).

This plastic feature, however, does not seem to consistently survive the development of the decorative program (or its replacement in isolated episodes of decoration repair?). The remodeling of the central peristyle, particularly in the North wing (but also in the East wing) will forget the precept, but not the intention of multiplying iconographic references, strongly mediated in the most important waiting space in the house: the wing of the peristyle opposite the *cavaedium*; here the prophylactic and apotropaic character of the labyrinth is strengthened (Oleiro 1992: 80; Oleiro 1994b: 273-278), certainly an element of the heroic cycle of Theseus, that in the specific architectural context cannot have failed to reminisce the value of the very ancient symbolic element with deep roots in the pre-Roman art of the West of the Iberian Peninsula. And it is to be noted that, if the interpretation of G. Lopez Monteagudo (1999: 249-266) gives of the representation of the charioteer approaches the original intention of the ordering party, the *Theseus* cycle may have had an unsuspected importance in the iconographic program design.

The importance of specific architectural context is also very eloquently suggested by the possible interpretation of the representation of *Actaeon* in front of the *triclinium* door as a possible *caveat* to the prying eyes of the servants, who should take the fate of reckless hunter as an allegory of their own (Lancha 2004: 82).

The possibility of these reconstructions being true, rather than just believable, is not likely to be tested. They are not, to that extent, scientific hypotheses, although it is arguable that an educated slave could have, on a day, made this association of ideas (but how do you know?). Nevertheless, one can apply them the Italian adage “se non é vero, é benvotato” (on the admissibility of differing interpretations of the same archaeological data Correia 2011: 160-162).

These particular tests do not exempt a broader vision and a comprehensive reading of the sets of figurations. In what regards the house of the fountains the *Corpus* volume (Oleiro 1992: *passim*) will be followed, according to our own analysis (Correia 2003: 121-131; Correia 2013: 303-309); other studies of the house will be referred when opportune (López 1990: 199-232; Durán 1993: s.v.; Lancha 2004: 81-96; Morand 2005: *passim*).

5.2. The themes

Four major iconographic themes can be identified in the mosaic decoration of the house of the fountains: the heroic cycles, hunting, the family self-representation and mythological representations that, for lack of a better expression we'll call of a diffuse nature.

5.2.1. The heroes

The first reference to the mythological / heroic cycles given in the house is the Minotaur in the center of the labyrinth (Fig. 5), an inescapable allusion to *Theseus*, the hero *par excellence* (CMRP 1, Mosaic 1.24. - Oleiro 1992: 80-81;

Figure 5
Labyrinth with the minotaur
in the central perystyle of
the house of the fountains
(Photo Delfim Ferreira
©MMC-DGPC).



the other labyrinths in the same aisle are CMRP 1 mosaics, 1.22 - Oleiro 1992: 76-77 - and perhaps incompetently executed, CMRP 1, 1.19 - Oleiro 1992: 71. See also Durán 1993: 171-172).

Were these references present in the original program (a legitimate question for, in its current state, the decoration of this aisle of the peristyle is a repaving of the end of the III century)?

It is possible, but the issue is not important for the analysis of the iconographic program in its final state. The dating of the Minotaur in the Labyrinth Mosaic collected in 1899 excavations (Oleiro 1973: 111-127 n 3; Oliveira 2005: n° 61, 85) in the early II century AD and the similarity of their border representing a city wall with its gates, which has echoes in the mosaics of the house of *Cantaber*, testify on the probable early dating of the model in the town, even if do not prove directly and irrefutably that this model was already present in the decoration of the older decorative program of the mosaics in the house of the fountains.

A simplified depiction of the Labyrinth and the Minotaur unfolds in several representations in the same aisles, in varying degrees of abstraction, where the labyrinth, reduced to decorative motif, may have seen their apotropaic and prophylactic character reinforced (Lopez 1990: 201-202; Oleiro 1992: 77) at the expense of an immediately recognizable allusion to the novelistic aspects of the myth.

Perseus is represented in the southwest corner of the peristyle (CMRP 1, Mosaic 1.1 - Lopez 1990: 203-204; Oleiro 1992: 32-36; Durán 1993: 172-173), oriented

to the regular access (i.e. facing the west aisle). Holding the head of Medusa as the sea monster moves away from the center of the composition, this hero is represented in a framework that emphasizes the achievement, devaluing the darker aspects of its history (the abandonment of *Andromeda*, Oleiro 1992: 36).

This is the epitome of the *sinedoical* nature of mythological representations in *Conimbriga* mosaics, already widely discussed; however, it is interesting to deepen the trope specifically chosen here. It would seem simplistic to reduce to artistic competence (or lack thereof) the formula to mention the whole by the part. Eventually, there was a deliberate attempt to look at the heroic purposes without concern for intermediate episodes (the “collateral damage” in modern military terminology) to which a peculiar iconographic selection should be allocated.

I. Morand (2005: 126-128) proposes to interpret this medallion, and the one with *Bellerophon*, the one with hunter with the hare and the Minotaur as astrological references to the constellations of *Perseus*, *Pegasus*, *Orion* and *Taurus*, respectively, but if “tout se passe comme si, dans la maison aux jets d’eau, on avait voulu faire penser les constellations par certaines associations d’idées au moyen d’images connues dans le répertoire iconographique plus antique non conçues pour représenter des constellations” (cit. Morand 2005: 128) it is clear that would be equivalent to a cipher decoding exercise, the results of which can never be validated against other possible theories, because we cannot conceive one *a priori* test of the theory that can come to validate it, because the figure would only truly be intelligible by its author; if the message recipient was not provided with a decryption key, this would be an exercise of steganography (U. Eco). We reject this proposal on methodological terms.

Bellerophon chasing the chimera was represented in a very incomplete *tondo* at the center of the south wing of the peristyle (CMRP 1, Mosaic 1.3 - Oleiro 1992: 41-44), slightly offset from the exact geometric position but architecturally correct to focus on the axis of the *exaedra*. The possible reconstruction of the missing parts indicate it would represent the chase of the monster, the victory of the hero being understood by allusion (Lopez 1990: 206; Oleiro 1992: 44), another ellipse of the moment less worthy of a glorified mythical narrative (*Bellerophon* overtaken by *hubris* and his fall and death).

In front of the *oecus-triclinium* in the center of the west wing of the peristyle, *Actaeon* attacked by his dogs was represented (CMRP 1, Mosaic 1.7 - Lopez 1990: 207-209; Oleiro 1992: 49-51), on the point of his transformation into deer, as punishment for his indiscretion, indicated by sprouting horns on his forehead (Fig. 6). Representations of *Actaeon* are rare in mosaics, and this particular reveals poor execution, not conveying the essential *pathos* of the scene (Oleiro 1992: 50-51). In addition to the possible locational interpretations given to the choice of this scene (Lancha 2004: 82), it should be noted that, as with *Perseus* and *Bellerophon*, there is an ellipsis of part of the story (the indiscretion of *Actaeon*); to paraphrase J. M. Bairrão Oleiro “it is a poorly told story” (Oleiro 1992: 36; the original sentence on the *Perseus*, is “for a well-told story the presence of *Andromeda* is indispensable”)

The victorious charioteer (Fig. 7) that runs through the starry sky, depicted in the room attached to the *triclinium* (A34 - 1 CMRP, mosaic 11 - Oleiro 1992: 117-125), may or may not be a heroic figure. G. López Monteagudo (1990: 220-221; 1999: 253-254), proposes identifying the charioteer as a representation of the apotheosis of *Hippolytus*, son of *Theseus*, ascetic hunter, victim of the baleful passion of *Phaedra* and of the rancor of *Aphrodite*, scorned in favor of the

Figure 6
Actaeon attacked by his dogs;
the *tondo* is framed by a
composition of dolphins and
small fish around a trident
(Photo Delfim Ferreira
©MMC-DGPC).



Figure 7
The victorious charioteer
from the main *diaeta* of the
house of the fountains
(Photo Delfim Ferreira
©MMC-DGPC).



hero devotion to *Artemis*, according to a legend mentioned by Pausanias (II, 32, 1). It may be a representation of *Sol Invictus*; the first proposal in this regard was made F. Camargo e Almeida (1970: 495-507) incomprehensibly discarded by J. Lancha (2004: 90-91) who reaches the same conclusion by other arguments (Lancha 2004: 91-93). The latter author, however, suggests a link of *Sol Invictus* to the imperial cult that may have been very important in a possible socio-political framework of *aemulatio* (conscious or unconscious) of the imperial practices by local elites in the affirmation, with caesarean echoes, of their own *dignitas*. Or it may be the symbolic representation of a victory in the field of sports extrapolated to the life of the *dominus*, carrying in it a huge development of possible interpretations and paraphrases, registered by I. Morand (2005: 133-138) collecting, among others, the earliest contributions of K. Dunbabin (1982: 84-87) towards the identification of the figure with the constellation of *Auriga*.

In any case it is, without the shadow of a doubt, the most discussed representation of all the mosaics of *Conimbriga*. It is also one of the surviving mosaics of the first phase of the decorative program of the house, which probably started in the last quarter of the II century (Oleiro 1992: 125).

5.2.2. The hunt

The grand representation of *venatio* in mosaics of the house of the fountains is undoubtedly the deer hunting scene (Fig. 8) in the central medallion of the *cenatio* that opens to the small private peristyle of the southern part of the house (A29 - 1 CMRP, mosaic 9 - Oleiro 1992: 104 -109). In no case of hunting depiction in the mosaics of the house - where there is always a superabundance of



Figure 8
The deer hunt from the *cenatio*
of the house of the fountains
(Photo Delfim Ferreira
©MMC-DGPC).

representation of the environmental details of the surrounding in which the activity takes place - is there anything to confirm the perception of C. Kondoleon (1991: 111) that one can be seeing the representation of public *venationes* in an amphitheater. In abstract, the argument is seductive to the sociopolitical representation of the owner, but the analysis of the mosaic does not support it, and the location of *Conimbriga* in a mildly urbanized region (unlike other examples used by the author) possibly made hunting in nature common and devalued *venatio* in the amphitheater of the local animals represented in mosaics (deer and wild boar).

Framed by a carpet of outstanding decorative richness, and later assisted by a pseudo-architectural treatment of the walls - of a very particular importance in its own standing - only under illusion can one call it a *tondo* (Lancha 2004: 86-87). Although it is striking that the representation owes something to Hadrianic *tondi* from the arc said of Constantine in Rome, it is no less true that the panel from the house of the fountains shows a superlative knowledge of narrative discourse, discursive can one say, well documented in the vault of Centcelles, as observed by J. Lancha (loc. cit.) and by G. Lopez Montegeagudo (1990: 216, about the scenes of the charioteer room to be mentioned later). This narrative discourse in the house of the fountains must be a development, parallel to the one at Centcelles, from a common origin which is not known to us directly.

The other important representation of the hunt is the one deployed in the *predella* surrounding the charioteer (Fig. 9), in the room already mentioned (CMRP 1, mosaic 11 - Oleiro 1992: 117-125). There, without the appearance of the master, all hunting phases are represented (Lancha 2004: 88-90).

Hunting is also represented in the medallion of the southeast corner of the central peristyle (CMRP 1, Mosaic 1.5 - Oleiro 1992: 46-47), in the form of a hunter (obviously a servant) who returns home, accompanied by his dog, carrying its prey, a hare (Fig. 10).

Figure 9
Hunter returning home.
Detail of a predella of the
victorious charioteer mosaic
(Photo Humberto Rendeiro
©MMC-DGPC).





The reference to hunting, in the figure of prey, also appears in small medallions in the main *triclinium* (CMRP 1, mosaic 10 - Oleiro 1992: 110-116), but this reference has been devalued for the one that is thought more evident, the representation of the family and its munificence exposed in the opulence of *xenia* offered to diners, *amici* or *clientes* they were.

5.2.3. The representation of the family

Self-representation of the *familia* appears in the house in discrete forms, but not the least important, particularly because of its location in key points of the decor:

First, the owner was represented with his firstborn in medallions (Fig. 11) in the mosaic of the main *triclinium* (CMRP 1, mosaic 10 - Oleiro 1992: 110-116; the interpretation is the one of J. Lancha 2004: 84-85; *contra* J. M. B. Oleiro 1992: 116). Second, the decorative motifs of the central panel of this room, whilst

Figure 10
Hare hunter and his dog from the
perystile of the house of the fountains
(Photo Humberto Rendeiro
©MMC-DGPC).

Figure 11
Side medallions with male figures
from the main *triclinium* of the
house of the fountains
(Photo Humberto Rendeiro
©MMC-DGPC).

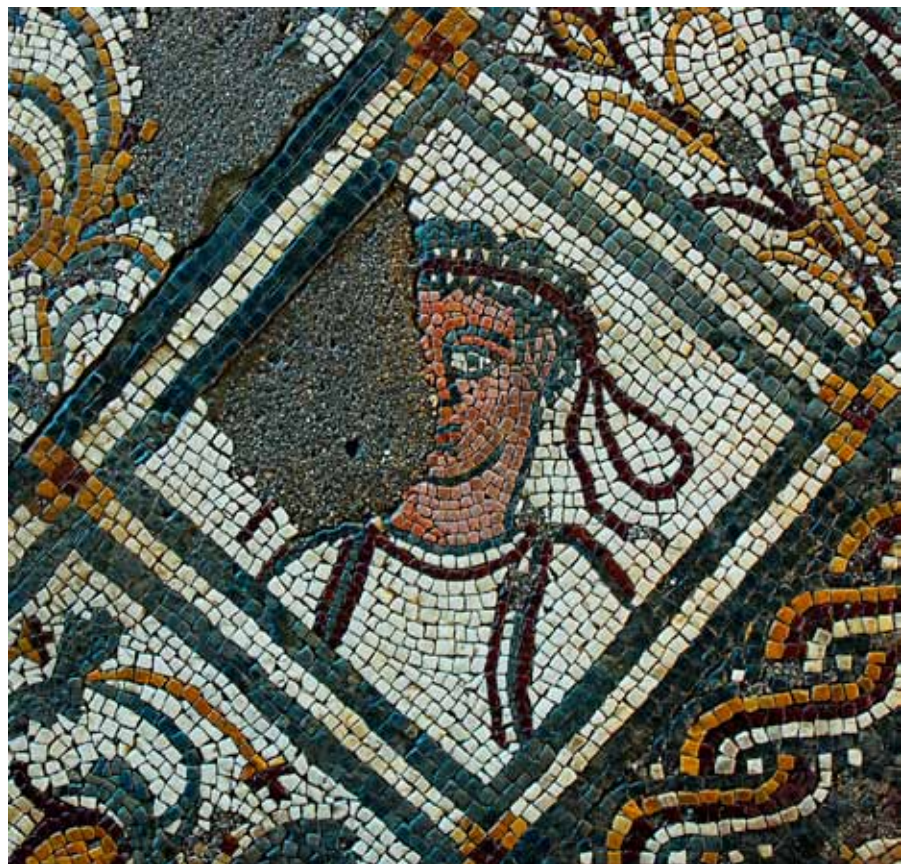
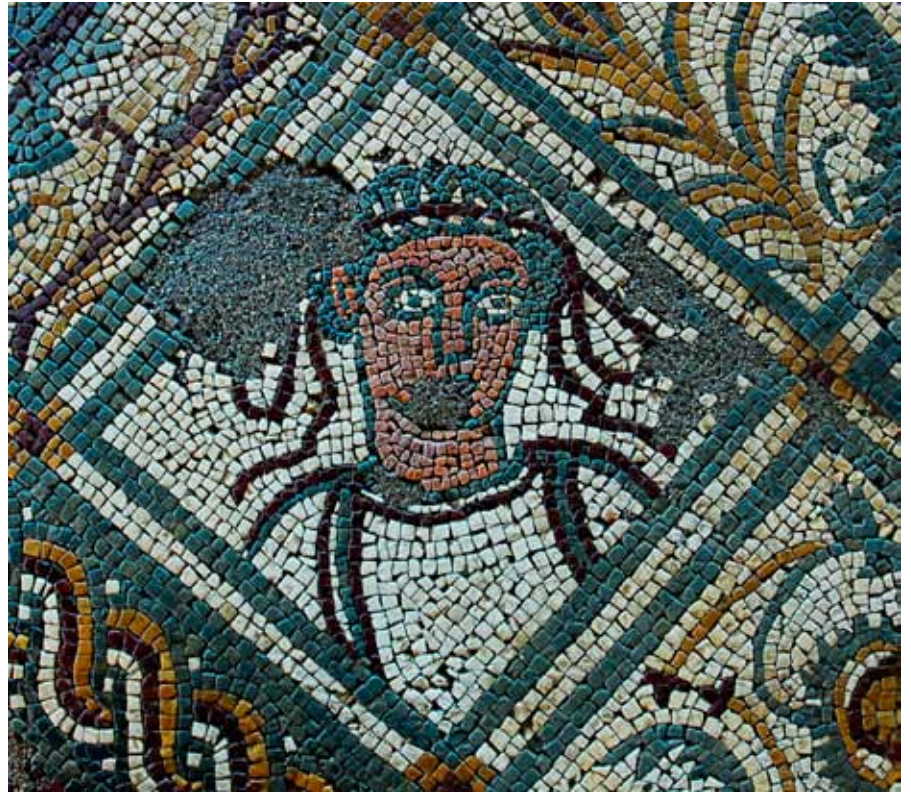

depicting the *xenia* are also a form of owner's representation. This interpretation of I. Morand (2005: 117-119) does not match exactly the one of J. Lancha (2004: 83) which adds a parallel, the *uilla* del Tellaro, which leads to another



Figure 12
Details of lion and roe from
the main *triclinium* of the
house of the fountains
(Photo Humberto Rendeiro
©MMC-DGPC).

mosaic of *Conimbriga*, the *cubiculum* mosaic of the house of the swastika (B12; Oliveira 2005: n° 23, 39). For G. Lopez Monteagudo (1990: 211) the *xenia* is a motif with Dionysian connotations.

But the fact that these representations, associated with *xenia* although not strictly speaking according to the stereotyped motifs of remains of opulent meals, obviously overlap with the theme of hunting (lion, roe. Fig. 12), tells a lot about the various levels of interpretation permitted (intended?).



Figure 13
 Servant carrying a piglet from
 the northern peristyle of the
 house of the fountains
 (Photo Delfim Ferreira
 ©MMC-DGPC).

A surprising way to represent the family is shown in the presentation of the house servants in daily activities, particularly in the access peristyle to the north wing (CMRP 1, mosaic 15 - Oleiro 1992: 139-140 fig. 13); in the same sense should be interpreted the identification of the servants (by name and by their physical characteristics, see Lopez 1990: 217-218 fig. 14) in the hunting *predellae* of the *Auriga* room (Lancha 2004: 86-89); the hunter with the hare of the west angle of the peristyle has already been mentioned, but must be remembered at this point.



Figure 14
 The servant Severus holds
 a dog by the leech while
 pursuing a boar, from a
 predella of the charioteer
 mosaic (Photo Humberto
 Rendeiro©MMC-DGPC).

5.2.4. *The mythological background*

In the mosaic decoration of the house of the fountains there is a plurality of references to scattered elements of iconography and Hellenistic and Roman mythology, which function as a magma that underlies the most consistently identifiable sets of specific references to individual myths, perhaps an essential line in the ideological discourse intended by the mosaic commissioners, although probably on a speech devoid of an elaborate syntax.

Figure 15
The Silenus mosaic of the
house of the fountains
(Photo Delfim Ferreira
©MMC-DGPC).



This hypothesis deserves an appreciation on its own for the semiotic implications that it inevitably has. Preliminarily, it can be established that it must be recognized that these choices in the mosaics were conscious, unless the theogonic references present in them were completely beyond the cultural and ideological luggage of the commissioners and the producers of mosaics, which is not credible against the global set of evidence of literacy, artistic and architectural knowledge and erudition that the residential architecture *Conimbriga* shows.

If the less eloquent character given to these representations was dictated by an actual depreciation in the way these representations were seen, or if we are dealing with the effects of ulterior motives that advised references by ellipses, is an impossible decision in the present state of our knowledge, and it is equally impossible a precise reconstruction of motivations and mental processes present at the time of the decision.

Figure 16
Marine centaur in a vignette
in the center of the *exaedra* of
the house of the fountains
(Photo Delfim Ferreira
©MMC-DGPC).



Within this broad semantic category, the main representation is linked to the Dionysian cycle; *Silenus* mounted on a donkey (Fig. 15), one of the main rooms of the private area of the house (A28) *cubiculum vel cenatio*. *Silenus* is led by *Dionysos* himself or by a simple servant. The iconography is ambiguous, but the hypothesis of G. Lopez Monteagudo (1990: 227) that the driver of the animal is a satyr seems less likely.

The marine centaur depicted in the center of the exedra (A25 - 1 CMRP, mosaic 3 - Oleiro 1992: 84-87 fig. 16) has also been interpreted as an allusion to the marine triumph of *Bacchus* (Lopez 1990: 210) and assignable to this mythological cycle are the representations of fish and tridents (CMRP 1, mosaics 1.3, 1.12 and 1.16 - Oleiro 1992: 41-44, 60-61 - 66-67) surrounding the *tondi* of the central peristyle. The opinion of G. Lopez Monteagudo (1990: 230-231) attaches to these symbols an apotropaic character, seeing it as a way to combat *invidus* which is, by contrast, associated to the entire representation of the triumph of *pietas*, in this case the heroics represented in the *tondo*. A third, more general interpretation, unrelated to any particular cycle, but associated with the marine centaur, is the one put forth by Reis – Oliveira (2009: 35).

One also can associate to this cycle the representations of *canthari* with ivies sprouting from them (CMRP 1, mosaic 1:21 - Oleiro 1992: 74-75, in the center of the west wing of the central peristyle, CMRP 1, Mosaic 1.9 - Oleiro 1992: 55-57, in the northeast corner). These representations are arranged axially before the two main entrances to the house from the outside: the first through the main entrance; the second through the underpass from the road on the north side; but the intrinsic value of these interpretations is obviously feeble. *Canthari* are also represented surrounding the deer hunt mosaic (above, CMRP 1, mosaic 9, cf. Lancha 2004: 86). Interestingly, it is also to be recognized that these representations, which belong to later phases of the decorative program, gain importance in later dates, apparently replacing different imagery.



Figure 17
Camel and elephant in a
room of the north part of
the house of the fountains
(Photo Delfim Ferreira
©MMC-DGPC).



Figure 18
 The seasons in the corners of the victorious charioteer mosaic:
 a) Winter, b) Autumn,
 c) Summer, d) Spring
 (Photo Humberto Rendeiro
 ©MMC-DGPC).

The Nilotic motif represented in the center of the camel and elephant room (A35 - 1 CMRP, mosaic 12 - Oleiro 1992: 126-133 fig. 17), can be interpreted as an allusion to the Indian Triumph of *Bacchus* (Lopez 1990: 222). But this figuration can also be associated with the myth of *Orpheus* (Lancha 2004: 81), which is known elsewhere in special areas of residences (cf. Zanker 1993: 203-205).

The Seasons remain to be mentioned (Lopez 1990: 212 fig. 18), represented in corner frames to the charioteer, with the figures carrying vine branches in the interstitial spaces between the seasons and the central *tondo* (Fig. 19). I. Morand (2005: 132-133), associates them to *Aeon* in its sense of “force of life”; J. Lancha (2004: 90) suggests that it is a secondary representation of the seasons; G. Lopez Monteagudo (1990: 218) suggests their identification with the *Horae*, deities dispensing wealth and abundance.

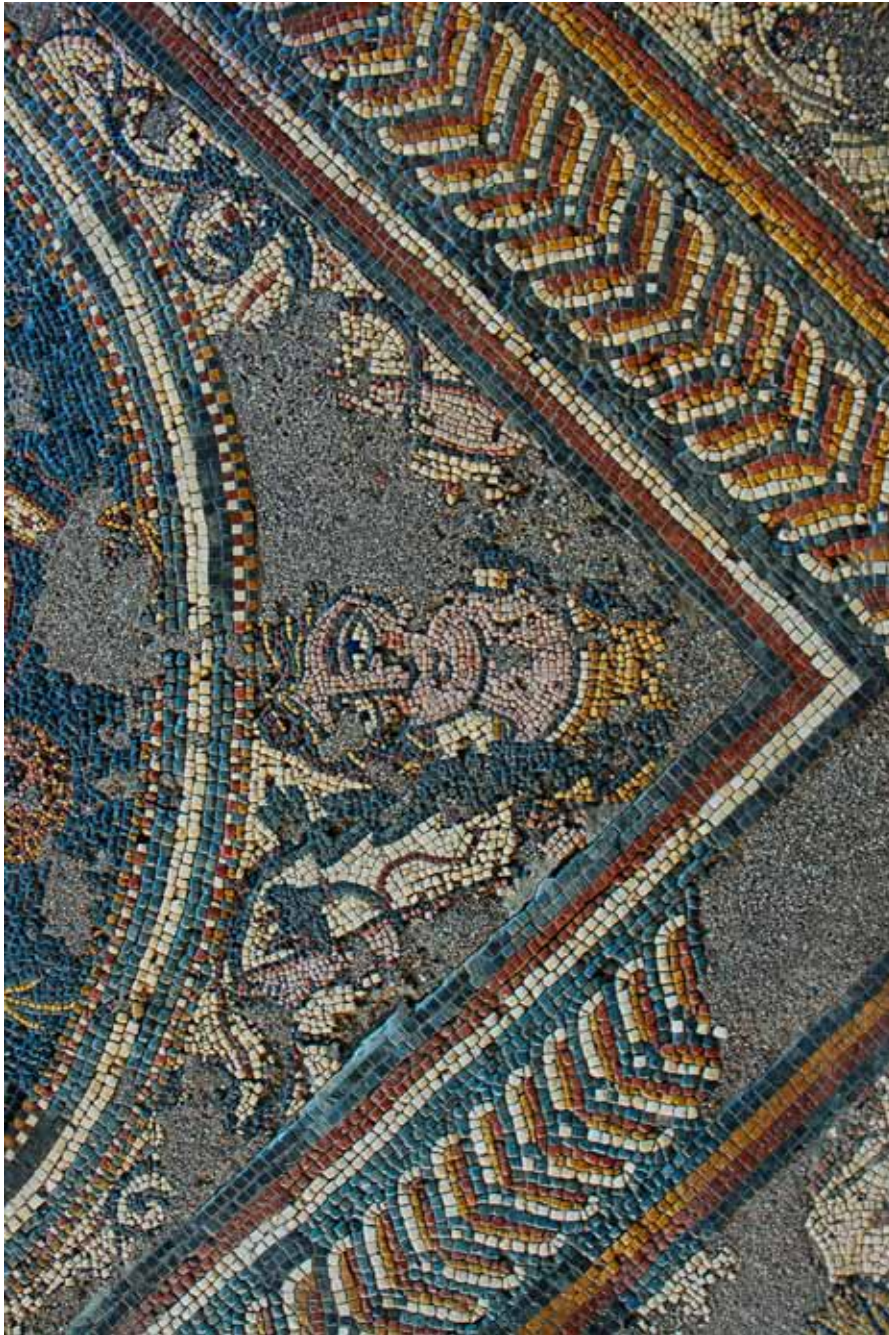

Figure 19
Feminine figure surrounding the
tondo of the victorious charioteer
(Photo Humberto Rendeiro
©MMC-DGPC).

5.3. Readings on the iconographic elements of the house of the fountains

A thorough and in-depth analysis of any supposed meaning of figural myths is notoriously difficult, and the specific form of their figurations, as they were specifically chosen at the time of an order is subject to the divergence of modern interpretations summarized here. Further identifying a motif (if at all possible), exploring meanings (not that they did not exist and have not been adequately exploited by the owners of buildings in their social representation) today seems, ultimately, a futile exercise.

A question needs to be asked: must it be admitted that the variation in modern interpretation is symmetric to the many meanings that these representations may

have had? If one imagines the multiplicity of readings possibly made between the years 200 and 300, when these figurations were available as a coherent whole, and in relation to the surrounding architecture, the answer is certainly: yes.

In modern anthropological research, all the meanings that the Greco-Latin literary tradition unveiled in these mosaics are valid, but none is *true*, because none is the only one valid. In this sense, the current multiple readings mimic possible coeval readings of the mosaics themselves: certain individuals bearing certain characteristics of education see in an icon specific references, perhaps distinct from other individuals of different education and cultural background; these many people, these many sets of erudition – so many references, so many meanings. The original meaning, residing in the *weltanschauung* of the ordering party (which, if we consider the entire life span of the representations, was not always present to settle eventual controversies), maybe was not absolutely conscious, may have never been verbalized or accurately transmitted to others; in any case, we lost it - hermeneutics is of no use here.

However, in decorative programs such as the house of the fountains displays, there is a general intentionality, a semantic field, where the decorative programs move like speech, and it should be possible to make a social and cultural approach to this speech and this semantic field.

This semantic field is erudite: the multiplication of mythological references attests it indisputably. But the scholarship is not academic, there was no intention of presenting a coherent sequence of images, and the way in which mythological references are fragmentarily represented can only be intentional, it must not be the product of any failure either of commissioners or mosaicists.

The three main lines of speech compete in the exaltation of the *dominus* by depicting his *virtus*, represented in hunting (Morand 1994: 252-258), which is a parallel of *pietas* (Lopez 1990: 229) of the hero (another way of *virtus*; Morand 1994: 259-267) represented as a heroic deed, both virtues resulting in the production of terrestrial harmony.

The *dominus* then, is the forbearer, to his own family and society at large, of cosmic order (Morand 2005: 145-146), from its most eminent members, enjoying *otium* in the fulfilled dream of universal harmony (André 1966: 519; Morand 1994: 260), to the most modest, carrying on with their daily activities in the timeless framework of the seasons and abundant nature (Morand 1994: 95-96).

5.4. The location of the decorative program in the architecture

Some particular aspects of the placement of the mosaic decoration in the architecture have already been mentioned, but even from a very limited point of view - from the strict viewpoint of decoration work - understanding the ideology values expressed by the decoration program does not dispense an analysis of how the program, as a whole, relates to the building, also as a whole.

Despite the reservations expressed elsewhere concerning access analysis in buildings (Correia 2013: 247), in this particular subject such analyses can be useful and the final exercise can result instructive.

Such an exercise, which results in three graphic analyzes carried out on the house plan (Figs. 20-22), which are believed to be self-explanatory, immediately gives two conclusions.

The first of these findings goes counter a phenomenological consideration, which is perhaps very common, that the mosaic decoration is invasive of all domestic



Figure 20
Locational distribution of the themes in the decorative program of the house of the fountains (Correia 2013: 305 fig. 136).

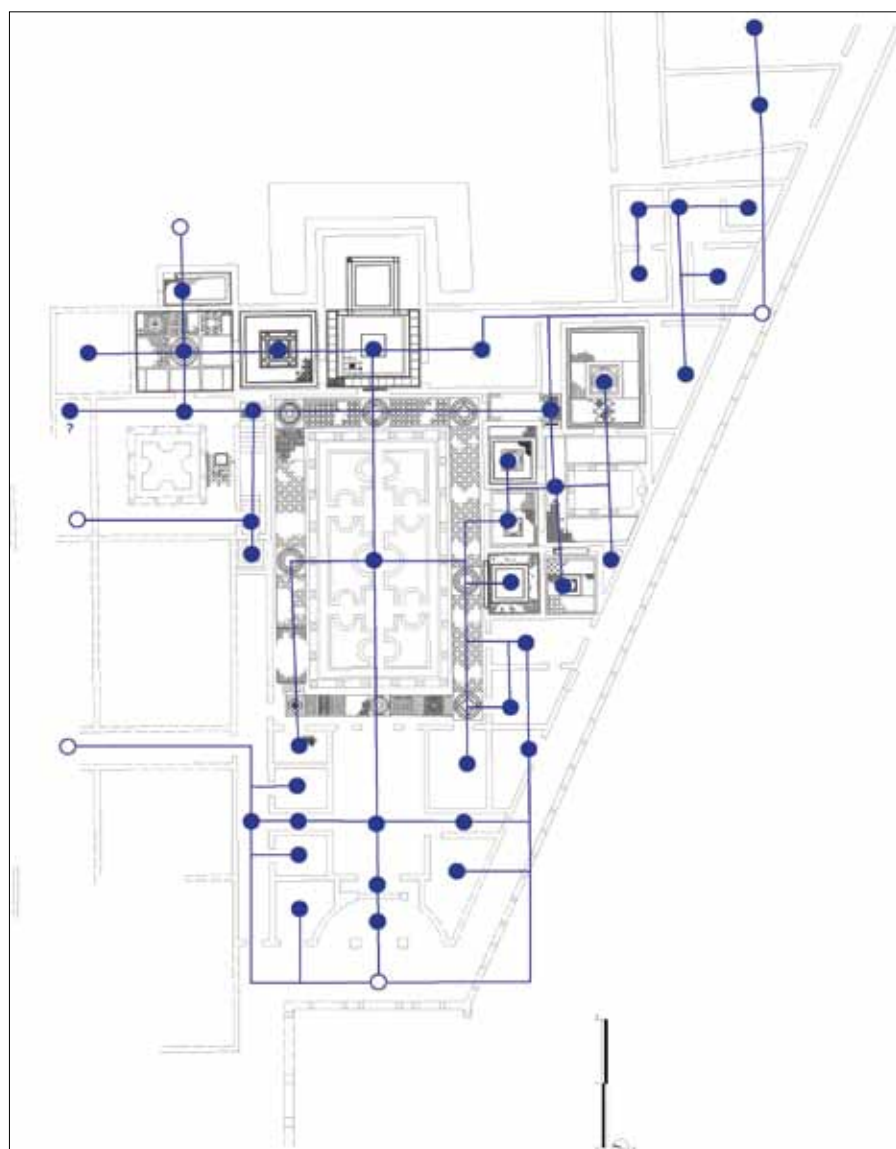

Figure 21
Access analysis of the house of the fountains ground plan (Correia 2013: 306 fig. 137).

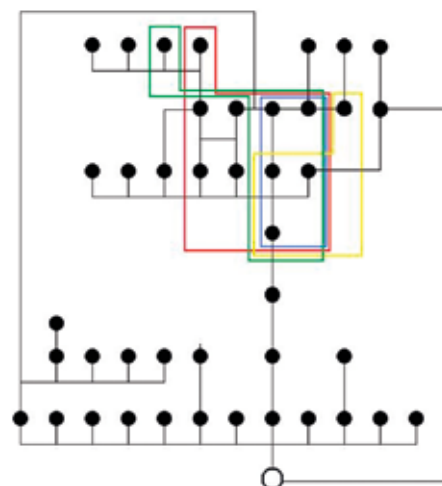

Figure 22
Distribution of figured themes in mosaics superimposed on the access scheme of the house of the fountains (Correia 2013: 307 fig. 138).

space. Rather, in particular with regard to figuration, the decoration is restricted to a very deep access zone, hence limited, in the residence.

The second conclusion is that various lines of the speech represented by the figurative decorations are, with respect to its topology, consistent and therefore somewhat redundant to each other.

This paper will come to these points later.

5.5. The mosaic decoration of the House of *Cantaber*

Conservation issues, but also questions of the original decorative program selection, create a very strong contrast between the decorative program of the house of the fountains and what one may reconstitute to have been the decorative program of the house attributed to *Cantaber*. This could be due to a relatively large chronological gap between the installation of these programs in and the other house, which would have allowed the mosaicists workshops of the town to significantly enrich their technique and their language, allowing them to meet the demanding orders from the commissioners of the decor of the house of the fountains in the mid II century in a way that the commissioners of the decoration of the house of *Cantaber*, in the first half of the century, could not expect to be satisfied. But this explanation is insufficient and must be postulated that there was actually a matter of taste underlying the division of styles in the houses, which still leads the decoration of spaces added to the house of *Cantaber* in the IV. century.

Only four iconographic elements survived in the house in a position to be analyzed.

Not included in these four are the decorations of the apsidal room which are part of the IV century addition, since they are manifestly not part of the original program, and this despite the integration of the later decoration in the same taste as the rest of the house, as mentioned above. These decorative elements have been studied by J. Hill (2006: I 169-171) and C. Mourão (2008: 48-50).

Much less studied than the house of the fountains, the very support of iconographic analysis of the house of *Cantaber* decorative program is completely different. The motifs identified are:

- In the private *cenatio* of the house (Oleiro 1973: 76-92 n° 1; C6 - Oliveira 2005: 51 n° 32;) the motif of crossed shields was used as a central element of square medallions that form the border of the mosaic (the central emblem was lost. Fig. 23).

The motif of crossed shields (Oleiro 1973: 83-86), which cannot be interpreted as merely decorative, alludes to the military trophies, popularized mainly from the decoration of Trajan's forum (Leon 1971: *passim*, with references in Ungaro 1994: 410- 412), which combined their sculptural representations with the display of actual coats of arms (Ungaro et al. 2004: 32. On the topic in general: Polito 1995: 110-113; Polito 1998: *passim*) which had a huge success in the provincial art of the west, namely in public buildings, spread in many motifs of unequal complexity, as in Orange (Amy et al. 1962: *passim*), *Clunia* (Acuña Fernández 1974: 213-229), most significantly in *Saepo* (Olvera, Cádiz; Beltrán 1999: 262) and, above all, in Merida (Nogales Basarrate 2007a: 468-471; Nogales Basarrate 2007b: 115-118).

The very incompleteness of the mosaic prevents a more accurate contextualization of the use of this motif, but certainly these echoes of the decoration of great



Figure 23
Crossed shields in the mosaic
from the house of Cantaber
(Photo Danilo Pavone
©Mediaprimer/MMC-DGPC).

public monuments were important in the interpretation of this coeval decoration of a private residence of exception.

- In the aisles of the south peristyle (C24; Oliveira 2005: 59, 64- mosaics nº 42 - C22 and nº 49 - C29) which distributes visitors to the *diaetae* of the house, the motif of the urban wall with gates and towers was used twice in symmetrical position, surrounding a composition of hexagons within a circle (Fig. 24).

The motif of the urban wall is known in *Conimbriga* in another example (Oleiro 1994b: 273-278; Oliveira 2005: 85 nº61), in the most common situation, surrounding a labyrinth (Barral y Altet – Navarro Saéz 1975: 503-522 lam. III). The



Figure 24
 The best preserved pavement of the existing two mosaics depicting a wall with towers and gates, from the Southeast peristyle of the house of Cantaber (Photo Danilo Pavone ©Mediaprimer/MMC-DGPC).

erudite references would not have been lost in this representation in the house of *Cantaber* (Lavagne 1988: 135-147; Hourcade 2002: 136-155, 136 n 24 for these examples), but their duplication and its specific position, marking the access axis from the main entrance of the peristyle off the *hortus*, and in the spaces through which access to the small rooms was preferentially made, must necessarily have been of special value and possibly transmitting a direct message to people accessing spaces, with the semiotics immediately available: the wall with gates



Figure 25
Octagonal composition surrounded
by *canthari*, from the Southeast of
the house of Cantaber
(Photo Danilo Pavone
©Mediaprimer/MMC-DGPC).

and towers is the very wall of *Conimbriga* and the composition of hexagons is an allegory of the city itself.

This opens a perspective of possible meanings for the motif of the wall and its gates in *Conimbriga*: is the labyrinth surrounded by the wall an allegory of the city as *dystopia* (Laurence 1997: 14-18), representing the city as the site of exercise of heroic *virtus*? Did the commissioner of the mosaic of the house of *Cantaber* choose to reduce the possible allegory and make a more direct speech in the representation of the city as a geometric construction (keeping the ideal representation of the exercise site of his *virtus*)?

- In one of *diaetae* (Oliveira 2005: 63, 48 - C28) in this area of the house, the octagonal composition of the central compartment was surrounded by four *canthari* from which ivy branches sprout (Fig. 25).

This motif of Bacchic reminiscences, which has been abundantly mentioned in connection with the house of the fountains, is here represented in a modest and contained form (as all the mosaics of the house) but that is possibly the earliest attestation of the motif in mosaic art in *Conimbriga*.

- On the same floor, but on its margins, some figurative elements were drawn in black on the white background: a trident in front of the door open to the west and a Mogor type labyrinth (Oleiro 1994b: 273-278) and two rosettes along the

door open to the north. The apotropaic character of these elements (on the value of the trident, see Lopez 1990: 230-23), would have been accorded to them by its very traditional nature and in a special way by its position within the housing architecture and its setting off the mosaic design. This is a reason to accept that the trident represents here a different function from what is recognizable in the house of the trident and the sword; there, the representation associated with the two weapons (Oliveira 2005: 74 n° 56) and the representation of a fishing net as a large decorative motif of an adjoining pavement (Oliveira 2005: 73 n° 55), associates the representation of these objects with gladiatorial games, something the special character of the building relates with the amphitheater (Correia 1994: 329-330; Correia 2016: 349-350).

5.6. Other residences

In the other buildings decorated by mosaics, the *cantharus* is the main motif that singles itself out, and moreover, used in a particular way.

The motif appears in the houses of the swastika (Oliveira 2005: 38 n° 22 - B11. Fig. 26) and in the house of the skeletons (Oliveira 2005: 45 n° 26 - B21. Fig. 27), in both cases it appears in the main *triclinia* without vine branches; in the second example it is associated with shells (Mourão 2008: 44-48), surrounding the representation of what would have been an *opus sectile* of rich stones (Pessoa 2016: 59-83).

Figure 26
The *triclinium* pavement of
the house of the swastika
(Photo Danilo Pavone
©Mediaprimer/MMC-DGPC).

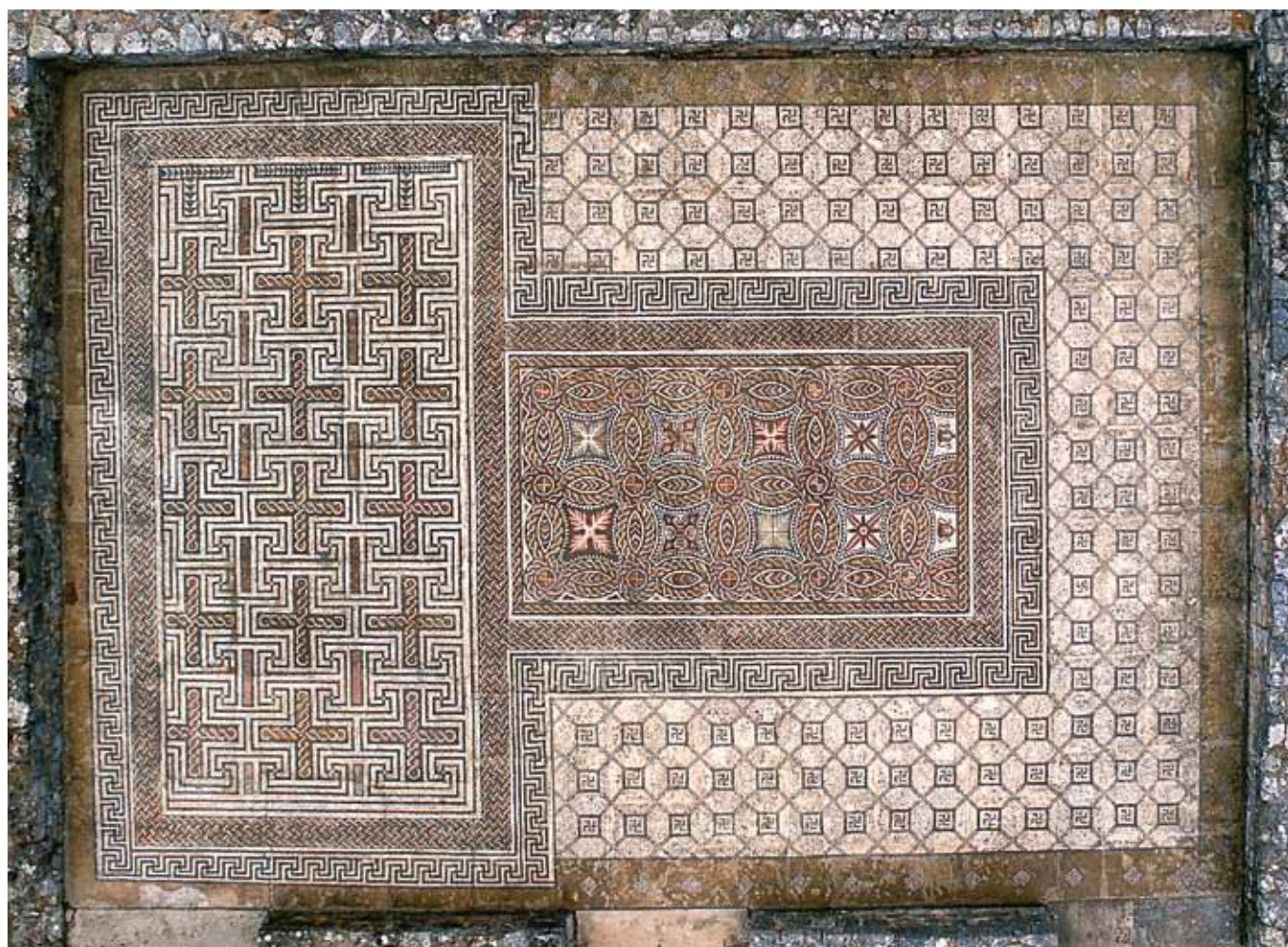



There is a third example in the house of the skeletons (Oliveira 2005: 47 n° 28 - B33A), with ivy branches.

The Bacchic references of the *cantharus* (Lopez 1990: 211), its association with *xenia* (Lancha 2004: 86) and the flowering of ivy as an allegory of abundance of

Figure 27
The *triclinium* pavement of the house of the skeletons (Photo Danilo Pavone ©Mediaprimer/MMC-DGPC).

nature (Lopez 1990: 218) were probably always been present in this representation. Its carefully studied position (in the case of the house of the swastika favoring the *locus consularis* and the traditional position of the host), pays tribute to the topological containment of the desired speech of the mosaic decoration.

A final, but provisional, reading

The moral and ideological discourse transmitted by the decorative program of the house of the fountains, was more complex than the simple semiotic exercise of reading an image of known significance. An almost private decorative program, as it turned out, reserved to the *loca propria* of the owners may have often been accompanied by a narrative (something that would not have happened with representations located in *loca communis*, which most likely would have to be decoded unaccompanied by an explanation that the *dominus* would not have failed to provide to his nearest *amici*).

In this line of reasoning it is revealing that the mosaic where all lines of discourse are present, the victorious charioteer mosaic, is located at the most reserved of the rooms, which is the *diaeta*, by definition the *locus proprius* of the *paterfamilias*. This must lead us to a conclusion that seems to underlie unconscious, never clearly verbalized in multiple analyzes the mosaic has already motivated: the charioteer is the actual owner of the house, commissioner of the mosaic, represented as power in triumph over all moral and ideological endeavors the decorative program suggests (a global allusion to the all the aspects of public and private life of the individual and his family), irrespective of cosmological or mythological allusion or narrative that the viewer may wish to make, within the eminently polysemic nature of representation.

In contrast, the whole question of the possible meanings of the house of *Cantaber* deals in incomplete knowledge. If the conservation status was different, some of the elements valued here could have been placed on the margins and other elements, possibly bearing a stronger speech could be called to the fore. But it is nevertheless possible, in contrast to the house of the fountains, to draw some analogies and some differences.

Amongst the differences is a possible substance of the speech. We did not find in the house of *Cantaber* any personalized reference; the allusions are made to war and the *urbs* it defends, to the extent that the *civitas* is *specula urbis* (Le Roux 1995: 97). But nothing more.

Analogies are the reserve of the figurative elements to the *loca propria* of owners, well demonstrated by the great monotony of continuous the geometric pattern of the peristyle mosaics and the multiplication of references (Bacchic and apotropaic) at the area restricted access of the house.

It could then be said that, although it deals with an art that is public in nature by virtue of the very life of the building, that the owners who commissioned the mosaics spoke mostly to themselves.

Bibliography – Kaynaklar

- Acuña 1974 P. Acuña Fernández, Los relieves de Clunia decorados com motivos militares, *Studia Archaeologica* n° 30, Santiago de Compostela/Valladolid, Universidades (Reprint Pere de Palol et al. 1991, Clunia 0 *Studia Varia Cluniensis* Burgos, 213-229).
- Alarcão 2010 J. de Alarcão, As casas da zona B de Conimbriga, Coimbra, CEAUCP.
- Alarcão – Etienne 1977 J. de Alarcão – R. Etienne, Fouilles de Conimbriga I, *L'architecture*, Paris, M.A.F.P./M.M.C.
- Almeida 1970 F. C. Almeida, “Considerações sobre o mosaico das quatro estações de Conimbriga – a representação do Sol”, *Actas do II Congresso Nacional de Arqueologia*, Coimbra, JNE, vol. II, 495-507.
- Amy et al. 1962 R. Amy – P.-M. Duval – J. Formigé – J. Hatt – C. Picard – G.-C. Picard – A. Piganiol, *L'arc d'Orange*, Paris, CNRS, 15th sup. to Gallia.
- André 1966 J.-M. André, *L'otium dans la vie morale et intellectuelle romaine des origines à l'époque augustéenne*, Paris, Fac. Lettres et Sciences Humaines, Série Recherches 30.
- Barral y Altet – Navarro Saéz 1975 X. Barral y Altet – R. Navarro Saéz, “Un motivo de orla itálico. Las representaciones de murallas en los mosaicos romanos de Hispania”, *Boletín del Seminario de Arte y Arqueología* n° 40-41, 503-522.
- Beltrán 1999 J. B. Fortes, “El esplendor de un Imperio: la época de Trajano”, *Hispania, El legado de Roma*, Mérida, MNAR, exhib. cat., 253-265.
- Bowman et al. 1996 A. K. Bowman – E. Champlin – A. Lintott, *Cambridge Ancient History X, The Augustan Empire*, Cambridge University Press.
- Correia 1941 V. Correia, “Las mas recientes excavaciones romanas de interes en Portugal. La ciudad de Conimbriga”, *Archivo Español de Arqueologia* 43, 257-267.
- Correia 1994 V. H. Correia, “O anfiteatro de Conimbriga. Notícia preliminar”, *El anfiteatro en la Hispania romana*, Mérida, MNAR, 327-344.
- Correia 2001 V. H. Correia, “Conimbriga. Casa atribuída a Cantaber. Trabalhos arqueológicos 1995-1998”, *Conimbriga* 40, 83-140.
- Correia 2003 V. H. Correia, “Notas sobre iconografia e arquitectura na casa dos repuxos (Conimbriga)”, *Livro de Actas do Congresso Internacional de Arqueologia Iconográfica e Simbólica*, Conimbriga, LAC, 121-131.
- Correia 2004a V. H. Correia, “O futuro dos estudos arqueológicos em Conimbriga”, V. H. Correia (ed.), *Perspectivas sobre Conimbriga*, Lisbon, Ed. Âncora, 49-80.
- Correia 2004b V. H. Correia, “Coexistência e revolução. Urbanismo e arquitectura em Conimbriga (séc. I a.C.-III d.C.)”, M. C. Lopes – R. Vilaça (coord.), *O passado em cena: narrativas e fragmentos. Miscelânea oferecida a Jorge de Alarcão*, Coimbra, C.E.A.U.C.P., 261-298.
- Correia 2011 V. H. Correia, “A pedra e o risco: arqueologia e arquitectura na investigação do fórum de Conimbriga”, L. T. Dias – P. Alarcão (coords.) *Interpretar a ruína. Contribuições entre campos disciplinares*, Oporto, FAUP, 157-160.
- Correia 2013 V. H. Correia, *A arquitectura doméstica de Conimbriga e as estruturas económicas e sociais da cidade romana*, Coimbra, Instituto de Arqueologia, Anexos de Conimbriga 6.
- Correia 2016 V. H. Correia, “A presença dos espaços de reunião no tecido urbano: o exemplo da cidade de Conimbriga (prov. Lusitania, Portugal)”, O. Rodríguez – N. Tran – B. Soler (eds.), *Los espacios de reunión de las asociaciones romanas. Diálogos desde la arqueología y la historia, en homenaje a Bertrand Goffaux*, Seville, ed. Universidad, 345-357.
- De Laine 1995 J. De Laine, “The Insula of the Paintings at Ostia i.4.2-igm for a city in flux”, T. J. Cornell – K. Lomas (eds.), *Urban Society in Roman Italy*, London, University College of London Press, 79-106.
- DGEMN 1948 Direcção Geral dos Edifícios e Monumentos Nacionais, *Ruínas de Conimbriga*, Lisbon, MOP Boletim Monumentos, n° 52-53.
- DGEMN 1964 Direcção Geral dos Edifícios e Monumentos Nacionais, *Ruínas de Conimbriga - Consolidação de Mosaicos*, Lisbon, MOP, Boletim Monumentos, n° 116.
- Dunbabin 1982 K. M. D. Dunbabin, “The victorious charioteer on mosaics and related monuments”, *AJA* 86, 65-89.
- Durán 1993 M. Durán, *Iconografía de los mosaicos romanos en la Hispania alto-imperial*, Barcelona, Un. Rovira i Virgili.
- Gonçalves 1903 A. A. Gonçalves, “Excavações nas ruínas de Conimbriga (Condeixa-a-Velha)”, *Portugalia* n° 1 (1899-1903), 359-365.

- Hill 2006 J. L. G. M. Hill, *Messages of immortality: interpretations of water symbolism in Roman mosaics*, PhD dissertation, Un. Wales College, Newport.
- Hourcade 2002 D. Hourcade, "Fortifications urbaines et discours idéologique: les représentations de murailles en Hispanie sous la République et le Haut-Empire", in *Fortificaciones en el entorno del Bajo G uadalquivir*, Alcalá de Guadaira, Congreso Internacional, 136-155.
- Kondoleon 1991 C. Kondoleon, "Signs of privilege and pleasure: Roman domestic mosaics", E. K. Gazda (ed.), *Roman art in the private sphere: new perspectives on the architecture and décor of the domus, uilla and insula*, Ann Arbor, Un. Michigan Press, 105-116.
- Lancha 2004 J. Lancha, "Sources images et originalité des ateliers de mosaïstes de Conimbriga", V. H. Correia (ed.) *Perspectivas sobre Conimbriga*, Conimbriga, LAC, 81-96.
- Laurence 1997 R. Laurence, "Writing the Roman metropolis", H. M. Parkins (ed.), *Roman urbanism beyond the consumer city*, London, Routledge, 21-41.
- Lavagne 1983 H. Lavagne, "Luxuria inaudita. Marcus Aemilius Scaurus et la naissance de la mosaïque murale", *Mosaïque - Recueil d'hommages à Henri Stern*, Paris, Ed. Recherches sur les civilisations, 259-264.
- Lavagne 1988 H. Lavagne, "Un emblème de romanitas: le motif des tours et remparts en mosaïque", *Le monde des images en Gaule et dans les provinces voisines*, Sévres, ENS, Caesarodunum 23, 135-147.
- Le Roux 1995 P. Le Roux, *Romains d'Espagne. Cités et politique dans les provinces*, Paris, Armand Colin.
- Leon 1971 C. F. Leon, *Die Bauornamentik des Trajansforum und ihre Stellung in der früh- und mittelkaiserzeitlichen Architekturdekoration Roms*, Vienna, Österreichischen Kulturinstituts in Rom.
- López Monteagudo 1990 G. López Monteagudo, "El programa iconográfico de la Casa de los Surtidores en Conimbriga", *Espacio, Tiempo y Forma, série II (Historia Antigua)* t. 3, 199-232.
- López Monteagudo 1999 G. López Monteagudo, "El mosaico del auriga de Conimbriga. Ensayo de interpretación", J. Alvar (ed.) *Homenaje a José M^a Blázquez*, Madrid, Ed. Clásicas, ARYS 2, vol. IV, 249-266.
- Morand 1994 I. Morand, *Ideologie, culture et spiritualité chez les propriétaires ruraux de l'Hispanie Romaine*, Paris, De Boccard, Publications du Centre Pierre Paris 27.
- Morand 1996 I. Morand, "A propos de la Maison des Jets d'Eau (Conimbriga, Portugal). Architecture et mosaïque", *Revue des Études Anciennes* n° 98 1-2, 207-222.
- Morand 2005 I. Morand, *La maison aux jets d'eau de Conimbriga (Portugal)*, Paris, De Boccard.
- Mourão 2008 C. Mourão, *Mirabilia aquarum. Motivos aquáticos em mosaicos da antiguidade no território português*, Lisboa, EPAL.
- Nogales 2007a T. Nogales Basarrate, "Culto imperial en Augusta Emerita: imágenes y programas urbanos", *Trinidad Nogales - J. González*, (eds.), *Culto imperial: política y poder*, Rome, L'Erma di Bretschneider, 447-541.
- Nogales 2007b T. Nogales Basarrate, "Teatro romano de Augusta Emerita. Evolución y programas decorativos", *Mainake* n° 29, 103-138.
- Oleiro 1965 J. M. B. Oleiro, "Mosaïques romaines du Portugal", *CMGR* I, 257-66.
- Oleiro 1973 J. M. B. Oleiro, "Mosaicos de Conimbriga encontrados durante as sondagens de 1899", *Conimbriga* 12, 67-158.
- Oleiro 1965 J. M. B. Oleiro, "Mosaico romano", J. de Alarcão (coord.), *História da Arte em Portugal*, Vol. 1, Do Paleolítico à arte visigótica, Lisbon, Pub. Alfa, 111-128.
- Oleiro 1992 J. M. B. Oleiro, *Conimbriga. Casa dos Repuxos*, Conimbriga, MMC, Corpus dos Mosaicos Romanos de Portugal 1.
- Oleiro 1994a J. M. B. Oleiro, "Mosaïques romaines de Conimbriga", *Le Portugal de la prehistoire à l'époque romaine*, Dijon, Les Dossiers d'Archeologie 198, 42-47.
- Oleiro 1994b J. M. B. Oleiro, "O tema do labirinto nos mosaicos portugueses", *VI Coloquio Internacional sobre Mosaico Antigo*, Palencia, Asociacion Española del Mosaico, 273-278.
- Oliveira 2005 C. Oliveira, *Mosaicos de Conimbriga*, Conimbriga, MMC.
- Oliveira 2008 C. Oliveira, "Fragmentos de mosaicos das termas do Sul de Conimbriga", J. P. Bernardes (ed.), *Hispania Romana - Actas do IV Congresso de Arqueologia Peninsular*, Faro, Un. Algarve, Promontoria Monografica 10, 183-195.
- Pereira 2008 R. M. Pereira, "Resultados dos trabalhos arqueológicos no Paço dos Vasconcelos (Maio de 2002 a Julho de 2004)", J. P. Bernardes (ed.), *Hispania Romana - Actas do IV Congresso de Arqueologia Peninsular*, Faro, Un. Algarve, Promontoria Monografica 10, 171-181.

- Pessoa 1998 M. Pessoa, Villa romana do Rabaçal. Um objecto de arte na paisagem, Penela, Câmara Municipal.
- Pessoa 2005 M. Pessoa, “Contributo para o estudo dos mosaicos romanos no território das civitates de Aeminium e de Conimbriga, Portugal”, Revista Portuguesa de Arqueologia 8-2, 363-401.
- Pessoa 2016 M. Pessoa, “Mimicking ‘marble’ in Roman mosaics in Conimbriga (Condeixa-a-velha – Portugal) discovered between 1938 and 1944 in the time of professor Vergílio Correia (1888-1944): a reflection”, JMR 9, 59-83.
- Polito 1995 E. Polito, “I fregi d’armi del foro di Traiano. La base della colonna e i pannelli nella storia del motivo”, E. La Rocca – L. Ungaro – R. Meneghini (eds.), I luoghi del consenso imperiale - Il foro di Augusto, il foro di Traiano. Introduzione storico-topografica, Rome, Commune, 110-113.
- Polito 1998 E. Polito, Fulgentibus armis. Introduzione allo studio dei fregi d’armi antichi, Rome, L’Erma.
- Reis – Oliveira 2009 M. P. Reis – C. Oliveira, “A água como elemento decorativo e a simbologia dos edifícios hidráulicos na Lusitânia romana. Alguns exemplos”, M. L. Cusatti (ed.), Portogallo e Mediterraneo. Atti del Congresso Internazionale, Naples, Un. “L’orientale”, 24-49.
- Ungaro 1994 L. Ungaro, “Il foro di Traiano: decorazione architettonico-scultorea e programma decorativo”, La ciudad en el mundo romano, Tarragona, CSIC, Actas do XIV C.I.A.C., vol 2, 410-413.
- Ungaro et al. 2004 L. Ungaro – M. Milella – M. Vitti, “Il sistema museale dei Fori Imperiali e i Mercati di Traiano”, Simulacra Romae, Tarragona, CUHR, 11-48.
- Zanker 1993 P. Zanker, Pompei. Società, immagini e forme dell’abitare, Turim, Giulio Einaudi.