



## SECOND LAW ANALYSIS OF AN ENVIRONMENTALLY FRIENDLY R290/R600/R600a MIXTURE IN A WATER-COOLED HEAT PUMP UNIT

Tayfun MENLİK\*, Hasan ÖZCAN\*\* and Erol ARCAKLIOĞLU\*\*\*

\*Gazi University, Technology Faculty, Department of Energy Systems Engineering, 06500, Ankara, TURKEY

\*\*University of Ontario Institute of Technology, 2000 Simcoe Street, Oshawa, ON, CANADA

\*\*\*Karabük University, Engineering Faculty, Department of Mechanical Engineering, Karabük, TURKEY

(Geliş Tarihi: 09.04.2013, Kabul Tarihi: 08.07.2013)

**Abstract:** In this study, second law analysis of environmentally friendly R290/R600/R600a mixture at a rate of 45/46/9 % by mass fraction has been experimentally executed on a water-cooled heat pump as a substitute for HFC134a at varying air and water mass flow rates. Experimental outputs indicate that the heat pump system shows the highest exergy efficiency at 0.040 kg s<sup>-1</sup> of water mass flow rate and 0.1 kg s<sup>-1</sup> of air mass flow rate running with both R134a and HC mixture. Even though proposed HC mixture has lower COP and rational efficiencies, cooling exergy efficiency of HC mixture is 2-3% better than that of R134a. Higher energy consumption and lower rational efficiencies can be resolved by a hermetic compressor with higher sweep volume which is compatible with pure and mixture hydrocarbons.

**Keywords:** R134a, Hydrocarbon Mixture, Heat Pump, Global warming, Second law analysis

## ÇEVRE DOSTU R290/R600/R600a KARIŞIMININ SU SOĞUTMALI ISI POMPASINDAKİ İKİNCİ KANUN ANALİZİ

**Özet:** Bu çalışmada, HFC134a soğutucu akışkanının yerine, kütleli olarak 45/46/9 % karışım oranlarına sahip çevre dostu R290/R600/R600a karışımının, su soğutmalı ısı pompasında değişik hava ve su debileri için ikinci kanun analizi yapılmıştır. Deneysel sonuçlar, ısı pompası sisteminin en yüksek ekserji veriminin, R134a ve HC karışımlarının her ikisinde de su ve hava için sırasıyla 0.040 kg s<sup>-1</sup> ve 0.1 kg s<sup>-1</sup>'de elde edildiğini göstermiştir. HC karışımı COP ve verim açısından daha düşük bir performansla sahip olmasına rağmen, HC karışımının soğutma ekserji veriminin R134a'dan %2-3 daha iyi olduğu görülmüştür. Yüksek ekserji tüketimi ve enerjinin rasyonel kullanımı ile ilgili problemler, saf ve karışım HC'lara uygun büyük süpürme hacmine sahip kompresör

**Anahtar kelimeler:** R134a, Hidrokarbon karışım, Isı pompası, Küresel ısınma, İkinci kanun analizi

### Nomenclature

C <sub>p</sub>	Specific heat
e	Specific exergy
Ex	Exergy rate
h	Specific enthalpy
m	mass flow rate
Q	Heat Transfer
s	Specific entropy
T	Temperature
w	Specific humidity
W	Work

### Subscripts

a	Air
b	Boiling
act	Actual
amb	Ambient
comp	Compressor
con	Condenser
cr	critic
des	Destruction
el	Electric
EV	Expansion Valve
HP	Heat Pump

i.th	i.th component
mec	mechanical
o	Outlet
r	Refrigerant
w	Water

### Acronyms

CFC	Chlorofluorocarbon
COP	Coefficient of Performance
HCFC	Hydroflorochlorocarbon
HFC	Hydro fluorocarbon
HC	Hydrocarbon
VCR	Vapor Compression Refrigeration
VRC	Volumetric Refrigeration Capacity
ODP	Ozone Depletion Potential
GWP	Global Warming Potential
LPG	Liquefied Propane Gas
M	Molar Weight
POE	Polyester Oil
IP	Improvement Potential
RI	Relative Irreversibility

### Greek Symbols

η	Efficiency
ψ	Exergy efficiency

## INTRODUCTION

CFC's had been the most common refrigerant used in refrigeration systems until *Molina and Rowland* made an investigation with their Nobel prized study that Chlorine atoms CFCs include, deplete the ozone layer (Molina and Rowland, 1974). After this study necessary and required regulations have been specified by Montreal Protocol in 1987 on phasing out chlorine including CFCs and HCFCs over the long term. World's refrigerant industry headed towards HFCs which is non ozone depleting with a high global warming potential (GWP) until it was seen that HFCs are not innocent as well with an announcement by Kyoto Protocol in 1997. CFC production and usage in Turkey has been stopped in all refrigeration units and HCFCs will be phased out by 2040 (UNEP, 1987). Refrigeration industry is now investigating for eco-friendly refrigerants and the most proper alternative refrigerants seem to be HCs without considering their high flammability properties (Powell, 2002).

Hydrocarbons are natural, non-toxic and non ozone depleting replacements for CFCs with negligible global warming potentials. Production costs are lower than that of artificial chemicals as they can be found in the nature. There is an ODP and GWP comparison of some CFCs, HCFCs, HFCs and HCs in Figure 1. It can be concluded from the figure that HCs are superior to those of halocarbons in terms of ecological advantages. When choosing HCs as alternative refrigerants, thermodynamic and thermo physical properties such as coefficient of performance, volumetric cooling capacity, critical temperature and pressure, molecular weight etc. should be considered and these properties should be similar or superior to the replaced refrigerant (Saleh and Wendland, 2006). Table 1 shows refrigerant properties of some refrigerants at +30/-40 condensing and evaporating temperatures. Variation of refrigerants COPs are 1%, and R1270 has the highest volumetric refrigeration capacity (VCR). VCR values of all refrigerants are proportional to their boiling points. This property does not give any indication related to energy consumption of refrigeration systems (Lemmon et al., 2002).

High flammability properties of HCs compel producers to take more security precautions and the refrigerant charge of HCs to refrigeration systems have been restricted by authorities in the US and EU. Besides, pressure indicators and gas leakage sensors must be set on the refrigeration systems including more than 1 kg of HC and pipe connections must be hermetic to be able to

prevent the system from sparking. Refrigeration unit must be distant from electrical devices and most suggested is that HC using systems should be used as the secondary systems out of enclosed spaces when required (IEC, 2001).

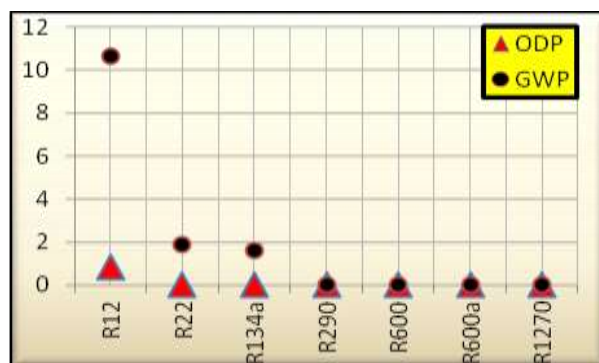

Figure 1. ODP and GWP (x1000) values of some refrigerants.

In this study, second law analysis of environmentally friendly R290/R600/R600a mixture at a rate of 45/46/9 % by mass fraction has been executed on a water-cooled heat pump as a substitute for HFC134a, thermodynamic properties of HC mixture and HFC134a have been obtained using REFPROP 7.0 software program. Coefficient of performances, exergy efficiencies, exergy destructions, relative irreversibilities and improvement potentials have been evaluated and compared for each refrigerant at 9 cases and the optimum cooling water mass flow rate and fan speed have been specified related to second law analysis.

## LITERATURE OVERVIEW

Many researchers have been investigated HC and HC/HFC mixture behaviors on various refrigeration systems as alternatives to R134a. *Kim et al. (1994)* investigated performances of 80/20 % R134a/R600a and 45/55 R290/R134a by mass fraction on a heat pump designed for R134a and it is obtained that R134a/R600a mixture has higher COP values and R290/R134a has higher VRC than that of R134a (Kim et al., 1994). *Wongwises and Chimres (2005, 2006)* experimentally analyzed pure, binary and ternary mixtures of R290, R600 and R600a HCs on a middle sized hermetic vapor compression refrigeration unit (VCR) as alternatives to R134a. The VCR system consumes less energy when 60/40 % by mass fraction of R290/R600 than that of

Table 1. Refrigerant properties of some refrigerants at +30/-40 °C condensing and evaporating temperatures.

	R12	R22	R134a	R290	R600	R600a	R1270
$T_b$ (°C)	-29,8	-40,8	-26,07	-42,11	-0,49	-11,75	-47,62
M(kg/kmol)	120,9	86,47	102,03	44,096	58,12	58,122	42,08
$T_{cr}$ (°C)	117,9	96,14	101,06	96,74	151,9	134,66	91,061
$P_{cr}$ (Mpa)	4,136	4,99	4,06	4,25	3,796	3,629	4,555
COP	2,547	2,519	2,484	2,468	2,589	2,499	2,471
VRC (J/dm <sup>3</sup> )	453,1	765,3	387,37	693,36	138,1	211,56	883,55

R134a and refrigerant charge of HC mixture is %50 less than R134a which makes HC mixture more economical. In another research above authors has specified that 50/40/10 % by mass fraction of R290/R600/R600a mixture had lower compressor discharge temperature and 16.5 % higher COP compared to R134a at 4-6 °C evaporation temperatures with their experimental study on an automobile air conditioner .

Fatouh and Kafafy (2006) experimentally analyzed the performance of LPG (60/40 R290/commercial butane) mixture as an alternative to R134a on a residential refrigeration system. Energy consumption of LPG using refrigeration system decreased 10.8 % and COP increased 7.6 % and it was specified that compressor discharge temperature, electricity consumption and VRC of the system has increased when the refrigerant charge increased. Optimum refrigerant charge to the system was specified as 60 g. In another study, a simulation was created for HCs and HC mixtures at ranges of -35 and -10°C evaporation temperatures 40-60 °C condensing temperatures. R290/R600/R600a mixture with 60 % R290 is at almost the same vapor pressure and input power with R134a. Discharge temperature and COP of HC mixture is 2 °C and 2.3 % higher and than that of R134a respectively.

Mani and Selludari (2008) offered 68/32 % of R290/R600a HC mixture as alternatives to R12 and R134a and denoted that HC mixture showed higher VRC and energy consumption. However HC mixture showed the best performance at higher evaporator and lower condensing temperatures. Mohanraj et al. (2009) has analyzed the performance of R290/R600a HC mixture as an alternative to R134a on a single evaporator domestic refrigerator. At 32 °C of ambient temperature, HC mixture has lower energy consumption, pull down time and on time ratio by 11.1 %, 11.6 % and 13.2 % respectively with higher COP values varying 3.25 – 3.6 %. Discharge temperature of HC mixture was found to be 8.5 to 13.4 °C lower than that of R134a . Park and Jung (2009) studied on R430A (R152a/R600a 76/24 % by mass fraction) on a residential water purifier as alternative to R134a. The small size of the system increased the effect of refrigerant charge on the system performance. 21-22 g of R430A charge consumed 13.4 % lower energy than that of R134a. With capillary tube optimization and proper compressor lubricant selection, R430A can be considered as a long term substitute to R134a in water purifiers.

Dalkılıç (2012) theoretically analyzed the performance of two-stage cascade refrigeration system using various alternative refrigerants (CFC-12, HCFC-22, CFC-502, and their alternatives, such as HFC-134a, HFC-152a, HFC-404A, HFC-407C, HC-290, HC-600a, R717 (ammonia), and three mixtures composed of HFC-134a, HFC-152a, HC-600a, and HC-290). It was found that refrigerant blends of HC290/HC600a (55/45 by wt%), as a non-azeotropic mixture, and HFC-152a/HFC-134a (14/86 by wt%) and HFC-134a/HC600a (82/18 by wt%), as azeotropic mixtures, gave lower performance

coefficients (COPs) and required lower refrigerant charge rates than their base pure refrigerants in the analysis.

Studies in the literature indicate that HC mixtures are proper refrigerants to be a substitute for HFC mixtures. Nevertheless, security concerns, equipment optimization and lubricant selection have been the key points of academic studies. Our study offers a new HC mixture which has 394.7 K of critical temperature, 4.344MPa critical pressure, 229.2 kg/m<sup>3</sup> density, -23.9 °C saturation temperature and 212.3 kJ/kg of latent heat with the specified rate and compares its second law performances with R134a and discusses the equipment compatibility for the suggested HC mixture.

## EXPERIMENTAL SETUP

Experiments have been conducted on a water-cooled heat pump unit which is a practical sample for vapor compression refrigeration system as the power input to compressor works up the system and runs the cycle. Heat pump unit is compatible with R134a and the compressor lubricant is polyester oil POE which is compatible with most HCs and HC mixtures as well. Figure 2 visualizes the system in details. Hermetic piston compressor of the system has a 8.85 cm<sup>3</sup>/rev of sweep volume with 2800 - 3400 rev/min and 60 Hz radial speed. Besides, the compressor is designed to be protected from extreme heat loads. Condenser has counter flow, parallel and nested pipes with a spiral design where the cooling water flows in the outer pipes of the heat exchanger. Evaporator has continual and externally finned pipes produced from Cu/Al alloys and steel. Thermostatically controllable expansion valve is available for extreme heating control. In addition to the main equipments, heat pump unit includes a filter drier, a fan, water and refrigerant mass flow meters, chronometer and wattmeter for measurement of compressor electricity consumption and a dimmer connected to fan for controlling the air mass flow through the evaporator. Besides, an external anemometer has been used to determine the air speed through the fan (Ozcan, 2011). 12 pieces of K type thermocouples are assembled to the main equipments inlets and outlets to be able to determine the thermodynamic properties of the unit and pressure transmitters mounted to compressor inlet and outlet. Data obtained from the heat pump unit has been transmitted to a computer via a data logger and transmission device. Numbers on the scheme represents the inlet and outlet values of main equipments, cooling water and fan air. These numbers on the figure are used as subscripts to be able to prevent the confusion in the equations.

Both HC mixture and R134a has been analyzed for 3 different water and air mass flow rates and consequently 9 different performance results for each refrigerant have been obtained. During the experiments, mass fractions have been considered and charge amounts of both R134a and HC mixture have been specified in terms of their density values at 25 °C using REFPROP. The

optimum charge and density of R134a to the system is 750g and 1270 kg/m<sup>3</sup> respectively. By considering the density of HC mixture as 534.4 kg/m<sup>3</sup>, charge of this refrigerant is determined as 315 g by using the density rates of R134a and HC mixture. When running the HC mixture in the heat pump, safety issues have also been considered and for the experiment area of 90 m<sup>3</sup>, it has been specified that the maximum charging amount of HC mixture is 0.68 kg and the refrigerant charge for present unit was under hazardous limit of 0.68 kg obtained from the literature (BSI, 1995). However, some safety precautions have been taken by providing proper ventilation.

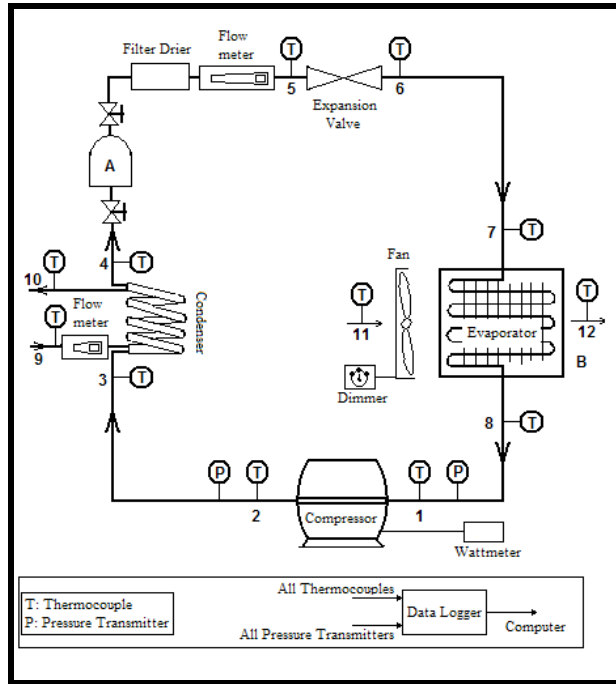

Figure 2. Schematic diagram of experimental setup

Technical properties of measurement devices are given in Table 2.

Table 2. Technical properties of measurement devices

Devices	Technical Properties	Accuracy	Total uncertainty
Anemometer	Velocity 0-20 m/s	± 0.01 m/s,	± 0.017 m/s
Thermocouple	K type, -200 °C- + 850 °C	±0.1 °C	± 0.14 °C
Pressure transmitter	0-40 bar, -50 - 85°C	± 2.5 mbar	± 2.75 mbar

## SYSTEM ANALYSIS

In the system analysis, coefficient of performances, exergy efficiencies, exergy destructions, relative irreversibilities and improvement potentials have been evaluated and compared for each refrigerant at 9 cases and the most efficient cooling water mass flow rate and fan speed have been specified related to second law

analysis. Table 3 shows the mass flow values of 9 cases and letters in the table represent air mass flow rates and numbers represent water mass flow rates.

Table 3. Air and water mass flow rates.

Fan air mass flow rate (kg s-1)	0,1	0,2	0,3
Water mass flow rate (kg s-1)			
0.020	A1	A2	A3
0.030	B1	B2	B3
0.040	C1	C2	C3

The letter symbols A, B and C designates water mass flow rates 0.02, 0.03 and 0.04 kg s<sup>-1</sup> and numerical symbols 1, 2 and 3 designates air mass flow rates 0.1, 0.2 and 0.3 kg s<sup>-1</sup>, respectively. To be able to simplify equations, some specified assumptions have been done and listed below (Dincer and Rosen, 2007);

1. All processes are steady-state and steady-flow with negligible potential and kinetic energies.
2. Reference environment parameters are measured as  $T_{amb}=32^{\circ}\text{C}$  and  $P_{amb}=90\text{ kPa}$  and assumed constant during experiments.
3. Heat transfer to the system and work transfer from the system is positive.
4. Air behaves as an ideal gas at a constant specific heat.
5. There is no chemical reaction during the process.
6. Mechanical and electrical efficiency of compressor is 69 %; of fan is 80 % and 40 %, respectively.
7. No pressure drops through heat exchangers

First and second law analysis of the system visualized in Figure 2 has been determined as follows;

Compressor:

$$\dot{m}_1 = \dot{m}_2 = \dot{m}_r \quad (1)$$

$$\dot{W}_{comp} = \dot{m}_r (h_2 - h_1) \quad (2)$$

$$\dot{Ex}_{des,comp} = \dot{m}_r (ex_2 - ex_1) + \dot{W}_{comp} \quad (3)$$

Condenser:

$$\dot{m}_3 = \dot{m}_4 = \dot{m}_r \quad (4)$$

$$\dot{m}_9 = \dot{m}_{10} = \dot{m}_w$$

$$\dot{Q}_{con} = \dot{m}_r (h_3 - h_4) \quad (5)$$

$$\dot{Q}_{con} = \dot{m}_w C_{p,w} (h_{10} - h_9) \quad (6)$$

$$\dot{Ex}_{des,con} = \dot{m}_r (ex_3 - ex_4) + \dot{m}_w (ex_9 - ex_{10}) \quad (7)$$

Evaporator:

$$\dot{m}_5 = \dot{m}_6 = \dot{m}_r \quad (8)$$

$$\dot{Q}_{evap} = \dot{m}_r (h_8 - h_7) \quad (9)$$

$$\dot{Q}_{evap} = \dot{m}_a C_{p,a} (T_{11} - T_{12}) \quad (10)$$

$$\dot{Ex}_{des,evap} = \dot{m}_r (ex_8 - ex_7) + \dot{m}_a (ex_{11} - ex_{12}) + \dot{W}_{fan} \quad (11)$$

Expansion Valve:

$$\dot{m}_5 = \dot{m}_6 = \dot{m}_r \quad (12)$$

$$h_5 = h_6 \quad (13)$$

$$\dot{E}x_{des, EV} = \dot{m}_r (ex_5 - ex_6) \quad (14)$$

Heat and environment interactions are neglected for above equations. Actual COP of the system and actual fan and compressor works are determined as follows;

$$COP_{act} = \frac{\dot{m}_w C_{p,w} (T_{11} - T_{12})}{\dot{W}_{comp,el} + \dot{W}_{fan,el}} \quad (15)$$

$$\dot{W}_{comp,el} = \frac{\dot{W}_{comp}}{\eta_{comp,el} \cdot \eta_{comp,mek}} \quad (16)$$

$$\dot{W}_{fan,el} = \frac{\dot{W}_{fan}}{\eta_{fan,el} \cdot \eta_{fan,mec}} \quad (17)$$

The total flow exergy of air is determined via considering specific heats and specific humidity for the designated temperature related to ambient temperature by Wepfer et al., (1979) ;

$$\begin{aligned} ex_a = & (Cp_a + wCp_w)T_{amb}[(T/T_{amb}) - 1 - \ln(T/T_{amb})] \\ & + RT_{amb}[(1 + 1,6078 w_{amb}) \ln\left[\frac{1 + 1,6078 w_{amb}}{1 + 1,6078 w}\right] \\ & + 1,6078 w \ln(w/w_{amb})] \end{aligned} \quad (18)$$

Exergy efficiencies of the heat pump system and components are determined as follows ;

$$\psi_{HP} = \frac{\dot{E}x_{o,evap} - \dot{E}x_{i,evap}}{\dot{W}_{comp,el} + \dot{W}_{fan,el}} \quad (19)$$

$$\psi_{comp} = \frac{\dot{E}x_2 - \dot{E}x_1}{\dot{W}_{comp}} \quad (20)$$

$$\psi_{con} = \frac{\dot{E}x_{10} - \dot{E}x_9}{\dot{E}x_3 - \dot{E}x_4} \quad (21)$$

$$\psi_{evap} = \frac{\dot{E}x_8 - \dot{E}x_7}{\dot{E}x_{11} - \dot{E}x_{12}} \quad (22)$$

$$\psi_{EV} = \frac{\dot{E}x_6}{\dot{E}x_5} \quad (23)$$

In addition to above efficiencies, improvement potential defined by Van Gool (1997) and relative irreversibility defined by Szargut et al. (2002) rates are evaluated as follows ;

$$IP = (1 - \psi)(\dot{E}x_i - \dot{E}x_o) \quad (24)$$

$$RI = \frac{\dot{E}x_{des,th}}{\dot{E}x_{des,tot}} \quad (25)$$

## UNCERTAINTY ANALYSIS

The properties and calibration of equipment, observation, test conditions and reading may cause errors and uncertainties. Uncertainty analyses define the limits of accuracy of the measured data (Akpinar, 2010, Aktaş et al., 2010). So, temperatures, pressures and air velocities were measured by using measurement devices of the experimental setup. Uncertainty ( $W_R$ ) is calculated by (Holman, 1994):

$$W_R = \left[ \left( \frac{\partial R}{\partial x_1} w_1 \right)^2 + \left( \frac{\partial R}{\partial x_2} w_2 \right)^2 + \dots + \left( \frac{\partial R}{\partial x_n} w_n \right)^2 \right]^{1/2} \quad (26)$$

## RESULTS AND DISCUSSION

In this section, first and second law analysis of the system components and the system itself have been compared related to R134a and HC mixture. Actual COP values, exergy destruction rates, exergy efficiencies, relative irreversibilities and the improvement potential of the system have been evaluated and compared. Furthermore, exergy diagrams for each refrigerant have been drawn and described.

To be able to understand the thermodynamic behavior of mixture components and R134a are first theoretically evaluated at a pressure ratio of 4.5 for a conventional heat pump unit. Heating and cooling capacities, power consumptions, energetic and exergetic COP values are comparatively determined. Cooling capacity and power consumption of R290 refrigerant is the highest among other fluids due to its lower boiling temperature. A R134a refrigerant is used for medium temperature cooling applications, using R290 alone is not a better option due to its high energy consumption. Exergetic COP and specific irreversibilities of R134a, R290, R600 and R600a are represented in Figure 3 with varying ambient temperatures. At higher temperatures all refrigerants show higher exergetic COP and lower irreversibility as the temperature difference between evaporation temperature of refrigerants and ambient temperature increases. Highest specific irreversibility belongs to R600 and highest exergetic COP belongs to R290. These plotted values are again related to thermophysical properties of refrigerants. R600 has the highest boiling temperature among others and thus having the lowest exergetic efficiency and highest specific irreversibility.

Actual COP values of each refrigerant at 9 cases are shown in Table 4. With increasing air and water mass flow rates actual COP values decrease due to the decreasing heat transfer from air to evaporator. Although HC mixture shows higher volumetric refrigeration capacities than that of R134a, higher energy consumption brings lower actual COP values. R134a and HC mixture show the best performance at case A1 and B1 respectively. Increasing air mass flow rates have decreased actual COP values of both refrigerants. As actual COP values are determined by considering mechanical and electrical efficiencies of the

compressor and fan, these values are lower than that of cooling COP values which vary between 3.90 and 4.70.

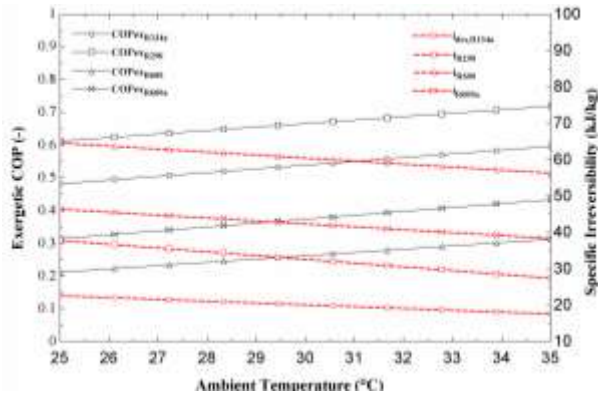
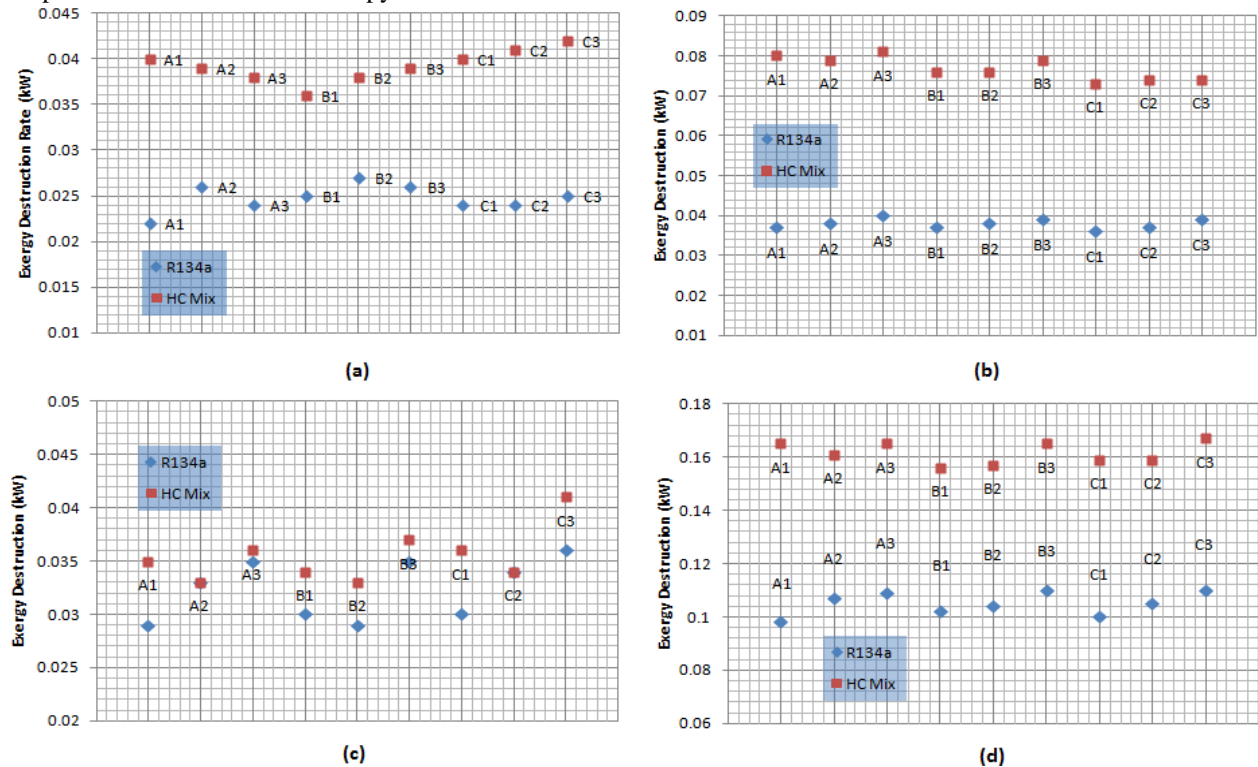

**Figure 3.** Variation of exergetic COP and specific irreversibility of refrigerant at different ambient temperatures.

During the exergy analysis, performances of components and the heat pump unit itself has been considered and plotted in Figure 4. Exergy destruction of the compressor using HC mixture is 29-44 % higher than that of R134a at 9 cases. Compressor has the highest exergy destruction rate at cases B2 and B1 and lowest at cases A1 and C2 for R134a and HC mixture respectively (Figure 4a). Exergy destruction rates are relatively higher for HC mixtures due to higher compressor discharge temperatures, ie high discharge temperatures increase the entropy and decrease the

exergy in infinitesimal terms. Also exergy destruction rate for the condenser is higher 48-56 % higher when running with HC mixture. Higher discharge temperatures and pressures cause this increase. Condenser has the highest exergy destruction rate at cases B2 and C2 and lowest at cases A1 and B1 for R134a and HC mixture respectively (Figure 4b).

When water mass flow rates increase a little decrease in exergy destruction rates for each refrigerant can be observed and air mass flow rate increase cause the total opposite effect on the condenser. Figure 4c designates the variation of exergy destruction rates of evaporator for each refrigerant. It can clearly be seen that variation of destruction rates are not proportional as in condenser and compressor. This is due to the randomness of heat transfer through air. HC mixture has lower exergy destruction rate at case A2 and C2 than that of R134a; however, increasing air mass flow rates increases exergy destruction for each refrigerant and 15 to 25 % decrease is observed when water mass flow rates are increased. Exergy destruction rates of expansion valve vary between 0.01 kW and therefore these value are neglected in terms of exergy destruction. A general discussion can be made for exergy destruction by checking the total destruction values of heat pump unit. Figure 4d indicates that HC mixture has higher exergy destruction rates than that of R134a and lowest exergy



**Figure 4.** Exergy destruction comparison of (a) Compressor (b) Condenser (c) Evaporator (d) Heat pump unit for R134a and HC mixture at all air-water mass flow rates.

**Table 4.** Actual COP values of refrigerants at varying mass and air flow rates

	A1	A2	A3	B1	B2	B3	C1	C2	C3
<b>R134a</b>	2.01	1.87	1.39	1.98	1.84	1.39	1.97	1.84	1.44
<b>HC</b>	1.59	1.62	1.39	1.74	1.66	1.43	1.38	1.37	1.37

destruction rates are at case C1 for both R134a and HC mixture. Increase of air mass flow rate results with more electricity consumption of fan and more random heat transfer through evaporator.

Exergy efficiencies of system components have been evaluated by equations (19) through (24) and plotted in Figures 5a, 5b, 5c and 5d for compressor, condenser, evaporator and heat pump unit respectively. From figures the most exergy efficient component is compressor for both refrigerants but 13-16 % decrease is observed for HC mixture. HC mixture shows better exergy efficiency than R134a in both condenser and evaporator. Lower water mass flow rates and higher air mass flow rates decrease exergetic efficiencies of both heat exchangers. Considering the exergy efficiency of heat pump unit best exergy efficiency percentages are obtained from the case C1 for both refrigerants. Denominator of equation (19) is used as real energy consumption of both fan and compressor and therefore the total exergy efficiency of the whole unit is lower when comparing to those of system equipments. As designated for heat exchangers above, when increasing air mass flow rates decrease exergy efficiency of the heat pump unit, increasing water mass flow rates increase the second law performance. Exergy efficiency of the system using HC mixture differs between 13-21 % and this value is 14-20 % for R134a.

Even if the heat pump unit is compatible with R134a refrigerant and first law analysis show that R134a using

systems performance is better than that of HC mixture, second law efficiency indicates that there is not a big difference between refrigerants in terms of cooling exergy. These results designates that a heat pump unit which is designed and constructed compatibly for HCs and their mixtures, HC mixtures will definitely have better performance results. Although HC using system consumes more energy, this disadvantage can be resolved by smaller system design with HC compatible equipments.

Relative irreversibility gives us the opportunity to compare equipments in terms of irreversibilities and specify the most exergy inefficient equipment by percentage and to determine in which equipment irreversibilities occur most. Relative irreversibility percentages of equipments for each refrigerant at 9 cases are plotted in Figure 6.

It is clear that compressor irreversibility rates for each refrigerant are between 23.2 - 25.8 % of the whole system irreversibility. Also the rate of expansion valve to the total irreversibility is around 5-8.8 %. Irreversibility percentage of expansion valve for R134a refrigerant has higher values than that of HC mixture as the total irreversibility of R134a using system is lower than that of HC mixture using system. Rate of heat exchangers' irreversibilities in total irreversibility are the highest for both refrigerants. While R134a running system shows higher irreversibility rates in evaporator,

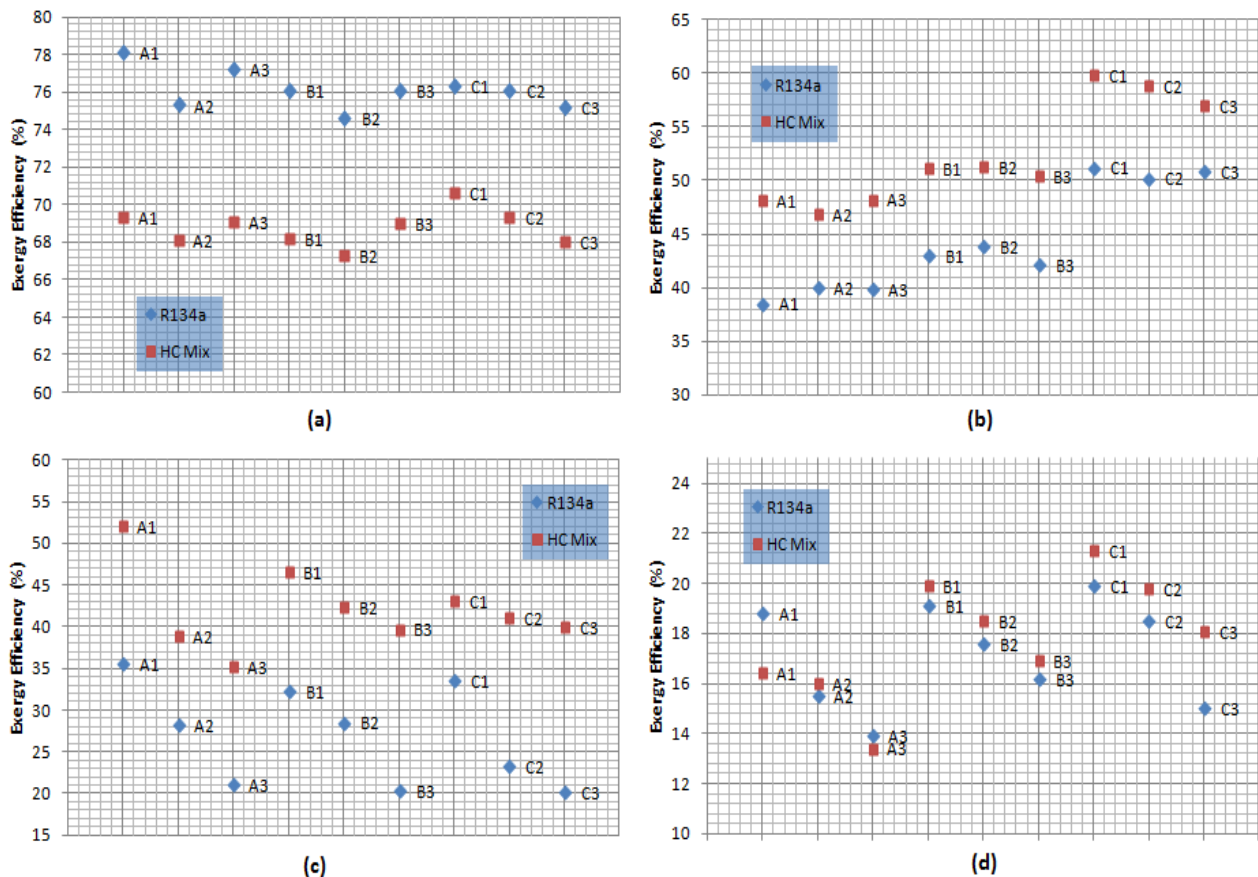

**Figure 5.** Exergy efficiency comparison of (a) Compressor (b) Condenser (c) Evaporator (d) Heat pump unit (cooling exergy efficiency) for R134a and HC mixture at all air-water mass flow rates.

HC running system shows this rate in condenser. This case is because of higher compressor discharge temperatures which occur as a result of the compressor sweep volume compatible with R134a but not for HC mixture. Increasing water mass flow rates decrease the rate of condenser irreversibility rate by around 10 % for HC mixture. Improvement potential of the heat pump unit designates the convertible exergy for the whole system in kilowatts and plotted in Figure 7. This description lets us to observe the convertibility of

energy for the whole system. As high as the improvement potential for the system, it means there are more irreversibilities and randomness. For both refrigerants C1 case has the lowest improvement potential which indicates that case C1 improves the lowest irreversibility values for both refrigerants in the system. A proportional variation can be observed from the figure that HC mixture has 0.04-0.06 kW higher improvement potential values at all cases.

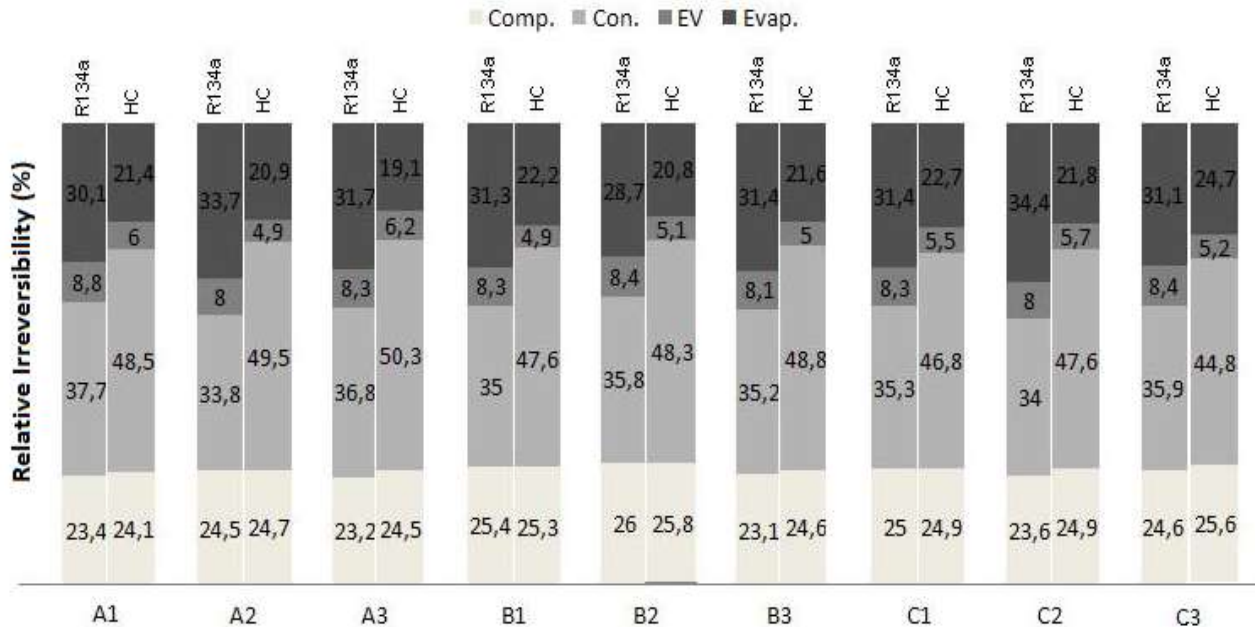

Figure 6. Relative Irreversibilities of system equipments at all air-water mass flow rates.

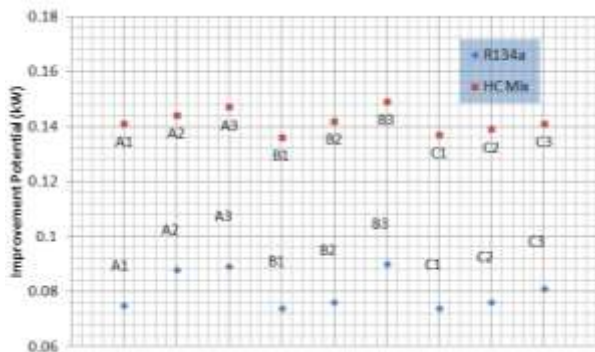

Figure 7. Improvement Potentials of Refrigerants at all air-water mass flow rates.

Second law analysis indicates that the best air-water mass flow rate case is C1 and to be able to see the exergy flow for this case exergy diagrams are generated for each refrigerant including fan energy consumption and shown in Figure 8. As seen in the figures HC using system consumes 19 % more energy than that of R134a using system and the available work is 5.1 % lower. Exergy destruction of compressor increases by 48 % for HC mixture due to lower compressor sweep volume which is compatible with R134a. Higher compressor discharge temperatures increase the condenser irreversibilities by more than 100 % for HC mixture. This result shows us that compressor selection is a crucial issue if the HC mixture is demanded as a

replacement. Evaporator and expansion valve exergy destructions are almost same for each refrigerant.

Considering exergy flow diagrams we can determine rational efficiencies by using the rate of available work per work input. In this case, the rational efficiencies are 58.8 % and 45.3 % for R134a and HC mixture respectively.

For the proposed hydrocarbon mixture, 8-12 °C higher compressor discharge temperature is observed comparing R134a. This is due to the compressor specifications as specified in Fatouh and Kafafy (2006). Compressors compatible with R134a might have higher energy consumption and discharge temperature when HC mixtures are used. 50% of refrigerant charge decrease is provided by Wongwises and Chimres (2005, 2006). 58% refrigerant charge decrease is provided for the proposed HC mixture in the present experimental setup decreasing from 750g R134a to 315g HC mixture. Lower performance coefficients have also been obtained as in Dalkilic (2012) using HC mixture as a substitute showing up to 14% lower COP values. However, up to 3% better exergetic efficiency is obtained for the proposed HC mixture than that of R134a. As exergetic evaluation is a better way to understand the system performance (Dincer and rosen, 2007) considering environmental parameters, HC mixture can be considered a more efficient refrigerant than R134a.



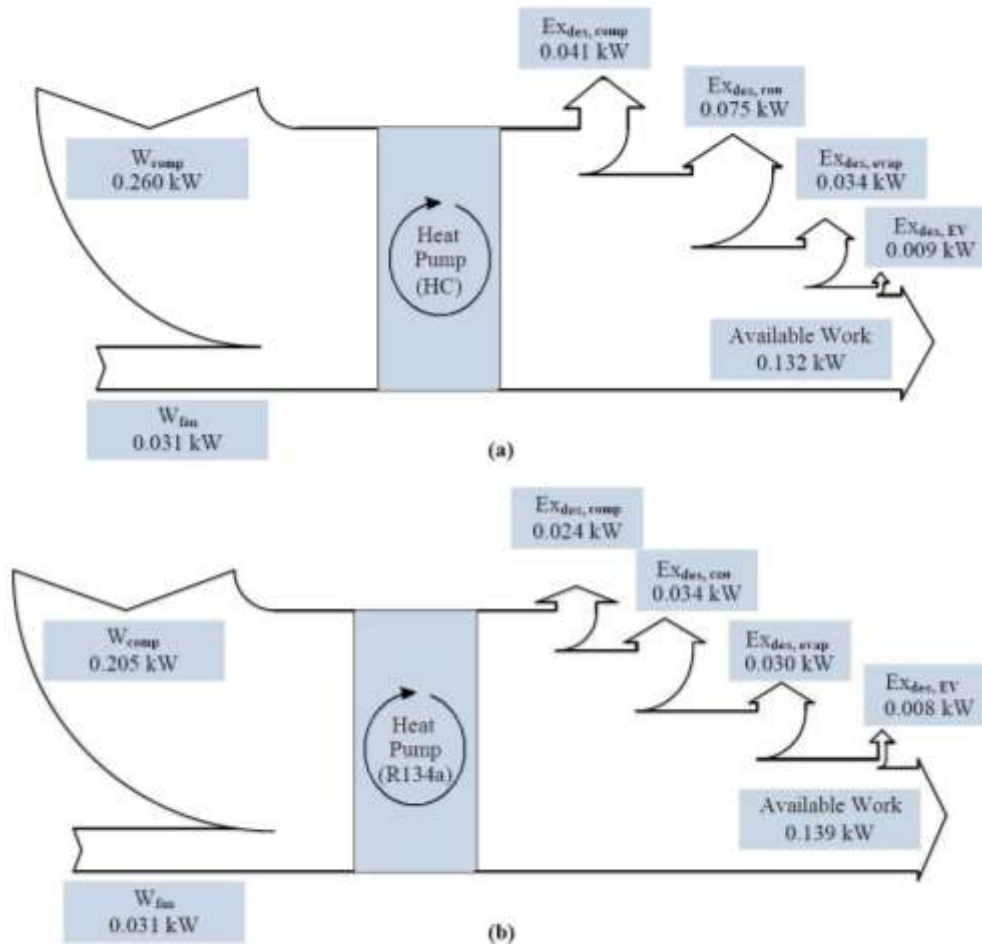

**Figure 8.** Exergy flow diagrams of heat pump unit for (a) HC mixture (b) R134a at case C1

## CONCLUSIONS

In this study, second law analysis of environmentally friendly R290/R600/R600a mixture at a rate of 45/46/9 % by mass fraction has been experimentally executed on a water-cooled heat pump at varying evaporator air and condenser cooling water mass flow rates as a substitute for HFC134a.

Energy consumption of heat pump system running with HC mixture is about 24 to 34% higher and the cooling capacity is from 18 to 19 % higher than that of R134a respectively. Actual COP of R134a and HC is the highest at the case A1 and B1 respectively. R134a has 14 % higher actual COP than that of HC mixture at cases where each refrigerant show the best performance. Both refrigerants show the best second law performances at 0.1 kg s<sup>-1</sup> air mass flow rate and 0.04 kg s<sup>-1</sup> water mass flow rate which is symbolized as case C1. Higher water mass flow rates and lower air mass flow rates enhance second law performances. Cooling exergy efficiencies of both refrigerants are almost same; 19.7 % and 20.7 % for R134a and HC mixture respectively at C1 case in terms of cooling exergy efficiency. If heating effect of heat-pump unit would be evaluated, R134a would show superior exergetic efficiency compared to HC mixture because of extreme compressor discharge temperatures of the

system running with HC. Best exergy efficiencies are obtained from expansion valve at all cases as this equipment was assumed as isenthalpic. Condenser has the highest irreversibility percentage among main equipments when HC mixture is used and Evaporator has the highest percentage when R134a is used in terms of relative irreversibility. It is concluded that heat exchangers are the most irreversible equipments of the system. Improvement potential of HC mixture is up to 45 % higher than that of R134a which shows that HC mixture running system has more irreversibility. Rational efficiency of R134a is 22.9 % higher than that of HC mixture at case C1. HC mixture using system requires 19 % additional work input and improves 5 % less available work comparing to R134a.

Even though HC mixture using system has not shown better energy performance results in terms of COP than that of R134a, higher volumetric refrigeration capacities and almost same cooling exergy efficiencies have been obtained for the HC running system. Offered HC mixture can be a substitute to R134a with its negligible global warming effects. When considering that HFCs like R134a will be phased out in the upcoming decades, further studies should be executed on varying air conditioning systems including equipments compatible with hydrocarbons. Better performances will be obtained

with optimized equipments. In addition security issues of HCs should also be regarded as these substances are highly flammable.

## ACKNOWLEDGEMENT

The study was funded by the Project (KBÜ-BAP-C-11-Y-007) supported by the Karabük University, Unit of Scientific Research Projects.

## REFERENCES

- Akpınar, E. K., 2010. Drying of mint leaves in a solar dryer and under open sun: Modelling, performance analyses, *Energy Conversion and Management*, 51(12), 2407-2418.
- Aktaş, M., Ceylan, İ., Doğan, H., Aktekeli, Z., 2010. Designing, manufacturing and performance experiments of heat Pump red pepper dryer assisted solar energy. *Journal of Thermal Science and Technology*, 30, 1, 111-120.
- British Standards Institution (BSI) Report, 1995. *Specification for safety and environmental aspects in the design, construction and installation of refrigerating appliances and systems*, London, 120-156.
- Dalkılıç, A., S., 2012. Theoretical Analysis on the Prediction Of Performance Coefficient of Two-Stage Cascade Refrigeration System Using Various Alternative Refrigerants, *Journal of Thermal Science and Technology*, 32, 1, 67-79.
- Dincer, I., Rosen, M.A., 2007. Exergy: Energy, Environment and Sustainable Development, *Elsevier Science Publications*, 91-94.
- Fatouh, M., El Kafafy, M., 2006. Assessment of Propane/commercial butane mixtures as possible alternatives to R134a in domestic refrigerators, *Energy Conversion and Management*, 47, 2644-2658.
- Fatouh, M., El Kafafy, M., 2006. Experimental evaluation of a domestic refrigerator working with LPG, *Applied Thermal Engineering*, 26, 1593-1603.
- IEC 60079, 2001. Electrical apparatus for explosive gas atmospheres.
- Kim, M.S. Mulroy, W.J., Didion, D.A., 1994. Performance Evaluation of Two Azeotropic Refrigerant Mixtures of HFC-134a With R-290 (Propane) and R-600a (Isobutane), *Journal of Energy Resources Technology*, 116, 147-155.
- Lemmon, E.W., McLinden, M.O., Huber, M.L., 2002. NIST reference fluid thermodynamic and transport properties-REFPROP, *NIST standard reference database*, 23-Version 7.0.
- Mani K., Selludari, V., 2008. Experimental Analysis of a new refrigerant mixture as drop-in replacement for CFC12 and HFC134a, *International Journal of Refrigeration*, 47, 1490-1495.
- Mohanraj, M., Jayaraj, S., Muraleedharan, C., Chandrasekar, P., 2009. Experimental investigation of R290/R600a mixture as an alternative to R134a in a domestic refrigerator, *International Journal of Thermal Sciences*, 48, 1036-1042.
- Molina, M.J., Rowland, F.S., 1974. Stratosphere sink for chlorofluoro-methanes chlorine catalyzed destruction of ozone, *Nature*, 249, 810-812.
- Ozcan, H., 2011. *Performance determination of alternative refrigerants by using exergy method*, Karabuk University Institute of Natural and Applied Sciences, MSc Thesis, in Turkish, 38-43.
- Park, K.J., Jung D., 2009. Performance of alternative refrigerant R430A on domestic water purifiers, *Energy Conversion and Management*, 50, 3045-3050.
- Powell, R.L., 2002. CFC phase out: Have we met the challenge, *Journal of Fluorine Chemistry*, 114, 237-250.
- Saleh, B., Wendland, M., 2006. Screening of Pure Fluids as alternative refrigerants, *International Journal of Refrigeration*, 29, 260-269.
- Szargut, J., Ziebig, A., Stanek, W., 2002. Depletion of non-renewable natural resources as a measure of the ecological cost, *Energy Conversion and Management*, 43, 1149-1163.
- United Nations Environment Program (UNEP), 1987. *Montreal Protocol on Substances That Deplete the Ozone*.
- Van Gool, W., 1997. Energy Policy: fairly tales and factualities, *Innovation and Technology-Strategies and Policies*, 93-105.
- Wepfer, W.J., Gaggioli, R.A., 1979. Proper evaluation of available energy for HVAC, *Ashrae Transactions*, 85, 214-230.
- Wongwises, S., Chimres, N., 2005. Experimental study of hydrocarbon mixtures to replace HFC-134a in a domestic refrigerator, *Energy Conversion and Management*, 46, 85-100.
- Wongwises, S., Kamboon, A., Orachon, B., 2006. Experimental investigation of hydrocarbon mixtures to replace HFC-134a in an automotive air conditioner, *Energy Conversion and Management*, 47, 1644-1659.