

Turkish Journal of Engineering



Turkish Journal of Engineering (TUJE)
Vol. 2, Issue 2, pp. 49-53, May 2018
ISSN 2587-1366, Turkey
DOI: 10.31127/tuje.339946
Research Article

AUTOMATIC SLIDING DOOR ROPE MECHANISM DESIGN FOR VEHICLES

Hüseyin Mutlu ^{*1}, Burak Emre Yapanmış ² and Alper Günöz ³

¹Mersin University, Engineering Faculty, Mechanical Engineering Department, Mersin, Turkey
ORCID ID 0000-0002-4770-2873
huseyinmutlu@yahoo.com

²Mersin University, Engineering Faculty, Mechanical Engineering Department, Mersin, Turkey
ORCID ID 0000-0003-0499-6581
burakemreyapanmis@gmail.com

³Mersin University, Engineering Faculty, Mechanical Engineering Department, Mersin, Turkey
ORCID ID 0000-0001-7978-6306
alper.gunoz@gmail.com

* Corresponding Author

Received: 26/09/2017 Accepted: 19/11/2017

ABSTRACT

In the automotive sector, doors have an important issue in terms of vehicle and passenger safety. Therefore, different kinds of materials and mechanisms have been being designed and parameters have been being investigated and analyzed in order to increase the functional efficiency of the vehicle doors. In this study, an automatic open/close mechanism is designed which can be used in all types of vehicles with sliding doors. Sliding door mechanism with rope system was analyzed and information about the parts of the mechanism was explained. Door weight, rope diameter, torque, opening time of the door parameters were examined. Finally, the designed mechanism has mounted to a vehicle and it has been observed to work successfully.

Keywords: *Vehicle Gate, Sliding Door, Rope Systems, Mechanism Design*

1. INTRODUCTION

Vehicle doors are an important part that allows people to get on and off the automobile. A lot of different type of door are used in vehicles according to user requirements, vehicle body designs, and vehicle types. However, sliding doors are preferred on commercial vehicles frequently because of the ease of getting on and off. Additionally, due to the ease of use, the sliding doors are becoming increasingly widespread in passenger cars nowadays. Consequently, the number of commercial works on sliding doors increases day by day.

The doors are not only used getting on and off the car. At the same time, in any unfavorable situation that may occur in traffic, it should be in a structure that protects passengers in dangerous situations. Further, the weight of the door has become a very important issue because of emission restrictions and fuel consuming in the automotive industry (Balaban, 2011).

Works about sliding door are performed at the beginning of 20th century by W Ellis who is the first person applies to patent. Its work appears the today's track system (Ellis, 1913). In spite of the fact that there are a lot of scientific work about sliding door (Ömür *et al.*, 2014; Uzundere *et al.*, 2014; Güven *et al.*, 2015; Kurutluş *et al.*, 2015), there is no enough work about sliding door mechanism. However, it can be found a lot of patent work about sliding door (Ellis, 1913; Övgü 2017; Ungetheim 2017).

In this study, a designed sliding door system for a commercial vehicle is considered and an automatic door opening mechanism with a rope system is designed instead of a brake system. The parameters such as door weight, opening and acceleration time, pulley diameter was examined and the necessary motor power and torque analysis were performed for each situation.

2. MATERIAL AND METHODS

This work is mainly to design a new rope-type mechanism that provides possibilities for automatic opening and closing of sliding doors. The designed mechanism consists mainly of pulley, rope and spring tension control unit. The pulley should be placed so that it can rotate in a fixed body and it should be a helical tooth with suitable step to wrap the rope in sufficient quantity on the cylindrical surface. One of the end of the rope should contact the sliding door and another end should contact with the cylindrical pulley's two plane faces.

In this design, the drum and tension control unit is housed in a closed box called the body so that the drive unit of the mechanism is isolated against external influences such as dust and dirt. One end of the rope is settled to the plane surface of the pulley, the other is mounted at the appropriate position of the sliding door by passing through two deflecting rollers placed on the guide rail. This flexibility allows easy assembling. The part of the rope, which is from the deflection roller to the drive pulley, is passed through a flexible protective pipe. In addition, thanks to the insertion of the sliding door mechanism's pulley and the tension control unit in a box, the area that covered by the drive motor are reduced as much as possible.

The constituent parts of the automatic sliding door opening-closing rope mechanism and the mechanism for the vehicle are shown in Figs. 1-3. Opening the sliding doors are provided by the movement of the sliding door on the guide rail as shown in Fig. 2.

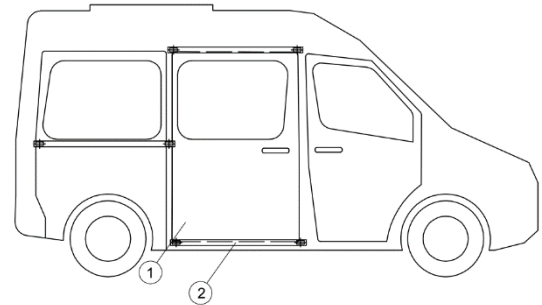

Fig. 1. General view of the vehicle where the system is used

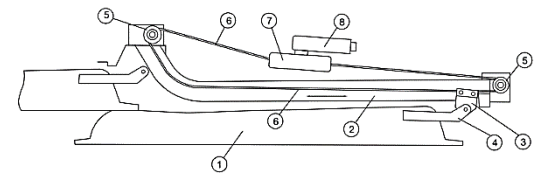

Fig. 2. The assembly view of the mechanism to sliding door

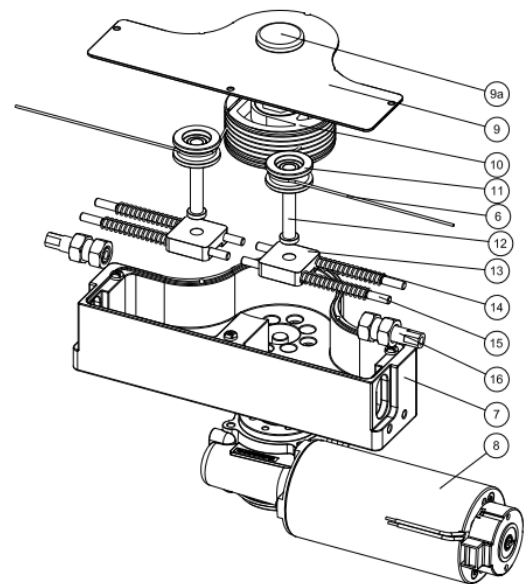

Fig. 3. Exploded view of the mechanism

In Fig. 1, number 1 represents car with sliding door, number 2 is sliding door's guide rail. In Fig. 2, number 3 is sliding door rope fixing plate, number 4 is sliding door rope fixing support plate, number 5 is sliding door rope deflecting pulley, number 6 is drive rope, number 7 is rope drive mechanism's body and number 8 is drive motor. Number 9 is rope drive mechanism body cover, number 9 (a) rope drive mechanism body cover support projection, number 10 is rope driving's pulley, number 11 is tensioner roller, number 12 is tensioner roller's pin,

number 13 is tensioner pin bearing, number 14 is tension spring, number 15 is tension pin, number 16 is driving rope body entrance in Fig. 3.

The operating principle of the mechanism can be summarized as follows to Fig. 3 and Fig. 4. One of the drive ropes, which is shown number 6, is wrapping around the rope drive pulley which is shown in number 10. At the same time, the other drive rope exits from the drive pulley. The sliding door is pulled by the driving rope and moves on the sliding door's guide rail. Similarly, while the other drive rope is wrapping on the rope drive pulley by the rotation of the drive motor in the opposite direction, the other drive rope exits from the rope drive pulley and the sliding door is moved in the opposite direction. Owing to this two-way motion, the sliding door is opened and closed.

In design, different parameters such as door opening time, door weight and opened door interval are determined. Numerical values of these parameters; opening times of the door are selected as 6 seconds, door weights are 50 kg and 80 kg and open door intervals are selected as 0.8 m and 1.3 m. In addition, according to the market survey and literature about the design of the door opening/closing mechanisms is based on an assumption that on a 17-degree incline road (Güven *et al.*, 2015).

The speed time graph of the sliding door opening and closing motion in the vehicles used in the current market conditions is determined as in Fig. 4.

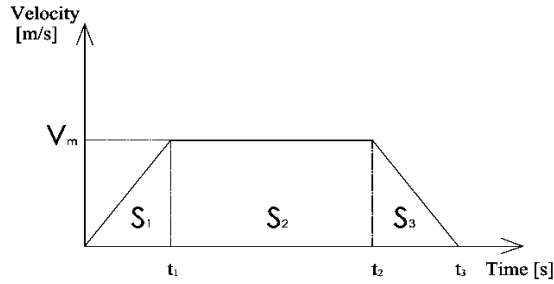

Fig. 4. Speed-time graph

The door is positive accelerating until V_m from 0 to t_1 intervals, is motion without acceleration at V_m from t_1 until t_2 and it is negative accelerating until the speed reaches to zero from t_2 to t_3 . The S_1 , S_2 , and S_3 , which are domain under the velocity-time curve during the movement, represent distance. The dynamic movement and force characteristics of the door can be calculated by selecting the time periods t_1 , t_2 , and t_3 .

It should be the operated to the drive mechanism in the critical position to calculate the maximum force values that occur in the ropes by the movement of the door. The free-body diagram of the vehicle operating at a slope of 17° is shown in Fig. 5.

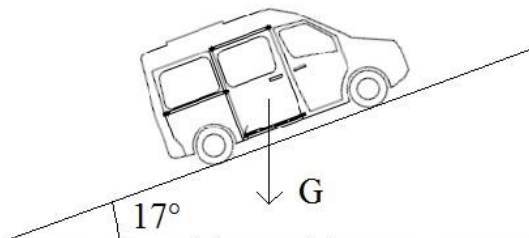

Fig. 5. Critical operation position

Thanks to the written equilibrium equations according to Newtonian motion law, the rope tension force (F_1 , F_2 , F_3) in each range is calculated as follows;

$$F_1 = ma_1 + mgsina + \mu mgcosa \quad (1)$$

$$F_2 = ma_2 + mgsina + \mu mgcosa \quad (2)$$

$$F_3 = ma_3 + mgsina + \mu mgcosa \quad (3)$$

Time dependent power (P) with the help of speed and force values; the time-dependent variation of the motor torque with the force and the radius of the pulley is obtained as follows;

$$P_1 = V_1 F_1; \quad \tau_1 = F_1 t_r \quad (4)$$

$$P_2 = V_2 F_2; \quad \tau_2 = F_2 t_r \quad (5)$$

$$P_3 = V_3 F_3; \quad \tau_3 = F_3 t_r \quad (6)$$

The speed time graph also informs the kinematic motion control characteristic of the drive motor. In order to calculate the dynamic force characteristic of the drive motor and the power values of the motor, the maximum distance was utilized from the speed-time graph in Fig. 5 and it is given in Eq. (7).

$$S_{max} = \frac{(t_1 - t_0)}{2} \cdot V_m + (t_2 - t_1)V_m + \frac{(t_3 - t_2) \cdot V_m}{2} \quad (7)$$

V_m with the required settings is as follows;

$$V_m = -\frac{2S_{max}}{t_1 - t_2 - t_3} \quad (8)$$

The velocities V_1 , V_2 and V_3 depending on time (t) can be calculated using Equation 8 as follows;

$$V_1 = \frac{V_m(t - t_0)}{(t_1 - t_0)} \quad (9)$$

$$V_2 = V_m \quad (10)$$

$$V_3 = \frac{V_m(t_3 - t)}{(t_3 - t_2)} \quad (11)$$

3. RESULTS

The torque and power values are numerically calculated according to the operating conditions. Door weights haven't got same values in existing cars with sliding door on the market. When these conditions are considered, the most common weights 50 kg and 80 kg are used. The opening time of the sliding door is defined as 6 seconds, and the deceleration times (t_1 and (t_3-t_2)) are selected equal as 0.3 and 0.5 seconds are used. The engine torque was calculated taking into account the three-different selected radius 0.05, 0.07 and 0.09 meters. In the calculations, the gravitational acceleration (g) was assumed to be 9.81 m/s^2 , and the friction coefficient (μ) was assumed to be 0.3.

Firstly, the engine torque-time graphs according to the

variation of the pulley radius are shown in Fig. 6. Power changing according to time for 50 and 80 kg door weights is shown in Fig. 7 and the changing of motor torque with time is shown in Fig. 8.

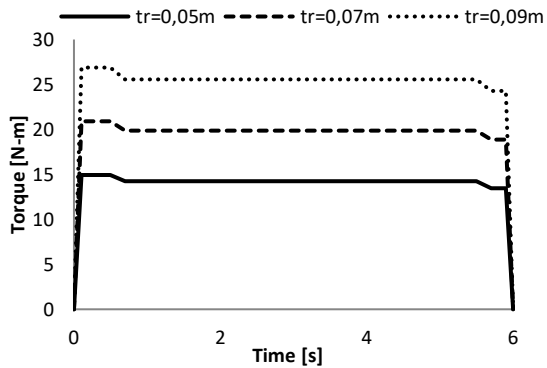

Fig. 6. Torque-time graph according to changing of the radius of the pulley

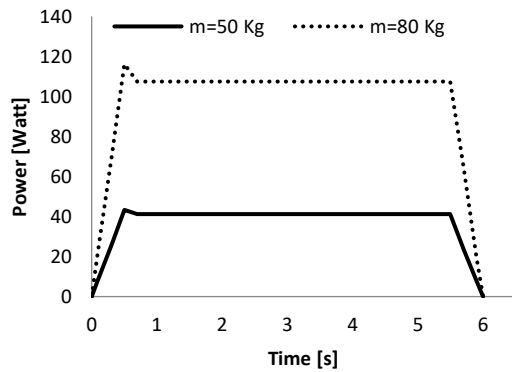

Fig. 7. Power-time graph according to changing door weight

As it is shown in Fig. 6 that the increase in the pulley radius caused the motor torque to increase. As a result of Fig 6, the best radius is chosen as 0.05 m.

Fig. 7 and 8 graphs show the variability in acceleration. There is a sudden rise in the beginning of each chart. The reason is that it is reached to a_1 acceleration from the speedless position. There is a small decreasing in curves due to $a_2 = 0$ and then it is going to stable until t_2 moment. Acceleration a_3 effects to system from time t_2 to time t_3 . All graphics tend to decrease until reset because of a_3 which is being in the negative direction.

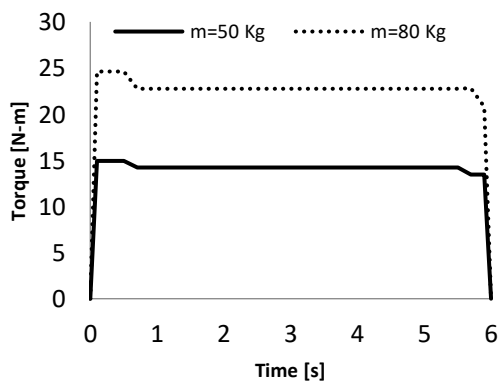

Fig. 8. Torque-time graph according to changing door weight

The changing of power and torque values taking into account two different starting and stopping times respectively 0.3 seconds and 0.5 seconds is shown in Fig. 9 and Fig. 10.

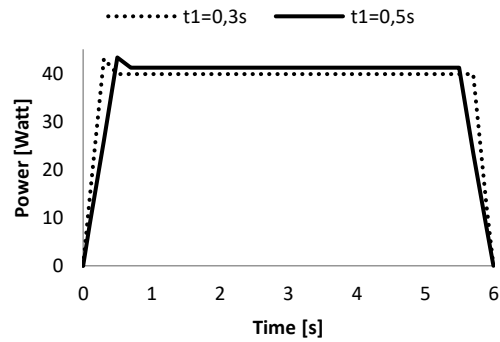

Fig. 9. Power-time graph according to changing door weight

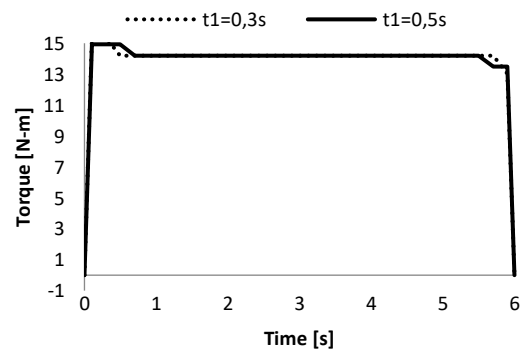

Fig. 10. Power-time graph according to changing door weight

In Fig. 9, it is shown that curves are a rapid increased until t_1 . From t_2 to t_3 , the acceleration is equal to zero, therefore, the curves a bit decreases then they tend to linear motion. After t_3 , the curves have a rapid decrease owing to the fact that the acceleration acts in the negative direction and it is going on until power is equal to zero.

It is shown that increase of curve because of acceleration in Fig. 10. Acceleration of opening/closing time 0.3 second is bigger than the acceleration of opening/closing time 0.5 second. The curves show linear behavior because of non-acceleration after t_2 . The curves show linear behavior because of non-acceleration from t_2 to t_3 . After t_3 , it is seen that the curves have decreased due to acceleration in the negative direction.

3.1. Experimental work

With the help of the numerical design algorithm, a prototype was designed and manufactured for a door weighing 50 kg, an acceleration time of 0.5 seconds and total time of opening 3 seconds, opened door interval 1.3 meters and a pulley diameter of 0.05 meters. The

experimental setup which is set up to test of the mechanism is shown in Fig. 11 and Fig. 12. The mechanism is mounted on a belt pulley kit which passes the driving rope through the deflection pulleys. The experimental works have been performed 120.000 rpm without any problem in this system.



Fig. 11. Experimental setup



Fig. 12. Application of the mechanism in the vehicle

4. CONCLUSION

Automatically opening and closing door mechanisms, which are frequently used in commercial and passenger vehicles, have an important place in the automotive sector. For this reason, different kinds of materials and mechanisms are designed and parameters are investigated and analyzed in order to increase the functional efficiency of the vehicle doors. In this work, information about the parts which consist of the mechanism is given and different weight, duration and pulley diameter parameters have been determined to increase the efficiency of the mechanism, minimize the mounting difficulties and to supply flexible assembly possibility. In addition, it is desirable to have the structural and potential flexibility to versatile usage possibilities in consideration of market needs, as well as cost-effective. The necessary analysis is carried out to provide these situations and an automatic sliding door mechanism is designed. It has been seen that a sliding door mechanism, which is automatically opened-closed, has been tried and installed on a real car and worked successfully. This system can also be alternative solutions applying as an elevator door and sliding doors of the building.

REFERENCES

Balaban G. B., (2011). Otomotiv Kayar Kapı Mekanizmalarında Ağırlık Optimizasyonu, Master

Thesis, University of Uludağ, Bursa, Turkey.

Güven C., Tufekci M., Bayık E., Gedik O., Tas M., (2015). "Experimental Verification and Finite Element Analysis of a Sliding Door System Used in Automotive Industry", *International Journal of Mechanical, Aerospace, Industrial, Mechatronic and Manufacturing Engineering*, Vol:9, No:10.

Uzundere C. M., Karakoç Ö. (2014). "Bir Taşıt Kayar Kapı Mekanizmasında Ayarlanabilir Kapı Durdurucu", *7th Automotive Technologies Congress*, Bursa, Turkey.

Kurtulus O., Yavuz C. (2015). "Examining the Modular End of Line Control Unit Design Criteria for Vehicle Sliding Door System Track Profile", *International Journal of Mechanical, Aerospace, Industrial, Mechatronic and Manufacturing Engineering*, Vol:9, No:10.

Ömür Ö.S., Rakipsiz C., Şengünel H. (2014). "Sliding Door Design Without B-Pillar for Passenger Cars" *7th Automotive Technologies Congress*, Bursa, Turkey.

2017/06937, (2017). Sayan Ö., Gündoğdu Ö., Topçu L., Ölmez H., *Taşıtlara Yönelik Kayar Kapı*, Turkish Patent and Trademark Office, İstanbul, Turkey.

WO/2017/142909, (2017). *Method and Apparatus of Extending Opening Ranges of Vehicle Sliding Doors*, World Intellectual Property Organization, Arizona, US.

1055969, (1913). W. Ellis, *Sliding Vehicle Door*, United States Patent Office.

Copyright © Turkish Journal of Engineering (TUJE). All rights reserved, including the making of copies unless permission is obtained from the copyright proprietors.