



**Yusuf Ulu**  
**Fırat Parlak**

Akim Metal Industry and Trade Inc./ R&D Center, İstanbul-Turkey  
yusufulu28.tr@gmail.com; fparlak@akimmetal.com.tr

DOI	<a href="http://dx.doi.org/10.12739/NWSA.2018.13.1.1A0396">http://dx.doi.org/10.12739/NWSA.2018.13.1.1A0396</a>	
ORCID ID	0000-0002-7958-682X	0000-0001-6072-4578
CORRESPONDING AUTHOR	Yusuf Ulu	

## **A DSP-CONTROLLED HIGH ACCURACY SPEED MEASUREMENT TECHNIQUES FOR MOTION CONTROL IN PMSM DRIVERS**

### **ABSTRACT**

In motion control drives, speed measurement with high accuracy is an important issue and has great influence on the motor performance. In this paper, speed measurement techniques' affects for motion control in permanent magnet synchronous machine (PMSM) with low resolution incremental encoder are discussed. Conventional speed measurement techniques such as measuring frequency method (M-method, measuring period method (T-method) and measuring both frequency and period method (M/T-method) are introduced. The simulation results are obtained in MATLAB/Simulink and the experimental results are presented based on TMS320x28xxx. Simulation and experimental comparative analysis of the various methods results show that M-method is suitable for high speed measurement, T-method is suitable for low speed measurement and M/T method is not related with speed and it works in both low speed and high speed. So the M/T method is better than the M-method and T-method and the speed measurement error is less than other methods with a high precision in a wide speed range.

**Keywords:** Speed Measurement, Motion Control, DSP, Incremental Encoder, Permanent Magnet Synchronous Machine (PMSM)

### **SMSM SÜRÜCÜLERİNDEKİ HAREKET KONTROLÜ İÇİN DSP KONTROLLÜ YÜKSEK DOĞRULUKTA HIZ ÖLÇME TEKNİKLERİ**

#### **ÖZ**

Hareket kontrollü sürücülerde, yüksek doğrulukta hız ölçümü önemli bir konudur ve motor performansı üzerinde büyük etkiye sahiptir. Bu makalede, düşük çözünürlüklü artımlı enkoder ile sürekli mıknatıslı senkron motorda (SMSM) hareket kontrolü için hız ölçüm tekniklerindeki etkiler ele alınmaktadır. Frekansı ölçme yöntemi (M-yöntemi), süre ölçme yöntemi (T-yöntemi) ve hem frekans hem de süre ölçme yöntemi (M/T-yöntemi) gibi geleneksel hız ölçüm teknikleri tanıtılmıştır. Simülasyon sonuçları MATLAB/Simulink'te elde edilmiş ve deneysel sonuçlar TMS320x28xxx temel alınarak sunulmuştur. Çeşitli yöntem sonuçlarının simülasyonu ve deneysel karşılaştırmalı analizi, M-yönteminin yüksek hız ölçümü için uygun olduğunu, T-yönteminin düşük hız ölçümü için uygun olduğunu ve M/T yönteminin hızla ilişkili olmadığını ve hem düşük hem de yüksek hızlarda çalıştığını göstermektedir. Dolayısıyla, M/T yöntemi M-yöntemi ve T-yönteminden daha iyidir ve hız ölçme hatası geniş bir hız aralığında yüksek hassasiyetle diğer yöntemlerden daha düşüktür.

**Anahtar Kelimeler:** Hız ölçme, hareket kontrolü, DSP, Artımlı Encoder, Sürekli Mıknatıslı Senkron Motor (SMSM)

#### **How to Cite:**

Ulu, Y. and Parlak, F., (2018). A DSP-Controlled High Accuracy Speed Measurement Techniques for Motion Control in PMSM Drivers, **Engineering Sciences (NWSAENS)**, 13(1):13-20, DOI: 10.12739/NWSA.2018.13.1.1A0396.



### 1. INTRODUCTION

Digital encoders are often preferred in high performance permanent magnet synchronous motor drives for motion control [1 and 2]. The accurate measurement of rotor angle and speed with digital encoders is required for speed control of the vector control method of these driver systems. A field-oriented control (FOC) diagram of PSMS is given in Figure 1.

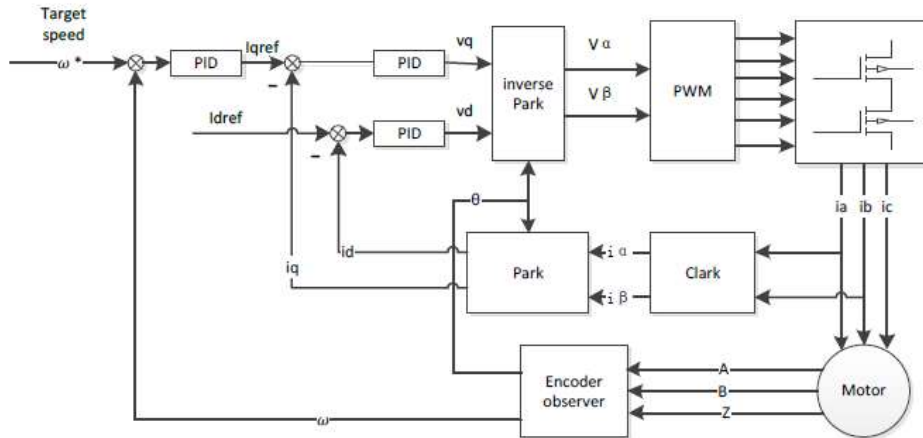

Figure 1. FOC control diagram with encoder

Digital encoders can be classified into two types, incremental encoder and absolute encoder. Absolute position is obtained with the absolute encoder while the relative position of the motor with the incremental encoder is obtained. Figure 2 shows the slot for an incremental encoder, which generates incremental "A" pulse and "B" and index pulse "Z". The relative position of an incremental encoder can be obtained by calculating of "A" and "B" pulse but to have the absolute position, some auxiliary pulses are added which is called "U", "V" and "W". By these pulses, the absolute position can be obtained with electrically  $\pm 30^\circ$  accuracy [3].

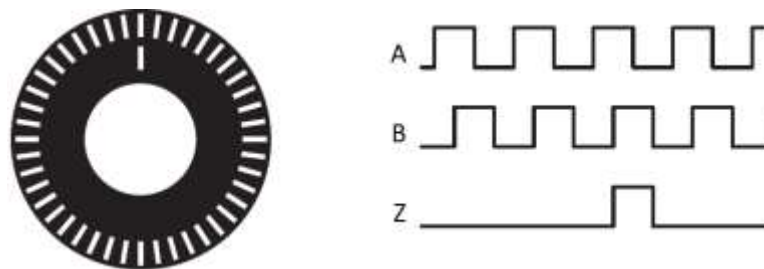

Figure 2. Slots of incremental encoder

It is an important issue to have accurate speed measurement for high performance motion control. The accuracy and bandwidth of speed can be increased by using an incremental encoder with high resolution but it has great effect on the cost of the drive. Besides that, low-resolution encoder limits the choice of speed measurement methods. There are many methods on speed measurements with incremental encoder. There are three commonly methods used among them: measuring frequency speed method (M method), measuring time speed method (T method) and measuring both frequency and time method (M/T method) [2 and 4]. There are also several speed prediction methods which are commonly used for PMSM drivers such as Kalman filter, full-order observer and discrete time observer [5 and 7].

## 2. RESEARCH SIGNIFICANCE

There are many methods to achieve accurate speed measurement in motion control drives. In permanent magnet synchronous machine, it has a vital role of choice of a correct speed measurement technique to have a high performance speed control with high precision and high control bandwidth. This paper will keep light on the choice of speed measurement technique between M method, T method and M/T method. In this paper, firstly, M method, T method and M/T methods which are used for incremental encoder are introduced in detail. Secondly, the structure of experimental setup is described. Finally, the simulation and experimental result of speed measurement techniques are given.

## 3. SPEED MEASUREMENT TECHNIQUES

### 3.1. Frequency Measurement (M-Method)

M method is an easy way to implement and widely used method to measure the motor speed from encoder pulses [2 and 3]. The principle of this method is based on counting the number of pulses in a fixed time interval as shown in Figure 3.

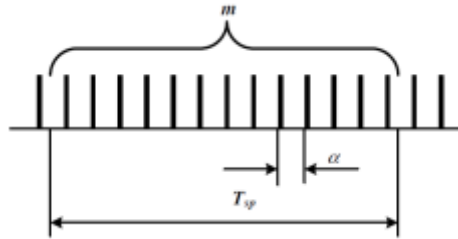

Figure 3. M method

The speed measurement by this method can be expressed as:

$$\omega = \frac{d\theta}{dt} \cong \frac{\Delta\theta}{T_{sp}} \cong \frac{2\pi \cdot \Delta N}{N_p \cdot T_{sp}} [\text{rad} \cdot \text{s}^{-1}] \quad (1)$$

$$\rightarrow \frac{60 \cdot \Delta N}{N_p \cdot T_{sp}} [\text{RPM}]$$

where  $\theta$  and  $\omega$  are rotor angle and speed,  $T_{sp}$  is sample period of speed,  $N_p$  is pulse per revolution (PPR) of encoder and  $\Delta N$  number of counted pulses in the sample period. In this method the speed measurement error is constant at any speed and depends on the pulse per revolution and sample period as expressed in Equation (2). This speed error can be tolerated at high speed while the speed measurement accuracy is getting worse at low speed region.

$$\frac{60}{N_p \cdot T_{sp}} [\text{rpm}] \quad (2)$$

There are several ways to reduce the constant speed measurement error in the low speed region such as using a high resolution encoder, increasing sample period and using low pass filter. However, high resolution encoder increase the cost of drive and increasing sample period or using low pass filter decrease the bandwidth of speed control loop.

### 3.2. Time Measurement (T-Method)

T method is realized by measurement the time interval between two adjacent pulses as show in Figure 4. The time interval is measured by using a high frequency clock [2 and 3].

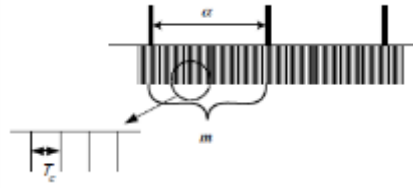

Figure 4. T method

The speed measurement by T method can be expressed as:

$$\omega = \frac{d\theta}{dt} = \frac{60}{N_p \cdot m \cdot T_c} [RPM] \quad (3)$$

where  $T_c$  is period of period of the clock and  $m$  is number of clock pulses. The speed accuracy with this method is acceptable at low speed region. However, the speed measurement time is not constant as in M method and varies according to the speed. Therefore measurement speed may have large time delay while speed control loop is executed at a constant frequency. As a result, this situation decreases the speed control performance.

### 3.3. Frequency and Time Measurement (M/T-method)

M/T method is a widely used in the industry and it is combined of M and T speed measurement methods [3 and 4]. The speed can be measured accurately at both high and low speed range. The speed is measured by counting the number of encoder pulses observed in the  $T_{sp}$  sampling period, within the measurement the time interval  $T_D$  which is synchronized to pulse right after  $T_{sp}$  as shown in Figure 5.

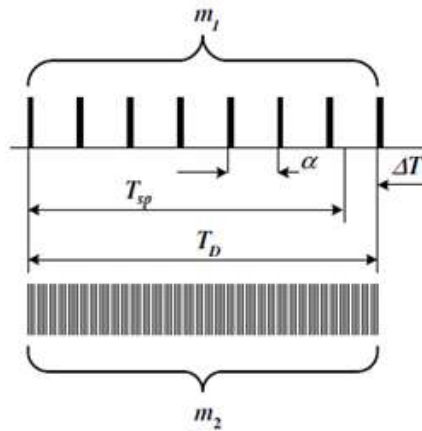

Figure 5. M/T method

The speed measurement equation by M/T method is described as

$$N_{M/T} = \frac{m_1 \alpha}{P_{PR}(T_{sp} + \Delta T)} = \frac{60 f_c m_1}{m_2 P_{PR}} (r/min) \quad (4)$$

where  $f_c$  is clock frequency,  $m_1$  number of encoder pulses in  $T_d$  time interval and  $m_2$  is number of clock pulses.

## 4. EXPERIMENTAL METHOD

Figure 6 shows the experimental setup in this study. Two motors were coupled to each other in the setup. On one side of the setup, Delta's ECMA series motor and ASDA-A2 series driver are assembled, which is also highly preferred for industrial applications with high speed sensitivity and high resolution. On the other side, the SMB brand PMSM and driver have been used [8].



Figure 6. Experimental setup

Table 1 shows some parameters of the ASDA-A2 driver. When the ASDA-A2 drive is examined, it appears that it has a high encoder resolution of 20-bit and high speed accuracy.

Table 1. ASDA-A2 driver parameters

Power	1.5 kW
Supply Voltage	220 VAC
Output Current	8.3A
Encoder Resolution	20-bit (1280000 PPR)
Speed Control Range	1:5000 rpm
Speed Bandwidth	Maximum 1kHz
Speed Accuracy	0.01%

SMB motor driver which is shown in Figure 7 includes TMS320x28xxx digital signal processor. The TMS320x28xxx is a high-performance DSP with a maximum operating frequency of 90MHz which is designed for motor control applications.



Figure 7. SMB motor driver

The TMS320x28xxx DSP includes the enhanced quadrature encoder pulse (eQEP) module and it is used for incremental encoder to get position, direction and speed information from the motor. The eQEP peripheral contains mainly Quadrature decoder unit (QDU), Position counter and control unit for position measurement (PCCU), Quadrature edge capture unit (QCAP) and Unit time base (UTIME). M method is implemented by using position counter with Unit time-out event for high speed calculation; T method is implemented with edge capture unit to measure the elapsed time between two adjacent encoder pulses. Finally M/T method is realized with both unit time-out (UTIME) and

edge capture unit. In the experiment, the ASDA-A2 driver with high speed accuracy was used to run the system at different speeds and the results of the speed measurement techniques were taken from encoder pulses coming to the DSP thanks to the SMB motor assembled in the experimental setup. Sample period of speed is 1ms for M and M/T method. 2048 PPR low-resolution encoder is chosen for test and if both edges of both pulse trains (A and B pulse) are used, PPR can be quadrupled. The Matlab/Simulink model for speed measurement is shown in Figure 8. Speed calculation is carried out with Matlab function for M method, T method and M/T method

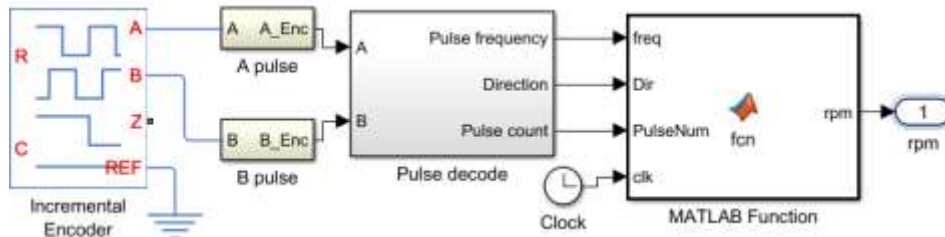

Figure 8. Matlab/Simulink Model

### 5. RESULT AND DISCUSSION

Speed measurement results were obtained at speeds of 10 rpm and 1000 rpm of the M, T and M/T speed measurement methods in the experimental setup and Matlab/Simulink. The speed measurement test and simulation results for 10 rpm speed are given in Fig. 9 for the M method, Fig. 10 for the T method and Fig. 11 for the M/T method. When the motor speed was calculated by the M method for a speed of 10 rpm, 7.392 rpm speed measurement error was observed for 1 ms sampling time and 8192 ppr(4\*2048) in the experiment and simulation. It has been found that the measured speed in the M method has an oscillation between 7.32 and 14.68 rpm. In the T and M / T methods, when the speed measurement results for 10 rpm are examined, the speed measurement errors are below 1 rpm and acceptable.

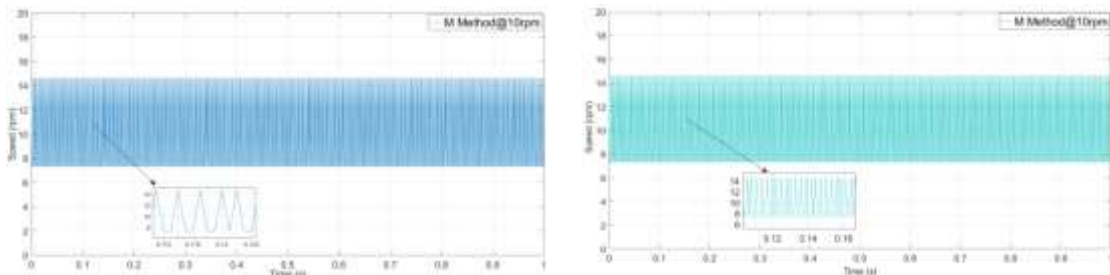

Figure 9. M method results @10rpm a) experimental b) simulation

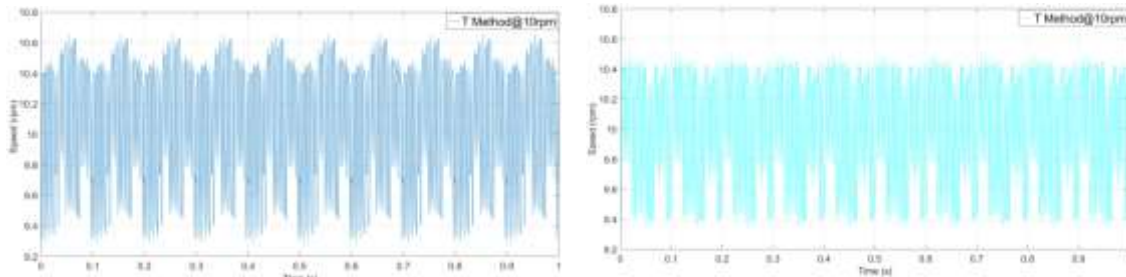

Figure 10. T method results @10rpm a) experimental b) simulation



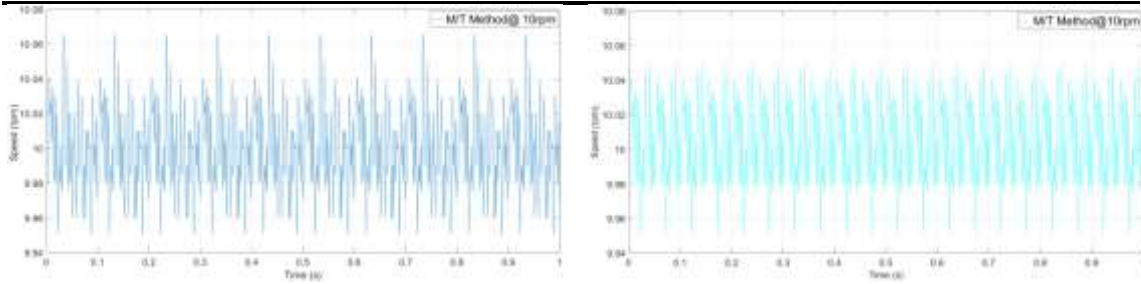

Figure 11. M/T method results @10rpm a) experimental b) simulation

For the speed measurement results at 1000 rpm speed, it has been observed that there was still a constant speed measurement error of 7.32 rpm in the M method and oscillation was performed at 996-1003 rpm. However, this speed measurement error appears to be 1% of 1000 rpm. In the T method, the speed measurement deteriorated and performed an oscillation between 950 and 1050 rpm. For the M/T method, it is observed that the oscillation in the speed measurement is below 1 rpm.

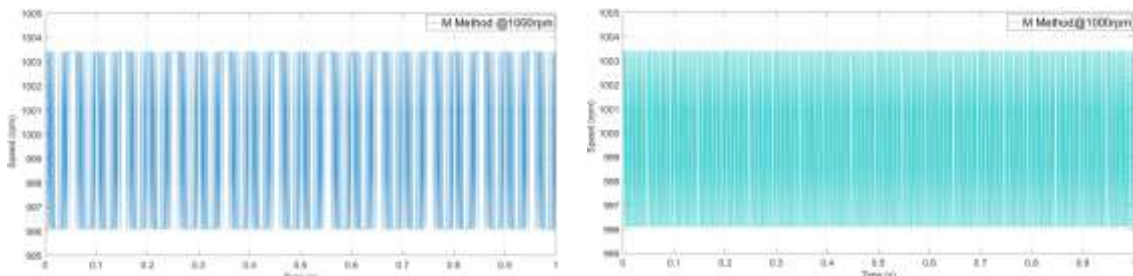

Figure 12. M method results @1000rpm a)experimental b)simulation

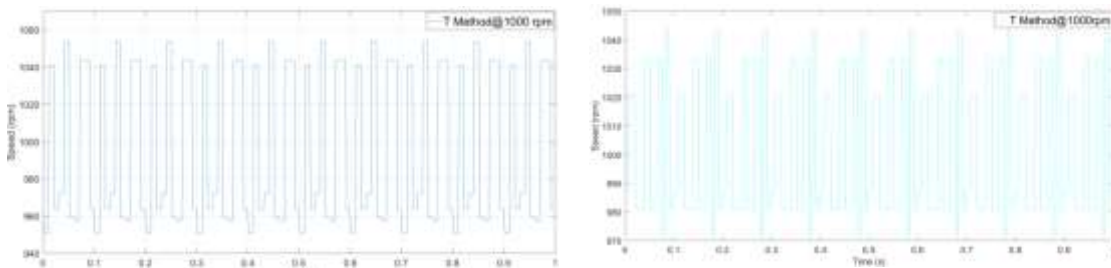

Figure 13. T method results @1000rpm a) experimental b) simulation

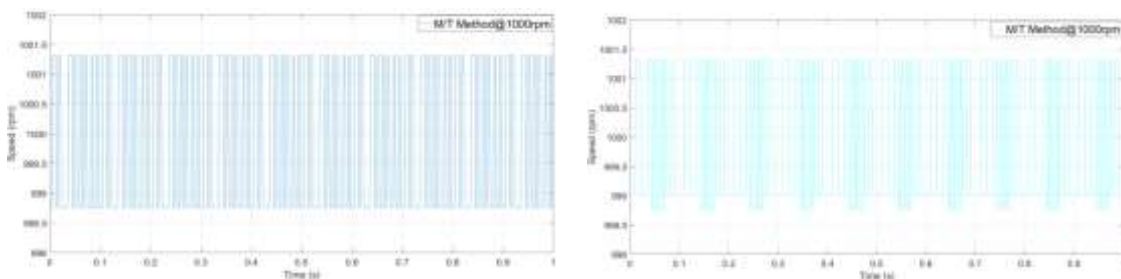

Figure 14. M/T method results @1000rpm a) experimental b) simulation

## 6. CONCLUSION AND RECOMMENDATIONS

In this paper, the speed measurement techniques in the speed control of the permanent magnet synchronous motor were investigated as experimental and simulation. Experimental and simulation results are obtained in TMS320x28xxx DSP and Matlab/Simulink respectively. M method, T method and M/T speed measurement methods with low resolution



incremental encoder have been realized and compared for different speeds. It has been observed that in this comparison, M method has an accurate speed measurement for high speed; T method has an accurate speed measurement for low speed; and M/T method has successfully performed in speed measurement at high precision and accuracy at low and high speed. In the next study, the effects on speed measurement will be examined by using different filtering methods used in speed measurement methods.

#### **NOTICE**

This work is presented at 05-08 September 2017, 2<sup>nd</sup> International Science Symposium (ISS2017) in Tbilisi-Georgia.

#### **REFERENCES**

1. Kennel, R.M., (2006). Why Do Incremental Encoders Do a Reasonably Good Job in Electrical Drives with Digital Control?. Conference Record of the 2006 IEEE Industry Applications Conference Forty-First IAS Annual Meeting, Tampa, FL, pp:925-930.
2. Briz, F., Cancelas, J.A., and A. Diez, A., (2006). Speed Measurement Using Rotary Encoders for High Performance AC Drives. *Industrial Electronics, Control and Instrumentation*, 1994. IECON '94., 20<sup>th</sup> International Conference on, Bologna, Cilt:1, pp:538-542.
3. Seung-Ki, S., (2011). *Control of Electric Machine Drive Systems*, Wiley-IEEE Press.
4. Ohmae, T. Matsuda, T., Kamiyama, K., and Tachikawa, M., (1982). A Microprocessor-Controlled High-Accuracy Wide-Range Speed Regulator for Motor Drives, in *IEEE Transactions on Industrial Electronics*, Cilt:IE-29, No:3, pp:207-211.
5. Belanger, P.R., (1992). Estimation of Angular Velocity and Acceleration from Shaft Encoder Measurements, *Proceedings 1992 IEEE International Conference on Robotics and Automation*, Nic, pp:585-592, vol:1.
6. Fujita, K. and Sado, K., (1990). Instantaneous speed detection with parameter identification for AC servo systems, *Conference Record of the 1990 IEEE Industry Applications Society Annual Meeting*, Seattle, WA, USA, pp:632-638, vol:1.
7. Petrella, R., Tursini, M., Peretti, L., and Zigliotto, M., (2007). Speed Measurement Algorithms for Low-Resolution Incremental Encoder Equipped Drives: a Comparative Analysis, *2007 International Aegean Conference on Electrical Machines and Power Electronics*, Bodrum, pp:780-787.
8. <http://www.smb-technics.com/tr/>