

# Turkish Journal of Engineering



*Turkish Journal of Engineering (TUJE)*  
*Vol. 3, Issue 4, pp. 206-217, October 2019*  
*ISSN 2587-1366, Turkey*  
*DOI: 10.31127/tuje.554075*  
*Research Article*

## **FLEXURAL BEHAVIOR OF HYBRID FRP-CONCRETE BRIDGE DECKS**

İlker Fatih Kara <sup>1</sup>, Ashraf F. Ashour <sup>2</sup> and Cahit Bilim <sup>\*3</sup>

<sup>1</sup> Mersin University, Engineering Faculty, Civil Engineering Department, Mersin, Turkey  
ORCID ID 0000-0002-5663-1595  
ifkara@mersin.edu.tr

<sup>2</sup> University of Bradford, School of Engineering, Department of Structural Engineering, Bradford, UK  
ORCID ID 0000-0002-4800-6060  
A.F.Ashour@Bradford.ac.uk

<sup>3</sup> Mersin University, Engineering Faculty, Civil Engineering Department, Mersin, Turkey  
ORCID ID 0000-0002-0975-1391  
cbilim@mersin.edu.tr

---

\*Corresponding Author

Received: 15/04/2019      Accepted: 23/07/2019

---

### **ABSTRACT**

The main aim of this study is to investigate the behaviour of hybrid FRP-concrete decks. The hybrid FRP-concrete bridge systems consisting of different FRP cell units available on the market such as trapezoidal, triangular, honeycomb, rectangular with alternating diagonal, half-depth trapezoidal, hexagonal and arch cell units were computationally compared and examined using the finite element (FE) analysis to decide the most appropriate FRP composite deck for bridge systems. Design criteria such as the deflections were considered in selecting the most effective unit system. Different FRP bridge deck panels were analysed under static loading representing the standard European truck wheel. The finite element analysis of bridge deck systems was performed using a general purpose finite element analysis package ABAQUS, and the behaviour of these systems was then be compared in terms of stiffness and strength criteria. The results showed that Delta, Super and ASSET hybrid decks are stiffer than other deck systems. The results from FEA approach also indicated that the layer of concrete on the top surface of bridge deck reduces the vertical displacement of FRP bridge systems approximately 60%.

**Keywords:** *FRP Composites; Concrete; Bridge Decks; Hybrid Design; Finite element analysis*

## 1. INTRODUCTION

It is well known that bridges deteriorate with age. For example, reinforced concrete bridges slowly deteriorate during the first few decades of their design life (typically 50 years), followed by a rapid decline thereafter. In many North European countries, deterioration, caused by de-icing salts, is creating an increasing maintenance workload due to their corrosive effect on steel reinforcement of concrete bridges. A 2002 Federal Highway Administration and United States Department of Transportation (FHWA/USDOT) (2002) study estimates the direct cost of repairing corrosion on highway bridges to be \$8.3 billion annually, including \$3.8 billion over the next 10 years to replace structurally deficient bridges and \$2.0 billion for maintenance of concrete bridge decks. Longer design life structures, using the latest materials and design technologies, are needed to maintain a functional transportation network, provide longer service life, and improve the safety of the highway network. Among new construction materials, fiber reinforced polymers (FRP) composites are very attractive materials to structural engineers, due to their superior material properties such as high stiffness, high strength, high corrosion resistance, light weight, and durability.

Bridge decks have been considered as the most critical component in bridges that could significantly benefit from the appropriate use of FRP composite materials. FRP bridge decks have many advantages including light weight, corrosion resistance, quick installation, high strength and low life cycle maintenance cost (Hollaway, 2010; Bakis *et al.*, 2002; Keller, 2002). FRP bridge decks are approximately weigh 20% of the structurally equivalent reinforced concrete decks, that can produce massive savings throughout the bridge, in particular bridge foundations. The modular form of FRP bridge decks offers several benefits including minimum traffic disruption, safer and cheaper installation. In spite of all these advantages, large displacement can occur under concentrated point loads in FRP bridge decks. It has been reported that the local deformation under concentrated point loads resulting from vehicle wheels is large for all FRP composite bridge decks due to the relatively low stiffness of FRP composites. Therefore, a thin layer of concrete on top of the FRP bridge deck enhances the overall stiffness of the deck, reduces the local deformation of the deck top flange and improve the overall serviceability of the wearing surface. In addition, FRP deck can act as a permanent formwork to cast the concrete layer. Sebastian *et al.* (2013) showed that a 30mm thick layer of polymer concrete surfacing significantly improved the load carrying capacity of glass fiber reinforced polymer (GFRP) bridge deck by 261% in comparison to the un-surfaced GFRP deck. However, this increase was only 90% when the plan dimensions of the applied load were increased.

Davalos *et al.* (2001) presented a combined analytical and experimental characterization of FRP honeycomb deck panels. The authors concluded that the equivalent orthotropic properties developed in their

study could be used for the analysis and design of the FRP sandwich panels.

Keller and Gurtler (2006) tested Duraspan and Asset FRP decks. In-plane compression and in-plane shear tests were carried out on panels made of three adhesively bonded components with all bending test. The failure mode of ASSET deck was brittle and linear elastic up to failure, while Duraspan deck exhibited some ductility.





Saiidi *et al.* (1994) carried out an experimental and analytical study of hybrid beams that consist of graphite/epoxy (G/E) sections and reinforced concrete (RC) slabs. They concluded that the use of epoxy resin to bond concrete to G/E sections was found to be only partially effective. Kitane *et al.* (2004) developed a basic concept of a hybrid FRP-concrete bridge superstructure. The structural type was a trapezoidal box sections. A thin layer of concrete was placed in the compressive zone of the section, and was surrounded with GFRP. They concluded that concrete bridge superstructure is very promising, from structural engineering view point.

The main aim this study is to investigate the behaviour of hybrid FRP-concrete decks. The hybrid FRP-concrete bridge systems consisting of different FRP cell units available on the market such as trapezoidal, triangular, honeycomb, rectangular with alternating diagonal, half-depth trapezoidal, hexagonal and arch cell units were computationally compared and examined using the finite element (FE) analysis to decide the most appropriate FRP composite deck for bridge systems. Design criteria such as the deflections were considered in selecting the most effective unit system. Different FRP bridge deck panels were analysed under static loading representing the standard European truck wheel. The finite element analysis of bridge deck systems was performed using a general purpose finite element analysis package ABAQUS (Hibbit, Karlsson & Sorensen, Inc., 2006), and the behaviour of these systems was then be compared in terms of stiffness and strength criteria.

## 2. ANALYSIS OF FRP DECK SYSTEMS

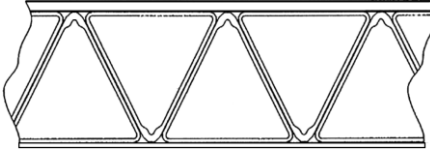
There are many different types of FRP deck solutions available on the market, each one having different geometric and physical properties and suitable for different uses. Table 1 shows seven typical bridge decks types, each from a different manufacturer. These FRP bridge decks were considered and a thin layer of concrete was placed on the top surface of the FRP deck for the formation of the hybrid deck systems (see Fig. 1 (a-b)) for EZ span deck). The interface between the concrete and the FRP plate was assumed perfectly bonded. All the hybrid decks were analysed and compared using the finite element (FE) analysis to decide the most appropriate two FRP composite decks for bridge systems. Design criteria such as the global deflection was considered in selecting the most effective two system. Different FRP bridge deck panels were analysed under static loading representing the standard European truck wheel.

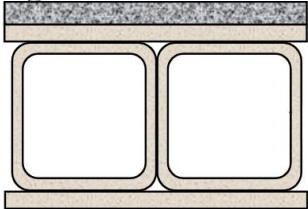
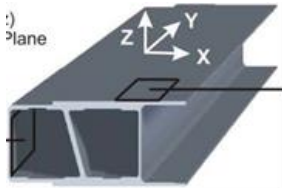
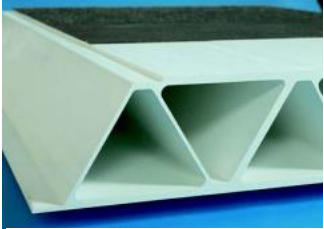
Table 1. FRP deck types and properties (Brown and Zureick (2001))

Deck System	Deck Thickness (mm)	Deck Weight (kN/m <sup>2</sup> )	Manufacturer	Illustration of the Deck
EZ Span Deck	216	0.96	Creative Pultrusion Inc. USA	
Superdeck	203	1,01	Creative Pultrusion Inc. USA	
Strongwell	170	1.08	Strongwell, USA	
DuraSpan	195	0.95	Martin Marietta Composites, USA	
Asset	225	0.93	Fiberline, Denmark	
Delta Deck	200	1.76	Korea	
Holes Deck	216	0.9	Spare Composites Corp. at Nanjing, China	

To evaluate these systems, a bridge superstructure was designed as a simply supported single span one-lane bridge with a length of 2.7 m as suggested by Keller and Schollmayer (2004) for serviceability states in designing process. As all decks have different geometry, the width of the bridge deck systems varies between 950 mm to 1200 mm. The concrete layers reduces the local deformation of the top surface of the bridge under concentrated loads that represent truck wheel loads

(Alnahhal *et al.* (2007)). The thickness of the concrete layer is a key design parameter to optimize the hybrid structural system. According to Kitane (2004), concrete can be used efficiently to increase the flexural rigidity until the concrete thickness equals about 10% of the bridge depth. Therefore, as the depth of the decks changes between 195 and 216 mm, the same concrete thickness of 2 cm was selected for all hybrid FRP deck systems.

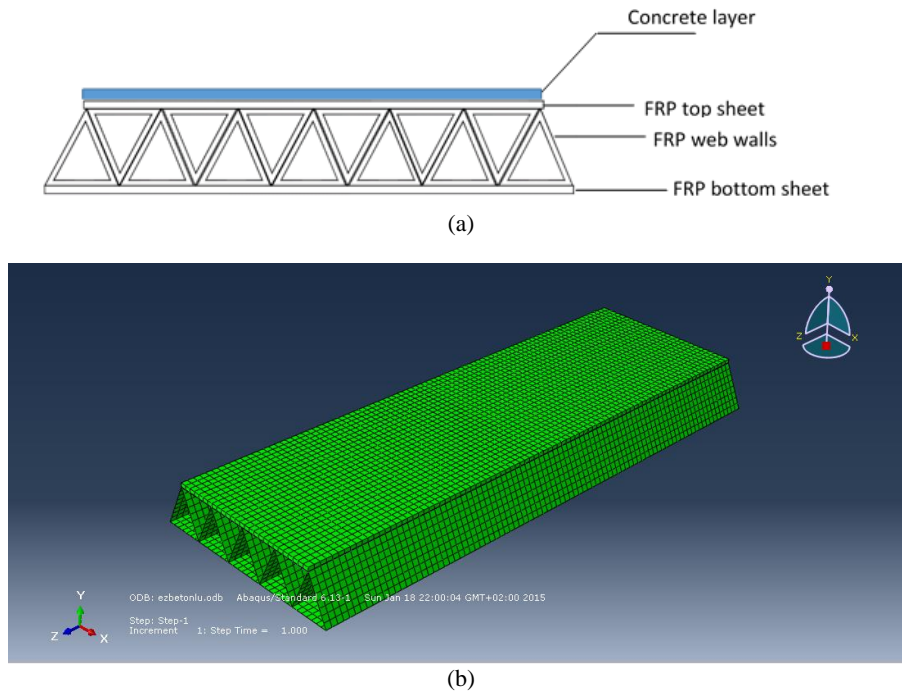

Fig. 1 (a-b) Section and finite element modelling of EZ Span hybrid bridge deck

Road traffic loads according to the European Code EC1(2002) were used. Figure 2 shows a patch load used in the structural analysis of the deck panel. The wheel load, as specified in, was uniformly distributed pressure load over a tyre-contacting area of 0.4 m x 0.4 m.

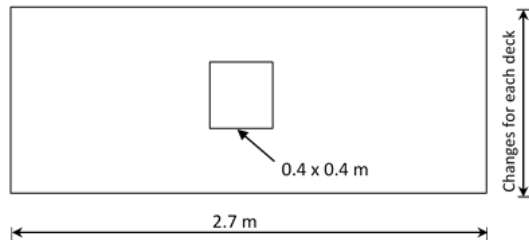

Fig. 2. Patch load used in the structural analysis of the hybrid deck panel

The finite element calculations of the bridge decks were carried out using ABAQUS (Hibbit, Karlsson& Sorensen, Inc., 2006). The FRP decking systems are modelled with 3D deformable shell elements (4 nodes). Orthotropic material properties are utilized with the mechanical characteristics as given in Table 2. 4 nodes shell elements are used due to the more detailed implicit hollow configuration. The steel loading plate is modelled using 3D deformable solid elements (8 nodes). For the steel members a Young's modulus of 220 GPa and a Poisson's ratio of 0.3 was utilized. The concrete compressive strength were assumed to be 40 MPa for all hybrid deck systems in this study. The behavior of hybrid bridge deck can be predicted by assuming the linear FEA if the strain induced in the materials is within the strain range where the elastic moduli of the materials were computed.

Table 2. Mechanical properties of deck specimens

Deck System	Top Sheet								
	$E_x$ (Mpa)	$E_y$ (Mpa)	$E_z$ (Mpa)	$G_x$ (Mpa)	$G_y$ (Mpa)	$G_z$ (Mpa)	$\rho_x$	$\rho_y$	$\rho_z$
Asset	23000	18000		2600	600	600	0.3	0.3	
DuraSpan	21240	11790	4140	5580	600	600	0.32	0.3	0.3
EZ Span Deck	31000	8300		4000			0.25		
Delta Deck	16600	13200							
Superdeck	24100			3400					
Strongwell	13790	9652							
Holes deck	31000	5000	5000	6000	6000	5000	0.2	0.2	0.3

	Web								
Deck System	E <sub>x</sub> (Mpa)	E <sub>y</sub> (Mpa)	E <sub>z</sub> (Mpa)	G <sub>x</sub> (Mpa)	G <sub>y</sub> (Mpa)	G <sub>z</sub> (Mpa)	ρ <sub>x</sub>	ρ <sub>y</sub>	ρ <sub>z</sub>
Asset	17300	22700		3150	600	600	0.3	0.3	
DuraSpan	17380	9650	4140	7170	600	600	0.3	0.3	0.3
EZ Span Deck	8300	31000			4000			0.3	
Delta Deck	28800	10100							
Superdeck		24100			3400				
Strongwell	11000	5516							
Holes deck	31000	5000	5000	6000	6000	5000	0.2	0.3	0.2
	Bottom Sheet								
Deck System	E <sub>x</sub> (Mpa)	E <sub>y</sub> (Mpa)	E <sub>z</sub> (Mpa)	G <sub>x</sub> (Mpa)	G <sub>y</sub> (Mpa)	G <sub>z</sub> (Mpa)	ρ <sub>x</sub>	ρ <sub>y</sub>	ρ <sub>z</sub>
Asset	16500	25600		2000	600	600	0.3	0.3	
DuraSpan	21240	11790	4140	5580	600	600	0.32	0.3	0.3
EZ Span Deck	31000	8300		4000			0.25		
Delta Deck	16600	13200							
Superdeck	24100			3400					
Strongwell	13790	9652							
Holes deck	31000	5000	5000	6000	6000	5000	0.2	0.2	0.3

### 3. RESEARCH RESULTS

The load combination specified in the European Code EC1 (2002) for the serviceability and ultimate limit state was applied to all hybrid bridge systems. The maximum midspan vertical displacements for serviceability limit state (SLS) are presented in Table 3. The deflected shape and displacement result of finite element method for all concrete decks considered here are shown in Fig. 3. The variation of longitudinal deflections is also obtained for all deck systems. Fig. 4 presents the comparison of these deflections for hybrid deck systems. It can be seen from Fig. 4 and Table 3, the

displacements in Delta, ASSET and Super hybrid FRP-concrete decks are smaller than the other deck systems. These three hybrid decks have also smaller deflection than the deflection limit of L/300 (9 mm) suggested by Keller and Schollmayer (2004). All the deck systems were also analyzed without placing of concrete on the top surface. The variation of midspan section displacement in longitudinal direction for hybrid and non-hybrid specimens are given in Figs. 5. As seen in Figs. and Table 3, the placement of thick layer concrete on the top surface reduces the maximum displacement of FRP bridge decks approximately 60%.

Table 3. Maximum vertical displacement in SLS

		Maximum Vertical Displacement (mm)	
		Hybrid FRP Concrete Deck	FRP Deck
FRP Deck Systems	DuraSpan	10.14	16.47
	Asset Deck	8.162	11.83
	Superdeck	8.58	13.05
	EZ Span Deck	12.16	16.39
	Strongwell	13.61	23.29
	Delta Deck	5.81	10.0
	Holes deck	9.76	18.18

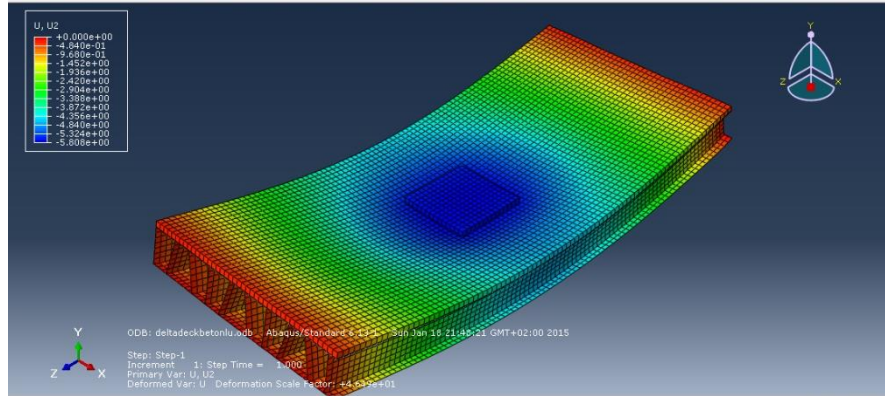

(a) Delta Hybrid FRP Concrete Deck

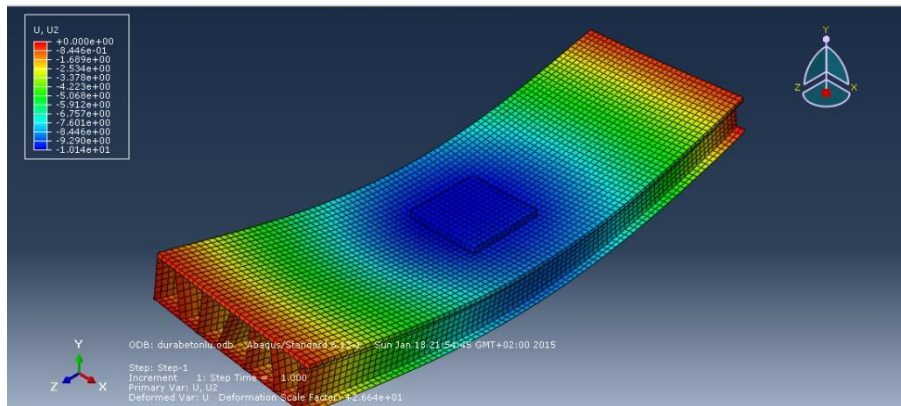

(b) Dura Span Hybrid FRP Concrete Deck

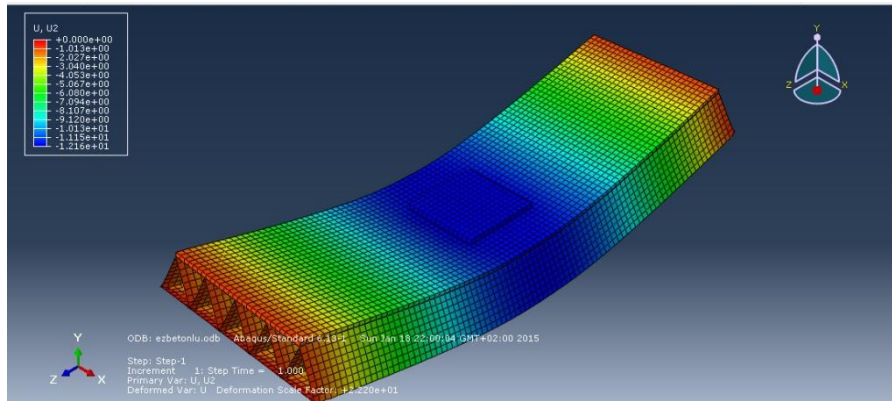

(c) EZ Span Hybrid FRP Concrete Deck

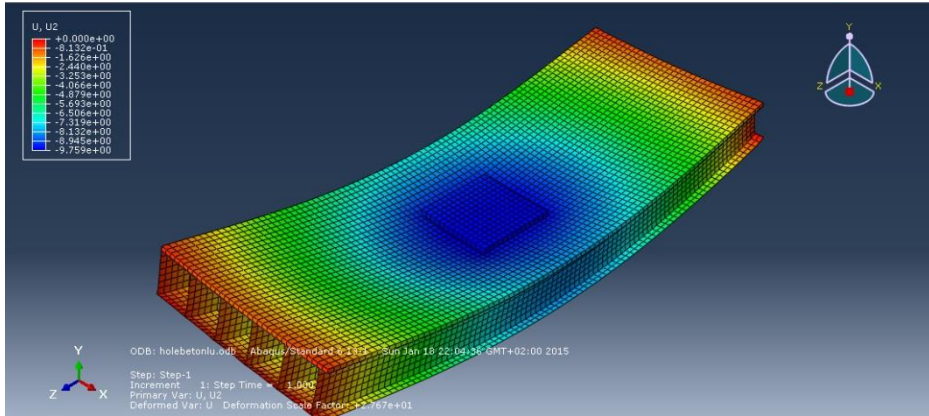

(d) Holes Hybrid FRP Concrete Deck

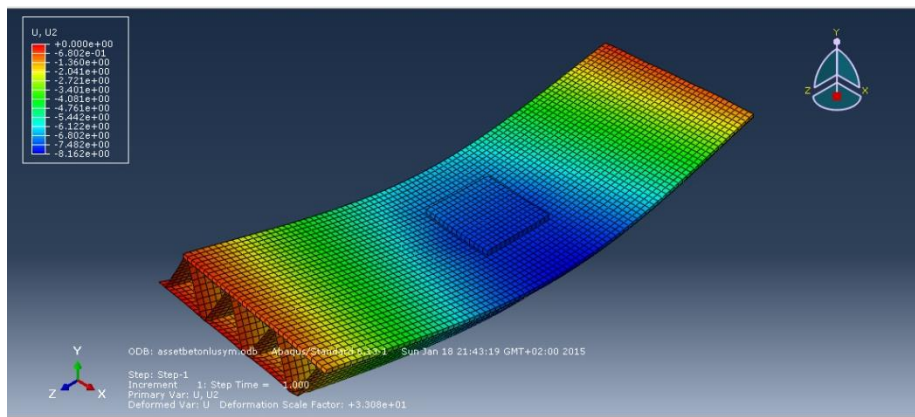

(e) Asset Hybrid FRP Concrete Deck

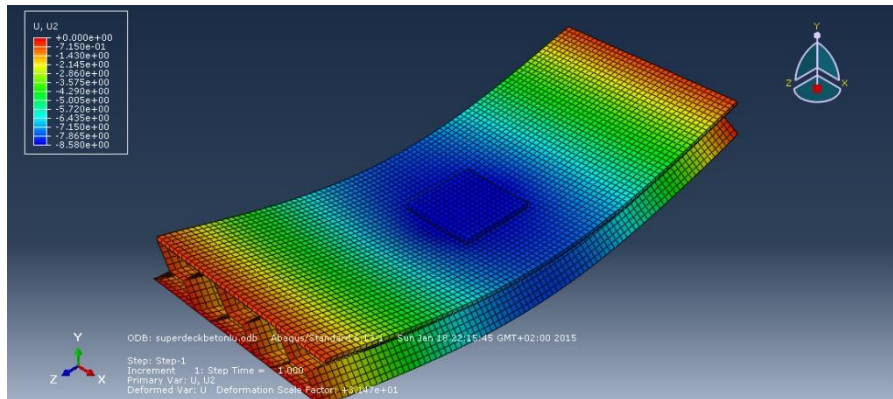

(f) Super Hybrid FRP Concrete Deck

Fig. 3 (a-f) Deflected shape and deflection results of hybrid FRP-concrete decks

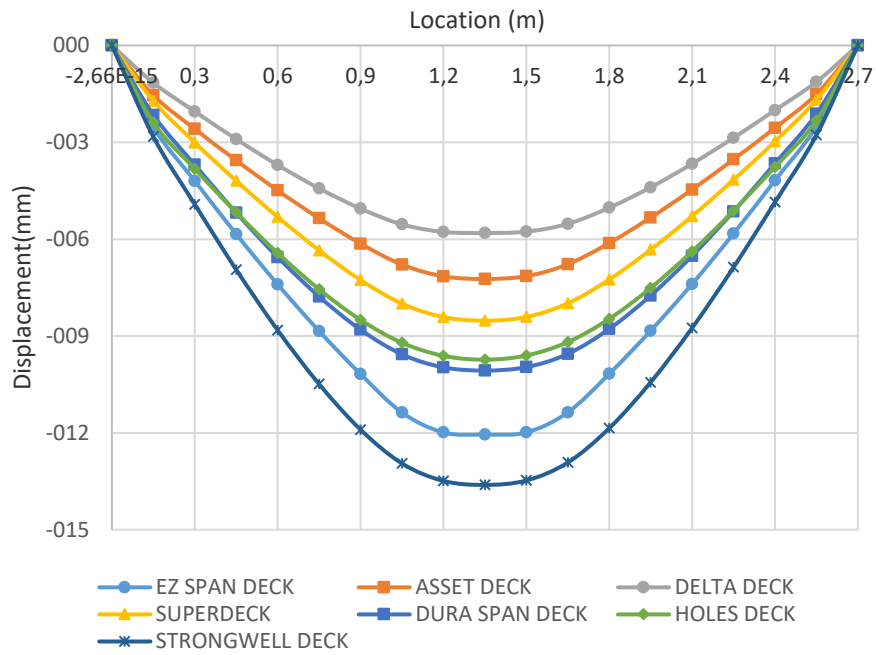
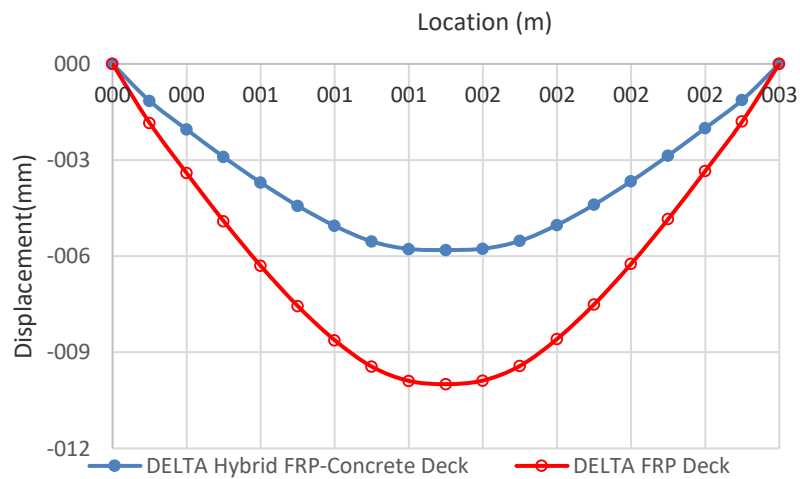
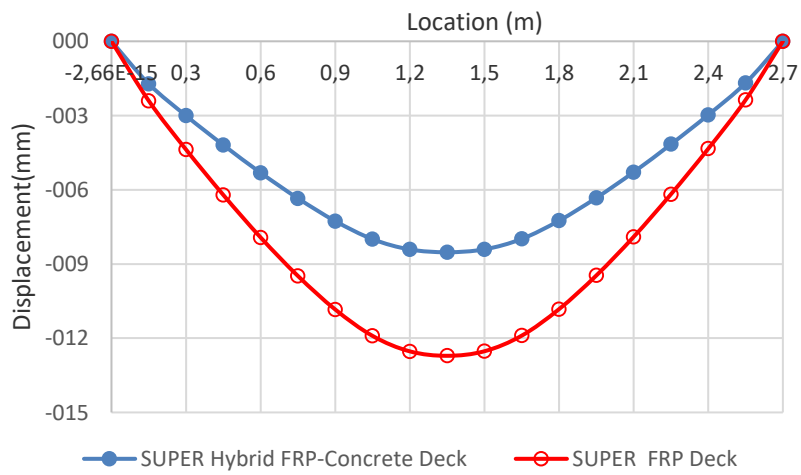

Fig. 4 Comparison of longitudinal maximum displacement of hybrid FRP-concrete decks



(a) Delta Deck





(b) Super Deck

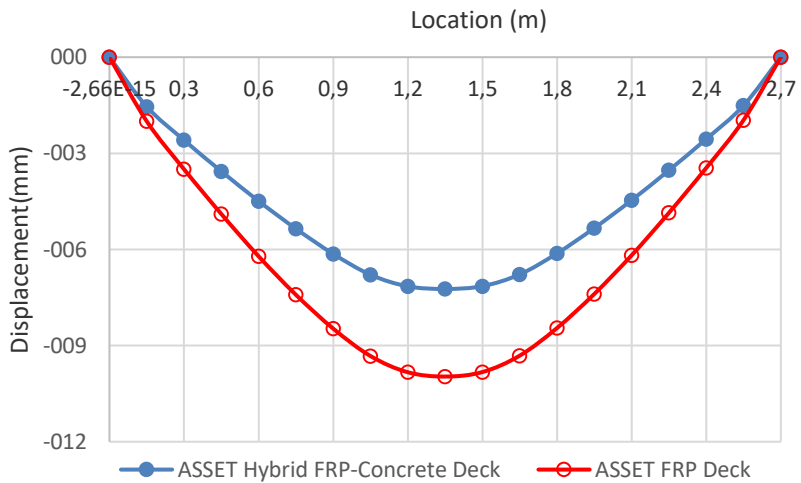

(c) Asset Deck

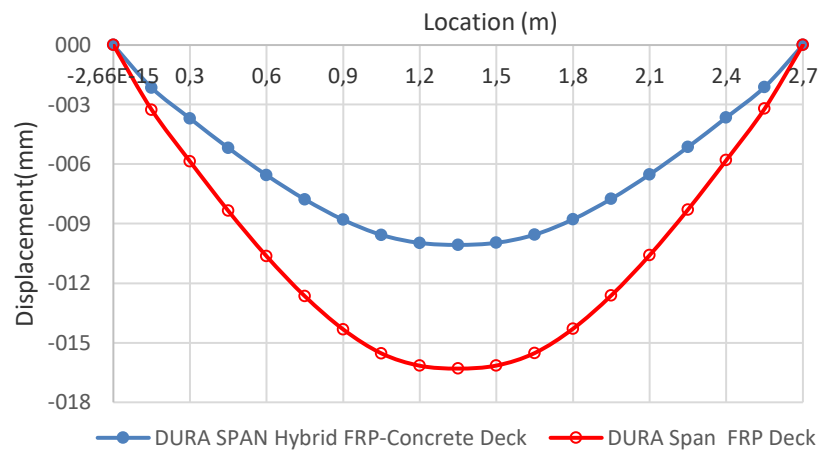

(d) Dura Span Deck

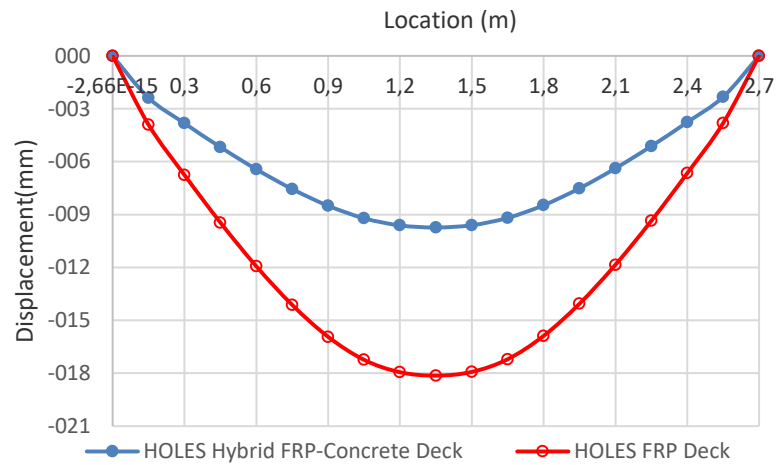

(e) Holes Deck

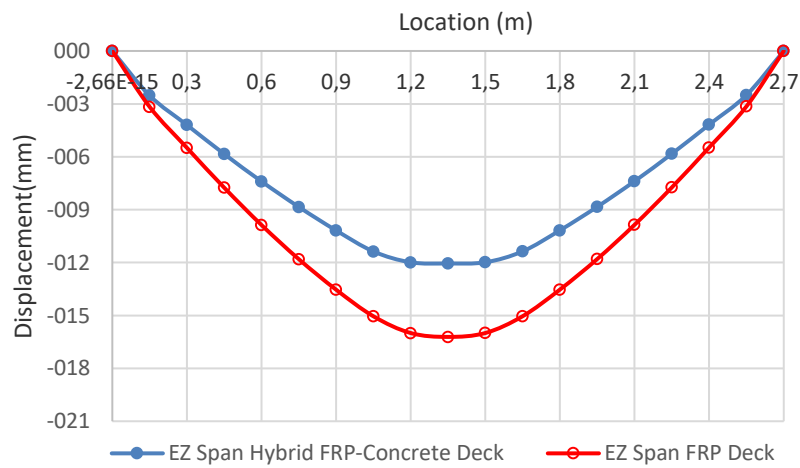

(f) EZ Span Deck

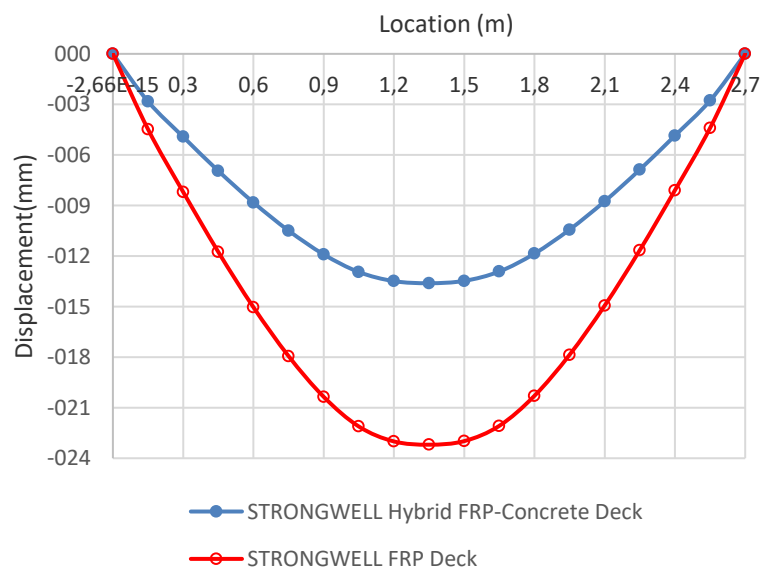

(g) Strongwell Deck

Fig. 5 (a-g) Comparison of longitudinal displacement of hybrid and non-hybrid FRP decks

Table 4 shows the maximum concrete compressive stress as well as tensile stresses in concrete element of hybrid deck systems. As seen in Table 4, the compressive stresses in concrete elements were all smaller than its compressive strength limit ( $0.85 \cdot f_c$ ) in all bridge systems, which is located at the top of the concrete under the load area. The maximum compressive stress in Delta, Asset and Super decks are smaller than the other hybrid deck systems. On the other hand the maximum tensile stresses ( $f_t$ ) exceeds the tensile strength of concrete for the decks systems except that EZ span hybrid deck. As expected the maximum tensile strength occurs at the bottom of the concrete layer in all bridge decks.

Table 4. Maximum concrete stress in SLS

		Maximum Concrete Stress	
		Compressive Stress (MPa)	Tensile Stress (MPa)
FRP Deck Systems	DuraSpan	22.22	7.26
	Asset Deck	20.94	5.20
	Superdeck	21.16	4.99
	EZ Span Deck	22.37	1.47
	Strongwell	27.17	10.28
	Delta Deck	13.07	4.94
	Holes deck	22.14	6.22

The load combination for the ultimate state was also applied to all the bridge systems. The results of the maximum vertical displacement is presented in Table 5. As seen in Table 5, the displacements in Delta, ASSET and Super hybrid FRP-concrete decks are smaller than the other deck systems as in the case of the SLS. The similar results for the variation of deflections, and also the maximum longitudinal stress in FRP decks were also obtained with that of SLS.

Table 5. Maximum vertical displacement for ultimate limit state (ULS)

		Maximum Vertical Displacement (mm)	
		Hybrid FRP Concrete Deck	FRP Deck
FRP Deck Systems	DuraSpan	13.68	22.24
	ASET Deck	11.02	15.98
	Superdeck	11.58	17.61
	EZ Span Deck	16.42	22.13
	Strongwell	18.38	31.44
	Delta Deck	7.841	13.51
	Holes deck	13.17	24.55

#### 4. CONCLUSION

Different hybrid FRP-concrete bridge decks were investigated numerically by using finite element (FE) analysis. A simplified FEM approach, which uses a single layer of thick shell elements to simulate a FRP deck, that has top and bottom face sheets and web, was proposed. The structural performance of the hybrid deck panels were compared with that of the non-hybrid deck

panels. The comparisons among these bridge systems were also carried out to select the most efficient two decks. The results showed that Delta, Super and ASSET hybrid decks are stiffer than other deck systems. The results from FEA approach also indicated that the layer of concrete on the top surface of bridge deck reduces the vertical displacement of FRP bridge systems approximately 60%. The FEA results also show that Delta, ASSET and Super hybrid decks were more efficient than other FRP decks considered here.

#### REFERENCES

Federal Highway Administration and United States Department of Transportation (FHWA/USDOT). (2002). "Corrosion costs and preventative strategies in the United States." A Supplement to Materials Performance (MP), NACE International, Houston.

Hollaway, L. C. (2010), "A review of the present and future utilisation of FRP composites in the civil infrastructure with reference to their important in-service properties", Construction and Building Materials, Vol. 24, pp. 2419–2445.

Bakis C.E., Bank L.C., Brown V.L., Cosenza E., Davalos J.F., Lesko J.J. (2002), "Fiber-reinforced polymer composites for construction-state-of-art review", J. Compos. Construct., ASCE;6(2):73–87.

Keller, T. (2002), "Overview of Fibre-Reinforced Polymers in Bridge Construction", In: Structural Engineering International, May, No. 2, p. 66–70.

Alnahhal W., Aref A., Alampalli S. (2007), "Composite behavior of hybrid FRP-concrete bridge deck on steel girders", Compos. Struct., 84, 29-43.

Kitane, Y. and Aref, A. (2004), "Static and fatigue testing of hybrid fiber-reinforced polymer-concrete bridge superstructure", J. Compos. for Const., 8(2),182-190.

Sebastian, W.M., Keller, T. and Ross, J. (2013) "Influences of polymer concrete surfacing and localised load distribution on behaviour up to failure of an orthotropic FRP bridge deck," Composites: Part B, Vol. 45, pp. 1234–1250.

Brown RT, Zureick AH. Lightweight composite truss section decking. Marine Struct 2001;14:115–32.

Davalos, J. F., Qiao, P., Xu, X. F., Robinson, J., and Barth, K. E. (2001). "Modeling and characterization of fiber-reinforced plastic honeycomb sandwich panels for highway bridge applications." Composite Structures, 52(3-4), 441-452.

Keller T. and Schollmayer M., Plate bending behavior of a pultruded GFRP bridge deck system, Composite Structures 64, 285–295, 2004.

Keller T, Gürtler H. 2006. In-plane compression and shear performance of FRP bridge decks acting as top chord of bridge girders. Compos. Struct. ;72(2):151–62.

Saiidi, M., Gordaninejad, F., and Wehbe, N. (1994), "Behavior of Graphite/Epoxy Concrete Composite Beams", *Journal of Structural Engineering*, Vol. 120, No. 10, pp. 2958-2976.

European Committee for Standardization (CEN): Eurocode 1— Actions on Structures, part 2: traffic loads on bridges. Pr EN 1991-2, 2002.

Hibbit, Karlsson& Sorensen, Inc. (2006), *ABAQUS/Standard User's Manual*, Version 6.6, Hibbit, Karlsson& Sorensen, Inc.