



## NATURAL VENTILATION PERFORMANCE OF RESIDENTIAL URBAN AREAS AT PEDESTRIAN LEVEL: COMPARISON OF OLD AND NEW SETTLEMENTS

Ayça Gülten<sup>1</sup>

<sup>1</sup>Department of Architecture, Faculty of Architecture, Firat University, Turkey

Original Scientific Paper

This study evaluates the natural ventilation performance of different urban areas in Elazığ, Turkey based on a parameter called “spatially averaged- wind velocity ratio”. The Computational Fluid Dynamics (CFD) 3-D steady-state simulations were made for old and newly built urban areas in Elazığ. Wind velocities of 3 and 5 m/s with NW prevailing wind direction were used in the simulations. Spatially-averaged wind velocity ratio (VRW) considering 20 m and 30 m building heights were used in the study as governing parameters. It is found that, there is remarkable difference between natural ventilation performance of configurations assessed for old and new settlements. Narrow streets in old settlements could not be ventilated effectively while the streets in new settlements have a better wind distribution and ventilation potential.

**Keywords:** Natural ventilation, urban areas, CFD, wind velocity ratio

### 1 Introduction

The urbanization character of a city directly affects the ventilation performance of urban areas. Uncontrolled urbanization also causes increase with energy consumption beside uncomfortable outdoor conditions for human being. In urban areas exposed to poor ventilation, the urban heat island effect is stronger with the effect of traffic pollutants and reduced green areas.

Urban building arrangement and street networks in an urban area could be defined as the main factors that affect the ventilation performance of a city [1]. Many studies on ventilation performance of urban areas used computational fluid dynamics simulations. Yuan and Ng [2] developed a practical application in order to predict the wind environment at pedestrian level in high rise urban areas of Hong-Kong. They aimed to find answer to the questions about input boundary conditions, simulation modelling, modelling verification, data collection and analysis. Du and Mak [3] developed a framework in order to improve the low wind velocity environment in high density cities. They performed Computational Fluid Dynamics (CFD) simulations for three different cases considering campus model with lift-up design, without lift-up design and with an opening in building Y. They found that proposed design framework could help in improve the low wind velocity environment at pedestrian level. He et al. [4] studied the effect of angular road patterns on pedestrian wind environment. They found that wind flow is affected by also relative orientation of adjacent road segments beside prevailing wind direction. Mirzaei and Haghighat [5] introduced a ventilation system

to improve the air quality at pedestrian level. They studied using computational fluid dynamics and on comfort parameters such as air temperature, wind velocity, air exchange rate. The results of simulations showed that physical ventilation system could improve the pedestrian level wind comfort.

Many of the studies that aimed to improve the wind environment in urban areas used indices to evaluate the performance of natural ventilation [6]. Spatially-averaged wind velocity ratio has become a remarkable parameter in recent years. Peng et al [7] used spatially-averaged wind velocity ratio as a natural ventilation indicator with air temperature. They compared the ventilation performance of different configured urban spaces by using CFD. Hu and Yoshie [8] also used spatially-averaged wind velocity ratio with CFD simulations. They evaluated natural ventilation of urban areas comparing a reference urban model that represents the residential region of Shanghai with configurations that have different building coverage ratios and building arrays and heights. Peng et al.[9], compared the ventilation performance of three high-rise residential areas in Jinan and emphasized the importance of avoiding matrix arrangement of buildings to provide a good ventilation. He et al. [10], evaluated urban breezeway networks over different morphological components. They proposed a linear regression analysis in order to predict the pedestrian wind velocities. Wise et al.[11], studied on the effect of small modifications to the inlet wind direction on CFD simulation results for seven different wind directions with 5° increasing angles from 205° to 235°.

\* Corresponding author.

E-mail address: aycagulten@gmail.com (A. Gülten) | ORCID Number : 0000-0001-9837-8674

Received 15 November 2019; Received in revised form 17 December 2019; Accepted 23 December 2019

2587-1943 | © 2019 IJIEA. All rights reserved.

In Turkey, evaluation of natural ventilation performance of urban areas have been ignored especially in the urban transformation process. On the other hand cities' uncontrollable growth adversely affects ventilation performance of urban districts beside causing an increase for cooling and heating loads. The main aim of this work is to evaluate the natural ventilation performance of a city, Elazığ, which is on east side of Turkey considering old and new settlements to be able to analyze the growing quality of city in terms of it's ventilation ability. Based on the literature survey and author' knowledge, this work is the first attempt in order to evaluate the natural ventilation performance of a city in Turkey by comparing old and new settlements' urbanisation characters. Thus, it is aimed

to lead a better urbanisation process for new settlements by concerning ventilation performance of old settlements.

## 2 Method

In this study, Elazığ's urban morphological characteristics have been classified with changing layouts for old and newly built settlements (Figure 1). Modelling process of urban morphological features have been established due to some assumptions determined for old and newly constructed urban areas. Old settlements present a layout with densely structured residential blocks while the new settlements stand seperately with a rectangular plan layout.

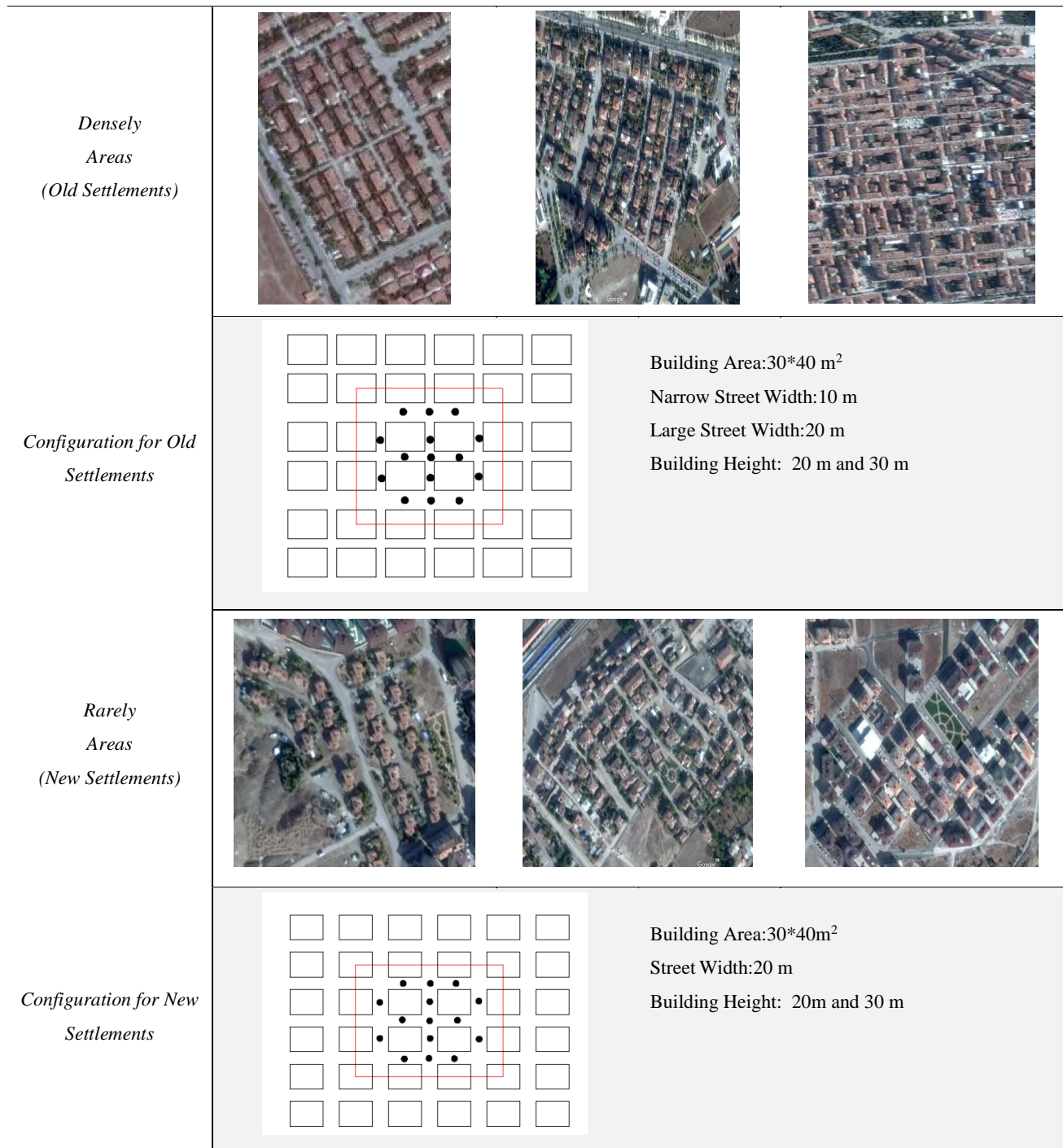

**Figure 1.** Configurations for old and new settlements in Elazığ [12].

20 m and 30 m high buildings have been evaluated for two different configurations. Figure 1 presents the assessed configurations based on existing settlements for both of old and new urban areas. Simulations were made for whole configuration while wind velocity values have been calculated for the points determined in the red square.

### 2.1 Solution Methodology

The velocity profile ( $U$ ) of inlet, the turbulent kinetic energy profile ( $k$ ) and turbulent dissipation rate profile ( $\epsilon$ ) are calculated by equations (1) – (3)

$$U_0 = U_{ref} \left(\frac{z}{H}\right)^{0.25} \quad (1)$$

$$k(z) = u_*^2 / \sqrt{C_\mu} \quad (2)$$

$$\epsilon(z) = C_\mu^{\frac{3}{4}} k^{\frac{3}{2}} / (k_\nu z) \quad (3)$$

Where  $z$  presents the height coordinate (m),  $z_0$  is the aerodynamic roughness length (m),  $k$  is the von Karman constant, and  $u_*$  is the atmospheric boundary layer friction velocity (m/s) [13]. The governing equations of Fluent have not been presented in order to summarize the paper and could be found in the reference [14].

### 2.2 Boundary Conditions and Simulation Set-Up

Building width and length are accepted as 30mx40m respectively. Street widths are accepted as 10 m for densely and 20 m for rarely urban areas. The height of the computational domain is set to 6H while the outlet boundary is set to 15H away from buildings (Figure 2) [15]. The prevailing wind direction is set up as NW, while on the Cartesian coordinate system, the X-direction represents the East and the Y-direction the North. Since 2 to 5 m/s wind speed is dominant in Elazığ [16], inflow wind velocities 3m/s and 5m/s have been used in order to evaluate natural ventilation performance of urban districts.

In this study, simulations were performed by a commercial CFD program Ansys Fluent 18. 5. Modelling and meshing studies were also performed in Workbench in accordance with Fluent solver. Mesh skewness ratio was accepted as a criteria for mesh quality. Since it is aimed to evaluate the ventilation efficiency of building arrays, standart k-ε model is used for steady-state three dimensional simulations [8] .

### 2.3 Spatially Averaged Wind Velocity Ratio

Wind velocity ratio ( $W_{RW}$ ) is a remarkable indice to measure the wind's availability in an urban area considering pedestrian level. It is the ratio of wind velocity at the top of the boundary layer to the wind velocity at about 2m above ground.  $W_{RW}$  is strongly affected by arrangement of buildings in an urban area [17].

It can be calculated by equation (4)

$$V_{RW} = V_p / V_{ref} \quad (4)$$

$V_p$  presents the wind velocity at 2m above the ground level (pedestrian level) while  $V_{ref}$  is the inlet velocity of the wind. It is necessary to assess measurement points distributed about 10-50 m apart around the study area in order to calculate the spatially averaged wind velocity ratio [17].

### 2.4 Validation Study

An observational study was performed in order to validate the code. For this purpose, wind velocity measurements were done for the points determined as P1 to P5 (Figure 3) on the new settlement. Measurements were done by a mobile CEM DT-619 model thermo-anemometer [18] and taken on 21<sup>th</sup> September 2019. Average wind velocities and directions of the related day for Elazığ was taken from the Government Meteorological Office. This data is used as input for the simulations that were done for validation study. Measured and simulated wind velocities presented in Figure 4 and showed a good agreement.

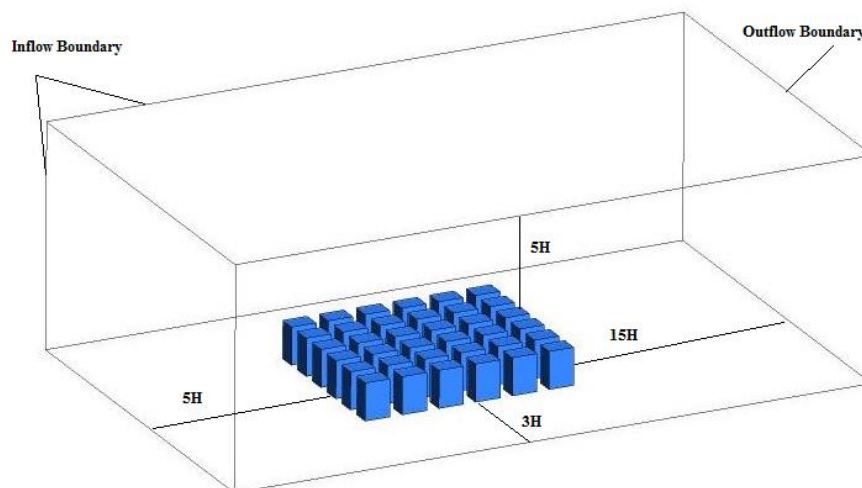

Figure 2. Domain of the study

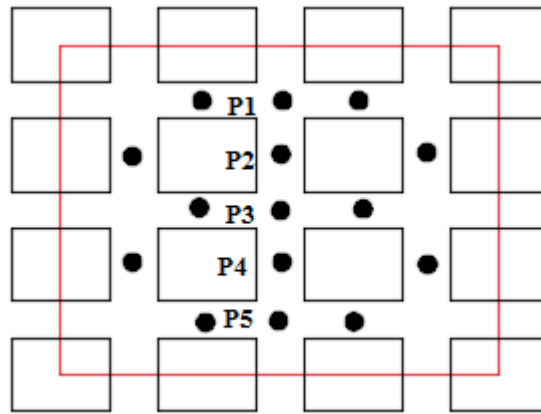

Figure 3. Assessed points in the configuration of new settlement for the validation study.

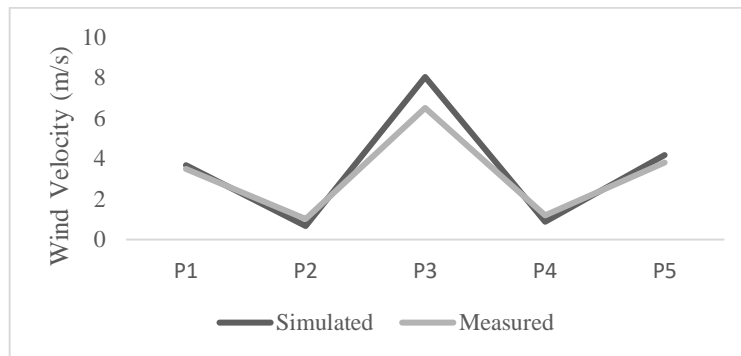

Figure 4. Comparison of measured and simulated wind velocities for P1-P5 points

### 3 Results

In this study, a CFD computation was completed in order to analyse the natural ventilation performance of two different configurations that represent the old and new settlements in Elazığ. Two wind velocities (2 and 5 m/s) and two different building heights were taken into consideration for simulations. Configurations were analyzed based on  $V_{RW}$  for 15 points determined on the settlements while calculation results were supported by visual flow field images.

Figure 5 shows the  $V_{RW}$  values calculated due to simulations results. Old city configuration has lower  $V_{RW}$  values and the difference between old and new configurations is very remarkable. Changing wind velocity does not affect the configurations’s natural ventilation performance and values for  $V_{RW}$  is very close to each other while it is 0.14 for 20 m height buildings considering 3 and 5 m/s wind velocities. It is equal to 0.15 for 3m/s and 0.12 for 5m/s wind velocities considering 30 m height buildings. Figure 6 presents the flow field for old configuration considering defined building heights and wind velocities. Because of the wind’s NW direction, coming flow could not be influenced by narrow streets and natural ventilation performance is weak in general. Laminar flow field is dominant on the 20 m width streets. Increasing wind velocity does not provide an increase for  $V_{RW}$  while increasing building height causes decreasing with natural ventilation performance. Narrow streets in the old configuration is the main problem that cause lower  $V_{RW}$  for old city configuration. Most of the narrow streets lack of natural ventilation

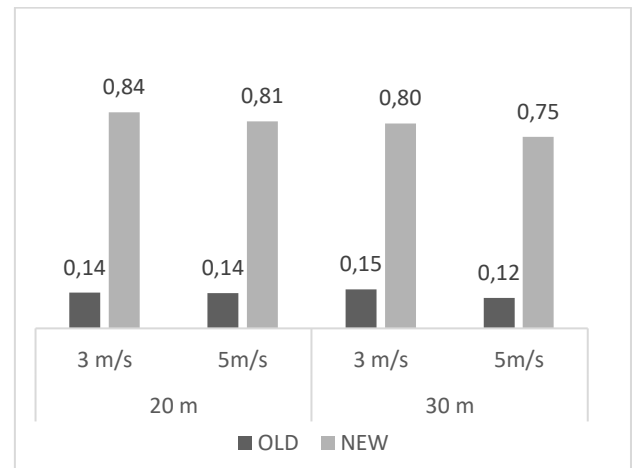
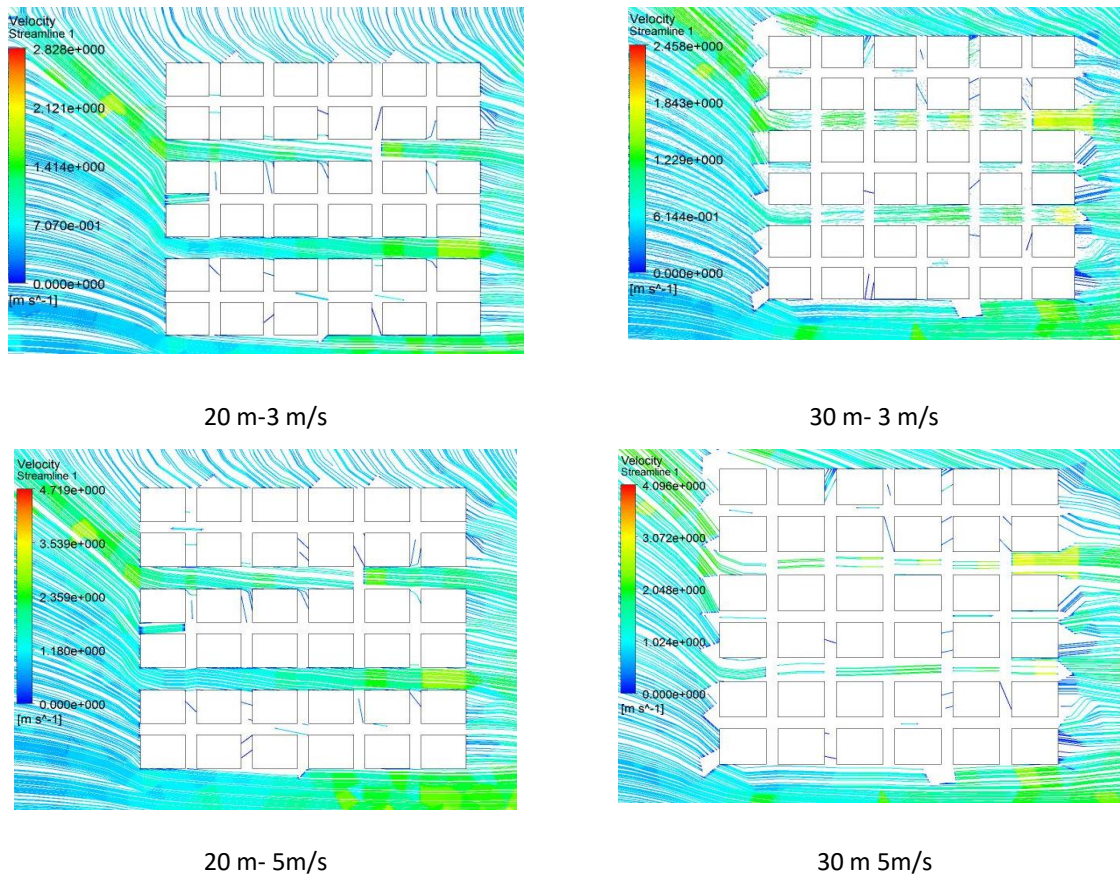
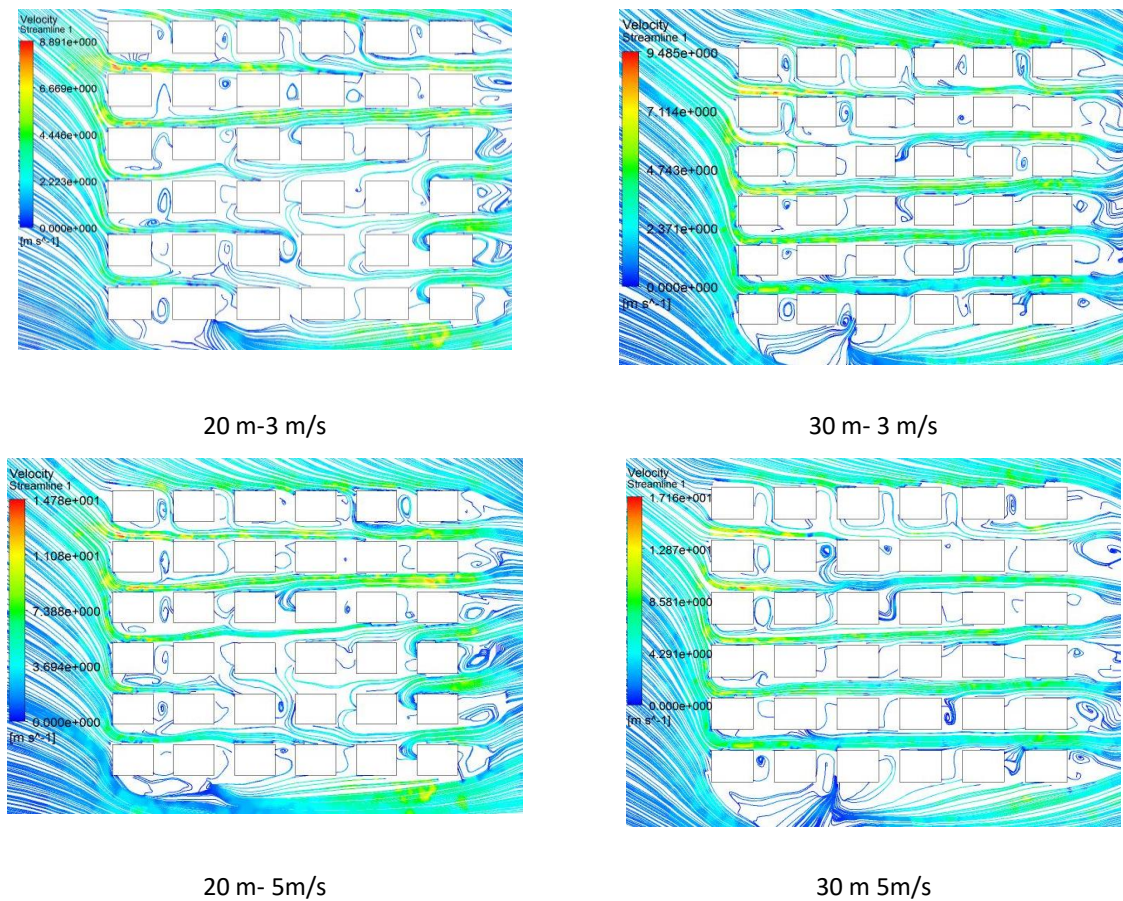

Figure 5.  $V_{RW}$  of configurations assessed for old and new settlements

$V_{RW}$  values varied between 0.84 and 0.75 (Figure 5) for configuration of new settlement. Better ventilation results were calculated for 3m/s wind velocity. Configuration for new settlement showed a balanced ventilation performance in comparison with configuration of old settlement. Figure 7 presents the flow field via wind velocities and building heights for configuration of new settlements. Due to the coming wind direction, flow goes fluently on the horizontal axis. The flow escaped between buildings on the vertical axis provides a cross ventilation for street grids. For the consideration of new settlement, streets on both of X and Y axes show a good performance in terms of natural ventilation while the ones on X axis have a better performance because of wind’s coming angle.



**Figure 6.** Simulated flow field for configuration of old settlements



**Figure 7.** Simulated flow field for configuration of new settlements

The laminar flow is dominant on X axis while turbulent flow occurs in the streets of Y axis that are perpendicular to the wind flow. Increasing wind velocity also increases the laminar flow effect. Increasing building height decreases the wind distribution (Figure 7). For example, 20 m height buildings with 3 m/s have a better wind distribution in comparison with the configuration with 30 m height buildings considering new settlement. This increases turbulent flows between buildings for the configuration with 20 m height buildings and the wind velocity ratios decrease. Depending on the geometry of buildings in the configuration, lower building heights provide better and comfortable outside conditions.

#### 4 Conclusion

In this work, the aim was to analyze the ventilation performance of old and new settlement configurations existing in Elazığ province in the east of Turkey. CFD-based simulations were completed considering, 3 m/s, and 5m/s wind velocities for NW wind direction. 20 m and 30 m building heights have also been used as governing parameters. Wind velocity ratios for old and new settlement configurations were determined and related flow field images were presented. Main findings of the study could be listed as:

- Configuration for old settlements showed lower  $V_{RW}$  values. The difference between old and new settlements is remarkably high. It is 0.70 for 3m/s, 0.67 for 5m/s, when the building height is 20m and 0.65 for 3 m/s, 0.63 for 5 m/s when the building height is 30 m.
- Configuration for new settlements presented  $V_{RW}$  values as 0.84 and 0.81 for 3 and 5 m/s wind velocities when the building height is 20 m, 0.80 and 0.75 for 3 and 5 m/s wind velocities when the building height is 30 m.
- Increasing wind velocity did not increase the natural ventilation potential. It is much more related to urban configuration and wind direction.
- Configuration for new settlements presented a balanced wind distribution while narrow streets in the configuration for old settlements lack of natural ventilation.
- Increasing building height showed that laminar flows increase and distribution of wind is blocked.

Since urban configuration is the most important parameter that affect the urban ventilation, a comparison of old and new settlements have been analysed in order to notice the negative or positive sides of old and new urban areas in terms of natural ventilation. The author intends to develop the types of configurations that represent old and new settlements with future studies in order to make comparisons from a wider perspective.

#### 5 References

1. Givoni, B., *Climate Considerations in Building and Urban Design*, Van Nostrand Reinhold, Newyork, 1998.

2. Yuan, C., Ng, E., (2014). Practical application of CFD on environmentally sensitive architectural design at high density cities: A case study in Hong Kong. *Urban Climate*, (8), 57–77.
3. Du, Y., Mak, C.M., 2018. Improving pedestrian level low wind velocity environment in high-density cities: A general framework and case study. *Sustainable Cities and Society*, (42), 314–324.
4. He, Y., Tablada, A., Wong, N.H. 2019. Aparametric study of angular road patterns on pedestrian ventilation in high-density urban areas. *Building and Environment*, (151), 251–267.
5. Mirzaei, P.A., Haghghat, F., 2010. A novel approach to enhance outdoor air quality: Pedestrian ventilation system. *Building and Environment*, (45)-,1582-1593.
6. Qihong Deng, Guangxing He, Chan Lu & Weiwei Liu (2012) *Urban Ventilation - A New Concept and Lumped Model*, *International Journal of Ventilation*, 11:2, 131-140.
7. Peng, Y., Gao, Z., Ding, W., (2017), An Approach on the Correlation between Urban Morphological Parameters and Ventilation Performance. *Energy Procedia*, (142), 2884-2891.
8. Hu, T., Yoshie, R. (2013). Indices to evaluate ventilation efficiency in newly-built urban area at pedestrian level. *Journal of Wind Engineering and Industrial Aerodynamics*, (112), 39-51.
9. Peng, Y., Gao, Z., Ding, W. (2017). An investigation on outdoor ventilation performance in high-rise residential districts based on CFD simulation and field measurement. *Procedia Engineering*, (205), 3035-3041.
10. He, Y., Tablada, A., Wong, N.H. (2018). Effects of non-uniform and orthogonal breezeway networks on pedestrian ventilation in Singapore's high-density urban environments. *Urban Climate*, (24), 460-484.
11. Wise, D.J., Boppana, V.B.L. Li, K.W. Poh, H.J.(2018). Effects of minor changes in the mean inlet wind direction on urban flow simulations. *Sustainable Cities and Society*, (37), 492-500.
12. Google Earth, 2019.
13. Bouhacina, B., Saima, R., Benzenine, H., Oztop, H.F.(2013). Analysis of thermal and dynamic compartment of a geothermal vertical U-tube heat exchanger. *Energy and Buildings*, (58), 37-43.
14. Ansys Fluent User's Guide, 2019.
15. Franke, J., Hirsch, C., Jensen, A., Krüs, H., Schatzmann, M., Westbury, P., et al. (2004). Recommendations on the use of CFD in wind engineering. *Cost Action C*, vol. 14, C1.
16. Government Meteorological Office of Turkey, (10.02.2019)
17. Ng, E. (2009) Policies and technical guidelines for urban planning of high-density cities – air ventilation assessment (AVA) of Hong Kong, *Building and Environment*, (44), 1478-1488.
18. www. Cem-instruments.com/en (1.11.2019)