



e-ISSN: 2548-060X

## International Journal of Energy Applications and Technologies

journal homepage: [www.dergipark.gov.tr/ijeat](http://www.dergipark.gov.tr/ijeat)

Original Research Article

### Artificial neural networks modelling for biodiesel production from waste cooking oil

Süleyman Karacan<sup>1\*</sup>, Büşra Gedikaslan<sup>1</sup>, Mehmet Tuncay Çağatay<sup>2</sup><sup>1</sup> Ankara University, Engineering Faculty, Department of Chemical Engineering, Tandoğan 06100, Ankara, Turkey<sup>2</sup> National Defence Ministry, Ankara District Quality Management Presidency, Etilik 06010, Ankara, Turkey

#### ARTICLE INFO

\* Corresponding author  
[karacan@eng.ankara.edu.tr](mailto:karacan@eng.ankara.edu.tr)Received January 15, 2020  
Accepted June 29, 2020Published by Editorial Board  
Members of IJEAT© This article is distributed by  
Turk Journal Park System under  
the CC 4.0 terms and conditions.

doi: 10.31593/ijeat.675275

#### ABSTRACT

The objective of the present work is to develop models inculcating the effect of operating conditions of waste cooking oil methyl esters production in the reactive distillation column, namely waste cooking oil (WCO) flow rate, methanol/WCO molar ratio, reboiler heat duty and feed inlet temperature on the estimation of parameters like the biodiesel conversion by using Artificial Neural Networks technique. In our study, at the maximum biodiesel conversion of 99.48% and at steady state time of 1.69 hour were determined as WCO flow rate of 2.90 ml/min, methanol/oil molar ratio of 8.19 and reboiler heat duty of 0.419 kW. Experiments were conducted in the laboratory and the results obtained were used to develop the ANN model using MATLAB. The developed model was in good agreement with the experimental values.

**Keywords:** Biodiesel; Artificial neural network; Simulation; Waste cooking oil

#### 1. Introduction

Biodiesel is a liquid fuel similar to petroleum diesel in combustion properties but is essentially free of sulphur, making it a cleaner burning fuel than petroleum based diesel. Biodiesel is a promising non-toxic and biodegradable renewable fuel comprising of mono-alkyl esters of long chain fatty acids, which is produced by a catalytic transesterification reaction of vegetable oils with short chain alcohols. It has become an interesting alternative to diesel, because it has similar properties to the traditional fossil diesel fuel and may thus substitute diesel fuel with none or very minor engine modifications [1]. Transesterification reactions can be catalysed by an acid, base, or enzymes. Homogeneous and heterogeneous alkali and acid catalysts have been studied [2]. Heterogeneous acid and base catalysts have the advantage that separation and regeneration of the catalyst is easy and cheap [3]. Heterogeneous basic catalysts include

alkaline– earth metal oxides such as CaO, MgO, SrO, and hydrotalcites [4,5]. In addition to the economical advantage, the superior catalytic performance of CaO is described in a number of papers reviewing utilization of solid base for the heterogeneous catalytic reaction to produce biodiesel [6–9]. Although several biodiesel production plants are operating around the world, the main technical challenge is how to make biodiesel profitable, given the high cost of raw vegetable oil used as the source of triglycerides. Results of economic evaluation [10] show that raw material costs account for a major portion of the total manufacturing cost. However, its price has been increasing internationally due to the growth of world demand for food because the most of vegetable oil used in the biodiesel production is a food commodity [11]. The use of waste cooking oil (WCO) or waste frying oil (WFO) instead of virgin oil to produce biodiesel is one ways to reduce the cost, as it is estimated to be about half the price of virgin oil [12]. Artificial Neural

Network (ANN), a popular modelling tool for processes where nonlinear multivariable relationships are involved, is also called as black box modelling and its working principle is loosely modelled on the biological neural network. It is composed of a large number of data processing elements called as nodes or neurons arranged in layers and interconnected with each other to develop a correlation [13]. Multi-Layer Perception (MLP) is the most common type of ANN employed in modelling of chemical processes. It is a feed forward error back propagation neural network and consists of input and output layers apart from at least one hidden layer in between them. The number of nodes in input and output layers is decided by the number of independent and dependent parameters that define the process. The number of hidden layers and the number of nodes in each hidden layer [14]. The developed ANN was a feed forward back propagation network with one input, two hidden and one output layers. The input parameters for the ANN to generalize the pre-treatment process were initial acid value of vegetable oil, methanol-to-oil ratio, catalyst concentration and reaction time and the output parameter was final acid value of oil. The developed ANN was trained with the experimental data obtained for jatropha, mahua, simaruoba and rice bran oils with acid value more than 14mg KOH/g-oil [15]. Atiya et al [16] studied on castor oil transesterification in presence of acid catalyst aims to use ANN for modelling the experimental data obtained as decided by central composite design (CCD) and then predicting fractional formation profile of FAME at optimized conditions, determined by RSM. The objective of the present work is to develop models inculcating the effect of operating conditions of waste cooking oil methyl esters production in the reactive distillation column, namely waste cooking oil (WCO) flow rate, methanol/WCO molar ratio, reboiler heat duty and feed inlet temperature on the estimation of parameters like the biodiesel conversion by using Artificial Neural Networks technique.

Banarjee A. et al [18] worked concerns with the transesterification of castor oil with methanol to form biodiesel. As the free fatty acid content in castor oil is more than 1%, an acid catalyst namely, H<sub>2</sub>SO<sub>4</sub> has been used for esterification. The experimental conditions were determined using central composite design method and the experiments were conducted in a 2 L working volume fully controlled reactor. The input conditions namely, catalyst concentration, methanol to oil molar ratio and temperature were varied, and % fatty acid methyl ester (FAME) content was determined. Based upon the experimental data, an ANN model has been developed which is used to predict %FAME yield for a given set of input conditions. The experimental data and the data predicted by the ANN model have been used to estimate the rate constants of a kinetic model. The ANN model predicts the % FAME yield within ±8% deviation, and the developed

kinetic model shows successfully the effect of methanol to oil molar ratio on % FAME yield at 60 °C and 3% (v/v) catalyst loading.

Xiaoyun Yue et al [19] research for finding alternative fuel sources has been concluded that the renewable fuels such as biodiesel can be used as an alternative to fossil fuels because of the energy security reasons and environmental benefits. In this contribution, transesterification of castor oil with methanol to form biodiesel has been modelled by using artificial neural network fuzzy interference system (ANFIS) approach. Methanol to oil molar ratio, catalyst amount (C), temperature (T), and time (S) were used as input parameters and fatty acid methyl ester yield was used as output parameter for modelling the efficiency of biodiesel production from castor oil. Obtaining low value of absolute deviation (2.2391), high value of R-squared (0.98704), and other modelling results proves that ANFIS modelling is an effective approach for biodiesel production from castor oil. In conclusion, a comparison has been presented between our model and other.

## 2. Materials and Method

### 2.1. Materials

Waste cooking oil was obtained from local restaurants in Ankara, Turkey. Heterogenous basic CaO catalyst was used for the biodiesel production. Methanol and CaO were purchased from Sigma–Aldrich. The fatty acid composition of waste cooking oil (see Table 1) was determined by Perkin Elmer Clarus 500 model gas chromatography (GC) using Agilent HP-88 (100 m x 0.25 mm x 0.2 µm) capillary column and Flame Ionization Detector (FID) with helium as the carrier gas. Analysis was performed according to “CoI/T.20/Doc.No.17, 2001” method identified by International Olive Oil Council (IOOC). The oven temperature was programmed at 175 °C for 12 min, and ramped to 225 °C at a rate of 2 °C/min for 12 min. In addition to, the injector and detector temperatures were 250 °C and 280 °C, respectively.

**Table 1.** The chemical and physical properties of WCO

Parameters	Value
FA composition (wt%)	
Palmitic	20.99
Stearic	4.92
Oleic	38.12
Linoleic	29.73
Physical properties	
Water content	0.09%
Acid value	1.09 (mg KOH/g oil)
Color	Golden yellow

The process involved in this work was a transesterification reaction occurring simultaneously with distillation operation

that were carried out in the reactive packed distillation column set up as shown pictorially in Fig. 1a and schematically in Fig. 1b. The column, excluding the condenser and the reboiler, had a height of 1.5 m and a diameter of 0.05 m. It consisted of a cylindrical condenser with a diameter and a height of 5 and 22.5 cm respectively. The main column section of the plant was divided into two subsections. The upper and lower sections were the reaction and the stripping sections respectively. The stripping section was packed with raschig rings while the reaction section was filled with small lumps ~3-20 mm of CaO solid. The reboiler was spherical in shape with a volume of 3 Liter. The column was fed with sunflower oil and Methanol at the top. All the signal inputs (reflux ratio (R), feed ratio (F) and reboiler duty (Q) to the column and the measured outputs (top segment temperature, reaction segment temperature and bottom segment temperature (TB)) from the column were sent and recorded respectively on-line with the aid of MATLAB/Simulink computer program and electronic input-output (I/O) modules that were connected to the equipment and the computer system. This block diagram was shown in Fig. 2.

The final FAME conversion was determined by FTIR. There were many studies in the literature about qualitative and quantitative analysis of biodiesel by using FTIR. It was noticed that the main frequency domain in which soybean oil and biodiesel mixture could be partitioned was of 1,500–900  $\text{cm}^{-1}$  and that the peak at 1,446  $\text{cm}^{-1}$  frequency was occurred only in biodiesel spectrum [20]. Also, the peak at 1,196  $\text{cm}^{-1}$  was the another characteristic peak for biodiesel [21]. Furthermore, it was found that the amount of biodiesel in the mixture of soybean oil and biodiesel could be detected with 98.11% accuracy by calculating the peak areas in frequency range of 1,425–1,447  $\text{cm}^{-1}$  and 1,188–1,200  $\text{cm}^{-1}$  by using an improved program [22]. In addition, the quantity of biodiesel in mixture of soybean oil and biodiesel was found with 99.91% precision by using the partial least squares regression method in the 1,800–600  $\text{cm}^{-1}$  interval [23].

Taking advantage of the information given above, a calibration curve was established in order to identify the biodiesel conversion ratio of the sample taken from the boiler outlet in each experiment. For this purpose, the known biodiesel ratios of WCO and biodiesel blends were prepared and their FTIR spectrums were drawn. Then, characteristic peak areas of biodiesel at 1,435  $\text{cm}^{-1}$  and 1,195  $\text{cm}^{-1}$  were calculated and plotted against the biodiesel conversion. Thus, the Fig. 3 was obtained and used for the quantitative analysis of FAME.

## 2.2. Design of experiments using Taguchi orthogonal arrays

A new method was developed by G. Taguchi to explore the efficacy of parameters on a mean and variance in a procedure.

This is a statistical method and to make smaller the number of experiments significantly is possible by usage of it. Thus, saving time and resources by minimum number of experiments could become probable. Moreover, it leads to the determination of the factors affecting the product quality. In short, Taguchi experimental design method could be said to be very useful tool for high quality system design. In the experimental configuration, reducing the number of experiments to meaning quantities could be done easily by using orthogonal rows. But, Taguchi, unlike other, standardized orthogonal sequences by sets in tabular form and simplified its use. In the methodology, only a few pairs were searched for instead of all possible combination of parameters. Thus, it became feasible to make a large number of variables with only a few experiments. The orthogonal array to be exploited is selected accordingly by the number of parameters (P) and the variation level (L) of each parameter by using Eq. (1) [17].

$$N = (L - 1) * P + 1 \quad (1)$$

where N is the minimum number of experiments.

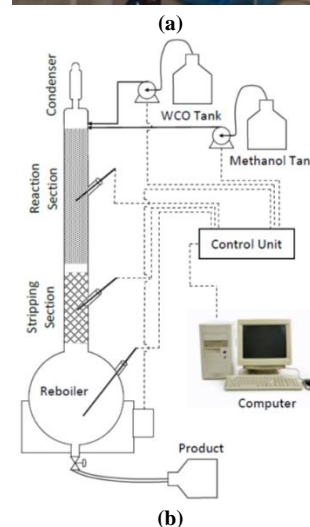

Fig. 1. Reactive packed distillation column: (a) Pictorial view; (b) Sketch view

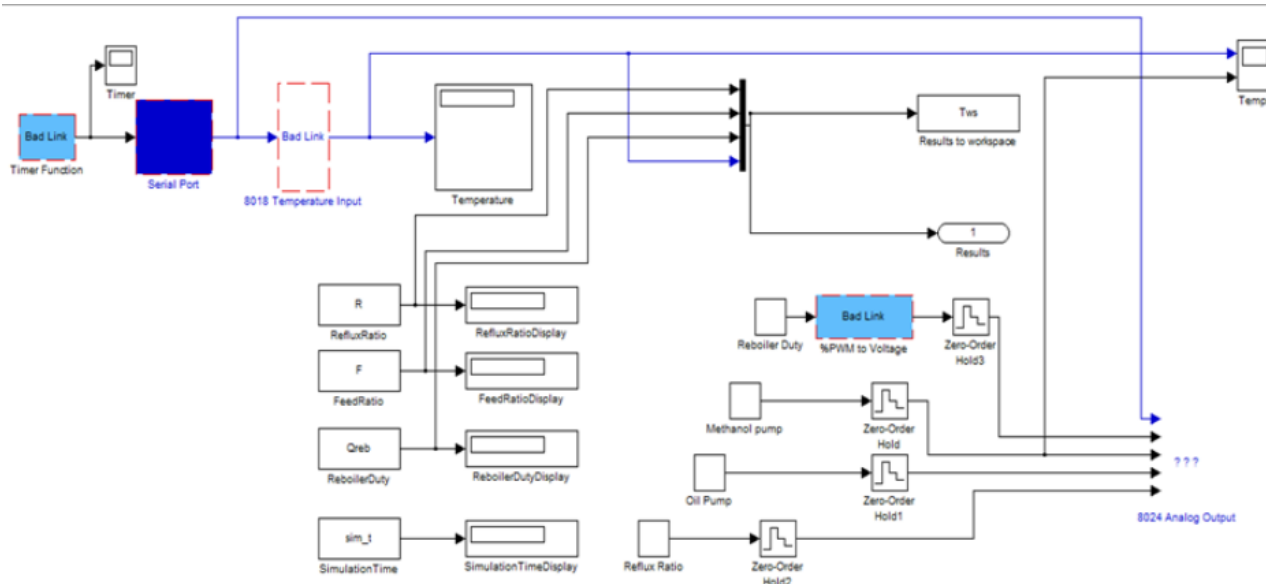

Fig. 2. Block diagram in which experimental data are received and recorded

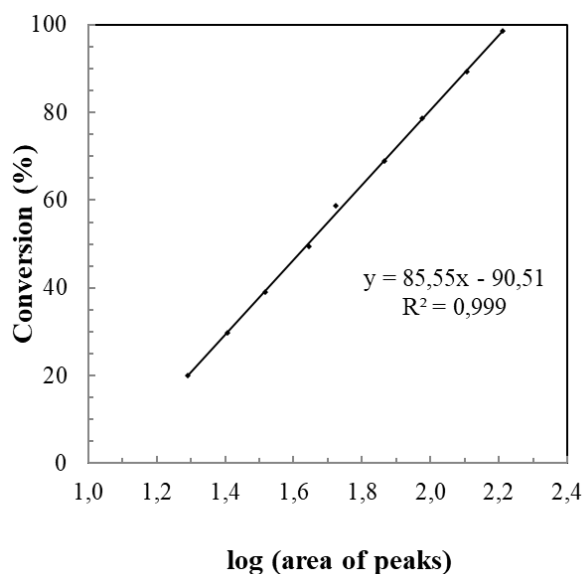

Fig. 3. Calibration graph based on FTIR analysis

### 3. Development of Artificial Neural Network Model

In the present work the data related to the experiments carried out in the laboratory for the production of biodiesel from WCO has been used for modelling purposes. A consolidated data set comprising of 87 data sets is compiled and parameters like the temperature at which the reaction is carried out, waste cooking oil (WCO) flow rate, methanol/WCO molar ratio, reboiler heat duty and feed inlet temperature have been used as the independent input parameters. The models developed are used for the prediction of the one dependent parameter, namely the conversion of biodiesel produced in each of the 87 independent runs. ANN model is developed using MATLAB 2011, inculcating the parameters of the present work. It contains of one hidden layer consisting of 20 neurons. The architectures of the topology for ANN model is depicted in the Fig 4.

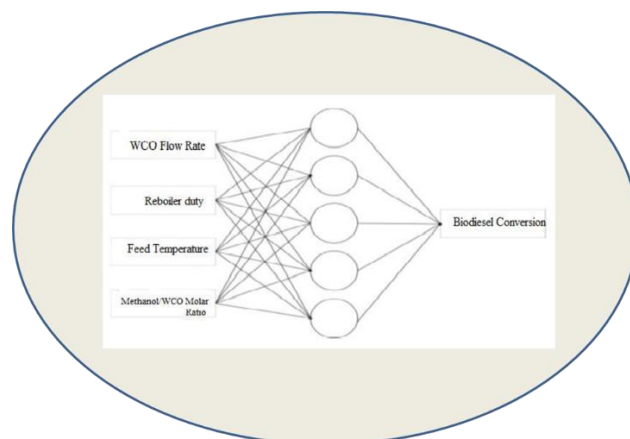

Fig. 4. A typical architecture of the topology of the ANN model

### 4. Results and Discussion

In the study, WCO flow rate, molar ratio of methanol to WCO, reboiler heat duty and feed inlet temperature were chosen as parameters and the effects of them on conversion were investigated. Experimental results are as indicated in Table 2. Some properties of waste oil and methanol used in feeding are shown in Table 3 and the properties of the feed stream are shown in Table 4.

Table 2. Taguchi design and FAME conversion values

Exp.Nu.	WCO flow rate (ml/min)	Molar ratio	Heat duty (W)	Feed inlet temp. (°C)	Biodiesel conv. (%)
1	1.80	6:1	280	45	90.00
2	1.80	8:1	350	50	91.60
3	1.80	12:1	420	55	96.56
4	3.30	6:1	350	55	91.35
5	3.30	8:1	420	45	98.17
6	3.30	12:1	280	50	99.52
7	4.40	6:1	420	50	72.99
8	4.40	8:1	280	55	86.66
9	4.40	12:1	350	45	97.38

**Table 3.** Some properties of components in the feed stream

Properties	Waste Oil	Methanol
Molecular weight (kg)	865.1	32.04
Mole density (kgmol / m3)	1.024	23.35
Density by mass (kg / m3)	885.8	748.2
Heat capacity (kJ / kgmol.C)	1636	119.6
Cp / (Cp-R)	1.005	1.075
Cp / Cv	1.087	1.388
Kinematic viscosity (cSt)	70.89	0.4639
Viscosity (kg / s.m)	6,280e-002	3,471e-004
Thermal Conductivity (W / m.K)	0.1327	0.1649

**Table 4.** Properties of feed stream

	Feed Stream	
	Waste Oil	Methanol
Flowrate, kgmol/h	0.0002	0.0012
<b>Mole fraction</b>		
Metanol	0.0000	1.0000
Tripalmitin	0.2399	0.0000
Tristearin	0.0509	0.0000
Triolein	0.3972	0.0000
Trilinolein	0.3120	0.0000

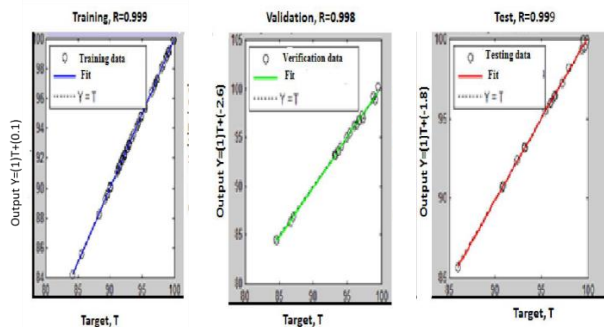

**Fig. 5.** Regression values for the training , Validation and test data

**Table 5.** Results obtained as a result of training

Total Data	Number of Samples	MSE	R
Training	53	2.53648e-4	0.999993
Verification	17	5.34478e-2	0.998964
Testing	17	1.64431e-2	0.999597

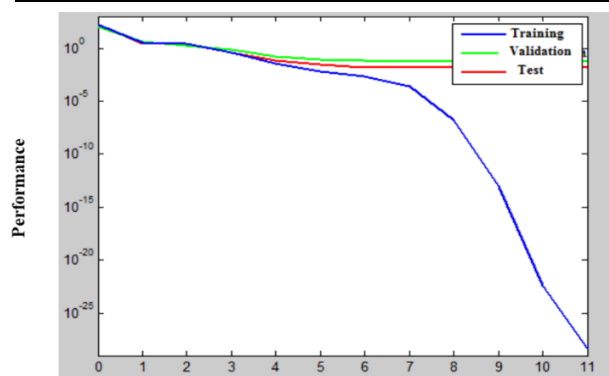
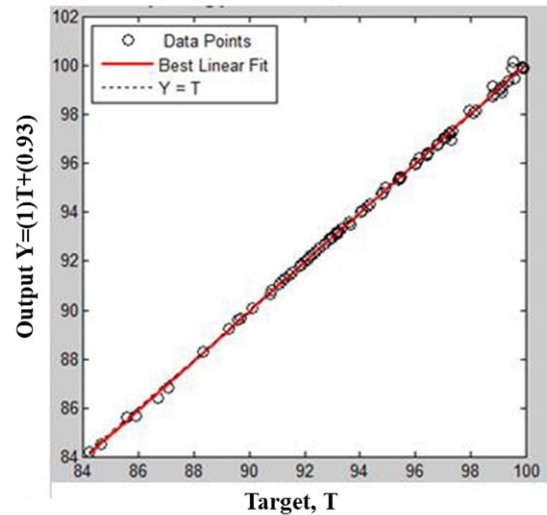

**Fig. 6.** RMSE for training, testing and validation data for the ANN model developed

Total data set of 87 points has been used in developing ANN model using MATLAB [24]. 60% of these 87 samples, 53 samples were used for the training of the model, 20%, 17 samples were used for the test and the remaining 20% were used for the verification of the model. The number of hidden layers was determined as 20 from the network structure and

Levenberg-Marquardt optimization was applied for the training of the network. The correlation value of MSE, small squares error and R, obtained at the end of the training are shown in Table 2. The comparison of the output data obtained from the defined output data and the modelling of the network is shown in Fig 5 and the performance of the training is shown in Figure 6.

The regression between output variables and target is shown in Fig 7.



**Fig. 7.** Regression between output variables and target in the model

## 5. Conclusion

In this study, neural network was used in 4-20-1 model with artificial neural network method, while Banarjee et al. used 4-12-1 artificial neural network model in his studies. This difference was thought to be different from the data groups used and the degree of data being understood by the model. With this model, the biodiesel conversion rate ( $X_c$ ) can be estimated in the experimental conditions. The data obtained from the experiments and the data obtained from the model were compared, and  $R = 0.9992$  correlation coefficient was calculated. In this study, in order to calculate the kinetic data, the system was run in the Aspen HYSYS program, then it was determined how product concentrations changed by applying various step effects in + and - directions. Concentration and conversion rates were obtained. With the help of the data obtained after the reaction speed equation was created ( $k_1$  and  $k_2$ ), the velocity constants were calculated as 0.00758, 0.01003 L.dk/mol, respectively. The recent uncertainty in the production of crude oil worldwide has triggered the increased interest of researchers in the development of fuels from natural sources, particularly fatty acid methyl esters, derived from triglycerides by trans esterification with methanol, known as biodiesel, have received the most attention. The objective of the present work is to correlate the effect of the operating parameters on the

conversion of biodiesel produced in a Reactive Distillation Column using Artificial Neural Networks as a modelling tool. It can be seen that the comparison of the conversion of biodiesel is well in acceptable limits. Also, the percentage error for all the data points is under acceptable limits. The present work is demonstrative & based on the outcome it can be concluded that ANN has great potential in addressing to the estimation problems related to yields incorporating the operating parameters of biodiesel production and should be extended to more comprehensive data sets. This would save on the time and energy and increase the accuracy of the estimations.

### ORCID

Süleyman Karacan		0000-0001-8113-7874
Büşra Gedikaslan		0000-0002-1997-023X
M. Tuncay Çağatay		0000-0002-8625-8058

### References

- [1] Ray S.K. and Prakash O., 2017. "Bio-Diesel Derived from Waste Vegetable Oil as an Alternative Fuel for Diesel Engine: A Review", *Renewable Energy and Its Innovative Technologies*, Proceedings of ICEMIT 2017, Vol:1, 210-231.
- [2] Zhang Y., Dube M.A., McLean D.D. and Kates M. 2003. "Biodiesel production from waste cooking oil: 1. Process design and technological assessment". *Bioresource Technology*, 89, 1-16.
- [3] Sharma, Y.C., Singh, B. and Upadhyay, S.N. 2008. "Advancements in development and characterization of biodiesel: a review". *Fuel*, 87, 2355–2373.
- [4] Liu, X., He, H., Wang, Y., Zhu, S. and Piao, X. 2008. "Transesterification of soybean oil to biodiesel using CaO as a solid base catalyst". *Fuel*, 87, 216–221.
- [5] Kouzu, M., Kasuno, T., Tajika, M., Sugimoto, Y., Yamanaka, S. and Hidaka, J. 2008. "Calcium oxide as a solid base catalyst for transesterification of soybean oil and its application to biodiesel production". *Fuel*, 87, 2798–2806.
- [6] DiSerio, M., Tesser R., Pengmei, L. and Santacesaria, E. 2008. "Heterogeneous catalysts for biodiesel production". *Energy and Fuels*, 22:201–17.
- [7] Zabeti, M., Daud, WMAW and Aroua, MK. 2009. "Activity of solid catalysts for biodiesel production: a review". *Fuel Process Technol.*, 90:770–7.
- [8] Helwani, Z., Othman, MR., Aziz, N., Kim, J. and Fernando WJN. 2009. "Solid heterogeneous catalysts for transesterification of triglycerides with methanol: a review". *Appl Catal A Gen.*, 363:1–10.
- [9] Yan, S., DiMaggio, C., Mohan, S., Kim, M., Salley, SO. and Ng, KYS. 2010. "Advancements in heterogeneous catalysis for biodiesel synthesis". *Top Catal.*, 53:721–36.
- [10] Zhang, Y., Dubé, M.A., McLean, D.D. and Kates, M. 2008. "Biodiesel production from waste cooking oil" vol: 1. Process design and technology assessment. *Bioresour. Technol.*, 99, 1131–1140.
- [11] Festel, G.W. 2008. "Biofuels—economic aspects, chemical engineering & technology". *Chem. Eng. Technol.*, 31, 715–720.
- [12] Kulkarni, M.G. and Dalai, A.K. 2006. "Waste cooking oil – an economical source for biodiesel: a review". *Ind. Eng. Chem. Res.*, 45, 2901–2913.
- [13] Anderson J.A, 1999. An Introduction to Neural Networks Prentice-Hall of India, Pvt Ltd New Delhi.
- [14] Rumelhart D. E. & McClelland, 1986. Back Propagation Training Algorithm Processing, M.I.T Press, Cambridge Massachusetts.
- [15] Machavaram R., Prakash C. J., Hifjur R 2009. "Prediction of optimized pretreatment process parameters for biodiesel production using ANN and GA". *Fuel*, 88 (5), pg. 868-875.
- [16] Atiya B., Devyani V., Surendra K., Payal C., Gupta V. K. 2017. "Biodiesel production from castor oil: ANN modeling and kinetic parameter estimation". *Int J Ind Chem*, 8:253–262.
- [17] Kumar R.S., Sureshkumar K., Velraj R. 2015. "Optimization of biodiesel production from Manilkara zapota (L.) seed oil using Taguchi method". *Fuel*, 140, 90–96.
- [18] Banarjee A., Varshney D., Kumar S., Chaudhary P., Gupta V. K.(2017) Biodiesel production from castor oil: ANN modeling and kinetic parameter estimation. *Int J Ind Chem* 8:253–262
- [19] Xiaoyun Yue, Yehua Chen, And Guoyang Chang (2018) Accurate Modeling Of Biodiesel Production From Castor Oil Using ANFIS. *Energy Sources, Part A: Recovery, Utilization, and Environmental Effects* 2018, vol. 40, no. 4, 432–438.
- [20] Soares I. P., Rezende T. F., Silva R. C., Castro E. V. R. and Fortes I. C. P., "Multivariate Calibration by Variable Selection for Blends of Raw Soybean Oil/Biodiesel from Different Sources Using Fourier Transform Infrared Spectroscopy (FTIR) Spectra Data", *Energy Fuels*, 22: 2079–83, (2008).
- [21] Dube M. A., Zheng S., Mclean D. D. and Kates M. J. A., "A Comparison of Attenuated Total Reflectance–FTIR Spectroscopy and GPC for Monitoring Biodiesel Production", *J. Am. Oil. Chem. Soc.*, 81: 599–603, (2004).
- [22] Mahamuni N. N. and Adewuyi Y. G., "Fourier Transform Infrared Spectroscopy (FTIR) Method to Monitor Soy Biodiesel and Soybean Oil in Transesterification Reactions, Petrodiesel–Biodiesel

Blends, and Blend Adulteration with Soy Oil”, *Energy & Fuels*, 23: 3773–82, (2009).

- [23] Sabrina N. R., Vany P. F., Leandro S. O. and Adriana S. F., “FTIR Analysis for Quantification of Fatty Acid Methyl Esters in Biodiesel Produced by Microwave–Assisted Transesterification”, *Int. J. of Environmental Science and Development*, 6: 964–969, (2015).
- [24] Matlab 11, The MathWorks, Inc., Apple Hill Drive, Natick, MA.,2016.

*NOTE: This article was presented at 8th International Conference on Advanced Technologies (ICAT'19). It was evaluated by 2 Reviewers before publish, and it has been passed all publication and evaluation processes of journal.*