

Journal

TAY

TÜRK AKADEMİK YAYINLAR DERGİSİ

International Peer-Reviewed Journal / Uluslararası Hakemli Dergi

Chief Editor / Baş Editör
Prof. Dr. Bayram TAY



TAY Journal publishes articles in English language three times a year, online in the field of educational sciences.

Türk Akademik Yayınlar Dergisi, eğitim bilimleri alanında çevrim içi olarak yılda üç kez İngilizce dilinde makaleler yayımlamaktadır.



Volume 8 Issue 2 Year 2024

Cilt 8 Sayı 2 Yıl 2024

Chief Editor

Prof. Dr. Bayram TAY
Kırşehir Ahi Evran University-Türkiye

Baş Editör

Prof. Dr. Bayram TAY
Kırşehir Ahi Evran Üniversitesi-Türkiye

Editors

Asst. Prof. Dr. Murat BAŞ
Kırşehir Ahi Evran University-Türkiye
Assoc. Prof. Dr. Michael HAMMOND
The University of Warwick-United Kingdom

Editörler

Dr. Öğretim Üyesi Murat BAŞ
Kırşehir Ahi Evran Üniversitesi-Türkiye
Doç. Dr. Michael HAMMOND
The University of Warwick-Birleşik Krallık

Contact / İletişim

<http://www.tayjournal.com>
<https://dergipark.org.tr/en/pub/tayjournal>
contact@tayjournal.com
<https://x.com/tayjournal>
https://instagram.com/tayjournal_2618_589X

+90 (386) 280 51 77

ISSN: 2618-589X



ASOS
indeks



ESJI
Eurasian Ecientific Journal Index

WORLD
of
JOURNALS

ACARINDEX
academic researches index

CiteFactor
Academic Scientific Journals

Google
Scholar

ROAD
DIRECTORY
OF OPEN ACCESS
SCHOLARLY
RESOURCES

OpenAIRE | EXPLORE

SÖBIAD

tei

türk eğitim indeksi

idealonline

IAD
INDEX OF ACADEMIC DOCUMENTS

ASCI
Asian Science Citation Index

academindex



Volume 8 Issue 2 Year 2024

Cilt 8 Sayı 2 Yıl 2024

Owner and Publisher
Prof. Dr. Bayram TAY

Sahibi ve Yayımcı
Prof. Dr. Bayram TAY

Chief Editor
Prof. Dr. Bayram TAY
Kırşehir Ahi Evran University-Türkiye

Baş Editör
Prof. Dr. Bayram TAY
Kırşehir Ahi Evran Üniversitesi-Türkiye

Editors
Asst. Prof. Dr. Murat BAŞ
Kırşehir Ahi Evran University-Türkiye
Assoc. Prof. Dr. Michael HAMMOND
The University of Warwick-United Kingdom

Editörler
Dr. Öğretim Üyesi Murat BAŞ
Kırşehir Ahi Evran Üniversitesi-Türkiye
Doç. Dr. Michael HAMMOND
The University of Warwick-Birleşik Krallık

Editorial Board
Prof. Dr. Todd S. HAWLEY
Kent State University-USA
Prof. Dr. Timothy RASINSKI
Kent State University-USA
Prof. Dr. Carlos HERVÁS-GÓMEZ
University of Seville-Spain
Assoc. Prof. Dr. Aleksandra MIHAJLOVIĆ
University of Kragujevac-Serbia
Assoc. Prof. Dr. Haktan DEMİRCİOĞLU
Hacettepe University-Türkiye
Assoc. Prof. Dr. Loredana IVA
National University of Political Studies and
Public Administration-Romania
Assoc. Prof. Dr. Mevlüt AYDOĞMUŞ
Necmettin Erbakan University-Türkiye
Dr. Anisoara DUMİTRACHE
University of Bucharest-Romania
Dr. Michele BERTANİ
University of Verona-Italy

Editör Kurulu
Prof. Dr. Todd S. HAWLEY
Kent State University-ABD
Prof. Dr. Timothy RASINSKI
Kent State University-ABD
Prof. Dr. Carlos HERVÁS-GÓMEZ
University of Seville-İspanya
Doç. Dr. Aleksandra MIHAJLOVIĆ
University of Kragujevac-Sırbistan
Doç. Dr. Haktan DEMİRCİOĞLU
Hacettepe Üniversitesi-Türkiye
Doç. Dr. Loredana IVA
National University of Political Studies and
Public Administration-Romanya
Doç. Dr. Mevlüt AYDOĞMUŞ
Necmettin Erbakan Üniversitesi-Türkiye
Dr. Anisoara DUMİTRACHE
University of Bucharest-Romanya
Dr. Michele BERTANİ
University of Verona-İtalya

Language Editor
Assoc. Prof. Dr. Michael HAMMOND
The University of Warwick-United Kingdom

Dil Editörü
Doç. Dr. Michael HAMMOND
The University of Warwick-Birleşik Krallık

Statistics Editor
Assoc. Prof. Dr. Ezgi MOR
Kastamonu University, Türkiye

İstatistik Editörü
Doç. Dr. Ezgi MOR
Kastamonu Üniversitesi, Türkiye

Graphic and Design
Assoc. Prof. Dr. Sevgi KAYALIOĞLU
Ankara Hacı Bayram Veli University-Türkiye

Grafik ve Tasarım
Doç. Dr. Sevgi KAYALIOĞLU
Ankara Hacı Bayram Veli Üniversitesi-Türkiye

doi: 10.29329/tayjournal.2024.653



Volume 8 Issue 2 Year 2024

Cilt 8 Sayı 2 Yıl 2024

Publication Advisory Board

Prof. Dr. Ahmet NALÇACI
Kahramanmaraş Sütçü İmam University, Türkiye
Prof. Dr. Asuman Seda SARACALOĞLU
Adnan Menderes University, Türkiye
Prof. Dr. Cemalettin İPEK
Kırşehir Ahi Evran University, Türkiye
Prof. Dr. Hayatî AKYOL
Gazi University, Türkiye
Prof. Dr. Handan DEVECİ
Anadolu University, Türkiye
Prof. Dr. Kasım YILDIRIM
Muğla Sıtkı Koçman University, Türkiye
Prof. Dr. Myunghui HONG
Seoul National University, Korea
Prof. Dr. Xun GE
The University of Oklahoma, USA
Assoc. Prof. Dr. Bengisu KOYUNCU
Mimar Sinan University, Türkiye
Assoc. Prof. Dr. Özlem KILINÇER
Nevşehir Hacı Bektaş Veli University, Türkiye

Contact/Copy Editing Editors

Res. Asst. Eylem ÇOBAN
Gaziantep University-Türkiye
Anıl Gülcan DENİZ BUDAK
Kırşehir Ahi Evran University-Türkiye

Contact Address

Kırşehir Ahi Evran University Faculty of Education
Basic Education Department
Department of Classroom Education
Bağbaşı Mah. Şehit Necdet Yağız Cad. No: 143 / E
Kırşehir/Türkiye

Yayın Danışma Kurulu

Prof. Dr. Ahmet NALÇACI
Kahramanmaraş Sütçü İmam Üniversitesi, Türkiye
Prof. Dr. Asuman Seda SARACALOĞLU
Adnan Menderes Üniversitesi, Türkiye
Prof. Dr. Cemalettin İPEK
Kırşehir Ahi Evran Üniversitesi, Türkiye
Prof. Dr. Hayati AKYOL
Gazi Üniversitesi, Türkiye
Prof. Dr. Handan DEVECİ
Anadolu Üniversitesi, Türkiye
Prof. Dr. Kasım YILDIRIM
Muğla Sıtkı Koçman Üniversitesi, Türkiye
Prof. Dr. Myunghui HONG
Seoul National University, Kore
Prof. Dr. Xun GE
The University of Oklahoma, ABD
Doç. Dr. Bengisu KOYUNCU
Mimar Sinan Üniversitesi, Türkiye
Doç. Dr. Özlem KILINÇER
Nevşehir Hacı Bektaş Veli Üniversitesi, Türkiye

İletişim/Yazım ve Mizampaj Editörleri

Araş. Gör. Eylem ÇOBAN
Gaziantep Üniversitesi-Türkiye
Anıl Gülcan DENİZ BUDAK
Kırşehir Ahi Evran Üniversitesi-Türkiye

Yazışma Adresi

Kırşehir Ahi Evran Üniversitesi Eğitim Fakültesi
Temel Eğitim Bölümü
Sınıf Eğitimi Anabilim Dalı
Bağbaşı Mah. Şehit Necdet Yağız Cad. No: 143 / E
Merkez / KIRŞEHİR

Contents / İçindekiler

Research Article/Araştırma Makalesi

Mehmet Yavuz, Gökhan Ilgaz

The Mediating Role of Professional Burnout in the Relationship between Life Satisfaction, Teacher Self-Efficacy and Job Satisfaction of Teachers Working in Inclusive Classrooms
Kaynaştırma Sınıflarında Çalışan Öğretmenlerin Yaşam Doyumu, Öğretmen Öz Yeterliliği ve İş Doyumu İlişkisinde Mesleki Tükenmişliğin Aracılı Rolü

197-224

Research Article/Araştırma Makalesi

Tuğba Semin Akkurt, Ömer Faruk Sönmez

Determination of Tax Awareness Level of Secondary School Students
Ortaokul Öğrencilerinin Vergi Bilincine Yönelik Farkındalıkları

225-245

Research Article/Araştırma Makalesi

Musa Türkmen, Mustafa Kaya

Examination of The Relationship between Physical Activity Level and Social Skills Level of Individuals Diagnosed with Special Learning Disability
Özel Öğrenme Güçlüğü Olan Bireylerin Fiziksel Aktivite Düzeyi ile Sosyal Beceri Düzeyi Arasındaki İlişkinin İncelenmesi

246-262

Research Article/Araştırma Makalesi

Özgür Babayiğit, Zeynep Koyunlu Ünlü, Uğur Gezer

Examination of Turkish Lessons Applied in Science and Art Centers
Bilim ve Sanat Merkezlerinde Uygulanan Türkçe Derslerinin İncelenmesi

263-286

Research Article/Araştırma Makalesi

Cahide Karakaş Tan, Mutlu Pınar Demirci Güler

Development of an Environmental Attitude Scale for Primary School Students
İlkokul Düzeyi Çevre Tutum Ölçeği Geliştirme Çalışması

287-316

Contents / İindekiler

Research Article/Arařtırma Makalesi

Atilla Özdemir, Selahattin Gelbal

*The Discrete Option Multiple Choice Items as A Measurement Instrument for
Mathematics Achievement*

317-348

*Matematik Başarısı için Bir Ölme Aracı Olarak Ayrık Seçenekli Çoktan
Semeli Maddeler*

Research Article/Arařtırma Makalesi

Serkan Bilgi, Tufan Ayta

*Evaluation of School Occupational Health and Safety Practices Performance
Indicators by School Administrators*

349-389

*Okul İş Saėlıėı ve Güvenliėi Uygulamaları Performans Göstergelerinin Okul
Yöneticileri Tarafından Deėerlendirilmesi*

Letter from the Chief Editor/Baş Editörden Mektup

Dear Readers,

The second issue of TAY Journal 2024 includes articles on inclusion in special education, physical activity in special education, discrete choice multiple-choice items in measurement and evaluation, attitude scale towards the environment in environmental education, applications in "Science and Art Centers" in Turkish education, and tax awareness in social studies education.

We would like to thank our authors who sent their original works to our journal, our reviewers for their detailed reviews and reports, the academics who participated in our editorial and advisory boards and who did not spare their help in every step of the articles, Asst. Prof. Dr. Murat Baş (Editor), Res. Asst. Eylem Çoban (Copy Editing Editor) and Anıl Gülcan Deniz Budak (Copy Editing Editors).

We hope that our journal will contribute to scientific accumulation and we look forward to your comments and suggestions.

Değerli Okuyucularımız,

Türk Akademik Yayınlar Dergisi (TAY Journal) 2024 yılının ikinci sayısında; özel eğitimde kaynaştırma, özel eğitimde fiziksel aktivite, ölçme ve değerlendirmede ayrık seçenekli çoktan seçmeli maddeler, çevre eğitiminde çevreye yönelik tutum ölçeği, Türkçe eğitiminde bilim ve sanat merkezlerindeki uygulamalar ve sosyal bilgiler eğitiminde vergi farkındalığı konularını içeren makaleler yer almaktadır.

Özgün eserlerini dergimize gönderen yazarlarımıza, detaylı incelemeleri ve raporları için hakemlerimize, editör ve yayın danışma kurullarımızda yer alan ve makalelerin her bir adımında yardımlarını esirgemeyen akademisyenlere, makaleleri titizlikle yayına hazırlayan Dr. Öğretim Üyesi Murat Baş'a (Editör), Araş. Gör. Eylem Çoban'a (Dizgi ve Mizanpaj Editörü) ve Anıl Gülcan Deniz Budak'a (Dizgi ve Mizanpaj Editörü) teşekkür ederiz.

Dergimizin bilimsel birikime katkı sağlamasını diler, görüş ve önerilerinizi bekleriz.

Prof. Dr. Bayram TAY
Chief Editor/Baş Editör
bayramtay@tayjournal.com



<http://www.tayjournal.com>

<https://dergipark.org.tr/en/pub/tayjournal>

The Mediating Role of Professional Burnout in the Relationship between Life Satisfaction, Teacher Self-Efficacy and Job Satisfaction of Teachers Working in Inclusive Classrooms

 Mehmet Yavuz, Assoc. Prof. Dr., Corresponding Author
Trakya University, Türkiye
mehmetyavuz23@gmail.com
Orcid ID: 0000-0003-0762-1611

 Gökhan Ilgaz, Assoc. Prof. Dr.
Trakya University, Türkiye
gokhani@trakya.edu.tr
Orcid ID: 0000-0001-8988-5279

Article Type: Research Article

Received Date: 21.04.2023

Accepted Date: 29.05.2024

Published Date: 31.07.2024

Plagiarism: This article has been reviewed by at least two referees and scanned via a plagiarism software

Doi: 10.29329/ tayjournal.2024.653.01

Citation: Yavuz, M., & Ilgaz, G. (2024). The mediating role of professional burnout in the relationship between life satisfaction, teacher self-efficacy and job satisfaction of teachers working in inclusive classrooms. *Türk Akademik Yayınlar Dergisi (TAY Journal)*, 8(2), 197-224.

Abstract

Aim of this study was to examine mediating role of professional burnout in the relationship between life satisfaction, teacher self-efficacy and job satisfaction of teachers working in inclusive classrooms. A structural equation modelling method was used in the study. Life satisfaction scale, teacher self-efficacy scale, job satisfaction scale and teacher professional burnout scale were used to collect data under scope of the study. Google Forms software was used to collect research data. The scales created on Google Forms were conveyed to teachers via WhatsApp, Facebook, Instagram and e-mail. Normality test was applied to obtained data and it was observed that the data was normally distributed. According to the results of the research, there was a positive relationship between teachers' levels of life satisfaction and professional self-efficacy, a positive relationship between their levels of life satisfaction and job satisfaction; a negative relationship between their levels of self-efficacy and professional burnout; a negative relationship between their levels of life satisfaction and professional burnout, and a negative relationship between their levels of professional burnout and job satisfaction. Results do not present any relationship between teacher self-efficacy and job satisfaction. It was observed that teachers' professional burnout played a mediating role not only in the relationship between self-efficacy and job satisfaction but also in the relationship between life satisfaction and job satisfaction. In future studies, the mediating role of other variables can be analysed.

Keywords: Life satisfaction, professional burnout, self-efficacy, job satisfaction.

Introduction

Unique challenges faced by individuals with disabilities becoming increasingly important in the field of education, and require to design and to implement more efficient special education strategies. Individuals with disabilities need education programmes, educational environments, educational methods and techniques, and tools and equipment suitable for their special needs (Kargin, 2010). According to the Special Education Services Regulation (Ministry of National Education [MoNE], 2018), individuals, who have special education needs, can continue their education full-time in special education schools or same classroom as their peers through inclusion/integration, or part-time in special education classes. It is stated in article 11 of the same regulation that inclusive students should be directed to the least restricted educational environments. The least restricted educational environment refers to environments where all students with special education needs, including those who attend a separate special education school or a special education class, can be with their families and peers as much as possible, and where they can receive education in the same environment as their normally developing peers, and at the same time, where their educational needs are met in the best possible way (Batu & Kırçali-İftar, 2005). However, when special need students come to an inclusive environment, they may have different needs than normally developing children. Therefore, it is important for teachers who work with special need students to have the competence to work with these students (Marzano & Marzano, 2003). In other words, it can be seen that the most important element of the practice of inclusion is the teacher, and great duties fall on the teacher in this respect (Batu, 2000).

The teaching profession is an important professional field in terms of raising and educating the children who are our future. The teaching profession is a profession that requires qualities such as self-sacrifice, tolerance, continuous self-renewal, and practising the

profession with love (Ergül et al., 2013). Being able to understand the field knowledge in a way that can be shared with others (i.e. students) rather than just knowing it for oneself, having the basic knowledge of where to start and the awareness of the difficulties that may be encountered in terms of what path should be followed when sharing with others. It also means having the knowledge of which materials and representations should be given priority when sharing information with others (Shulman, 1986). In addition, teachers' knowledge about child development will help them provide education appropriate to their developmental level. When the teacher has knowledge about child development, he/she knows that each child has individual differences and accordingly their needs may be different, and takes their developmental characteristics into consideration when preparing a program (Artan & Uyanık Balat, 2003).

Self-sacrifice, tolerance and practising the profession with love are particularly important in the field in which teachers work with inclusive students, since working with students with disabilities is more difficult than working with normally developing children. In individuals with disabilities, severe behavioural problems may be seen, and deficiencies in social and language skills and limitations in academic skills can be observed (Billingsley & Cross, 1991). For these reasons, teachers may feel inadequate (Billingsley & Cross, 1991; Koyutürk, 2014). Because of these intense behavioural and learning problems, a feeling of burnout may be seen in teachers working with inclusive students. In order for teachers working with inclusive students not to experience burnout, their professional self-efficacy (Kabasakal, 2018; Koyutürk, 2014, Soodak et al., 1998) and life satisfaction (Kabasakal, 2018; Koyutürk, 2014) should be high. High professional self-efficacy and life satisfaction (Koyutürk, 2014) will enable teachers to exhibit a positive attitude in inclusion practices (Sharma et al., 2011). In this way, too, it has been observed that teachers work more diligently for the success of their students who have learning problems; they prepare and implement better lesson plans, and they can educate even the most difficult students (Kaner, 2010).

The concept of professional burnout first began to be used in the United States in the 1970s and was defined as “a state of exhaustion that occurs as a result of failure, wearing out, loss of energy and strength, or excessive demands on a person’s inner resources” (Maslach et al., 2001). Burnout syndrome is more commonly seen in people who are required to work with people face to face (Tuğrul & Çelik, 2002). One of these areas is the teaching profession. The feeling of burnout has a serious negative effect on teachers’ work efficiency, and teachers develop negative attitudes towards their jobs, experience less job satisfaction, go to work with less desire, and feel constantly tired (Dworkin, 2001). Furthermore, teachers who experience burnout continually have problems in the classroom are unsuccessful in using coping strategies (Camacho, 2017), neglect their duties, and feel inadequate in their profession, and as a result, they may quit their jobs (Collie et al., 2012). In the literature, burnout is examined in three dimensions: emotional exhaustion, depersonalisation, and low personal accomplishment (Maslach et al., 2001; Yiğit, 2007).

Emotional exhaustion is the first symptom of burnout (Ören and Türkoğlu, 2006) and refers to its stress-related dimension (Maslach et al., 2001; Moore, 2000; Roelofs et al., 2005). In other words, it is a person’s feeling of being emotionally exhausted (Moore, 2000; Yiğit,

2007). Individuals experiencing emotional exhaustion have become weary of their jobs and feel physically worn out (Ören & Türkoğlu, 2006). An individual experiencing emotional exhaustion has a problem focusing on his/her job (Maslach et al., 2001).

The dimension of depersonalisation is the emotional disconnection of the individual from his/her work (Yıldız, 2015). In the dimension of depersonalisation, the teacher can display a cynical and negative attitude towards students he/she serves (Nichols & Sosnowsky, 2002). Furthermore, teachers may display a rude attitude towards parents and colleagues (Wisniewski & Gargiulo, 1997). Another dimension of burnout is low sense of personal accomplishment. A sense of low personal accomplishment refers to the individual's self-evaluation dimension (Maslach et al., 2001). An individual with a low sense of personal accomplishment feels inadequate in his work and human relations (Budak & Sürgevil, 2005). In other words, teachers believe that they do not have enough professional responsibility towards their students, colleagues and students' families (Maslach et al., 2001).

Life satisfaction is individuals' holistic subjective evaluation of areas of their lives, such as family, environment, friends and self (Suldo et al., 2006). In other words, it is an individual's internal evaluation of his/her own life in a holistic framework. Life satisfaction does not refer to satisfaction with a particular situation or event. It expresses the satisfaction that an individual derives from his/her whole life in general (McDowell, 2010). Considered from this point of view, the concept of life satisfaction is a subjective concept, because the meaning that each individual attaches to and perceives for his life is different (Gülcan, 2014). Therefore, it is related to the individual's expectations from life and his/her own personal judgement regarding the ability to fulfil these expectations (Dost, 2007; Şimşek, 2011). There are six different components of life satisfaction: 1) the individual's income level, 2) his/her profession and social status, 3) the opportunities and social mobility that he/she has, 4) his/her welfare status, 5) the state policies of the country in which he/she lives, and 6) his/her environment, family and social relations (Appleton & Song, 2008). According to Köker (1991), life satisfaction is affected by variables such as the individual's age, gender, working conditions, education level, religious belief, race, salary, family life, social life, and personality traits. Since life satisfaction occurs as a result of the individual's evaluation of his/her life as a whole, it is likely that a teacher who is happy in his/her general life will also be happy in the teaching profession (Türker & Çelik, 2019). Moreover, teaching profession is one that provides direct service to people. For this reason, increasing teachers' quality of life will contribute to their life satisfaction. Teachers with high life satisfaction will also look after their students in a competent manner.

The concept of self-efficacy is based on Bandura's social learning theory. Bandura defined self-efficacy as an individual's beliefs in his/her abilities and performances as a result of his/her subjective evaluation (Bandura, 1994). Teacher self-efficacy is teachers' belief in their abilities to plan, organise and conduct the activities they will perform in order to achieve educational goals (Skaalvik & Skaalvik, 2007). According to Karahan and Uyanık-Balat (2011), Miller and McDaniel (1989) and Toy and Duru (2016), one of the teacher groups who are expected to have a high perception of teacher self-efficacy are teachers who work with inclusive students, since students with disabilities exhibit many behavioural problems. This situation

can make teachers more stressed and tense (Girgin & Baysal, 2005; Karahan & Uyanık-Balat, 2011). Consequently, they may experience a feeling of burnout and might not want to work (Şahin & Şahin, 2012). However, teachers with a high perception of self-efficacy will work with confidence in themselves. This sense of confidence will be reflected in the teacher's behaviours and teachers will use new methods and techniques for their students and carry out classroom management successfully (Tschannen-Moran & Hoy, 2001). High self-efficacy perception in a teacher plays an active role in developing positive attitudes towards teaching and students, feeling more competent, and coping with burnout (Sürgevil, 2006). On the other hand, teachers with a low self-efficacy perception are more concerned with non-academic subjects, see the problem in students when they themselves are unsuccessful, have difficulty in finding the necessary materials for education, and tend to avoid activities that they think will be beyond their own performance capabilities (Ülper & Bağcı, 2012). In summary, low self-efficacy perception can cause teachers to have problems in every task they encounter over time, and to become stressed and depressed (Pajares, 1996). Self-efficacy is affected by various variables such as (a) Performance Accomplishments, the individual's general idea about his/her own performance based on his/her past experiences, (b) Vicarious Experiences, the individual's belief that by being inspired by the successes of others by observing them, he/she will also be successful, (c) Verbal Persuasion, other individuals' speech about whether or not an individual will be successful by talking to him/her, and (d) Emotional States, situations such as the agitation, fear and tension experienced by the individual affect the individual's self-efficacy (Çapa et al., 2013).

Job satisfaction is the emotional response that individuals develop towards their job as a result of their individual evaluation of their job and work environment (Duxbury et al., 1984; Artıran et al., 2019). Job satisfaction increases when the characteristics of the job in which the individual works are similar to expectations of working individual from that job. In other words, the more the characteristics of the job and the expectations of the individual overlap, the higher the job satisfaction (Wright & Davis, 2003). On the other hand, job dissatisfaction emerges when the individual is not satisfied with his/her job and does not develop a positive attitude towards his/her job (Eğınli, 2009). One of the areas in which job satisfaction is examined is teaching profession. Teachers' job satisfaction can be defined as teacher's attitude towards student and school, or satisfaction or dissatisfaction that teachers feel towards their jobs (Vural, 2004). It is a desired and expected situation for teachers to have a high level of job satisfaction. A high level of job satisfaction in teachers increases quality of education. When teachers' job satisfaction level is high, their energy will be reflected positively on their students. In this way, quality of education will increase and more successful students will be educated (Şahin, 2013). In addition, a high level of job satisfaction in teachers contributes to the development of their competencies and skills (Ghavifekr & Pillai, 2016). However, teachers' job satisfaction levels may decrease after a time due to negative working conditions in their daily school life. As a result of this, absenteeism may begin to occur in teachers and a teacher who finds the opportunity may change his/her job (Akçamete et al., 2001). Teachers' job satisfaction is affected by various variables. These variables are relations with managers and colleagues, working conditions, working hours and teachers' individual characteristics

(Ghavifekr and Pillai, 2016), salary, responsibility given to the teacher, the job itself, security (Waters, 2013).

When we look at the literature, we can find studies reporting a positive relationship between life satisfaction and self-efficacy (Bigdeloo and Bozorgi, 2016; Çevik, 2017; Moksnes 2019; Telef, 2011), a positive relationship between life satisfaction and job satisfaction (Atabay 2020; Casteel, 2018; Hombrados-Mendieta and Cosano-Rivas, 2011; Stempien and Loeb, 2002; Telef, 2011) and a positive relationship between self-efficacy and job satisfaction (Buluç & Demir, 2015; Dinçer et al., 2017; Telef, 2011; Teltik, 2009). On the other hand, while there is a study examining the mediating role of burnout between self-efficacy and job satisfaction Hassan and Ibourk (2021), no study can be found that examines the mediating role of professional burnout between life satisfaction and job satisfaction.

This research has been conducted with teachers working in inclusive classrooms. The reason for this is that working with inclusive classes is more difficult than working with normally developing children. It is important to determine the variables that help teachers working in these classrooms to perform their duties in a competent manner and to generate solutions for these. Moreover, when examined in general, it is observed that among teachers, individuals with high life satisfaction and teacher self-efficacy levels are happier in their jobs and do their jobs more efficiently. In addition, it can be seen that professional burnout negatively affects life satisfaction, teacher self-efficacy and job satisfaction, and that teachers who experience burnout cannot contribute to students' education. For this reason, it can be stated in this study that high life satisfaction and teacher self-efficacy levels will reduce professional burnout and therefore increase teachers' job satisfaction. Furthermore, it is thought that the findings of this study will provide important data to educators, psychological counsellors and experts and contribute to future research findings. Therefore, the aim of this study was to examine the mediating role of professional burnout in the relationship between life satisfaction, teacher self-efficacy and job satisfaction of teachers working in inclusive classrooms. For this reason, answers to the following questions were sought:

1. Is there a mediating role of professional burnout in the relationship between self-efficacy and job satisfaction of teachers working in inclusive classrooms?
2. Is there a mediating role of professional burnout in the relationship between life satisfaction and job satisfaction of teachers working in inclusive classrooms?

Method

In this study, Structural Equation Modelling [SEM], one of the quantitative research designs, was used to examine the nature of the relationships between "life satisfaction", "teacher self-efficacy", "teacher professional burnout" and "job satisfaction". The theoretical basis of SEM is an approach used for observing causal relationships (Dursun & Kocagöz, 2010). Since the hypothesis model of research was measured with latent variables within the framework of correlation analysis, a latent variable structural equation modelling method was used in the study. In this section, information is given about participants, data collection tool and data analysis.

Figure 1.
Research Model

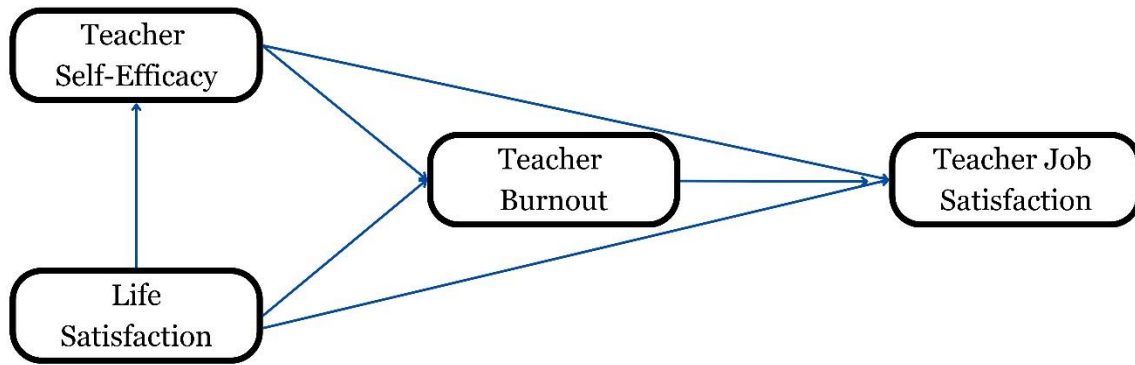

Study Group

Online forms were used to collect data. Data were obtained through the scales created on Google Form to participants who were integration students in their classes via social media or e-mail addresses. The research was conducted using scale data of 201 (160 female, 41 male) volunteer teachers.

Data Collection Tools

Life satisfaction scale, teacher self-efficacy scale, job satisfaction scale and teacher professional burnout scale were used to collect the data of this study.

Life Satisfaction Scale

This scale was developed by Diener, Emmons, Larsen and Griffin (1985) and adapted to Turkish by Dağlı and Baysal (2016), who also conducted the validity and reliability study of the scale. The original scale consists of five items and it is a five-point Likert-type scale. The scale is scored as “strongly disagree” (1), “slightly agree” (2), “moderately agree” (3), “strongly agree” (4), and “completely agree” (5). As a result of the validity-reliability study, the scale was created as a one-dimensional, five-item, five-point Likert-type scale similar to the original. Factor analysis was carried out to determine construct validity of the scale. As a result of exploratory factor analysis, the Kaiser-Meyer-Olkin [KMO] coefficient was calculated, and Bartlett’s test of sphericity was applied. As a result of this analysis, the KMO value was determined as .869. According to confirmatory factor analysis applied to the scale, ratio of chi-square to degree of freedom was $\chi^2/df=1.17$; values of NFI=.99, NNFI=1, SRMR=.019, RMSEA=.03, and GFI=.99. The Cronbach alpha coefficient of the scale was calculated as .88 and also test-retest reliability was found to be .97. In this study, it was found to be .87.

Teacher Self-Efficacy Scale

The Teacher Self-Efficacy Scale was developed by Tschannen-Moran and Hoy (2001) and adapted into Turkish by Çapa et al. (2005), and it is a Likert-type scale. The scale consists of 3 sub-dimensions, namely efficacy for student engagement (8 items), efficacy for instructional strategies (8 items), and efficacy for classroom management (8 items), and comprises a total of 24 items. The scale is a nine-point Likert-type scale. Scoring of the scale is as follows: “incompetent” (1), “slightly competent” (3), “somewhat competent” (5), “fairly competent” (7), and “very competent” (9). In the validity study of the scale, confirmatory factor

analysis and the Rasch measurement model were used. In the reliability study, the internal consistency coefficients of the scale were calculated, and in the Rasch analysis, it was observed that scale items had appropriate fit values. According to confirmatory factor analysis applied to the scale, ratio of chi-square ($\chi^2=393.57$) to degree of freedom ($df=249$, $p=.00$) was $\chi^2/df=1.45$; values of RMSEA=.077, CFI=.90 and GFI=.91 were determined. In addition, item-test correlations were observed to be between .50 and .71. The scale has three factors: “student engagement”, “instructional strategies” and “classroom management”. The Cronbach alpha reliability values for the dimensions of the scale are .82 for student engagement, .86 for instructional strategies, and .84 for classroom management. In this study, the values are .86, .90 and .92, respectively.

Job Satisfaction Scale

Job Satisfaction Scale was developed by Şahin (1999) and consists of 42 items. The scale is a three-point Likert-type scale and comprises a total of six sub-dimensions. These dimensions consist of Job Itself, Administration, Salary, Achievement-Prestige-Recognition [APR], Interpersonal Relations [IR], and Parent-Student Indifference [PSI] sub-dimensions. The scale is scored as “yes” (3), “partially” (2), and “no” (1). Negative items are reverse-scored. Since the scale consists of two intervals and three options, in order to interpret the arithmetic mean scores, an interval value of 66 was obtained by dividing the scale by the number of intervals. By adding one point to the obtained value, the range of 1-1.66 was accepted as “unsatisfying”, the range of 1.67–2.33 as “partially satisfying”, and the range of 2.34–3.00 as “satisfying”. The variance explained by the sub-dimensions of the scale is 11.12 in the Administration sub-dimension, 9.90 in the Salary sub-dimension, 9.00 in the IR sub-dimension, 8.73 in the Job Itself sub-dimension, 5.34 in the APR sub-dimension, and 5.29 in the PSI sub-dimension. The total variance explained by the scale is 49.4. The Cronbach alpha value of the scale is .91. In this study, the Cronbach alpha value was also found to be .88. In the sub-dimensions of the scale, the Cronbach alpha values were found to be .75 in the Job Itself sub-dimension, .89 in the Administration sub-dimension, .81 in the Salary sub-dimension, .78 in the APR sub-dimension, .74 in the IR sub-dimension, and .74 in the PSI sub-dimension. In this study, Cronbach alpha coefficients for each sub-dimension were .68; .88; .59; .68; .78; .69, respectively.

Teacher Professional Burnout Scale

Teacher Professional Burnout Scale, developed by Kaner et al. (2008), is a 5 point Likert-type scale. The scale consists of four sub-dimensions and 26 items. The sub-dimensions of the scale are Professional Burnout, Alienation from Students, Physical and Emotional Burnout and Alienation from Colleagues and Administrators sub-dimensions. The scale is scored as “describes me very well” (5), “describes me well” (4), “describes me a little” (3), “does not describe me very well” (2), and “does not describe me at all” (1). The authors performed exploratory factor analysis to test the construct validity of the scale. The variance explained by the four factors is 60.902%. In addition to, the authors was applied to 59 teachers together with Maslach Burnout Inventory to test concurrent validity of the scale, it. Correlation between total scores of the two scales was significant ($r=.60$, $p<.01$). Cronbach alpha internal consistency coefficients of the scale are .92 for the total scale, and for its sub-dimensions, .90 for

Professional Burnout, .87 for Alienation from Students, .86 for Physical and Emotional Burnout, and .80 for Alienation from Colleagues and Administrators. Cronbach alpha reliability value for this study is .86.

Data Collection

An online method through Google Forms was used to collect the data. The Demographic Information Form, Life Satisfaction Scale, Teacher Self-Efficacy Scale, Job Satisfaction Scale and Teacher Professional Burnout Scale were transferred to Google Forms. Created forms were sent to the classroom teachers via WhatsApp, Facebook, Instagram and e-mail between 12.01.2022 and 30.01.2022. After data collection, the data was uploaded and analysed.

Data Analysis

First, it was examined whether each variable showed a normal distribution or not. It is assumed that skewness and kurtosis values in the range of ± 2 ensure a normal distribution (Field, 2009; Gravetter & Wallnau, 2014; Trochim et al., 2015). Since the obtained values were in the range of ± 2 , the data were considered to show normal distribution. After this, case of multicollinearity was examined. Mahalanobis distance, Variance Inflation Factors [VIF] and tolerance values were examined with the regression equation created for this purpose. The fact that the largest Mahalanobis distance was 16.36 (< 20.515), the VIF value did not exceed 10, and the tolerance values were greater than .100 (Field, 2009) shows that there was no multicollinearity problem. Furthermore, since the correlation between the variables did not exceed .90 (Çokluk et al., 2014), it can be stated that there was no multicollinearity. Within the framework of these results, structural equation modelling was applied. For the structural equation model, χ^2/d value of below 3 (Hu and Bentler, 1999), RMSEA value of below .05 (Kline, 2005), and GFI, AGFI, TLI and CFI values of .90 and above (Brown, 2006) were taken as acceptable values.

Ethical Permits of Research:

In this study, all the rules specified to be followed within the scope of "Higher Education Institutions Scientific Research and Publication Ethics Directive" were complied with. None of the actions specified under the heading "Actions Contrary to Scientific Research and Publication Ethics", which is the second part of the directive, have been taken.

Ethics Committee Permission Information:

Name of the committee that made the ethical evaluation = Trakya University Rectorate Social and Human Sciences Research Ethics Committee

Date of ethical review decision=24.11.2021

Ethics evaluation document publication number=2021.09.07

Findings

Structural equation modelling was used to test the mediating relationship between teachers' life satisfaction and job satisfaction. Following the conceptual model that was created, when the two mediating variables of "teacher self-efficacy" and "teacher burnout" are taken into account, there is a direct relationship between teachers' life satisfaction and their job satisfaction (Figure 1). However, the hypothesised structural equation model did not generate acceptable values. Furthermore, the path from "teacher self-efficacy" to "teacher job satisfaction" did not emerge as significant. Therefore, this path was removed and the analysis was repeated. The results (Figure 2) show that teachers' life satisfaction significantly predicts their job satisfaction directly and indirectly ($\beta=.31$, $p<.05$). The constructed path model has acceptable fit values ($\chi^2/df=.62$, $p>.05$; GFI=.998; AGFI=.985, TLI=1, CFI=1, RMSEA=0). This means that teachers' life satisfaction increases their job satisfaction.

Table 1.

Direct, Indirect and Total Effect Results

Effects	Direct effect			Indirect effect			Total effect		
	Life satis-faction	Self-efficacy	Burnout	Life satis-faction	Self-efficacy	Burnout	Life satis-faction	Self-efficacy	Burnout
Self-efficacy	.22						.22		
burnout	-.23	-.46		-.10			-.33	-.46	
Job satisfaction	.31		-.60	.20	.27		.51	.27	-.60

Figure 2.

Path Analysis

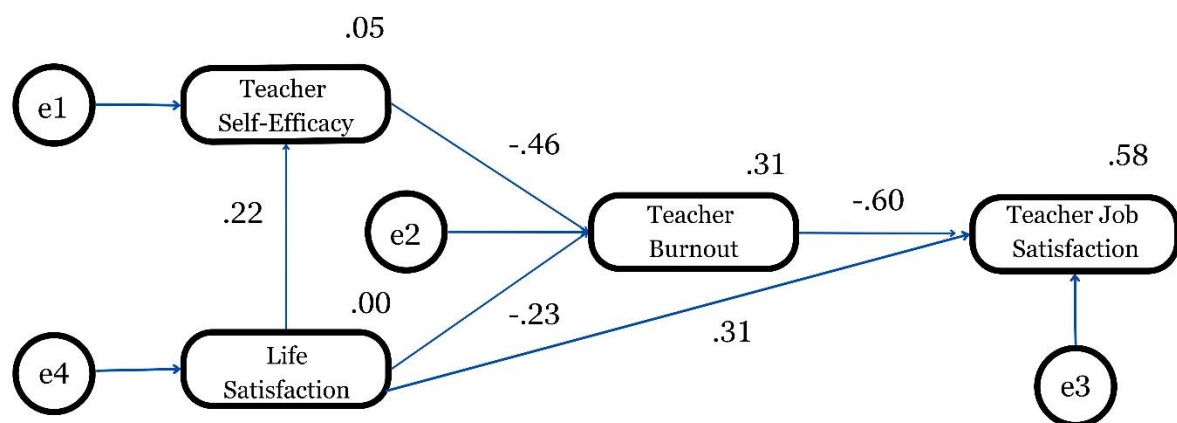

Moreover, the path analysis shows that "self-efficacy" and "burnout" also mediate the relationship between "life satisfaction" and "job satisfaction". There is a close relationship between "life satisfaction", "self-efficacy" ($\beta=.22$, $p<.05$) and "burnout", that is, when teachers' "life satisfaction" increases, their "self-efficacy" increases and their "burnout" decreases. The path coefficient from "burnout" to "job satisfaction" also produced significant results ($\beta=-.60$, $p<.05$). There is a relationship between "self-efficacy" and "job satisfaction", and this is

mediated by “burnout” ($\beta = .27, p < .05$). Overall, the results show that a decrease in “burnout” can increase the likelihood of teachers’ “job satisfaction”.

More specifically, when we examine the path analysis in Figure 2, teachers’ “self-efficacy” and “burnout” together mediate the relationship between “life satisfaction” and “job satisfaction” ($\beta =$ from life satisfaction to self-efficacy and burnout, and finally to job satisfaction $= .22 * (-.46) * (-.60) = .06, p < .05$). In addition to this, “burnout” has only a mediating role ($\beta =$ from life satisfaction to burnout and job satisfaction $= (-.23) * (-.60) = .14, p < .05$). When all these are taken into account, the path model results show that “life satisfaction” predicts “teacher job satisfaction” both directly ($\beta = .31, p < .05$) and indirectly ($\beta = .20 (= .6 + .14), p < .05$), which supports the view that teachers’ job satisfaction is related to their life satisfaction. The total effect of life satisfaction on teacher job satisfaction is $.51$ ($=$ direct effect $+$ indirect effect $= .31 + (.14 + .06)$). Together, these variables account for 58% of job satisfaction ($= [.31]^2 + [.06]^2 + [.14]^2 + [-.60]^2$) explain.

Discussion and Conclusion

The first finding of the study is the positive relationship observed between teachers’ life satisfaction and their professional self-efficacy. When the literature is examined, we can find studies investigating teachers’ life satisfaction and teacher professional self-efficacy. In his study conducted with teachers working in primary and secondary schools, Telef (2011) observed a weak positive relationship between teachers’ life satisfaction and teacher professional self-efficacy. Çelik and Kahraman (2018) observed a positive relationship between teachers’ life satisfaction and teacher professional self-efficacy in their study carried out with secondary school teachers. Similarly, Bigdeloo and Bozorgi (2016), Çevik (2017), and Moksnes et al. (2019) determined a positive relationship between teachers’ life satisfaction and teacher professional self-efficacy in their studies conducted with teachers. Individuals who feel competent about their individual abilities do not perceive the problems they encounter as dangers, and they tackle these. Individuals with a high perception of self-efficacy are undaunted by the problems they encounter and may even experience a sense of tranquillity (Pajares, 1996). Moreover, the individual’s living conditions and psychology are variables that affect his/her level of self-efficacy. Positive living conditions and a positive state of mind are observed in individuals with high self-efficacy levels (Bandura et al., 1996). In summary, the fact that individuals with high self-efficacy perceptions are happier and more at ease is a finding that does not contradict the literature. Teacher self-efficacy is teachers’ belief in their abilities to plan, organize and carry out activities to achieve educational goals (Skaalvik & Skaalvik, 2007). It is a desired and expected situation that teachers’ self-efficacy perception is high. When the teacher’s self-efficacy perception is high, he will contribute more to the education of his students. This will contribute positively to teachers’ professional satisfaction. It will contribute positively to the life satisfaction of teachers who are successful in their profession by reflecting on other areas of life such as family and health (Telef, 2011). In other words, high self-efficacy contributes to the development of teachers’ life satisfaction and does not play an important role in ensuring the continuation of life satisfaction (Vecchio et al., 2007). The second finding of the study is the positive relationship observed between life satisfaction and job satisfaction. When the literature is examined, we can see that there are

studies reporting a positive relationship between teachers' life satisfaction and their job satisfaction. Casteel (2018) and Stempien and Loeb (2002) stated that there is a positive relationship between life satisfaction and job satisfaction among special education teachers. In studies conducted by Atabay (2020) with kindergarten teachers, Hombrados-Mendieta and Cosano-Rivas (2011) with social workers, and Telef (2011) with primary and secondary school teachers, it was observed that job satisfaction increases as life satisfaction increases. According to the research results, it is natural to mention a positive relationship between life satisfaction and job satisfaction, because an individual spends a large part of his/her life at work. It is natural that being happy at work has a positive effect on life satisfaction. Berry (1997) stated in her research that life satisfaction and job satisfaction affect each other positively, and moreover that job satisfaction contributes positively to the institution where the individual works in the micro sense and to the state in the macro sense. There is a reciprocal and positive relationship between job satisfaction and life satisfaction (Judge & Watanabe, 1993). While job satisfaction is an important factor for the quality of work life, life satisfaction is an important factor for the quality of life as a whole (Rice et al., 1985). In other words, life satisfaction refers to the satisfaction an individual receives from his or her entire life in general (McDowell, 2010). In summary, since an individual's business life is one of the individual's living spaces, if life satisfaction is high, it will contribute positively to high job satisfaction by contributing to business life. According to Rice et al. (1985), an individual with high life satisfaction will also have high job satisfaction. The third finding observed in the study is the mediating role of professional burnout between teacher self-efficacy and job satisfaction. When we look at the literature, one study conducted with teachers can be found. In their study made with primary school teachers, Hassan and Ibourk (2021) observed that burnout has a mediating role between self-efficacy and job satisfaction. In addition, in a study made with individuals working in a state-owned enterprise, a full mediating role of self-assessment was observed in the relationship between job satisfaction and burnout (Örücü & Hasırcı, 2021). Furthermore, there are various studies examining the relationship between teacher self-efficacy, job satisfaction and professional burnout. In studies conducted with teachers by Wang et al. (2015), with special education teachers by Johnson (2010), and with individuals who attended a special education certificate course by Capri and Guler (2018), the researchers observed a positive relationship between job satisfaction and self-efficacy, and a negative relationship of burnout with job satisfaction and self-efficacy. According to the results of this study, an individual who regards him/herself as competent in the teaching profession does not experience professional burnout. As a result, he/she is happy in his/her work and experiences job satisfaction.

The third finding observed in the study is the mediating role of professional burnout between teacher self-efficacy and job satisfaction. When we look at the literature, one study conducted with teachers can be found. In their study made with primary school teachers, Hassan and Ibourk (2021) observed that burnout has a mediating role between self-efficacy and job satisfaction. In addition, in a study made with individuals working in a state-owned enterprise, a full mediating role of self-assessment was observed in the relationship between job satisfaction and burnout (Örücü & Hasırcı, 2021). Furthermore, there are various studies examining the relationship between teacher self-efficacy, job satisfaction and professional

burnout. In studies conducted with teachers by Wang et al. (2015), with special education teachers by Johnson (2010), and with individuals who attended a special education certificate course by Capri and Guler (2018), the researchers observed a positive relationship between job satisfaction and self-efficacy, and a negative relationship of burnout with job satisfaction and self-efficacy. According to the results of this study, the individual who regards him/herself as competent in the teaching profession does not experience professional burnout. As a result, he/she is happy in his/her work and experiences job satisfaction.

The fourth finding observed in the study is the mediating role of professional burnout between teacher self-efficacy and job satisfaction. When we look at the literature, one study conducted with teachers can be found. In their study made with primary school teachers, Hassan and Ibourk (2021) observed that burnout has a mediating role between self-efficacy and job satisfaction. In addition, in a study made with individuals working in a state-owned enterprise, a full mediating role of self-assessment was observed in the relationship between job satisfaction and burnout (Örücü & Hasırcı, 2021). Furthermore, there are various studies examining the relationship between teacher self-efficacy, job satisfaction and professional burnout. In studies conducted with teachers by Wang et al. (2015), with special education teachers by Johnson (2010), and with individuals who attended a special education certificate course by Capri and Guler (2018), the researchers observed a positive relationship between job satisfaction and self-efficacy, and a negative relationship of burnout with job satisfaction and self-efficacy. According to the results of this study, the individual who regards him/herself as competent in the teaching profession does not experience professional burnout. As a result, he/she is happy in his/her work and experiences job satisfaction. Professional self-efficacy levels and professional burnout in teachers are decreasing. Teachers whose professional self-efficacy levels increase can provide more qualified education (Telef, 2011). In addition, teachers' high self-efficacy levels will increase their job satisfaction positively. Teachers with high job satisfaction levels will also increase the quality of education. When teachers' job satisfaction level is high, their energy will reflect positively on their students. In this way, the quality of education will increase and more successful students will be raised (Şahin, 2013). As the fifth finding of the study, it was determined that professional burnout had a mediating role between teachers' life satisfaction and job satisfaction. When we examine the literature, there is no research that examines the mediating role of professional burnout between teachers' life satisfaction and job satisfaction. However, in studies carried out by Karaaslan et al. (2020) with physical education teachers, Telef (2011) with primary and secondary school teachers, Arslan and Acar (2013) with academics, Güner Çiçek and Can (2014) with bank employees, Michinov et al. (2010) with anesthetists, and Sivakcı (2019) with individuals working in the private sector, a positive relationship was observed between life satisfaction and job satisfaction, while a negative relationship of burnout with life satisfaction and job satisfaction was found. Individuals with high life satisfaction will feel competent in their profession. In this way, individuals' job satisfaction will also be higher.

Recommendations

This study observed that life satisfaction and teacher self-efficacy have a mediating role in the relationship between professional burnout and job satisfaction. In future studies, what other variables have a mediating role can be examined.

In future research, sources of teacher self-efficacy, life satisfaction and job satisfaction can be investigated. In addition, necessary in-service training can be given to increase these investigated variables.

Working with individuals with disabilities is difficult. Additionally, teachers may experience burnout if they do not know how to treat students with disabilities. For this reason, seminars can be given to teachers about the characteristics of individuals with disabilities, behavior modification, teaching methods, etc.

References

- Appleton, S., & Song, L. (2008). Life satisfaction in urban China: Components and determinants. *World Development*, 36(11), 2325-2340.
- Arslan, R., & Acar, B. N. (2013). A research on academics on life satisfaction, job satisfaction and professional burnout. *Suleyman Demirel University Journal of Faculty of Economics & Administrative Sciences*, 18(3), 2027-2040.
- Artan, İ., & Uyanık Balat, G. (2003). Okul öncesi eğitimcilerinin entegrasyona ilişkin bilgi ve düşüncelerinin incelenmesi [Knowledge and thoughts of the early childhood education teachers on integration]. *Kastamonu Education Journal*, 11(1), 65-80.
- Artıran, M., Ceren Er, A., & Artıran, H. M. (2019). Özel eğitim öğretmenlerinde negatif düşüncelerin tükenmişlik düzeyi ve iş doyumunu ile ilişkisi [The relationship between negative thoughts, burnout and work satisfaction in special education teachers]. *Elementary Education Online*, 18(4), 2027-2040.
- Atabay, E. (2020). *Tükenmişlik ile iş doyumunu arasındaki ilişkinin incelenmesi: Anaokulu öğretmenleri örnekleme* [Examining the relationship between burnout and job satisfaction: A sample of kindergarten teachers]. (Publication No. 642162) [Master thesis, İstanbul Gelişim University]. National Thesis Center.
- Bandura, A. (1994). Self-efficacy. In V. S. Ramachandran (Ed.), *Encyclopedia of human behavior* (pp.71-81). Academic.
- Batu, E. S. (2000). Kaynaştırma, destek hizmetler ve kaynaştırmaya hazırlık etkinlikleri [Mainstreaming, support services and inclusion preparation activities]. *Ankara University Faculty of Educational Sciences Journal of Special Education*, 2(4), 35-45.
- Batu, E. S., & Kırcaali-İftar G. (2005). *Kaynaştırma [Inclusion]* (1th ed.). Kök.
- Berry, L. M. (1997). *Psychology at work: An introduction to industrial and organizational psychology*. McGraw Hill Companies Inc.
- Bigdeloo, M., & Bozorgi, Z. D. (2016). *Relationship between the religious attitude, self-efficacy, and life satisfaction in high school teachers of Mahshahr city* (EJ1112683). ERIC. <https://eric.ed.gov/?id=EJ1112683>
- Billingsley, B. S., & Cross, L. H. (1991). Teachers' decisions to transfer from special to general to general education. *The Journal of Special Education*, 24(4), 496-511.
- Brown, T. A. (2006). *Confirmatory factor analysis for applied research*. Guilford.
- Budak, G., & Sürgevil, O. (2005). Tükenmişlik ve tükenmişliği etkileyen örgütsel faktörlerin analizine ilişkin akademik personel üzerinde bir uygulama [An application on academic staff on the analysis of burnout and organizational factors affecting burnout]. *Dokuz Eylül University Faculty of Economics and Administrative Sciences Journal*, 20(2), 95-108.
- Buluç, B., & Demir, S. (2015). İlk ve ortaokul öğretmenlerinin öz-yeterlik algıları ile iş doyumları arasındaki ilişki [The relationship between job satisfaction and self efficacy based on elementary and middle school teacher's perceptions]. *Ahi Evran University Journal of Kırşehir Education Faculty*, 16(1), 289-308.
- Camacho, D. A. (2017). *Applying a cognitive-behavioral model to conceptualize burnout and coping for teachers in urban schools* [Unpublished master thesis]. Loyola University.
- Capri, B., & Guler, M. (2018). Evaluation of burnout levels in teachers regarding socio-demographic variables, job satisfaction and general self-efficacy. *Eurasian Journal of Educational Research*, 18(74), 123-144.
- Casteel, C. L. (2018). *The relationship between certification type and burnout, perceived support, job satisfaction, and life satisfaction in special education teachers* [Unpublished master thesis]. Loyola University.

- Collie, R. J., Shapka, J. D., & Perry, N. E. (2012). School climate and social–emotional learning: Predicting teacher stress, job satisfaction, and teaching efficacy. *Journal of Educational Psychology, 104*(4), 1189–1204.
- Çapa Aydın, Y., Uzuntiryaki, E., Temli, Y., & Tarkın, A. (2013). Öz Yeterlik Kaynakları Ölçeği'nin Türkçe'ye uyarlanması [Adaptation of sources of Self-Efficacy Inventory into Turkish]. *Elementary Education Online, 12*(3), 749-758.
- Çelik, O. T., & Kahraman, Ü. (2018). The relationship among teachers' general self-efficacy perceptions, job burnout and life satisfaction. *Universal Journal of Educational Research, 6*(12), 2721-2729.
- Çevik, G. B. (2017). The roles of life satisfaction, teaching efficacy, and self-esteem in predicting teachers' job satisfaction. *Universal Journal of Educational Research, 5*(3), 338-346.
- Çokluk, Ö., Şekercioğlu, G., & Büyüköztürk, Ş. (2014). *Sosyal bilimler için çok değişkenli istatistik SPSS ve LISREL uygulamaları* [Multivariate statistics for social sciences SPSS and LISREL applications]. Pegem.
- Dinçer, B., Saracaloğlu, A. S., Karademir, Ç. A., & Dedeşali, N. C. (2017). Öğretmenlerin öğretim stilleri, öz yeterlik ve iş doyumlarının belirlenmesi [Determining teaching styles, self-efficacy beliefs and job satisfaction of teachers]. *Education Sciences, 12*(1), 58-85.
- Dost, M. T. (2007). Üniversite öğrencilerinin yaşam doyumunun bazı değişkenlere göre incelenmesi [Examining life satisfaction levels of university students in terms of some variables]. *Pamukkale University Journal of Education, 22*(22), 132-143.
- Dursun, Y., & Kocagöz, E. (2010). Yapısal eşitlik modellemesi ve regresyon: Karşılaştırmalı bir analiz [Structural equation modeling and regression: A comparative analysis]. *Erciyes University Journal of Economics and Administrative Sciences, 35*(1), 1-17.
- Duxbury, M., Armstrong, G., Drew, D., & Henley, S. (1984). Head nurse leadership style with staff burnout and job satisfaction in neonatal intensive care units. *Nursing Research, 33*, 97-101.
- Dworkin, A. (2001). Perspectives on teacher burnout and school reform. *International Education Journal, 4*(2), 69–78.
- Eğimli, A. T. (2009). Çalışanlarda iş doyumunu: Kamu ve özel sektör çalışanlarının iş doyumuna yönelik bir araştırma [Job satisfaction in employees: A research on job satisfaction of public and private sector employees]. *Trends in Business and Economics, 23*(3), 35-52.
- Ergül, C., Baydık, B., & Demir, S. (2013). Özel eğitim öğretmen adaylarının ve öğretmenlerinin zihin engelliler öğretmenliği lisans programı yeterliklerine ilişkin görüşleri [Profile of students in special education teaching undergraduate programs and their views on the field]. *Educational Sciences: Theory & Practice, 13*(1), 1-24.
- Field, A. (2009). *Discovering statistics using SPSS* (3rd ed.). Sage.
- Ghavifekr, S., & Pillai, N. S. (2016) The relationship between school's organizational climate and teacher's job satisfaction: Malaysian experience. *Asia Pacific Education Review, 17*, 87–106.
- Girgin, G., & Baysal, A. (2005). Tükenmişlik sendromuna bir örnek: Zihinsel engelli öğrencilere eğitim veren öğretmenlerin mesleki tükenmişlik düzeyi [An example for burnout: Special education educator's burnout level and some variables]. *TSK Koruyucu Hekimlik Bülteni, 4*(4), 172-187.
- Gravetter, F. J., & Wallnau, L. B. (2014). *Essentials of statistics for the behavioral sciences*. Wadsworth.
- Gülcan, A. (2014). *Genç yetişkinlerde iyimserliğin mutluluk ve yaşam doyumunu üzerindeki etkisinin incelenmesi* [The effect of optimism on happiness and life satisfaction on young adults]. (Publication No. 367982) [Master thesis, Fatih University]. National Thesis Center.
- Güner, F., Çiçek, H., & Can, A. (2014). Banka çalışanlarının mesleki stres ve tükenmişlik düzeylerinin iş doyumunu ve yaşam doyumunu düzeyleri ile ilişkisi [The relationship between the levels of occupational stress and burnout and the levels of job satisfaction and life satisfaction of employees]. *Journal of Alanya Faculty of Business, 6*(3), 59-76.
- Hassan, O., & Ibourk, A. (2021). Burnout, self-efficacy and job satisfaction among primary school teachers in Morocco. *Social Sciences & Humanities Open, 4*(1), 100-148.

- Hombrados-Mendieta, I., & Cosano-Rivas, F. (2011). Burnout, workplace support, job satisfaction and life satisfaction among social workers in Spain: A structural equation model. *International Social Work*, 56(2), 228-246.
- Hu, L., & Bentler, P. M. (1999). Cutoff criteria for fit indexes in covariance structure analysis: Conventional criteria versus new alternatives. *Structural Equation Modeling: A Multidisciplinary Journal*, 6(1), 1-55.
- Johnson, B. W. (2010). *Job satisfaction, self-efficacy, burnout and path of teacher certification: Predictors of attrition in special education teacher* (Publication No. 3403234) [Doctoral dissertation, Capella University]. ProQuest Thesis Center.
- Judge, T. A., & Watanabe, S. (1993). Another look at the job satisfaction-life satisfaction relationship. *Journal of Applied Psychology*, 78(6), 939-948.
- Kabasakal, E. (2018). *Kaynaştırma öğrencisi bulunan sınıflarda rasyonel duygucu eğitimin diğer öğrencilerin, rasyonel düşünme, öznel iyi oluş, öz yeterlilik ve sosyal kabul düzeyine etkisi* [The effect of rational emotive education on the rational thinking, subjective well-being, self-efficacy and social acceptance levels of the students who are not disabled in mainstream classes involving students with disabilities]. (Publication No. 510786) [Master thesis, Hacettepe University]. National Thesis Center.
- Kaner, S. (2010). Özel gereksinimli olan ve olmayan öğrencilerin öğretmenlerinin öz-yetkinlik inançları [Examining teachers' self-efficacy beliefs of students with and without special needs]. *Ankara University Journal of Faculty of Educational Sciences*, 43(1), 193-217.
- Kaner, S., Şekercioğlu G., & Yellice-Yüksel, B. (2008, May 14-16). *Öğretmen mesleki öz-yetkinlik ölçeği geliştirme çalışması* [Teacher professional self-efficacy scale development study]. [Conference presentation]. EPODDER, Ankara.
- Karaaslan, İ., Uslu, T., & Esen, S. (2020). Beden eğitimi öğretmenlerinin mesleki tükenmişlik, iş doyum ve yaşam doyumlarının incelenmesi [Research on occupational burnout, job satisfaction and life satisfaction of physical education teachers]. *Journal of Health and Sport Sciences*, 3(1), 7-18.
- Karahan, Ş., & Uyanık-Balat, G. (2011). Özel eğitim okullarında çalışan eğitimcilerin öz-yeterlilik algılarının ve tükenmişlik düzeylerinin incelenmesi [The analysis of self-efficacy perception and burnout level of special education school educators]. *Pamukkale University Journal of Education*, 29, 1-14.
- Kargin T. (2010). Özel gereksinimli öğrencilerin yerleştirilmesi ve BEP [Placement of students with special needs and BEP]. In A. Gönül Akçamete (Ed.), *Genel eğitim okullarında özel gereksinimi olan öğrenciler ve özel eğitim* [Students with special needs and special education in general education schools]. (pp. 77-109). Kök.
- Kline, R. B. (2005). *Principles and practice of structural equation modeling* (2nd ed.). Guilford.
- Koyutürk, N. (2014). *Sınıfta kaynaştırma öğrencisi olan ve olmayan okul öncesi öğretmenlerinin iş doyum ve tükenmişlik düzeylerinin belirlenmesi* [Determining the levels of the job satisfaction and burnout in pre-school teachers whose classes include or do not include students with special- needs]. (Publication No. 370245) [Master thesis, Mehmet Akif Ersoy University]. National Thesis Center.
- Köker, S. (1991). *Normal ve sorunlu ergenlerin yaşam doyum düzeyinin karşılaştırılması* [Comparison of life satisfaction levels of normal and problematic adolescents]. (Publication No. 16802) [Master thesis, Ankara University]. National Thesis Center.
- Marzano, R. J., & Marzano, J. S. (2003). The key to classroom management. *Educational Leadership*, 61(1), 6-17.
- Maslach, C., Schaufeli, W. B., & Leiter, M. P. (2001). Job burnout. *Annual Review of Psychology*, 52, 397-422.
- McDowell, I. (2010). Measures of self-perceived well-being. *Journal of Psychosomatic Research*, 69(1), 69-79.

- Miller, R., & McDaniel, E. A. (1989). Enhancing teacher efficacy in special education through the assessment of student performance. *Academic Therapy*, 25(2), 171-181.
- Ministry of National Education (MoNE). (2018). *Özel eğitim hizmetleri yönetmeliği* [Special education services regulation]. (No. 30471). Official Gazette. Retrieved January 2, 2023, from <https://www.mevzuat.gov.tr>
- Moksnes, U. K., Eilertsen, M. E. B., Ringdal, R., Bjørnsen, H. N., & Rannestad, T. (2019). Life satisfaction in association with self-efficacy and stressor experience in adolescents—self-efficacy as a potential moderator. *Scandinavian Journal of Caring Sciences*, 33(1), 222-230.
- Moore, J. E. (2000). Why is this happening? A causal attribution relationship to work exhaustion consequences. *Academy of Management Review*, 25(2), 335-349.
- Nichols, A. S., & Sosnowsky, F. L. (2002). Burnout among special education teachers in self-contained cross-categorical classrooms. *Teacher Education and Special Education*, 25(1), 71-86.
- Ören, N., & Türkoğlu, H. (2006). Öğretmen adaylarında tükenmişlik [The exhaustion levels of teacher candidate]. *Journal of Social Sciences and Humanities Researches*, 16, 1-10.
- Örücü, E., & Hasırcı, I. (2021). İş tatmini ve tükenmişlik ilişkisinde öz kendilik değerlendirmesinin aracı rolü ve bir uygulama [The role of self evaluation in job satisfaction and burnout relationship and an application]. *Academic Review of Economics and Administrative Sciences*, 14(4), 1172-1189.
- Pajares, M. F. (1996). Self-efficacy beliefs in academic settings [Electronic version]. *Review of Educational Research*, 66, 543-578.
- Rice, R. W., McFarlin, D. B., Hunt R. G., & Near, J. P. (1985). Job importance as a moderator of the relationship between job satisfaction and life satisfaction. *Basic and Applied Social Psychology*, 6(4), 297-316.
- Roelofs, J., Verbraak, M., Keijsers, G. P. J., de Bruin, M. B. N., & Schmidt, A. J. M. (2005). Psychometric properties of a Dutch version of the maslach burnout inventory general survey [MBI-DV] in individuals with and without clinical burnout. *Stress and Health: Journal of the International Society for the Investigation of Stress*, 21(1), 17-25.
- Sharma, U., Loreman, T., & Forlin, C. (2011). Measuring teacher efficacy to implement inclusive practices. *Journal of Research in Special Educational Needs*, 1-10.
- Shulman, L. S. (1986). Those who understand: Knowledge growth in teaching. *Educational Researcher*, 15(2), 4-14.
- Sıvakçı, S. (2019). *Tükenmişlik sendromunun ve iş doyumunun yaşam doyumunu ile ilişkisi: Özel sektör çalışanları üzerinde bir araştırma* [The relationship of burnout syndrome and job satisfaction with life satisfaction: A study on private sector employees]. (Publication No. 557235) [Master thesis, İstanbul Sabahattin Zaim University]. National Thesis Center.
- Skaalvik, E. M., & Skaalvik, S. (2007). Dimensions of teacher self-efficacy and relations with strain factors, perceived collective teacher efficacy, and teacher burnout. *Journal of Educational Psychology*, 99(3), 611-625.
- Soodak, L. C., Podell, D. M., & Lehman, L. R. (1998) Teacher, student, and school attributes as predictors of teachers' responses to inclusion. *Journal of Special Education*, 31(4), 480-497.
- Stempien, L. R., & Loeb, R. C. (2002). Difference in job satisfaction between general education and special education teachers: Implications for retention. *Remedial and Special Education*, 23(5), 258-267.
- Suldo, S. M., Riley, K. N., & Shaffer, E. J. (2006). Academic correlates of children and adolescents' life satisfaction. *School Psychology International*. 27(5), 567-582.
- Sürgevil, O. (2006). *Çalışma hayatında tükenmişlik sendromu* [Burnout syndrome in working life] (2th ed.). Nobel.
- Şahin, F., & Şahin, D. (2012). Engelli bireylerle çalışan özel eğitim öğretmenlerinin tükenmişlik düzeyinin belirlenmesi [Examining the burn-out level of special education teachers working with disabled individuals]. *Journal of Teacher Education and Educators*, 1(2), 275-294.

- Şahin, İ. (1999). *İlköğretim okullarında görevli öğretmenlerin iş doyum düzeyleri* [Job satisfaction levels of primary school teachers]. [Unpublished master thesis]. Dokuz Eylül University.
- Şahin, İ. (2013). Öğretmenlerin iş doyumları düzeyleri [Job satisfaction levels of teachers]. *Van Yüzüncü Yıl University Journal of Education*, 10(1), 142-167.
- Şimşek, E. (2011). *Örgütsel iletişim ve kişilik özelliklerinin yaşam doyumuna etkileri* [The effects of organizational communication and personality traits on life satisfaction]. (Publication No. 286778) [Master thesis, Anadolu University]. National Thesis Center.
- Telef, B. B. (2011). Öğretmenlerin öz-yeterlikleri, iş doyumları, yaşam doyumları ve tükenmişliklerinin incelenmesi [The study of teachers' self-efficacy, job satisfaction, life satisfaction and burnout]. *Elementary Education Online*, 10(1). 91-108.
- Teltik, H. (2009). *Okul öncesi öğretmenlerinin mesleki yeterlilik algılarının iş doyum ve tükenmişlik düzeyleriyle ilişkisinin belirlenmesi* [The determination of teacher self-efficacy perception between job satisfaction and burnout level correlations for preschool teachers]. (Publication No. 250821) [Master thesis, Marmara University]. National Thesis Center.
- Toy, S. N., & Duru, S. (2016). Sınıf öğretmenlerinin öğretmen öz yeterlikleri ile kaynaştırma eğitime ilişkin yeterlik inançlarının karşılaştırılması [The comparison of self-efficacy and inclusive education beliefs of primary school teachers]. *Ege Journal of Education*, 17(1), 146-173.
- Trochim, W. M., Donnelly, J. P., & Arora, K. (2015). *Research methods: The essential knowledge base*. Nelson Education.
- Tschannen-Moran, M., & Woolfolk Hoy, A. (2001). Teacher efficacy: Capturing an elusive construct. *Teaching and Teacher Education*, 17, 783-805.
- Tuğrul, B., & Çelik, E. (2002). Normal çocuklarla çalışan anaokulu öğretmenlerinde tükenmişlik [Burnout in kindergarten teachers working with normal children]. *Pamukkale University Journal of Education*, 2(12), 1-11.
- Türker, Y., & Çelik, K. (2019). Öğretmenlerde iş ve aile çatışmasının yaşam doyum üzerindeki etkisinde iş doyumunun aracı rolü [Mediating role of job satisfaction in the effect of work and family conflict on teachers' satisfaction with life]. *Hacettepe University Journal of Education*, 4(1), 242-258.
- Ülper, H., & Bağcı, H. (2012). Türkçe öğretmeni adaylarının öğretmenlik mesleğine dönük öz yeterlik algıları [Self-efficacy perceptions of Turkish teacher candidates towards the teaching profession]. *Turkish Studies*, 7(2), 1115-1131.
- Vecchio, G. M., Gerbino, M., Pastorelli, C., Del Bove, G., & Caprara, G. V. (2007). Multi-faceted self-efficacy beliefs as predictors of life satisfaction in late adolescence. *Personality and Individual Differences*, 43(7), 1807-1818.
- Vural, B. (2004). *Yetkin-ideal-vizyoner öğretmen* [Competent-ideal-visionary teacher] (2th ed.). Hayat.
- Wang, H., Hall, N. C., & Rahimi, S. (2015). Self-efficacy and causal attributions in teachers: Effects on burnout, job satisfaction, illness, and quitting intentions. *Teaching and Teacher Education*, 47, 120-130.
- Waters, K. K. (2013). *The relationship between principals' leadership styles and job satisfaction as perceived by primary school teachers across NSW independent schools* [Unpublished doctoral dissertation]. University of Wollongong.
- Wisniewski, L., & Gargiulo, R. M. (1997). Occupational stress and burnout among special educators: A review of the literature. *The Journal of Special Education*, 31(3), 225-346.
- Wright, B. E., & Davis, B. S. (2003). Job satisfaction in the public sector the role of the work environment. *The American Review of Public Administration*, 33(1), 70-90.
- Yıldız, S. M. (2015). *Lider-üye etkileşimi, işyerinde mobbing ve mesleki tükenmişlik ilişkisi* [Relationship between leader-member interaction, mobbing at workplace and occupational burnout] (2th ed.). Detay.

Yiğit, A. (2007). *Özel eğitim kurumlarında çalışan öğretmenlerin iş doyumunu, tükenmişlik ve ruh sağlığı düzeylerinin çeşitli değişkenler açısından incelenmesi* [The works satisfaction of the teachers who works in the private educational institutes the searching the level of burnout and the healthy of soul in dint of wary changable factors]. (Publication No. 209320) [Master thesis, Niğde University]. National Thesis Center.

BIOGRAPHICAL NOTES

Contribution Rate of Researchers

Author 1: 50%

Author 2: 50%

Conflict Statement

There is no conflict of interest that the authors will declare in the research.

Kaynaştırma Sınıflarında Çalışan Öğretmenlerin Yaşam Doymu, Öğretmen Öz Yeterliği ve İş Doymu İlişkisinde Mesleki Tükenmişliğin Aracılı Rolü



Özet

Bu çalışmanın amacı, kaynaştırma sınıflarında çalışan öğretmenlerin yaşam doymu, öğretmen öz yeterliği ve iş doymu arasındaki ilişkide mesleki tükenmişliğin aracılık rolünü incelemektir. Araştırmada yapısal eşitlik modeli yöntemi kullanılmıştır. Araştırmaya kaynaştırma sınıflarında görev yapan toplam 201 gönüllü öğretmen katılmıştır. Araştırma verilerin toplanması için Yaşam Doymu Ölçeği, Öğretmen Öz-Yeterlik Ölçeği, İş Doymu Ölçeği ve Öğretmen Mesleki Tükenmişlik Ölçeği kullanılmıştır. Araştırma verilerinin toplanmasında Google Forms yazılımı kullanıldı. Google Formlar üzerinde oluşturulan ölçekler öğretmenlere WhatsApp, Facebook, Instagram ve e-posta yoluyla iletildi. Elde edilen verilere normallik testi uygulanmış ve verilerin normal dağıldığı görülmüştür. Araştırma sonuçlarına göre öğretmenlerin yaşam doymu düzeyleri ile mesleki öz yeterlilik düzeyleri arasında pozitif, yaşam doymu düzeyleri ile iş doymu arasında pozitif, öz yeterlilik düzeyleri ile mesleki tükenmişlik arasında negatif, yaşam doymu düzeyleri ile mesleki tükenmişlik arasında negatif ve mesleki tükenmişlik düzeyleri ile iş doymu arasında negatif ilişki bulunmuştur. Sonuçlar öğretmen öz yeterliği ile iş tatmini arasında herhangi bir ilişki ortaya koymamıştır. Öğretmenlerin mesleki tükenmişliğinin sadece öz yeterlilik ile iş doymu arasındaki ilişkide değil, aynı zamanda yaşam doymu ile iş doymu arasındaki ilişkide de aracı rol oynadığı görülmüştür. İlerideki çalışmalarda diğer değişkenlerin aracılık rolü incelenebilir.

Anahtar Kelimeler: Yaşam doymu, öğretmen öz yeterliği, iş doymu, mesleki tükenmişlik, kaynaştırma.

Giriş

Özel eğitim ihtiyacı olan bireyler akranlarına göre farklı eğitim ihtiyaçları bulunmaktadır. Bu sebeple Özel eğitim ihtiyacı olan bireylerin bireysel özelliklerine uygun hazırlanmış eğitim ortamlarına ihtiyaç duymaktadırlar (Kargın, 2010). Bu eğitim ortamları Özel Eğitim Hizmetleri Yönetmeliği'ne (Millî Eğitim Bakanlığı [MEB], 2018) göre; özel eğitim okullarında, kaynaştırma/bütünleştirme yoluyla akranları ile birlikte aynı sınıfta tam zamanlı veya özel eğitim sınıflarında yarı zamanlı olarak eğitimlerini sürdürebilmektedir. Bunun yanında özel eğitim ihtiyacı olan bireylerin hangi ortamlarda eğitim alacaklarını aynı yönetmeliğin 11. maddesinde öğrencilerin en az sınırlandırılmış eğitim ortamlarına yönlendirilmeleri gerektiği belirtilmektedir. En az sınırlandırılmış eğitim ortamı ise özel eğitim ihtiyacı olan bütün öğrencilerin; ailesi ve akranlarıyla en fazla birlikte olabileceği, olağan gelişim gösteren akranlarıyla aynı ortamlarda eğitim alabileceği ve aynı zamanda eğitim ihtiyaçlarının en iyi şekilde karşılandığı ortamları olarak ifade edilmektedir (Batu & Kırçalı-İftar, 2005). Buna karşın kaynaştırma öğrencileri kaynaştırma ortamına geldiklerinde olağan gelişim gösteren çocuklardan farklı ihtiyaçları gözlenebilmekte ve sınıf ve okul ortamlarında çeşitli sorunlar yaşayabilmektedirler. Bu sebeple kaynaştırma öğrencisiyle çalışan öğretmenlerde bu öğrencilerle çalışacak yeterliliğin olması en önemli konudur (Marzano & Marzano, 2003). Başka bir deyişle kaynaştırma uygulamasının en önemli öğesinin öğretmen olduğu görülmekte ve öğretmene büyük görevler düşmektedir (Batu, 2000).

Öğretmenlik mesleği, bizlerin geleceği olan çocukların yetiştirilmesi ve eğitilmeleri açısından önemli bir meslek alanıdır. Öğretmenlik mesleği alan ve meslek bilgisi ediniminin yanında özveri, hoşgörü, sürekli kendini yenileme, mesleği severek yerine getirme gibi özellikleri de gerektiren bir meslektir (Ergül vd., 2013). Özellikle alan bilgisinin özveri, hoşgörü, mesleği severek yapmanın önemli olduğu öğretmenlik ise kaynaştırma öğrencileriyle çalışan öğretmenlik alanıdır. Çünkü yetersizliği olan öğrencilerle çalışmak olağan gelişim gösteren çocuklarla çalışmaktan daha zordur. Yetersizliği olan bireylerde yoğun davranış problemleri görülmekte, sosyal ve dil becerilerinde gerilikler ve akademik becerilerde sınırlılıklar gözlenebilmektedir (Billingsley & Cross 1991). Bu sebeplerden dolayı öğretmenler kendilerini yetersiz hissetmektedirler (Billingsley & Cross 1991; Koyutürk, 2014). Bu yoğun davranış ve öğrenme sorunlarından dolayı kaynaştırma öğrencisiyle çalışan öğretmenlerde tükenmişlik duygusu görülebilmektedir. Kaynaştırma öğrencileriyle çalışan öğretmenlerin tükenmişlik duygusu yaşamaması için öğretmenlerde mesleki öz-yeterlilik (Kabasakal, 2018; Koyutürk, 2014; Soodak vd., 1998) ve yaşam doyumunun (Kabasakal, 2018; Koyutürk, 2014) yüksek olması gerekmektedir. Mesleki öz-yeterlilik ve yaşam doyumunun (Koyutürk, 2014) yüksek olması ise öğretmenin kaynaştırma uygulamalarında olumlu tavır sergilemesini sağlayacaktır (Sharma vd., 2011).

Tükenmişlik sendromu genellikle insanlarla yüz yüze çalışmak zorunda olan kişilerde daha fazla görülmektedir (Tuğrul & Çelik, 2002). Tükenmişlik sendromunun görüldüğü alanlardan biri de öğretmenlik mesleğidir. Tükenmişlik duygusu, öğretmenlerin iş verimliliğini ciddi anlamda olumsuz olarak etkilemekte, öğretmenler işlerine karşı olumsuz tutum geliştirmekte, daha az iş tatmini yaşamakta, daha az istek ile işe gitmekte ve sürekli kendilerini yorgun hissetmektedirler (Dworkin, 2001). Bunun yanında tükenmişlik duygusu yaşayan öğretmenler sınıflarda sürekli sorun yaşamakta, başa çıkma stratejilerini kullanmakta başarısız olmakta (Camacho, 2017), görevleri ihmal etmekte, mesleklerinde kendilerini yetersiz hissetmekte ve sonuç olarak da işten ayrılma durumuna gelebilmektedirler (Collie vd., 2012). Tükenmişlik alanyazınında duygusal tükenmişlik, duyarsızlaşma ve düşük kişisel başarı duygusu olmak üzere üç boyutta incelenmektedir (Maslach vd., 2001; Yiğit, 2007).

Yaşam doyumunu, bireylerin yaşamını; aile, çevre, arkadaşlar ve benlik gibi yaşam alanlarını bir bütün olarak öznel değerlendirmesidir (Suldo vd., 2006). Farklı bir ifade ile bireyin kendi yaşamını bütüncül bir çerçevede ve içsel olarak değerlendirmesidir. Yaşam doyumunu, belirli bir durum ve olaya ilişkin doyumunu ifade etmemektedir. Bireyin genel olarak tüm yaşamından aldığı doyumunu ifade etmektedir (McDowell, 2010). Bu açıdan bakıldığında yaşam doyumunu kavramı öznel bir kavramdır. Çünkü her bireyin yaşamına yüklediği ve algıladığı anlam farklıdır (Gülcan, 2014). Bu sebeple bireyin, hayattan beklentileri ve bu beklentilerini gerçekleştirebilmesine ilişkin kendi kişisel yargısıyla ilişkilidir (Dost, 2007; Şimşek, 2011; Özcan, 2008). Öğretmenlik mesleği insanlara doğrudan hizmet veren bir meslektir. Bu sebeple öğretmenlerin yaşam kalitesini yükseltmek onların yaşam doyumuna katkı sağlayacaktır. Yaşam doyumunu yüksek olan öğretmenler de öğrencileriyle nitelikli bir şekilde ilgileneceklerdir.

Öğretmen öz-yeterliliği öğretmenlerin eğitim hedeflerine ulaşmak amacıyla yapılacak etkinlikleri planlama, organize etme ve yürütmek için yeteneklerine olan inançlarıdır (Skaalvik

& Skaalvik, 2007). Öz-yeterlik algısı yüksek olan öğretmenler kendilerine güven duyarak çalışacaklardır. Bu güven duygusu öğretmenin davranışlarına yansıtacak ve öğretmenler öğrencileri için yeni yöntem ve teknikler kullanacak ve sınıf yönetimini başarıyla gerçekleştireceklerdir (Tschannen-Moran & Hoy, 2001). Öğretimde öz-yeterlik algısının yüksek olması öğretime ve öğrencilere karşı pozitif tutum geliştirmesine kendini daha yeterli hissetmesine ve tükenmişlik duygusuyla baş etmesinde etkin rol oynamaktadır (Sürgevil, 2006).

İş doyumunu, bireyin çalıştığı işte, işini ve iş çevresini bireysel değerlendirmesi sonucu işine karşı geliştirdiği duygusal tepkidir (Artıran vd., 2019; Duxbury vd., 1984). İş doyumunu, bireyin çalıştığı işin özellikleriyle, çalışan bireyin işten beklentileriyle benzer olması durumunda yükselir. Farklı bir ifade ile çalışılan işin özellikleriyle bireyin beklentileri ne kadar örtüşürüyorsa iş doyumunu o kadar yüksek olmaktadır (Wright & Davis, 2003). Öğretmenler iş doyumunu ise öğretmenin öğrenciye ve okuluna karşı tutumu veya öğretmenlerin işlerinden duydukları hoşnutluk ya da hoşnutsuzluk olarak tanımlanabilir (Vural, 2004). Öğretmenlerde iş doyum düzeyinin yüksek olması istenen ve beklenen bir durumdur. Öğretmenlerin iş doyum düzeyi yüksek olması eğitimin kalitesini artırır. Öğretmenlerin iş doyum düzeyi yüksek olunca enerjisi öğrencilerine olumlu yansıtacaktır. Böylelikle eğitimin niteliği artacak ve daha başarılı öğrenciler yetişecektir (Şahin, 2013).

Bu araştırma kaynaştırma sınıfında çalışmakta olan öğretmenlerle yapılmaktadır. Bunun sebebi ise kaynaştırma sınıflarıyla çalışmanın olağan gelişim gösteren çocuklarla çalışmaktan daha zor olmasıdır. Bu sınıflarda çalışan öğretmenlerinin görevlerini nitelikli bir şekilde yapmalarına yardımcı olan değişkenlerin belirlenmesi ve bunlara dair çözümler üretilmesi açısından önemlidir. Bunun yanında genel olarak baktığımızda öğretmenlerde yaşam doyumunu ve öğretmen öz-yeterlik düzeyi yüksek olan bireylerin işlerinde daha mutlu oldukları ve işlerini daha nitelikli yaptıkları gözlenmektedir. Ayrıca mesleki tükenmişliğin ise yaşam doyumunu, öğretmen öz-yeterliği ve iş doyumunu olumsuz etkilediği ve tükenmişlik yaşayan öğretmenlerin öğrencilerin eğitimine katkı sağlayamadıkları gözlenmektedir. Bu sebeple bu çalışmada yaşam doyumunun ve yüksek öğretmen öz-yeterlik düzeyinin mesleki tükenmişliği azaltacağı ve dolayısıyla öğretmenlerin iş doyumunu arttıracacağı belirtilebilir. Ek olarak bu araştırma sonuçlarının eğitimciler, psikolojik danışmanlara ve uzmanlara önemli veri sağlayacağı ve ileriki araştırma bulgularına katkı sağlayacağı düşünülmektedir.

Yöntem

Bu çalışmada, Yaşam Doyumu, Öğretmen Öz-Yeterlik, Öğretmen Mesleki Tükenmişlik ve İş Doyumu arasındaki ilişkilerin doğasını incelemek için bir nicel araştırma tasarımlarından Yapısal Eşitlik Modelleri [YEM] kullanılmıştır.

Çalışma Grubu

Araştırma 201 (160 kadın, 41 erkek) gönüllü öğretmenin ölçek verileri kullanılarak gerçekleştirilmiştir. Verileri toplamak için çevrimiçi formlar kullanılmıştır.

Veri Toplama Araçları

Bu araştırmada verilerin toplanması için Demografik Bilgi Formu, Yaşam Doyum Ölçeği, Öğretmen Öz-Yeterlik Ölçeği, İş Doyum Ölçeği ve Öğretmen Mesleki Tükenmişlik Ölçeği kullanılmıştır.

Verilerin Toplanması

Verilerin toplanması için Google Forms ile çevrimiçi yöntem kullanılmıştır. Demografik Bilgi Formu, Yaşam Doyum Ölçeği, Öğretmen Öz-Yeterlik Ölçeği, İş Doyum Ölçeği ve Öğretmen Mesleki Tükenmişlik Ölçeği Google Forms'a aktarılmıştır. Oluşturulan form 12.01.2022 ile 30.01.2022. tarihleri arasında kaynaştırma sınıflarında çalışan öğretmenlere whatsapp, facebook, instagram ve e-mail yöntemi ile gönderilmiştir.

Verilerin Analizi

Öncelikle her bir değişkenin normal dağılım gösterip göstermediğine bakılmıştır. Skewness ve kurtosis değerlerinin ± 2 aralığında olması durumunda normal dağılım sağladığı (Field, 2009; Gravetter ve Wallnau, 2014; Trochim vd., 2015) varsayılmıştır. Elde edilen değerler ± 2 aralığında olduğu için veriler normal dağılımı gösterdiği değerlendirilmiştir. Bundan sonra ise çoklu bağlantı (multicollinearity) durumu incelenmiştir. Bu amaçla oluşturulan regresyon denklemi ile Mahalanobis Mesafesi (Mahalanobis distance), varyans artırıcı faktör Variance Inflation Factors [VIF] ve Tolerance değerleri incelenmiştir. En büyük Mahalanobis distance 16.36 (< 20.515), VIF değerinin 10'u geçmemesi ve Tolerance değerlerinin .100'den büyük olması (Field, 2009) çok bağlantı probleminin olmadığını göstermektedir. Bununla birlikte değişkenler arasındaki korelasyon .90 geçmediğinden (Çokluk vd., 2014) çok bağlantı probleminin olmadığı ifade edilebilir. Bu sonuçlar çerçevesinde yapısal eşitlik modeli uygulanmıştır. Yapısal eşitlik modeli için χ^2/d değerinin 3'ün altında olması (Hu ve Bentler, 1999), RMSEA değerinin .05 altında olması (Kline, 2005), GFI, AGFI, TLI ve CFI değerlerinin .90 ve üstü (Brown, 2006) olması kabul edilebilir değerler olarak alınmıştır.

Araştırmanın Etik İzinleri:

Bu çalışmada "Yükseköğretim Kurumları Bilimsel Araştırma ve Yayın Etiği Yönergesi" kapsamında uyulması gerektiği belirtilen tüm kurallara uyulmuştur. Yönergenin ikinci bölümü olan "Bilimsel Araştırma ve Yayın Etiğine Aykırı Eylemler" başlığı altında belirtilen eylemlerin hiçbiri gerçekleştirilmemiştir.

Etik Kurul İzin Bilgileri:

Etik değerlendirmeyi yapan kurulun adı = Trakya Üniversitesi Rektörlük Sosyal ve Beşeri Bilimler Araştırmaları Etik Kurulu

Etik kurul etik inceleme karar tarihi= 24.11.2021

Etik değerlendirme belgesi konu numarası= 2021.09.07

Bulgular

Öğretmenlerin yaşam doyumu ile mesleki doyumları arasındaki aracı ilişkiyi test etmek için yapısal eşitlik modeli kullanıldı. Oluşturulan kavramsal modeli takiben, iki aracı değişken

“öğretmen öz-yeterliği” ve “öğretmen tükenmişliği” düşünüldüğünde, öğretmenlerin yaşam doyumu ile mesleki doyumları arasında doğrudan bir ilişki vardır (Şekil 1). Varsayılan model yapısal eşitlik modeli kabul edilebilir değerleri üretmemiştir. Bununla birlikte öğretmen öz-yeterliği den öğretmenlerin mesleki doyumlarına giden yol anlamlı çıkmamıştır. Bu yol çıkartılarak analiz tekrarlanmıştır. Sonuçlar (Şekil 2) öğretmenlerin yaşam doyumları anlamlı bir biçimde direk ve dolaylı olarak mesleki doyumu tahmin ettiğini ($\beta=.31$, $p<.05$) göstermektedir. Oluşturulan yol modeli kabul edilebilir uyum değerlerine sahiptir ($\chi^2/df=.62$, $p>.05$; GFI=.998; AGFI:.985, TLI:1, CFI:1, RMSEA:0). Bu öğretmenlerin yaşam doyumlarının mesleki doyumlarını arttırdığı anlamına gelmektedir.

Şekil 1.

Araştırma Modeli

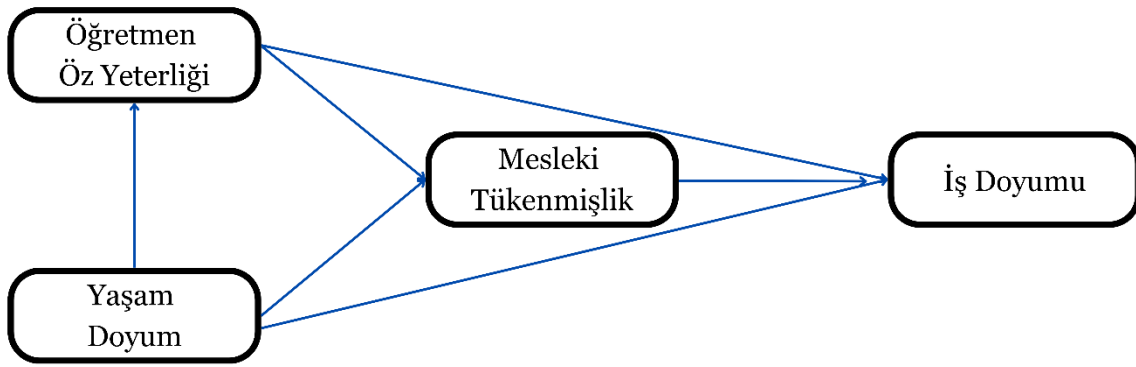

Şekil 2.

Path Analizi

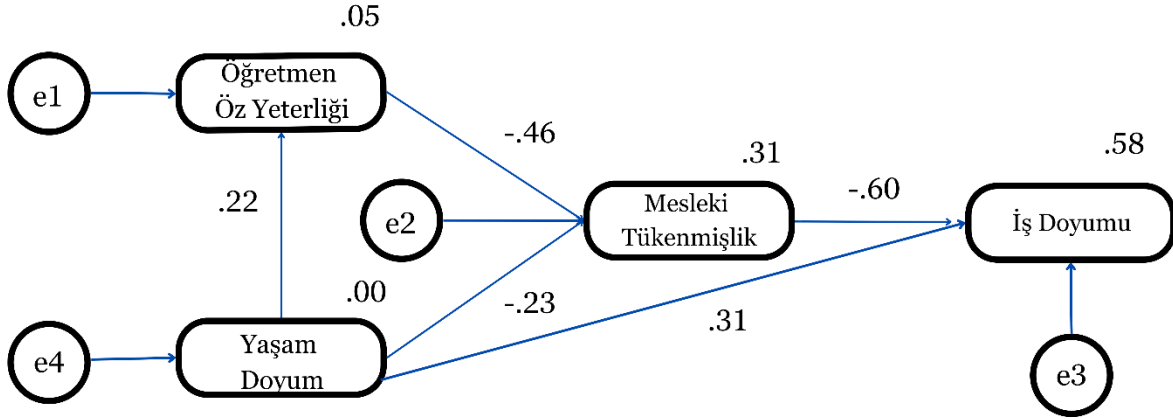

Ayrıca yol analizi “yaşam doyumu” ile “mesleki doyum” arasındaki ilişkiye “öz-yeterliğin” ve “tükenmişliğin” de aracılık ettiğini gösterir. “Yaşam doyumu” ile “öz-yeterlik” ($\beta=.22$, $p<.05$) ve “tükenmişlik” arasında yakın bir oranda ilişki vardır, yani, “yaşam doyumu” arttığında, öğretmenlerin öz-yeterlikleri artmakta ve “tükenmişlikleri” azalmaktadır. Tükenmişlikten mesleki doyuma giden yol katsayısı da anlamlı sonuçlar üretmiştir ($\beta=-.60$, $p<.05$). Öz-yeterlik ile meslek doyumları arasında ilişki var olup bu tükenmişlik aracılığı ile gerçekleşmektedir ($\beta=.27$, $p<.05$). Genel olarak sonuçlar, tükenmişliğin azalmasının öğretmenlerin iş doyumu olasılığını artırabileceğini göstermektedir.

Daha özel olarak, öğretmenlerin öz-yeterliği ve tükenmişlikleri, yaşam doyumu ile mesleki durum arasındaki ilişkiye birlikte aracılık yapmaktadırlar ($\beta = \text{Yaşam doyumundan, öz-yeterlilik ile tükenmişliğe ve sonunda mesleki doyuma} = .22 * (-.46) * (-.60) = .06, p < .05$). Buna ilaveten, tükenmişlik sadece aracı rolde sahiptir ($\beta = \text{Yaşam doyumundan, tükenmişliğe ile mesleki doyuma} = (-.23) * (-.60) = .14, p < .05$). Tüm bunlar dikkate alındığında, yol modeli sonuçları, “yaşam doyumu” nun “öğretmen iş tatmini” hem doğrudan ($\beta = .31, p < .05$) hem de dolaylı olarak ($\beta = .20 (= .6 + .14), p < .05$) tahmin ettiğin, öğretmenlerin iş doyumlarının yaşam doyumları ile ilişki olduğu görüşünü desteklemektedir. Yaşam doyumunun öğretmen iş doyumunu üzerindeki toplam etkisi .51'dir (=Doğrudan etki + Dolaylı etki = $.31 + (.14 + .06)$). Bu değişkenlerle birlikte mesleki doyumunun %58'ini ($= [.31]^2 + [.06]^2 + [.14]^2 + [-.60]^2$) açıklamaktadır.

Tartışma ve Sonuç

Araştırmanın ilk bulgusu yaşam doyumuyla öğretmen mesleki öz-yeterlik arasında gözlenen pozitif ilişkidir. Alanyazın incelendiğinde öğretmenlerinin yaşam doyumuyla öğretmen mesleki öz-yeterliği araştıran çalışmalara rastlanmamaktadır. Telef (2011) yaptığı araştırmada ilköğretim ve ortaöğretim kurumlarında görev yapan öğretmenlerle, öğretmenlerin yaşam doyumuyla, öğretmen mesleki öz-yeterliği arasında düşük düzeyde pozitif ilişki gözlemlemiştir. Okursoy (2016) öğretmenlerle yaptığı araştırmada öğretmenlerin yaşam doyumuyla öğretmen mesleki öz-yeterliği arasında pozitif ilişki gözlemlemiştir. Benzer şekilde Bigdeloo ve Bozorgi (2016), Çevik (2017) ve Moksnes vd. (2019), öğretmenlerle yaptıkları araştırmalarda öğretmenlerin yaşam doyumuyla öğretmen mesleki öz-yeterliği arasında pozitif ilişki gözlemlemiştir. Bireysel yetenek konusunda kendini yeterli hisseden bireyler karşılaştıkları sorunları tehlike olarak algılamayıp bunlarla mücadele etmektedirler. Öz yeterlik algısı yüksek olan bireyler karşılarına çıkan sorunlar karşısında yılmaz hatta huzur duygusu yaşayabilirler (Pajares, 2002). Bunun yanında bireyin yaşam şartları, psikolojisi öz-yeterlik düzeyini etkileyen değişkenlerdir. Öz-yeterlik düzeyi yüksek olan bireylerde olumlu yaşam şartları ve olumlu ruh hali gözlenmektedir (Bandura vd., 1996). Özet bir ifade ile öz yeterlik algısı yüksek olan bireylerin daha huzurlu ve mutlu olması alanyazınla çelişmeyen bir bulgudur.

Araştırmanın ikinci bulgusu yaşam doyumuyla iş doyumunun pozitif ilişki gözlenmesidir. Alanyazın incelendiğinde öğretmenlerinin yaşam doyumuyla iş doyumunu arasında pozitif ilişki olduğunu bildiren araştırmalar olduğunu görülmektedir. Atabay (2020) anaokulu öğretmenleriyle, Hombrados-Mendieta ve Cosano-Rivas (2011) sosyal çalışmacılarla, Telef (2011) ilköğretim ve ortaöğretim öğretmenleriyle yaptıkları araştırmalarda yaşam doyumunu arttıkça iş doyumunun arttığını gözlemişlerdir. Araştırma sonucuna göre yaşam doyumunu ile iş doyumunu arasında pozitif ilişkiden bahsetmek doğaldır. Çünkü birey yaşamının büyük bir bölümünü işinde geçirmektedir. Çalıştığı işte mutlu olması yaşam doyumunu olumlu etkilemesi doğal bir durumdur. Berry (1997) yaptığı araştırmada yaşam doyumunu ile iş doyumunun birbirini pozitif yönde etkilediğini, ayrıca iş doyumunun mikro anlamda bireyin çalıştığı kuruma, makro anlamda ise devlete olumlu katkı sağladığını belirlemiştir.

Araştırmanın üçüncü bulgusu öğretmen öz-yeterliği ile iş doyumunu arasında mesleki tükenmişliği aracılı rolü olduğu gözlenmiştir. Alanyazına baktığımızda öğretmenlerle yapılmış sadece bir araştırmaya rastlanmaktadır. Hassan ve Ibourk (2021) ilkokul öğretmenleriyle yaptığı çalışmada, öz-yeterlikle, iş doyumunu arasında tükenmişliğin araçlı rolü olduğunu gözlemlemiştir. Bunun yanında ise kamu iktisadi teşebbüsünde çalışan bireylerle yapılan çalışmada iş tatmini ve tükenmişlik arasındaki ilişkide öz kendilik değerlendirmesinin tam aracılık rolünü gözlemlemiştir (Örücü & Hasırcı, 2021). Öğretmen öz-yeterliği, iş doyumunu ve mesleki tükenmişlik arasında ilişkiyi inceleyen çeşitli araştırmalara rastlanmaktadır. Wang vd. (2015) öğretmenlerle, Johnson (2010) özel eğitim öğretmenleriyle, Capri ve Guler (2018), özel eğitim sertifika kursuna katılan bireylerle yaptıkları araştırmalarda iş doyumuyla, öz-yeterlik arasında pozitif, iş doyumunu, öz-yeterlik ile tükenmişlik arasında negatif ilişki gözlemlemiştir. Bu araştırma sonucuna göre kendini öğretmenlik mesleğinde yeterli gören birey mesleki tükenmişlik yaşamamaktadır. Bunun sonucunda da yaptığı işte mutlu olmakta ve iş doyumunu yaşamaktadır.

Öneriler

Bu araştırma yaşam doyumunun ve öğretmen öz-yeterliğinin, iş doyumunu ilişkisinde mesleki tükenmişliğin aracı rolü olduğu gözlenmiştir. İleriki araştırmalarda başka hangi değişkenlerin aracı rolü olduğu incelenebilir.

İleriki araştırmalarda öğretmen öz-yeterlik ve yaşam doyumunun ve iş doyumunu kaynaklarının neler olduğu araştırılabilir. Ayrıca araştırılan bu değişkenleri arttırmak için gereken hizmet içi eğitimler verilebilir.

Yetersizliği olan bireylerle çalışmak zordur. Ayrıca öğretmenler yetersizliği olan öğrencilere nasıl davranacaklarını bilmezlerse tükenmişlik duygusu yaşayabilir. Bu sebeple öğretmenlere yetersizliği olan bireylerin özellikleri ve davranış değiştirme, öğretim yöntemleri vb. hakkında seminerler verilebilir.



<http://www.tayjournal.com>

<https://dergipark.org.tr/en/pub/tayjournal>

Determination of Tax Awareness Level of Secondary School Students*

İD Tuğba Semin Akkurt, Teacher, Corresponding Author
Tokat Gaziosmanpaşa University, Türkiye
tugbaseminkurt@gmail.com
Orcid ID: 0000-0002-3559-756X

İD Ömer Faruk Sönmez, Prof. Dr.
Tokat Gaziosmanpaşa University, Türkiye
sonmez.omerfaruk@gmail.com
Orcid ID: 0000-0002-8910-2817

Article Type: Research Article

Received Date: 21.08.2023

Accepted Date: 26.05.2024

Published Date: 31.07.2024

Plagiarism: This article has been reviewed by at least two referees and scanned via a plagiarism software

Doi: 10.29329/ tayjournal.2024.653.02

Citation: Akkurt, T. S., & Sönmez, Ö. F. (2024). Determination of tax awareness level of secondary school students. *Türk Akademik Yayınlar Dergisi (TAY Journal)*, 8(2), 225-245.

*This article was produced from Tuğba Semin Akkurt's master's thesis supervised by Prof. Dr. Ömer Faruk Sönmez.

Abstract

The way the state can provide the necessary services to its people is through regularly paid taxes. In order for taxes to be paid regularly, taxpayers should perceive the tax positively. The aim of this study is to evaluate the tax awareness of 6th and 7th grade secondary school students. The survey model, which is one of the quantitative research methods, was used in the study. A questionnaire was applied within the scope of the research. In the study, it was concluded that students' tax awareness was at a low level. One of the results of the research is that as the age and class levels of the students increase, their tax awareness also increases. As a result of the study, suggestions were given to increase the tax awareness of the students. In this context, tax- related gains that are limited to the 6th grade can also be included in the 7th and 8th grade levels. Since these are the places where students hear the concept of tax most frequently, emphasis can be given to tax education through family and school in order to increase their tax awareness.

Keywords: Tax, tax awareness, secondary school students.

Introduction

Taxes are among the most important sources of income for states. States meet the increasing public expenditures through the taxes they receive from the public. The state's attainment of the expected economic level is largely thanks to taxes. The increasing need for income from past to present is met by taxes, which constitute the majority of income in our country, as in other countries (Organ & Yegen, 2013). In a society where citizens pay their taxes regularly and voluntarily, state revenues will be maximized and the level of public service will be kept high (Aktan et al., 2012). The positive perception of tax by taxpayers facilitates their voluntary compliance with taxation. The tax education that individuals will receive from an early age will facilitate them to develop a positive attitude towards taxation. Tax literacy, tax awareness, tax morale are among the factors that affect the attitudes and behaviors of citizens. An individual with tax awareness will have knowledge about the purposes for which the state collects and uses taxes. Informing the society about taxes will make citizens more comfortable about paying taxes. It is thought that taxpayers who are educated in taxation are aware of the benefits they provide to the state, so they have higher tax compliance and higher tax morale (Cesur & Çelikkaya, 2014). As the necessary importance is given to tax education in our country, the probability of the state to collect taxes will increase. If the state collects taxes at the desired level, improvements will be made in the services it will offer to the public. In this research, the perception of the boundaries of the 6th and 7th grades of secondary school and their distance to the edges are revealed. The tax awareness survey developed by Zorlu (2012) was used in the study. The survey was applied to 408 students in the city center of Tokat. The survey was applied to 6th and 7th grade students because there are tax-related gains in the social studies course at the 6th and 7th grade level. The aim of the study is to conduct a tax awareness assessment with 6th and 7th grade secondary school students in Tokat province. The aim of the research is to identify the deficiencies and guide the work to be done to eliminate the deficiencies in order to raise tax-conscious citizens of the future. In line with the purpose of the study, answers were sought to the following questions.

1. What is the tax awareness of 6th and 7th grade secondary school students?

2. Does the tax awareness of 6th and 7th grade secondary school students differ according to gender?

3. Does the tax awareness of 6th and 7th grade secondary school students differ according to family income status?

4. Does the tax awareness of 6th and 7th grade secondary school students differ according to their mother's education level?

5. Does the tax awareness of 6th and 7th grade secondary school students differ according to their father's education level?

6. Does the tax awareness of 6th and 7th grade secondary school students differ according to the mother's profession?

7. Does the tax awareness of 6th and 7th grade secondary school students differ according to the father's profession?

Conceptual Framework Regarding Tax

Taxes are among the most important sources of income that states use to fulfill their expected duties (Edizdoğan et al., 2019). Tax is used as an effective tool in situations such as inflation and deflation, which disrupt economic stability, economic development and progress in the country's economy in various periods (Edizdoğan et al., 2019). The quality of public services will increase in societies where individuals pay their taxes voluntarily and regularly. Citizens' voluntary compliance with taxes will be possible by raising awareness about taxes. Tax literacy is among the factors that shape citizens' attitudes towards taxes. Tax literacy; It is to have the ability to adequately read, write and understand tax-related issues (Yılar & Akdağ, 2017). As the necessary importance is given to tax literacy in our country, the probability of the state collecting taxes will increase. Another factor that will change individuals' attitudes towards taxes is tax awareness. Taxpayers have a certain resistance to paying taxes. With the declaration-based taxation system in our country, obligations are fulfilled by the taxpayers themselves (Çiçek, 2007). For this reason, it is important for citizens to be able to make accurate statements to the state. The way to make an accurate declaration is to have tax awareness. Tax awareness is defined as citizens being willing and attentive to pay taxes in accordance with the law (Kıral, 2018). Another factor that affects taxpayers' perspective on tax is tax morale. Tax morale; It can be defined as the willingness of taxpayers to pay their taxes or their sense of moral duty (Sandalcı & Sandalcı, 2017). Citizens' sensitivity to taxes depends on their level of tax morale (Kurt & Bozdoğan, 2023). When we look at tax morale and the sensitivity shown towards taxes, social tax morale also has an important place in addition to individual morality and sensitivity. The development and establishment of tax morale is directly linked to education, awareness and development (Teyyare & Kumbaşlı, 2016). The best way to raise awareness about a subject is the education provided on that subject. With the training provided on tax, individuals will be enabled to learn tax legislation better and thus fulfill their tax-related obligations on time (Oğuz, 2019). It is necessary to raise a certain awareness through tax education given to citizens from an early age.

Studies Conducted with Students for Tax Awareness

When the literature is examined, it is seen that many studies have been conducted on the tax awareness levels of students at various education levels. Zorlu (2012) conducted a survey consisting of 32 questions in total in his study titled "Tax awareness level of primary school students and a sample application on tax awareness level (Ankara province example)". In the study, the differences in tax awareness of students according to socio-demographic situations were investigated. As a result of the analysis, it was seen that primary school students' perceptions of taxes were positive. While students' tax awareness does not differ significantly according to their gender, father's profession, parents' education level and average monthly income; There are significant differences depending on their age, mother's profession, and the grades they study in. Güngüneş (2022), aimed to measure the tax and invoice-receipt awareness of students in the 9-11 age group in his study titled "Tax perception towards children: A study on Kırıkkale primary school students". In this regard, a survey consisting of 30 questions was conducted. As a result of the analysis, it was concluded that as the age of the students increases, their tax awareness increases, and as the education level of the parents increases, the tax awareness of their children increases. As a result of the findings, it was seen that the importance given by the parents to receiving receipts and invoices matched the care taken by the student in receiving receipts and invoices. However, it was observed that there was no relationship between the care taken by the student in receiving receipts and invoices and age. As a result, it was concluded in the study that there is a parallelism between the tax consciousness of families and the tax consciousness of children. Gür (2019), in his study titled "Tax awareness and tax morale among secondary school students: The example of Bingöl province", conducted a survey on 6021 students between the ages of 14-19. As a result of the analysis, a significant relationship was found between students' tax awareness and tax morale and age, class and gender factors. However, it was observed that the students' knowledge was sufficient in defining taxes and defining citizens who pay taxes and do not pay taxes. Karaot (2010), "Tax awareness level of primary school students; In his study titled "Sample of Aliğa district of Izmir province", it was examined whether there is a relationship between the tax awareness of primary school students and the income level of the family, the education level and professions of the parents, and the settlement area of residence. A survey and interview were applied in the study. As a result of the findings obtained from the study, it is seen that mother's education is directly proportional to the willingness to pay taxes. However, it was concluded that students are aware that taxes are an important financing tool for the state. In his study titled "Tax awareness and tax perception: A research on primary school students in Kütahya", Karaca (2015), conducted a survey on 339 3rd and 4th grade students. As a result of the analysis, it was concluded that there was no significant relationship between students' tax perceptions and tax awareness levels and their gender, place of residence, parents' education levels, mother's profession, and family income. As a result of the research, it was observed that students were frequently indecisive. The researcher suggested that tax education should be included first in the family and then in schools. Çelik (2013), in his study titled "Examination of tax perception in primary school age: Zonguldak province example", conducted a survey on 766 students consisting of 4th, 5th, 6th, 7th and 8th grade students. It was concluded in the study that half of the students had no knowledge about taxes. Another result of the study is that as

students' ages increase, their tax perceptions also increase. Sağbaşı and Başođlu (2005), in his study titled "Primary school students' perception of taxes: Afyonkarahisar province example", conducted a survey and interview with primary school students in Afyonkarahisar province. It was concluded in the study that students had many misconceptions about taxes, but that education level and gender were not decisive in their perception of taxes. It was concluded that as the age of the students, the income level of the family and the education level of the parents increase, misconceptions about taxes decrease.

Method

Survey model, which is one of the quantitative research methods, was used in the study. The survey model is a research model in which the characteristics of a certain group are determined and the past or still existing event is tried to be described without the researcher's effort to influence it. In the survey model, the situation subject to the research is defined as it is, and the researcher does not intervene in the situation (Krathwohl, 1993; as cited in Köse, 2013; Büyüköztürk et al., 2016). In the survey model, the opinions and attitudes of the individuals in the group are taken and the phenomena and events are tried to be described (Tanıröğren, 2014). In this type of research, what is described is clearly revealed and generalisations are made for the universe (Hocaođlu & Baysal, 2019).

Population and Sample

The population of the study consists of 6th and 7th grade students in Tokat in the 2021-2022 academic year. The sample of this study was selected by simple random sampling method. In the simple random sampling method, all elements in the universe have an equal chance of being selected (Karasar, 2002). The sample representing the population of the research was determined by simple random sampling method, 408 students from 6th and 7th grades from 8 public schools in Tokat province in the 2021-2022 academic year. The demographic characteristics of the students who participated in the research are shown in Table 1.

Table 1.
Demographic Characteristics of Students

		<i>f</i>	%
Age	11	191	46.8
	12	164	40.2
	13	48	11.8
	14	5	1.2
Grade	6 th grade	204	50.0
	7 th grade	204	50.0
Gender	Girl	207	50.7
	Male	201	49.3
Father's education level	Illiterate	28	6.9
	Primary school	32	7.8
	Middle school	80	19.6
	High school	100	24.5
	University and college	168	41.2
Mother's education level	Illiterate	33	8.1
	Primary school	75	18.4
	Middle school	133	32.6
	High school	91	22.3
	University and college	76	18.6
Mother's profession	Not working/housewife	255	62.5
	Employee	30	7.4
	Officer	81	19.9
	Private sector	15	3.7
	Craft	11	2.7
	Self-employment	13	3.2
	Other	3	.7
	Does not work/ has an obstacle to work	13	3.2
Father's profession	Employee	88	21.6
	Officer	148	36.3
	Private sector	30	7.4
	Craft	36	8.8
	Self-employment	30	7.4
	Executive	23	5.6
	Other	40	9.8
Monthly income	0-5500	39	9.6
	5501-7500	62	15.2
	7501-10000	125	30.6
	10001-15000	97	23.8
	15001 and above	85	20.8

When Table 1 is examined, 46.8% of the students participating in the study are 11 years old, 40.2% are 12 years old, 11.8% are 13 years old and 1.2% are 14 years old; It was observed that 50.0% were girls and 50.0% were boys. When the education level of the students' fathers is examined, 6.9% are literate, 7.8% are primary school graduates, 19.6% are secondary school graduates, 24.5% are high school graduates and 41.2% are university or college graduates. graduated from; When the educational status of the mother is examined, 8.1% are illiterate, 18.4% are primary school graduates, 32.6% are secondary school graduates, 22.3% are high school graduates and 18.6% are university and college graduates. It has been observed that. 62.5% of the students' mothers are unemployed/housewives, 7.4% are workers, 19.9% are civil servants, 3.7% are in the private sector, 2.7% are tradesmen, 3.2% are It was observed that

100.000 of them were self-employed and 7% were in other occupational groups. 3.2% of the students' fathers are not working or have an obstacle to work, 21.6% are workers, 36.3% are civil servants, 7.4% are in the private sector, 8.8% are tradesmen, 7% are It was observed that 4 of them were self-employed, 5.6% were managers and 9.8% were in other professional groups. 9.6% of the students say their family's monthly income is between 0-5500 TL, 15.2% say their family's monthly income is between 5501-7500 TL, 30.6% say their family's monthly income is between 7501-10000 TL, 23.8% say their family's monthly income is between 5501-7500 TL. It was observed that the monthly income of the family of 10001-15000 TL was between 10001-15000 TL and 20.8% of the family's monthly income was 15001 and above.

Data Collection Tools

As a data collection tool in this research; A three-part survey developed by Zorlu (2012) was applied. The first part of the survey includes questions about the demographic characteristics of the students and their families. In the second part, there are multiple choice questions regarding students' tax awareness. Finally, there is a Likert survey.

Cronbach's alpha value was used to examine the reliability level of the tax awareness survey in relation to internal consistency. Cronbach alpha value varies between "0" and "1". Alpha values are considered unreliable if they are less than .50, moderately reliable if they are between .50 and .80 and highly reliable if they are more than .80 (Salvucci et al., 1997). Reliability coefficients for the survey are listed in Table 2.

Table 2.

Reliability Coefficients of the Tax Awareness Survey

Survey	Number of items	Cronbach's alpha
Tax awareness survey	20	.96

Data Collection Process

Before applying the tax awareness survey to the students in the sample group of the study, the necessary permissions were obtained from the Tokat Provincial Directorate of National Education and the application was started. The survey was administered to students in March, and it was assumed that students would learn the tax awareness gains in the curriculum and increase their awareness.

Surveys were administered to students during class hours. All questionnaires were filled out and all forms were analyzed.

Analysis of Data

The data collected within the scope of the study was entered into the SPSS program. The data collected in the study were analyzed using the SPSS 22 program. The suitability of the data for normal distribution was determined using skewness, kurtosis and standard error values.

Table 3.

Skewness and Kurtosis Values of the Tax Awareness Survey

Survey	Skewness		Kurtosis	
	Worth	Std. Error	Worth	Std. error
Tax awareness	.54	.12	-.23	.24

Ethical Permits of Research:

In this study, all the rules specified to be followed within the scope of "Higher Education Institutions Scientific Research and Publication Ethics Directive" were complied with. None of the actions specified under the heading "Actions Contrary to Scientific Research and Publication Ethics", which is the second part of the directive, have been taken.

Ethics Committee Permission Information:

Name of the committee that made the ethical evaluation = Tokat Gaziosmanpaşa University Social Sciences and Humanities Research Ethics Committee

Date of ethical review decision= 17.06.2022

Ethics evaluation document publication number= 163879

Findings

In this section, the results obtained by analyzing the data obtained from the tax awareness survey applied to the students participating in the research are included. In the process of analyzing the data; Descriptive statistics, t-test and Anova test, which are parametric tests, were applied.

Table 4 includes descriptive statistics for the tax awareness survey.

Table 4.

Descriptive Statistics of Tax Awareness

	<i>n</i>	Minimum	Maximum	<i>M</i>	<i>SD</i>
Tax awareness	408	1.00	5.00	2.41	1.01

When we examine Table 4, the points given to the tax awareness survey are minimum 1.00; maximum 5.00; It is seen that the mean is 2.41 and the standard deviation is 1.01. Considering the averages obtained, it was concluded that students' tax awareness was low.

The question "What do you think is tax?" in the tax awareness survey of the students participating in the research. Their answers to the question are shown in Table 5.

Table 5.

What Do You Think is Tax? Descriptive Statistics for the Question

What do you think is tax?	<i>f</i>	%
It is the compensation for the services provided by the state	214	52.5
It is a civic duty	76	18.6
It is a compulsory and unrequited payment.	54	13.2
It is a burden on people.	35	8.6
It is an application that hinders the growth of businesses	29	7.1

When Table 5 is examined, it can be seen that the question "What do you think is tax?" in the tax awareness survey. 52.5% of the students answered the question "It is a reward for the services provided by the state", 18.6% said "It is a civic duty", 13.2% said "It is a payment made compulsorily and without compensation", 8.6% said "It affects people". It was observed that they answered "It is a burden" and 7.1% said "It is a practice that prevents the growth of businesses". It was observed that the answer with the highest frequency was "It is a reward for the services provided by the state", and the answer with the lowest frequency was "It is a practice that prevents the growth of businesses".

Table 6.

What Do You Think is Tax? Descriptive Statistics Fort He Question

Where did you first hear the word tax?	<i>f</i>	%
From my family	131	32.1
From school	148	36.3
Newspaper/magazine/tv etc.	62	15.2
From my surroundings	67	16.4

Table 6 shows the question "Where did you first hear the word tax?" in the tax awareness survey. Regarding the topics, 32.1% said "From my family", 36.3% said "From school", 15.2% said "Newspaper/magazine/TV etc." and 16.4% were found to be "From my environment". The highest frequency of exit from school is "From school" and the lowest frequency is "Newspaper/magazine/tv etc." It was observed that there was an infection.

Table 6 shows the results of the difference in meaning between students' tax awareness according to their age variable.

Table 7.

Tax Awareness Survey Anova Test According Age Variable

Questionnaire	Age	<i>n</i>	<i>M</i>	<i>SD</i>	<i>f</i>	<i>p</i>	Post-Hoc
Tax awareness	11	191	1.94	.94	38.10	.00**	12>11
	12	164	2.70	.87			13>11
	13	48	3.25	.83			13>12
	14	5	3.16	.20			14>11

**p<.01; *p<.05

When Table 7 is evaluated, it is concluded that there is a significant difference in the averages of the tax awareness survey according to the age variable of the students ($p < .05$). It was observed that the average score of 12-year-old students in the survey ($2.70 \pm .87$) was higher than the average score of 11-year-old students ($1.94 \pm .94$) and that the tax awareness of 12-year-old students was higher than that of 11-year-old students. The average score given by 13-year-old students to the survey ($3.25 \pm .83$) was higher than the average score given by 11-year-old students ($1.94 \pm .94$) and the average score of 12-year-old students ($2.70 \pm .87$). It was observed that the tax awareness of 13-year-old students was higher than that of 11- and 12-year-old students. It was observed that the average score given by 14- year-old students to the tax awareness survey ($3.16 \pm .20$) was higher than the average score given by 11-year-old students ($1.94 \pm .94$) and that the tax awareness of 14-year-old students was higher than that of 11-year-old students.

Table 8.

Tax Awareness Survey t-test According to Class Variable

Questionnaire	Class	<i>n</i>	<i>M</i>	<i>SD</i>	<i>t</i>	<i>p</i>
Tax awareness	6	204	1.73	.75	-18.63	.00**
	7	204	3.10	.74		

**p<.01; *p<.05

When Table 8 is examined, it is seen that there is a significant difference in the average scores given to the tax awareness survey according to the students' class variable ($p < .05$). It was found that the average score given by 7th grade students to the tax awareness survey

(3.10±.74) was higher than the average score given by 6th grade students (1.73±.75) and that the tax awareness awareness of 7th grade students was higher than that of 6th grade students. It was found to be higher than that of first grade students.

Table 9.

Tax Awareness Survey t-test According to Gender Variable

Questionnaire	Gender	<i>n</i>	<i>M</i>	<i>SD</i>	<i>t</i>	<i>p</i>
Tax awareness	Girl	207	2.88	1.00	10.62	.00**
	Male	201	1.93	.78		

**p<.01; *p<.05

When Table 9 is examined, it is seen that there is a significant difference in the average scores given to the tax awareness survey according to the gender variable of the students (p<.05). It was observed that the average score given by female students to the tax awareness survey (2.88±1.00) was higher than the average score given by male students (1.93±.78) and that the tax awareness of female students was higher than that of male students.

Discussion and Conclusion

There are studies in the literature to determine the tax awareness of primary and secondary school students. Among these studies, Çelik (2013), Güngüneş (2022), Karaca (2015), Karaot (2010), Zorlu (2012) conducted research to determine the tax awareness of primary school students. Gür (2019), Yıldız and Bakır (2019) conducted research to determine tax awareness among secondary school students. Studies conducted by Zorlu (2012) and Karaca (2015) show parallelism with students' tax perceptions in that there is no significant difference between gender, place of residence, parents' education levels, and monthly incomes of their families. In the research, it was seen that there was a significant difference between the income status of the students' families, the education level of the parents and tax awareness. In this context, it does not support the results in the literature. In this regard, Torgler and Schaltegger (2005) concluded in their research that taxpayers with higher education levels have lower tax compliance due to their higher critical perspectives. A similar study was conducted by Dubin et al. (1990) and it was concluded that there was a negative relationship between tax compliance and education. Another study on the subject was conducted by Alm et al. (1992). The study concluded that as the education level of individuals increases, tax compliance will become easier. Çelik (2013), Güngüneş (2022), Gür (2019), Zorlu (2012) revealed in their studies that there is a significant difference between students' ages and tax perceptions. The result of the research supports this result in the literature. As students' ages increase, their awareness of taxes may be related to their increased knowledge levels.

Among those who conducted studies to evaluate the tax awareness of university students are Macit (2023), Akkara (2016), Karacan (2019), Kaya (2018), Suzan Demir (2023). In his study with associate degree students, Karacan (2019), concluded that second-year students have higher tax awareness than first-year students. Macit (2023), conducted her study with university students and, similar to other studies, concluded that there is a significant difference between age and tax awareness.

Tax awareness is evaluated as being able to define tax correctly, understanding its purpose, developing a positive attitude towards those who pay taxes and having a negative

perspective towards those who do not pay (Zorlu, 2012). In this study, the tax awareness of secondary school students was examined and it was aimed to help raise tax-conscious individuals. According to the answers given by the students to the applied tax awareness survey, it was concluded that the students' tax awareness was at a low level. The majority of the students participating in the research define taxes as compensation for the services provided by the state and as a civic duty; It was concluded that he heard the word tax for the first time from school and his family. In the research, it was determined that there was a significant difference between the tax awareness levels of the students according to the age variable. Tax awareness levels of 12, 13 and 14 year old students are higher than 11 year old students; It was concluded that the tax awareness levels of 13-year-old students are higher than 12-year-old students. In the research, it was determined that there was a significant difference between the tax awareness levels of the students according to the class variable. It was concluded that 7th grade students' tax consciousness awareness is higher than 6th grade students. In the research, it was determined that there was a significant difference between the tax awareness levels of the students according to the gender variable. It was concluded that female students' tax consciousness awareness is higher than male students.

Recommendations

Since school and family are the places where 6th and 7th grade students hear about taxes the most, their tax awareness should be increased through training given at school and within the family.

Due to the fact that 7th grade students have higher tax awareness than 6th grade students, activities to increase tax awareness in 6th grade should be increased. Coordinated studies should be carried out with the revenue administration.

Since this research is limited to 6th and 7th grade students, it is recommended to include 8th grade students in future studies in this field.

References

- Akkara, Ö., & Gencel, U. (2016). *Yükseköğretim öğrencilerinin vergiye yönelik algularının çeşitli değişkenler açısından incelenmesi: Çanakkale Onsekiz Mart Üniversitesi örneği* [Examining higher education students' perceptions towards tax in terms of various variables: Çanakkale Onsekiz Mart University example]. (Publication No. 433732) [Master thesis, Çanakkale Onsekiz Mart University] National Thesis Center.
- Aktan, C. C., Kesik, A., & Dileyici, D. (2012). *Yeni maliye: Değişim çağında kamu maliyesi: Yeni trendler, yeni paradigmlar, yeni öğretiler, yeni perspektifler* [New finance: Public finance in the age of change: New trends, new paradigms, new teachings, new perspectives]. Maliye Bakanlığı Strateji Geliştirme Başkanlığı.
- Alm, J., Jackson, B. R., & McKee, M. (1992). Estimating the determinants of taxpayer compliance with experimental data. *National Tax Journal*, 45(1), 107-114.
- Büyüköztürk, Ş., Çakmak, E. K., Akgün, Ö. E., Karadeniz, Ş., & Demirel, F. (2016). *Bilimsel araştırma yöntemleri* [Scientific research methods]. Pegem.
- Canbolat Kaya, S. (2018). *Yükseköğretim öğrencilerinde vergi bilinci ve vergi algısı üzerine bir araştırma: Ahi Evran Üniversitesi örneği* [A research on tax awareness and tax perception among higher education students: Ahi Evran University example]. (Publication No. 504466) [Master thesis, Ahi Evran University]. National Thesis Center.
- Cesur, A., & Çelikkaya, A. (2014). Türkiye'de vergi kültürünün gelişmesinde Gelir İdaresi Başkanlığı'nın yeri ve önemi [In the development of tax culture in Türkiye place and importance of Revenue Administration]. *Afyon Kocatepe University Journal of Economics and Administrative Sciences*, 16(2), 1-14.
- Çelik, İ., Tunç, H., & Kaya, M. (2013). Vergi indirimlerinin yerel ekonomilerin büyümesindeki rolü ve Burdur örneği [The role of tax discount in local economic growth and a case study for Burdur]. *Mehmet Akif Ersoy University Journal of Social Sciences Institute*, 5(8), 26-35.
- Çiçek, H. (2007). *Psikolojik ve sosyal yönden yükümlülerin vergiye karşı tutum ve tepkileri* [Attitudes and reactions of taxpayers towards tax from psychological and social aspects]. (Publication No. 217039) [Doctoral dissertation, İstanbul University]. National Thesis Center.
- Dubin, J. A., Graetz, M. J., & Wilde, L. L. (1990). The effect of audit rates on the federal individual income tax: 1977- 1986. *National Tax Journal*, 43(4), 395-409.
- Edizdoğan, N., Çetinkaya, Ö., & Gümüş, E. (2019). *Kamu maliyesi* [Public finance] (10th ed.). Ekin.
- Güngüneş, S. N. (2022). *Çocuklara yönelik vergi algısı: Kırıkkale ilköğretim öğrencileri üzerine bir inceleme* [Tax perception on children: A review on Kırıkkale primary students]. (Publication No. 713099) [Master thesis, Kırıkkale University]. National Thesis Center.
- Gür, E. (2019). *Orta öğretim öğrencilerinde vergi bilinci ve vergi ahlakı: Bingöl ili örneği* [Tax awareness and tax ethics among high school students: The example of Bingöl province]. (Publication No. 567777) [Master thesis, İnönü University]. National Thesis Center.
- Hocaoğlu, N., & Baysal, A. (2019). Nicel araştırma modelleri-desenleri [Quantitative research models-designs]. In G. Ocak (Ed.), *Eğitimde bilimsel araştırma yöntemleri* [Scientific research methods in education]. (pp. 66-11). Pegem.
- Karaca, R. (2015). *Vergi bilinci ve vergi algısı: Kütahya ilinde ilköğretim öğrencileri üzerine bir araştırma* [Tax awareness and tax perception: A survey on primary school students in Kütahya province]. (Publication No. 413862) [Master thesis, Dumlupınar University]. National Thesis Center.
- Karacan, C. İ. (2019). *Ön lisans öğrencilerinin vergiye bakışı ve vergi bilinç düzeyi: Sakarya ili örneği* [Associate degree students' view of tax and tax awareness level: The example of Sakarya province]. (Publication No. 572829) [Doctoral dissertation, Sakarya University]. National Thesis Center.

- Karaot, A. (2010). *İlköğretim çağındaki öğrencilerin vergi bilinç düzeyi: İzmir ili Aliağa ilçesi örneği* [Tax revenue of primary school students: Example of İzmir Aliağa town]. (Publication No. 257362) [Master thesis, Çanakkale Onsekiz Mart University]. National Thesis Center.
- Karasar, N. (2002). *Bilimsel araştırma yöntemi* [Scientific research method]. Nobel.
- Kaya, S. C., (2018). *Yükseköğretim öğrencilerinde vergi bilinci ve vergi algısı üzerine bir araştırma: Ahi Evran Üniversitesi örneği* [A study on tax consciousness and tax perception in higher education students: Ahi Evran University example]. (Publication No. 504466) [Master thesis, Ahi Evran University]. National Thesis Center.
- Kıral, E. (2018). Vergi ahlakı ve vergi bilincini etkileyen faktörler: Çukurova Üniversitesi öğrencileri üzerine bir analiz [Factors affecting tax morality and tax awareness: An analysis on Cukurova University students]. *Academic Review of Economics and Administrative Sciences*, 11(2), 150-167.
- Krathwohl, D. R. (1993). *Methods of educational and social science research: An integrated approach*. Longman/Addison Wesley Longman.
- Kurt, S., & Bozdoğan, D. (2023). Vergi cennetlerinin uluslararası vergi rekabetine olumsuz etkileri [Negative effects of tax havens on international tax competition]. *Journal of Strategic Management Research*, 6(1), 78-93.
- Macit, D. (2023). *Üniversite öğrencilerinde vergi bilincinin değerlendirilmesi: Türkiye ve Polonya örneği* [Evaluation of tax awareness among university students: The example of Turkey and Poland]. (Publication No. 820945) [Master thesis, Bursa Uludağ University]. National Thesis Center.
- Oğuz, Y. (2019). *Türkiye’de vergi bilincinin geliştirilmesinde eğitimin rolü: Antalya ili Manavgat ilçesi örneği* [Role in development of training tax awareness in Turkey: The case of Antalya Manavgat]. (Publication No. 606931) [Master thesis, Akdeniz University]. National Thesis Center.
- Organ, İ., & Yegen, B. (2013). Vergi bilinci ve vergi ahlakı oluşumunda muhasebe meslek mensuplarının rolü: Adana örneği [The role of professional accountants in the formation of tax awareness and tax morale: Adana example]. *Journal of Economics and Administrative Sciences*, 27(4), 241-271.
- Ömürbek, N., Çiçek, H. G., & Çiçek, S. (2007). Vergi bilinci üzerine bir inceleme: Üniversite öğrencileri üzerinde yapılan anketin bulguları [An analysis on tax conciousness: The findings of the survey on university students]. *Maliye Dergisi*, 153(2007), 102-122.
- Sağbaş, İ., & Başoğlu, A. (2005). İlköğretim çağındaki öğrencilerin vergileri algılaması: Afyonkarahisar ili örneği [Primary school students' perception of taxes: The example of Afyonkarahisar province]. *Afyon Kocatepe University Journal of Economics and Administrative Sciences*, 7(2), 123-144.
- Salvucci, S., Walter, E., Conley, V., Fink, S., & Saba, M. (1997). *Measurement error studies at the national center for education statistics* (Report No. NCEs 97464). U.S. Department of Education. Retrieved January 25, 2023, from <https://nces.ed.gov/pubs97/97464.pdf>
- Sandalcı, U., & Sandalcı, İ. (2017). Vergi ahlakı ve kayıt dışı ekonomi ilişkisi: OECD ülkeleri özelinde bir inceleme [The relationship between tax morality and informal economy: A Study specific to OECD countries]. *The Sakarya Journal of Economics*, 6(1), 70-93.
- Suzan, D. (2023). *Yükseköğretim öğrencilerinin vergi algısı ve vergi bilinci: Akdeniz Üniversitesi örneği* [Tax perception and tax awareness of higher education students: Case of Akdeniz University]. (Publication No. 787618) [Master thesis, Akdeniz University]. National Thesis Center.
- Tanrıöğren, A. (2014). *Bilimsel araştırma yöntemleri* [Scientific research methods]. Anı.

- Teyyare, E., & Kumbaşlı, E. (2016). Vergi bilinci ve vergi ahlakının gelişmesinde maliye bölümü eğitiminin rolü [The role of finance department education in the development of tax awareness and tax morale]. *Bolu Abant İzzet Baysal University Journal of Graduate School of Social Sciences*, 16(4), 1-30.
- Torgler, B., & Schaltegger, C. A. (2005). Tax morale and fiscal policy. *Center for Research in Economics, Management and the Arts*, 1-34.
- Turan, R., & Akdağ, H. (Eds.). *Sosyal bilgiler öğretiminde yeni yaklaşımlar III* [New approaches in social studies teaching III]. Pegem.
- Yılar, M. B., & Akdağ, H. (2017). Sosyal bilgiler öğretiminde vergi okuryazarlığı [Tax literacy in social studies teaching] In R. Turan & H. Akdağ (Eds.). *Sosyal bilgiler öğretiminde yeni yaklaşımlar 3* [New approaches in social studies teaching 3] (pp. 356-388). Pegem.
- Yıldız, G., & Bakır, Z. (2019). Lise öğrencilerine yönelik vergi bilinci: Eskişehir örneği [Tax awareness for high school students: Eskişehir example] *Eurasian Journal of Social and Economic Research*, 6(4), 294-307.
- Zorlu, Ö. (2012). *İlköğretim çağındaki öğrencilerin vergi bilinci düzeyi ve vergi bilinci düzeyi ile ilgili örnek uygulama* (Ankara ili örneği) [Taxation consciousness of students in primary education age and model application related to taxation consciousness: Case of Ankara]. (Publication No. 317170) [Master thesis, Gazi University]. National Thesis Center.

BIOGRAPHICAL NOTES

Contribution Rate of Researchers

Author 1: 50%

Author 2: 50%

Conflict Statement

There is no conflict of interest that the authors will declare in the research.



Ortaokul Öğrencilerinin Vergi Bilincine Yönelik Farkındalıkları

Özet

Devletin halkına gerekli hizmetleri sunabilmesinin yolu vergilerin düzenli ödenmesinden geçmektedir. Vergilerin düzenli ödenebilmesi için mükelleflerin vergiyi olumlu algılaması gerekmektedir. Bu çalışmanın amacı ortaokul 6. ve 7. sınıf öğrencilerinin vergi farkındalıklarının değerlendirilmesidir. Araştırmada nicel araştırma yöntemlerinden biri olan tarama modeli kullanılmıştır. Araştırma kapsamında Tokat ilinde bulunan toplam 408 öğrenciye anket uygulanmıştır. Araştırmada öğrencilerin vergi bilincinin düşük düzeyde olduğu sonucuna ulaşılmıştır. Araştırmanın sonuçlarından biri de öğrencilerin yaş ve sınıf düzeyleri arttıkça vergi farkındalıklarının da arttığıdır. Araştırma kapsamında öğrencilerin vergi farkındalıkları ile; yaş, sınıf, cinsiyet, baba eğitim durumu, anne eğitim durumu, baba mesleği, anne mesleği ve öğrencilerin aylık ortalama gelir durumu değişkenleri arasında anlamlı farklılık olduğu tespit edilmiştir. Çalışma sonucunda öğrencilerin vergi bilincinin artırılmasına yönelik önerilerde bulunulmuştur. Bu bağlamda 6. sınıfla sınırlı olan vergi ile alakalı kazanımların 7. ve 8. sınıf seviyelerinde de yer alabileceği önerisi verilmiştir. Öğrencilerin vergi kavramını en sık duydukları yer olması sebebiyle vergi farkındalıklarını arttırmak amacıyla aile ve okul aracılığıyla vergi eğitimine ağırlık verilebilir.

Anahtar Kelimeler: Vergi, vergi bilinci, ortaokul öğrencileri.

Giriş

Vergi, devletlerin sahip olduğu en önemli gelir kaynakları arasında yer almaktadır. Vatandaşların vergisini düzenli ve gönüllü olarak ödediği bir toplumda devlet gelirleri maksimize edilerek kamusal hizmet düzeyinin yüksek tutulması sağlanacaktır (Aktan vd., 2012). Mükelleflerin vergiyi olumlu olarak algılaması, vergiye karşı gönüllü uyum göstermelerini kolaylaştırmaktadır. Bireylerin küçük yaşlardan itibaren alacakları vergi eğitimi, vergiye karşı olumlu tutum geliştirmelerini kolaylaştıracaktır. Vergi konusunda eğitilmiş mükelleflerin, devlete sağladıkları faydanın farkında oldukları için vergiye yüksek uyum gösterdikleri ve vergi ahlaklarının daha yüksek olduğu düşünülmektedir (Cesur & Çelikkaya, 2014).

Yöntem

Çalışmada nicel araştırma yöntemlerinden biri olan tarama modeli kullanılmıştır. Tarama modeli; belirli bir grubun özelliklerinin belirlenerek, geçmişte ya da hala var olan olayı araştırmacının etkileme çabası olmadan betimlenmeye çalışıldığı bir araştırma modelidir. Tarama modelinde araştırmaya konu olan durum olduğu gibi tanımlanır, araştırmacı duruma herhangi bir müdahalede bulunmaz (Krathwohl, 1993; akt. Köse, 2013; Büyüköztürk vd., 2016). Tarama modelinde, grupta yer alan bireylerin görüşleri ve tutumları alınarak, olgu ve olaylar betimlenmeye çalışılır (Tanıröğren, 2014). Bu tür araştırmalarda betimlenenin ne olduğu açıkça ortaya konulur ve evrene yönelik genellemeler yapılır (Hocaoğlu ve Baysal, 2019).

Evren ve Örneklem

Çalışmanın evrenini 2021-2022 eğitim ve öğretim yılında Tokat ilindeki 6. ve 7. sınıf öğrencileri oluşturmaktadır. Bu çalışmanın örnekleme basit tesadüfi örnekleme yöntemi ile seçilmiştir. Basit tesadüfi örnekleme yönteminde evrende yer alan tüm elemanların seçilme şansı birbirine eşittir (Karasar, 2002). Araştırmanın evrenini temsil eden örneklem 2021-2022 eğitim ve öğretim yılında Tokat ilindeki 8 devlet okulundan 6. ve 7. sınıflardan 408 öğrenci basit tesadüfi örnekleme yöntemi ile belirlenmiştir.

Veri Toplama Araçları

Araştırmada veri toplama aracı olarak; Zorlu (2012) tarafından geliştirilen anket uygulanmıştır. Anketin ilk bölümünde öğrencilerin ve ailelerinin demografik özelliklerine ilişkin sorular yer almaktadır. İkinci bölümde ise öğrencilerin vergi farkındalıklarına yönelik çoktan seçmeli sorular vardır. Son olarak da likert anketi yer almaktadır.

Vergi farkındalığı anketinin iç tutarlılık ile ilişkili güvenilirlik düzeyini incelemek için Cronbach alfa değeri kullanılmıştır. Cronbach alfa değeri “0” ile “1” arasında değişmektedir. Alfa değerleri .50’den az ise güvenilir değil, .50-.80 arasında ise orta düzeyde güvenilir, .80’den fazla ise yüksek güvenilirlikte kabul edilmektedir (Salvucci vd., 1997).

Tablo 1.

Vergi Bilinci Anketine Ait Güvenirlik Katsayıları

Anket	Madde sayısı	Cronbach alfa
Vergi bilinci anketi	20	.96

Veri Toplama Süreci

Çalışmanın örneklem grubunda yer alan öğrencilere vergi farkındalığı anketi uygulanmadan önce Tokat İl Millî Eğitim Müdürlüğü’nden gerekli izinler alınmıştır. Gerekli izinler alındıktan sonra anketler uygulanmaya başlanmıştır. Anket öğrencilere mart ayı içerisinde uygulanarak öğrencilerin öğretim programında yer alan vergi bilincine yönelik kazanımları öğrenmeleri ve farkındalıklarının artması varsayılmıştır.

Verilerin Analizi

Çalışma kapsamında toplanan verilerin girişi SPSS programına yapılmıştır. Çalışmada toplanan veriler SPSS 22 programı aracılığıyla analiz edilmiştir. Verilerin normal dağılıma uygunluğu çarpıklık, basıklık ve standart hata değerleri kullanılarak tespit edilmiştir.

Tablo 2.

Vergi Bilinci Anketine Ait Çarpıklık ve Basıklık Değerleri

Anket	Çarpıklık		Basıklık	
	Değer	Std. hata	Değer	Std. hata
Vergi bilinci	.54	.12	-.23	.24

Araştırmanın Etik İzinleri:

Bu çalışmada "Yükseköğretim Kurumları Bilimsel Araştırma ve Yayın Etiği Yönergesi" kapsamında uyulması gerektiği belirtilen tüm kurallara uyulmuştur. Yönergenin ikinci bölümü olan "Bilimsel Araştırma ve Yayın Etiğine Aykırı Eylemler" başlığı altında belirtilen eylemlerin hiçbiri gerçekleştirilmemiştir.

Etik Kurul İzin Bilgileri:

Etik değerlendirmeyi yapan kurulun adı = Tokat Gaziosmanpaşa Üniversitesi Sosyal ve Beşeri Bilimler Araştırmaları Etik Kurulu

Etik kurul etik inceleme karar tarihi= 17.06.2022

Etik değerlendirme belgesi konu numarası= 163879

Bulgular

Tablo 3'te vergi bilinci anketine yönelik betimsel istatistiklere yer verilmiştir.

Tablo 3.

Vergi Bilincine Ait Betimsel İstatistikler

	<i>n</i>	Minimum	Maksimum	<i>M</i>	<i>SD</i>
Vergi bilinci	408	1.00	5.00	2.41	1.01

Tablo 3'ü incelediğimizde vergi bilinci anketine verilen puanların minimum 1.00; maksimum 5.00; ortalamasının 2.41 ve standart sapmasının 1.01 olduğu görülmektedir. Elde edilen ortalamalara bakıldığında öğrencilerin vergi farkındalıklarının düşük olduğu sonucuna ulaşılmıştır.

Tablo 4.

Sizce Vergi Nedir? Sorusuna Ait Betimsel İstatistikler

Sizce vergi nedir?	<i>f</i>	%
Devletin sunduğu hizmetlerin karşılığıdır	214	52.5
Vatandaşlık görevidir	76	18.6
Zorunlu olarak ve karşılıksız yapılan ödemedir	54	13.2
İnsanlar üzerinde bir yüküdür	35	8.6
İşletmelerin büyümesini engelleyen bir uygulamadır	29	7.1

Tablo 4 incelendiğinde, vergi bilinci anketinde yer alan "Sizce vergi nedir?" sorusuna öğrencilerin %52.5'i "Devletin sunduğu hizmetlerin karşılığıdır", %18.6'sı "Vatandaşlık görevidir", %13.2'si "Zorunlu olarak ve karşılıksız yapılan ödemedir", %8.6'sı "İnsanlar üzerinde bir yüküdür" ve %7.1'i "İşletmelerin büyümesini engelleyen bir uygulamadır" cevabını verdikleri görülmüştür. En yüksek frekansa sahip "Devletin sunduğu hizmetlerin karşılığıdır" cevabının, en düşük frekansa sahip "İşletmelerin büyümesini engelleyen bir uygulamadır" cevabının olduğu görülmüştür.

Tablo 5.*Sizce Vergi Nedir? Sorusuna Ait Betimsel İstatistikler*

Vergi kelimesini ilk nerede duydunuz?	<i>f</i>	%
Ailemden	131	32.1
Okuldan	148	36.3
Gazete/ dergi/ tv vb.	62	15.2
Çevremden	67	16.4

Tablo 5 incelendiğinde, vergi bilinci anketinde yer alan “Vergi kelimesini ilk nerede duydunuz?” sorusuna öğrencilerin %32.1’i “Ailemden”, %36.3’ü “Okuldan”, %15.2’si “Gazete/ dergi/ tv vb.” ve %16.4’ü “Çevremden” cevabını verdikleri görülmüştür. En yüksek frekansa sahip “Okuldan” cevabının, en düşük frekansa sahip “Gazete/ dergi/ tv vb.” cevabının olduğu görülmüştür.

Tablo 7.*Vergi Bilinci Anketi Yaş Değişkenine Göre Anova Testi*

Anket	Yaş	<i>n</i>	<i>M</i>	<i>SD</i>	<i>f</i>	<i>p</i>	Post-hoc
Vergi Bilinci	11	191	1.94	.94	38.10	.00**	12>11
	12	164	2.70	.87			13>11
	13	48	3.25	.83			13>12
	14	5	3.16	.20			14>11

***p*<.01; **p*<.05

Tablo 7 değerlendirildiğinde vergi bilinci anketindeki ortalamalarda öğrencilerin yaş değişkenine göre anlamlı farklılık olduğu sonucuna ulaşılmıştır (*p*<.05). 12 yaşındaki öğrencilerin ankete vermiş oldukları puan ortalamalarının (2.70±.87) 11 yaşındaki öğrencilerin puan ortalamalarından (1.94±.94) daha yüksek olduğu ve 12 yaşındaki öğrencilerin vergi farkındalıklarının 11 yaşındaki öğrencilere göre daha yüksek olduğu görülmüştür. 13 yaşındaki öğrencilerin ankete vermiş oldukları puan ortalamalarının (3.25±.83) 11 yaşındaki öğrencilerin verdikleri puan ortalamalarından (1.94±.94) ve 12 yaşındaki öğrencilerin puan ortalamalarından (2.70±.87) daha yüksek olduğu ve 13 yaşındaki öğrencilerin vergi farkındalıklarının 11 ve 12 yaşındaki öğrencilerden yüksek olduğu görülmüştür. 14 yaşındaki öğrencilerin vergi bilinci anketine vermiş oldukları puan ortalamalarının (3.16±.20) 11 yaşındaki öğrencilerin vermiş oldukları puan ortalamalarından (1.94±.94) daha yüksek olduğu ve 14 yaşındaki öğrencilerin vergi farkındalıklarının 11 yaşındaki öğrencilerden yüksek olduğu görülmüştür.

Tablo 8.*Vergi Bilinci Anketi Sınıf Değişkenine Göre t testi*

Anket	Sınıf	<i>n</i>	<i>M</i>	<i>SD</i>	<i>t</i>	<i>p</i>
Vergi bilinci	6	204	1.73	.75	-18.63	.00**
	7	204	3.10	.74		

***p*<.01; **p*<.05

Tablo 8 incelendiğinde, 7. sınıf öğrencilerin vergi bilinci anketine vermiş oldukları puan ortalamalarının (3.10±.74) 6. sınıf öğrencilerin vermiş oldukları puan ortalamalarından (1.73±.75) daha yüksek olduğu ve 7. sınıf öğrencilerin vergi bilinci farkındalıklarının 6. sınıf öğrencilerinden daha yüksek olduğu görülmüştür.

Tablo 9.

Vergi Bilinci Anketi Cinsiyet Değişkenine Göre t-testi

Anket	Cinsiyet	n	M	SD	t	p
Vergi bilinci	Kız	207	2.88	1.00	10.62	.00**
	Erkek	201	1.93	.78		

**p<.01; *p<.05

Tablo 9 incelendiğinde, kız öğrencilerin vergi bilinci anketine vermiş oldukları puan ortalamalarının (2.88±1.00) erkek öğrencilerin vermiş oldukları puan ortalamalarından (1.93±.78) daha yüksek olduğu ve kız öğrencilerin vergi farkındalıklarının erkek öğrencilerden daha yüksek olduğu görülmüştür.

Tartışma ve Sonuç

Literatürde İlköğretim ve ortaöğretim düzeyindeki öğrencilerin vergi bilincini belirlemeye yönelik çalışmalar yer almaktadır. Bu çalışmalar arasında Çelik (2013), Güngüneş (2022), Karaca (2015), Karaot (2010), Zorlu (2012) ilköğretim çağındaki öğrencilerin vergi bilincini belirlemeye yönelik araştırma yapmıştır. Gür (2019), Yıldız ve Bakır (2019), ortaöğretim öğrencilerinde vergi bilincini belirlemeye yönelik araştırma yapmıştır. Zorlu (2012) ve Karaca (2015) tarafından yapılan çalışmalar, öğrencilerin vergi algıları ile cinsiyet, ikamet yeri anne-baba öğrenim düzeyleri, ailelerinin aylık gelirleri arasında anlamlı bir farklılık olmaması yönünden paralellik göstermektedir. Araştırmada öğrencilerin ailelerinin gelir durumu, anne-baba öğrenim düzeyi ile vergi farkındalığı arasında anlamlı bir farklılık olduğu görülmüştür. Bu konuda Torgler ve Schaltegger (2005) araştırmasında öğrenim düzeyi yüksek mükelleflerin eleştirel bakış açılarının daha yüksek olması sebebiyle vergiye uyumlarının daha düşük olduğu sonucuna ulaşmıştır. Çelik (2013), Güngüneş (2022), Gür (2019), Zorlu (2012) çalışmalarında öğrencilerin yaşları ile vergi algıları arasında anlamlı farklılık olduğunu ortaya koymuştur. Araştırmanın sonucu literatürdeki sonucu destekler niteliktedir. Üniversite öğrencilerinin vergi bilincini değerlendirmeye yönelik çalışma yapanlar arasında Akkara (2016), Macit (2023), Karacan (2019), Kaya (2018), Suzan Demir (2023) yer almaktadır. Karacan (2019), önlisans öğrencileri ile yaptığı çalışmada 2. sınıf öğrencilerin 1. sınıf öğrencilerine göre vergi bilinçlerinin daha yüksek olduğu sonucuna ulaşmıştır.

Bu çalışmada ortaokul öğrencilerinin vergi farkındalıkları incelenmiştir ve vergi bilincine sahip bireyler yetiştirilmesine yardımcı olmak amaçlanmıştır. 12, 13 ve 14 yaşındaki öğrencilerin vergi bilinci düzeylerinin 11 yaşındaki öğrencilerden yüksek olduğu; 13 yaşındaki öğrencilerin vergi bilinci düzeylerinin 12 yaşındaki öğrencilerden yüksek olduğu sonucuna ulaşılmıştır. Yapılan çalışmada, öğrencilerin sınıf değişkenine göre vergi bilinci düzeyleri arasında anlamlı bir farklılık olduğu tespit edilmiştir. 7. sınıf öğrencilerin vergi bilinci farkındalıklarının 6. sınıf öğrencilerden daha yüksek olduğu sonucuna ulaşılmıştır. Yapılan çalışmada, öğrencilerin cinsiyet değişkenine göre vergi bilinci düzeyleri arasında anlamlı farklılık olduğu tespit edilmiştir. Kız öğrencilerin vergi bilinci farkındalıklarının erkek öğrencilerden daha yüksek olduğu sonucuna ulaşılmıştır.

Öneriler

6. ve 7. sınıf öğrencilerinin vergiyi en çok duydukları yerin okul ve aile olması sebebiyle okulda ve aile içinde verilen eğitimlerle vergi bilinci farkındalıkları artırılmalıdır.

7. sınıf öğrencilerinin vergi bilinci farkındalıklarının 6. sınıf öğrencilerinden yüksek olmasına bağlı olarak 6. sınıfta vergi bilincini artırmaya yönelik etkinlikler artırılmalıdır.

Bu araştırma 6. ve 7. sınıf öğrencileriyle sınırlı olduğu için bu alanda sonraki çalışmalara 8. sınıf öğrencilerinin de dâhil edilmesi önerilmektedir.



<http://www.tayjournal.com>

<https://dergipark.org.tr/en/pub/tayjournal>

Examination of The Relationship between Physical Activity Level and Social Skills Level of Individuals Diagnosed with Special Learning Disability*

 Musa Türkmen, PhD Student, Corresponding Author
İnönü University, Türkiye
mstrkmn4455@gmail.com
Orcid ID: 0000-0001-5606-444X

 Mustafa Kaya, Prof. Dr.
Sivas Cumhuriyet University, Türkiye
mustafakaya58@cumhuriyet.edu.tr
Orcid ID: 0000-0002-8158-4671

Article Type: Research Article

Received Date: 08.06.2023

Accepted Date: 16.07.2024

Published Date: 31.07.2024

Plagiarism: This article has been reviewed by at least two referees and scanned via a plagiarism software

Doi: 10.29329/tayjournal.2024.653.03

Citation: Türkmen, M., & Kaya, M. (2024). Examination of the relationship between physical activity level and social skills level of individuals diagnosed with special learning disability. *Türk Akademik Yayınlar Dergisi (TAY Journal)*, 8(2), 246-262.

*This article was produced from Musa Türkmen's master's thesis supervised by Prof. Dr. Mustafa Kaya.

Abstract

The aim of this study is to examine the relationship between physical activity level and social skill level of individuals diagnosed with special learning disabilities. The research is descriptive by nature, one of the quantitative research models (screening). A total of 210 (100 female, 110 male) individuals diagnosed with Special Learning Disability [SLD] participated in the study. The 'International Physical Activity Questionnaire (Short)' was used to determine the physical activity level of individuals, and the 'Social Skills Scale for Children' was used to determine the social skill level. The data of the research were analyzed with the SPSS 25 package program. As a result of the normality analysis, it was determined that the data were normally distributed. For this reason, statistical analyzes were made with the Independent Sample t-test and One-Way Analysis of Variance, which are parametric tests. Pearson correlation analysis was performed to determine the relationship between the groups. The significance value was determined as $p < .05$. No significant difference was found between the social skills of individuals according to gender, and there was no significant difference between the physical activity levels of individuals according to gender ($p > .05$). A positive and significant relationship was found between individuals' physical activity level and social skill level ($r = .367$, $p < .001$). According to the results of the study, as the level of physical activity increments individuals with SLD, the level of social skills also increases. These individuals should be encouraged to participate in physical activities such as exercise, games and sports in order to increase their social skill levels.

Keywords: Learning disability, physical activity, social skills.

Introduction

More than an estimated 1 billion (15%) of the world's population suffer from some form of disability and this number increases day by day. Studies show that the most common group among disability groups is individuals with special learning difficulties known as late and difficult learning (World Health Organization [WHO], 2021). According to DSM-V data, the rate of SLD in school-aged individuals is between 5% and 15%, while this rate is 4% in adults (Koroğlu, 2014).

According to the latest statistics, the population of our country is 83.614.362. The child population is 22,750,657 (27.2%) (Turkish Statistical Institute [TurkStat], 2020). According to the Disability Survey of Turkey (2002), the disability rate in Turkey is 12.3. Learning difficulties constitute 0.48 of these rates (TurkStat, 2002). According to the published Turkey Health Survey report (2020), individuals between the ages of 15-75 who have difficulty in learning 3.4% in 2012, 6.7% in 2014, 6.7% in 2016 and 5.4% in 2019. It is seen that the rate of individuals who have difficulty in learning among children at the age of 12 is 1.1% in 2019. (TurkStat, 2020). As can be seen, the rate of individuals diagnosed with SLD in the total population has tended to increase in recent years.

Having a learning disability with normal or above-normal intelligence capacity, no mental illness, and no problems in using brain functions and affective skills; It refers to the situation of individuals who have inadequacy in communication, reading and writing skills, cognitive, and mathematical operations and turning them into skills (Korkmazlar, 1999). Individuals with SLD also have poor social perception and interactions, and poor self-management skills (Hammill, 1990). Apart from these reasons, learning disabilities seen in

individuals with physical, mental, auditory, and visual disabilities, experiencing various emotional disorders, and socioeconomically disadvantaged individuals are not included in the scope of learning disabilities (Individuals with Disabilities Education Improvement Act [IDEA], 2004).

In addition to increasing the resistance of individuals to diseases, keeping their body weights at a normal level, and helping to prevent various diseases, physical activities also improve the mental health, quality of life and living standards of individuals (Arslandoğan et al., 2021; Kurtoğlu et al., 2022). It is seen that regular physical activity contributes to the psychological development of individuals, increases the quality of life, and has positive effects on stress and social variables (Kurtoğlu et al., 2022; Reynolds et al., 1990).

The development of physical activity and sportive activities, which are a part of education and training activities, necessitated further studies on the physical, mental, and social development of individuals with special needs. Physical activity and sportive activities contribute to the physical, emotional, cognitive, and social development of individuals and positively affect individuals in terms of their integration into society (Kurtoğlu et al., 2023). The initial studies conducted with individuals diagnosed with ASD focused on their physical performance, reporting frequent motor impairments and low physical performance (Bluechartd & Shephard, 1996; Demirci & Toptaş-Demirci, 2016). Subsequent research has focused on the effects of exercise interventions on physical fitness parameters in these individuals and has demonstrated the effectiveness of exercise interventions (Yılmaz et al., 2017). No other research has been found that examines the relationship between physical activity levels and social skills in these individuals.

It is extremely important to facilitate the social adaptation of individuals with learning disabilities, to remind them that they are a part of social life, and to carry out studies in this direction. This study aims to examine the relationship between the level of physical activity and social skill levels of individuals with SLD. According to the results of this study, experts will have the opportunity to organize the educational environment and educational process of these individuals. Families will have more information about their children's development and adaptation to social life. Healthy steps can be taken towards the development of the individual on the axis of family, individual, and school. It has been observed that there are few studies (Bluechartd and Shephard, 1996; Demirci and Toptaş-Demirci, 2016; Yılmaz et al., 2017) in the physical learning literature on participants who have special learning disability with this OGG, so it is thought that the results of our study will fill a gap in the literature. More than an estimated 1 billion (15%) of the world's population suffer from some form of disability and this number is increasing day by day. Studies show that the most common group among disability groups is individuals with special learning difficulties known as late and difficult learning (WHO, 2021). According to DSM – V data, the rate of SLD in school-aged individuals is between 5% and 15%, while this rate is 4% in adults (Köroğlu, 2014).

Method

Research Model

The research is descriptive, one of the quantitative research models (Akarsu, 2019). Descriptive research comprises studies carried out in large groups to receive opinions and observe the attitudes of individuals in such groups concerning a fact or event, as well as describing these facts and events (Karakaya, 2012). The purpose of descriptive studies is to describe individuals, events, or conditions by studying them as they are in nature (Houser, 2008). In this type of research, the researcher does not manipulate any of the variables but rather only describes the sample and/or the variables (Stangor & Wallings, 2014).

Participants

The research is descriptive, one of the quantitative research models (Akarsu, 2019). Participants in the study were determined by simple random sampling method. The participants included in the study consist of individuals diagnosed with Specific Learning Disability who have mild symptoms and normal or near-normal intelligence scores (Deniz et al., 2009). The individuals participating in the study were evaluated in terms of medical and educational aspects and were diagnosed with SLD. The medical diagnosis was made by the Training and Research Hospitals, and the educational diagnosis was made by the Sivas Guidance and Research Center [RAM] after the necessary evaluations were completed. The population of the research consists of individuals with a diagnosis of SLD who are educated in secondary education institutions in Sivas. Among these individuals, those with any diagnosis other than SLD were not included in the study. G Power 3.1 software was used to determine the research sample size (Cohen, 1992). In the power analysis, Type I error ($\alpha=.05$), (power= $1-\beta$) .80 effect size 2.2, it was determined that at least 190 participants should participate in the study. In this context, a total of 210 participants, 100 female (Age; 15.88 ± 1.328), and 110 male (Age; 15.67 ± 1.539) were included in this study.

Data Collection

Necessary information about the research was given to the individuals participating in the study. They were asked to read the survey questions carefully. It was stated that the research was based on volunteerism. During the application, the necessary feedbacks was given to the questions from the individuals. An 8 item Personal Information Form was prepared to determine the demographic characteristics of the individuals participating in the research. In this form, individuals were asked about their age, height, weight, gender, which grade they were and where they lived (city center, district center, village).

International Physical Activity Questionnaire (Short Form) (IPAQ)

The IPAQ is a questionnaire used in determining the level of physical activity, the validity and reliability of which was made by Öztürk. This scale is used 15-65 age for individuals. In this study, it was used to determine the physical activity level of individuals with SLD (Öztürk, 2005). The participants were asked to think back on the previous week's activities. With a survey consisting of 7 questions in total, the number of days and duration of physical activity in the previous week was determined and the energy which is consumed by

individuals in a week was calculated. The weekly required energy is calculated by calculating the Metabolic Equation (MET-min/week) score. This calculation;

$$\text{MET-min/week} = \text{Standard Value} \times \text{Number of Days of Activity} \times \text{Duration (min)}$$

After these scores are calculated, the classification is as follows (Savcı et al., 2006).

- Inactive Category: <600 MET-min/week
- Minimally Active: 600-3000 MET min/week
- Very Active: >3000 MET min/week

Individuals with MET min/week scores in the inactive category were classified as low FA, minimally active individuals as moderate FA, and highly active individuals as high FA.

Social Skills Scale for Children

The "Social Skills Scale" was developed by Yurdakavuştu (2012) and was used in this study to measure the social skill levels of individuals with SLD. The fact that the items in the scale were short, clear, and understandable provided convenience at the point of application in individuals with SLD. The scale has a total of 20 items. It is prepared as a 4-point Likert scale. Scoring the answers given to the scale; always: 4 points, often: 3 points, occasionally: 2 points, and never: 1 point. Accordingly, a minimum of 20 points and a maximum of 80 points can be obtained from this scale. The scores obtained from the scale throughout the research reveal the social skill levels of the children. The validity and reliability study of the scale was carried out and the Cronbach alpha reliability coefficient was found to be .87. This scale has no sub-dimensions.

Statistical Analysis

Statistical analyses of the research were made with the SPSS 25 package program. Variables in the personal information form; Evaluated in terms of percentage (%), frequency, and mean values. Normality analyses of the data were performed with Kolmogorow-Smirnov and Shapiro-Wilk tests. It was determined that the data were normally distributed and for two-group comparisons, the Independent Sample t-test, one of the parametric tests, was performed with One-Way Analysis of Variance for more than two-group analysis. In addition, Scheffe and Tukey HSD tests from Post Hoc tests were applied to determine the relationship between groups. In our study, the level of significance was determined as $p < .05$. Pearson correlation analysis was performed to determine the relationship between the groups (-1, +1).

Ethical Permits of Research:

In this study, all the rules specified to be followed within the scope of "Higher Education Institutions Scientific Research and Publication Ethics Directive" were complied with. None of the actions specified under the heading "Actions Contrary to Scientific Research and Publication Ethics", which is the second part of the directive, have been taken.

Ethics Committee Permission Information:

Name of the committee that made the ethical evaluation = Sivas Cumhuriyet University Scientific Research and Publication Ethics Social and Human Sciences Committee

Date of ethical review decision= 04.10.2021

Ethics assessment document issue number= 2021-10-11/15

Findings

Table 1.

Personal Information of Participants

		<i>f</i>	<i>%</i>
Grade	9 th grade	77	36.7
	10 th grade	52	24.8
	11 th grade	45	21.4
	12 th grade	36	17.1
Gender	Girl	100	47.6
	Male	110	52.4
Living place	Town center	124	59.0
	District center	52	24.8
	Village	34	16.2

When the personal information table of the participants is examined; 100 (47.6%) of the 210 people participating in the research are women and 110 (52.4%) are men. Of these individuals, 77 (36.7%) were 9th grade, 52 (24.8%) were 10th grade, 45 (21.4%) were 11th grade and 36 (17.1%) were 12th grade student. It is seen that the number of individuals residing in the city center is 124 (59.9%), the number of individuals residing in the district center is 52 (24.8%) and finally the number of individuals residing in the village is 34 (16.2%).

Table 2.

Comparison of Participants' Social Skill Scores by Gender

Gender	<i>n</i>	<i>M ± SD</i>	<i>t</i>	<i>p</i>
Female	100	59.100±11.870	.416	.193
Male	110	58.381±13.048		

When the Independent Samples t-test comparison table of the total social skill scores of the participants by gender was examined, no significant difference was found between the social skill total scores of women and men ($p > .05$).

Table 3.

Comparison of Participants' MET ml/kg/min Scores by Gender

Gender	<i>M ± SD</i>	<i>t</i>	<i>p</i>
Female	2269.1±2677.4	-1.778	.158
Male	2932.8±2724.0		

When the Independent Samples t-test comparison table of the MET ml/kg/min scores of the participants by gender was analyzed, no significant difference was found between the MET ml/kg/min averages of women and the MET ml/kg/min averages of men ($p > .05$).

Table 4.*Comparison of Physical Activity Level and Social Skill Level*

Physical activity level	<i>M ± SD</i>	Min.	Max.	<i>f</i>	<i>p</i>
Low PA (n=35)	45.6±11.7	20.0	63.0	44.818	.000**
Middle PA (n=119)	58.7±10.4	20.0	76.0		
High PA (n=56)	66.9±9.5	32.0	80.0		
Total	58.7±12.4	20.0	80.0		

When Table 4 is examined, a significant difference was found between the social skills of individuals with low physical activity 45.600±11.760, moderate physical activity 58.705±10.479, and high physical activity 66.964±9.574 ($p < .001$). According to the results of the Tukey HSD test, it was observed that the social skills of individuals with high physical activity levels were higher.

Table 5.*Examining the Relationship Between Participants' MET Values and Social Skill Scores*

Parameters	<i>M ± SD</i>	<i>r</i>	<i>p</i>
MET ml/kg/min	2616.8±2715.8	.367	.000**
Social skill score	58.7±12.4		

When the Pearson correlation results of the relationship between individuals' mean MET ml/kg/min mean scores and their total mean scores for social skills were examined, it was determined that there was a significant positive relationship for these values ($r = .367$, $p < .001$).

Discussion and Conclusion

In addition to the limitations observed in cognitive skills, individuals diagnosed with Specific Learning Disability [SLD] may also experience problems in their physical and social skills. Identifying the relationship between the level of participation in physical activities and the level of social skills in these individuals could be beneficial for rehabilitating potential limitations they face. For this purpose, it is aimed to determine the correlation between the level of physical activity and the level of social skills in individuals diagnosed with SLD. As there lack many research looking at social skills and physical activity levels in people with SLD, the results were compared with those from other studies. We believe that our study is groundbreaking in this regard.

When comparing the social skill scores of individuals diagnosed with SLD who participated in the study by gender, it was found that there was no significant difference in the social skill levels between female and male students ($p > .05$). According to a study by Kalafat and Kınca (2008), women scored on average higher than men did for social skills. Furthermore, research revealed that women who engaged in physical activities in secondary education institutions have much better social skills than men who did the same (Akbaş & Eyüboğlu, 2019). Examining the literature reveals that our research on gender differences in social skill levels is not consistent with the level found in it. It is believed that the variation in the sample group is the cause of this discrepancy.

When comparing the physical activity levels of individuals diagnosed with SLD who participated in the study by gender, it was found that although males had a higher average

score, these averages were not statistically significant ($p > .05$). In a study conducted by DeWolfe et al., (2020) the researchers investigated the physical activity levels of individuals based on their gender. The findings revealed that women exhibited a lower level of physical activity compared to men. A separate investigation analyzed the prevalence of obesity, levels of physical activity, and adherence to good lifestyle habits among teenage children. The study revealed a considerable disparity in physical activity based on gender, with boys exhibiting higher levels of physical activity compared to females (Coşkun & Karagöz, 2021). Unlike the aforementioned research, a recent study investigating the social skills and physical activity attributes of secondary school students revealed that there was no statistically significant correlation between physical activity and the gender variable (Kara & Şahin, 2021). Upon reviewing the literature, it was observed that there were both similar and distinct studies in relation to our own study. The variation in the physical activity level of patients diagnosed with SLD according to gender is believed to be attributed to the disparity in the sample group.

This study discovered that there is a positive correlation between the physical activity level and social abilities of patients diagnosed with SLD. When the physical activity level grew, correspondingly rose the level of social skills. Based on these findings, it was concluded that there exists a notable and favorable association between the degree of physical exercise and the level of social skills in persons. According to Zhao and Chen (2018), a physical activity plan enhances individuals' social abilities. Furthermore, a study conducted by Ilkm (2018) revealed that children's social adaption and skill levels experienced enhancement as a result of their involvement in athletic endeavors. Furthermore, Zaboni and Solari (2019), discovered that engaging in physical activities had a good impact on the social skills of individuals and led to an improvement in problem behaviors. Participating in physical activity has a favorable impact on persons' social abilities, as shown by another study. According to a paper by Kuruoğlu and Uzunçayır (2020), increasing the degree of physical activity in individuals has a favorable impact on behaviors such as beginning and maintaining communication, emotional skills, self-control, accepting results, and following directions. In a study by Aksoy (2020) investigating the impact of recreational physical activity on the social development of individuals with autism, it was observed that those who engaged in physical activities demonstrated higher levels of social development compared to those who did not participate. The involvement in physical activity had a positive influence on individuals' social skills, self-control, group cooperation, and communication abilities.

Furthermore, a study investigating the social skills and physical activity levels of students in secondary school revealed a direct correlation between an individual's physical activity level and their degree of social skills. According to a report by Kara and Şahin (2021), those who engage in regular physical activity possess superior social attitudes and communication skills compared to those who live a physically inactive lifestyle. Upon reviewing the literature, it becomes evident that the findings from studies investigating the correlation between physical activity and social skills are very consistent. These studies reveal a substantial and favorable association between the amount of physical activity and the level of social skills. It is believed that the amount of physical exercise has a favorable impact on social skills and enhances the social life of individuals, including various participant groups. The current body of literature supports our research.

Recommendations

The problems experienced by individuals with SLD during the process of displaying social skills can be reduced by participating in physical activity. Physically active individuals; can successfully fulfill their social roles, social duties, and responsibilities. Various activities and projects can be carried out to increase the physical activity levels of individuals with Special Learning Disability by carrying out studies based on the Ministry, schools, families, and students.

Various seminars can be organized for physical education teachers working under the Ministry of National Education and their families, and information can be given to individuals with SLD.

To determine the physical activities suitable for the developmental characteristics of individuals with a diagnosis, research can be conducted on these individuals.

Research on physical activity and social development can be done by taking the opinions of families and teachers who are close to individuals and have the opportunity to observe individuals constantly.

More research can be conducted to determine whether the level of physical activity and social skills are different according to the gender variable in individuals with SLD.

References

- Akarsu, B., & Akarsu, B. (2019). *Bilimsel araştırma tasarımı. Nicel, nitel ve karma araştırma yaklaşımları* [Scientific research design. Quantitative, qualitative and mixed research approaches]. Cinius.
- Akbaş, M., & Eyuboğlu, E. (2019). Ortaöğretim kurumlarında öğrenim gören öğrencilerin spor yapma değişkenlerine göre sosyal beceri düzeylerinin karşılaştırılması [Comparison of social skills levels of secondary school students according to variable of making sports]. *International Journal of Contemporary Educational Studies*, 5(2), 175-187.
- Aksoy, Y. (2020). Rekreatif faaliyet olarak fiziksel aktivitelerin otizmli çocuklarda sosyal iletişime yönelik etkileri [The effects of physical activity as recreational activity on social communication in children with autism]. *Gaziantep University Journal of Sport Science*, 5(1), 1-9.
- American Psychiatric Association (APA). (2014). *Ruhsal bozuklukların tanısal ve sayımsal elkitabı DSM-5* [Diagnostic and statistical manual of mental disorders DSM-5] (E. Koroğlu, Trans.). Hekimler Yayın Birliği.
- Arslandoğan, A., Türkmen, M., Töre, E., Demir, B., & Hazar, S. (2021). Covid-19 sürecinde fiziksel aktivite düzeyi ile mental iyi oluş arasındaki ilişkinin incelenmesi [The investigation of the relationship between physical activity level and mental well-being during the covid-19 process]. *Sivas Cumhuriyet University Journal of Sport Sciences*, 2(2), 67-75.
- Bluehardt, M., & Shephard, R. J. (1996). Motor performance impairment in students with learning disability: Influence of gender and body build. *Research in Sports Medicine: An International Journal*, 7(2), 133-140.
- Cohen, J. (1992). Statistical power analysis. *Current Directions in Psychological Science*, 1(3), 98-101.
- Coşkun, A., & Karagöz, Ş. (2021). Adölesan dönemdeki çocuklarda obezite sıklığı, fiziksel aktivite düzeyi ve sağlıklı yaşam biçimi davranışlarının incelenmesi [Investigation of obesity prevalence, physical activity level and healthy lifestyle behaviors in adolescent children]. *Turkish Journal of Sports Science*, 5(2), 63-72.
- Demirci, N., & Demirci, P. T. (2016). Özel öğrenme güçlüğü olan çocukların kaba ve ince motor becerilerinin değerlendirilmesi [The evaluation of rough and fine motor skills of disabled children having learning difficulties]. *Inonu University, Journal of Physical Education and Sport Sciences*, 3(1), 47-57.
- Deniz, M. E., Yorgancı, Z., & Özyeşil, Z. (2009). Öğrenme güçlüğü görülen çocukların sürekli kaygı ve depresyon düzeylerinin incelenmesi üzerine bir araştırma [A research on investigating the trait anxiety and depression levels of the students with learning disabilities]. *Elementary Education Online*, 8(3), 694-708.
- DeWolfe, C. E., Watt, M. C., Romero-Sanchiz, P., & Stewart, S. H. (2020). Gender differences in physical activity are partially explained by anxiety sensitivity in post-secondary students. *Journal of American College Health*, 68(3), 219-222.
- Hammill, D. D. (1990). On defining learning disabilities: An emerging consensus. *Journal of Learning Disabilities*, 23(2), 74-84.
- Houser, J. (2008). *Nursing research: Reading, using, and understanding evidence*. Jones & Bartlett.
- Ilkım, M., Kalaycı, M. C. K., Güleröğlü, F., & Gündoğdu, C. (2018). Down sendromlu çocuklarda sportif etkinliklere katılma durumuna göre sosyal uyum ve beceri düzeyinin incelenmesi [Examination of the social adaptation and skills on children who are down syndrome according to participation status in sportive activities]. *İnönü University International Journal of Social Sciences*, 7(1), 162-172.
- Individuals with Disabilities Education Act (IDEA). (2004). *Publication law* (No. 118 Stat. 2706). Retrieved July 18, 2023, from <https://ies.ed.gov/ncser/pdf/pl108-446.pdf>

- Kalafat, T., & Kıncal, R. Y. (2006). Üniversite öğrencilerinin beden memnuniyeti düzeyleri ile sosyal beceri düzeyleri arasındaki ilişkinin incelenmesi [The analysis of the interaction between the body gratification of university students and their level of skill]. *Buca Faculty of Education Journal*, (23), 41-47.
- Kara, A., & Şahin, M. (2021). Ortaokul öğrencilerinin sosyal beceri, fiziksel aktivite ve akademik başarı özelliklerinin incelenmesi [Secondary school students' social skills, physical activity and examining academic success characteristics]. *Journal of Health and Sport Sciences*, 4(2), 30-41.
- Karakaya, İ. (2012). Bilimsel araştırma yöntemleri [Scientific research methods]. In A. Tanrıoğen (Ed.) *Bilimsel araştırma yöntemleri* [Scientific research methods] (pp.57-83). Anı.
- Korkmazlar, Ü. (1999). Özel öğrenme bozukluğu (öğrenme güçlükleri) [Specific learning disorder (learning difficulties)]. In A. Ekşi (Ed.). *Ben hasta değilim, çocuk sağlığı hastalıklarının psiko-sosyal yönü* [I am not sick, psycho-social aspects of child health disorders] (2nd ed.). (pp. 285-299). Nobel Tıp.
- Kurtoğlu, A., Çar, B., & Konar, N. (2022). Comparison of physical and motoric characteristics of totally visually impaired and low vision individual. *Sportis Scientific Journal of School Sport, Physical Education and Psychomotricity*, 8(3), 414-425.
- Kurtoğlu, A., Konar, N., Akçınar, F., Çar, B., & Akkoyunlu, Y. (2022). Comparison of strength parameters in amputee football players according to the degree of amputation. *Pakistan Journal of Medical & Health Sciences*, 16(06), 485-485.
- Kurtoğlu, A., Kurtoğlu, E., Konar, N., Çar, B., Eken, Ö., Prieto-González, P., & Nobari, H. (2023). Comparison of echocardiographic parameters of amputee football players with active football players and sedentary individuals. *BMC Sports Science, Medicine and Rehabilitation*, 15(1), 1-9.
- Kuruoğlu, M. Y. A., & Uzunçayır, D. (2020). Zihinsel yetersizliği olan çocuklarda uyarlanmış su içi egzersizlerin sosyal beceriler üzerine etkisi [Impact of adapted aquatic exercises on social skills of children with intellectual deficiencies]. *Gazi Journal of Physical Education and Sport Sciences*, 25(2), 117-126.
- Learning Disabilities Association of America (LDA). (2023). *Disleksi* [Dyslexia]. Retrieved January 11, 2023, from <https://ldaamerica.org/disabilities/dyslexia/?audience=Educators>
- Ministry of National Education (MoNE). (2021). *Özel öğrenme güçlüğü olan bireyler. Aileler için rehber kitapçık* [Individuals with special learning disabilities. Guide booklet for families]. 18-19. Özel Eğitim ve Rehberlik Hizmetleri Genel Müdürlüğü. Retrieved July 11, 2023, from https://orgm.meb.gov.tr/meb_ays_dosyalar/2021_02/04102620_OYRENME_GUCLUYU_OLAN_BYREYLER_TR.pdf
- Öztürk, M. (2005). *Üniversitede eğitim-öğretim gören öğrencilerde uluslararası fiziksel aktivite anketinin geçerliliği ve güvenilirliği ve fiziksel aktivite düzeylerinin belirlenmesi* [Research on reliability and validity of international physical activity questionnaire and determination of physical activity level in university students]. (Publication No. 194366) [Master thesis, Hacettepe University]. National Thesis Center.
- Reynolds, K. D., Killen, J. D., Bryson, S. W., Maron, D. J., Taylor, C. B., Maccoby, N., & Farquhar, J. W. (1990). Psychosocial predictors of physical activity in adolescents. *Preventive Medicine*, 19(5), 541-551.
- Savcı, S., Öztürk, M., Arıkan, H., İnal İnce, D., & Tokgözoğlu, L. (2006). Physical activity levels of university students. *Archives of the Turkish Society of Cardiology*, 34(3), 166-172.
- Stangor, C., & Wallings, J. (2014). *Introduction to psychology*. BCcampus.
- Turkish Statistical Institute (TurkStat). (2021). *Türkiye sağlık araştırması* [Türkiye health survey]. Retrieved January 12, 2023, from <https://data.tuik.gov.tr/Bulten/Index?p=Turkiye-Saglik-Arastirmasi-2019-33661E>

- Turkish Statistical Institute ([TurkStat). (2021). *İstatistiklerle çocuk* [Child with statistics]. Retrieved January 12, 2023, from <https://data.tuik.gov.tr/Bulten/Index?p=Istatistiklerle-Cocuk-2020-37228>
- World Health Organization (WHO). (2023). *Engellilik* [Disability]. Retrieved February 5, 2023, from <https://www.who.int/news-room/fact-sheets/detail/disability-and-health>
- World Health Organization (WHO). (2023). *Fiziksel aktivite* [Physical activity]. Retrieved February 5, 2023, from <https://www.who.int/news-room/fact-sheets/detail/physical-activity-2020>
- Yılmaz, A., Karakaş, G., Baba-Kaya, H., & Kaçay, Z. (2017). The effects of sportive exercises on physical fitness of children with specific learning disability. *Acta Kinesiologica*, 11(1), 88-93.
- Yurdakavuştu, Y. (2012). *İlköğretim öğrencilerinde duygusal zekâ ve sosyal beceri düzeyleri* [Primary school students' emotional intelligence and social skill levels]. (Publication No. 317708) [Master thesis, Dokuz Eylül University]. National Thesis Center.
- Zanobini, M., & Solari, S. (2019). Effectiveness of the program “Acqua mediatrice di comunicazione” (Water as a mediator of communication) on social skills, autistic behaviors and aquatic skills in ASD children. *Journal of Autism and Developmental Disorders*, 49(10), 4134-4146.
- Zhao, M., & Chen, S. (2018). The effects of structured physical activity program on social interaction and communication for children with autism. *BioMed Research International*, 1-13.

BIOGRAPHICAL NOTES

Contribution Rate of Researchers

Author 1: 50%

Author 2: 50%

Conflict Statement

There is no conflict of interest that the authors will declare in the research.

Özel Öğrenme Güçlüğü Olan Bireylerin Fiziksel Aktivite Düzeyi ile Sosyal Beceri Düzeyi Arasındaki İlişkinin İncelenmesi



Özet

Bu çalışmanın amacı, özel öğrenme güçlüğü tanısı almış bireylerin fiziksel aktivite düzeyi ile sosyal beceri düzeyi arasındaki ilişkiyi incelemektir. Araştırma, nicel araştırma modellerinden biri olan tarama modelinde, betimsel niteliktedir. Çalışmaya, Özel Öğrenme Güçlüğü [ÖÖG] tanısı almış toplam 210 birey (100 kadın, 110 erkek) katılmıştır. Bireylerin fiziksel aktivite düzeylerini belirlemek için 'Uluslararası Fiziksel Aktivite Anketi (Kısa Form) ve sosyal beceri düzeylerini belirlemek için 'Çocuklar İçin Sosyal Beceriler Ölçeği' kullanılmıştır. Araştırmanın verileri SPSS 25 paket programı ile analiz edilmiştir. Normallik analizi sonucunda verilerin normal dağıldığı belirlenmiştir. Bu nedenle, istatistiksel analizler parametrik testler olan Bağımsız Örneklem t-testi ve Tek Yönlü Varyans Analizi ile yapılmıştır. Gruplar arasındaki ilişkiyi belirlemek için Pearson korelasyon analizi yapılmıştır. Anlamlılık değeri $p < .05$ olarak belirlenmiştir. Cinsiyete göre bireylerin sosyal becerileri arasında ve fiziksel aktivite düzeyleri arasında anlamlı bir fark bulunmamıştır ($p > .05$). Bireylerin fiziksel aktivite düzeyi ile sosyal beceri düzeyi arasında pozitif ve anlamlı bir ilişki bulunmuştur ($r = .367$, $p < .001$). Çalışmanın sonuçlarına göre, ÖÖG tanısı almış bireylerin fiziksel aktivite düzeyi arttıkça, sosyal beceri düzeyleri de artmaktadır. Bu bireylerin sosyal beceri düzeylerini artırmak için egzersiz, oyun ve spor gibi fiziksel aktivitelere katılmaları teşvik edilmelidir.

Anahtar Kelimeler: Öğrenme güçlüğü, fiziksel aktivite, sosyal beceriler.

Giriş

Öğrenme güçlüğü, normal veya normalin de üstünde zeka kapasitesi olan ruhsal rahatsızlığı, beyin fonksiyonlarını kullanma sorunları olmayan; iletişim kurma, okuma ve yazma, akıl yürütme ile matematiksel işlemleri beceriye dönüştürme noktasında yetersizlik yaşayan bireylerin durumunu ifade etmektedir. Özel Öğrenme Güçlüğü [ÖÖG] tanımlı bireyler sosyal algı ve etkileşimlerde, kendini idare etme becerileri zayıftır. Fiziksel, zihinsel, işitsel, görsel yetersizlikleri olan, çeşitli duyu bozuklukları yaşayan ve sosyoekonomik açıdan dezavantajlı bireylerdeki öğrenme yetersizlikleri bu kapsamda değerlendirilmemektedir.

Eğitim öğretim faaliyetlerinin bir parçası olan fiziksel aktivite ve sportif faaliyetlerin zamanla gelişmesi özel gereksinimli bireylerin fiziksel, zihinsel ve sosyal gelişimlerine yönelik daha fazla çalışmanın yapılmasını gerekli kılmıştır. Fiziksel aktivite ve sportif faaliyetler bireylerin fiziksel, duygusal, bilişsel ve sosyal gelişimlerine katkı sağlamakta, topluma entegrasyonları noktasında bireyleri olumlu yönde etkilemektedir. Öğrenme güçlüğü tanımlı bireylerin sosyal adaptasyonunu kolaylaştırmak toplumsal hayatın bir parçası olduklarını hatırlatmak ve bu yönde çalışmalar yapmak son derece önemlidir.

Bu araştırmanın amacı; ÖÖG tanımlı bireylerin fiziksel aktivite yapma düzeyi ile sosyal beceri düzeyleri arasındaki ilişkinin incelenmesidir. Uzmanlar bu çalışmanın sonucuna göre bu bireylerin eğitim ortamlarını ve eğitim sürecini düzenleme imkanı bulabileceklerdir. Aileler, çocuklarının gelişimine ve sosyal hayata adaptasyonu konusunda daha fazla bilgi sahibi

olacaktır. Aile, birey ve okul ekseninde bireyin gelişimine yönelik sağlıklı adımlar atılabilecektir.

Yöntem

Araştırmada nicel araştırma modellerinden betimsel (tarama) modeli kullanılmıştır (Akarsu, 2019). Araştırmaya katılan bireyler, tıbbi ve eğitsel açıdan değerlendirilmiş ve ÖÖG tanısı almıştır. Tıbbi tanısı Eğitim ve Araştırma hastaneleri tarafından yapılmış, eğitsel tanısı ise Sivas Rehberlik ve Araştırma Merkezi [RAM] tarafından gerekli değerlendirmeler yapıldıktan sonra konulmuştur. Araştırmanın evrenini Sivas ilindeki ortaöğretim kurumlarında eğitim gören ÖÖG tanılı bireyler oluşturmaktadır. Bu bireylerden ÖÖG tanısı dışında herhangi bir tanısı olanlar araştırmaya dahil edilmemiştir. Bu bağlamda araştırmaya 210 (100 kadın, 110 erkek) katılımcı dahil edilmiştir.

Veri toplama aracı olarak, araştırmaya katılan bireyler için 8 maddelik Kişisel Bilgi Formu hazırlanmıştır. Uluslararası Fiziksel Aktivite Anketi [UFAA] fiziksel aktivite düzeyini belirlenmesinde kullanılan geçerliliği ve güvenilirliği Öztür (2005) tarafından yapılan bir anket kullanılmıştır. Ayrıca, ÖÖG tanılı bireylerin sosyal beceri düzeylerini ölçmek için Yurdakavuştu (2012) tarafından geliştirilen "Çocuklar için Sosyal Beceri Ölçeği" kullanılmıştır.

Araştırmanın istatistiksel analizleri SPSS 25 paket programı ile yapılmıştır. Kişisel bilgi formundaki değişkenler; yüzde (%), frekans, ortalama değerler açısından değerlendirilmiştir. Verilerin normallik analizleri Kolmogorow-Smirnov ve Shapiro Wilk testleri ile yapılmıştır. Parametrik testlerden Bağımsız Örneklem t-testi, ikiden fazla grup analizleri için Tek Yönlü Varyans Analizi ile yapılmıştır. Ayrıca gruplar arası ilişkinin belirlenmesi için Post Hoc testlerinden Scheffe ve Tukey HSD testleri uygulanmıştır. Gruplar arasındaki ilişkinin belirlenmesi için Pearson korelasyonu analizi yapılmıştır (-1, +1).

Araştırmanın Etik İzinleri:

Bu çalışmada "Yükseköğretim Kurumları Bilimsel Araştırma ve Yayın Etiği Yönergesi" kapsamında uyulması gerektiği belirtilen tüm kurallara uyulmuştur. Yönergenin ikinci bölümü olan "Bilimsel Araştırma ve Yayın Etiğine Aykırı Eylemler" başlığı altında belirtilen eylemlerin hiçbiri gerçekleştirilmemiştir.

Etik Kurul İzin Bilgileri:

Etik değerlendirmeyi yapan kurulun adı = Sivas Cumhuriyet Üniversitesi Bilimsel Araştırma ve Yayın Etiği Sosyal ve Beşeri Bilimler Kurulu

Etik Kurul Etik inceleme karar tarihi= 04.10.2021

Etik değerlendirme belgesi konu numarası= 2021-10-11/15

Bulgular

Tablo 1.

Cinsiyete göre Katılımcıların Sosyal Beceri Puanlarının Karşılaştırılması

Değişkenler	<i>n</i>	<i>M ± SD</i>	<i>t</i>	<i>p</i>
Kadın	100	59.100±11.870	.416	.193
Erkek	110	58.381±13.048		

Cinsiyete göre katılımcıların sosyal beceri toplam puanlarının Independent Samples t-test karşılaştırılması tablosu incelendiğinde kadınlar ile erkeklerin sosyal beceri toplam puan ortalamaları arasında anlamlı fark tespit edilmemiştir ($p > .05$).

Tablo 2.

Cinsiyete göre Katılımcıların MET ml/kg/dk Puanlarının Karşılaştırılması

Değişkenler	n	M ± SD	t	p
Kadın	100	2269.160±2677.484	-1.778	.158
Erkek	110	2932.854±2724.006		

Cinsiyete göre katılımcıların MET ml/kg/dk puanlarının Bağımsız Örneklem t-testi karşılaştırılması tablosu incelendiğinde kadınların MET ml/kg/dk ortalamaları ile erkeklerin MET ml/kg/dk puan ortalamaları arasında anlamlı fark tespit edilmemiştir ($p > .05$).

Tablo 3.

Fiziksel Aktivite Düzeyi ile Sosyal Beceri Düzeyinin Karşılaştırması

Değişkenler	n	M ± SD	Min.	Max.	f	p
Düşük FA	35	45.600±11.760	20.00	63.00	44.818	.000**
Orta FA	119	58.705±10.479	20.00	76.00		
Yüksek FA	56	66.964±9.574	32.00	80.00		
Toplam	210	58.723±12.476	20.00	80.00		

** $p < .001$ FA: Fiziksel Aktivite

Tablo 3 incelendiğinde; düşük fiziksel aktivite 45.600±11.760, orta fiziksel aktivite 58.705±10.479 ve yüksek fiziksel aktivite 66.964±9.574 düzeyinde olan bireylerin sosyal becerileri arasında anlamlı fark tespit edilmiştir ($p < .001$). Yapılan Tukey HSD testi sonucuna göre fiziksel aktivite düzeyi yüksek olan bireylerin sosyal becerilerinin daha yüksek olduğu görülmüştür.

Tablo 4.

Bireylerin MET ml/kg/dk Puanları ile Sosyal Beceri Puanları Arasındaki İlişkinin Pearson Korelasyon Tablosu

Değişkenler	n	M ± SD	r	p
MET ml/kg/dk	210	2616.809±2715.893	.367	.000*
Sosyal beceri puanı	210	58.723±12.476		

** $p < .001$

Bireylerin MET ml/kg/dk puan ortalamaları ile sosyal becerilerine ilişkin toplam puan ortalamaları arasındaki ilişkinin Pearson korelasyonu sonuçlarına bakıldığında bu değerler için anlamlı düzeyde pozitif bir ilişki olduğu tespit edilmiştir ($r = .367$, $p < .001$).

Tartışma ve Sonuç

Araştırmaya katılan ÖÖG tanılı bireylerin sosyal beceri puanlarını cinsiyete göre karşılaştırdığında kadın ve erkek öğrencilerin sosyal beceri düzeyleri arasında anlamlı bir fark olmadığı tespit edilmiştir ($p > .05$). Mevcut literatür incelendiğinde cinsiyete göre sosyal beceri düzeyinin araştırma ile farklılık gösterdiği görülmektedir. ÖÖG tanılı bireylerin sosyal beceri düzeyinin, cinsiyete göre farklılık göstermemesinin sebebi; örneklem grubunun tanısı, kadın ve erkek bireylerin bu tanıdan benzer oranda etkilenmelerinden kaynaklı olduğu düşünülmektedir.

Araştırmaya katılan ÖÖG tanılı bireylerin fiziksel aktivite düzeyleri cinsiyete göre karşılaştırıldığında, erkeklerin daha yüksek puan ortalamasına sahip olduğu bulunmuş olsa da

bu ortalamaların istatistiksel açıdan anlamlı olmadığı tespit edilmiştir ($p>.05$). Mevcut literatür incelendiğinde; elde edilen verilerin araştırma ile farklılık gösterdiği tespit edilmiştir. ÖÖG tanılı bireylerin fiziksel aktivite düzeyinin cinsiyete göre farklılık göstermemesinin sebebinin; örneklem grubunun farklı olmasından ve yaşadıkları yetersizliklerin cinsiyet fark etmeksizin bireyleri benzer oranda etkilemesinden kaynaklandığı düşünülmektedir.

Araştırmaya katılan ÖÖG tanılı bireylerin fiziksel aktivite düzeyi ile sosyal beceri düzeyi arasında pozitif yönlü anlamlı bir korelasyon olduğu tespit edilmiştir. Mevcut literatür incelendiğinde; fiziksel aktivite ve sosyal beceri üzerine yapılan araştırmalardan elde edilen sonuçların yüksek oranda benzerlik gösterdiği, fiziksel aktivite düzeyi ile sosyal beceri düzeyi arasında pozitif yönlü anlamlı bir ilişki olduğu görülmektedir. Örneklem grubu fark etmeksizin bireylerin fiziksel aktivite düzeyinin sosyal beceri düzeyini olumlu yönde etkilediği ve bireylerin sosyal yaşamını geliştirdiği düşünülmektedir.

Sonuç olarak, yapılan araştırmalar, ÖÖG tanılı bireylerde fiziksel aktivite ile sosyal beceri arasında anlamlı ve pozitif bir ilişki olduğunu ortaya koymaktadır. Araştırma bulgularına göre, fiziksel aktivite düzeyi arttıkça bu bireylerin sosyal becerileri de artmaktadır. Fiziksel aktivitenin, bireylerin sosyal beceri gelişimi üzerinde önemli ve olumlu bir etkisi olduğu görülmüştür. Ayrıca, cinsiyete göre ÖÖG tanılı bireylerin sosyal beceri ve fiziksel aktivite düzeyleri arasında anlamlı bir fark bulunmamış, kadın ve erkeklerin sosyal beceri ve fiziksel aktivite düzeylerinin benzer olduğu belirlenmiştir.

Öneriler

ÖÖG olan bireylerin sosyal becerileri sergileme sürecinde yaşadıkları sorunlar, fiziksel aktiviteye katılım ile azaltılabilir. Fiziksel olarak aktif bireyler; sosyal rollerini, toplumsal görev ve sorumluluklarını başarıyla yerine getirebilirler. Bakanlık, okullar, aileler ve öğrenciler bazında çalışmalar yapılarak Özel Öğrenme Güçlüğü olan bireylerin fiziksel aktivite düzeylerinin artırılmasına yönelik çeşitli faaliyet ve projeler yürütülebilir.

Millî Eğitim Bakanlığı bünyesinde görev yapan beden eğitimi öğretmenlerine ve ailelerine yönelik çeşitli seminerler düzenlenerek ÖÖG olan bireylere bilgilendirme yapılabilir. Tanısı olan bireylerin gelişimsel özelliklerine uygun fiziksel aktivitelerin belirlenmesi için bu bireyler üzerinde araştırmalar yapılabilir.

Bireylere yakın olan ve bireyleri sürekli gözlemleme fırsatı olan ailelerin ve öğretmenlerin görüşleri alınarak fiziksel aktivite ve sosyal gelişim üzerine araştırmalar yapılabilir. ÖÖG tanılı bireylerde fiziksel aktivite ve sosyal beceri düzeyinin cinsiyet değişkenine göre farklı olup olmadığını belirlemeye yönelik daha fazla araştırma yapılabilir.



<http://www.tayjournal.com>

<https://dergipark.org.tr/en/pub/tayjournal>

Examination of Turkish Lessons Applied in Science and Art Centers*

 Özgür Babayiğit, Assoc. Prof. Dr., Corresponding Author
Yozgat Bozok University, Türkiye
ozgur.babayigit@bozok.edu.tr
Orcid ID: 0000-0001-6123-0609

 Zeynep Koyunlu Ünlü, Assoc. Prof. Dr.
Yozgat Bozok University, Türkiye
zeynepko.unlu@gmail.com
Orcid ID: 0000-0003-3627-1809

 Uğur Gezer, Assoc. Prof. Dr.
Yozgat Bozok University, Türkiye
ugur.gezer@yobu.edu.tr
Orcid ID: 0000-0001-6752-7526

Article Type: Research Article

Received Date: 22.11.2023

Accepted Date: 30.06.2024

Published Date: 31.07.2024

Plagiarism: This article has been reviewed by at least two referees and scanned via plagiarism software

Doi: 10.29329/tayjournal.2024.653.04

Citation: Babayiğit, Ö., Koyunlu Ünlü, Z., & Gezer, U. (2024). Examination of Turkish lessons applied in science and art centers. *Türk Akademik Yayınlar Dergisi (TAY Journal)*, 8(2), 263-286.

*This research has been supported by Yozgat Bozok University Scientific Research Projects Coordination Unit under grant number SGA-2021-869.

Abstract

This research aims to examine Turkish lessons implemented in science and art centers. The research is in the case study type, one of the qualitative research methods. The study group of this research consists of 4 Turkish teachers and 59 students working at the science and art center in the Yozgat province. In this research, interview and observation methods, which are qualitative data collection methods, were used. Interviews were held with Turkish teachers. Turkish lessons in science and art centers were monitored with an observation form. Classes are held five days a week in science and art centers. The general aim of Turkish lessons in science and art centers is to implement activities that will enable students to realize and develop the skills they have. The materials used in Turkish lessons in science and art centers are as follows: activity books, Turkish supplementary course materials, interactive board, computer, and books. Teachers must be creative. Teachers must be well-equipped and researchers. Turkish support book should be developed. Twenty percent of the students in the class can participate in the science and art center exams. Eighth grade students at the science and arts center may be absent due to central exams. It is necessary to reduce this absenteeism. It is recommended that Turkish teachers working in science and art centers be selected among teachers with master's and doctoral degrees. All students who want to take the science and art center application exams should be able to participate.

Keywords: Science and art center, Turkish lesson, application.

Introduction

Science and art center; attending formal education institutions; It is an institution opened to provide support education services to students who are specially talented in general mental, visual arts, or musical talent areas, to develop their talents and use their capacities at the highest level (Special Education Services Regulation, 2018). Considering that 57.360 selected students received education in 182 science and art centers in the 2019-2020 academic year, the importance of these schools can be better understood (Ministry of National Education Strategy Development Directorate, 2020). The aims of science and art centers are stated as follows: In line with the general aims and basic principles of Turkish national education, the educational services offered in science and art centers and special talented students; to grow up as productive, problem-solving, self-actualized individuals who combine scientific thought and behavior with aesthetic values, and to realize their talents and creativity at an early age and use them at the highest level. Acquire creative thinking, discovery, invention, success in social relations, innovation, leadership, communication, and artistic skills. It is aimed at helping them to gain scientific study discipline in line with their special abilities, to think interdisciplinary, to solve problems, and to realize projects to meet determined needs (Science and Art Centers Directive, 2023). If individual differences in education reach certain levels, the education of students with special needs comes to the fore. Developments in the direction of these students receiving a different education from their peers or receiving supplementary education along with the education they receive with their peers have led to the emergence of educational institutions for the gifted. Schools that have an important place in the education of gifted students in Türkiye are science and art centers. Science and art centers play a role in the education of these students from their diagnosis of giftedness to university age (Vuran & Ünlü, 2013). Education and training environments in science and art centers are prepared to support the development and learning characteristics

of specially talented students, suitable for individual education and group education. Education and training environments are equipped with rich tools and materials to identify different areas of interest and talent and to develop high-level thinking skills (Science and Art Centers Directive, 2023). In this context, the kind of special education that students who are identified as gifted can receive in the support education rooms of their schools, as well as in these schools, should also be evaluated. The education of gifted individuals is important for countries in many different dimensions. Gifted people act as forward carriers in social and economic developments. The importance of gifted individuals in the development and development of countries with their innovative and creative work in many fields has been expressed (Alevli, 2019). Gifted students; have high performance capacity in areas related to general intellectual skills, specific academic skills, creative and productive thinking, leadership skills, visual-applied arts, and psychomotor skills (Davis & Rimm, 2004).

The following points are taken into account in the execution of education and training services at the science and art center (Science and Art Centers Directive, 2023): Education and training activities to be held at the science and art center are planned to take place on weekdays and/or weekends, outside the hours when the student receives formal education. To realize original products, projects, and productions, a project-based, interdisciplinary, enriched, and differentiated education program appropriate to the abilities of the students is applied and educational activities are organized. Education and training services at the science and art center are provided in the form of individual and/or group education. Education and training activities are carried out according to the common annual work calendar prepared by the Ministry during the academic year. In addition, summer schools, winter schools, and student camps can be organized during midterm, semester, and summer holidays. Students registered at the science and art center; are included in adaptation, support training, awareness of individual talents, development of special talents, project production, and management programs. Kirk and Gallogher (1989) gifted and specially talented child; defined as a child who demonstrates a high performance capacity in areas such as intellectual, creative, artistic, or leadership, or who needs activities and activities in specific academic areas that he cannot obtain at school to fully develop these capacities. These children are different and developed in many respects compared to their peers.

Special education for gifted individuals is as important socially as it is individually (Bilgili, 2000). Education and training programs to be implemented in the science and arts center are prepared and developed within the framework of the following principles (Science and Art Centers Directive, 2023): The programs are designed to be developed under the guidance of relevant class/branch teachers, in a student-centered and interdisciplinary structure, suitable for individual learning, and students' effective problem solving skills. It is prepared by differentiating and enriching them according to their interests, abilities, and potentials, to enable them to acquire the high-level mental, social, personal, and academic skills they will need in adulthood, such as decision-making and creativity. Planning, implementation, and evaluation stages are carried out in a way that ensures that students are raised as individuals who learn by doing, experience, produce solutions to real-life problems, think creatively, communicate with their environment, and make scientific research and inventions. Programs to develop special talents are prepared and carried out to provide in-

depth and advanced knowledge, skills, and behavior in any discipline, taking into account disciplinary and interdisciplinary approaches. While preparing training programs, attention is paid to the planning and implementation of activities that enable the development of high-level thinking skills. Project production and development activities are the basis of all activities carried out. In the implementation of educational programs, scientific, artistic, cultural, etc. cooperation is made with universities, institutions, and organizations. Cooperation is made on issues. Parents have an important role in the education and development of gifted children. The ability of a gifted child to fulfill his/her functions and grow up as a happy and balanced individual who is satisfied with life is closely related to the relationships within the family and the attitudes of the parents. It is observed that parents of gifted children need more awareness for their children's education and to prevent possible problems (Karakuş, 2010). Gifted and talented individuals acquire extensive amounts of information because they have high-level skills such as analysis, synthesis, and communication. These individuals are very successful in integrating and using a variety of different technologies. They generally do not have much trouble, especially in downloading documents from the internet and obtaining graphic images, using word processing and graphics programs, and preparing multimedia presentations (Karnes & Stephens, 2005).

Education and training implementation periods at the science and art center are prepared taking into account the following principles: The adaptation program is planned and implemented as a total of 40 lesson hours, not exceeding two months. The support education program is planned and implemented for students enrolled in the science and art center in the 2nd and 3rd grades, with the first year being taught primarily by the classroom teachers, and lasting at least 2 academic years, including the orientation program period. It is planned and implemented for 1 academic year, including the orientation program period, to be taught by class/branch teachers for students who are enrolled in the science and art center in the 4th grade. The program to recognize individual talents is planned and implemented for 2 academic years, starting from the 5th grade level, in a way that the student will be introduced to all areas. Development of a special abilities program, 2 academic years for students diagnosed in the field of general mental ability; it is planned and implemented as 7 academic years for students identified in the field of art and music talent. Each lesson/event/skill workshop hour is planned and implemented as 40 minutes. The program for the development of special talents is implemented for students identified in the field of art and music as follows: 7 academic years for students enrolled in the science and art center in the 2nd grade, 6 academic years for students enrolled in the 3rd grade, 6 academic years for students enrolled in the 4th grade. It is planned and implemented for 5 academic years (Science and Art Centers Directive, 2023). From the past to the present, societies have been able to develop and achieve civilization thanks to the contribution of gifted people. For this reason, early diagnosis and education of a rare number of individuals with superior abilities are important to increase their levels and to enable them to grow up as leading individuals in society who can offer creative ideas for society (Yumuş & Toptaş, 2011).

Various studies have been conducted on science and art centers: Ford (1998), Fraser-Seeto et al., (2015), Gagne (2007), Gunter and Kenny (2012), Henderson and Jarvis (2016), Koçak (2020), Peterson et al., (2009), Reid and Horvathova (2016), Rogers (2007), Tallent-

Runnels et al., (2000), Weber and Cavanaugh (2006). According to the results of the research conducted by Alevli (2019), teachers who take Turkish lessons in science and art centers differentiate and enrich the content, process, product, and learning environment by the characteristics of specially talented students, use various materials that attract the attention of students in the teaching process, and use multiple measurement methods in evaluation. It was observed that they included tools and evaluation methods. In addition, it is concluded that the activity contents should be revised to make them more abstract and complex, the advanced content should be increased, different strategies, methods and techniques, higher-order thinking skills and open-ended problems should be included in the teaching process, and visual, technological and game-based materials should be developed. In the research conducted by Okur and Özsoy (2013), the attitudes of gifted students towards Turkish lessons were examined. In the research conducted by Yıldız (2018), the development/use of course materials by Turkish teachers working in science and art centers was examined. In the research conducted by Eryılmaz (2021), the Turkish course curriculum of science and art centers was examined according to the Turkish course competencies of specially talented students. In the research conducted by Mete (2021), the opinions of science and art center Turkish teachers regarding the game-based teaching method were examined.

This research aims to examine Turkish lessons implemented in science and art centers. The research to be conducted aims to examine in depth the Turkish lessons conducted in science and art centers. This article will contribute to the literature on science and art centers and the literature on Turkish teaching. This research is important in terms of describing Turkish courses in science and art centers. It will contribute to improving Turkish courses in science and art centers. The results of the article are beneficial to the development of a conceptual/theoretical framework. It will contribute to scientific knowledge in the field of education of gifted and special talents and Turkish education. The article has the potential to produce solutions to the problems in Turkish teaching activities carried out in science and art centers. Teachers working in science and art centers and academicians working in the field of Turkish teaching will be able to benefit from the results of the article. The problem statement of this research is: How are Turkish lessons conducted in science and art centers? Within the scope of this problem statement, answers were sought to the following questions:

1. How are Turkish lessons implemented in the science and art center?
2. What activities are held in Turkish lessons at the science and art center?
3. What are the effects of Turkish course activities implemented in the science and art center on students?
4. What are the suggestions of teachers to make Turkish lessons in science and art centers more effective and efficient?

Method

Research Model

The research is a case study type, one of the qualitative research methods. A case study is the description and examination of an interesting and special phenomenon within the context of the situation (Sönmez & Alacapınar, 2011). Case studies are holistic and contextually sensitive (Patton, 2014). One or several situations with certain boundaries are studied (Creswell, 2007). Its most basic feature is the in-depth investigation of one or several situations (Yıldırım & Şimşek, 2006). Available data collection and analysis techniques are used in case studies (Yin, 2009). Observation and interview techniques were used in this research.

Study Group

The study group of this research consists of 2 Turkish teachers and 34 students working at the science and art center in the central district of Yozgat province, and 2 Turkish teachers and 25 students working at the science and art center in Boğazlıyan district of Yozgat province. A total of 4 Turkish teachers and 59 students were studied. It was determined by the purposeful sampling method in the 2022-2023 academic years. The characteristics of the Turkish teachers in the study group are presented in Table 1.

Table 1.

Distribution of Teachers by Gender and Professional Experience

	Gender	Year	Graduation	Professional seniority
Teacher 1	Male	40	Turkish teacher	18
Teacher 2	Female	39	Turkish teacher	16
Teacher 3	Male	36	Turkish teacher	11
Teacher 4	Female	38	Turkish teacher	14

Table 1 shows that the ages of the teachers in the study group are between 36-40. All of them are graduates of the Turkish teacher department.

Data Collection Tools

In this research, interview and observation methods, which are qualitative data collection methods, were used. The interview method was deemed appropriate to create suggestions for the problems they encountered in the Turkish course at the science and art center and the ways to solve these problems (Yıldırım & Şimşek, 2006). Interviews were held with Turkish teachers. Teachers' opinions and experiences were used as data sources. Previous studies were examined to create the semi-structured interview form. Then, a faculty member who was an expert in his field was consulted to determine the suitability of the interview form. As a result of the feedback received, additions, deletions, and edits were made to the semi-structured interview form. The prepared semi-structured interview form was piloted with a Turkish teacher to be tested. The semi-structured interview form consists of two parts. In the first part, the demographic characteristics of the teachers were asked, and in the second part, the teachers were asked about the problems they encountered in the process of teaching Turkish and their opinions and experiences about the solution suggestions for these problems. The semi-structured interview form includes the following questions:

Interview questions:

1. What do you think about the Turkish course practices implemented in the science and art center?
2. What activities do you use in the Turkish lesson at the science and art center?
3. What do you think about the impact of Turkish course activities implemented in the science and art center on students?
4. What are your suggestions for making Turkish lessons at the science and art center more effective and efficient?

Turkish lessons in science and art centers were monitored with an observation form. Activities carried out in Turkish lessons were written on the observation form. What the students did in Turkish lessons was noted. The observation form aims to record the Turkish lessons process. Observation forms include information about where, when, for how long, and with how many people the observation was made. In addition, the observation form includes a section where the physical space characteristics of the classrooms are specified and a main section where the process is recorded.

Data Collection

After determining the data collection tools, the researchers started collecting data. To collect data, four Turkish teachers working in science and art centers were interviewed face to face, one-on-one, after school hours. Before the interviews were conducted, teachers were informed about the purpose of this study, and their opinions were recorded in writing, based on their volunteering. The interviews were held in May and June 2023. The interviews, which lasted approximately 15-20 minutes, were held in a friendly environment. During the interviews, it was observed that teachers were extremely willing to share their professional experiences and the problems they encountered. During the interviews, questions that the teachers could not understand were explained in detail with examples.

In addition, Turkish lessons conducted in science and art centers were written on the observation form. During the observations, the researchers did not intervene in the process. They only watched Turkish lessons. Observations of students in primary school first grade Turkish lessons were recorded by the researchers on the observation form. Turkish lessons were observed eight times. The process in Turkish lessons was written on the observation form. Each observation lasted approximately 20 minutes. A total of 164 minutes of observation was made.

Analysis of Data

The descriptive analysis method was used to analyze the data obtained. In descriptive analysis, the data obtained are summarized and interpreted according to predetermined themes (Yıldırım & Şimşek, 2006). The data collected through interviews and observations were recorded in written form using Word. The data from the semi-structured interview and observation forms were converted into data texts for analysis. The data texts created in this context were read and evaluated four times. In the evaluation, literature-based data were taken into consideration as a result of interviews and observations. Based on the results, the

basic outlines of the research were determined and the themes were created. The created themes were given their final form after being presented to expert opinion. After the data obtained from the research was analyzed, it was made suitable for interpretation. The themes and codes created from the data obtained from the interview results in the research were tried to be conveyed to the reader through quotations without making any personal inferences in the findings section. Four themes were reached. These themes are the structure and purpose of science and art center Turkish lessons, materials used in Turkish lessons, activities in Turkish lessons, and teachers' suggestions.

To ensure validity in this qualitative research, the method of examining the codes and themes by an expert was used. The expert is an associate professor working in the field of classroom teaching and Turkish teaching. In terms of the reliability of the research, what was planned and realized by the researcher was shared with a faculty member who has a doctorate in the field of measurement and evaluation in education, from the planning of the process to the end. During the content analysis process of the data, coding was done by the researcher and an associate professor who works in Turkish teaching in the field of classroom teaching as the second coder. For the reliability of the analysis of the data, the reliability formula developed by Miles and Huberman (2015) [Reliability=Number of consensus/(Total agreement + Number of disagreements)] was taken as basis. According to this analysis, the reliability coefficient was calculated as = .91. According to this finding, it can be said that the codings are reliable.

Ethical Permits of Research:

In this study, all the rules specified to be followed within the scope of "Higher Education Institutions Scientific Research and Publication Ethics Directive" were complied with. None of the actions specified under the heading "Actions Contrary to Scientific Research and Publication Ethics", which is the second part of the directive, have been taken.

Ethics Committee Permission Information:

Name of the committee that made the ethical evaluation = Yozgat Bozok University
Ethics Commission

Date of ethical review decision= 25.08.2021

Ethics assessment document issue number= 24/09

Findings

As a result of the content analysis, four themes were reached. The themes and codes reached are shown in Table 2.

Table 2.

Themes and Codes

Themes	Codes
Structure and purpose of science and art center Turkish lessons	5 days of lessons Student groups of 3-5 people Two stage exam Two hours of Turkish lessons per week A total of 12 hours of lessons per week Periods Activities Skills Projects Turkish class Pictures of literary figures Literature books
Materials used in Turkish lessons	Activity books Turkish language supplementary course materials Interactive board Computer Books
Activities in Turkish lessons	Turkish lesson support book Write a skit Finger puppets Cartoon Creating a new intelligence game Puzzle
Teachers' suggestions	Creative teacher Equipped teacher Researcher teacher Support book All students should take application exams Student absenteeism

As in Table 2, the answers given by the teachers to the questions based on the semi-structured interview form and observation form are presented under four theme headings.

Structure and Purpose of Science and Art Center Turkish Lessons

The first finding of the research is the structure and purpose of Turkish courses in the science and art center. In this finding, the structure and purpose of Turkish lessons in science and art centers are explained. First of all, as a result of the interviews with the teachers, what the teachers said was stated. Teachers said the following on this subject:

- There are classes five days a week in science and art centers. Student groups of 3, 4, or 5 people. Classes are held between 08:00 and 19:30. These students pass a two-stage aptitude test. There are two hours of Turkish lessons a week in science and art centers. There is a maximum of 12 hours of lessons in total. There is a two-month adaptation period for the first registration. There is a support phase in the third and fourth months. Then there is the phase of recognizing individual talents. Then special abilities are developed. 10th, 11th and 12th grades project classes. Permanent teachers work in science and art centers. The interview is

based on success and exam. Primary school teachers can also work in science and art centers (Teacher 4).

- The general purpose of Turkish lessons is to implement activities that will enable students to recognize and improve their skills (Teacher 1).

- Its difference from classical schools is that instead of trying to teach a subject in the program, it makes the child aware of the special skills he has and provides opportunities to improve himself in this direction. For this purpose, plenty of practices, activities, and projects need to be done (Teacher 2).

- We make students aware of their abilities (Teacher 3).

An example observation made on this subject as a result of the observations made by the researchers is as follows:

Each teacher has his or her classroom in the science and art center. Different students come to this classroom and teach their lessons. The Turkish teacher has a special class of his own. There are pictures of various literary figures in this class. There are various literature books in the classroom libraries. Various student writings hang on the classroom walls (Observation 1).

Turkish classrooms of science and art centers can be seen in the photographs below.

Photo 1.

Turkish Class



Photo 2.

Turkish Class



Photo 3.

Turkish Class



Photo 4.

Turkish Class



Materials Used in Turkish Lessons

The second finding of the research is the materials used in Turkish lessons in the science and art center. In this finding, the materials used in Turkish lessons in science and art centers are explained. First of all, as a result of the interviews with the teachers, what the teachers said was stated. Teachers said the following on this subject:

- We have activity books prepared according to grade level on the basic skills of listening, writing, speaking, and understanding (Teacher 1).
- Activities from the book are selected and implemented according to the potential of the class (Teacher 4).
- Teachers prepare the plans according to grade level by selecting outcomes and activities from ready-made templates (Teacher 3).
- Sharing information in science and art center groups specific to each branch is guiding and enriching (Teacher 2).
- There is an activity book. There is a science and art center activity book. General Directorate of Special Education and Guidance Services has supplementary course materials in the Turkish field (Teacher 1).
- Interactive whiteboards and computers are used in lessons (Teacher 4).

An example observation made on this subject as a result of the observations made by the researchers is as follows:

Students came to class with their bags. They took their activity books out of their bags. There are interactive whiteboards in the classrooms. Students open and use this interactive board whenever necessary in Turkish lessons. In some cases, they take notes in their notebooks. Sometimes they use the books in the classroom libraries (Observation 2).

An interactive board in the Turkish classrooms of science and art centers can be seen in the photo below.

Photo 5.

Activity with an Interactive Whiteboard



Activities in Turkish Lessons

The third finding of the research is the activities in Turkish lessons in the science and art center. In this finding, the activities in Turkish lessons in science and art centers are explained. First of all, as a result of the interviews with the teachers, what the teachers said was stated. Teachers said the following on this subject:

- We can change and develop the activities according to need, or we can design and implement activities independent of the book (Teacher 1).

- Sometimes the activity can be completed faster than the given time. In such cases, we do backup activities or improvised practices in that process (Teacher 2).

- For example, we do not explain figures of speech, but we can ask them to complete a text with blank spaces in the introduction, development, and conclusion sections, using the figures of speech we want. We can write a skit for two people appropriate to the given topic and ask them to act it out with finger puppets. Or we give a cartoon series and ask the characters to fill the empty thought bubbles. Creating a new intelligence game, writing down the way the game is played and its rules, and playing the game prepared by the other team according to the instructions are examples of unique activities that I implemented outside the book (Teacher 3).

- Students are overactive. Students are researchers and very curious (Teacher 4).

- In Turkish lessons, we do not repeat the student's lessons at school. We do not prepare for central exams. We manage the process through the Turkish supplementary textbook (Teacher 2).

- The student produced his puzzle in Turkish class. We compiled this into a book. What is done in Turkish lessons does not only improve students' basic language skills. It also improves mental skills. Interactive whiteboard computers are used in lessons (Teacher 3).

An example observation made on this subject as a result of the observations made by the researchers is as follows:

Students took their activity books out of their bags. They did activities from activity books for one class hour. They played a word puzzle game in the second lesson period. They enjoyed the word puzzle game very much. There was laughter when some words were said incorrectly in the word puzzle (Observation 3).

Examples of activities in Turkish classrooms of science and art centers can be seen in the photographs below.

Photo 6.

Activity



Photo 7.

Activity Tree



Teachers' Suggestions

The fourth and last finding of the research is the suggestions of Turkish teachers of the science and art center. In this finding, the suggestions of Turkish teachers in science and

art centers are explained. First of all, as a result of the interviews with the teachers, what the teachers said was stated. Teachers said the following on this subject:

- Teachers must be creative. Must be well-equipped and investigative (Teacher 1).
- We need a support book for Turkish lessons. A Turkish activity support book should be developed (Teacher 2).
- Twenty percent of the students in the class can participate in the science and art center exams. Instead, all students should be able to take the application exams of science and art centers (Teacher 3).
- Eighth grade students at the science and arts center may be absent due to central exams. This absenteeism needs to be reduced (Teacher 4).

An example observation made on this subject as a result of the observations made by the researchers is as follows:

Not all students come to Turkish lessons at the science and art center. There are a few students who are absent from every Turkish lesson. Regarding this issue, teachers said that students may get tired because they have both school and science and art center classes. For this reason, they think that absenteeism is high (Observation 4).

Discussion and Conclusion

As a result of the research, four themes were reached. These themes are the structure and purpose of science and art center Turkish lessons, materials used in Turkish lessons, activities in Turkish lessons, and teachers' suggestions. The codes obtained in the structure and purpose of the science and art center Turkish lessons theme are as follows: 5 days of lessons, student groups of 3-5 people, two stage exams, two hours of Turkish lessons per week, a total of 12 hours of lessons per week, periods, activities, skills, projects, Turkish class, pictures of literary figures, literature books. Here, the number of students in Turkish courses attracts attention. The codes accessed in the materials used in Turkish lessons theme are as follows: activity books, Turkish language supplementary course materials, interactive board, computer, and books. The codes accessed in the activities in Turkish lessons theme are Turkish lesson support book, write a skit, finger puppets, cartoon, creating a new intelligence game, and puzzle. It is understood that students engage in high-level activities in Turkish lessons at the science and art center. The codes available in the teachers' suggestions theme are as follows: creative teacher, equipped teacher, researcher teacher, support book, all students should take application exams, and student absenteeism. When teacher recommendations are examined, teachers' equipment and students' absenteeism draw attention.

The structure and purpose of science and art center Turkish lessons are explained. There are classes five days a week in science and art centers. Student groups of 3, 4, or 5 people. Classes are held between 08:00 and 19:30. These students pass a two-stage aptitude test. There are two hours of Turkish lessons a week in science and art centers. There is a maximum of 12 hours of lessons in total. There is a two-month adaptation period for the first registration. There is a support phase in the third and fourth months. Then there is the phase

of recognizing individual talents. Then special abilities are developed. 10th, 11th and 12th grades project classes. Permanent teachers work in science and art centers. The interview is based on success and exam. Primary school teachers can also work in science and art centers. Students registered with the science and art center; are included in adaptation, support training, awareness of individual talents, development of special talents, project production, and management training programs (Science and Art Centers Directive, 2023). In other words, the program structure that is thought to be effective for gifted students is complex and deep (Karnes & Stephens, 2005). In the education methods of science and art centers, it is never possible to use academic knowledge for exams and similar processes. Here, students are provided with education in their talent areas with a project-based teaching model, and students are expected to carry out projects according to the desired qualifications (Su et. al., 2017). The following points are taken into account in the execution of science and art center education and training services (Science and Art Centers Directive, 2023): Education and training activities to be carried out in the science and art center are planned to take place on weekdays and/or weekends, outside the hours when the student receives formal education. To realize original products, projects, and productions at the science and art center, a project-based, interdisciplinary, enriched, and differentiated education program appropriate to the abilities of the students are implemented and educational activities are organized. Education and training services at the science and arts center are provided in the form of individual and/or group education. In addition, summer schools, winter schools, and student camps can be organized during midterm, semester, and summer holidays. Registered students; are included in adaptation, support training, awareness of individual talents, development of special talents, project production, and management programs. Visits to historical places, museums, industrial facilities, universities, festivals, fairs, and nearby areas, participation in conferences, recitals, concerts, exhibitions, autograph signing events, and all scientific, cultural, artistic, and social activities inside and outside the institution are considered within the scope of education and training activities. The general aim of Turkish lessons in science and art centers is to implement activities that will enable them to realize and develop the skills they have. Its difference from classical schools is that instead of trying to teach a subject in the program, it makes the child aware of the special skills he has and provides opportunities to improve himself in this direction. For this purpose, many applications, activities, and projects need to be carried out. In science and art centers, students are made aware of their talents. The purposes of science and art centers are stated as follows (Science and Art Centers Directive, 2023): In line with the general objectives and basic principles of Turkish national education, the education services offered in science and art centers and special talented students; To grow up as productive, problem-solving, self-actualized individuals who combine scientific thought and behavior with aesthetic values, and to realize their talents and creativity at an early age and use them at the highest level. Acquire creative thinking, discovery, invention, success in social relations, innovation, leadership, communication, and artistic skills. It is aimed for them to gain scientific study discipline in line with their special abilities, to think interdisciplinary, to solve problems, and to realize projects to meet determined needs. According to Saranlı and Metin (2012), to support the social and emotional development of gifted children and prevent possible negativities that

may arise, highlighting their social strengths and focusing on what they can do will help them show a more positive personality structure. In other words, these individuals should be provided with learning and practice environments that will satisfy them and enable them to use their existing features effectively. Care should be taken to ensure that the program structure to be used in these environments supports these characteristics of individuals.

It has been determined that various teaching materials are used in Turkish lessons in science and art centers. These materials are activity books, Turkish language supplementary course materials, interactive boards, computers, and books. Education and training environments in science and art centers are prepared to support the development and learning characteristics of especially talented students, suitable for individual education and group education. Education and training environments are equipped with rich tools and materials to identify different areas of interest and talent and to develop high-level thinking skills (Science and Art Centers Directive, 2023). Gifted and talented individuals need an educational environment that suits their unique characteristics and needs due to the differences in their cognitive, sensory, and developmental characteristics (Kanlı, 2008). Considering the roles that especially talented individuals will assume in the future, the importance of science and art centers cannot be ignored. It is very important to solve the problems encountered in science and art centers and to have sufficient physical conditions and equipment for these centers (Kılıç, 2015). According to Alevli (2019), there should be rich materials in the learning environment for especially talented students. The materials most used by teachers are books, authentic materials, verbal intelligence games, puppets, pictures, Hacivat-Karagöz sets, magazines, dictionaries, posters and costumes, authentic materials, verbal intelligence games, and puppet smart boards, educational videos, computers, web 2.0 tools, animation, documentary, camera, music, audio poetry, radio, and sound recording.

It has been determined that various activities are carried out in Turkish lessons in science and art centers. It has been determined that the main source of activities is the activity book. They may be asked to complete a blank text using the desired figures of speech. A skit suitable for the subject can be written for two people and animated with finger puppets. They are given a cartoon series and the characters are asked to fill in the empty thought bubbles. Creating a new intelligence game, writing down the way the game is played and its rules, and playing the game prepared by the other team according to the instructions are examples of original activities outside the book. The student produced his puzzle in Turkish class. According to Alevli (2019), stated that within the scope of the enriched program at the science and art center, they implemented the activities in the Turkish course framework program and activity book, their enriched activities, and also implemented them by differentiating the existing activities. According to the Science and Art Centers Directive (2023), programs are designed under the guidance of relevant class/branch teachers, in a student-centered and interdisciplinary structure, suitable for individual learning, and provide students with high-level mental, social, and personal skills that they will need in adulthood, such as effective problem solving, decision-making and creativity. It is prepared by differentiating and enriching the students according to their interests, abilities, and potential to enable them to acquire academic skills. Planning, implementation, and evaluation stages are carried out in a way that ensures that students are raised as individuals who learn by

doing, experience, produce solutions to real-life problems, think creatively, communicate with their environment, and make scientific research and inventions. According to Alevli (2019), the most common concrete student products in lessons were stories, essays, poems, and fairy tales. Articles, puppets, Hacivat-Karagöz, comics, interviews, paintings, plays, songs, free text, cartoons, short films, drama shows and posters are among the products created by students.

The final result reached in the research is the suggestions of Turkish teachers of the science and art center. Teachers must be creative. Must be well-equipped and investigative. According to Alevli (2019), the individual characteristics that Turkish teachers in science and art centers should have are; he/she is a strong communicator, investigative, exemplary, creative, tolerant, patient, caring, critical thinker, open to criticism, has strong empathy skills, prioritizes national moral values, and has universal values. Professional characteristics; He/she has received training on special talents, is open to innovation, has good field knowledge, has knowledge of the curriculum, can use the program flexibly, can prepare qualified educational environments, is experienced, and has received postgraduate education. A support book is required. A support book should be developed. Twenty percent of the students in the class can participate in the science and art center exams. Instead, all students should be able to take the application exams of science and art centers. From the past to the present, societies have been able to develop and achieve civilization thanks to the contribution of gifted people. For this reason, early diagnosis and education of a rare number of individuals with superior abilities are important to increase their levels and to enable them to grow up as leading individuals in society who can offer creative ideas for society (Yumuş & Toptaş, 2011). Eighth grade students at the science and arts center may be absent due to central exams. It is necessary to reduce this absenteeism. According to Çelik-Şahin (2014), students do not attend the science and art center regularly and therefore education is disrupted. The research concluded that students also have problems with issues such as transportation, time management, and health. Students who can use their means of transportation can attend these centers with the help of a shuttle or their parents. Students' motivation and energy may decrease in activities at science and art centers due to school fatigue.

Recommendations

The following recommendations are made within the scope of the research results:

Turkish teachers working in science and art centers must be creative. These teachers must be well-equipped and researchers.

It is recommended that Turkish teachers working in science and art centers be selected among teachers with master's and doctoral degrees.

The number of Turkish support books should be increased in science and art centers.

All students who want to take the science and art center application exams should be able to participate.

References

- Alevli, O. (2019). *Özel yetenekli öğrencilere bilim ve sanat merkezlerinde uygulanan Türkçe eğitimi: Bir durum çalışması* [Turkish education applied in science and art centers to gifted students: A case study]. (Publication No. 583373) [Doctoral dissertation, Sakarya University]. National Thesis Center.
- Bilgili, A. (2000). Üstün yetenekli çocukların eğitimi sorunu-sosyal sorumluluk yaklaşımı [The problem of education of gifted children-social responsibility approach]. *Marmara University Atatürk Education Faculty Journal of Educational Sciences*, 12(12), 59-74.
- Creswell, J. W. (2007). *Qualitative inquiry and research design: Choosing among five approaches* (2nd ed.). Sage.
- Çelik-Şahin, Ç. (2014). Bilim ve sanat merkezi öğrencilerinin bu kurumlara ilişkin görüşlerinin incelenmesi [Investigating science and arts center students' opinions on these organizations]. *HAYEF Journal of Education*, 11(1), 101-117.
- Davis, G., & Rimm, S. (2004). *Education of the gifted and talented* (5th ed.). Pearson Education.
- Eryılmaz, R. (2021). Bilim sanat merkezleri Türkçe dersi öğretim programının özel yetenekli öğrencilerin Türkçe dersi yetkinliklerine göre incelenmesi [Examination of the science and art centers Turkish course curriculum according to the Turkish competencies framework of gifted students]. *Adnan Menderes University Faculty of Education Journal of Education Science*, 12(2), 34-48.
- Ford, D. (1998). The under-representation of minority students in gifted education: Problems and promises in recruitment and retention. *The Journal of Special Education*, 32(4), 4-14.
- Fraser-Seeto, K. T., Howard, S. J., & Woodcock, S. (2015). An investigation of teachers' awareness and willingness to engage with a self-directed professional development package on gifted and talented education. *Australian Journal of Teacher Education*, 40(1), 1-14.
- Gagne, F. (2007). Ten commandments for academic talent development. *Gifted Child Quarterly*, 51(2), 93-118.
- Gunter, G. A., & Kenny, R. F. (2012). UB the director: Utilizing digital book trailers to engage gifted and twice exceptional students in reading. *Journal of Gifted Education International*, 28(2), 146-160.
- Henderson, L., & Jarvis, J. (2016). The gifted dimension of the Australian professional standards for teachers: Implications for professional learning. *Australian Journal of Teacher Education*, 41(8), 60-83.
- Kanlı, E. (2008). *Fen ve teknoloji öğretiminde probleme dayalı öğrenmenin üstün ve normal zihin düzeyindeki öğrencilerin erişimi, yaratıcı düşünme ve motivasyon düzeylerine etkisi* [The effect of problem based learning in science and technology instruction on gifted and normal students' achievement, creative thinking and motivation levels]. (Publication No. 261852) [Master thesis, İstanbul University]. National Thesis Center.
- Karakuş, F. (2010). Üstün yetenekli çocukların anne babalarının karşılaştıkları güçlükler [Difficulties faced by parents of gifted children]. *Mersin University Journal of the Faculty of Education*, 6(1), 127-144.
- Karnes, F. A., & Stephens, R. K. (2005). *Using media & technology with gifted learners*. Profrock.
- Kılıç, V. C. (2015). Türkiye'de üstün ve özel yetenekli çocuklara yönelik bir eğitim politikası oluşturulamaması sorunu üzerine bir değerlendirme [An evaluation over unavailable education programme policy for gifted and talented children in Türkiye]. *Education and Society in the 21st Century*, 4(12), 145-154.
- Kirk, S., A., & Gallagher, J. (1989). *Educating exceptional children*. Houghton Mifflin Company.
- Koçak, E. (2020). Eğitim fakültesi öğrencilerinin eleştirel okuma becerilerinin incelenmesi [Investigation of critical reading skills of education faculty students]. *TAY Journal*, 4(1), 17-30.
- Mete, G. (2021). BİLSEM Türkçe öğretmenlerinin oyun temelli öğretim yöntemine yönelik görüşleri [Turkish teachers' views on game-based teaching method in BİLSEM]. *Journal of Social Sciences of Kahramanmaraş Sütçü İmam University*, 18(1), 106-130.
- Miles, B., & Huberman, M. (2015). *Genişletilmiş bir kaynak kitap: Nitel veri analizi* [Qualitative data analysis: An expanded sourcebook] (S. Akbaba Altun & A. Ersoy, Trans. Ed.). Pegem.

- Ministry of National Education Strategy Development Directorate. (2020). *Resmi istatistikler* [Official statistics]. Retrieved October 15, 2023, from <https://sgb.meb.gov.tr/www/resmi-istatistikler/icerik/64>
- Okur, A., & Özsoy, Y. (2013). Üstün zekalı öğrencilerin Türkçe dersine yönelik tutumlarının incelenmesi: Bartın BİLSEM örneği [A research for the attitudes of gifted students' towards Turkish lesson: A sample of Bartın BILSEM]. *Journal of Theory and Practice in Education*, 9(3), 254-264.
- Patton, M. Q. (2014). *Nitel araştırma ve değerlendirme yöntemleri* [Qualitative research and evaluation methods] (2nd ed.). (M. Bütün & S. B. Demir, Trans.). Pegem.
- Peterson, J., Duncan, N., & Canady, K. (2009). Longitudinal study of negative life events, stress, and school experiences of gifted youth. *Gifted Child Quarterly*, 53(1), 34-49.
- Reid, E., & Horváthová, B. (2016). Teacher training programs for gifted education with focus on sustainability. *Journal of Teacher Education for Sustainability*, 18(2) 66-74.
- Rogers, K. B. (2007). Lessons learned about educating the gifted and talented: A synthesis of the research on educational practice. *Gifted Child Quarterly*, 51(4), 382-396.
- Saranlı, A. G., & Metin, N. (2012). Üstün yetenekli çocuklarda gözlenen sosyal-duyusal sorunlar [Social-emotional problems observed in gifted children]. *Ankara University Journal of Faculty of Educational Sciences*, 45(1), 139-163.
- Science and Art Centers Directive. (2023). *Millî Eğitim Bakanlığı bilim ve sanat merkezleri yönergesi* [Ministry of National Education science and art centers directive]. Retrieved September 22, 2023 from https://orgm.meb.gov.tr/meb_iys_dosyalar/2022_12/06214921_BIYLIYM_VE_SANAT_ME_RKEZLERIY_YOYNERGESIY.pdf
- Sönmez, V., & Alacapınar, F. G. (2011). *Örneklendirilmiş bilimsel araştırma yöntemleri* [Illustrated scientific research methods]. Anı.
- Special Education Services Regulation. (2018). *Resmî gazete* [Official newspaper]. Issue: 30471, Saturday, July 7, 2018. Retrieved September 20, 2023 from <https://resmigazete.gov.tr/fihrist?tarikh=2018-07-07>
- Su, Ş., Sağlam, A., & Mutlu, Y. (2017). Bilim ve sanat merkezi öğrencilerinin "BİLSEM" ve "okul" kavramlarına ilişkin algı düzeylerinin metaforlarla karşılaştırılması [Comparison of science and art center students' perception levels regarding the concepts "BILSEM" and "school" with metaphors]. *Journal of Gifted Education and Creativity*, 4(3), 91-108.
- Tallent-Runnels, M. K., Tirri, K. A., & Adams, A. M. (2000). A cross-cultural study of teacher's attitudes toward gifted children and programs for gifted children. *Gifted and Talented International*, 15(2), 103-115.
- Vuran, S., & Ünlü, E. (2013). Türkiye'de özel gereksinimli çocukların eğitimi ile ilgili örgütlenme ve mevzuat [Organization and legislation regarding the education of children with special needs in Türkiye]. In S. Vuran (Ed.), *Özel eğitim* [Special education]. (pp. 57-79). Maya Akademi.
- Weber, C. L., & Cavanaugh, T. W. (2006). Promoting reading: Using ebooks with gifted and advanced readers. *Gifted Child Today*, 29(4), 56-63.
- Yıldırım, A., & Şimşek, H. (2006). *Sosyal bilimlerde nitel araştırma yöntemleri* [Qualitative research methods in the social sciences] (6th ed.). Seçkin.
- Yıldız, N. (2018). *Bilim ve sanat merkezlerinde görev yapan Türkçe öğretmenlerinin ders materyali geliştirme/kullanma durumlarının incelenmesi* [The investigation of the course material development/use of Turkish teachers working in science and art centers]. (Publication No. 506263) [Master thesis, Necmettin Erbakan University]. National Thesis Center.
- Yin, R. K. (2009). *Case study research: Design and methods* (4th ed.). Sage.
- Yumuş, A., & Toptaş, V. (2011). Bilim ve sanat merkezlerinin amacına uygun işleyişinin değerlendirilmesi [Evaluation of the proper functioning of science and art centers]. *Mersin University Journal of the Faculty of Education*, 7(2), 80-88.

BIOGRAPHICAL NOTES

Contribution Rate of Researchers

Author 1: 34%

Author 2: 33%

Author 3: 33%

Support and Thanks

This research has been supported by Yozgat Bozok University Scientific Research Projects Coordination Unit under grant number SGA-2021-869.

Conflict Statement

There is no conflict of interest in the research.



Bilim ve Sanat Merkezlerinde Uygulanan Türkçe Derslerinin İncelenmesi

Özet

Bu araştırmada Bilim ve Sanat Merkezlerinde uygulanan Türkçe derslerinin incelenmesi amaçlanmaktadır. Araştırma nitel araştırma yöntemlerinden durum çalışması türündedir. Bu araştırmanın çalışma grubunu Yozgat ilindeki iki adet Bilim ve Sanat Merkezinde görev yapan 4 Türkçe öğretmeni ve 59 öğrenci oluşturmaktadır. Bu araştırmada nitel veri toplama yöntemlerinden görüşme ve gözlem yöntemleri kullanılmıştır. Türkçe öğretmenleriyle görüşmeler yapılmıştır. Bilim ve Sanat Merkezlerindeki Türkçe dersleri gözlem formuyla izlenmiştir. Araştırma sonuçlarına göre, Bilim ve Sanat Merkezlerinde dersler, hafta içi beş gün yapılmaktadır. Bilim ve Sanat Merkezlerinde Türkçe derslerinin genel amacı, öğrencilerin sahip oldukları becerileri fark etmelerini ve geliştirmelerini sağlayacak etkinliklerin uygulanmasıdır. Bilim ve Sanat Merkezlerinde Türkçe derslerinde kullanılan materyaller şu şekildedir: etkinlik kitapları, Türkçe yardımcı ders materyalleri, etkileşimli tahta, bilgisayar ve kitaplar. Bilim ve Sanat Merkezindeki sekizinci sınıf öğrencileri merkezi sınavlar nedeniyle devamsızlık yapabilmektedir. Bu devamsızlığı azaltmak gerekmektedir. Bilim ve Sanat Merkezlerinde görev yapan Türkçe öğretmenlerinin yüksek lisans ve doktora derecesine sahip öğretmenler arasından seçilmesi önerilmektedir. Bilim ve Sanat Merkezi uygulama sınavlarına girmek isteyen tüm öğrencilerin katılabilmesi önerilmektedir.

Anahtar Kelimeler: Bilim ve sanat merkezi, Türkçe dersi, uygulama.

Giriş

Bilim ve Sanat Merkezi genellikle bilimsel ve sanatsal etkinliklerin düzenlendiği, eğitim ve kültür hizmetlerinin sunulduğu, zeki veya yetenekli öğrencilerin öğrenim gördüğü kuruluştur. Bu merkezler genellikle çeşitli atölye çalışmaları, sergiler, konferanslar, seminerler ve etkinlikler düzenleyerek bilim, teknoloji, mühendislik, matematik, sanat ve kültür alanlarında katılımcılara eğitim fırsatları sunmaktadır. Bilim ve Sanat Merkezleri, öğrencileri erken yaşlardan itibaren bilim ve sanatla tanıştırmayı, yaratıcılıklarını geliştirmelerine olanak tanımayı ve bu alanlarda yeteneklerini keşfetmelerine yardımcı olmayı amaçlamaktadır. Ayrıca, toplumun genel bilgi düzeyini artırmak ve bilimle sanatı daha erişilebilir kılmak için çeşitli halka açık etkinliklere ev sahipliği yapabilmektedir. Bu tür merkezler, bilim ve sanatın toplum için önemli olduğu düşüncesinden hareketle, bireylerin bu alanlara ilgi duymalarını teşvik etmekte ve gelecekteki bilim insanları, mühendisler, sanatçıların yetişmesine katkıda bulunmaktadır (Özel Eğitim Hizmetleri Yönetmeliği, 2018).

Bilim ve Sanat Merkezinde Türkçe dersleri, dil becerilerini artırmak, yazma ve konuşma yeteneklerini geliştirmek, edebi anlayışı artırmak gibi hedeflere yönelik olarak sunulmaktadır (Millî Eğitim Bakanlığı Bilim ve Sanat Merkezleri Yönergesi, 2023). Türkçe dersleri genellikle dilbilgisi, yazma, okuma anlama, konuşma ve edebiyat gibi temel alanları kapsamaktadır. Bu dersler, öğrencilere dil becerilerini güçlendirmeleri için fırsatlar sunmaktadır. Ayrıca, öğrencilere kendi yazılarını oluşturma, eleştirel düşünme, iletişim becerilerini geliştirme gibi konularda rehberlik etmektedir. Bilim ve Sanat Merkezlerindeki

Türkçe dersleri genellikle gençlerin yaratıcılıklarını desteklemektedir. Bu dersler, öğrencilere dilin güzelliklerini keşfetme, ifade yeteneklerini artırma ve kültürel anlamda zenginleşme imkânı sunmaktadır. Temel dilbilgisi kuralları, imla ve yazım kuralları üzerine odaklanılmaktadır. Öğrenciler, dilbilgisi konularında güçlendirilmekte ve yazma becerileri geliştirilmektedir. Edebi metinler, makaleler, hikâyeler gibi farklı türlerdeki metinler üzerinde çalışmalar yapılmaktadır. Öğrencilere anlama, çözümleme ve eleştirel düşünme becerileri kazandırılmaktadır. Öğrencilere sözlü iletişim becerilerini geliştirme adına konuşma ve sunum yapma fırsatları sunulmaktadır. Bu, öğrencilerin kendilerini açıkça ifade etmelerini sağlamaktadır. Türk ve dünya edebiyatının klasik ve modern eserleri üzerinde çalışmalar yapılmaktadır. Öğrencilere edebi eserleri anlama, yorumlama ve eleştirme yetenekleri kazandırılmaktadır. Öğrencilere kendi yazılarını oluşturma fırsatı tanınmaktadır. Şiir, hikâye, deneme gibi farklı türlerde yaratıcı yazma becerileri geliştirilmektedir.

Bu araştırmanın amacı Bilim ve Sanat Merkezlerinde uygulanan Türkçe derslerinin incelenmesidir. Bilim ve Sanat Merkezlerinde uygulanan eğitim-öğretim faaliyetleri yeterince bilinmemektedir. Ayrıca bu kurumlarla ilgili yeterince çalışma yapılmamıştır. Yapılacak olan araştırma ile Bilim ve Sanat Merkezlerinde yürütülen Türkçe derslerinin derinlemesine incelenmesi amaçlanmaktadır. Bu makale ile Bilim ve Sanat Merkezleri alan yazınına ve Türkçe öğretimi alan yazınına katkı sağlamaktadır. Makale sonucunda ortaya konulan sonuçların kavramsal/kuramsal çerçeve geliştirilmesine faydaları bulunmaktadır. Üstün ve özel yeteneklilerin eğitimi alanı ile Türkçe eğitimi alanına bilimsel birikime katkı sağlanmaktadır. Makalenin Bilim ve Sanat Merkezlerinde yürütülen Türkçe öğretimi etkinliklerindeki sorunlara çözüm üretme potansiyeli bulunmaktadır. Makale sonuçlarından Bilim ve Sanat Merkezlerinde görev yapan öğretmenler ile Türkçe öğretimi alanında çalışan akademisyenler yararlanabilmektedir.

Yöntem

Araştırma nitel araştırma yöntemlerinden durum çalışması türündedir (Sönmez & Alacapınar, 2011; Yin, 2009). Çalışma grubu 2022-2023 eğitim öğretim yılında amaçlı örnekleme yöntemiyle belirlenmiştir. Bu araştırmanın çalışma gurubunu Yozgat ili merkez ilçede Bilim ve Sanat Merkezinde görev yapan 2 Türkçe öğretmeni ve 34 öğrenci, Yozgat ili Boğazlıyan ilçesinde Bilim ve Sanat Merkezinde görev yapan 2 Türkçe öğretmeni ve 25 öğrenci oluşturmaktadır. Toplamda 4 Türkçe öğretmeni ve 59 öğrenci ile çalışılmıştır. Bu araştırmada nitel veri toplama yöntemlerinden görüşme ve gözlem yöntemi kullanılmıştır. Görüşmeler Türkçe öğretmenleri ile yapılmıştır. Veri kaynağı olarak öğretmenlerin görüşleri ve deneyimlerine başvurulmuştur. Yarı yapılandırılmış görüşme formunu oluşturmak amacıyla daha önce yapılmış çalışmalar incelenmiştir. Ardından oluşturulan görüşme formunun uygunluğu konusunda alanında uzman olan bir öğretim üyesine başvurulmuştur. Alınan dönütler sonucunda yarı yapılandırılmış görüşme formunda ekleme, çıkarma ve düzenlemeler yapılmıştır. Yarı yapılandırılmış görüşme formu iki kısımdan oluşmaktadır. Birinci kısımda öğretmenlerin demografik özelliklerinden, ikinci kısımda ise öğretmenlerin Bilim ve Sanat Merkezinde Türkçe öğretimi sürecine hakkındaki görüş ve deneyimler sorulmuştur. Bunun yanı sıra Bilim ve Sanat Merkezlerindeki Türkçe dersleri gözlem formu ile izlenmiştir. Gözlem formuna Bilim ve Sanat Merkezi Türkçe derslerinde yürütülen

etkinlikler yazılmıştır. Öğrencilerin Türkçe derslerinde yaptıkları not edilmiştir. Gözlemler sırasında araştırmacılar sürece müdahale etmemiştir. Türkçe derslerini sadece izlemişlerdir.

Elde edilen verilerin analizinde betimsel analiz yöntemi kullanılmıştır (Yıldırım & Şimşek, 2006). Görüşme ve gözlem ile elde edilen veriler word üzerinden yazılı şekilde kayıt altına alınmıştır. Yarı yapılandırılmış görüşme formundan ve gözlem formundan elde edilen veriler analiz edilmek üzere veri metinleri haline getirilmiştir. Bu bağlamda oluşturulan veri metinleri defalarca okunularak değerlendirilmiştir. Yapılan değerlendirmede görüşmeler ve gözlemler sonunda literatüre dayalı veriler göz önüne alınmıştır. Ortaya çıkan sonuç üzerinden araştırmacının temel hatları belirlenmiş temaları oluşturulmuştur. Oluşturulan temalar uzman görüşüne sunulduktan sonra son şekli verilmiştir. Araştırmadan elde edilen veriler analiz edildikten sonra yorumlanmaya uygun hale getirilmiştir. Araştırma içerisinde görüşme sonuçlarından elde edilen veriler oluşturulan temalar, bulgular kısmında kişisel bir çıkarım yapılmadan alıntılar aracılığı ile okuyucuya aktarılmaya çalışılmıştır.

Araştırmanın Etik İzinleri:

Bu çalışmada "Yükseköğretim Kurumları Bilimsel Araştırma ve Yayın Etiği Yönergesi" kapsamında uyulması gerektiği belirtilen tüm kurallara uyulmuştur. Yönergenin ikinci bölümü olan "Bilimsel Araştırma ve Yayın Etiğine Aykırı Eylemler" başlığı altında belirtilen eylemlerin hiçbiri gerçekleştirilmemiştir.

Etik Kurul İzin Bilgileri:

Etik değerlendirmeyi yapan kurulun adı = Yozgat Bozok Üniversitesi Etik Komisyonu

Etik Kurul Etik inceleme karar tarihi= 25.08.2021

Etik değerlendirme belgesi konu numarası= 24/09

Bulgular

Bu bölümde yarı yapılandırılmış görüşme formuna dayalı sorulara öğretmenlerin vermiş oldukları cevaplar dört başlık altında sunulmaktadır. Araştırmanın ilk bulgusu Bilim ve Sanat Merkezi Türkçe derslerinin yapısı ve amacıdır. Bilim ve Sanat Merkezlerinde hafta içi beş gün ders yapılmaktadır. Öğrenci grupları 3, 4 veya 5 kişiden oluşmaktadır. Bilim ve Sanat Merkezi mesai saati 08:00 ile 19:30 arasındadır. Bilim ve Sanat Merkezi mesai saatlerinin belirlenmesinde, öğrencilerin normal okullarındaki ders saatleri dikkate alınmaktadır. Bilim ve Sanat Merkezi başvuru sınavında öğrenciler iki aşamalı yetenek sınavından geçmektedir. Bilim ve Sanat Merkezlerinde her bir öğrenci grubu için haftada iki saat Türkçe dersi yapılmaktadır. Bilim ve Sanat Merkezlerinde her bir öğrenci grubu için toplamda 12 saat ders yapılmaktadır. İlk kayıta iki ay uyum süreci vardır. Üçüncü ve dördüncü aylarda destek aşaması bulunmaktadır. Daha sonra bireysel yetenekleri fark etme aşaması yürütülmektedir. Ardından özel yetenekleri geliştirme yapılmaktadır. 10., 11. ve 12. sınıflar proje sınıflarıdır. Bilim ve Sanat Merkezlerinde kadrolu öğretmenler görev yapmaktadır. Bilim ve Sanat Merkezinde öğretmen olabilmek için başarı sınavı ve mülakata yapılmaktadır. Bilim ve Sanat Merkezlerinde branş öğretmenlerinin yanı sıra ilköğretim öğretmenleri de görev yapabilmektedir. Bilim ve Sanat Merkezlerinde Türkçe derslerinde genel amaç öğrencilerin sahip oldukları becerileri fark etmelerini ve geliştirebilmelerini

sağlayacak etkinlikler uygulamaktır. Klasik okullardan farkı, programda olan bir konuyu öğretme uğraşı yerine çocuğun sahip olduğu özel becerilerin farkına vardırmak ve kendini bu yönde geliştirecek fırsatlar tanımaktır. Bu amaçla bol uygulama, etkinlik, proje yapılması gerekmektedir. Bilim ve Sanat Merkezlerinde öğrencilerin yeteneklerinin farkına varmaları sağlanmaktadır. Bilim ve Sanat Merkezleri Türkçe derslerinde çeşitli öğretim materyallerinin kullanıldığı belirlenmiştir. Bu materyallerden bazıları şunlardır; etkinlik kitapları, Türkçe alanı yardımcı ders materyalleri, etkileşimli tahta, bilgisayar, kitaplar. Bilim ve Sanat Merkezleri Türkçe derslerinde çeşitli etkinlikler gerçekleştirildiği belirlenmiştir. Etkinliklerin ana kaynağının etkinlik kitabı olduğu tespit edilmiştir. Öğrencilerden boşluklar bırakılmış bir metni istenen söz sanatlarını kullanarak tamamlamaları istenebilmektedir. Konuya uygun iki kişilik bir skeç yazıp parmak kuklalarla canlandırma yapılmıştır. Bir karikatür dizisi verip karakterlerin boş olan düşünce balonlarını doldurmaları istenmiştir. Yeni bir zeka oyunu oluşturmaları, oyunun oynanış şeklini ve kurallarını yazmaları ayrıca diğer takımın hazırladığı oyunu yönergeye göre oynamaları da kitap dışı özgün etkinlik örneğidir. Bir öğrenci Türkçe dersinde kendi bulmacasını üretmiştir. Araştırmada ulaşılan son sonuç Bilim ve Sanat Merkezi Türkçe öğretmenlerinin önerileridir. Bilim ve Sanat Merkezi Türkçe öğretmenlerine göre, Bilim ve Sanat Merkezinde görev yapan öğretmenler yaratıcı olmalıdır. Yine bu öğretmenler donanımlı, araştırmacı olmalıdır. Bilim ve Sanat Merkezlerinde Türkçe dersi destek kitabına gerek duyulduğu dile getirilmiştir. Türkçe dersi destek kitabının geliştirilmesi gerektiği belirtilmiştir. Bilim ve Sanat Merkezi Türkçe öğretmenlerine göre, Bilim ve Sanat Merkezi sınavlarına normal okullardaki sınıfın yüzde yirmi oranında öğrencileri katılabilmektedir. Bu uygulamanın yerine normal okullardaki tüm öğrencilerin Bilim ve Sanat Merkezlerinin başvuru sınavlarına girebilmesi önerilmektedir. Bilim ve Sanat Merkezi Türkçe öğretmenlerine göre, Bilim ve Sanat Merkezindeki sekizinci sınıf öğrencileri merkezi sınavlar nedeniyle devamsızlık yapabilmektedir. Bu öğrenci devamsızlığının azaltılması gerekmektedir.

Tartışma ve Sonuç

Araştırma kapsamında çeşitli sonuçlara ulaşılmıştır. Bilim ve Sanat Merkezlerinde normal okullarda olduğu gibi hafta içi beş gün ders yapılmaktadır. Normal okullardan farklı olarak öğrenci grupları 3, 4 veya 5 kişiden oluşmaktadır. Bilim ve Sanat Merkezi mesai saatleri normal mesai saatlerinden farklı olarak 08:00 ile 19:30 arasındadır. Bilim ve Sanat Merkezi başvuru sınavında öğrenciler iki aşamalı yetenek sınavından geçmektedirler (Millî Eğitim Bakanlığı Bilim ve Sanat Merkezleri Yönergesi, 2023). Her öğrenci grubu için haftada iki saat Türkçe dersi ve toplamda 12 saat ders yapılmaktadır. Bilim ve Sanat Merkezlerinde normal okullardan farklı bir eğitim-öğretim yürütülmektedir (Karnes & Stephens, 2005). İlk kayıta iki ay uyum süreci vardır, destek aşaması ise üçüncü ve dördüncü aylarda başlamaktadır. Bilim ve Sanat Merkezlerinde 10., 11. ve 12. sınıflar proje sınıflarıdır. Bilim ve Sanat Merkezlerinde kadrolu öğretmenler görev yapmaktadır. Bilim ve Sanat Merkezinde öğretmen olabilmek için başarı sınavı ve mülakat yapılmaktadır. Türkçe derslerinde öğrencilerin becerilerini fark etmelerini sağlayacak etkinlikler uygulanmaktadır. Türkçe dersinde kullanılan materyaller arasında etkinlik kitapları, yardımcı ders materyalleri, etkileşimli tahta, bilgisayar ve kitaplar bulunmaktadır (Alevli, 2019). Etkinlikler arasında metin tamamlama, skeç yazma, parmak kukla canlandırma, karikatür dizisi tamamlama gibi

örnekler vardır. Bu etkinlikler normal okullardaki etkinliklerle kıyaslandığında, üst düzey etkinlikler olduğu dikkat çekmektedir. Türkçe öğretmenleri, Bilim ve Sanat Merkezi öğretmenlerinin yaratıcı, donanımlı ve araştırmacı olması gerektiğini belirtmektedir. Ayrıca Türkçe dersi destek kitabının geliştirilmesinin gerektiği vurgulanmıştır. Bilim ve Sanat Merkezi başvuru sınavlarına daha fazla öğrencinin katılabilmesi önerilmektedir. Bu önerinin üstün zekalı veya yetenekli öğrencilerin tespiti için önemli olduğu düşünülmektedir. Sekizinci sınıf öğrencilerinin merkezi sınavlar nedeniyle devamsızlık yapabildiği ve bu durumun azaltılması gerektiği ifade edilmiştir (Çelik-Şahin, 2014). Bu merkezi sınavların liselere geçiş sınavı ve üniversiteye giriş sınavları olduğu düşünülmektedir.

Öneriler

Araştırma sonuçları kapsamında şu önerilerde bulunmaktadır:

Bilim ve Sanat Merkezlerinde görev yapan Türkçe öğretmenleri yaratıcı olmalıdır. Bu öğretmenler donanımlı, araştırmacı olmalıdır.

Bilim ve Sanat Merkezlerinde görev yapan Türkçe öğretmenlerinin, yüksek lisans ve doktora mezunu öğretmenler arasından seçilmesi önerilmektedir.

Bilim ve Sanat Merkezlerinde Türkçe dersi destek kitabı sayısı artırılmalıdır.

Bilim ve Sanat Merkezi başvuru sınavlarına isteyen tüm öğrenciler katılabilmelidir.

Bilim ve Sanat Merkezindeki sekizinci ve on ikinci sınıf öğrencileri merkezi sınavlar nedeniyle devamsızlık yapabilmektedir. Bu devamsızlığın azaltılması gereklidir.



<http://www.tayjournal.com>

<https://dergipark.org.tr/en/pub/tayjournal>

Development of an Environmental Attitude Scale for Primary School Students*

☐ Cahide Karakaş Tan, Teacher, Corresponding Author
Ministry of National Education, Türkiye
karakastan.cahide@gmail.com
Orcid ID: 0009-0006-9165-8255

☐ Mutlu Pınar Demirci Güler, Prof. Dr.
Kırşehir Ahi Evran University, Türkiye
pinarguler@ahievran.edu.tr
Orcid ID: 0000-0002-8286-4472

Article Type: Research Article

Received Date: 30.10.2023

Accepted Date: 18.07.2024

Published Date: 31.07.2024

Plagiarism: This article has been reviewed by at least two referees and scanned via a plagiarism software

Doi: 10.29329/tayjournal.2024.653.05

Citation: Karakaş Tan, C., & Demirci Güler, M. P. (2024). Development of an environmental attitude scale for primary school students. *Türk Akademik Yayınlar Dergisi (TAY Journal)*, 8(2), 287-316.

*This article was produced from Cahide Karakaş Tan's master's thesis supervised by Prof. Dr. Mutlu Pınar Demirci Güler.

Abstract

This study aims to develop a valid and reliable measurement tool to determine the environmental attitude levels of primary school students. The research adopts a quantitative research design and is of a survey study nature. The study was conducted during the 2022-2023 academic year with the participation of 948 students from primary schools in Kırşehir. The likert-type scale development model was used in the study. Considering that the items in the measurement tool are related to each other, the promax oblique rotation technique was used in the explanatory factor analysis [EFA]. As a result of the rotation technique applied three times, a 17 item scale consisting of 3 sub-factors was obtained. The result of the Kaiser-Meyer-Olkin [KMO] Test of the scale was calculated as .837. The Bartlett Test result was found to be significant ($p < .00$). As a result of the validity and reliability analyses of the developed data collection tool, it was observed that the Cronbach's alpha internal consistency coefficient calculated in the explanatory factor analysis increased from .76 to .91 in the confirmatory factor analysis. As a result of the study, a valid and reliable measurement tool was developed to determine the environmental attitude levels of primary school students. The developed scale can be revised in line with the curriculum and learning outcomes for different grade levels.

Keywords: Attitude, environment, primary school, scale development.

Introduction

Human beings have interacted with their environment since their existence, affecting the environment they live in and being affected by it. In general terms, the environment refers to the living space of organisms. The living space is an area where people maintain their relationships in social, biological, economic, physical, and cultural aspects and interact mutually. It is also a place where people communicate, realize themselves, and integrate with their inner world, in other words, where they find themselves. In this context, it can be said that the environment is not only a physical space for humans but also plays an important role personally and psychologically. It is known that interactions with the environment are significant for an individual's self-realization (Ada et al., 2017; Çabuk & Karacaoğlu, 2003; Kavruk, 2002; Yalçinkaya, 2012).

The environment is important both individually and socially. Every positive or negative activity individuals perform on the environment not only impacts their immediate surroundings but also affects the broader societal environment. Therefore, it is undoubtedly crucial for individuals to be aware of their impact on the environment in their daily lives. This awareness can be achieved by providing individuals with environmental education. Environmental education can be defined as an interdisciplinary approach that continues throughout an individual's life, aiming to make individuals knowledgeable, solution-oriented towards problems, and responsible in their actions concerning environmental issues (Chepesiuk, 2007; Moseley, 2000). Within this framework, environmental education aims to foster positive attitudes towards the environment and encourage a critical perspective in interactions with it. Consequently, it aims to raise individuals who are sensitive and knowledgeable about leaving a clean and healthy environment for future generations. Additionally, environmental education can transform and enhance individuals' problem-solving skills, their ability to question information, and their capability to reach conclusions and make decisions (Doğan, 1997; Görümlü, 2003).

In all dimensions of environmental education, the importance of starting environmental-related activities at an early age is emphasized. Childhood is considered a critical period for developing sensitivity, gaining knowledge, feeling concern, and becoming aware of the natural world. Therefore, instilling environmental sensitivity and awareness in children during this period through family and school is crucial. The foundational gains of this awareness process, which begins with the family, can be provided during preschool and primary education. Environmental education that starts at an early age is vital for forming individuals' environmental attitudes and awareness (Demirkaya, 2006; Erten, 2004; Gök & Afyon, 2015; Gökçe et al., 2007). Atasoy (2006) stated that, beyond its obligatory nature, primary school is not a superficial and simple education period but actually forms the foundation of the entire education system. The primary school period is a critical educational stage with a complex structure that should be prioritized. Considering the high number of students in our country who are unable to continue to higher education levels, the importance of environmental education provided during the basic education process becomes evident (Gürkan & Gökçe, 1999).

Attitude can be defined as tendencies formed as a result of learning that push individuals to exhibit certain behaviors (Demirel, 1993). Considering that attitude is formed as a result of learning and that the critical period for learning is at the basic education level, it can be said that providing environmental education at an early age is effective in creating environmental sensitivity and developing positive attitudes towards the environment in individuals. The components of attitude consist of three dimensions: cognitive, emotional, and behavioral (Morgan, 1991). These components are considered to have internal consistency with each other. According to this assumption, if the knowledge an individual has about a subject leads them to approach it positively, it is called the "cognitive component." If the person has positive feelings about that subject, it is called the "emotional component." If they express these feelings and thoughts through words or actions, it is called the "behavioral component." Therefore, attitudes are not just a combination of knowledge, tendency, and emotion but are a whole formed by the blending of the cognition-emotion-behavior tendency (İnceoğlu, 1993). The cognitive dimension of attitude consists of factual information and beliefs related to attitude objects (stimuli). This information represents the knowledge that individuals acquire about attitude objects in the environment. The more factual this information is, the more permanent the individuals' attitudes will be. When individuals' knowledge about that attitude changes, their attitudes also change (Tavşancıl, 2010). The affective dimension of attitude includes an individual's emotional responses to the attitude object and their evaluations in this context. The affective component gives continuity to the attitude, shapes it, and influences it (Erdoğan, 1999). The behavioral dimension of attitude is the third component. Allport (1967) sees attitude as essentially a tendency to move in a certain direction and emphasizes the information it can express as a result of behavior. An attitude essentially predisposes an individual to behave in a certain way towards the attitude object. An individual who develops a positive attitude towards an object will tend to engage in positive behaviors related to that object, stay close to it, and help it. Conversely, an individual who develops a negative attitude towards an object will tend to ignore it or stay away from it, criticize it, and even engage in behaviors that harm it. Research indicates that while individuals' behaviors can be directly

observed, a scale is needed to measure their attitudes (Çınar et al., 2008; Meyerhoff, 2006). Based on this need, the aim of the study is to develop a valid and reliable scale to determine the environmental attitudes of primary school students. A review of the literature reveals scale development studies for environmental attitudes aimed at first-grade primary school students (Demir, 2016; Yaşaroğlu and Akdağ, 2013), second-grade primary school students (Demirkaya and Genç, 2006; Kılıç and Kan, 2020), and pre-service teachers' attitudes towards the environment (Afacan & Demirci Güler, 2011; Kahyaoglu, 2011; Okur & Yalçın Özdilek, 2012; Tuncer, 2021). However, there is no scale in the literature that comprehensively addresses the entire primary school curriculum, determines environmental gains, and is developed based on the three dimensions of attitude. Therefore, this study can be considered a significant contribution to the literature.

During the development process of the scale, two main points were considered while creating the item pool. The first point is addressing the cognitive, affective, and behavioral dimensions, which are the components of attitude, in the process of creating the scale items. The second point is examining the curricula of all subjects taught in the first, second, third, and fourth grades of primary school and forming the scale items based on the environmental gains identified in these curricula. The developed scale can serve as a tool for educators to determine the environmental attitude levels of primary school students. In this context, the study sought to answer the question, "How can a scale be developed to determine the environmental attitude levels of primary school students?"

Method

Research Design

The research aimed to develop a valid and reliable measurement tool to determine primary school students' attitudes towards the environment. The research adopts a singular survey model from general survey models. With the singular survey model, efforts were made to determine students' current situations. The singular survey model is used to gain a general understanding of the universe through a specific group or subset, rather than the entire population (Bailey, 1982).

Population and Sample

The population of the study consisted of students attending primary schools in Kırşehir province during the 2022-2023 academic year, while the sample was comprised of 4th-grade students selected from this population. The primary aim in selecting 4th grade students was their higher age levels and readiness compared to other grades, which was expected to facilitate a clearer understanding of the scale items. Stratified sampling was preferred in the sample selection process. This method ensured that subgroups within the population were identified and represented in the sample according to their proportions in the population. School administrators and class teachers provided insights regarding the number of students in schools and the socio-economic level of their environments, which helped in stratifying the population. Work groups were then determined using simple random sampling from each stratum of the population. Simple random sampling ensured that every individual in the population had an equal chance of being selected (Çingı, 1994). Thus, the goal was to represent

the population with the obtained sample. Throughout the study, three work groups were involved. The first group, the pilot implementation group, consisted of 50 students, the second group involved 371 students where the Explanatory Factor Analysis [EFA] items were applied, and the third group, comprising 527 students, was used to validate the items identified in the EFA. The research was conducted with 948 out of 3040 4th grade students in Kırşehir province.

Analysis of Data

The Attitude Scale was developed using EFA and Confirmatory Factor Analysis [CFA]. While SPSS 25 package program was used for EFA, LISREL 8.80 program was preferred for CFA. For each item in the scale using EFA, item analysis based on the difference between lower and upper group means, item-total correlation, scree plot graph, Kaiser-Mayer-Olkin [KMO] Test, and Barlett Test were conducted to determine the adequacy of the factor analysis of the scale. Factor loadings, factor loading values, and factor loadings of items in the factor structure of the scale, as well as Cronbach's alpha internal consistency coefficient calculations, were performed. With CFA, goodness-of-fit criteria such as Root Mean Square Error of Approximation [RMSEA], Standardized Root Mean Square Residual [SRMR], Goodness of Fit Index [GFI], Adjusted Goodness of Fit Index [AGFI], Comparative Fit Index [CFI], Normed Fit Index [NFI], degrees of freedom, and chi-square goodness-of-fit value were calculated.

Ethical Permits of Research:

In this study, all the rules specified to be followed within the scope of "Higher Education Institutions Scientific Research and Publication Ethics Directive" were complied with. None of the actions specified under the heading "Actions Contrary to Scientific Research and Publication Ethics", which is the second part of the directive, have been taken.

Ethics Committee Permission Information:

Name Name of the committee that made the ethical evaluation = Kırşehir Ahi Evran University Social and Human Sciences Scientific Research and Publication Ethics Committee

Date of ethical review decision = 02.02.2023

Ethics assessment document issue number = 2023/01/27

Findings

The seven-step scale development process proposed by DeVellis (2016) was followed in creating the environmental attitude scale. The obtained results are presented within the framework of these steps.

1. Clearly Defining the Subject of

The aim of developing the environmental attitude scale is to create a valid and reliable measurement tool for determining primary school students' attitudes towards the environment. The preparation process for the scale began with the first step of reviewing the literature related to attitudes, examining attitude-related survey items in the literature, and reviewing attitude scales related to other primary school subjects. Next, the achievements in the primary school curriculum were analyzed, and the environmental-related achievements were identified to create an item pool.

2. Creating the Item Pool

Following the literature review, the step of writing items and creating the item pool was completed. In this step, attitude expressions related to the environment were identified in the achievements of all subjects in the primary school curriculum, relevant achievements were determined, and appropriate items related to the cognitive, affective, and behavioral dimensions of attitude were grouped and written. While creating the item pool, efforts were made to include items in similar proportions related to the cognitive, affective, and behavioral dimensions of attitude. The created items were then evaluated, and each item was carefully examined. Items that did not cover the achievements and were not suitable for the primary school level were removed from the item pool with expert opinion. The final item pool consisted of a total of 50 items.

3. Determining the Measurement Structure

The measurement format chosen for the study is a Likert-type measurement format. Since it is more appropriate to use a three-level or binary Likert scale in scales at the primary school level (Köklü, 1995), a three-level Likert-type measurement format was preferred as the measurement format in the research. Three-level Likert ratings were paired with the 50 items created to determine students' degrees of agreement with environmental attitude statements. These ratings are ["Agree (3)", "Partially Agree (2)", "Disagree (1)"].

4. Reviewing the Item Pool by Experts

To determine content and scope validity, expert opinions should be sought to assess the appropriateness of items in the measurement tool and whether they adequately represent the targeted domain (Erefe, 2002; Karasar, 2016). In this context, draft items were evaluated by 3 primary school teachers, 3 science teachers, and 5 academics in the field of classroom education using the "Primary School Level Environmental Attitude Scale Expert Evaluation Form". After obtaining expert opinions, Lawshe's (1975) technique was used to calculate the Content Validity Ratios [CVR] for the items. Following the evaluations, the Content Validity Index [CVI] value was determined as 1, indicating sufficient agreement among the evaluators. However, five items in the scale were removed based on expert opinions as their CVR value (= .59) was below the established minimum value.

The scale now consists of 45 items, with 15 items targeting cognitive attitudes, 15 items targeting affective attitudes, and 15 items targeting behavioral attitudes. Additionally, two measurement and evaluation experts were consulted to determine whether the attitude items accurately measure students' emotions, thoughts, and behaviors. These experts confirmed that the scale items adequately reflected attitudes and achieved the intended measurement. Furthermore, three language experts examined the scale items to evaluate if there were any deficiencies in terms of language clarity. These experts confirmed that the language used in the items was correct and understandable, without any elements that could lead to misunderstanding or confusion. A pilot test of the 45 item preliminary form was conducted with 50 fourth-grade primary school students. They were asked if there were any items they found difficult to understand, and the duration of the pilot test was determined. Feedback from

the 50 students indicated that there were no items they did not understand, and the average duration of the scale's pilot test was found to be between 25 and 30 minutes.

5. Including Verification Items

In the fifth stage, it has been concluded that there is no need to add any additional verification items regarding determining the final versions of the items.

6. Determining Sample Selection for Item Development

At this stage, the steps of determining a sample size sufficient for the pilot study and conducting the pilot study have been completed. A preliminary application form consisting of 45 items was administered by the researcher to a sample group of 450 students, 250 (56%) of whom were girls and 200 (44%) were boys, selected through simple random sampling from ten different primary schools in Kırşehir city center using stratified sampling. In assessing the adequacy of the dataset, the primary factor considered is the sample size. Kline (1994) suggests that a sample size at least ten times the number of items may be sufficient to reveal reliable factors. Although this number may be reduced to 100 in cases where the factor structure is clear and limited, it is generally emphasized that working with larger samples is more appropriate (as cited in Çokluk et al., 2010). As the sample size increases, the reliability of factor analysis results also increases (Field, 2005). Additionally, it is advocated that in determining the sample size for factor analysis, the Kaiser-Meyer-Olkin test should be conducted, with a value of .60 or higher, and the Bartlett test should be statistically significant (Büyüköztürk, 2019). Finally, according to criteria in the literature, it is suggested that meeting at least two criteria may be appropriate for determining an adequate sample size for factor analysis (Çokluk et al., 2010). In this context, obtaining data from 450 individuals for EFA in the conducted research can be considered to meet the specified criteria.

The Environmental Attitude Scale's structural validity was assessed using the EFA method. The data obtained from 450 students were evaluated to determine if they met the conditions required for EFA. The KMO test yielded a result of .837, and the Bartlett test was found to be statistically significant ($p=.000$). Based on the results of these tests, it can be said that the data set of 450 individuals is sufficient for conducting EFA.

7. Evaluation of Substances

In this stage, validity and reliability calculations were conducted for item assessments. In this context, content, structural, and face validities were analyzed. Content validity expresses how well the measuring tool covers the behaviors it aims to measure, indicating how suitable the measuring tool is for its overall purpose and evaluating the relevance of each item to the purpose (Tekin, 1993; Turgut & Baykul, 2010). For the scope validity of the Environmental Attitude Scale, attitude items in the relevant field were examined, taking into account the general characteristics of environmental education. Additionally, the opinions of experts support the scope validity.

Structural validity refers to the ability of a measuring tool to accurately measure an abstract concept. In other words, structural validity evaluates whether the scores obtained from a test truly measure what the test aims to measure (Büyüköztürk, 2002; Tavşancıl, 2010). Statistical techniques are used to assess structural validity, and these techniques include

methods called factor analyses. Factor analysis can be implemented in two different ways: CFA and EFA (Yurdubakan, 2010). In evaluating the structural validity of the Primary School Level Environmental Attitude Scale, both EFA and CFA methods were utilized.

To determine the reliability of the scale, item analysis and item-total correlation values were examined, and a decision was made on whether any item should be removed from the scale. Subsequently, Cronbach's alpha reliability coefficient was calculated to determine the reliability of the scale.

Item Analysis of the Environmental Attitude Scale

In the analysis of the items in the Environmental Attitude Scale, item analysis based on the difference between lower and upper group means and item-total correlation analysis methods were used. These analyses were conducted to decide whether each item should be included in the final scale (Tezbaşaran, 1997).

To evaluate the discriminant power of the items in the draft scale, the difference between the mean environmental attitude scores of the lower and upper groups for each item was examined. Initially, the total attitude scores of the students were calculated. Students' environmental attitude scores were ranked from highest to lowest, and the top 27% and bottom 27% groups were identified. From these groups, 122 individuals (27% of the sample) were selected as the lower and upper groups. An independent samples t-test was conducted to examine the difference between the scores of the lower and upper groups. To assess the discriminant potential of the items in the draft scale, a significant difference was observed in terms of environmental attitude score means between the lower and upper groups for each item. It was found that for each item, $p < .05$, indicating that the scale items contribute to measuring the intended property. Therefore, no item was removed from the scale.

Each item's item-total correlation value was statistically calculated in the draft scale. It was found that the item-total correlation values for each item ranged from .430 to .654. As emphasized by Büyüköztürk (2019), when item-total correlation coefficients are .30 or higher, it indicates that the items distinguish individuals well. Seçer (2021) also recommends that the item factor loadings be at least .30. When it is assumed that the factors in the measuring tool are unrelated, orthogonal rotation techniques are used; when they are assumed to be related, oblique rotation techniques are used (Seçer, 2021). In this context, considering that the items in the measuring tool represent dimensions of attitude and are related to each other, the promax oblique rotation technique was used in the EFA. Upon examining the item-total correlation value, the explained total variance values, the scree plot, and the component matrix of the Environmental Attitude Scale consisting of 45 items, it was observed that the scale has a multifactorial structure and some items overlap. This indicates the need for further analysis and additional EFAs. Therefore, the EFA was conducted three times. The final EFA resulted in a scale consisting of 3 factors and 17 items. To test the suitability of the 17 item attitude scale for EFA, the KMO Test and Bartlett's Test were applied, and the results are presented in Table 1.

Table 1.*Results of the Scale's KMO and Bartlett's Test*

Kaiser-Meyer-Olkin sample adequacy measure		.837
Bartlett's sphericity test	chi-square	1270.790
	<i>SD</i>	136
	<i>p</i>	.000

The KMO test resulted in .837. The calculated Bartlett's test result was found to be significant ($p < .00$). If the KMO coefficient is greater than .60 and the Bartlett test is statistically significant, the data is considered suitable for factor analysis (Büyüköztürk, 2019). Looking at the results obtained, it is seen that the data is suitable for factor analysis. The scree plot for the eigenvalues of the factors of the Environmental Attitude Scale is presented in Graph 1.

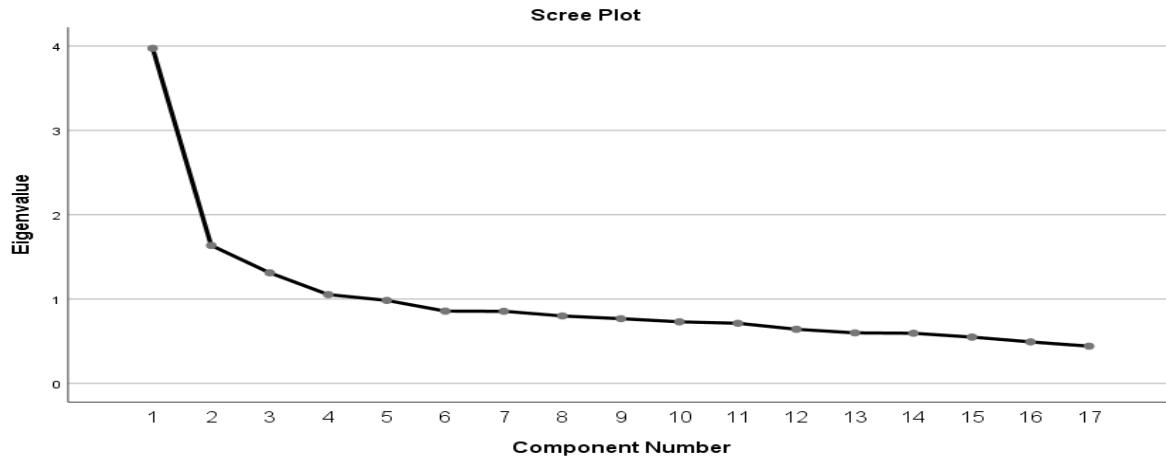
Graph 1.*Scree Plot Based on Eigenvalues of Factors*

According to Graph 1, breaks were observed at three points. In this context, it can be predicted that the scale may consist of three factors. The results of the rotated component analysis applied to the 17 items in the Environmental Attitude Scale, including item numbers, item contents, common factor variances of items, the number of factors separated, which items are under which factors, and the load values for each item and factor, are presented in Table 2.

Table 2.

Results of Rotated Principal Component Analysis for Factor Analysis

Item number	Common factor variance (Extraction)	Factor 1	Factor 2	Factor 3
t35	.462	.661		
t24	.445	.651		
t38	.484	.643		
t3	.402	.615		
t10	.478	.580		
t21	.444	.544		
t11	.390	.521		
t9	.444	.507		
t8	.591	.362		
t32	.651		.816	
t31	.613		.759	
t45	.442		.548	
t37	.409		.380	
t23	.474			.669
t6	.435			.643
t18	.443			.609
t16	.350			.420

According to the results in Table 2, the variance of each item in a common factor ranges from .35 to .65, indicating that the items in the scale collectively account for a variance of .30 or higher in a common factor. Therefore, there is no need to remove any items from the scale. Similarly, Kalaycı (2009) emphasized that each factor should have a minimum common variance explanation of .30.

According to Table 2, it was determined that the scale consists of a three-factor structure. The first factor is formed by items t35, t24, t38, t3, t10, t21, t11, t9, and t8, with factor loadings ranging from .36 to .66. The second factor is formed by items t32, t31, t45, and t37, with factor loadings ranging from .38 to .81. The third factor is formed by items t23, t6, t18, and t16, with factor loadings ranging from .42 to .66. To evaluate the relationships between the three factors obtained from the EFA, inter-factor correlation values were calculated. These values are presented in Table 3.

Table 3.

Correlation Results of the Factors

	Factor1	Factor2	Factor3
Factor1	1		
Factor2	.272**	1	
Factor3	.279**	.166**	1

Table 3 indicates that the three factors comprising the Environmental Attitude Scale are significantly related to each other. The correlation coefficients between the factors range from .16 to .27. According to Seçer (2021), correlation coefficients between factors exceeding .90 indicate multicollinearity problems, which are not recommended. However, the correlation values provided in Table 3 indicate that the scale does not have multicollinearity issues. Additionally, the values in Table 3 also indicate that each sub-factor measures a different characteristic.

The Cronbach's alpha coefficient of internal consistency was calculated to assess the reliability of the Environmental Attitude Scale. This calculation was performed to evaluate both the overall reliability of the scale and the reliability of its subscales. The obtained Cronbach's alpha values are presented in Table 4.

Table 4.

Reliability Coefficients for the Overall Environmental Attitude Scale and Its Subscales

	Number of items	Cronbach alpha
factor1	9	.732
factor2	4	.660
factor3	4	.613
The overall scale	17	.763

The overall Cronbach's alpha coefficient of internal consistency for the Environmental Attitude Scale was calculated as .76. This value indicates that the scale has the required reliability. A reliability coefficient of .70 or higher is generally considered acceptable (Durmuş et al., 2013; Seçer, 2021; Tezbaşaran, 1997). When examining the subscales of the Environmental Attitude Scale, it can be stated that the reliability coefficient of the first subscale is above .70, indicating that the measurements are reliable. The Cronbach's alpha coefficient of internal consistency for the second and third subscales is found to be .66. Sipahi et al., (2010) have supported the view that a reliability coefficient of .60 or higher is sufficient when the number of items in the scale is low. Therefore, considering that the second and third subscales consist of 4 items each, the values of .66 and .61 can be considered sufficient for reliability.

While naming the 3 factors that emerged as a result of EFA, Tezbaşaran (1997) emphasized the method of recording the particles within the scope of the factor loadings, the distribution of the ratios between the variables depending on their levels, and naming them based on the theoretical framework, and suggested that experts should not be taken into account during the process. The scale development process is to expand the information about the data in the item repository primary school curriculum by considering sensory and behavioral dimensions. The three factors consisting of this dimension were discussed separately, the items were re-read, and the process was named according to the underlying dimension. Two experts were interviewed during and after the naming. Thus, the factors in the Primary School Level Environmental Attitude Scale are named as follows.

Factor 1. Behavioral Tendency Towards the Environment

Factor 2. Affective Tendency Towards the Environment

Factor 3. Cognitive Tendency Towards the Environment

EFA and CFA are two statistical analysis methods that serve different purposes. While EFA is used to discover the factor structure of a scale and to recognize the relationships between the measured variables, CFA is used to evaluate whether a previously used scale fits the actual factor structure when used in the current research and if so, to what extent (Suhr, 2006). In the scale development process, EFA is applied first. This analysis reveals the factor structure of the scale using the data obtained from the data collection process and helps to discover new factors. Then, CFA is conducted to confirm this new factor structure. However, it is important to note that EFA and CFA should not be conducted on the same sample (Suhr,

2006). CFA with the data collected for EFA can only provide confirmation of the discovered structure and may not provide any important information. Therefore, a new data collection process is necessary to retest the factor structure obtained as a result of EFA with new data.

Data was collected from 527 students, 252 (48%) of whom were girls and 275 (52%) were boys, through simple random sampling from six different primary schools in Kırşehir city center determined by a layered sampling method for CFA. The Environmental Attitude Scale, reduced to 17 items from 45 items through EFA, was applied, and CFA was conducted using LISREL 8.80 statistical analysis software on the obtained data.

The overall Cronbach's alpha coefficient for internal consistency of the Environmental Attitude Scale data collected for CFA was calculated as .91, confirming that the scale has the required reliability. Additionally, it was observed that the Cronbach's alpha coefficients for the sub-dimensions of the scale were higher compared to the values obtained from EFA. The Cronbach's alpha coefficient for the first factor increased from .73 to .89, for the second factor from .66 to .73, and for the third factor from .61 to .66.

In CFA, model fit was evaluated using model fit criteria such as RMSEA, SRMR, GFI, AGFI, CFI, and NFI. The RMSEA value was calculated as .049, which according to Browne and Cudeck (1993), indicates a good fit when below .05. The SRMR value for the scale was calculated as .042. Kline (2005) suggests that an SRMR value generally below .10 is considered favorable. Therefore, based on the LISREL data, it can be said that the RMSEA and SRMR values for the scale are favorable.

When evaluating the model fit in CFA, the GFI value was calculated as .96, which is above the recommended threshold of .90 according to Kline (2005). The Adjusted AGFI value was calculated as .95. According to Jöreskog and Sörbom (1993), GFI and AGFI values can range from 0 to 1, with values closer to 1 indicating better model fit. It is also emphasized that these values should not be negative. Raykov and Marcoulides (2006) share a similar view, arguing that GFI and AGFI values between 0 and 1, closer to 1, indicate an appropriate model fit.

Kline (2005) and Raykov and Marcoulides (2006) stated that the NFI value should be close to 1 for an appropriate model fit. According to the measured data, the NFI value was calculated as .94. Furthermore, Byrne (2010), Raykov and Marcoulides (2006) and Brown (2006) argued that the CFI value should also be close to 1. According to the calculation results, the CFI value was calculated as .98. These values show that the model exhibits an acceptable fit. The CFA data of the environmental attitude scale evaluated above were reevaluated in the table below according to the values tabulated by Schumacker and Lomax (2004) and Seğer (2021).

Table 5.
Results of CFA for the Environmental Attitude Scale

Indexes	Perfect fit criterion	Acceptable fit criterion	Finding	Result
X2/sd	0-2.5	2.5-3	2.26	perfect
RMSEA	≤.05	≤.08	.049	perfect
SRMR	≤.05	≤.08	.042	perfect
RMR	≤.05	≤.08	.015	perfectl
NFI	≥.95	≥.90	.94	acceptable
NNFI	≥.95	≥.90	.97	perfect
CFI	≥.95	≥.90	.98	perfect
GFI	≥.90	≥.85	.96	perfect
AGFI	≥.90	≥.85	.95	perfect
IFI	≥.95	≥.90	.98	perfect
RFI	≥.95	≥.90	.93	acceptable

According to Table 5, it is observed that 2 of the data obtained from the Environmental Attitude Scale through CFA are acceptable, and 8 of them have excellent level results. The diagram obtained through CFA is included in Figure 1.

Figure 1.
Fit Diagram Obtained with CFA.

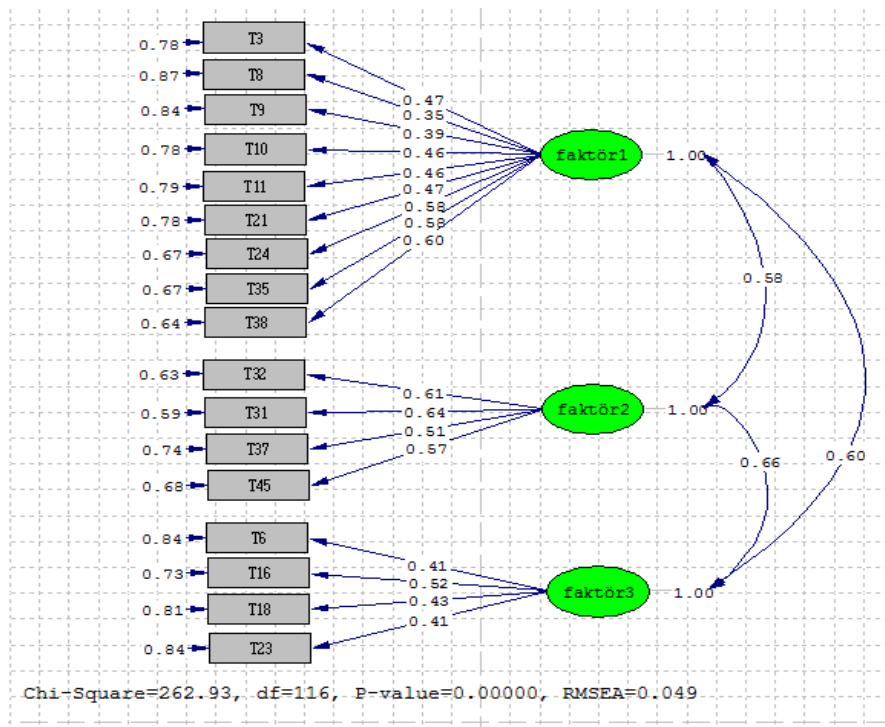

In Figure 1 obtained using the Lisrel 8.80 program, normalized factor values obtained according to CFA results are displayed. These values represent the relationships between observed variables and latent variables. The fact that none of the correlation values between observed variables is above 1 indicates that the relationships between these variables are at an appropriate level. Additionally, according to the diagram, it is concluded that the structure of the Environmental Attitude Scale is significant based on the chi-square fit value ($\chi^2= 262.93$, $df=116$, $p=.00$) obtained from CFA. Considering the sample size, a chi-square value of 262.93

with degrees of freedom (df) of 116 was determined. The ratio χ^2/df for model fit is 2.26. These values indicate an acceptable model fit (adapted from Bollen 1989, as cited in Kline, 2005).

Discussion and Conclusion

The aim of the study is to develop a valid and reliable scale to determine primary school students' attitudes towards the environment. In preparing the Environmental Attitude Scale, the scale development stages proposed by DeVellis (2016) were considered. Learning outcomes determined by the Ministry of National Education [MoNE] were examined, and a pool of items was created by reviewing the literature on the subject. The item pool consisted of a total of 50 items. Each item in the item pool was thoroughly examined, and in this context, 50 items were prepared for expert opinions. After obtaining expert opinions, Content Validity Ratios [CVR] for the items were calculated using Lawshe's (1975) technique, and items with CVR values below the specified minimum value ($=.59$) were removed, resulting in a scale ready for pilot testing with 45 items.

The 45-item scale was administered to 50 fourth-grade primary school students, and it was concluded that there were no items that were not understood, and the scale could be administered in 25-30 minutes. It was decided that there was no need to add an additional validation item, and the scale was evaluated for meeting the necessary conditions for EFA. The first factor considered in determining the adequacy of the data set was the sample size. Kline (1994) suggests that a sample size ten times the number of items may be sufficient for reliable factors to emerge. While it is mentioned that this number can be reduced to 100 when the factor structure is clear and limited, it is generally emphasized that working with larger samples is more appropriate (as cited in Çokluk et al., 2010). According to Field (2005), as the sample size increases, the reliability of factor analysis results also increases. Additionally, it is argued that in determining the sample size for factor analysis, the Kaiser-Meyer-Olkin test should be conducted, and the obtained value should be .60 or higher, and the Bartlett test should be statistically significant (Büyüköztürk, 2019). Finally, according to the criteria in the literature, it is stated that meeting at least two criteria may be appropriate for determining an adequate sample size for factor analysis (Çokluk et al., 2010). In this context, it can be stated that obtaining data from 450 individuals for EFA in this study is in line with the specified criteria. The first Kaiser-Mayer-Olkin test result for the data set was found to be .837, and the Bartlett test was statistically significant ($p=.000$). These results indicate that the data set of 450 individuals is of sufficient sample size for EFA.

SPSS 25 statistical calculation software was used for factor analysis of the scale. To evaluate the discriminant power of the items in the draft scale, the difference between the mean scores of the lower group and upper group environmental attitude scores for each item was examined. It was found that there was a significant difference between the mean scores of the lower group and upper group environmental attitude scores. In each item, since the p-value in the t-test results for item means was less than .05, it was concluded that the scale items contribute to measuring the desired characteristic. In the calculation of the item-total correlation value for the draft scale, it was observed that the item-total correlation values for all items in the scale ranged from .430 to .654. Büyüköztürk (2019) emphasizes that when the item-total correlation coefficients are .30 and above, the items distinguish individuals well.

Seçer (2021) suggests that the item factor load should be at least .30, which also supports the reliability of the scale.

Upon examining the item-total correlation and the scree plot graph for the Environmental Attitude Scale consisting of 45 items, it was observed that the scale had a multifactorial structure and some items overlapped with each other. This situation indicated the need for further analysis and more factor analyses [EFA]. Considering that the items in the measurement tool were related to each other in the context of the scale where EFA was performed, the promax oblique rotation technique was used. Promax oblique rotation was applied three times. As a result, a 17 item scale was obtained. The maximum score that can be obtained from the triple Likert scale is 51, and the minimum score is 17. The results of the rotated component analysis conducted on the 17 items of the Environmental Attitude Scale (item number, item content, common factor variance for the items, factors, and factor load values of the items under the factors) were examined, and it was observed that the variance explained together in a common factor ranged from .35 to .65. In this context, since the values of the variance explained together in a common factor were greater than .30, it was understood that none of the items in the scale needed to be removed. Similarly, Kalaycı (2009) states that factors should have a common variance explained of at least .30. It was determined that the scale consisted of three factors, with the first factor being composed of items t35, t24, t38, t3, t10, t21, t11, t9, and t8, and the factor loadings of these items ranged from .36 to .66. It was determined that the second factor was formed by items t32, t31, t45, and t37, with factor loadings ranging from .38 to .81. The third factor was formed by items t23, t6, t18, and t16, with factor loadings ranging from .42 to .66. When the correlation values between the three factors that make up the Environmental Attitude Scale were calculated, it was observed that the three factors were significantly correlated with each other, with values ranging from .16 to .27, indicating a meaningful relationship between the factors. To evaluate the reliability of the Environmental Attitude Scale, Cronbach's alpha internal consistency coefficient was calculated. The Cronbach's alpha internal consistency coefficient for the overall Environmental Attitude Scale was calculated as .76. This value indicates that the scale has the required reliability. A reliability coefficient of .70 and above is considered reliable for measurements (Durmuş et al., 2013; Seçer, 2021; Tezbaşaran, 1997). Looking at the sub-dimensions of the Environmental Attitude Scale, it can be said that the reliability coefficients of the first sub-dimension are above .70, and therefore the measurements are reliable. The Cronbach's alpha internal consistency coefficient for the second and third sub-dimensions was found to be .66. According to Sipahi et al. (2010), when the number of items in the scale is low, a reliability coefficient of .60 and above is considered sufficient. Therefore, considering that the second and third sub-dimensions consist of 4 items, it can be concluded that the values of .66 and .61 are sufficient for reliability.

The three factors identified through the data obtained from EFA were named as Environmental Behavioral Tendencies, Environmental Affective Tendencies, and Environmental Cognitive Tendencies. Considering that the item lengths were also adequate and the reliability of the developed scale was not low, the study proceeded to CFA.

Morgan (1991) acknowledges that attitude includes behavior as a component and that attitudes can predict behaviors. Therefore, it is observed that attitude scales related to the environment are generally developed, and in the development of these scales, only EFA is used (Bogner & Wiseman, 2006; Çınar et al., 2008; Kaiser et al., 1999). However, Şimşek (2007) notes that a scale without a solid theoretical foundation may yield good results in EFA but may not yield the same results in CFA. Therefore, both EFA and CFA were used in the study. It can be said that the scale development study conducted in this context made a significant contribution to the literature. After reducing the Environmental Attitude Scale from 45 items to 17 items based on the results of EFA, the final version of the scale was applied, and CFA was conducted using the data obtained. The Cronbach's alpha internal consistency coefficient for the overall Environmental Attitude Scale based on the data collected for CFA was calculated as .91. This value confirms that the scale has the required reliability. It was observed that the Cronbach's alpha internal consistency coefficients for the sub-dimensions of the environmental attitude scale were higher compared to the values in EFA based on the data collected for CFA. For example, while the Cronbach's alpha internal consistency coefficient for the first factor was .73, it increased to .89, for the second factor from .66 to .73, and for the third factor from .61 to .66. In CFA, the model fit criteria RMSEA value was calculated as .049, SRMR value as .042, and GFI value as .96. The GFI statistic ranges from 0 to 1 and moves inversely with degrees of freedom. That is, as the sample size increases, the GFI value generally tends to increase (Bollen, 1990). Traditionally, a GFI value of .90 is recommended as an acceptable value. However, GFI values up to .95 can be considered for evaluation in cases of small sample sizes or low factor loadings (Shevlin & Miles, 1998). The GFI value of the developed scale is consistent with the literature.

The AGFI value was calculated as .95, the CFI value as .98, and the NFI value as .94. As a result, based on the literature (Schumacker and Lomax, 2004; Seçer, 2021), it is observed that two of the data obtained from CFA for the Environmental Attitude Scale are acceptable, and eight of them are at an excellent level of results.

The goodness-of-fit test result for the structure of the scale obtained through CFA yielded a significant chi-square value ($\chi^2= 262.93$, $df=116$, $p=.00$). It was determined that the chi-square value, which varies according to sample size, was 262.93 with 116 degrees of freedom. The Environmental Attitude Scale, developed through EFA and CFA applications and designed to be applied to elementary school students, has reached its final form.

As a result, it can be said that a scale with appropriate content validity and reliability has been developed in the scale development process. Okur and Yalçın Özdilek (2012) improved the environmental attitude scale with positive and negative attitude sub-factors among teacher candidates. Kılıç and Kan (2020) addressed attitude in their attitude scale towards environmental issues for middle school students, considering positive cognitive, negative cognitive, affective, and behavioral dimensions. Yücel and Özkan (2014) divided attitude into behavior, emotion, thought, and willingness to act in their environmental attitude scale for middle school students. The developed scale is prepared to include the cognitive, affective, and behavioral dimensions of elementary school students' environmental attitudes.

Therefore, this study makes a significant contribution to the field of scale development as it addresses the fundamental three dimensions of attitude.

Recommendations

The developed Primary School Level Environmental Attitude Scale can be used as a data collection tool in future studies by reorganizing it in line with the curriculum and achievements for different grade levels. It can also be revised for different grade levels.

Studies can be conducted to increase the coefficients of items with low factor variance. In addition, arrangements can be made for the factors with fewer items.

Teachers can use the developed scale in their classes to determine the level of their students' attitudes towards the environment, and they can carry out studies to take precautions against the negative attitudes they identify.

The developed scale can be used to conduct studies by scanning environmental attitudes across the province, region or Türkiye. Educational policies can be developed for schools and classes where the scale yields low results. Sharing the results obtained with stakeholders can form the basis for future studies in the field of environment.

Curriculum implementers and curriculum development experts can use this scale to determine the situation and needs, and update the outcomes accordingly.

References

- Ada, S., Baysal, Z., & Şahenk Erkan, S. (2017). *Çeşitli boyutlarıyla çevre eğitimi* [Environmental education in various dimensions]. Nobel.
- Afacan, Ö., & Demirci Güler, M. P. (2011, April 27-29). *Sürdürülebilir çevre eğitimi kapsamında tutum ölçeği geliştirme çalışması* [Attitude scale development study within the scope of sustainable environmental education]. 2nd International Conference on New Trends in Education and Their Implications, Antalya.
- Allport, G. W. (1967). Attitudes. In M. Fishbein (Ed.), *Readings in attitude theory and measurement*. (pp. 3-13). John Wiley & Sons.
- Atasoy, E. (2006). *Çevre için eğitim çocuk doğa etkileşimi* [Education child nature interaction for environment]. Ezgi Kitapevi.
- Bailey, K. D. (1982). *Methods of social research*. Free.
- Bogner, F. X., & Wiseman, M. (2006). Adolescents' attitudes towards nature and environment: Quantifying the 2-MEV model. *Environmentalist*, 26, 247-254.
- Bollen, K. A. (1990). Overall fit in covariance structure models: Two types of sample size effects. *Psychological Bulletin*, 107(2), 256-259.
- Brown, T. A. (2006). *Confirmatory factor analysis for applied research* (2th ed.). Guilford.
- Browne, M. W., & Cudeck, R. (1993). Alternative ways of assessing model fit. In K. A. Bollen & J. S. Long (Eds.). *Testing structural equation models*. (pp. 136-162). Sage.
- Büyüköztürk, Ş. (2002). Faktör analizi: Temel kavramlar ve ölçek geliştirmede kullanımı [Factor analysis: Basic concepts and its use in scale improvement]. *Educational Administration: Theory and Practice*, 32(32), 470-483.
- Büyüköztürk, Ş. (2019). *Sosyal bilimler için veri analizi el kitabı: İstatistik, araştırma deseni, SPSS uygulamaları ve yorum* [Data analysis handbook for social sciences: Statistics, research design, SPSS applications and interpretation]. Pegem.
- Byrne, B. M. (2010). *Structural equation modeling with AMOS* (3th ed.). Routledge.
- Chepesiuk, R. (2007). Environmental literacy: Knowledge for a healthier public. *Environmental Health Perspectives*, 115(10), 494-499.
- Çabuk, B., & Karacaoğlu, Ö. C. (2003). Üniversite öğrencilerinin çevre duyarlılıklarının incelenmesi [Examining the environmental awareness of university students]. *Ankara University, Journal of Educational of Faculty Sciences*, 36(1-2), 189-198.
- Çınar, D., Doğu, S., & Meydan, A. (2008, May 2-4). *Sınıf öğretmenleri adaylarının çevreye karşı tutumları* [Attitudes of classroom teacher candidates towards the environment]. VII. National Classroom Teacher Education Symposium. Nobel. Ankara.
- Çıngı, H. (1994). *Örnekleme kuramı* [Sampling theory]. Hacettepe University.
- Çokluk, Ö., Şekercioğlu, G., & Büyüköztürk, Ş. (2010). *Sosyal bilimler için çok değişkenli istatistik SPSS ve LISREL uygulamaları* [SPSS and LISREL applications of multivariate statistics for social sciences]. Pegem.
- DeVellis, R. F. (2016). *Scale development: Theory and applications*. Sage.
- Demir, Z. M. (2016). *İlkokul öğrencilerine yönelik çevre tutum ölçeği geliştirme çalışması* [A study of developing an environmental attitude scale for primary school students]. (Publication No: 423568) [Master thesis, Eskisehir Osmangazi University]. National Thesis Center.
- Demirel, Ö. (1993). *Eğitim terimleri sözlüğü* [Dictionary of educational terms]. Pegem.
- Demirkaya, H. (2006). Çevre eğitiminin Türkiye'deki coğrafya programları içerisindeki yeri ve çevre eğitimine yönelik yeni yaklaşımlar [The place of environmental education in geography curricula in Turkey and new approaches to environmental education]. *Firat University Journal of Social Science*, 16(1), 207-222.

- Demirkaya, H., & Genç, H., (2006). Ormana ilişkin tutum ölçeği geliştirilmesi [Development of an attitude scale to measure attitudes toward forest]. *Kastamonu Education Journal*, 14(1), 39-46.
- Doğan, M. (1997). *Çevre eğitimi. Çevre ve insan* [Environmental education. Environment and people]. Ministry of Environment.
- Durmuş, B., Yurtkoru, E. S., & Çinko, M. (2013). *Sosyal bilimlerde SPSS’le veri analizi* [Data analysis with SPSS in social sciences] (5th ed.). Beta.
- Erdoğan, İ. (1999) *İşletmelerde davranış* [Behavior in businesses]. Evrim.
- Erefe, İ. (Ed.). (2002). *Veri toplama araçlarının niteliği. Hemşirelikte araştırma ilke süreç ve yöntemleri* [Nature of data collection tools. Research principles, processes and methods in nursing]. (pp. 169-188). HEMAR-GE.
- Erten, S. (2004). Çevre eğitimi ve çevre bilinci nedir, çevre eğitimi nasıl olmalıdır? [What is environmental education and environmental awareness, how should environmental education be?]. *Environment and Human Journal*, 65/66.
- Field, A. (2005). *Discovering statistics using SPSS*. Sage.
- Gök, E., & Afyon, A. (2015). İlköğretim öğrencilerinin çevre bilgisi ve çevresel tutumları üzerine alan araştırması [Field research on primary school students' environmental knowledge and environmental attitudes]. *Turkish Journal of Science Education*, 12(4), 77-93.
- Gökçe, N., Kaya, E., Aktay, S., & Özden, M. (2007). İlköğretim öğrencilerinin çevreye yönelik tutumları [Elementary students' attitudes towards the environment] *Elementary Education Online*, 6(3), 452-468.
- Görümlü, T. (2003). *Liselerde çevreye karşı duyarlılığın oluşturulmasında çevre eğitiminin önemi eğitimi* [Training on the importance of environmental education in creating environmental awareness in high schools]. (Publication No. 140108) [Master thesis, Fırat University]. National Thesis Center.
- Gürkan, T., & Gökçe, E. (1999). *Türkiye’de ve çeşitli ülkelerde ilköğretim: Program, öğrenci, öğretmen* [Primary education in Turkey and various countries: Program, student, teacher]. Siyasal.
- İnceoğlu, M. (1993). *Tutum algı iletişim* [Attitude perception communication]. Verso.
- Jöreskog, K. G., & Sörbom D. (1993). *Lisrel 8: Structural equation modeling with the SIMPLIS command language*. Scientific Software International.
- Kahyaoğlu, M. (2011). Çevre konularıyla ilgili kitap okumaya yönelik tutum ölçeği geliştirme çalışması [Development study of attitude scale towards reading book about environmental issues]. *Elementary Education Online*, 10(3), 1056-1065.
- Kaiser, F. G., Wölfling, S., & Fuhrer U. (1999). Environmental attitudes and ecological behaviour. *Journal of Environmental Psychology*, 19(1), 1-19.
- Kalaycı, Ş. (2009). *SPSS uygulamalı çok değişkenli istatistik teknikleri* [SPSS applied multivariate statistical techniques]. Asil.
- Karasar, N. (2016). *Bilimsel araştırma yöntemi: Kavramlar-ilkeler-teknikler* [Scientific research method: Concepts-principles-techniques] (35th ed.). Nobel.
- Kavruk, S. B. (2002) *Türkiye’de çevre duyarlılığının artırılmasında çevre eğitiminin rolü ve önemi* [The role and importance of environmental education in increasing environmental awareness in Turkey]. [Unpublished master thesis]. Gazi University.
- Kılıç, Ç., & Kan, A., (2020). Çevre sorunlarına yönelik tutum ölçeği geliştirme çalışması [A study on developing attitude scale towards environmental problems]. *Abant İzzet Baysal University Faculty of Education Journal*, 20(4), 1676-1690.
- Kline, P. (1994). *An easy guide to factor analysis*. London.
- Kline, R. B. (2005). *Principles and practice of structural equation modeling* (2th ed). Guilford.

- Köklü, N. (1995). Tutumların ölçülmesi ve likert tipi ölçeklerde kullanılan seçenekler [Measurement of attitudes and options used in Likert-type scales]. *Ankara University Journal of Faculty of Educational Sciences*, 28(2), 81-93.
- Lawshe, C. H. (1975). A quantitative approach to content validity. *Personnel Psychology*, 28(4), 563-575.
- Meyerhoff, J. (2006). Stated willingness to pay as hypothetical behaviour: Can attitudes tell us more? *Journal of Environmental Planning and Management*, 49(2), 209- 226.
- Morgan, C. T. (1991). *Psikolojiye giriş* [Introduction to psychology] (8th ed.). (H. Arıcı, O. Aydın, et al., Trans.). Hacettepe University Psychology Department.
- Moseley, C. (2000). Teaching for environmental literacy. *Clearing House*, 74(1), 23– 24.
- Okur, E., & Yalçın-Özdilek, Ş. (2012). Environmental attitude scale developed by structural equation modeling. *Elementary Education Online*, 11(1), 85-94.
- Raykov, T., & Marcoulides, G. A. (2006). *A first course in structural equation modeling*. Lawrence Erlbaum Associates.
- Schumacker, R. E., & Lomax, R. G. (2004). *A beginner's guide to structural equation modeling*. Psychology.
- Seçer, İ. (2021). *SPSS ve Lisrel ile pratik veri analizi: Analiz ve raporlaştırma* [Practical data analysis with SPSS and Lisrel: Analysis and reporting]. Anı.
- Shevlin, M., & Miles, J. N. (1998). Effects of sample size, model specification and factor loadings on the GFI in confirmatory factor analysis. *Personality and Individual Differences*, 25(1), 85-90.
- Sipahi, B., Yurtkoru, E. S., & Çinko, M. (2010). *Sosyal bilimlerde SPSS'le veri analizi* [Data analysis with SPSS in social sciences]. Beta.
- Suhr, D. D. (2006). *Exploratory or confirmatory factor analysis?* (pp. 1-17). SAS Institute.
- Şimşek, Ö. F. (2007). *Yapısal eşitlik modellemesine giriş, temel ilkeler ve LISREL uygulamaları* [Introduction to structural equation modeling, basic principles and LISREL applications]. Ekinoks.
- Tavşancıl, E. (2010). *Tutumların ölçülmesi ve SPSS ile veri analizi* [Measurement of attitudes and data analysis with SPSS] (3th ed). Nobel.
- Tekin, H. (1993). *Eğitimde ölçme ve değerlendirme* [Measurement and evaluation in education]. Yargı.
- Tezbaşaran, A. (1997). *Likert tipi ölçek geliştirme kılavuzu* [Likert type scale development guide]. Turkish Psychologists Association.
- Tuncer, A. (2021). *Öğretmen adaylarının çevresel tutumunu belirlemek amacıyla geliştirilen Çevre'ye Yönelik Tutum Ölçeği: Ordu Üniversitesi örneği* [Attitude Towards the Environment Scale developed to determine the environmental attitudes of pre-service teachers: The case of Ordu University]. (Publication No. 10432725) [Master thesis, Ordu University]. Ordu University Open Access System.
- Turgut, M. F., & Baykul, Y. (2010). *Eğitimde ölçme ve değerlendirme* [Measurement and evaluation in education]. Pegem.
- Yalçınkaya, E. (2012). İlköğretim 6. sınıf öğrencilerinin çevre sorunları farkındalık düzeyleri [The levels of primary 6th grade students' awareness of environmental issues]. *Marmara Geographical Review*, (25), 137-151.
- Yaşaroğlu, C., & Akdağ, M. (2013). İlköğretim birinci kademe için çevreye yönelik tutum ölçeği: Geçerlik ve güvenirlik çalışması [Scale of first stage elementary school students' attitudes towards environment: The study of validity and reliability]. *Adiyaman University Journal of Social Sciences*, (13), 253-275.
- Yurdubakan, İ. (2010) Eğitimde kullanılan ölçme araçlarının nitelikleri [Qualifications of measurement tools used in education]. In M. Gömleksiz & S. Erkan (Eds.). *Eğitimde ölçme ve değerlendirme* [Measurement and evaluation in education]. (pp. 33-66). Nobel.

Yücel, E. Ö., & Özkan, M. (2014). Ortaokul öğrencilerine yönelik çevresel tutum ölçeği geliştirilmesi [Development of environmental attitudes scale for secondary school students]. *Journal of Uludag University Faculty of Education, 27(1), 27-48.*

BIOGRAPHICAL NOTES

Contribution Rate of Researchers

Author 1: 50%

Author 2: 50%

Conflict Statement

There is no conflict of interest that the authors will declare in the research.



İlkokul Düzeyi Çevre Tutum Ölçeği Geliştirme Çalışması

Özet

Bu çalışmada, ilkököl öğrencilerinin çevreye yönelik tutum düzeylerini belirleyebilecek geçerli ve güvenilir bir ölçme aracının geliştirilmesi amaçlanmıştır. Nicel araştırma deseninin benimsendiği araştırma tarama çalışması niteliğindedir. Araştırma 2022-2023 eğitim öğretim yılında Kırşehir ilinde yer alan ilkokullarda 948 öğrencinin katılımıyla yürütülmüştür. Araştırmada, likert tipi ölçek geliştirme modeli kullanılmıştır. Ölçme aracında yer alan maddelerin birbiriyle ilişkili olduğu düşünülerek Açıklayıcı (Explanatory) Faktör Analizinde [AFA] promax eğik döndürme tekniği kullanılmıştır. Üç kez uygulanan döndürme tekniği sonucunda, 3 alt faktörden oluşan, 17 maddelik ölçek elde edilmiştir. Ölçeğin Kaiser-Mayer-Olkin [KMO] Testi sonucu .837 olarak hesaplanmıştır. Hesaplanan Bartlett Testi sonucunun ise ($p < .00$) anlamlı olduğu tespit edilmiştir. Geliştirilen veri toplama aracının geçerlik-güvenirlik analizleri sonucunda açıklayıcı faktör analizinde .76 olarak hesaplanan Cronbach alfa iç tutarlık katsayısının doğrulayıcı faktör analizinde .91 olarak artış gösterdiği görülmüştür. Araştırma sonucunda ilkököl öğrencilerinin çevreye yönelik tutum düzeylerini belirleyebilecek geçerli ve güvenilir bir ölçme aracı geliştirilmiştir. Geliştirilen ölçek farklı sınıf düzeyleri için müfredat ve kazanımlar doğrultusunda revize edilebilir.

Anahtar Kelimeler: Çevre, ilkököl, ölçek geliştirme, tutum.

Giriş

İnsanoğlu varoluşundan itibaren çevresiyle etkileşim içinde olmuş hem çevresini etkilemiş hem de ondan etkilenmiştir. Çevre, canlıların yaşam alanıdır ve insanların sosyal, biyolojik, ekonomik, fiziksel ve kültürel ilişkilerini sürdürdükleri bir ortamdır. Bu ortam, insanların iletişim kurdukları, kendilerini gerçekleştirdikleri ve iç dünyalarıyla bütünleştikleri yerdir. Çevre, sadece fiziksel bir mekân değil, kişisel ve psikolojik açıdan da önemlidir. Çevre ile etkileşimler bireyin kendini gerçekleştirmesinde önemli rol oynar (Ada vd., 2017; Çabuk & Karacaoğlu, 2003; Kavruk, 2002; Yalçınkaya, 2012). Bireylerin çevre üzerindeki faaliyetleri toplumsal çevreyi de etkiler. Bu nedenle bireylerin çevre üzerindeki etkilerinin farkında olmaları önemlidir ve bu farkındalık çevre eğitimi ile sağlanabilir. Çevre eğitimi, bireylerin çevreyle ilgili durumlarda bilgili, çözüm odaklı ve sorumluluk sahibi olmalarını sağlar ve yaşam boyu devam eden disiplinler arası bir yaklaşımdır (Chepesiuk, 2007; Moseley, 2000). Çevre eğitiminin tüm boyutlarında, çevre çalışmalarına erken yaşlarda başlamanın önemi vurgulanır. Erken yaşlarda başlayan çevre eğitimi, bireylerin çevresel tutum ve farkındalıklarının oluşmasında büyük önem taşır (Demirkaya, 2006; Erten, 2004; Gök & Afyon, 2015; Gökçe vd., 2007).

Tutum, bireyleri belirli davranışlara yönlendiren, öğrenme sonucu oluşan eğilimlerdir (Demirel, 1993). Öğrenmenin kritik döneminin temel eğitim düzeyi olduğu düşünüldüğünde, çevre eğitiminin erken yaşlarda verilmesi bireylerde çevre duyarlılığı ve olumlu tutumlar geliştirmede etkilidir. Tutum bileşenleri bilişsel, duygusal ve davranışsal boyutlardan oluşur (Morgan, 1991). Bu bileşenlerin birbirleriyle iç tutarlılığı vardır. Bireyin sahip olduğu bilgiler

olumlu yaklaşıma neden oluyorsa "bilişsel bileşen", olumlu duygulara sahip olması "duygusal bileşen", bu duygu ve düşüncelerini ifade etmesi "davranışsal bileşen" olarak adlandırılır. Tutumlar, biliş-duygu-davranış eğiliminin harmanlanmasıyla oluşan bir bütündür (İnceoğlu, 1993). Araştırmalar, bireylerin davranışları doğrudan gözlemlenebilir olsa da tutumlarını ölçmek için bir ölçeğe ihtiyaç duyulduğunu göstermektedir (Çınar vd., 2008; Meyerhoff, 2006). Bu ihtiyaçtan yola çıkarak bu araştırma, ilkökul öğrencilerinin çevreye yönelik tutumlarını belirlemek için geçerli ve güvenilir bir ölçek geliştirmeyi amaçlamaktadır. Alanyazında, ilkökul birinci kademe (Demir, 2016; Yaşaroğlu ve Akdağ, 2013) ve ikinci kademe öğrencilerine (Demirkaya ve Genç, 2006; Kılıç ve Kan, 2020) yönelik çevre tutum ölçekleri geliştirilmiş; öğretmen adaylarının çevreye yönelik tutumlarına dair ölçekler (Afacan ve Demirci Güler, 2011; Kahyaoğlu, 2011; Okur ve Yalçın Özdilek, 2012; Tuncer, 2021) bulunmaktadır. Ancak, ilkökul müfredatının tamamını ele alıp çevre ile ilgili kazanımları belirleyen ve tutumun üç boyutunu baz alarak geliştirilmiş bir ölçek mevcut değildir. Bu nedenle, araştırmanın alanyazına önemli bir katkı sağladığı düşünülebilir. Ölçeğin geliştirilmesi sürecinde tutumun boyutları ve ilkökul müfredatında yer alan çevre ile ilişkili kazanımlar doğrultusunda ölçek maddeleri belirlenmiştir. Bu bağlamda "İlkökul öğrencilerinin çevreye ilişkin tutum düzeylerini belirlemeye yönelik bir ölçek nasıl geliştirilebilir?" sorusuna cevap aranmıştır.

Yöntem

Araştırmanın Modeli

Araştırmada nicel araştırma yöntemlerinden biri olan genel tarama modellerinden tekil tarama modeli benimsenmiştir. Tekil tarama modeliyle öğrencilerin güncel durumları belirlenmeye çalışılmıştır. Tekil tarama modeli, evrenin bütünü yerine belirli bir grup veya alt küme üzerinden evren hakkında genel bir anlayışa varma amacıyla kullanılmıştır (Bailey, 1982).

Evren ve Örneklem

Araştırmanın evrenini 2022-2023 eğitim öğretim yılında Kırşehir ilinde ilkökullarda öğrenim gören öğrenciler, örneklemini ise; bu evrenden belirlenen 4. sınıf öğrencileri oluşturmuştur. İlkökul 4. sınıflarının belirlenmesindeki temel amaç yaş düzeylerinin ve hazırbulunuşluklarının diğer sınıflara göre daha yüksek olmasıdır. Bu sayede ölçek maddelerinin daha net anlaşılabilirliği düşünülmüştür. Örneklem alımında tabakalı örnekleme yöntemi tercih edilmiştir. Bu araştırmada tabakalı örnekleme yöntemi ile evrendeki alt grupların belirlenip bunların evren büyüklüğü içindeki oranlarıyla örnekleme temsil edilmeleri sağlanmıştır. Araştırmada okullar, öğrenci sayıları ve buldukları çevrenin sosyo ekonomik düzeyleri bakımından okul yöneticilerinden ve sınıf öğretmenlerinden alınan görüşler doğrultusunda tabakalara ayrılmıştır. Tabakalara ayrılan evren üzerinden basit tesadüfi örnekleme yöntemiyle çalışma grupları belirlenmiştir. Basit tesadüfi örnekleme yöntemi ile belirlenen her bir evrendeki bireylerin seçilme şansının eşit olasılıkta olması (Çingı, 1994) ulaşılan örnekleme evreni temsil etmek hedeflenmiştir.

Verilerin Analizi

Tutum ölçeğinin geliştirilmesinde Açıklayıcı Faktör Analizi [AFA] ve Doğrulayıcı Faktör Analizi'nden [DFA] yararlanılmıştır. AFA için SPSS 25 paket programı kullanılırken DFA için LISREL 8.80 programı tercih edilmiştir. AFA ile ölçekte bulunan her madde için alt ve üst grup ortalamaları farkına dayalı madde analizi, madde-toplam korelasyonu, çizgi (scree plot) grafiği, ölçeğin faktör analizi yeterliliğini belirlemek amacıyla Kaiser-Mayer-Olkin [KMO] Testi ve Barlett Testi, ölçeğin faktör yapısını belirtmek için faktörlerin yük hesaplamaları, faktörlerin yük değerleri ve ölçekte bulunan maddelerin faktör çatısında almış olduğu yük değerleri, Cronbach alfa iç tutarlık katsayı hesaplamaları yapılmıştır. DFA ile; veri uygunluk ölçütlerinden Root Mean Square Error of Approximation [RMSEA], Standardized Root Mean Square Residual [SRMR], Goodness of Fit Index [GFI], Adjusted Goodness of Fit Index [AGFI], Comparative Fit Index [CFI], Normed Fit Index [NFI] değerleri, serbestlik değeri ve ki-kare uyum değeri hesaplanmıştır.

Araştırmanın Etik İzinleri:

Bu çalışmada "Yükseköğretim Kurumları Bilimsel Araştırma ve Yayın Etiği Yönergesi" kapsamında uyulması gerektiği belirtilen tüm kurallara uyulmuştur. Yönergenin ikinci bölümü olan "Bilimsel Araştırma ve Yayın Etiğine Aykırı Eylemler" başlığı altında belirtilen eylemlerin hiçbiri gerçekleştirilmemiştir.

Etik Kurul İzin Bilgileri:

Etik değerlendirmeyi yapan kurulun adı = Kırşehir Ahi Evran Üniversitesi Sosyal ve Beşerî Bilimler Bilimsel Araştırma ve Yayın Etik Kurulu

Etik kurul etik inceleme karar tarihi= 02.02.2023

Etik değerlendirme belgesi konu numarası= 2023/01/27

Bulgular

Çevre tutum ölçeği oluşturulurken, DeVellis (2016) tarafından önerilen yedi aşamalı ölçek geliştirme basamakları temel alınmıştır. Elde edilen sonuçlar bu adımlar çerçevesinde sunulmuştur.

1. Ölçülecek Konunun Açıkça Belirlenmesi

Ölçek hazırlığı sürecinde ilk adım olarak tutumla ilgili alanyazının taranması, literatürde yer alan tutum içerikli anket maddelerinin gözden geçirilmesi ve diğer ilkökul dersleriyle ilgili literatürde yer alan tutum ölçeklerinin incelenmesi gerçekleştirilmiştir. Ardından ilkökul müfredatındaki kazanımlar analiz edilmiş ve çevre ile ilgili kazanımlar madde havuzu oluşturmak için belirlenmiştir.

2. Madde Havuzunu Oluşturma

Literatür incelemesinin ardından, maddeleri yazma ve madde havuzu oluşturma adımı gerçekleştirilmiştir. Bu adımda, ilkökul müfredatında yer alan bütün derslerin kazanımlarında çevreye yönelik tutum ifadeleri belirlenmiş, ilgili kazanımlar tespit edilmiş ve tutumun bilişsel, duyuşsal ve davranışsal boyutuna ilişkin uygun maddeler gruplandırılarak yazılmıştır. Madde havuzu oluşturulurken tutumun bilişsel, duyuşsal ve davranışsal boyutuna ilişkin benzer

oranlarda maddeye yer verilmeye çalışılmıştır. Oluşturulan maddeler daha sonra değerlendirilmiş ve her bir madde dikkatlice incelenerek kazanımları kapsamayan ve ilkökul düzeyine uygun görülmeyen maddeler uzman görüşü alınarak madde havuzundan çıkarılmıştır. Oluşturulan madde havuzu son haliyle toplamda 50 maddeyi içermiştir.

3. Ölçme Düzenini Belirleme

Çalışma ilkökul düzeyinde gerçekleştirildiğinden ölçüm formatı olarak 3'lü likert tipi tercih edilmiştir.

4. Uzmanlar Tarafından Madde Havuzunun Gözden Geçirilmesi

Hazırlanan taslak maddelerin değerlendirilmesi amacıyla 3 sınıf öğretmeni, 3 fen bilimleri öğretmeni ve sınıf eğitimi alanında 5 akademisyene "İlkokul Düzeyi Çevre Tutum Ölçeği Uzman Değerlendirme Formu" iletilmiştir. Uzman görüşleri alındıktan sonra, Lawshe (1975) tekniği kullanılarak maddelere ilişkin Kapsam Geçerlik Oranları [KGO] hesaplanmıştır. Değerlendirmeler sonucunda, Kapsam Geçerlik İndeksi [KGI] değeri 1 olarak belirlenmiş ve bu da değerlendiriciler arasında yeterli uyum olduğunu göstermiştir. Bununla birlikte hazırlanan ölçekte yer alan 5 madde uzman görüşleri doğrultusunda KGO değerinin (= .59) belirlenen minimum değerinin altında olması sebebiyle ölçekten çıkarılmıştır. Bu durumda ölçekte 45 madde kalmıştır. Kalan 45 maddenin 15 maddesinin bilişsel, 15 maddesinin duyuşsal, 15 maddesinin de davranışsal tutum ifadelerine yönelik olduğu belirlenmiştir.

5. Doğrulama Maddelerini Dâhil Etme

Beşinci aşamada, maddelerin nihai hallerini belirlenmesi konusunda herhangi bir ek doğrulama maddesinin eklenmesine gerek olmadığı kanısına varılmıştır.

6. Madde Geliştirme için Örneklem Seçimini Belirleme

Bu aşamada, ön uygulama için yeterli olabilecek örneklemin belirlenmesi ve ön uygulamanın gerçekleştirilmesi adımları tamamlanmıştır.

7. Maddelerin Değerlendirilmesi

Madde değerlendirmeleri için bu aşamada geçerlik ve güvenilirlik hesaplamaları yapılmıştır. Bu bağlamda öncelikle kapsam, yapı ve görünüş geçerlikleri analiz edilmiştir. İlkokul Düzeyi Çevre Tutum Ölçeğinin geçerliğini değerlendirmek için AFA'nın yanı sıra DFA yöntemlerinden yararlanılmıştır. Ölçeğin güvenilirliğini belirlemek için madde analizi ve madde-toplam korelasyonu değerleri incelenmiş ve ölçekten herhangi bir madde çıkarılıp çıkarılmayacağına karar verilmiştir. Ardından ölçeğin güvenilirliğini belirlemek için Cronbach alfa güvenilirlik katsayısı hesaplanmıştır.

Çevre Tutum Ölçeğinin Madde Analizi

Taslak ölçekte yer alan maddelerin ayırt edicilik potansiyelini değerlendirmek amacıyla, her bir madde için alt grup ile üst grup arasında çevre tutum puanları ortalamaları açısından anlamlı bir farklılık gözlemlenmiştir. Her bir madde için $p < .05$ olduğu görülmüş olup bu da ölçek maddelerinin ölçülmek istenen özelliğin ölçülmesine katkıda bulunduğunu göstermektedir. Böylece ölçekten herhangi bir madde çıkarılmamıştır. KMO Testi sonucu .837 olarak hesaplanmıştır. Hesaplanan Bartlett Testi sonucu ise ($p < .00$) anlamlı olduğu tespit edilmiştir.

Çevre tutum ölçeğinin güvenilirliğini değerlendirmek için Cronbach alfa iç tutarlık katsayısı hesaplanmıştır. Bu hesaplama hem ölçeğin genel güvenilirliğini hem de alt boyutlarına ait güvenilirliği değerlendirmek amacıyla yapılmıştır. Çevre tutum ölçeğinin genel Cronbach alfa iç tutarlık katsayısı .76 olarak hesaplanmıştır. Bu değer, ölçeğin gereken güvenilirliğe sahip olduğunu göstermektedir.

AFA sonucunda ortaya çıkan 3 faktör isimlendirilirken Tezbaşaran (1997), maddelerin taşıdığı faktör yükleri kapsamında belirlenen maddelerin, faktörler arasındaki ilişkilerin düzeyine bağlı olarak düzenlenmesi, faktörlerin teorik çerçeveye dayalı olarak adlandırılması gerektiğini vurgulamış ve sürecin yürütülmesi sırasında konuda uzman kişilerin görüşlerinin dikkate alınmasını önermiştir. Ölçek geliştirme sürecinde madde havuzu ilkökul dersleri müfredatında yer alan kazanımlar doğrultusunda tutumun bilişsel, duyuşsal ve davranışsal boyutları ele alınarak oluşturulmuştur. Bu bağlamda ölçekte oluşan üç faktör ayrı ayrı ele alınmış, maddeler yeniden okunmuş, sürecin başlangıcında temel alınan tutumun boyutlarına göre isimlendirme yoluna gidilmiştir. İsimlendirme yapılırken ve yapıldıktan sonra iki uzman görüşü alınmıştır. Böylece İlkokul Düzeyi Çevre Tutum Ölçeğindeki faktörler aşağıdaki gibi isimlendirilmiştir.

Faktör 1. Çevreye Yönelik Davranışsal Eğilim

Faktör 2. Çevreye Yönelik Duyuşsal Eğilim

Faktör 3. Çevreye Yönelik Bilişsel Eğilim

DFA için Kırşehir il merkezindeki okullardan tabakalı örneklem yöntemiyle belirlenen altı farklı ilkokuldan basit seçkisiz örnekleme yoluyla 252'si (%48) kız ve 275'i (%52) erkek olmak üzere toplam 527 öğrenciden veri toplanmıştır. AFA sonucunda 45 maddeden 17 maddeye düşen Çevre Tutum Ölçeği son hali ile uygulanmış ve elde edilen veriler üzerinde LISREL 8.80 istatistik hesaplama programı kullanılarak DFA yapılmıştır.

Çevre Tutum Ölçeğinin DFA için toplanan verilerine göre genel Cronbach alfa iç tutarlık katsayısı .91 olarak hesaplanmıştır. Bu değer, ölçeğin gereken güvenilirliğe sahip olduğunu doğrulamaktadır. Ayrıca, DFA için toplanan verilere göre ölçeğin alt boyutlarına ait Cronbach alfa iç tutarlık katsayılarının AFA'daki değerlere kıyasla daha yüksek olduğu gözlemlenmiştir. Birinci faktörün Cronbach alfa iç tutarlık katsayısı .73 iken .89'a, ikinci faktörün katsayısı .66 iken .73'e ve üçüncü faktörün katsayısı .61 iken .66'ya yükselmiştir.

DFA'da, modelin uygunluğunu değerlendirmek için RMSEA, SRMR, GFI, AGFI, CFI, NFI gibi model uygunluk ölçütleri kullanılmıştır. RMSEA değeri .049 hesaplanmıştır. Browne ve Cudeck'e (1993) göre, RMSEA değerinin .05'in altında olması iyi bir uyum gösterdiğini belirtmektedir. Ölçeğin SRMR değeri .042 olarak hesaplanmıştır. Kline'a (2005) göre SRMR değerinin genel olarak .10'un altında olması olumlu olarak kabul edilmektedir. Bu bağlamda LISREL verilerine göre ölçeğe ait RMSEA ve SRMR değerinin olumlu değerler aldığı söylenebilir.

DFA' da modelin uygunluğu baz alındığında .90 değerinin üzerinde olması gereken (Kline, 2005) GFI değeri .96 olarak hesaplanmış, AGFI değeri ise .95 olarak hesaplanmıştır. Jöreskog ve Sörbom'a (1993) göre, GFI ve AGFI değerlerinin modelin uyumunu yansıttığında

0 ile 1 arasında bir değer alabileceği ve 1'e daha yakın olmasının istenilen durum olduğu belirtilmektedir. Ayrıca, bu değerlerin negatif olmaması gerektiği vurgulanmaktadır. Raykov ve Marcoulides (2006) ise aynı görüşü paylaşarak GFI ve AGFI değerlerinin 0 ile 1 arasında olması ve 1'e yakın olması durumunda uygun bir model uyumu olduğunu savunmuşlardır.

Kline (2005) ve Raykov ve Marcoulides (2006), uygun bir model uyumu için NFI değerinin 1'e yakın olması gerektiğini ifade etmişlerdir. Ölçülen verilere göre NFI değeri .94 olarak hesaplanmıştır. Ayrıca Byrne (2010), Raykov ve Marcoulides (2006) ve Brown (2006), CFI değerinin de 1'e yakın olması gerektiğini savunmuşlardır. Hesaplama sonuçlarına göre CFI değeri .98 olarak hesaplanmıştır. Bu değerler, modelin kabul edilebilir bir uyum sergilediğini göstermektedir. Çevre tutum ölçeğinin yukarıda değerlendirilen DFA verileri Schumacker ve Lomax (2004) ve Seçer (2021) tarafından tablolaştırılan değerlere göre aşağıdaki tabloda belirtilip yeniden değerlendirilmiştir.

Tartışma ve Sonuç

Morgan (1991), tutumun bir bileşenin de davranış olduğu ve tutumların davranışları öngörebileceği kabul edilmektedir. Bu nedenle çevreye ilişkin genellikle tutum ölçeklerinin geliştirildiği ve bu ölçeklerin geliştirilmesinde sadece AFA'nın kullanıldığı gözlenmektedir (Bogner & Wiseman, 2006; Çınar vd., 2008; Kaiser vd., 1999). Ancak Şimşek (2007), sağlam bir teorik temele sahip olmayan bir ölçeğin, AFA'da iyi sonuçlar verse bile aynı sonucun DFA'dan elde edilemeyeceğini belirtmektedir. Bu nedenle, araştırmada hem AFA hem DFA kullanılmıştır. Yürütülen ölçek geliştirme çalışmasının bu bağlamda alanyazına önemli bir katkı sağladığı söylenebilir. AFA sonucunda 45 maddeden 17 maddeye düşen Çevre Tutum Ölçeği son hali ile uygulanmış ve elde edilen veriler üzerinde LISREL 8.80 istatistik hesaplama programı kullanılarak DFA yapılmıştır. Çevre tutum ölçeğinin DFA için toplanan verilerine göre geneline ait Cronbach alfa iç tutarlık katsayısı .91 olarak hesaplanmıştır. Bu değer, ölçeğin gereken güvenilirliğe sahip olduğunu doğrulamaktadır. DFA için toplanan verilere göre çevre tutum ölçeğinin alt boyutlarına ait Cronbach alfa iç tutarlık katsayılarının AFA'daki değerlere kıyasla daha yüksek olduğu gözlemlenmiştir. Örneğin, birinci faktörün Cronbach alfa iç tutarlık katsayısı .73 iken .89'a, ikinci faktörün katsayısı .66 iken .73'e ve üçüncü faktörün katsayısı .61 iken .66'ya yükselmiştir. DFA'da, yapının uygunluğu için model uygunluk ölçütlerinden RMSEA değeri .049, SRMR değeri .042 olarak hesaplanmıştır. GFI değeri .96 olarak hesaplanmıştır. GFI istatistiği 0 ile 1 arasında değer alır ve serbestlik derecesiyle ters orantılı olarak hareket eder. Yani, örnek büyüklüğü arttıkça GFI değeri genellikle artma eğilimindedir (Bollen, 1990). Geleneksel olarak, .90 GFI değeri kabul edilebilir bir değer olarak önerilmektedir. Ancak, küçük örneklem büyüklükleri veya düşük faktör yükleri gibi durumlarda, değerlendirme yapmak için .95'e kadar olan GFI değerleri dikkate alınabilir (Shevlin & Miles, 1998). Geliştirilen ölçeğin GFI değeri literatürle uyumludur.

AGFI değeri .95, CFI değeri .98, NFI değeri ise .94 hesaplanmıştır. Sonuç olarak çevre tutum ölçeğinin DFA ile elde edilen verilerinin alan yazına göre (Schumacker ve Lomax, 2004; Seçer, 2021) 2 tanesinin kabul edilebilir ve 8 tanesinin de mükemmel düzeyde sonuçlara sahip olduğu görülmüştür.

DFA sonucunda ölçeğin yapısının ki-kare uyum değerinin ($X^2 = 262.93$, $sd = 116$, $p = .00$) anlamlı olduğu tespit edilmiştir. Örneklem büyüklüğüne göre değişiklik gösteren X^2 değerinin 262.93, serbestlik derecesinin [df] 116 olduğu belirlenmiştir. AFA ve DFA uygulamalarıyla geliştirilen ve ilkokul düzeyi öğrencilere uygulanabilecek veri toplama aracı olan Çevre Tutum Ölçeğinin son haline ulaşılmıştır.

Sonuç olarak ölçek geliştirme sürecinde kapsam geçerliliği ve güvenilirliği uygun olan bir ölçek geliştirildiği söylenebilir. Okur ve Yalçın Özdilek (2012) öğretmen adaylarıyla yürüttükleri çevresel tutum ölçeğini olumlu ve olumsuz tutum alt faktörlerinde geliştirmişlerdir. Kılıç ve Kan (2020) ise ortaokul öğrencilerine yönelik geliştirdiği çevre sorunlarına yönelik tutum ölçeğinde tutumu, olumlu bilişsel, olumsuz bilişsel, duyuşsal ve davranışsal olarak dört boyutta ele almıştır. Yücel ve Özkan'ın (2014) ortaokul öğrencilerine ilişkin geliştirmiş oldukları çevre tutum ölçeğinde ise tutumu davranış, duygu, düşünce ve eylemde bulunmaya isteklilik olarak faktörlere ayırmışlardır. Geliştirilen bu ölçek ilkokul öğrencilerinin çevre tutumlarını bilişsel, duyuşsal ve davranışsal boyutlarını içerecek şekilde hazırlanmıştır. Bu nedenle, yapılan çalışma tutumun temel üç boyutunu ele aldığından ölçek geliştirme alanında önemli bir katkı sağlamaktadır.

Öneriler

Geliştirilen İlkokul Düzeyi Çevre Tutum Ölçeği farklı sınıf düzeyleri için müfredat ve kazanımlar doğrultusunda yeniden düzenlenerek gelecek çalışmalarda veri toplama aracı olarak kullanılabilir. Ayrıca farklı sınıf düzeyleri için revize edilebilir.

Faktör varyansı düşük olan maddelerin katsayılarını arttırmak için çalışmalar yapılabilir. Ayrıca madde sayısı az olan faktörlere ilişkin düzenlemeler yapılabilir.

Öğretmenler, geliştirilen ölçeği, öğrencilerinin çevreye yönelik tutum düzeylerini belirlemek amacıyla sınıflarında kullanabilir, belirledikleri olumsuz tutumlara ilişkin önlem almaya yönelik çalışmalar yapabilirler.

Geliştirilen ölçek, il, bölge veya Türkiye genelinde çevresel tutumları tarayarak çalışmalar yapmak amacıyla kullanılabilir. Yapılan taramalarda, ölçeğin düşük sonuçlar verdiği okullar ve sınıflara yönelik eğitim politikaları geliştirilebilir. Elde edilen sonuçların paydaşlarla paylaşılması çevre alanında yapılacak çalışmalara temel oluşturabilir.

Öğretim programları uygulayıcıları ve program geliştirme uzmanları, durumu belirlemek ve ihtiyaçları tespit etmek amacıyla bu ölçeği kullanabilir, bu doğrultuda kazanımları güncelleyebilirler.

Ek 1: İlkokul Düzeyi Çevre Tutum Ölçeği

Sıra Numarası		(3) Katılıyorum	(2) Kısmen katılıyorum	(1) Katılmıyorum
1	Okulda su kaynaklarımı boşa harcamamaya özen gösteririm.	③	②	①
2	Gelecekte temiz içme suyu bulmakta zorlanacağımızı düşünürüm.	③	②	①
3	Elektrikli aletlerin kullanılmadığında fişten çekilmesini uygun bulurum.	③	②	①
4	Çevre konusunda arkadaşlarımla konuşmaktan zevk alırım.	③	②	①
5	Odadan ayrılırken lambayı kapatmayı tercih ederim.	③	②	①
6	Buzdolabının kapağını uzun süre açık tutmam.	③	②	①
7	Geri dönüşümün ülke ekonomisine katkı sağladığına inanırım.	③	②	①
8	Çevremde bulunan bitkileri korumaya özen gösteririm.	③	②	①
9	Kullanılmış pilleri atık pil kutusuna atmaya tercih ederim.	③	②	①
10	Çevre konulu kitapları ilgi çekici bulurum.	③	②	①
11	Okulda çöpleri çöp kutusuna atmaya özen gösteririm.	③	②	①
12	Arkadaşlarımla birlikte sınıfımı temizlemekten keyif alırım.	③	②	①
13	Ağaçlara zarar vermenin doğal afetlere yol açabileceğini düşünürüm.	③	②	①
14	Çevremde bulunan hayvanları korumaya özen gösteririm.	③	②	①
15	Çevremde ağaçları görmek bana huzur verir.	③	②	①
16	Plastik poşet kullanmanın zararlı olduğunu düşünürüm.	③	②	①
17	Dişlerimi fırçalarken musluğu kapatmayı tercih ederim.	③	②	①



<http://www.tayjournal.com>

<https://dergipark.org.tr/en/pub/tayjournal>

The Discrete Option Multiple Choice Items as A Measurement Instrument for Mathematics Achievement*

Atilla Özdemir, Asst. Prof., Corresponding Author
Süleyman Demirel University, Türkiye
atillaozdemir@sdu.edu.tr
Orcid ID: 0000-0003-4775-4435

Selahattin Gelbal, Prof. Dr.
Hacettepe University, Türkiye
sgelbal@gmail.com
Orcid ID: 0000-0001-5181-7262

Article Type: Research Article

Received Date: 17.01.2024

Accepted Date: 24.06.2024

Published Date: 31.07.2024

Plagiarism: This article has been reviewed by at least two referees and scanned via a plagiarism software

Doi: 10.29329/tayjournal.2024.653.06

Citation: Özdemir, A., & Gelbal, S. (2024). The discrete option multiple choice items as a measurement instrument for mathematics achievement. *Türk Akademik Yayınlar Dergisi (TAY Journal)*, 8(2), 317-348.

*This article was produced from Atilla Özdemir's doctoral thesis supervised by Prof. Dr. Selahattin Gelbal.

Abstract

This study examines the applicability of Discrete Option Multiple Choice [DOMC] items in secondary school mathematics. The test included 25 questions, with 10 being traditional multiple-choice and 15 being DOMC items. Data were collected from 725 secondary school students during the second term of the 2020-2021 academic year. Among these students, 491 (68%) were in 7th grade and 234 (32%) were in 8th grade; 391 (54%) were female, and 334 (46%) were male. The findings revealed significant differences between the two item types, especially in high scores, using Classical Test Theory [CTT]. However, Item Response Theory [IRT] analysis showed that the question type did not affect estimations of students' ability levels, thus reducing errors in extreme values. This suggests that DOMC items do not significantly impact students' total scores when parameter estimations are performed using IRT instead of CTT. Additionally, some Traditional Multiple Choice [TMC] items were adapted into the DOMC format to test the applicability of various question types in this format.

Keywords: Classical test theory, discrete option multiple choice, item response theory, mathematics achievement, traditional multiple choice.

Introduction

Student years are essential for observing the impact of assessments and evaluations of our lives. When national (Evaluation of High School Entrance Exam), (Examination for Transition to Higher Education), etc.) and international (Scholastic Aptitude Test [SAT]), (Graduate Record Examination [GRE]), etc.) standardized tests are considered, the measurement and evaluation processes become an influential agenda for all stakeholders in education (Cohen & Swerdlik, 2018; Erdoğan, 2003; Janda, 1997; Popham, 1999). Student success was evaluated based on the results of achievement tests. However, high-stakes tests, which are used to transition between levels and continue higher education, direct the educational processes with exams (Vidal Rodeiro & Macinska, 2022). Mathematics tests determine the decisive role of these examinations. The attainment of success by students in the field of mathematics holds paramount importance, not solely for academic achievements but also in sculpting the trajectories of their future professional careers (Forsblom et al., 2022; Wainer et al., 2015). Although only multiple choice questions were used in these exams, the answers did not show the details the students's mathematical thinking process. Therefore, students' abilities and real success cannot be precisely measured (Burt, 1911; Burt, 1972; Davis et al., 1993; Gooddenough, 1926; Lowell, 1919; Porteus, 1915; Woodworth, 1910).

Multiple choice tests are extensively utilized because of their ability to objectively evaluate, which is regarded as their most important feature (Baker, 2001). However, there are other sorts of multiple choice items, with Traditional Multiple Choice [TMC] items being the most common. Furthermore, multiple choice items can take various forms, such as matched multiple choice, best-answer, broad-matched, true-false, multiple true-false, content-dependent item sets, and Discrete Option Multiple Choice [DOMC] items (Foster & Miller, 2009).

Despite the widespread use of TMC, it has some limitations, the most notable being cheating and test wiseness. These limitations negatively affect tests's psychometric properties when there are measures other than the information a test wants to measure. In TMC tests, the

respondent chooses the alternative he thinks is most likely correct rather than directly revealing his knowledge. This selection was based on a comparison of all options at the same time. As a result, another critical disadvantage of the TMC item-containing test type is that it allows for the extraction or creation of indications pointing to the correct answer by comparing alternative answer options (Holmes, 2002). In this case, the person taking the test can answer questions using clues from the TMC item. The ability to answer questions using such clues in TMC items is called test wiseness (Gibb, 1964). Thus, individuals can find the right solution and increase their test scores by comparing the options without knowing the question using all available answer options (Bailey et al., 2022; Rost & Sparfeldt, 2007). The mere use of unwanted cues cannot decipher TMC items in carefully constructed and evaluated tests if practical item writing guidelines are followed (Adediwura et al., 2021; Haladyna & Downing, 2004). Even an experienced item writer, however, needs considerable effort to develop a genuine TMC item. Many TMC items are generated under time constraints by writers who need more excellent test development experience (Fagley, 1987). Thanks very much for your comment. The sentence has been corrected and written again (Foster & Miller, 2009). Many of these items can be answered without training or appropriate knowledge due to the wisdom cues they frequently contain (Alnasraween et al., 2022; Lions et al., 2022; Rotthoff et al., 2008).

Differences among individuals with test wiseness skills allow candidates with high test wiseness to be rewarded while punishing individuals who do not possess these skills (Baker & Baker, 2022; Taylor & Gardner, 1999). In psychometric terms, situations such as test wiseness and cheating appear as Construct-Irrelevant Variance [CIV] elements because they affect the results of test scoring containing TMC items (Guo et al., 2022). Therefore, each point obtained represents both knowledge and skill on the subject and CIV elements (test wiseness, cheating, etc.). Increasing CIV jeopardizes the test's construct validity (Haladyna & Downing, 2004; Zhai et al., 2021). One with high test wiseness or cheating can acquire dramatically different scores from people with the same degree of knowledge or skill. Given the scores, grades, certificates, or admissions obtained in this way, people with skills unrelated to the structure may come to the fore. Various TMC item formats have been proposed to reduce anxiety and to create validity and its effect on TMC test scores (Rodriguez, 2005).

As a result, tests with TMC items frequently contain solution hints and are thus sensitive to test wiseness. Similar problems are likely to be encountered, as these suggestions involve simultaneously presenting the test-taker with a choice of answers. The DOMC tests, as posited by Foster and Miller (2009), represent a prospective avenue for mitigating apprehensions related to test wiseness and cheating, presenting a viable substitute to the conventional TMC tests. Analogous to TMC items, DOMC items consist of a stem, the correct answer, and alternatives. However, they diverge fundamentally in two key aspects. Primarily, in DOMC items, response options are presented sequentially rather than simultaneously, each accompanied by a true or false designation. Participants are tasked with individually deciding on each option as it is presented sequentially, with the order randomized and no opportunity for revisiting or altering previous responses, a procedural characteristic exclusively applicable prospectively (Foster & Miller, 2009; Kingston et al., 2012). Secondly, the DOMC test employs three distinct conditions to conclude the processing of an item. Termination occurs

without further presentation of response options when any of these conditions are met: (a) the correct solution is completed (rendering additional options unnecessary), (b) the correct answer is rejected, or (c) the distractor is accepted as correct. In conditions (b) or (c) apply, additional answer options are deemed redundant, as the item has already been considered incorrect. Consequently, the presentation of options concludes upon the correct or incorrect resolution of DOMC item, in contrast to multiple-choice items that provide all answer options regardless of correctness. Foster and Miller (2009) further advocate for incorporating an additional option with a probability of .50 after the initial scoring of the item. This approach aims to diminish participants' ability to confidently discern the accuracy of their responses, thus enhancing the evaluative challenge. There are few studies on this subject (Bolt et al., 2012, 2018, 2020; Eckerly, 2017, 2018; Foster and Miller, 2009; Funk et al., 2010; Gorney and Wollack, 2022; Kingston et al., 2012; Papenberg et al., 2017, 2019; Papenberg, 2018; Willing et al., 2015), and there were no studies on DOMC item use in determining secondary school mathematics achievement.

This study examined the usability of DOMC items in measuring mathematics achievement. In this sense, comparing the psychometric properties of the DOMC item format, which is believed to provide an alternative solution to some of the limitations experienced in applying TMC items, will make an essential contribution to the literature. This study on the use of DOMC items, recently introduced in the literature, will contribute to the field. When the literature is examined, it is observed that there is no study at the middle school level, and at the high school level, only one study (Kingston et al., 2012) has been conducted. Furthermore, limited investigations on DOMC items based on actual data on importance and test criteria indicate that this study will substantially contribute to the literature.

To achieve this aim, the research problem is: How are DOMC and TMC test features compared to item response and classical test theories?

The subproblems of the problem statement are as follows.

1. How are the item and test characteristics of the DOMC and TMC tests compared to the CTT? Is there a statistically significant difference between the item difficulty indices?
2. According to the IRT what are the item and test parameters of DOMC and TMC tests?
3. How do the DOMC and TMC tests affect candidates' success? Is there a statistically significant difference between the students' test achievement scores?

Method

This section provides information on the type of research, the study group, the data collection process, the data collection tool used, and the data analysis.

Research Model

This study examined student mathematics achievement variations using TMC and DOMC test items. Success scores were compared to CTT and IRT, revealing similarities and differences. In this respect, a descriptive quantitative research model was used. The descriptive quantitative research model is a research method aimed at describing the current state of a specific group, situation, or event as it is. This model is used to describe, analyze, and draw

various conclusions about the current state of the research subject through observations related to this situation (Fraenkel et al., 2012).

Participants

The study group consisted of 853 students in the 7th and 8th grades studying in five different secondary schools in Ankara. The study did not include one hundred twenty-eight data from these students with missing data problems. It was observed that all students with missing data issues had incomplete answers to the exam questions. Therefore, the studies of these students were not included in the research. The research groups are presented in Table 1.

Table 1.

Study Group of the Research

Gender/Grade level	7 th	8 th	Total
Female	261	130	391
Male	230	104	334
Total	491	234	725

Table 1 shows the 725 students in the study group. While 491 (68%) of the students were in the 7th grade, 234 (32%) were in the 8th grade. The study group included 391 (46%) female students and 334 (54%) male students.

Data Collection Process

Research data was collected during the second semester of the 2020-2021 academic year. The data were collected through the “Scorpion™” platform prepared by Caveon for online testing (Caveon, 2020). This platform allows the test content to reach the students online. The application, planned to be carried out in schools due to the covid-19 pandemic, was conducted online through this platform. Questions were created, and data were collected using the same TMC and DOMC items platform.

Before the data collection process, a video introducing the platform interface was prepared for the students. A ten-question trial exam was prepared for students to recognize the system and have information about the multiple choice item format with discrete options. Along with the introductory video, the trial exam has also been activated, so preparations before the final application have been completed.

A ten-question trial exam was prepared to ensure students were familiar with the system and the DOMC item format. Alongside an introductory video, the trial exam was activated, thus completing the preparatory phase before the final implementation. The link to the online test prepared for the final application was shared with the school administrations. Some students accessed the system and completed the exam during math class hours in certain schools, while others used the application outside of regular class hours. Upon entering the system, students encountered a screen that progressed step by step (Figure 1). During the data collection phase, in the event of technical issues, the researcher intervened in the system to enable students to resume the exam.

On the screen with exam questions, the exam duration and number of questions are on the upper left screen. Accordingly, students can see which question they are in from the

question numbers on the upper-left screen. Although there were 25 questions in total in the exam, 15 consisted of DOMC, and 10 were TMC items. The number of items in DOMC is greater than the number of items in TMC. This is because there is a requirement in DOMC to write multiple items measuring the same question for some of the items in TMC. In this respect, the number of DOMC and TMC items in the system is the same. Another critical issue in the system is the difference in the order of questions for each student at this stage. The system automatically and randomly assigns questions to each student. Accordingly, each student's order of true and false statements on the DOMC items and distractors on the TMC items varied. The system completely automated this process. After seeing all the questions, the students who completed the 25th question received an exam completion warning on the next screen. Students who completed the exam were directed to the screen to learn about the results. At this stage, students can see the scores obtained from the exam.

Figure 1.

Exam Screenshots

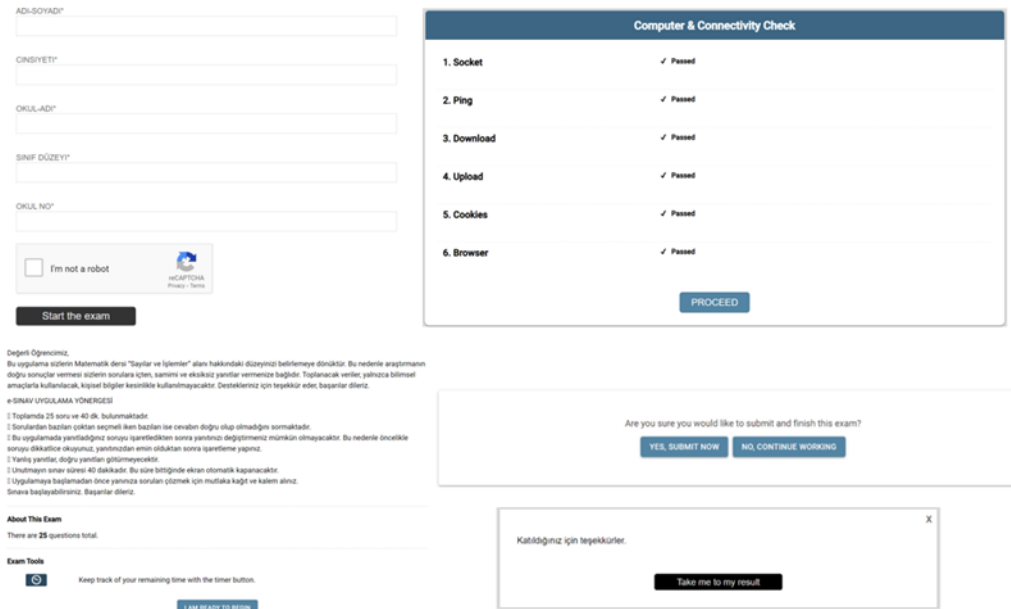

Students see their scores and exam times on the exam results screen. The data collection process was completed between 1-31 May 2021 for all schools participating in the research. The purpose of determining these dates was for all students to complete their lectures on the question items used. All students voluntarily participated in the study, and each student who completed the study was given a pencil.

Data Collection Tool

As a data collection tool in the research, within the scope of TÜBİTAK's 1003 Priority Areas Research and Development Projects Support Program, "Investigation of Some Variables Regarding the Level of School and Students Affecting Turkish, Mathematics and Science Course Success and Development of Policy Suggestions for 7th and 8th Grade Students." (Project No. 117K851), a standardized mathematics test developed within the project's scope, was used as a data collection tool.

In the research, it was decided to utilize 20 selected items from the final multiple-choice test comprising 25 questions developed for the 7th-grade level within the scope of the project. However, due to the prolonged closure of schools resulting from the global covid-19 pandemic, the possibility of face-to-face implementation was eliminated. Consequently, it was decided to prepare the application in a single session, incorporating both discrete multiple-choice and multiple-choice items. To achieve this, it was agreed to use 10 items from the 20-item form. DOMC items were created for each selected TMC item using the same stem. For some TMC items, 2 or more questions were written as DOMC items. Table 2 shows the item specifications of the chosen TMC items according to CTT.

When examining Table 2, it can be inferred that the test items exhibit medium difficulty and discrimination according to CTT. Discrimination indices range from .28 to .53, while item difficulties vary between .32 and .74, and the KR-20 reliability coefficient was found to be .76.

Table 2.

Data Collection Tool CTT Item Parameters

Items	Discrimination	Item difficulty	Item standard deviation
I16	.38	.74	.44
I17	.51	.60	.49
I18	.33	.52	.50
I19	.32	.38	.49
I20	.44	.42	.49
I21	.28	.32	.47
I22	.53	.52	.50
I23	.53	.59	.49
I24	.45	.65	.48
I25	.48	.53	.50

When the data were examined according to IRT, a three-parameter model was observed according to the model data fit. The obtained data are listed in Table 3.

Table 3.

Data Collection Tool IRT Item Parameters

Items	a parameter (Discrimination)	b parameter (Item difficulty)	c parameter (Guessing)
I16	1.512	-.828	.097
I17	1.962	-.328	.000
I18	.893	-.117	.001
I19	2.326	1.021	.230
I20	2.889	.671	.191
I21	3.395	1.215	.214
I22	4.359	.282	.210
I23	3.173	-.008	.167
I24	2.652	-.054	.268
I25	3.198	.338	.227

Table 3 shows that parameter a varied between .893 and 4.359, parameter b varied between -.828 and 1.215, and parameter c varied between 0 and .268. Theoretically, the discrimination parameter (a) can range from 0 to positive infinity. Higher values indicate that the item is more effective at discriminating between individuals with different latent trait levels. The difficulty parameter (b) typically ranges from negative to positive infinity. Negative values indicate easier items and positive values indicate more difficult items. The guessing parameter (c) has a range from 0 to 1. A higher value of c indicates a higher chance of guessing

correctly (Baker & Kim, 2004). When Table 3 is examined, the questions are of medium difficulty and discrimination, and guessing is low.

The item characteristic curves of the data according to the IRT are shown in Figure 2.

Figure 2.

Data Collection Tool Item Characteristic Curve

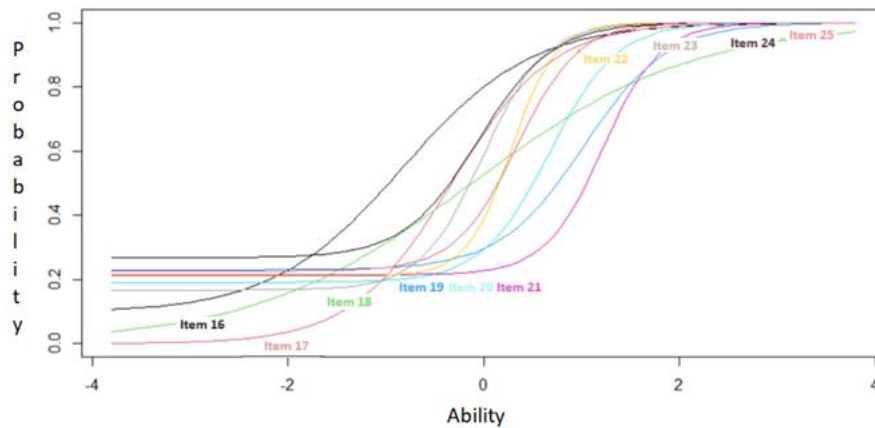

Figure 2 shows that the probability of solving the other items by chance is high, except for three items (items 16, 17 and 18), according to the item characteristic curves obtained according to the three PLM. In addition, it was found that the b parameters generally showed a distribution of approximately 0 (zero). Figure 1 shows that the slope parameters, indicators of the parameters, are also close to each other. The IRT reliability coefficient was calculated as .62.

Preparing Discrete Option Multiple Choice Items

While preparing discrete options for multiple choice items, a plan was made to prepare at least one question for each TMC item. Owing to the nature of the DOMC, more than one DOMC was ready for some TMC items. While preparing the items, multiple choice item roots were preserved, and similar questions were created by making changes only in numerical information. Table 4 shows the sequence of the items in the applied test as well as their distribution according to multiple choice item groups.

Table 4 shows that the first 15 items in the test are multiple choice with discrete choice, while the latter ten are regular multiple choice, for a total of 25 items. Four DOMC items (1, 2, 3, and 4) were written to provide the sixteenth question from the TMC items. Similarly, two DOMC (5, 6) items were written in response to the seventeenth TMC question. Two DOMC (8, 9) items were written in response to the nineteenth TMC question. One DOMC item was written for the other TMC items on the test. The main reason for writing more than one question for some TMC items was to ensure that the questions could be measured similarly while being converted to DOMC items.

Table 4.*Ranking and Distribution of the Items in the Test*

DOMC items	TMC items
I1	I16
I2	
I3	
I4	
I5	I17
I6	
I7	I18
I8	I19
I9	
I10	I20
I11	I21
I12	I22
I13	I23
I14	I24
I15	I25

When Table 4 is examined, for example, the 17th question prepared as a TMC question is given in Figure 3.

Figure 3.*TMC Question 17*

17. Some equations are given below.

$$(14.8) + (8.\triangle) = 20.8$$

$$(\square.5) + (5.3) = 10.5$$

Which of the following numbers should replace the symbols \triangle and \square in these equations?

- | | \triangle | \square |
|----|-------------|-----------|
| A) | 6 | 9 |
| B) | 5 | 7 |
| C) | 5 | 9 |
| D) | 6 | 7 |

For the TMC question 17 in Figure 3, questions 5 and 6 in the DOMC item type were given in Figure 4.

Figure 4.*DOMC Questions 5 and 6*

5. The number to replace the symbol \square in the equation $(12.6) + (6.\square) = 21.6$;

7

8

9

10

11

6. The number to replace the symbol \circ in the equation $(\circ.7) + (7.8) = 12.7$;

2

3

4

5

6

Analysis of Data

CTT and IRT were used to analyze the data to address research problems. Basic information about these theories is presented in detail on the theoretical basis of this study. Item and test statistics were calculated according to CTT. As a result, the item discrimination and difficulty of the items were determined, as were the average difficulty and discrimination of the test and Cronbach's alpha reliability coefficient. The model data fit for TMC items was analyzed using IRT, and item statistics (a parameter (discrimination), b parameter (item difficulty), c parameter (guessing), and test reliability coefficient) were provided. DOMC's model data fit was investigated using Testlet Response Theory [TRT], and the test's reliability coefficient was computed using item statistics.

Limitations and Assumptions

We need to acknowledge the readers for certain limitations and assumptions before discussing the results. Although the TMC item test paper-pencil form of the research and the DOMC test was planned to be applied face-to-face at school with a computer program, because of the covid-19 pandemic conditions, it could be used by the students online. The data collection for this study was facilitated through the utilization of the "Scorpion™" platform developed by Caveon. It is imperative to acknowledge that a limitation inherent in the study arises from the automated structuring of the order of questions and options by the program. With these limitations, we made some assumptions in our study. It was assumed that each candidate performing the test was adequately performed. Each candidate was assumed to use computer communication technologies (Information and Communications Technology or Technologies [ICT]). It is assumed that each candidate answered questions independently. All participants are assumed to know basic expressions such as "YES" – "NO."

Although Turkish expressions have been added to computer programs, the interface is still in English.

Ethical Permits of Research:

In this study, all the rules specified to be followed within the scope of "Higher Education Institutions Scientific Research and Publication Ethics Directive" were complied with. None of the actions specified under the heading "Actions Contrary to Scientific Research and Publication Ethics", which is the second part of the directive, have been taken.

Ethics Committee Permission Information:

Name of the committee that made the ethical evaluation = Hacettepe University Ethics Committee

Date of ethical review decision= 25.02.2020

Ethics assessment document issue number= 51944218-300/00000987002

Findings

This section analyzes the findings to answer the research questions, and the answers to each problem are presented. The findings obtained from the data analysis were converted into tables and graphics.

Research Problem 1: Comparison of Item and Test Properties of DOMC and TMC Tests with CTT, and Examination of the Statistical Significance Between Item Difficulty Indices

The discrimination and difficulty indices of the DOMC and TMC test items and test statistics were calculated based on the CTT to answer the first research question above. The calculated items and test statistics are presented in Tables 5 and 6.

In Table 5, item discrimination and item difficulty indices for the DOMC items are presented. When the findings were examined, the lowest discrimination item was 13 (.05), and the highest was 5 (.58). When item difficulties were discussed, it was found that the easiest item was 3 (.74), and the most difficult item was 10 (.12). The mean discrimination in the DOMC items was .39, and the mean item difficulty was .43. For 15 DOMC items, Cronbach's alpha reliability coefficient was .78.

Table 5.

Item and Test Statistics for Discrete Option Multiple Choice Items

Items	Discrimination (r_{jx})	Item difficulty (p_j)
1	.44	.58
2	.45	.57
3	.47	.74
4	.37	.49
5	.58	.57
6	.58	.57
7	.05	.24
8	.41	.33
9	.38	.33
10	.11	.12
11	.33	.15
12	.56	.34
13	.05	.22
14	.46	.59
15	.56	.55
<i>M</i>	.39	.43
Reliability (Cronbach alpha)	.78	

CTT presents the data obtained from TMC test items in Table 6. In Table 6, item discrimination and item difficulty indices for the TMC items are presented. When the findings were examined, the lowest discrimination item was 19 (.35), and the highest was 22 (.53). When the item difficulties were concerned, it was seen that the easiest item was 24 (.72), and the most difficult item was 21 (.32). The item difficulty was .53, while the mean item discrimination of multiple choice items was .44. Cronbach's alpha reliability coefficient for ten classic multiple choice items was .78.

Table 6.

Item and Test Statistics for Traditional Multiple Choice Items

Items	Discrimination (rjx)	Item Difficulty (pj)
16	.42	.64
17	.48	.62
18	.36	.54
19	.35	.39
20	.52	.33
21	.36	.32
22	.53	.54
23	.47	.65
24	.41	.72
25	.51	.52
<i>M</i>	.44	.53
Reliability (Cronbach alpha)	.78	

The z-ratio test examined whether a statistically significant difference existed between item difficulty indices. When the findings were examined, it was determined that the item difficulty indices calculated for both item types of all items except item 15 showed statistically significant differences. Accordingly, all item difficulties, except item 15, obtained from the TMC item type were found to be statistically significance, that is, easier than the DOMC. Table 7 lists the item difficulty indexes of the DOMC and TMC items.

Table 7.

Comparison of Item Difficulty and Discrimination of DOMA and TMC Items

Items TMC♦	Items DOMC♦♦	pj♦	pj♦♦	p	Cohen's h	rjx♦	rjx♦♦	z	Cohen's q
	1								
16	2	.64	.59	.03*	.09	.42	.43	-47	.01
	3								
	4								
17	5	.62	.57	.01*	.11	.48	.58	-5.34*	.14
	6								
18	7	.54	.24	0*	.61	.36	.05	16.21*	.32
	8								
19	9	.39	.33	0*	.14	.36	.39	-2.04*	-.05
	10								
20	10	.33	.12	0*	.51	.52	.11	21.29*	.46
	11								
21	11	.32	.15	0*	.40	.36	.33	1.35*	.03
	12								
22	12	.54	.34	0*	.41	.52	.56	-1.84	-.05
	13								
23	13	.65	.22	0*	.90	.47	.05	23.08*	.47
	14								
24	14	.72	.59	0*	.28	.41	.46	2.46*	.06
	15								
25	15	.52	.55	.23	-.06	.51	.56	-2.29*	-.06

♦TMC, ♦♦DOMC, *p<.05

Research Problem 2: Determination of Item and Test Parameters of DOMC and TMC Tests According to IRT

The item and test parameters of the DOMC and TMC test items were calculated based on IRT to answer the second research question above. The data from the DOMC, according to IRT, were analyzed using the TRT model. Preliminary to the analyses, the assessment involved comparisons with diverse fit criteria to adjudicate the most appropriate model. Based on the results garnered, the 2PL-TRT model emerged as the optimal choice, as evidenced by its minimal AIC, BIC, and DIC values coupled with the highest log-likelihood value. Further scrutiny included an examination of S-X2 statistics to evaluate the conformity of item model-data fit. Upon review, it was ascertained that all items demonstrated compliance within the

framework of the 2PL-TRT model. When the model data fit was examined, it was observed that the data were compatible with the two-parameter TRT model (2PL-TRT). The obtained data are presented in Table 8.

Table 8.

a and b Parameters according to TRT for DOMC Items

Items	a parameter (Discrimination)	b parameter (Item difficulty)
I1	.814	.287
I2	.848	.255
I3	1.190	1.063
I4	.588	-.001
I5	1.721	.436
I6	1.689	.426
I7	.047	-.696
I8	.807	-.633
I9	.756	-.621
I10	.131	-1.166
I11	.583	-1.188
I12	1.334	-.635
I13	.029	-.767
I14	.898	.311
I15	1.359	.275
<i>M</i>	.852	-.176
Reliability coefficient	.810	

When Table 8 was examined, it was seen that the highest parameter was in item 5 (1.721), and the lowest was in item 13 (.029). These results are consistent with the CTT results. As shown in Table 8, the lowest b parameter was Item 11 (-1.188), and Item 3 (1.063) was the highest. These results differed from the CTT results. This is because the items were grouped while calculating the TRT parameters of items 1-4, 5-6, and 8-9. However, in the CTT, the parameters were calculated, assuming that each item is independent. The TRT reliability coefficient for the DOMC item score was .81.

When the model data fit of the data obtained from the TMC test items according to IRT was examined, it was observed that the data were compatible with the three-parameter IRT model (3PLM), and the item parameters were calculated within this framework. The obtained data are presented in Table 9.

Table 9.

IRT Results on Traditional Multiple Choice Items

Items	a parameter (Discrimination)	b parameter (Item difficulty)	c parameter (Guessing)
I16	1.788	-.208	.193
I17	2.559	-.100	.199
I18	1.039	-.177	.004
I19	2.464	.958	.229
I20	4.865	.754	.119
I21	3.886	1.023	.173
I22	4.535	.272	.244
I23	2.934	-.071	.277
I24	1.825	-.799	.001
I25	4.927	.390	.257
<i>M</i>	3.082	.204	.169
Reliability coefficient	.610		

When Table 9 is examined, it is seen that the highest parameter is in item 25 (4.927), and the lowest parameter is in item 18 (1.039). In Table 9, it was found that the item with the highest b parameter was Item 21 (1.023), and the lowest was Item 24 (-.799). According to the results of the IRT, the easiest item was 24, while the most difficult item was 21. Upon scrutiny of the guessing parameter, it is observed that the minimum chance of guessing for an item is 24 (.001), whereas the maximum is 25 (.257). The computed KR-20 reliability coefficient for the TMC item scores is .61.

The item characteristic curves for TMC items are given in Figure 5. When Figure 5 was studied, it was noted that the likelihood of solving the other items by chance was relatively high, except for two items (items 18 and, 24), according to the item characteristic curves derived according to 3PLM. In addition, the b parameters generally exhibit a distribution of approximately 0 (zero). It can be asserted that the slope parameters, serving as indicators of the parameters of the items, exhibit a noteworthy proximity to one another.

Figure 5.

Item Characteristic Curve of TMC Items

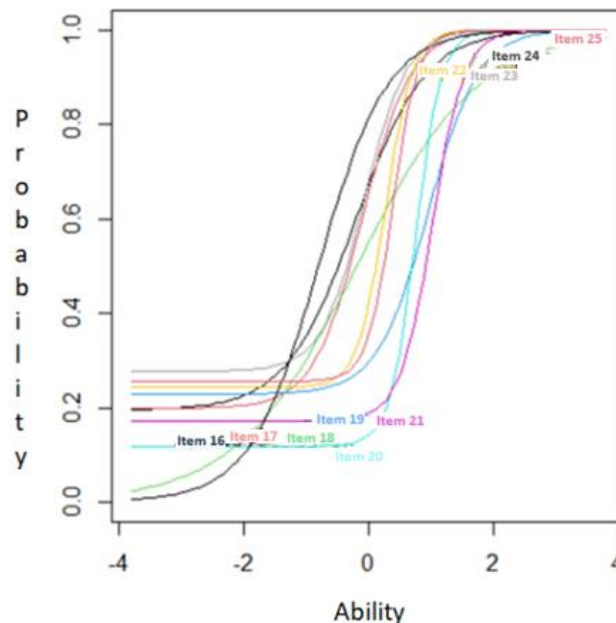

The critical finding obtained from the second subproblem of the study, when IRT calculated the scores obtained from the DOMC and TMC tests, gave close results compared to the raw scores obtained from CTT analyses. While there were significant differences between the two item types in the CTT analyses (Table 5, 6 and 7), particularly in high scores, the estimations of the student's ability levels in the IRT (Table 8 and 9) analyses were not affected by the question type, reducing the errors that may occur in extreme values.

Research Problem 3: Investigating the Effect of DOMC and TMC Tests on Candidates' Achievement and Determining Statistically Significant Differences between Students' Test Achievement Scores

To address this research problem, four graphs are examined. In the first graph, Figure 6 shows the raw scores obtained from the TMC test on the x-axis and the raw scores from the DOMC test on the y-axis.

Figure 6.
CTT Score Chart

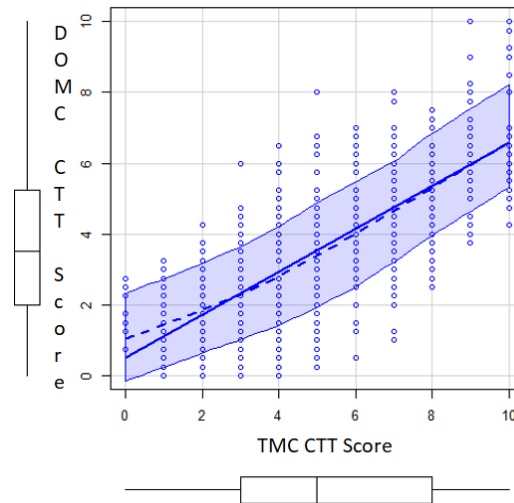

According to Figure 6, there is a linear relationship between the scores obtained from both test types. Observed scores are indicated by dashed blue lines in the middle of the figure, while blue lines in the middle indicate expected scores. The fact that these two lines almost overlap indicates that the expected and observed scores were very close. This shows a linear relationship between the TMC and DOMC scores. Most of the total scores are at the 95% lower and upper limits of the observed score line. Another remarkable situation in this graph is that the expected score linear line cuts the x-axis at an angle of less than 45° . This indicates that the total points students receive from the DOMC items are lower than those from the TMC items.

Figure 7 shows students' raw scores on the x-axis and student density on the y-axis. The red and blue lines represent the DOMC and TMC scores, respectively. Although the distributions of the scores obtained from both test types for low and medium scores were similar, student densities were higher in the DOMC-type items. This shows that students have more difficulties with the DOMC items. With a total score of 6.5, it was discovered that the number of students in the total scores of the two question types differed significantly. This shows that separation can be performed better in the DOMC test, especially with high scores.

Figure 8, on the x-axis, shows theta ability levels estimated according to the IRT obtained from the multiple choice test. On the y-axis are the theta ability levels estimated according to the IRT obtained from the discrete multiple choice test.

In Figure 9, on the x-axis, the students' IRT theta ability level values from the test are located, and on the y-axis, the student density.

In Figure 9, like Figure 7, the red line indicates DOMC theta ability levels, and the blue line indicates TMC theta ability levels. The distribution of scores obtained from the two test types was consistent. The estimations of students' ability levels with the IRT were not affected by the type of question as with the CTT.

Figure 7.
CTT Score Density

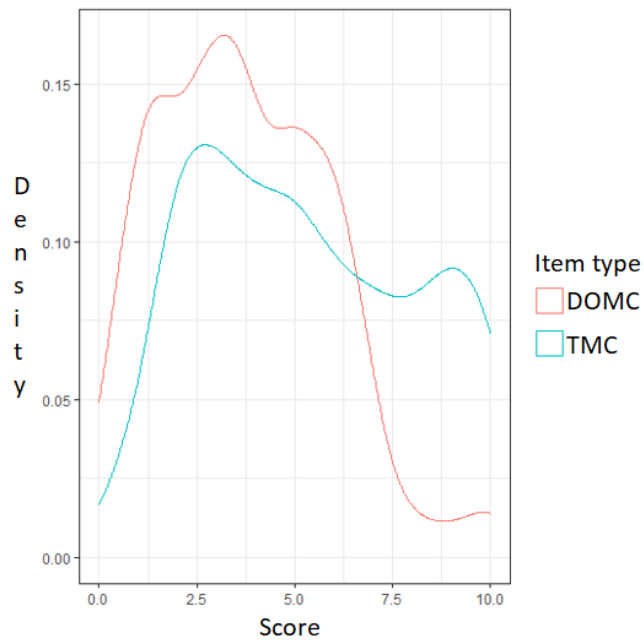

There was no statistically significant difference between IRT-calculated student theta levels ($t(724) = -.34, p = .735, d = -.01$). According to the CTT, the total scores obtained from TMC items were statistically higher than the total scores obtained from the DOMC items ($t(724) = 23.89, p < .001, d = .89$).

Figure 8.
IRT Score Graph

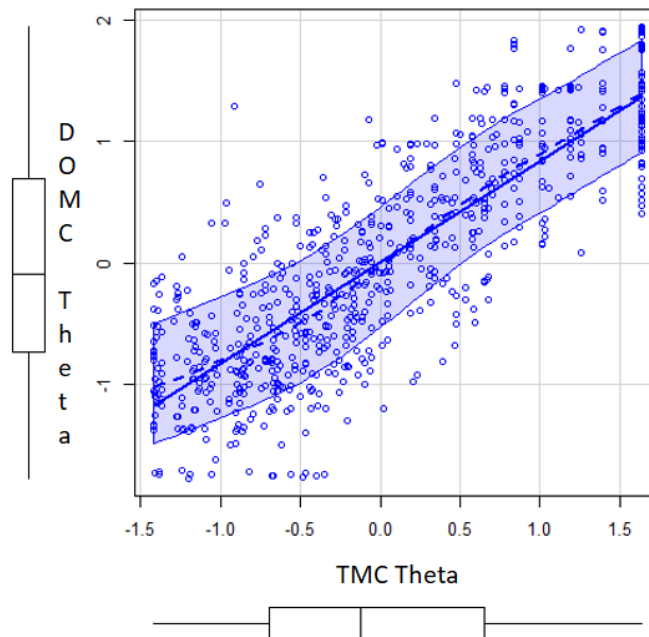
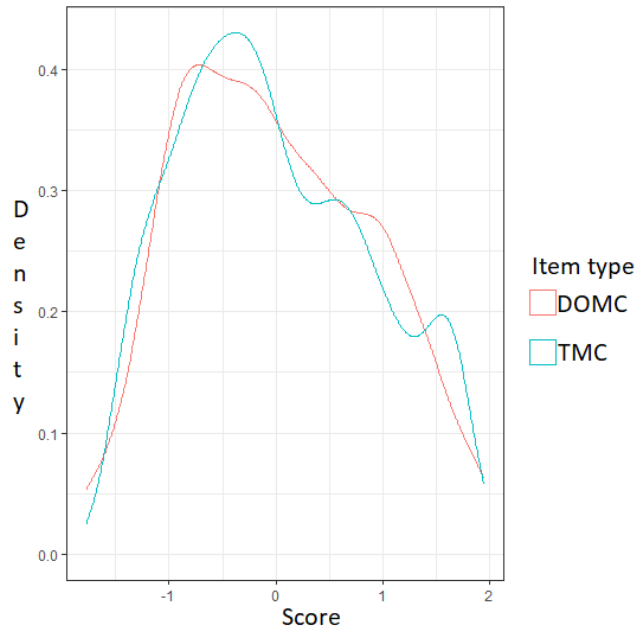

Figure 9.*IRT Theta Ability Level Density Graph*

Discussion and Conclusion

This study examined the variation in students' mathematics achievement according to TMC and DOMC items, and answers were sought from research questions created within this framework. In this section, the results obtained based on the analysis of the research and the findings are presented by comparing them with other studies in literature. In addition, various suggestions were made for practitioners and researchers based on the information gained during this research.

In this study, the mathematics achievement of 725 secondary school students was compared using the DOMC and TMC item formats. The results obtained because of this study are as follows.

1. When scrutinizing the questions employed in the research, ten items were prepared for TMC, and parallel to these items, fifteen items were developed for DOMC (refer to Table 4). Notably, in the case of certain TMC items, it became imperative to compose multiple items adhering to the DOMC format rather than a singular item (refer to Figures 3 and 4). This distinction assumes significance, indicating a variance in the nature of DOMC items and the format employed in question construction compared to TMC optional items.

2. A vital feature of DOMC items over TMC items is that the correct and distracting numbers can be changed in their options. This feature of DOMC items has been used in most studies (Eckerly et al., 2017; Papenberg et al., 2017, 2019). In this study, as in previous studies, in writing the options for DOMC items, one correct and three incorrect options are presented for five items, one correct and four incorrect options for three items, one correct and five incorrect options for four items, one correct and six incorrect options for one item, two correct and four incorrect options are presented for one item, and three correct and four incorrect options are presented for one item. Since each participant has different options, DOMC items

provide a significant advantage over TMC items. It has been observed that more than one correct option can be written for some questions depending on the nature of the items so that, unlike TMC items, questions that do not have only one correct answer for an item can be produced.

3. DOMC items can be applied on a computer-based basis. For this, the software is required to write DOMC item-type questions. When the literature is examined, it is stated that different software (Webassessor™, Unipark, Macro-supported PowerPoint) are used, but the software used in many studies is not specified. This study used the Caveon Scorpion, one of the few software programs suitable for the DOMC item format. The researcher obtained a one-year free usage permit for this study. The software used is ideal for the simultaneous use of DOMC and TMC item formats. However, it has been observed that there is no user interface for organizing the data in the reporting process. Another situation is that the DOMC item type is patented, and using these items in a test or exam requires a license. This creates the DOMC item type at a disadvantage. Although there is no charge for the use of the item type for research and trial purposes, the limited number of test distribution software that supports DOMC item types, and the fact that they charge a fee in this regard, can be expressed as another critical disadvantage.

4. Throughout the course of the research, several challenges were encountered concerning the implementation of the DOMC item type. Primarily, participants accustomed to the TMC item format faced potential difficulties, prompting the initiation of a preliminary trial application to mitigate the impact of this circumstance. Secondly, challenges arose in the domain of item construction, where comprehensive parallelism between DOMC items and certain questions amenable to the TMC format proved unattainable. Furthermore, it is noteworthy that DOMC, as a computer-based item type, introduces potential complexities, particularly when implemented through specific software. The foremost challenge in this study pertains to the sequential presentation of options and, notably, the placement of the correct answer. Given the potential impact on participants and the consequential influence on the psychometric quality of tests incorporating DOMC items, addressing this aspect is paramount.

The results obtained from the first problem of the study are like the results in the literature, and it was observed that students had more difficulty in DOMC item types than TMC items (Foster & Miller, 2009; Funk et al., 2010; Kingston et al., 2012; Samuel & Hinson, 2012; Willing, 2013). This situation may depend on factors such as the ordered presentation of options in multiple-choice items, the possibility of multiple correct answers for certain questions, and the use of different options for each participant in DOMC items. Upon examination of item difficulty index comparisons, disregarding the effect size signs, it is observed that these comparisons span a range from .06 to .90. Consequently, it is discerned that 4 comparisons exhibit a small impact, 5 manifest a medium impact, and 1 reflects a high impact.

In Table 7, the item discrimination indexes for TMC test range from .36 to .52, while for DOMC test, the range is observed to be between .05 and .58. Upon comparing the item discrimination indexes of analogous items, a statistically significant difference is evident across all items, except for two. Despite variations in the item discrimination index for items

measuring the same construct, there exists a general proximity between the item discrimination indexes of the two tests. Upon scrutinizing the effect sizes irrespective of their directional signs, the observed range spans from .01 to .47. Hence, it is inferred that 7 comparisons yield a small effect, while 3 exhibit a medium effect.

Based on the findings obtained, the test scores were reliable. The reliability coefficients of the scores obtained for both item types were the same. Accordingly, while Cronbach's alpha reliability coefficient for the DOMC first 15 items and the last 10 TMC items of the test scores was .78, Cronbach's alpha reliability coefficient was .87 for the scores obtained from all questions in the test. When we look at the literature, a similar result was obtained in the study of Willing (2013). Considering the ascertained results, one may posit that the test scores are reliable.

The results obtained from the first problem of the study are like the results in the literature, and it was observed that students had more difficulty in DOMC item types than TMC items (Foster & Miller, 2009; Funk et al., 2010; Kingston et al., 2012; Samuel & Hinson, 2012; Willing, 2013). This situation may depend on factors such as the ordered presentation of options in multiple-choice items, the possibility of multiple correct answers for certain questions, and the use of different options for each participant in DOMC items. Upon examination of item difficulty index comparisons, disregarding the effect size signs, it is observed that these comparisons span a range from .06 to .90. Consequently, it is discerned that 4 comparisons exhibit a small impact, 5 manifest a medium impact, and 1 reflects a high impact.

In Table 7, the item discrimination indexes for TMC test range from .36 to .52, while for DOMC test, the range is observed to be between .05 and .58. Upon comparing the item discrimination indexes of analogous items, a statistically significant difference is evident across all items, except for two. Despite variations in the item discrimination index for items measuring the same construct, there exists a general proximity between the item discrimination indexes of the two tests. Upon scrutinizing the effect sizes irrespective of their directional signs, the observed range spans from .01 to .47. Hence, it is inferred that 7 comparisons yield a small effect, while 3 exhibit a medium effect.

Based on the findings obtained, the test scores were reliable. The reliability coefficients of the scores obtained for both item types were the same. Accordingly, while Cronbach's alpha reliability coefficient for the DOMC first 15 items and the last 10 TMC items of the test scores was .78, Cronbach's alpha reliability coefficient was .87 for the scores obtained from all questions in the test. When we look at the literature, a similar result was obtained in the study of Willing (2013). Considering the ascertained results, one may posit that the test scores are reliable.

When the literature on the findings obtained from the second problem of the study is examined, it is seen that ITC-based studies on DOMC focus on models related to the ordering of answer choices (Bolt et al., 2012; Bolt et al., 2018; Bolt et al., 2020). There is no comparative study on test and item parameters. Therefore, it is thought that the information obtained will contribute to the literature.

When the visualizations obtained from the third problem of the study are analyzed in general, using IRT instead of CTT to estimate the parameters does not lead to significant changes in students' total scores for the DOMC items. Using IRT decreases the possibility of errors, especially at extreme values. Estimates made using the CTT approach revealed significant disparities between the two item types, particularly for high scores. This indicates that students have more difficulty with DOMC items, which are a different type of question, than with TMC items. In a similar study with undergraduate students, Funk et al. (2010) stated that they preferred to use the TMC item format because the DOMC items were new to students and made it difficult to predict. However, Samuel and Hinson (2012) found in their study that the DOMC item format supported students' self-efficacy and intrinsic value.

Similar results were obtained in many studies when the data obtained were evaluated in general. Kingston et al. (2012) stated in their research that DOMC and TMC items measured similar structures, and TMC items were consistently easier than DOMC items. This is demonstrated in the present study. In their experimental studies, Willing et al. (2015) stated that test wiseness clues are less useful in the DOMC item format than in TMC items; therefore, DOMC items are more difficult than TMC items. In the findings obtained in the first subproblem of the study, when TMC and DOMC item difficulties were compared, it was found that DOMC items were difficult in a statistically significant way.

Another important finding of this study was related to the TMC items used. It tested whether different question types applied to the DOMC item format based on some of the TMC items used in the study. In the second subproblem, the reliability results differed for both theories. When TMC and DOMC item forms were presented in equal numbers in the literature, the findings could not be compared to those of a different study.

To date, all studies in literature have been conducted at undergraduate and higher levels. The DOMC item types could be used at the secondary school level, and no problems were encountered during the application. Thus, the usability of tests containing DOMC items for different question types and educational levels was demonstrated.

Recommendations

The DOMC item format offers an essential alternative to the TMC item format, which has been used for nearly a century. However, there need to be more studies on issues such as question writing, software to be used, analysis methods, and the order of options (Bolt et al., 2018; Bolt et al., 2020). As a result, in this study, in contrast to the literature on DOMC items, various findings were revealed by making subject area, question contents, software used, grade level, and comparative analyses. The following suggestions are presented to practitioners and researchers for studies on this subject.

Recommendations for practitioners are as follows:

When studies related to DOMC items are examined, it is observed that applications are made in psychology, medicine, information technologies, the German language, and mathematics. Conducting studies on DOMC items in different fields and the content of the questions will increase our knowledge of the use of these items.

Another critical issue in the studies is that DOMC items must be delivered to the individuals who will take the test via computer-based software, so developing software on this subject is essential. A limited number of software is used in the studies carried out so far.

Considering that the groups in which DOMC items are applied are undergraduate, graduate, and adult groups in the current studies, it is evident that there is a need for studies at the K-12 level in which multiple choice tests are frequently used.

When comparing DOMC items with TMC items, preparing and applying DOMC parallel forms for different TMC items is essential. This will provide more insight into the nature of the DOMC item format.

Recommendations for researchers are as follows:

Considering the sample sizes studied on DOMC items, repeating studies in larger sample groups and testing the existing findings will positively contribute to the literature.

Considering that IRT-based studies on DOMC items are very limited in the literature, it is essential to conduct comparative studies to analyze the data obtained.

Another crucial future study area is to conduct studies to determine the effect of DOMC items on affective characteristics other than academic achievement and contribute to the limited literature on this subject.

One of the most significant criticisms of DOMC items is the order effect of options. The studies on the order effect of the options and the software to be developed based on these studies can popularize the use of DOMC items. However, studies on this subject could be more extensive in the literature.

In the context of DOMC applications, instead of scoring the entire item 0-1, the exploration of alternative scoring methodologies, such as nominal response or partial credit model for each option or combination can provide additional information.

References

- Adediwura, A. A., Ajayi, O. S., & Ibikunle, Y. A. (2021). Students and test variables as predictors of undergraduates' self-compassion. *Journal of Research & Method in Education, 11*(3), 42-48.
- Alnasraween, M. S., Alsmadi, M. S., Al-zboon, H. S., & Alkurshe, T. O. (2022). The level of universities students' test wiseness in Jordan during distance learning in light of some variables. *Education Research International, 1*-10.
- Anastasi, A. (1988). *Psychological testing* (6th ed.). Macmillan.
- Bailey, C. D., Briggs, J. W., & Irving, J. H. (2022). Test-wiseness and multiple-choice accounting questions: Implications for instructors. *Issues in Accounting Education, 37*(2), 1-14.
- Baker, D. L., & Baker, R. L. (2022). Knowledge and wisdom: High stakes testing and learning outcomes. In *Neuroethical policy design. Studies in brain and mind.* (pp.101-118). Springer.
- Baker, F. B. (2001). *The basics of item response theory* (ED458219). ERIC. <https://eric.ed.gov/?id=ED458219>
- Baker, F. B., & Kim, S. H. (Eds.). (2004). *Item response theory: Parameter estimation techniques* (2nd ed.). CRC.
- Bolt, D. M., Kim, N., Wollack, J., Pan, Y., Eckerly, C., & Sowles, J. (2020). A psychometric model for discrete-option multiple-choice items. *Applied Psychological Measurement, 44*(1), 33-48.
- Bolt, D. M., Lee, S., Wollack, J., Eckerly, C., & Sowles, J. (2018). Application of asymmetric IRT modeling to discrete-option Multiple-Choice Test items. *Frontiers in Psychology, 9*, 1-7.
- Bolt, D. M., Wollack, J. A., & Suh, Y. (2012). Application of a multidimensional nested logit model to multiple-choice test items. *Psychometrika, 77*, 263-287.
- Bowman, M. L. (1989). Testing individual differences in ancient China. *American Psychologist, 44*(3), 576-578.
- Burt, C. (1911). Experimental tests of higher mental processes and their relation to general intelligence. *Journal of Experimental Pedagogy, 1*, 93-112.
- Burt, C. (1972). Inheritance of general intelligence. *American Psychologist, 27*(3), 175-190.
- Caveon. (2020). Technology and internet-based services subscriber agreement. Retrieved October 10, 2023, from <https://caveon.com/caveon-privacy-policy-for-students-of-education-subscribers/>
- Cohen, R. J., & Swerdlik, M. E. (2018). *Psychological testing and assessment* (9th ed.). McGraw-Hill Education.
- Cronbach, L. (1990). *Essentials of psychological testing* (5th ed.). Harper & Row.
- Davis, N. T. (1996). Transition from objectivism to constructivism in science education. *International Journal of Science Education, 15*(6), 627-636.
- Eckerly, C., Smith, R. W., & Sowles, J. (2017, September 7). *Analysis of the discrete option multiple choice item: Examples from its certification*. Conference on Test Security, Madison, WI.
- Eckerly, C., Smith, R., & Sowles, J. (2018). Fairness concerns of discrete option multiple-choice items. *Practical Assessment, Research & Evaluation, 23*(16), 1-10.
- Erdoğan, İ. (2003). *Çağdaş eğitim sistemleri* [Contemporary education systems] (5th ed.). Sistem.
- Fagley, N. S. (1987). Positional response bias in multiple-choice tests of learning: Its relation to test wiseness and guessing strategy. *Journal of Educational Psychology, 79*(1), 95-97.
- Forsblom, L., Pekrun, R., Loderer, K., & Peixoto, F. (2022). Cognitive appraisals, achievement emotions, and students' math achievement: A longitudinal analysis. *Journal of Educational Psychology, 114*(2), 346-367.
- Foster, D. F., & Miller, H. L. (2009). A new format for multiple-choice testing: Discrete option multiple-choice. Results from early studies. *Psychology Science Quarterly, 51*, 355-369.

- Fraenkel, J. R., Wallen, N. E., & Hyun, H. H. (2012). *How to design and evaluate research in education* (8th ed.). McGraw Hill.
- Funk, R., Hooper, T., Hadlock, E., Whicker, J., Estes, D., & Miller, H. L. (2010). *Differential effects of the discrete-option multiple-choice format on test takers' assessment preparation and scores*. Poster presented at the Mary Lou Fulton Undergraduate Research Conference, Provo, UT.
- Gibb, B. G. (1964). *Testwiseness as a secondary cue response* (Publication No. 6407643) [Doctoral dissertation, Stanford University]. ProQuest Thesis Center.
- Goodenough, F. L. (1926). *Measurement of intelligence by drawings*. World Book Company.
- Gorney, K., & Wollack, J. A. (2022). Does item format affect test security? *Practical Assessment, Research, & Evaluation*, 27(15), 1-13.
- Guo, H., Rios, J. A., Ling, G., Wang, Z., Gu, L., Yang, Z., & Liu, L. O. (2022). Influence of selected-response format variants on test characteristics and test-taking effort: An empirical study. *ETS Research Report Series*, 2022(1), 1–20.
- Güler, N. (2011). *Eğitimde ölçme ve değerlendirme* [Measurement and evaluation in education]. Pegem.
- Haladyna, T. M., & Downing, S. M. (2004). Construct-irrelevant variance in high-stakes testing. *Educational Measurement: Issues and Practice*, 23(1), 17–27.
- Holmes, P. (2002). *Multiple evaluation versus multiple choice as testing paradigm* [Doctoral dissertation, Twente University]. University of Twente Research Information.
- Janda, L. H. (1997). *Psychological testing: Theory and applications* (1st ed.). Pearson.
- Kingston, N. M., Tiemann, G. C., Miller, H. L., & Foster, D. (2012). An analysis of the discrete-option multiple-choice item type. *Psychological Test and Assessment Modeling*, 54(1), 3–19.
- Kumandaş, H., & Kutlu, Ö. (2010). High stakes testing: Does secondary education examination involve any risks? *Procedia- Social and Behavioral Sciences*, 9, 758-764.
- Lions, S., Monsalve, C., Dartnell, P., Blanco, M. P., Ortega, G., & Lemarié, J. (2022). Does the response options placement provide clues to the correct answers in multiple-choice tests? A systematic review. *Applied Measurement in Education*, 35(2), 133–152.
- Lowell, F. (1919). A preliminary report of some group tests of general intelligence. *Journal of Educational Psychology*, 10(7), 323–344.
- Papenberg, M. (2018). *On how test wiseness and acceptance reluctance influence the validity of sequential knowledge tests* [Unpublished doctoral dissertation]. Heinrich-Heine-University Düsseldorf.
- Papenberg, M., Diedenhofen, B., & Musch, J. (2019). Experimental validation of sequential multiple-choice tests. *Journal of Experimental Education*, 89(2), 402–421.
- Papenberg, M., Willing, S., & Musch, J. (2017). Sequentially presented response options prevent the use of testwiseness cues in multiple-choice testing. *Psychological Test and Assessment Modeling*, 59(2), 245-266.
- Popham, W. J. (1999). *Modern educational measurement: Practical guidelines for educational leaders* (3rd ed.). Pearson.
- Porteus, S. D. (1915). Mental tests for the feebleminded: A new series. *Journal of Psycho-Asthenics*, 19, 200-213.
- Rodriguez, M. C. (2005). Three options are optimal for multiple-choice items: A meta-analysis of 80 years of research. *Educational Measurement Issues and Practice*. 24(2), 3–13.
- Rost, D. H., & Sparfeldt, J. R. (2007). Reading comprehension without reading? On the construct validity of multiple-choice reading comprehension test items. *Zeitschrift für Pädagogische Psychologie*, 21, 305-314.

- Rotthoff, T., Fahron, U., Baehring, T., & Scherbaum, W. A. (2008). The quality of CME questions as a component part of continuing medical education--an empirical study. *Zeitschrift für Ärztliche Fortbildung und Qualität im Gesundheitswesen*, 101, 667-674.
- Samuel, J., & Hinson, J. (2012, March 5). *Promoting motivation through technology-based testing*. In P. Resta (Ed.), *Proceedings of the Society for Information Technology & Teacher Education International Conference Chesapeake, VA: AACE*.
- Taylor, C., & Gardner, P. L. (1999). An alternative method of answering and scoring multiple-choice tests. *Research in Science Education*, 29, 353-363.
- Vidal Rodeiro, C., & Macinska, S. (2022). Equal opportunity or unfair advantage? The impact of test accommodations on performance in high-stakes assessments. *Assessment in Education: Principles, Policy & Practice*, 29(4), 462-481.
- Wainer, H., Dorans, N. J., Eignor, D. R., Flaugher, R. L., Green, B. F., Mislevy, R. J., Steinberg, L., & Thissen, D. (2015). *Computerized adaptive testing a primer* (2nd ed.). Routledge.
- Willing, S. (2013). *Discrete-option multiple-choice: Evaluating the psychometric properties of a new method of knowledge assessment* [Unpublished doctoral dissertation]. Heinrich-Heine-University Düsseldorf.
- Willing, S., Ostapczuk, M., & Musch, J. (2015). Do sequentially presented answer options prevent the use of test wiseness cues on continuing medical education tests? *Advances in Health Sciences Education: Theory and Practice*, 20(1), 247-263.
- Woodworth, R. S. (1910). Race differences in mental traits. *Science*, 31(788), 171-86.
- Zhai, X., Haudek, K. C., Wilson, C., & Stuhlsatz, M. (2021). A framework of construct-irrelevant variance for contextualized constructed response assessment. *Frontiers in Education*, 6, 1-13.

BIOGRAPHICAL NOTES

Contribution Rate of Researchers

Author 1: 50%

Author 2: 50%

Conflict Statement

There is no conflict of interest in the research.

Matematik Başarısı için Bir Ölçme Aracı Olarak Ayrık Seçenekli Çoktan Seçmeli Maddeler



Özet

Bu çalışmanın amacı Ayrık Seçenekli Çoktan Seçmeli [ASÇS] maddelerin uygulanabilirliğinin incelenmesidir. Bu amaca ulaşmak için ortaokul matematik dersi kapsamında toplam 25 sorudan oluşan bir test kullanılmıştır. Testi oluşturan maddelerden 10 tanesi çoktan seçmeli maddelerden oluşurken 15 tanesi ASÇS maddelerden oluşmaktadır. Araştırmanın verileri 2020-2021 eğitim-öğretim yılı 2. döneminde ortaokulda öğrenim görmekte olan 725 öğrenciden elde edilmiştir. Öğrencilerin 491 (%68) tanesi 7. sınıf düzeyinde iken 234 (%32) tanesi 8. sınıf düzeyindedir. Çalışma grubundaki öğrencilerin 391 (%54)'ini kız öğrenciler, 334 (%46)'sını ise erkek öğrenciler oluşturmaktadır. Araştırmadan elde edilen bulgular incelendiğinde Klasik Test Kuramı [KTK] ile yapılan analizlerde özellikle yüksek puanlarda iki madde türü arasında büyük farklılıklar gözlenirken, Madde Tepki Kuramı [MTK] ile yapılan analizlerde öğrencilerin yetenek düzeylerinin kestirimlerinin soru tipinden etkilenmediği böylece uç değerlerde oluşabilecek hataları düşürdüğü gözlenmiştir. ASÇS maddelerinin, KTK yerine MTK ile parametre kestirimlerinin gerçekleştirilmesiyle öğrencilerin toplam puanlarında çok büyük bir farklılığa yol açmayacağı söylenebilir. Çalışmada kullanılan bazı Geleneksel Çoktan Seçmeli [GÇS] maddeler, ASÇS madde formatında iki veya daha fazla soru olacak şekilde seçilmiş ve farklı soru türlerinin ASÇS madde formatında uygulanabilirliği test edilmiştir.

Anahtar Kelimeler: Klasik test kuramı, ayrık seçenekli çoktan seçmeli, madde tepki kuramı, matematik başarısı, geleneksel çoktan seçmeli.

Giriş

Okul yıllarımıza kadar fark etmesek de hayatımızın her alanında karşımıza çıkacak olan ölçme ve değerlendirme süreçleri yaşamımızın doğal bir parçası haline gelmiştir. Günlük hayatımızın olağan akışında sıklıkla ölçme-değerlendirmeler yapar ve kararlar alırız. Örneğin seçeceğimiz ayakkabı için ayak ölçümüze uygun olan ayakkabıyı inceleriz, bir futbol sahası yapmamız için en ve boy ölçülerine ihtiyaç duyarız, trafik düzenini sağlamak için kullandığımız lambalar için zaman ölçülerinden yararlanarak verimli bir model geliştirmeye çalışırız. Bunlar gibi birçok farklı alanda ölçme-değerlendirme işleminden faydalanırız. Farklı alanlarda yapılan tüm bu ölçmeler kendine özgü bir ölçme aracına ve ölçme birimine sahiptir. Bu araç ve birimler bizlere ölçmelerimizi doğrudan, dolaylı ya da türetilmiş şekilde yapmaya olanak tanır. Doğrudan ölçmelerde ölçülmek istenilen özellik doğrudan gözlenebilirken, dolaylı ölçmelerde ölçülmek istenen özelliğin ölçülüp gözlenmesi bir başka özelliğin yardımıyla ölçülebilir. Türetilmiş ölçmelerde ise ölçülmek istenilen özellik kendisinden farklı iki ya da daha fazla özelliğin arasındaki matematiksel bir bağlantıyla ölçülebilir (Güler, 2011).

Ölçme ve değerlendirmenin günlük hayattaki etkisinin fark edildiği en önemli süreç öğrencilik yıllarıdır. Bunun en önemli nedeni ders başarılarının değerlendirilmesinde öğrencilere uygulanan başarı testlerinden elde edilen ölçümlerin kullanılmasıdır. Bununla birlikte kademeler arası geçiş ve üst öğrenime devam etmek için kullanılan yüksek risk içeren (high stakes tests) (Kumandaş ve Kutlu, 2010) ulusal standart testlerde düşünüldüğünde

ölçme ve değerlendirme süreçleri eğitimin bütün paydaşlarının önemli bir gündemi haline gelmektedir. Geliştirilen başarı testlerinin tamamında amaç psikolojik yapıların ölçülmesi olduğundan tarihsel süreç içerisinde gelişimleri paralellik göstermiştir.

Testler genel anlamdan bireyleri tanımak ve bilgi sahibi olmak için kullanılırken (Cronbach, 1990), psikolojik testler bireye ait zeka, yetenek, beceri, tutum vb. davranışların standart ölçümlerini ifade etmektedir (Anastasi, 1988). Psikolojik test ve test programlarının kullanımı kaynaklarda MÖ 2200 yıllarındaki antik Çin'e kadar dayandırılır (Cohen & Swerdlik, 2018; Janda, 1997; Popham, 1999). Uygulanan testler subay ve sivil memur seçimleri için kullanılan ve imparatorluk sınavları ismi verilen bir takım zorlu süreçleri içermekteydi. Testlerin uygulama yöntemleri açısından günümüzle benzerlikleri dikkat çekicidir. Bu durumun en basit açıklaması ise Çinliler tarafından geliştirilen sınav uygulama prosedürleri ve esas alınan psikometrik nitelikler Fransa (1791), Hindistan (1833) ve Amerika Birleşik Devletleri (1883) gibi ülkelerde benzer uygulamalar için temel teşkil etmiştir. Sınav uygulamalarında ise aday isimlerinin gizli tutulması, sınav salonlarının her bir aday için benzer koşullarda, özel sınav binalarında bulunan küçük odacıklarda sınavların yapılması, sınav kağıtlarını puanlarken en az iki bağımsız değerlendiricinin olması gibi günümüzdeki uygulamalara benzer süreçler geliştirildiği görülmektedir (Bowman, 1989; Cohen & Swerdlik, 2018).

1900'lü yılların başlarında test süreçleriyle ilgili hem istatistiksel çalışmalar hem de farklı becerilerle ilgili performansları ölçebilmek için farklı türlerde testlerin ortaya çıktığı görülmektedir (Burt, 1911; Burt, 1972; Goodenough, 1926; Lowell, 1919; Porteus, 1915; Woodworth, 1910). Bu gelişmelerle birlikte testlerin bireysel olarak değil toplu olarak uygulanmaya başlamış, grup testleriyle birlikte çoktan seçmeli testlerin kullanımı yaygınlaşmıştır. Bu konuda ilk defa ABD'de 1901 yılında üniversiteye giriş sınavında uygulaması başlatılmış devam eden süreçte ise bu konuda bir komite kurularak 1926 yılında "Scholastic Aptitude Test [SAT]" isimli bir yetenek testi geliştirilerek kullanılmaya başlanmıştır. Testin kullanımı giderek yaygınlaşmış ve sadece üniversiteye girişte değil bursların verilmesinde de etkili bir rol oynamaya başlamıştır (Wainer vd., 2015). Günümüzde Amerika'daki pek çok üniversite öğrenci kabulünde ortaöğretim notları, SAT, Graduate Record Examination [GRE] ve Graduate Management Admission Test [GMAT] gibi yetenek ve başarı testlerinden alınan puanları kullanmaktadır. Bu süreçte tavsiye mektupları da göz önünde bulundurulurken, bu belgelere ilave olarak bazı üniversiteler ayrı bir seçme sınavı da uygulayabilmektedir (Erdoğan, 2003).

Çoktan seçmeli testlerin bu kadar geniş bir kullanım alanına sahip olmasının en temel nedeni objektif olarak değerlendirilmeleridir (Baker, 2001). Çoktan seçmeli maddelerin çeşitli türleri olmasına rağmen, Geleneksel Çoktan Seçmeli [GÇS] maddeler sıklıkla kullanılır. GÇS maddelerin yaygın olarak kullanılmasına rağmen bazı sınırlılıklarının olduğu gözlemlenmiştir. En bariz olanlar test bilgeliği ve kopyadır. Test bilgeliği becerisine sahip bireyler arasındaki farklılıklar, test bilgeliği yüksek olan adayları ödüllendirirken, bu beceriye sahip olmayanları cezalandırmaktadır (Baker & Baker, 2022; Taylor & Gardner, 1999). Psikometrik açıdan test bilgeliği ve kopya çekme gibi durumlar, GÇS maddeleri içeren test değerlendirmelerinin sonuçlarını etkiledikleri için yapıyla ilgisiz varyans öğeleri olarak karşımıza çıkmaktadır (Guo

vd., 2022). Bu nedenle, elde edilen her puan, ilgili bilgi, beceri ve ölçülmemiş varyansın bileşenlerini (test bilgeliği, kopya vb.) temsil eder. Yapıyla ilgisiz varyansın arttırılması, testin yapı geçerliliğini tehdit eder (Haladyna & Downing, 2004; Zhai vd., 2021). Aynı bilgi ve beceri düzeyine sahip iki kişiden, test bilgeliği yüksek olan veya kopya çeken aday, önemli ölçüde farklı puanlar alabilir. Bu şekilde elde edilen puanlar, dereceler, sertifikalar veya kabuller göz önüne alındığında, ölçülen yapıyla ilgisi olmayan becerilere sahip kişiler ön plana çıkabilir. Bu sınırlamalar, bir testin ölçmek istediği bilgilerden başka ölçümler olduğunda testin psikometrik özelliklerini olumsuz etkiler.

Ayrıca GÇS öğeleriyle yapılan testler genellikle çözüme yönelik ipuçları içerir ve bu nedenle test bilgeliği stratejilerine karşı savunmasızdır. Bu noktada literatürde son yıllarda yer bulmaya başlayan “Ayrık Seçenekli Çoktan Seçmeli [ASÇS]” madde içeren testler önemli bir alternatif olarak karşımıza çıkmaktadır. Bu araştırma, ASÇS madde içeren testleri kullanarak, GÇS madde içeren testlere yöneltilen test bilgeliği ve kopya eleştirileri için çözümler sunmaktadır. Literatür incelendiğinde ASÇS maddelerle ilgili çalışmaların sınırlı sayıda olduğu görülmektedir (Bolt vd., 2012, 2018, 2020; Eckerly vd., 2017, 2018; Foster & Miller, 2009; Funk vd., 2010; Kingston vd., 2012; Papenberg, 2018; Papenberg vd., 2019; Willing vd., 2015). Ayrıca ortaokul matematik başarısını belirlemede ASÇS madde kullanımına ilişkin herhangi bir çalışmada bulunmamaktadır. Ek olarak, ASÇS maddelerinin önemi ve test parametreleri hakkındaki gerçek verilerden elde edilen sınırlı çalışmalar, bu çalışmanın literatüre önemli ölçüde katkı sağlayacağını göstermektedir.

Bu nedenlerle bu çalışmada ASÇS maddelerin matematik başarısını ölçmede kullanılabilirliğini incelenmiştir. Bu amaca ulaşmak için nicel araştırma türlerinden betimsel model kullanılmıştır (Fraenkel vd., 2012).

Araştırmanın temel problemi şu şekildedir: ASÇS ve GÇS test özellikleri madde yanıt ve klasik test teorilerine göre nasıldır?

Problem cümlesinin alt problemleri aşağıda verilmiştir:

1. ASÇS ve GÇS testlerin madde ve test özellikleri Klasik Test Kuramına [KTK] göre nasıldır? Madde güçlük indeksleri arasında istatistiksel olarak anlamlı bir fark var mıdır?
2. ASÇS ve GÇS testlerin madde ve test parametreleri Madde Tepki Kuramına [MTK] göre nasıldır?
3. ASÇS ve GÇS testlerin adayların başarısına olan etkisi nasıldır? Öğrencilerin testlerden aldıkları başarı puanları arasında istatistiksel olarak anlamlı bir farklılık var mıdır?

Yöntem

Bu çalışmada, GÇS ve ASÇS test maddeleri kullanılarak öğrencilerin matematik başarısındaki değişimler incelenmiştir. Başarı puanları KTK ve MTK ile karşılaştırılarak benzerlikler ve farklılıklar ortaya çıkarılmıştır. Bu bağlamda, betimsel bir nicel araştırma modeli kullanılmıştır (Fraenkel vd., 2012).

Araştırmanın Etik İzinleri:

Bu çalışmada "Yükseköğretim Kurumları Bilimsel Araştırma ve Yayın Etiği Yönergesi" kapsamında uyulması gerektiği belirtilen tüm kurallara uyulmuştur. Yönergenin ikinci bölümü olan "Bilimsel Araştırma ve Yayın Etiğine Aykırı Eylemler" başlığı altında belirtilen eylemlerin hiçbiri gerçekleştirilmemiştir.

Etik Kurul İzin Bilgileri:

Etik değerlendirmeyi yapan kurulun adı = Hacettepe Üniversitesi Etik Komisyonu

Etik Kurul Etik inceleme karar tarihi= 25.02.2020

Etik değerlendirme belgesi konu numarası= 51944218-300/00000987002

Bulgular

Araştırma sonucunda elde edilen bulgular genel olarak değerlendirildiğinde, parametre kestirimi KTK yerine MTK ile yapıldığında ASÇS maddelerinin öğrencilerin toplam puanlarında anlamlı bir farklılığa neden olmayacağı söylenebilir. MTK kullanımının özellikle uç değerlerde oluşabilecek hataları azalttığı görülmüştür. KTK yöntemi ile yapılan tahminlerde iki madde türü arasında özellikle yüksek puanlarda anlamlı farklar olduğu görülmüştür. Bu durum öğrencilerin farklı bir soru türü olan ASÇS maddelerde, GÇS maddelere göre daha fazla zorlandıklarını göstermektedir. Lisans öğrencileriyle yapılan benzer bir çalışmada Funk vd. (2010), ASÇS maddelerinin öğrenciler için yeni olması ve tahmin etmeyi zorlaştırması nedeniyle GÇS madde formatını kullanmayı tercih ettiklerini belirtmişlerdir. Ancak Samuel ve Hinson (2012) çalışmalarında ASÇS madde formatının öğrencilerin öz yeterliklerini ve içsel değerlerini desteklediğini bulmuşlardır.

Tartışma ve Sonuç

Çalışmanın sonuçları literatürdeki birçok çalışma ile benzer sonuçların elde edildiği görülmüştür. Kingston vd. (2012) araştırmalarında ASÇS ve GÇS maddelerinin benzer yapıları ölçtüğünü ve TMK maddelerinin ASÇS maddelerine göre sürekli olarak daha kolay olduğunu belirtmişlerdir. Bu çalışmada da benzer bir sonuç bulgulanmıştır. Deneysel çalışmalarında, Willing vd. (2015), test bilgeliğin ipuçlarının ASÇS madde formatında GÇS maddelerine göre daha az yararlı olduğunu, bu nedenle ASÇS maddelerinin GÇS maddelerine göre daha zor olduğunu belirtmiştir. Araştırmanın birinci alt probleminde elde edilen bulgularda, GÇS ve ASÇS madde güçlükleri karşılaştırıldığında, ASÇS maddelerinin istatistiksel olarak anlamlı bir şekilde zor olduğu bulunmuştur.

Araştırmanın bir diğer önemli bulgusu da kullanılan GÇS maddeleri ile ilgilidir. Çalışmada kullanılan bazı GÇS maddeleri, ASÇS madde formatında iki veya daha fazla soru olarak seçilmiş ve farklı soru türlerinin ASÇS madde formatında uygulanabilirliği test edilmiştir. Araştırmanın ikinci alt probleminde ise her iki teoride güvenilirlik sonuçları farklılık göstermektedir. Literatürde GÇS ve ASÇS madde formları eşit sayıda sunulduğunda bulgular farklı bir çalışma ile karşılaştırılamamıştır.

Şimdiye kadar literatürde yer alan çalışmaların tamamı lisans ve üzeri düzeyde uygulanmıştır. ASÇS madde türleri ortaokul düzeyinde kullanılabilmektedir ve uygulama

sırasında herhangi bir sorunla karşılaşılmamıştır. Böylece ASÇS maddeleri içeren testlerin farklı soru türlerinde ve eğitim düzeylerinde kullanılabilirliği ortaya konmuştur.

Araştırmada, öğrencilerin matematik başarılarının GÇS ve ASÇS test maddelerine göre değişimi incelenmiş ve bu çerçevede oluşturulan araştırma sorularına yanıt aranmıştır. Araştırmanın analizlerine ve elde edilen bulgulara dayalı olarak ulaşılan sonuçlar alan yazındaki diğer çalışmalarla karşılaştırılmış ve araştırma süresince kazanılan bilgiler ışığında, uygulayıcılara ve araştırmacılara yönelik çeşitli öneriler getirilmiştir. Bu çalışmada ortaokul düzeyinde 725 öğrencinin matematik başarıları ASÇS ve GÇS madde formatları ile karşılaştırılmıştır. Çalışma sonucunda elde edilen sonuçlar:

1. Araştırmada kullanılan sorular açısından incelendiğinde GÇS seçmeli on madde için paralel on beş madde oluşturulmuştur. Literatürden farklı olarak GÇS maddelerden bazıları için birden fazla ASÇS madde yazılması gerekmiştir. Bu durum ASÇS maddelerin doğası ve soru yazım formatının GÇS maddelerden farklı olduğunu göstermesi açısından önemlidir.

2. ASÇS maddelerin GÇS maddelerden güçlü bir özelliği seçeneklerinde doğru ve çeldirici sayılarının değiştirilebilmesidir. Literatürdeki çalışmalarında birçoğunda kullanılan maddelerde ASÇS maddelerin bu özelliği kullanılmıştır (Eckerly vd., 2017; Papenberg vd., 2019; Papenberg vd., 2017). Bu çalışmada literatürdeki çalışmalara benzer şekilde ASÇS maddelerin seçeneklerinin yazılmasında beş madde için bir doğru üç yanlış seçenek, üç madde için bir doğru dört yanlış, dört madde için bir doğru beş yanlış, bir madde için bir doğru altı yanlış, bir madde için iki doğru dört yanlış, bir madde için üç doğru dört yanlış seçenek sunulmuştur. Her bir katılımcıya farklı sayıda seçenek gösterildiği düşünüldüğünde GÇS maddelere göre ASÇS maddelerin önemli bir avantaj sağladığı görülmektedir. Maddelerin doğasına bağlı olarak bazı sorular için birden fazla doğru seçeneğin yazılabildiği böylece GÇS maddelerden farklı olarak bir madde için sadece bir doğru cevabın olmadığı soruların üretilmediği görülmüştür.

3. ASÇS maddeler bilgisayar tabanlı olarak uygulanabilmektedir. Bunun için ASÇS madde türü soruların yazılabileceği bir yazılıma ihtiyaç vardır. Literatür incelendiğinde farklı yazılımlar (Webassessor™, Unipark, Makro destekli power point) kullanıldığı ifade edilmiş ancak birçok çalışmada kullanılan yazılım belirtilmemiştir. Bu çalışmada ASÇS madde formatına uygun az sayıda yazılımlardan biri olan Caveon Scorpion kullanılmıştır. Araştırmacı tarafından bu çalışma için bir yıllık ücretsiz bir kullanım izni alınmıştır. Kullanılan yazılım ASÇS madde formatı ve GÇS madde formatının aynı anda kullanımına uygundur. Bununla birlikte raporlama sürecinde verilerin düzenlenmesi için çok pratik bir ara yüzünün olmadığı görülmüştür. Bir diğer önemli konu ise ASÇS madde türünün patentli ve bu maddelerin bir test veya sınavda kullanılması için bir lisans gereğinin olmasıdır. Bu durum ASÇS madde türü için bir dezavantaj oluşturmaktadır. Her ne kadar araştırma ve deneme amaçlı olarak madde türünün kullanımından bir ücret talep edilmese de ASÇS madde türlerini destekleyen test dağıtım yazılımlarının sınırlı sayıda olması ve bu konuda ücret talep etmeleri de bir diğer önemli dezavantaj olarak ifade edilebilir.

Sonuç olarak bu çalışmada ASÇS maddelere ilişkin literatürden farklı olarak konu alanı, soru içerikleri, kullanılan yazılım, sınıf düzeyi ve karşılaştırmalı analizler yapılarak çeşitli

bulgular ortaya konulmuştur. ASÇS madde formatının yaklaşık yüzyıldır kullanılan GÇS madde formatı için önemli bir alternatif sunduğu görülmektedir. Bununla birlikte soru yazımı, kullanılması gereken yazılım, analiz yöntemleri ve sınırlı sayıda çalışma olan seçenek sıralaması (Bolt vd., 2018; Bolt vd., 2020) gibi konularda yeterince çalışmanın olmadığı görülmektedir.

Öneriler

ASÇS madde formatı, yaklaşık bir asırdır kullanılan GÇS madde formatına önemli bir alternatif sunmaktadır. Ancak soru yazımı, kullanılacak yazılım, analiz yöntemleri, seçeneklerin sıralanışı gibi konularda daha fazla çalışmaya ihtiyaç duyulmaktadır (Bolt vd., 2018; Bolt vd., 2020). Sonuç olarak bu çalışmada ASÇS maddeler ile ilgili literatürden farklı olarak konu alanı, soru içerikleri, kullanılan yazılım, sınıf düzeyi ve karşılaştırmalı analizler yapılarak çeşitli bulgular ortaya konulmuştur. Bu konuda yapılacak çalışmalar için uygulayıcılara ve araştırmacılara aşağıdaki öneriler sunulmuştur.

Uygulayıcılar için öneriler şunlardır:

ASÇS maddeleri ile ilgili çalışmalar incelendiğinde psikoloji, tıp, bilişim teknolojileri, Alman dili ve matematik alanlarında uygulamalar yapıldığı görülmektedir. Farklı alanlardaki ASÇS maddeleri ve soruların içeriği üzerine çalışmalar yapılması bu maddelerin kullanımına ilişkin bilgimizi artıracaktır.

Çalışmalardaki bir diğer kritik konu ise ASÇS maddelerinin bilgisayar tabanlı yazılımlar aracılığıyla sınava girecek bireylere ulaştırılması gerekliliğidir, dolayısıyla bu konuda yazılım geliştirilmesi elzemdir. Şu ana kadar yapılan çalışmalarda sınırlı sayıda yazılım kullanılmıştır.

Mevcut çalışmalarda ASÇS maddelerinin uygulandığı grupların lisans, lisansüstü ve yetişkin grupları olduğu düşünüldüğünde, çoktan seçmeli testlerin sıklıkla kullanıldığı K-12 düzeyinde de çalışmalara ihtiyaç olduğu açıktır.

ASÇS maddeleri ile GÇS maddelerini karşılaştırırken, farklı GÇS maddeleri için ASÇS paralel formlarının hazırlanması ve uygulanması önemlidir. Bu, ASÇS madde formatının doğası hakkında daha fazla bilgi sağlayacaktır.

Araştırmacılar için öneriler şu şekildedir:

ASÇS maddeleri üzerinde çalışılan örneklem büyüklükleri dikkate alındığında, çalışmaların daha büyük örneklem gruplarında tekrarlanması ve mevcut bulguların test edilmesi literatüre olumlu katkı sağlayacaktır.

Alanyazında ASÇS maddeleri üzerinde MTK temelli çalışmaların oldukça sınırlı olduğu göz önünde bulundurulduğunda, elde edilen verilerin analiz edilmesi için karşılaştırmalı çalışmaların yapılması elzemdir.

Gelecekteki önemli çalışma alanlarından bir diğeri de ASÇS maddelerinin akademik başarı dışındaki duyuşsal özellikler üzerindeki etkisini belirlemeye yönelik çalışmaların yapılması ve bu konudaki sınırlı literatüre katkı sağlanmasıdır.

ASÇS maddelerine yönelik en önemli eleştirilerden biri seçeneklerin sıra etkisidir. Seçeneklerin sıra etkisi üzerine yapılacak çalışmalar ve bu çalışmalara dayalı olarak

geliştirilecek yazılımlar ASÇS maddelerinin kullanımını yaygınlaştırabilir. Ancak literatürde bu konudaki çalışmalar daha kapsamlı olabilir.

ASÇS uygulamaları bağlamında, maddenin tamamını 0-1 puanlamak yerine, her bir seçenek veya kombinasyon için nominal yanıt veya kısmi kredi modeli gibi alternatif puanlama yöntemlerinin araştırılması ek bilgi sağlayabilir.



<http://www.tayjournal.com>

<https://dergipark.org.tr/en/pub/tayjournal>

Evaluation of School Occupational Health and Safety Practices Performance Indicators by School Administrators*

 Serkan Bilgiç, Asst. Prof., Corresponding Author
Ministry of Labor and Social Security, Türkiye
serkanbilgic@yahoo.com
Orcid ID: 0000-0001-9516-4072

 Tufan Aytaç, Prof. Dr.
Kırşehir Ahi Evran University, Türkiye
tufana60@gmail.com
Orcid ID: 0000-0002-6103-3530

Article Type: Research Article

Received Date: 14.12.2023

Accepted Date: 26.05.2024

Published Date: 31.07.2024

Plagiarism: This article has been reviewed by at least two referees and scanned via a plagiarism software

Doi: 10.29329/tayjournal.2024.653.07

Citation: Bilgiç, S., & Aytaç, T. (2024). Evaluation of school occupational health and safety practices performance indicators by school administrators. *Türk Akademik Yayınlar Dergisi (TAY Journal)*, 8(2), 349-389.

*This article was produced from Serkan Bilgiç's doctoral thesis supervised by Prof. Dr. Tufan Aytaç.

Abstract

The aim of this study is to determine school Occupational Health and Safety [OHS] performance indicators by revealing the opinions of school administrators about the effectiveness of OHS implementation. In line with this purpose, a semi-structured interview form was created. This method was applied randomly to ten school administrators working in public and private, primary, secondary, and high schools with 50 or more employees affiliated to the Ministry of National Education [MoNE] with criterion sampling, one of the purposeful sampling method types. Because of the analyses, six main categories were reached: OHS Education Effectiveness, OHS Awareness, OHS Material Effectiveness, OHS Managerial Effectiveness, Teacher and Student OHS Attitudes and Behaviors, and OHS Effectiveness in Pandemic. The main category of OHS Material Effectiveness is divided into three subcategory: "Visual Material intelligibility", "Visual Material Effectiveness", "OHS Material Use Adequacy". OHS Managerial Effectiveness: It was divided into two subcategory: "Managerial Duty and Responsibility Awareness" and "Managerial Problems Encountered and Solutions". It is expected that the findings will greatly contribute to the creation of indicator of school OHS performance. At the end of the research, researchers may be advised to The Occupational Health and Safety Management System [OHSAS] can be developed only for schools and studies on school safety coaching can be conducted.

Keywords: Performance, occupational health and safety, school occupational health and safety, teacher.

Introduction

While the concept of "occupational safety" refers to the protection of workers against technical risks, "occupational health" means keeping and maintaining the physical, mental, social, moral, and well-being of all employees at the highest level. To achieve this in workplaces, it is necessary to eliminate bad health conditions and protect against adverse conditions. Employees should be placed in suitable jobs physically and spiritually, work should be adapted to the person and the person to the job should be ensured. Occupational safety, on the other hand, is defined as the technical and systematic studies carried out to investigate and eliminate the damages and malfunctions that may occur in the workplaces due to the work practices and during the work to ensure the continuity of the work (Demir, 2006).

With the Industrial Revolution, people working in very poor working conditions and in great danger were faced with work accidents and occupational diseases. Over time, with the development of technology and protective tools, a safer working environment has been created. However, as time progresses, new risks have emerged that endanger the occupational health and safety of employees (occupational health and safety culture, legislation and operational problems, etc.) (Kılıç, 2014).

In the twentieth century, developments regarding Occupational Health and Safety [OHS] have become an issue that concerns the entire world. The International Labor Organization [ILO] within the United Nations [UN] has conducted important studies on OHS related issues. With the agreement signed between the UN and the ILO in 1946, the ILO became a specialized agency. The ILO and the World Health Organization [WHO] and many organizations that cooperate with these organizations have carried out important studies in terms of occupational health and safety. The "exposure values in the workplace" determined

for chemical substances by the ILO, of which our country is also a member, the decisions taken on occupational health and safety, and the international agreements created have contributed to the solution of OHS problems (Çetindağ, 2010).

In accordance with Article 4 of the Occupational Health and Safety Law No. 6331, the employer is obliged to inspect whether OHS-related health and safety measures are complied with and to ensure that any problems that arise are resolved. According to the 10th article of this law regarding risk assessment, necessary control, measurement, and examination must be carried out to eliminate the risk factors to which the working environment and employees are exposed in terms of OHS. According to the 8th article of the Regulation on Occupational Health and Safety Committees, the main duty of the OHS committees is to prepare a draft OHS internal directive suitable for the nature of the organization and submit it to the approval of the employer or employer's representative. Observing the implementation of the prepared directive, reporting the results of the observations, ensuring that the measures to be taken are determined, preparing an annual report on the current situation of the workplace regarding OHS, evaluating the studies related to the previous year, and collaborating with other institutions are among the other duties of these boards (Law on Occupational Health and Safety, 2012).

These OHS practices provide a safe education and working environment by keeping employees and learners in educational institutions away from stress, anxiety, and danger. This situation will provide a safe school environment for individuals by purifying the school from the dangers and risks that may arise. The feeling of physical and psychological comfort and peace of teachers, students, and staff is expressed through the concept of school safety. Therefore, a safe school environment to be created with OHS practices is considered important in terms of making individuals feel more comfortable and showing their performance in the best way (Çay, 2019).

The goal of the school safety plan is to create and maintain a school climate where success is rewarded and all students thrive in an environment free from dangers, violence, harmful addictions, and fear, where teachers can teach and students can learn (Stephens, 1998). All the practices that school administrators need to do regarding school safety are necessary precautions for the climate, culture, and educational qualities of the school. This is the purpose of the plans for school safety.

There have been studies on OHS practices applied in schools and their results, but no study has been found on OHS performance, which is used in other sectors where OHS is practiced and enables the effectiveness of OHS practices to be determined and their deficiencies to be revealed. In this context, it is necessary to develop a performance scale to evaluate whether the OHS management is effective enough on issues such as the school administrators', school's teachers, students, and employees' awareness and awareness levels on OHS and their views on OHS practices in schools, as well as the school's compliance with OHS criteria and cooperation between employees. It is thought that it will make a great contribution to managers. On the basis of this assumption, an in-depth examination of OHS practices in schools, development of a performance scale, and due diligence were found worthy of research.

Method

In this part of the research, the model followed in the research, the universe and sample/research group of the research, data collection tools, details of the application/procedure process, and how the collected data were analyzed are explained.

Model of The Research

It was desired to make an in-depth analysis of the situation to be investigated with the qualitative research method, and in this direction, the study was carried out with the 'phenomenology' design, which provides the opportunity to examine the desired phenomenon in depth. This pattern focuses on phenomena that we know about but do not have a detailed and in-depth understanding of (Yıldırım & Şimşek, 2016). Phenomenological research is handled in two ways. These are descriptive and interpretive phenomenological approaches. Descriptive phenomenology was preferred because the main purpose of the research was to describe the opinions and experiences of the school principals participating in the research on OHS practices (Ersoy, 2017). In this context, a semi-structured interview form was applied to examine the OHS practices of school administrators in depth. The data obtained were analyzed using the NVIVO program.

Sample Selection

The universe of the study was determined as the schools throughout Istanbul with 50 or more employees who perform OHS practices (Occupational Health and Safety Law, 2012). Since it is not possible to reach the entire universe in line with time and possibilities, the sample was determined (Yıldırım & Şimşek, 2008). In the 2021–2022 academic year, 25 (64.1%) of 39 districts in Istanbul are on the European side and 14 (35.9%) are on the Anatolian side (Ministry of National Education Statistics, 2020). Within this ratio, six districts from the European side and three districts from the Anatolian side were determined using the stratified sampling method at the rates of 25/39 and 14/39, which is a sampling type that aims to represent the strata or subgroups in the population in proportion to their weight in the universe. Within the proportions of the selected strata, the districts in Istanbul were selected randomly by drawing lots using simple random sampling methods (Büyüköztürk et al., 2012 as cited in Koç, 2017). Six districts (Esenyurt, Silivri, Bahçeşehir, Fatih, Büyükçekmece, Esenler) from the European side and three districts from the Anatolian side (Kadıköy, Üsküdar, Kartal) were selected. Schools with 50 or more employees were randomly determined by criterion sampling (Patton, 1990), which is one of the purposeful sampling methods used in primary schools, secondary schools, science high schools, Anatolian high schools, vocational high schools, and imam atip high schools in these districts. The semi-structured interview form prepared for qualitative research in the selected schools was applied to the school administrators determined as the study group in these schools. The criterion for participation in the study group was based on the condition of being a school administrator with 50 or more employees, since it was stated that the school administrator would act as the employer's representative in schools with 50 or more employees in accordance with the OHS regulation (Ministry of National Education [MoNE], 2014). According to Creswell (2017), the number of participants to whom the form will be applied in phenomenology should be between 3 and 10. In line with this information, 10 school administrators working in the specified schools were

included in the study. Considering the demographic characteristics of school administrators, the number of school administrators who are female have a seniority of more than 10 years, work in secondary schools and have a master's degree is low.

Data Collection Tool

Under this title, detailed information about the data collection tools used in data collection and the data collection process have been expressed.

Semistructured Interview Form

In line with the OHS practices of school administrators, a "semi-structured interview form" was used, which included eight open-ended questions, which were prepared to examine in depth the OHS practices in schools within the scope of the negativities, deficiencies, and solutions they created against them. Semi-structured interviews help the participant to answer the posed questions more easily and allow the researcher to make changes when posing the questions when the participant deems it necessary (Yıldırım & Şimşek, 2016). In semi-structured interviews, the researcher is the listener, while the participant answers the questions. The questions in the semi-structured interview form were first formed by examining the laws, regulations, and studies in the field, paying attention to reflect the research subject in the best way possible.

To determine whether the draft form of the developed interview form is qualified, suitable for research, and understandable, the content validity of the subject to be researched, and whether there are any questions to be corrected, removed, or added, it was shared with two professors, two doctoral faculty members, three doctoral students, three OHS experts, and two Turkish language experts. Then, according to expert opinions, questions were removed from the draft interview form, new questions were added, and the semi-structured interview form was finalized by making arrangements in line with the suggestions regarding the questions that were difficult to understand. In this direction, a semi-structured interview form called "Occupational Health and Safety Practices of School Administrators" consisting of eight open-ended questions was created. Before the interviews with the school administrators who will be in the study group, a semi-structured interview form was applied to two randomly selected school administrators to evaluate their intelligibility. Necessary corrections were made for possible problems that emerged after the application and the semi-structured interview form was finalized.

In qualitative research, validity is the degree to which the problem to be investigated is resolved objectively. In this context, it is of great importance to determine to what extent the data obtained in the research reflect reality. Examining the study problem as a whole and revealing the details of the phenomenon to be investigated are important criteria for establishing validity. In addition, in the interviews with the participants, in order to better understand the situation, "Is this what you mean?" or "Is this what I should understand from your words?" With questions such as, the consent of the participant was obtained and the validity was increased. In qualitative research, validity is examined in two ways: internal and external. Internal validity: It is the adequacy of the process followed in reaching the final results of the research, about how much the study reveals the real situation. "Do the

researcher's work, observed and tried to understand events or phenomena reflect the real situation in detail? Are the research findings meaningful and consistent? Are there specific rules, principles, or strategies used to verify the validity of the findings? Are there any facts or events that are unclear or whose relationships have not been defined? Were the findings found realistic by the participants?". Internal validity was increased with questions similar to these. In addition, approaches such as interacting for a certain period of time in the research environment and participant confirmation positively affect internal validity (Baltacı, 2019). In this context, observations were made by spending time in these schools to obtain information about the progress of OHS management and practices in the schools in the sample group where the research will be conducted. In addition, before starting the interviews, some data transferred to the text were reviewed by the school administrators and the qualitative analysis was carried out. Thus, if there were thoughts that the school administrators could not express during the interview, they were added to the data collection form and necessary arrangements were made.

External validity: refers to the generalizability of the research findings. It has been argued that cases are similar at similar times, whereas similar events are universal if they can produce similar results at different times. In this context, the limited generalizability of the research can be seen as a problem for a researcher who wants to ensure external validity. In this context, the researcher should provide the necessary detailed information about all the stages of work and convince the reader (Baltacı, 2019). In this direction, all stages of the research process have been attempted to be given in detail. Obtaining the same results when the research is conducted again shows reliability. Reliability, which is one of the prerequisites of credibility, is a condition that must be met in research. In this respect, the reliability of the research is

1. Invariance (continuity) with respect to time
2. Cohesion between independent experts and raters (rater consistency) is determined with.

Reliability is evaluated in two parts: internal reliability and external reliability. External reliability can be defined as obtaining similar results to the study performed when the study is repeated in similar environments. To ensure external reliability, the study should be reported according to objective criteria, and data sources and participants should be specified in detail. In addition, the researcher should clearly state the facts, events, and theories that constitute the source of work in the research report. In the Methods section, how the data are analyzed, the data collection process, and the data collection tools are explained in detail, contributing to external reliability (Baltacı, 2019). In this context, the details of the study have been added to the sections mentioned. Internal reliability, on the other hand, is expressed as different researchers reaching similar results using the same dataset. Including more than one researcher in the research, confirming the accuracy of the interviews of the participants and experts, using the analyses of other experts and researchers in the analysis of the data obtained, and cross-coding with different encoders are of great importance in determining the internal reliability (Creswell, 2017). In line with this approach, it has been ensured that there are no obvious mistakes such as bias or missing parts that are not suitable for the theme during the

analysis of the answers given, that there is no deviation in the definition of the codes during the coding process, and that there is no change in meaning. Codes the expert, who has completed a doctorate in the field of social sciences, was first given sufficient information on OHS, and sample codes were created. Afterwards, it was ensured that the coding required for the research was performed separately by two experts. Comparisons were made by gathering data in the two specified date ranges, and the final codes were formed as a result of the cross-checks. For reliability, Miles and Huberman reliability percentage was calculated.

According to the coding control, which provides internal consistency, the consensus among coders is expected to be at least 80% (Miles & Huberman, 1994; Patton, 2002, as cited in Arastaman et al., 2018). In light of this information, the two coders met on certain dates, and the reliability percentages were calculated. In the first meeting, 26 codes with consensus remained the same, 14 codes were revised, and 74% of the codes related to inter-expert agreement were decided. In the second meeting, 32 codes with which consensus was reached remained the same, 3 codes were revised, and 92% of the codes related to inter-expert agreement were decided. 90% and above is an acceptable value for Miles and Huberman (Miles & Huberman, 1994; Patton, 2002, as cited in Arastaman et al., 2018). Cohen's kappa (k) coefficient is another technique used for reliability. The Kappa coefficient shows the proportion of the other compromises after the luck factored ones are excluded from the compromises. This statistical value takes a value between 0 and 1, and it is stated that values of .40 and above show acceptable reconciliation power (Wynd et al., 2003, as cited in Arastaman et al., 2018). Both Miles, Huberman percent reliability and Cohen's kappa (k) coefficient are not recommended by Shenton (2004), Lincoln and Guba (1988), Guba (1981) as they are more in line with the nature of the rigor concept of approaches (Arastaman et al., 2018).

Kappa coefficient analysis was performed to measure agreement between two observers. According to the results of this analysis, the two coders are significantly compatible ($K=721$; $p < .05$). Kappa statistical values are given in Table 1

Table 1.

Kappa Statistics Value

Kappa		.721
Comparison of	<i>SD</i>	.99
	<i>p</i>	.000

$p < .05$

In addition, to protect the identities of the school administrators participating in the research, coding was made as E1, E2, ... for male participants and K1, K2, ... for female participants. The obtained data were analyzed using the "content analysis method". This analysis method is used to determine the meanings and similarities in the data obtained from the observations and interviews, as well as to reveal the truths hidden in the data (Akbulut, 2021). In this direction, the research data were examined, coding was performed with the help of the NVIVO program, and categories were created by paying attention to the similarities and differences.

Ethical Permits of Research:

In this study, all the rules specified to be followed within the scope of "Higher Education Institutions Scientific Research and Publication Ethics Directive" were complied with. None of the actions specified under the heading "Actions Contrary to Scientific Research and Publication Ethics", which is the second part of the directive, have been taken.

Ethics Committee Permission Information:

Name of the committee that made the ethical evaluation = Kırşehir Ahi Evran University Social and Humanities Scientific Research and Publication Ethics Committee

Date of ethical review decision= 25.03.2022

Ethics evaluation document publication number= 2022/03/45

Findings

Open-ended questions were asked to the school administrators who participated in the research about their views on the OHS practices they perform at school, the problems they encounter in the practices, the deficiencies, and the perceptions of the school stakeholders on the OHS practices. In this context, the findings related to the answers provided by the school administrators are presented in the form of tables and figures below.

Theme, Category and Codes Determined by The Data Collection Tool

The views of school administrators about OHS practices carried out in schools were analyzed in the NVIVO program, and all the themes, categories, and codes were shown.

OHS Training Effectiveness

The categories and codes obtained under this heading, where the opinions of school administrators about the effectiveness of the OHS trainings given in their ability to manage the OHS practices they manage in their schools more effectively, are shown in Figure 1.

Figure 1.

Training Effectiveness Category and Codes

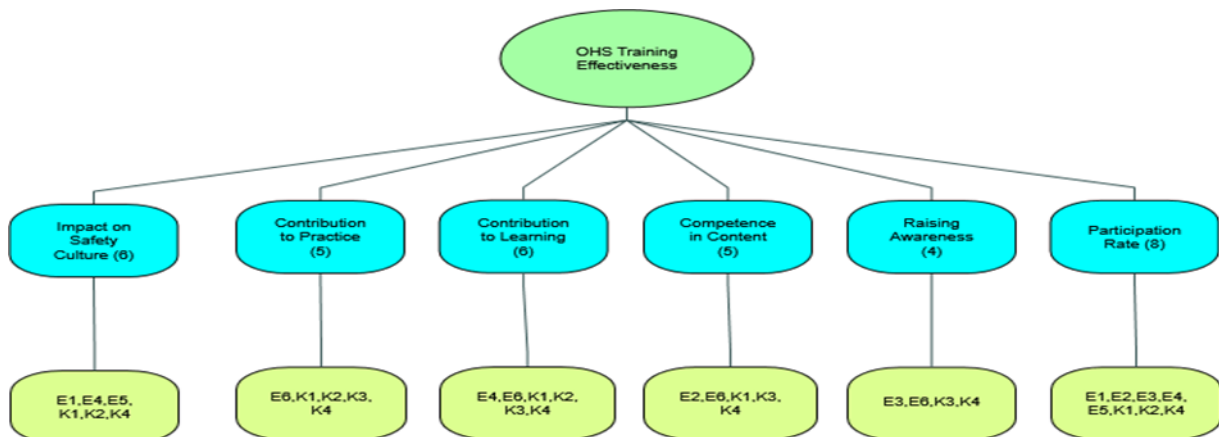

In this context, the statements of E2, E4, and E5 are given below.

I attend every training session and I think it is effective (E2).

I attend training. It helps us to ensure life safety within the framework of OHS practices, to perform the education and training process in schools at a more reliable stage, and to guide student teachers and employees in this direction (E4).

It enables me to gain a new awareness in terms of life safety and make it my priority every time (E5).

Negative approaches of school administrators for OHS trainings given: In particular, the trainings are made as a legal obligation, the people who give the training are not competent, the presentations are not supported with visual content, and the applications are given less place. E3, E6, K1, and K3 expressed this situation as follows:

I generally do not participate in OHS practices and training related to practice because I do not think it is very effective. I see it as a waste of time because it only progresses as a legal obligation and those who give the training do not have control over the event (E3).

I do not think that the training provided is effective enough. However, I think that if the training is done practically and the trainers are more competent in OHS, the goal will be closer (E6).

Superficial information is provided. I do not think that it is very useful because it is a short-term training. I believe that if more practical training is provided, its effectiveness will increase (K1).

I attend the trainings, but I do not think it is effective. I believe it will be effective if the intended information and visual content are too much (K3).

In the evaluations made for the OHS trainings given by the provincial and district national education directorates, it was stated that the OHS trainings provided did not provide sufficient effect in creating the necessary sensitivity in cases of risk and danger:

I am trying to participate in OHS practices in schools and in training related to practice. I do not think that life safety will be fully ensured with the content of the trainings given within the framework of OHS practices. For the education and training process in schools to occur at a more reliable stage, more comprehensive evaluations can be made and the OHS education content and rules can be arranged within this framework (E4).

Some negative criticisms of school administrators on the OHS trainings were related to the training dates and times. It has been stated that the planned hours for OHS training, outside of working hours, reduce participation, which negatively affects the importance given to OHS training. K4's view on this situation is as follows:

... unfortunately, the importance and attention of school administrators toward the subject decreases when the trainings that should be done during working hours are carried out after working hours. The deficiencies seen in the mentioned practices in education impact the perspective of the subject even more negatively (K4).

OHS Awareness

In this section, the opinions of school administrators on OHS awareness are explained, and the categories and codes obtained are shown in Figure 2.

Figure 2.
OHS Awareness Categories and Codes

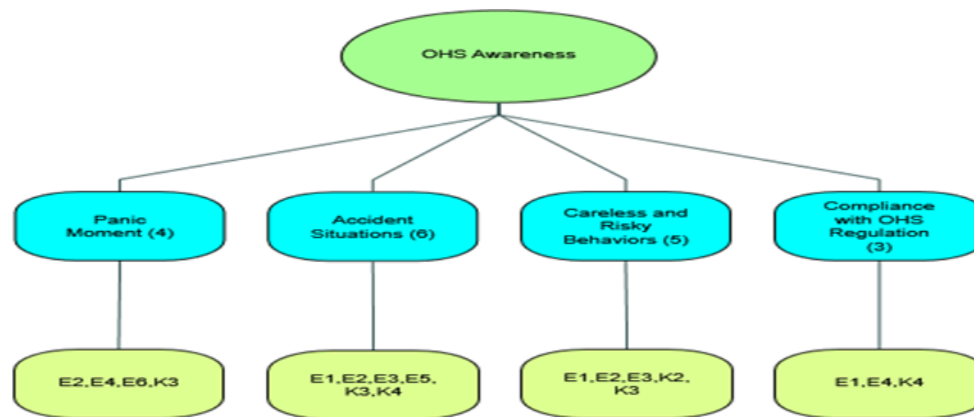

In the examination conducted on 'OHS awareness', one of the categories of the effectiveness of OHS practices, the majority of school principals think that the awareness effect is sufficient.

E1, E5, E6, and K2 stated that it was observed that the awareness increased the panic environment experienced during the accident and gave way to more controlled and precautionary behaviors as follows:

While acting carelessly in accidents and incidents before OHS practices, all processes before and after the accident are more controlled with this awareness created by OHS practices. ... (E1).

Awareness and the creation of awareness prevented panic during and after the accident. The accident situation was resolved with colder blood (E2).

... I naturally think that it will have improved awareness compared with the past (E5).

I believe that every training and application is always better than the old one in terms of awareness; naturally, this situation affects the accident moment and before it positively (E6).

Awareness occurs after each training session (K2).

In the comments made in line with the level of awareness of E3 and K1 OHS practices, it was stated that teachers' awareness improved, but there was not much change in students' awareness. School principals stated that more time should be allocated to the students to raise awareness, that there should be more visual content, and that the trainings given by experts should be given with teaching techniques suitable for the level of the student.

OHS practices naturally create an interest, and it is seen that the level of awareness, especially in teachers, increases, but this is not seen much in students. I think there is not much change in general (E3).

Teachers have a high level of awareness. More training should be provided to students. Training given by real experts and suitable for children will be effective. Only the presentation method should not be used in the trainings; it should be demonstrated and applied (K1).

E4' stated that the question marks that formed in the minds of the students before the OHS practices were erased after the practices, and their awareness level was higher about how they would act in times of danger. In addition, E4' stated that the prejudices of the teachers continued, and therefore there was not much change.

Before the OHS applications, the questions that had question marks in the minds of the students were removed with the awareness created by the OHS applications. For teachers, the situation continued in the same way as before and after... (E4).

K2 stated that it is natural to increase awareness within the framework of the practices, and that awareness has partially increased, but there is not much change in injury rates.

Although the approach has changed partially in cases related to accidents, injuries continue (K2).

K3 stated that there was no change after the OHS practices and that parents should also participate in the process, especially in raising the awareness of students as follows:

I do not think that the awareness is high, the support of the family is necessary for the awareness to be at the desired level (K3).

E2 stated that protection from accident and risk factors is ensured thanks to the teachers who are experienced and have more knowledge of the situation, rather than the OHS practices, and that OHS practices are generally on paper.

There were no serious accidents in our school due to the profession, seniority, and attention of the teachers, rather than the effect of the OHS practices. Compared with the past, there is a decrease in simple accidents, but it can be said that OHS applications should not remain on paper to be more effective (E2).

OHS Material Effectiveness

In this section, the opinions of school administrators on OHS material effectiveness are explained, and the categories and codes obtained are shown in Figure 3.

Figure 3.

OHS Material Effectiveness Category and Codes



In the evaluations made by school administrators, the category of "OHS Material Effectiveness" is divided into three subcategories: "Visual Material Understandability", "Visual Material Effectiveness" and "OHS Material Use Adequacy".

In the evaluations of the school administrators about the 'Visual Material Understanding'; they are generally understandable by E1, E2, E3, E4, E6, K1, K2, and K4 as follows:

Its intelligibility is seen as sufficient because the feedback received by the students is positive (E1).

understandable and appropriate to the learning level of the students (E2).

Especially the posters are interesting and understandable...(E3).

...intelligibility is sufficient. Images express themselves in accordance with their intended purpose (E4).

...it is understandable...(E6).

It attracts the attention of children and employees and provides sufficient information about what to do (K1).

Visual materials convey the desired message about the importance of OHS practices. Therefore, its intelligibility is sufficient (K2).

... The works prepared by teachers and students are understandable (K4).

In the 'Visual Material Understandability' sub-category, E5 and K3 stated that visual OHS materials, which are designed in accordance with the desired purpose and increase their attractiveness, will contribute more to the intelligibility as follows:

I can't say that it attracted much attention, but it seems that the visuals were designed in accordance with the desired purpose, so it is understandable (E5).

Visual materials can be developed further, especially if they are designed by students according to their age levels, they can attract more attention, so if they are developed again considering the age for the purpose, their effectiveness as well as intelligibility (K3) can be ensured.

According to the comments made by school administrators belonging to the sub-category called 'Visual Material Effectiveness'; the view that the materials are not effective is more dominant. This situation was expressed by E3, E4, E5, and E6 as follows:

... I cannot say the same about material effectiveness because especially the OHS measures taken are not approached very sensitively (E3).

I do not think its effectiveness is excellent. I wouldn't say it's completely bad either (E4).

... I can't say it's effective (E5).

I don't think it is effective; it should be changed frequently with different images to be more effective (E6).

Visual materials can be developed further, especially if they are designed by students according to their age levels, they can attract more attention, so if they are developed again considering the age for the purpose, their effectiveness can be ensured as well as intelligibility (K3).

School administrators emphasized that visual materials are interesting and effective in accident and risk factors by E1, K1, and K4 as follows:

I do not think it is as effective as its intelligibility (E1).

The materials prepared for OHS are sufficient and effective (K1).

I think it is effective (K4).

E2, K1, and K3 emphasized that the materials are effective, that they should be arranged according to the student age group to be more effective, and that their attractiveness should be increased:

I think it is effective, I think it will be even better if it is revised according to student age levels in schools (E2).

It attracts the attention of children and employees and provides sufficient information about what to do (K1).

Visual materials can be developed further, especially if they are designed by students according to their age levels, they can attract more attention, so if they are developed again considering the age for the purpose, their effectiveness can be ensured as well as intelligibility (K3).

K2, one of the school administrators, stated that the effectiveness of the visual material was not complete, and no visible effect was observed when compared with the previous one.

Its effectiveness is moderate because some injuries are caused by non-compliance with OHS rules (K2).

Considering the comments made for 'OHS Material Use Adequacy', which is stated as the third subcategory related to OHS material effectiveness, it has been stated that, especially since the competence levels of the teachers are good, their proficiency in using OHS tools is also good. However, E1, E3, E4, E6, and K3 expressed that especially high school students cannot use OHS tools and equipment because their competence in using OHS materials is not yet at the desired level:

As the management and teaching staff, we use the tools related to OHS at a sufficient level (E1).

Because of their level of awareness, our teachers use OHS-related tools and equipment adequately. I do not think that our students have the required qualifications because they are not given adequate training on the introduction and use of OHS tools (E3).

As management and teaching staff, we use OHS-related tools and equipment adequately. I believe that this sensitivity can be increased by conducting awareness studies about the use of relevant tools for the safety of our students and ourselves (E4).

Of course, it would be a little wrong to expect such a thing from students, but in parallel with the effectiveness of the trainings, teachers are considered sufficient in the use and application of OHS equipment, and age is important (E6).

When adequate promotion is made, there is no problem in its use, but the students have deficiencies in this regard because of their age, and they have problems in their use (K3).

School administrators produce solutions to increase the effectiveness of the use of OHS equipment. E1, E2, E4, and K1 are of the opinion that approaches such as introducing and demonstrating OHS equipment in training given by experts in this field and preparing slides emphasizing the importance of using equipment will increase the proficiency in the use of materials.

The use of the relevant tools and equipment for our students is not at the desired level, and this sensitivity can be increased by conducting awareness studies by the experts assigned by the Ministry of National Education (E1).

... practical training will solve this problem (E2).

I believe that this sensitivity can be increased by conducting awareness studies about the use of relevant tools for the safety of our students and ourselves (E4).

More full presentations and trainings should be made by people who are better equipped about their necessity (K1).

E2, E5, K1, and K2 did not have a positive approach to the adequacy of material use in the OHS practices managed in schools and offered suggestions regarding the necessity of eliminating the deficiencies within the MoNE.

I do not think that the competencies are sufficiently developed, but practical training will solve this problem (E2).

No studies have been conducted on the use of OHS equipment. This is because the Ministry of National Education does not direct experts on the subject. Naturally, the use of tools is not at a sufficient level (E5).

Managers and teachers are not competent in using OHS tools. More training is needed. Superficial training turns OHS practices into an ordinary business situation (K1).

Mastery of the use of tools and equipment is not at a sufficient level due to the lack of training and detailed practical explanations and the inability to allocate sufficient time (K2).

K3 stated that by presenting a different perspective on material use proficiency, they especially increased teachers' awareness of the use of OHS equipment and contributed to the use of equipment in class or extracurricular times, as follows.

Vocational teachers at our school inform their students about OHS equipment in the professional development course. This improves competence in the use of tools. Although not all the teachers are sufficient in the use of tools, we are trying to provide the necessary training (K4).

OHS Managerial Effectiveness

In this section, where school administrators' views on OHS managerial effectiveness are explained, the categories and codes obtained are shown in Figure 4.

Figure 4.

OHS Managerial Effectiveness Category and Codes

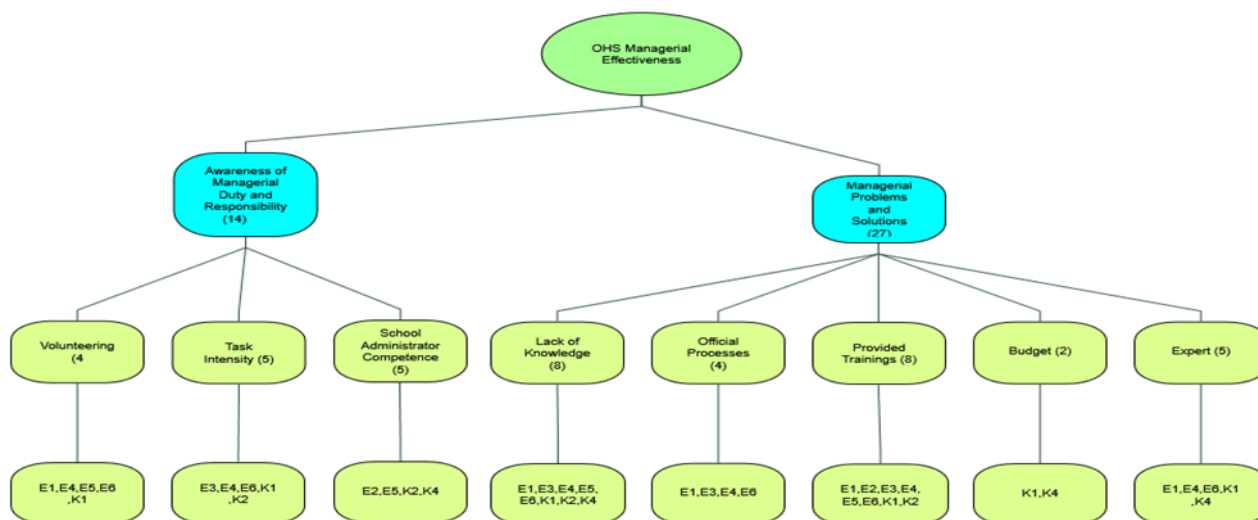

The two subcategories determined as 'Managerial Duty and Responsibility Awareness' and 'Managerial Problems and Solutions' are shown in Figure 4.

Responsibility' subcategory, it was stated that the OHS duty and responsibility awareness of school administrators was insufficient. However, it is seen that E2, E6, and K2' give a more positive opinion for this subcategory.

Although the law obliges school administrators, sufficient awareness is created as volunteering is prioritized in their duty regions (E2).

Since the school administrators are the first to be responsible in accordance with the regulation, they have to be related by necessity (E6).

School administrators are aware of their OHS duties and responsibilities and perform their duties as best they can (K2).

E3 and E4 stated that school administrators are aware of their duties and responsibilities, but the studies have not reached the desired level. In addition, they stated that they had to take responsibility for the injuries that may occur because of all kinds of accidents that may occur in the school, and this situation put the school principals under stress.

OHS practices managed by school administrators have taken precedence over their main job of education and training. Being seen as the cause of accidents that may occur at school stresses school administrators a lot, so their awareness is high but not sufficient (E3).

Of course, my school administrator friends are aware of their OHS responsibilities, but sometimes they turn into situations that cannot be overcome because of too many responsibilities (E4).

E1, E4, K1, K3, and K4 stated that the level of consciousness was not sufficient. The reason for this is that school administrators have stated reasons such as the burden of duty arising from education is high, the laws and obligations are not known well enough, and the training given by the Ministry of National Education is not given by competent people:

Although school administrators have many duties and responsibilities, OHS practices should be conducted with OHS experts to be allocated to institutions. I do not think that school administrators perform this task at the desired level (E1).

When the problems of teachers and students regarding the duties and responsibilities of the school administration with education are added, the intensity increases. When the heavier burden of OHS applications is added to this situation, the situation becomes quite difficult (E4).

Too many responsibilities are placed on school administrators regarding OHS. A budget is needed to take some measures, but unfortunately, such a budget is not given to schools. Most school administrators are not aware of their responsibilities. The situation is progressing only as a legal obligation (K1).

In general, I do not think that our colleagues have this responsibility at the desired level; unfortunately, most of them are not aware of this heavy burden (K3).

The applications made by the Ministry are insufficient to understand the importance of the subject. Therefore, I think that school administrators are not sufficiently aware of their OHS duties and responsibilities (K4).

E5, it was stated that OHS-related approaches are taken more seriously in natural disasters such as epidemics, and this positively contributes to the increase of OHS duty awareness. However, it has been stated that when these processes are over and they return to normal again, there will be a decrease in the level of consciousness.

Because it is seen as a legal obligation, I think the seriousness of the situation was understood during the pandemic process. Even though the pandemic process shows how serious the event is, I think it will return to the same triviality when it's over (E5).

E1, E2, E4, E6, K1, and K4 from school administrators stated that there is a lack of information in the 'Managerial Problems Encountered and Solutions' category, which is the second sub-category of the 'OHS Managerial Effectiveness' category, and that the quality of the training given by the experts should be increased to overcome this deficiency. They also stated that the establishment of a more internalized system regarding OHS laws and regulations would be effective, and the provision of competent experts by independent institutions would increase the quality of OHS practices.

In general, I encounter problems with carelessness in OHS practices and lack of knowledge about the official process of the work. In-service training and adequate delivery of the procedures of the situation by actual experts will help to solve the problems (E1).

The biggest problem is that the organizations providing OHS services are not independent. In other words, receiving services from independent OHS organizations for the

training and practices provided will lead to more sensitive progress on the subject and the problems will be resolved faster (E2).

In general, problems of carelessness and lack of information about the official process of work are encountered in OHS practices. Sufficient and remarkable in-service training will help solve problems and increase efficiency (E4).

In this regard, the risk analyses required by the legislation, especially by the business experts, and taking the measures in line with these analyses will contribute greatly to the problem (E6).

We also have the problem of a lack of information. In my opinion, school administrators should be informed about their duties and responsibilities, and they should receive training and work with people who have OHS expertise in this regard (K1).

In addition, the ministry can conduct more comprehensive and coordinated studies by increasing the number of OHS experts (K4).

K1 and K4 It was stated that the necessary financial resources should be provided to perform the studies more professionally and that these resources should be supported by additional budgets, not from the school budget. In addition to the purchase of the necessary services, this approach also includes missing equipment, physical changes of the school, etc. It has been stated that it will help in ensuring that it is used in expenditures such as.

The biggest problem is the budget problem in the measures to be taken for OHS (K1).

However, there are serious problems in eliminating other deficiencies in schools that are insufficient in terms of cost. The Ministry can overcome these problems by creating appropriations on the basis of schools (K4).

School administrators stated that not giving the necessary importance to OHS practices that prevent danger and risk situations that may cause loss of life and property and the lack of sensitivity on this issue create a big problem in OHS management. In solving this problem, the necessity of removing the training from the circle of monotony and giving them hands-on training by experts, using mobile applications, taking the lead in OHS management with the guidance of risk analyzes prepared by experts, and using all necessary approaches to eliminate perception deficiencies were expressed by E5, E6, and K3 as follows.

Conducting training in the form of seminars causes the work to be considered boring, monotonous, and a waste of time. They should be supported by mobile applications (E5).

... so no matter how sensitive you are about it, it comes out of an open place. Especially by business experts, the risk analyses required by the legislation and taking precautions in line with these analyses will contribute greatly to the problem (E6).

I think that people have great deficiencies in their sensitivity to situations, which causes great problems in practice. Therefore, first, the necessary work should be done to increase the perception of people on the subject. Training should focus on this situation (K3).

The comments made indicate that one of the major problems that school administrators encounter while performing OHS practices is the inability to allocate the

necessary time for OHS practices due to the excessive intensity of the education and training process. It was stated that this situation caused great divisions, and that most efforts to prevent risk and danger situations that should be done in accordance with the regulation were overlooked. Among those presented as a solution, the most important suggestion was that the execution of OHS practices should be carried out by experts, and that if the execution was to remain with the school administration, the responsibility should be shared. The opinions of E1, E3, E4, and K1 on the subject are as follows.

Although school administrators have many duties and responsibilities, OHS practices should be conducted with OHS experts to be allocated to institutions (E1).

Being seen as the cause of accidents that may occur outside legal responsibility in a situation where the OHS practices managed by school administrators come before their main job, education and training, puts school administrators under stress (E3).

When the problems of teachers and students regarding the duties and responsibilities of the school administration with education are added, the intensity increases. When the heavier burden of OHS practices is added to this situation, the situation becomes quite difficult. Of course, my school administrator friends are aware of their OHS responsibilities, but due to the reasons listed above, they sometimes turn into situations that cannot be overcome. As for how to solve this problem, conducting it with OHS experts to be allocated to institutions will ensure that the situation will be conducted more disciplined (E4).

Too much responsibility is placed on school administrators on OHS (K1).

Teacher and Student OHS Attitudes and Behaviors

The categories and codes obtained in line with the opinions of school administrators regarding teacher and student attitudes and behaviors are shown in Figure 5.

Figure 5.

Teacher and Student OHS Attitudes and Behaviors Categories and Codes

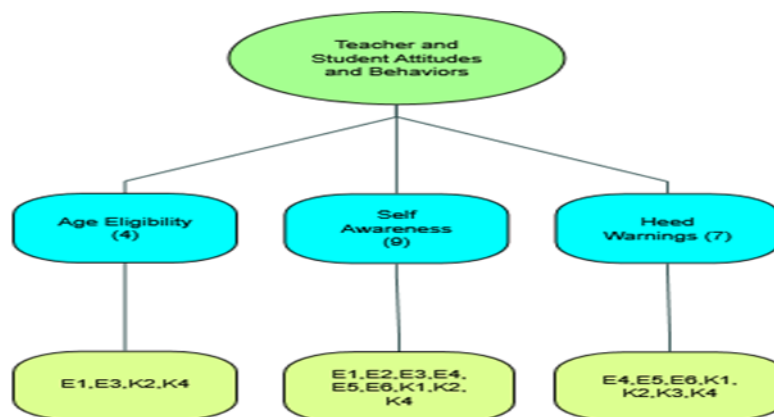

This situation is expressed by E1, E3, E4, E5, K2, and K3 as follows:

Most of the time, our teachers fully comply with the OHS practices because they are more sensitive in consciousness and are more aware of the seriousness of the event, whereas the students know the importance of the practices but do not pay much attention to them (E1).

Most of the time, our teachers show the desired sensitivity to OHS practices and fully comply with the instructions, whereas students do not consider OHS practices due to their age, even if they are aware of them (E3).

Most of the time, our teachers comply with OHS practices... (E4).

Even though students are aware of OHS practices, they do not take it into account too much (E4).

... reflects OHS practices in their attitudes and behaviors at a sufficient level (E5).

As much as they can, our teachers develop positive attitudes and behaviors toward OHS practices and follow the rules. Although the awareness of the students increases due to the attractiveness of the applications, they cannot fully reflect the OHS practices in their attitudes and behaviors due to their age (K2).

When the application rules are explained in detail and clearly, the teachers understand the situation and develop more sensitive attitudes. However, I do not think that students will develop attitudes and behaviors at the desired level because of their age (K3).

In particular, E2 and E1 stated that the sensitivity of both groups to OHS practices varies according to the person, age, experience, and education level, and therefore cannot be the same for everyone; therefore, attitudes and behaviors differ from person to person.

The same sensitivity does not occur in every staff member and student. Therefore, attitudes and behaviors generally progress toward the person (E2).

It is seen that teachers and students are willing to participate in OHS practices; however, I cannot give clear information about whether this affects their attitudes and behaviors (K1).

E4 and K1 stated that the positive attitudes of teachers toward the behaviors they normally show in line with OHS practices change negatively during exam and activity periods when the workload increases, and they do not exhibit the desired behaviors. In addition, they stated that deficiencies in OHS training practices and high difficulty levels of OHS practices cause behavioral deficiencies.

Most of the time, our teachers comply with OHS practices, but I think that the sensitivity to the necessary accident risk situations decreases, especially during exam and activity returns (E4).

... however, OHS practices can be ignored because they are difficult to perform in practice (K1).

E5 stated that school teachers reflect what they already know about OHS practices on their behaviors, and that they cannot comment much on students' behaviors, but how much what is learned is reflected in behaviors in case of accidents can be observed:

Some teachers think of such practices as things they already know and reflect them on their attitudes and behaviors at a sufficient level. They have high interest because it is new

and attractive to students, but is it reflected in their attitudes and behaviors? I cannot say anything for sure without seeing it at the time of the accident (E5).

Expressing that the situation is negative for both groups in his comment, E6 expressed his views on the importance of OHS practices in epidemics and stated that the efforts to prevent accidents and risk factors will help protect against all loss of life and property, especially natural disasters:

They are not aware of the situation yet, but the pandemic period that has emerged recently has shown what will happen if the necessary sensitivity is not the case (E6).

K4 stated that both groups managed to avoid being harmed by emergency, danger, and risk factors with the experience and practices they gained through school club activities. Their readiness levels improved thanks to these trainings and positive attitudes were formed:

In addition to the OHS practices, first aid training, natural disaster and fire drills, evacuation, protection, and rescue practices in line with the work of the civil defense club have positively affected the attitudes and behaviors of both teachers and students (K4).

OHS Effectiveness in a Pandemic

Considering the effectiveness of OHS in the pandemic, the school administration has the category and codes form shown in Figure 6.

Figure 6.

Pandemic Period OHS Effectiveness Categories and Codes

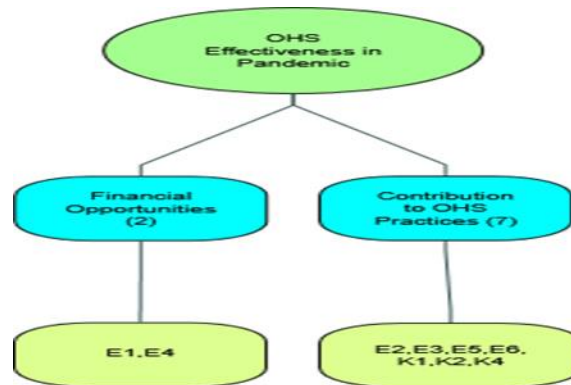

Considering the general answers in this category, it is seen that the practices during the pandemic period positively affect all processes related to OHS. It has been stated that especially health-related OHS studies are at the forefront, school stakeholders are more sensitive about hygiene-related measures, and risky situation measures are applied sensitively by school stakeholders. This situation is expressed by E1, E2, E3, E4, E5, E6, K1, K2, and K4 as follows:

In the pandemic process, OHS applications, especially those related to health, have been seen as more important... (E1).

They provided support and guidance regarding the pandemic measures and preparations to be taken. OHS hygiene practices, which were not given much importance before, gained great importance especially in this period (E2).

This troublesome process emphasized the importance of OHS practices. For example, students without the habit of washing their hands now wash their hands after everything they touch. Many more sensitivities like this started to form throughout the school (E3).

To increase the awareness of OHS in the pandemic process positively... (E4).

In particular, awareness about health has increased and the severity of the situation has been seen more clearly. Occupational health has become more significant in this respect. All school staff and students started to be more careful about virus-related measures, naturally, especially hygiene measures were taken spontaneously (E5).

The pandemic spread quickly and education stopped completely, especially in the absence of hygiene-related measures (E6).

In this process, more attention was paid to OHS practices. Studies were conducted more carefully, both as management and as implementing personnel. In particular, with the 'My School is Clean' certification process, many measures have been taken and the applications continue (K1).

Gained more sensitivity, increased general awareness on precautions, improved hygiene measures more, and naturally enabled the measures to be taken within the scope of OHS to turn into behavior in a shorter time (K2).

The pandemic process has improved the sensitivity of OHS practices, especially in terms of cleaning, hygiene, and mask use. OHS rules were provided without any warning (K4).

While talking about the sensitivity of the OHS hygiene measures applied during the pandemic process, school administrators especially mentioned the lack of financial opportunities, emphasizing that the importance of these deficiencies in the process is very great, and it was stated that the ministry should allocate a special budget for this situation. E1 and E4 express the situation as follows:

... OHS practices that need to be performed to protect against the virus were blocked due to financial insufficiency. Because these applications can be carried out easily within the financial possibilities, the provision of appropriation support by our ministry will relieve the situation (E1).

OHS practices have been prevented from being fully implemented due to a lack of financial means. Because these applications can be carried out easily within the financial possibilities, appropriation support should be provided by our ministry during the pandemic process (E4).

K2, one of the school administrators, stated that the positive effects of the pandemic period were not observed, there was no change in the sensitivity of school stakeholders to OHS, and the mistakes made in previous accidents and risk situations continued.

I do not think that the pandemic process has any effect on OHS practices. As in previous processes, sufficient sensitivity was not provided in the case of accidents and risks (K2).

Discussion and Conclusion

According to the opinions of school administrators regarding OHS practices carried out in schools, school OHS performance indicators include OHS Education Effectiveness, OHS Awareness, OHS Material Effectiveness, OHS Managerial Effectiveness, Teacher and Student OHS Attitudes and Behaviors, and OHS Effectiveness in Pandemic.

The opinions of school principals regarding the OHS Training Effectiveness category were examined, and the general opinions were evaluated as the ineffectiveness of OHS training. The potential for damage or harm by affecting the employees or the organization, existing in the working environment or coming from outside, is called "hazard" and the possibility of injury, loss, or other harmful consequences arising from these hazards is called "risk". To be protected from dangers and risks in the organizational environment, OHS training should be given to the employees of the organization (Akpınar & Öğütoğulları, 2016). In the evaluations made, in the comments made that the school administrators did not find the implemented OHS trainings effective enough and "What can be done to make it effective"; the necessity of determining the needs and conducting trainings in this direction was emphasized. In parallel with the approach of Akpınar and Öğütoğulları (2016), a needs questionnaire should be administered to employees by an OHS specialist or a workplace physician before training programs are created. In this way, the duration and type of education should be revealed. It should be ensured that the continuity of OHS trainings of school administrators and which trainings will be provided in the future should be determined, and the quality of OHS education should be increased. In this direction, according to Kılış and Demir (2012), the subject and type of OHS training should be determined and a training program showing the OHS training to be implemented in the current year should be prepared. In this training program, there should be information about the purpose, subject, date, target, duration of the trainings to be given, the title, name, surname of the trainees, and the number of those who will attend the training. It will be of great benefit to perform training activities within a program in terms of ensuring the continuity of the trainings given, determining which trainings are given before and which trainings can be provided for the following periods. It has been determined that the comments made by school administrators about the improvement of OHS training are especially in line with the delivery of training by competent people. In parallel with this approach, according to Akpınar and Öğütoğulları (2016), professionals with certain competencies are needed to implement training programs. These professionals should be occupational safety specialists, field specialists, workplace physicians, supervisors, coordinators, or employees who have received training in this field.

In the same direction, Çay (2019) on OHS practices in schools talked about the importance of OHS training given in schools and emphasized that there are deficiencies in their effectiveness. Likewise, Taşdemir and Gür (2021) examined the findings regarding the OHS training program and stated that teachers opinions on OHS training programs were positive, but they reported negative opinions about the shortness of the training period and the lack of materials and practices. The OHS trainings conducted in schools have a great impact on the OHS attitudes and behaviors of school stakeholders. In particular, it is seen that school administrators should take measures to ensure that the visual contents are included in the

management of the OHS education process, as well as case studies and practical explanations. Yılmaz (2009), one of the OHS studies conducted on organizations outside the school, emphasized that OHS trainings are essential in his research and stated that these trainings are insufficient and therefore the effectiveness of OHS is reduced. In addition, he stated that a systematic approach is needed for OHS training. Apart from the contribution of OHS trainings to OHS practices, there is also the effect of increasing safety awareness. In particular, Dursun (2014) investigated the relationship between safety awareness and OHS behaviors in work environments and determined that OHS training is of great importance in improving safety awareness. In addition, it has been stated that the importance of occupational safety and safe behavior should be emphasized at all stages of training to eliminate deficiencies in the current situation. It is stated that OHS training contributes to the development of OHS culture in the working environment as well as to the benefits related to safe behavior and OHS awareness. Bilir (2016) stated that the importance of OHS training in creating an OHS culture and increasing the level of accident and risk factor awareness in our country is great, but he stated that this situation is not at sufficient levels. In addition, it has been determined that many work accidents occur every year because of mistakes caused by a lack of education; therefore, there are inadequacies in the effectiveness of education. In general, it was emphasized that the OHS trainings were either not done or incomplete, that the OHS trainings did not contribute to the prevention of accidents and risk factors in the working environment, and that the OHS practices could not serve their main purpose. Yılmaz (2009), stated that the most important OHS-related issue in Türkiye is OHS training, but the necessary importance is not shown. It is thought that the emphasis on the effectiveness of OHS training will be beneficial in eliminating the deficiencies of OHS training. The findings revealed that while focusing on the results of OHS training deficiencies, the management level or employer representatives who took part in the delivery and execution of these trainings were not mentioned much. It also showed that there is no guiding study for OHS education content or for school administrators. It is thought that this study will be a guide in eliminating the deficiencies arising from this situation.

Regarding OHS awareness, school principals stated that the awareness of school stakeholders on the subject was sufficient and that the practices carried out improved the awareness level of teachers. The concept used to show the level of awareness of people's own behavior and attitude is expressed as awareness (Kağıtçıbaşı, 2010). Security awareness is defined as the mentality that determines the judgments, perceptions, and awareness of employees regarding their individual abilities and responsibilities to protect themselves from the risks that will lead to a dangerous situation in the work environment. Studies have shown that safety awareness has an impact on OHS-related behaviors (Dursun, 2014). In line with the comments made by school administrators about OHS awareness, it was observed that teachers' safety awareness increased depending on seniority and year. In this direction, it has been determined that young teachers do not have sufficient sensitivity at the point of OHS application, so the desired safe behaviors are not observed in the risk situations experienced. In addition, according to Dursun and Keser (2014), the safety awareness of the employees in the organization is an effective factor in occupational safety behaviors, and as the safety awareness of the employees increases, they participate more in safety-related issues. Therefore, the activities and arrangements that increase the safety awareness of employees are

of great importance in reducing occupational accidents. For this purpose, the security mission, slogans, material publications (library, statistics, bulletins), logos, effective use of media tools, effective OHS trainings, and OHS culture will make a significant difference in the development of safety awareness (Dursun & Keser, 2014). In general, the situation seen in the research on the awareness of OHS practices is that the OHS awareness of the employees and managers of the organization increases. The most important reason why the findings are in this direction is that the obligations of OHS Law No. 6331 cover all public institutions as well as the private sector. This situation has led to an increase in scientific studies on OHS practices, and each study has contributed to the development of awareness of OHS practices in all institutions, especially in public and private schools. In addition, Bilir's (2016) study on OHS awareness in Türkiye parallels the conclusion that OHS awareness has increased significantly in recent years.

In the evaluations made by the school administrators regarding the "OHS Material Effectiveness" category, it was determined that "visual materials are understandable and their intelligibility should be improved" for the sub-category of the clarity of visual materials. Evaluations of this subcategory indicate that the material is well understood. In the sub-category of "Visual material effectiveness", school administrators stated that visual materials are effective and that "the effectiveness of visual materials can be improved and visual materials are not effective". The dominant view is that visual materials are not effective. Teaching that appeals to the sense organs will ensure that what is learned is more permanent if it is supported by technologies (Erdemir & Bakırcı, 2016). Therefore, the preparation of visual materials according to the purpose and characteristics of the target audience will increase effectiveness. In particular, in the visual perception process, the quality of the content intended to create the perception, as well as the creation of an effective message system and a successful message system, increase the effectiveness of the visual design. In this direction, while creating the design, it is necessary to create design contents suitable for the different target audience qualities and expectations encountered in the perception process. These designs help to achieve the desired results in line with the effective visual perception process, to receive effective feedback, and to create an effective visual understanding. Determining the target audience characteristics related to visual perception as a center will contribute to solving the problems related to perception and enabling the buyer to use the design effectively (Erişti et al., 2013). In this context, determining the visual materials designed for school in OHS practices in accordance with the qualifications of students and teachers will increase the effectiveness of visual materials. In line with the evaluations of the school administrators, it was stated that the teachers were sufficient in the use of OHS tools and equipment (fire extinguisher, warning signs, safety strips, etc.), but the students were not sufficient at the desired level. To eliminate this negative situation, it is thought that teachers should undertake the task of safety coaching in the use of tools and equipment, since they are closer to the students. With the help of the obtained data, this method will help eliminate the problems in the use of missing OHS materials by teachers and students.

According to Kılış and Demir (2012), who reached similar results, using visual tools (working in newspapers or magazines, using posters with plenty of pictures, creating security boards) to ensure the continuity of the information obtained after OHS training increases the

effectiveness of OHS. According to many research findings, the use of materials increases learning success (Kaplan et al., 2013). In the studies, it can be stated that the increase in material intelligibility in OHS practices greatly increases the awareness of accidents and risk factors. In OHS practices in schools, it was emphasized that OHS awareness should be developed more in students than in administrators and teachers. The findings obtained in this study confirm this. The use of OHS visual materials in OHS trainings indirectly increases the effectiveness of OHS materials. Bayram's (2020) study, in which he investigated the quality of online OHS trainings, emphasized that the effectiveness of OHS trainings, supported by visual content and expressed in fluent narratives, which were constructed in an immersive way, would increase.

In the OHS managerial effectiveness category, the evaluations made by school administrators are expressed in subcategories of managerial duty and responsibility awareness, administrative problems, and solutions. In the evaluations made in these subcategories, it was seen that there was no sense of duty and responsibility. Management, systematic and scientific knowledge community; refers to an application and a set of activities or processes (Mucuk, 2008). In this context, the development of a sense of responsibility in management requires a systematic approach to the scientific processes of the subject being managed. Therefore, it is necessary for school administrators to receive adequate training on OHS practices. The efficiency and effectiveness of an organization depend on the degree to which it can achieve its goals. This can only be achieved through the harmonious operation of organizational elements (Genç, 2005). The harmony of teachers, students, and administrators in the school is of great importance in achieving the goals of managed OHS practices. It was emphasized that information, financial, legal, and time resources are of great importance in the approaches of school administrators, especially in the healthier progress of OHS practices. It is seen that the situation is in the same direction as in the studies on the subject. Koç and Topaloğlu (2010) stated that various resources are used during the management process, including human, financial, time, information, and legal resources. It has been emphasized that financial resources, which are the most emphasized resource, are not adequately provided by the MEB during OHS implementations, and these impossibilities create some inadequacies in eliminating some risks. The development of responsibility awareness among school administrators will positively affect the OHS culture in the school. It has been emphasized that a safety culture, which is defined as a product of the thought, value, competence, behavior, and perception models of groups and individuals in an organization, will be formed under the leadership of school administrators (Şensöğüt, 2018). Although OHS management in schools increases the duties and responsibilities imposed on school administrators, the most ideal education and training will be possible with the best managed OHS practices. Odaman stated that the material and moral losses that will occur due to the disruption of education will cause great harm to both the people and the country's economy. Employees are injured, disabled, or killed because of hazards arising from the work environment. Because the neglect of OHS practices greatly increases economic costs, this neglect interrupts the sustainable social and economic development that countries focus on the most (Serin & Çuhadar, 2015).

According to Çay (2019), while some administrators working in schools stated that OHS practices were correct and important, a significant portion of them stated that these practices

were only for show and that necessary studies should be conducted to change this situation. It has been seen that the opinions expressed about the other subcategory, managerial problems and solutions, are evaluated in the center of lack of information, lack of necessary financial resources, not giving the necessary importance, mandatory OHS practices, and high workload. It has been determined that the most expressed opinion among these subcategories is the lack of information and the opinion that the workload, which is close to this opinion, is too high. According to the study of Yılmaz (2009), who has similar findings, the activities related to OHS are carried out under adverse conditions such as training, information, coordination, and lack of experts on the subject. After private sector workplaces were included in the scope of OHS Law No. 6331, public institutions were also included in the scope of this law in 2012. With this law, public administrators had to undertake many legal responsibilities and obligations for which they did not have any knowledge or sufficient technical skills to apply (Akaner, 2022). The article of this law, which is seen as the heaviest of the obligations for managers, places the responsibility of performing the work and transactions related to OHS practices in the workplaces on the public administrators as the employer's representative. This situation can cause managers to have difficulties in determining legal priorities, especially in their work areas. In addition, the law on the employment of OHS professionals who conduct risk analyses to determine risk factors in the working environment is constantly postponed. This may cause managers without sufficient technical knowledge about risk analysis to feel inadequate in detecting situations that may cause security vulnerabilities. In addition, the high workload of school administrators regarding both education and OHS may cause a decrease in their awareness of taking responsibility for OHS practices. It is thought that it would be more beneficial to evaluate the findings of the research on the subject with these deficiencies.

The views on the category of teacher and student OHS attitudes and behaviors are that teachers' attitudes and behaviors can be positive or negative and change according to the individual (Dursun & Keser, 2014). In this respect, it is seen that the attitudes of school administrators toward OHS are positive, and this is reflected in their behaviors positively. It is significant, but not sufficient, that school administrators have good attitudes and behaviors toward OHS. Administrators need to reflect this on the school culture as well. Organizational culture has an important place in the dissemination of behaviors to the public. In particular, Nielsen (2014), it states that human behavior is closely related to culture, and in countries where the occupational safety culture is high, occupational accident rates are seen at very low levels. In this context, with the help of the attitudes reflected in the school safety culture, the behavior of school staff, teachers, and students will be developed in this direction, thus provide protection from OHS risk factors and dangerous situations.

Teachers' attitudes and behaviors need to be improved. For this reason, the duties, responsibilities, and OHS training that school administrators will give to teachers regarding OHS practices in schools will help teachers gain OHS awareness and contribute to the positive development of OHS attitudes and behaviors (Türüdü, 2019). It has been stated that the most important factors that determine and guide the safe behaviors of the employees are the thoughts, attitudes, behaviors, and perceptions of the organization management about OHS. It has been observed that with the increasing importance given by the management to OHS practices, the sensitivity of the employees to OHS regulation procedures, equipment use, and

training has also increased (Can & Hüseyinli, 2017). When the findings of the study are examined in this context, it is thought that the positive changes in the OHS attitudes and behaviors of teachers and students depend on the approaches of the school administration. According to the study of Öztürk (2020), which was carried out in schools where the management's OHS approaches are good, it was observed that vocational high school students with school management who aim to create a good OHS culture comply with the OHS rules. In addition, it has been observed that they have knowledge about OHS, and their attitudes and behaviors toward OHS practices have changed positively.

When we look at the opinions of school administrators about how epidemics, such as pandemics, affect the perspective on OHS practices, the general opinion is that the pandemic period positively affects the perspective on OHS practices. During the pandemic period, serious measures were taken all over the world and in our country. After the first case appeared in our country on 11.03.2020, on 13.03.2020, primary and secondary schools and universities were suspended throughout the country, and the activities of all places where people could be found together were suspended. It has been shown in international and domestic research that breaks in education have great negative effects on student education and training. According to the research results of Carlsson et al., 1% of the standard deviation values obtained because of ten days of additional training significantly increase the crystallized intelligence scores in information use tests. It has been determined that 6% of the standard deviation value is lost due to the effect of school closures, i.e., 12 weeks less education. In the same vein, Lavy et al., (2015), states that the duration of education has a significant effect on test score values and emphasizes that this situation differs between countries (Burgess & Sievertsen, 2020, as cited in Balci, 2020). In the study conducted by Aytaç (2020), school administrators stated that during the pandemic process, school administrators experienced problems such as not being able to provide students with motivation to learn and parents not being able to create a learning environment for students at home. Furthermore, children under quarantine experienced four times more stress as well as psychological and behavioral problems. In this direction, it is thought that instead of stopping or interrupting education to protect from the effects of the pandemic, it will be more effective and beneficial to develop a health and safety culture by focusing on OHS practices. It was seen that this situation was in the same direction as the school administrators expressed. Emphasizing that the measures taken due to the seriousness of the issue will vary according to the sectors, eleven guides have been published by the Ministry of Health Science Board on this issue. According to this guide, the recommended measures were shared with the public, considering the working environments, the characteristics of the work, and the working conditions, and the employer was held liable for taking these measures (Ateş, 2020). Therefore, school principals who work as employers' representatives in schools are also under this obligation. Taking these measures has once again emphasized the seriousness of the OHS practices managed in organizational environments, and it has been observed that the culture of safety and health continues even in environments where OHS management is applied or not.

Töre et al. (2021), state that the pandemic period has improved the process of complying with the hygiene rules in OHS practices and created a serious awareness among school stakeholders, and that the hygiene measures taken can be highly standardized. Dilaver

(2020), in his study on the impact of the covid-19 pandemic process on OHS practices, stated that the general views of the research participants were that both employers and employees increased their OHS awareness during this period. In addition, it was stated that due to the increase in the sensitivity of the employees to the OHS rules, a decrease in occupational accidents, compliance with the hygiene rules, improvement in the communication of the employees with the OHS professionals, and an increase in the desire of the employees to take responsibility for OHS were observed. In the study of Can and Hüseyinli (2017) on the OHS culture in the working environment, as the safety needs and personal priorities of the employees in OHS issues increased, the efforts of the employees to the OHS procedures, supporting and applying the OHS regulation rules, and the use of OHS equipment increased. In addition, it has been observed that safe behaviors such as the desire to perform additional tasks for OHS practices and the desire to participate in activities have increased. It is seen that the 'security need' in Maslow's hierarchy of needs increases especially during periods when health and safety situations such as natural disasters are at risk. It has been determined that all the safe behaviors related to OHS in general in the pandemic period research findings are in line with the findings of this study, not only as a legal obligation but also willingly.

Recommendations

Training to be given to administrators and school staff by OHS experts may be more accurate for OHS objectives.

Information on OHS process practices in other sectors can be exchanged.

Assistance can be obtained from the OSGB for the methods followed in the school OHS practices of the provincial and district organizations of the MoNE.

The Occupational Health and Safety Management System can be developed only for schools.

Studies on school safety coaching can be conducted.

References

- Akaner, Ö. (2022). *6331 sayılı iş sağlığı ve güvenliği kanunu perspektifinde kamu kurumlarına yönelik iş sağlığı ve güvenliği yönetim sistemi önerisi* [Occupational health and safety management system proposal for public institutions in the perspective of the occupational health and safety law (Act. No. 6331)]. (Publication No. 751620) [Doctoral dissertation, Gazi University]. National Thesis Center.
- Akbulut, V. (2021). *Ortaokul ve lise öğrencilerinin dönüşümsel liderlik alguları beden eğitimi dersi yatkınlıkları ve motivasyonlarının karma yöntem aracılığıyla incelenmesi* [An investigation of middle and high school students' transformational leadership perceptions, predisposition and motivation for physical education lessons through mixed method]. (Publication No. 671268) [Doctoral dissertation, Trabzon University]. National Thesis Center.
- Akpınar, T., & Öğütoğulları, E. (2016). OHSAS 18001 iş sağlığı ve güvenliği yönetim sistemi [OHSAS 18001 occupational health and safety management system]. *Balkan and Near East Journal of Social Sciences*, 2(3).
- Arastaman, G., Fidan, İ., & Fidan, T. (2018). Nitel araştırmada geçerlik ve güvenilirlik: Kuramsal bir inceleme [Validity and reliability in qualitative research: A theoretical analysis]. *YYU Faculty of Education Journal*, 15(1), 37-75.
- Aytaç, T. (Ed.). (2020). *Eğitim hukuku* [Education Law]. Pegem.
- Balcı, A. (2020). Covid-19 özelinde salgınların eğitime etkileri [In covid-19 special the effect of pandemics on education]. *International Journal of Leadership Studies: Theory and Practice*, 3(3), 75-85.
- Baltacı, A. (2019). Nitel araştırma süreci: Nitel bir araştırma nasıl yapılır? [The qualitative research process: How to conduct a qualitative research?]. *Journal of Ahi Evran University Institute of Social Sciences*, 2(5), 368-388.
- Bayram, M. (2020). Uzaktan iş sağlığı ve güvenliği eğitim kalitesinin katılımcıların memnuniyet algıları üzerinde etkisi [The effect of occupational health and safety distance training quality on the perception of satisfaction of the participants]. *The Journal of Social Sciences*, 4(7), 110-120.
- Bilir, N. (2016). *İş sağlığı ve güvenliği profili: Türkiye* [Profile of occupational health and safety: Türkiye]. Çalışma ve Sosyal Güvenlik Bakanlığı. Retrieved October 17, 2023 <https://www.csgb.gov.tr/medias/4578/kitap09.pdf>
- Burgess, S., & Sievertsen, H. H. (2020). Schools, skills, and learning: The impact of covid-19 on education. VoxEU.Org. Retrieved October 25, 2023, from <https://voxeu.org/article/impact-covid-19-education>
- Büyüköztürk, Ş. (2012). *Sosyal bilimler için veri analizi el kitabı* [Manual of data analysis for social sciences]. Pegem.
- Can, M., & Hüseyinli, N. (2017). Çalışma hayatında iş sağlığı ve güvenliği kültürü ve otel çalışanlarının güvenli davranışlarının incelenmesi [Analysis of occupational health and safety culture in the work life and the safe behavior of hotel workers]. *Journal of Atatürk University Institute of Social Sciences*, 21(4), 1397-1420.
- Carlsson, M., Dahl, G. B., Öckert, B., & Rooth, D. O. (2015). The effect of schooling on cognitive skills. *The Review of Economics and Statistics*, 97(3), 533-547.
- Creswell, J. W. (2017). *Araştırma deseni* [Research design]. Eğiten Kitap.
- Çay, E. (2019). Özel eğitim okulu yöneticilerinin iş sağlığı ve güvenliğine yönelik görüşleri [Opinions of managers working in special education school about occupational health and safety]. *Education Sciences*, 14(1), 1-16.
- Çetindağ, Ş. (2010). İş sağlığı ve güvenliğinin tarihsel gelişimi ve mevzuattaki güncel durum [Historical development of occupational health and safety and current situation in legislation]. *Toprak İşveren Journal*, 86, 1-6.

- Demir, G. (2006). *İş sağlığı ve güvenliğinin sağlanmasında iş yeri ISG kurullarının etkinliği* [Effectiveness of work place occupational health and safety committees to provide occupational health and safety (OHS)]. (Publication No. 187306) [Master thesis, Uludağ University]. National Thesis Center.
- Dilaver, İ. (2020). *Covid-19 pandemisi sırasında iş sağlığı ve güvenliği uygulamalarının değerlendirilmesi* [Evaluation of occupational health and safety practices during the covid-19 pandemic]. (Publication No. 652179) [Doctoral dissertation, Trabzon University]. National Thesis Center.
- Dursun, S., & Keser, A. (2014). İş güvenliği farkındalığı ve iş güvenliği davranışları arasındaki ilişkilerin araştırılması: Uygulamalı bir araştırma [Researching the relations between awareness of labour safety and labour safety behaviours: An applied research]. *Journal of Labor Relations*, 5(2), 1-9.
- Erdemir, N., & Bakırcı, H. (2016). Öğretmen adaylarının öğretim elemanlarından bilgi teknolojilerini kullanma konusunda beklentileri [Expectations of preservice teachers from university professors in terms of use of instructional technology]. *Van Yüzüncü Yıl University Journal of the Faculty of Education*, 13(1), 275-300.
- Erişti S. D., Uluuysal B., & Dindar, M. (2013). Görsel algı kuramlarına dayalı etkileşimli bir öğretim ortamı tasarımı ve ortama ilişkin öğrenci görüşleri [Designing an interactive learning environment based on theories of visual perception and students' views about the software]. *Anadolu Journal of Educational Sciences International*, 3(1), 47-66.
- Ersoy, A. F., & Saban, A. (Eds.). (2017). *Fenomenoloji* [Phenomenology]. Anı.
- Genç, N. (2005). *Yönetim ve organizasyon* [Management and organization]. Seçkin.
- Guba, E. G. (1981). Criteria for assessing the trustworthiness of naturalistic inquiries. *Educational Technology Research and Development*, 29, 75-91.
- Kağıtçıbaşı, Ç. (2010) *Günümüzde insan ve insanlar* [People and human nowadays]. Evrim.
- Kaplan, Z., Topan, B., & Erkan, B. (2013). Sınıf içi öğretimde materyal kullanımının etkililik düzeyi: Bir meta-analiz çalışması [The effectiveness level of material use in classroom instruction: A meta-analysis study]. *Journal of Educational Sciences in Theory and Practice*, 13(3), 1629-1644.
- Kılış, İ. (2014). 6331 sayılı kanunda iş güvenliği uzmanlığı: Nitelikleri, görevlendirilmeleri ve yetkilendirilmeleri [Occupational safety experts in the law no 6331: Qualifications, assignments and authorizations]. *SGD-Social Security Journal*, 4(2), 32-67.
- Kılış, İ., & Demir, S. (2012). İşverenin iş sağlığı ve güvenliği eğitimi verme yükümlülüğü üzerine bir inceleme [A review at the obligation of the employer to provide training related to occupational health and safety]. *Journal of Labor Relations*, 3(1), 23-47.
- Koç, H., & Topaloğlu, M. (2010). *Yönetim bilimi* [Management science] Seçkin.
- Koç, Y. (2017). Sosyal bilimlerde örnekleme kuramı [Sampling theory in social sciences]. *Academic Journal of Social Studies*, 5(47), 480-495.
- Lavy, V. (2015). Do differences in schools' instruction time explain international achievement gaps? Evidence from developed and developing countries, *Economic Journal*. 125, 397-424.
- Law on Occupational Health and Safety (2012, June 30). *Official gazette of the republic of Türkiye*. Retrieved September 14, 2023, from <https://www.resmigazete.gov.tr/eskiler/2012/06/20120630-1.htm>
- Lincoln, Y. S., & Guba, E. G (1988). *Criteria for assessing naturalistic inquiries as reports* (ED297007). ERIC. <https://files.eric.ed.gov/fulltext/ED297007.pdf>
- Miles, M. B., & Huberman, A. M. (1994). *Qualitative data analysis: An expanded sourcebook* (2nd ed.). Sage.

- Ministry of National Education Statistics (2020). 2020-2021 *National education statistics* (No. 1300-0993). Retrieved June 18, 2023, from http://sgb.meb.gov.tr/meb_iys_dosyalar/2021_09/10141326_meb_istatistikleri_orgun_egitim_2020_2021.pdf.
- Ministry of National Education Support Services Department Occupational Health and Safety Circular in Schools. (2014, August 19). *MEB mevzuat* [MoNE circular] 2014/16 (No: 3450084). Retrieved June 13, 2023, from <http://mevzuat.meb.gov.tr/dosyalar/1705.pdf>
- Mucuk, İ. (2008). *Modern işletmecilik* [The modern business]. Türkmen.
- Nielsen, K. J. (2014). Improving safety culture through the health and safety organization: A case study. *Journal of Safety Research*, 48(2014), 7-17.
- Öztürk, Y. (2020). Meslek lisesi öğrencilerinin iş sağlığı ve güvenliği hakkındaki tutumları [The attitudes of vocational high school students on occupational health and safety]. *International Journal of Advances in Engineering and Pure Sciences*, 2(2020), 111-117.
- Patton, M. Q. (1990). *Qualitative research and evaluation methods*. Sage.
- Patton, M. Q. (2002). *Qualitative research and evaluation methods* (3rd ed.). Sage.
- Serin, G., & Çuhadar, T. (2015). İş güvenliği ve sağlığı yönetim sistemi [Occupational health and safety management systems]. *SDU Journal of Technical Sciences*, 5(2), 44-59.
- Shenton, A. K. (2004). Strategies for ensuring trustworthiness in qualitative research projects. *Education for Information*, 22, 63-75.
- Stephens, R. D. (1998). Safe school planning. In D. S. Elliott, B. Hamburg & K. R. Williams (Eds.), *Violence in American schools: A new perspective*. (pp. 253-289). Cambridge University.
- Şensöğüt, C. (2018). İş güvenliği kültürü ve üniversiteler [Occupational safety culture and universities]. *Soma Vocational School Journal of Technical Sciences*, 1(25), 9-15.
- Taşdemir, G., & Gür, B. (2021). Sınıf öğretmenlerinin iş sağlığı ve güvenliği öz yeterliği (Iğdır ili örneği) [The self-efficacy of primary teachers on occupational health and safety: (Iğdır province example)]. *International Journal of Advances in Engineering and Pure Sciences*, 33(3), 467-477.
- Töre, E., Çilek, A., & Çetin, E. (2021). Covid-19 pandemisi sürecinde okul yönetimlerinin Millî Eğitim Bakanlığı hijyen kontrol kılavuzuna uyma durumlarının incelenmesi [Examining the compliance of school administrations to the Ministry of National Education hygiene control guide during the covid-19 pandemic process]. *e-Caucasian Journal of Educational Research*, 8, 233-254.
- Türüdü, N. O. (2019). *Öğretmenlerin iş güvenliği kültürü ile okula yönelik tutumları arasındaki ilişki* [The relationship between teachers' occupational safety culture and school attitudes]. (Publication No. 530249) [Doctoral dissertation, İstanbul Sabahattin Zaim University]. National Thesis Center.
- Wynd, C. A., Schmidt, B., & Schaefer, M. A. (2003). Two quantitative approaches for estimating content validity. *Western Journal of Nursing Research*, 25, 508-518.
- Yıldırım, A., & Şimşek, H. (2008). *Sosyal bilimlerde nitel araştırma yöntemleri* [Qualitative research methods in the social sciences]. Seçkin.
- Yıldırım, A., & Şimşek, H. (2016). *Nitel araştırma yöntemleri* [Qualitative research methods]. Seçkin.
- Yılmaz, F. (2009). *Avrupa birliği ve Türkiye'de iş sağlığı ve güvenliği: Türkiye'de iş sağlığı ve güvenliği kurullarının etkinlik düzeyinin ölçülmesi* [Occupational health and safety in the European Union and Turkey: An evaluation of effectiveness occupational health and safety committees in Turkey]. (Publication No. 261926) [Doctoral dissertation, İstanbul University]. National Thesis Center.

BIOGRAPHICAL NOTES

Contribution Rate of Researchers

Author 1: 50%

Author 2: 50%

Conflict Statement

There is no conflict of interest that the authors will declare in the research.



Okul İş Sağlığı ve Güvenliği Uygulamaları Performans Göstergelerinin Okul Yöneticileri Tarafından Değerlendirilmesi

Özet

Bu çalışmanın amacı okul yöneticilerinin İSG uygulamasının etkililiğine ilişkin görüşlerini ortaya koyarak okul İş Sağlığı ve Güvenliği [İSG] performans göstergelerini belirlemektir. Bu amaç doğrultusunda yarı yapılandırılmış görüşme formu oluşturulmuştur. Amaçlı örnekleme yöntem türlerinden biri olan ölçüt örnekleme ile belirlenmiş Millî Eğitim Bakanlığına [MEB] bağlı 50 ve daha fazla çalışanı olan kamu ve özel okullar ile ilk, orta ve liselerde görev yapan on okul yöneticisine uygulanmıştır. Analizler sonucunda altı ana kategoriye (İSG Eğitim Etkililiği, İSG Bilinci, İSG Materyal Etkililiği, İSG Yönetimsel Etkililiği, Öğretmen ve Öğrenci İSG Tutum ve Davranışları, Pandemi İSG Etkililiği) ulaşılmıştır. İSG Materyal Etkililiği ana kategorisi üç alt kategoriye (Görsel Materyal Anlaşılabilirliği, Görsel Materyal Etkililiği, İSG Materyal Kullanımı Yeterliliği) ayrılmıştır. İSG Yönetimsel Etkililik ana kategorisi "Yönetimsel Görev ve Sorumluluk Bilinci" ve "Karşılaşılan Yönetimsel Sorunlar ve Çözümleri" olarak iki alt kategoriye ayrılmıştır. Bulguların okul İSG performans göstergesinin oluşturulmasına büyük katkı sağlayacağı düşünülmektedir. Araştırmacılara İş Sağlığı ve Güvenliği Yönetim Sisteminin [OHSAS] sadece okullar için uygulanabilecek bir sürümü geliştirilebileceği ve okul güvenliği koçluğu konusunda çalışmalar yapılabileceği önerisinde bulunabilir.

Anahtar Kelimeler: Performans, iş sağlığı ve güvenliği, okul iş sağlığı ve güvenliği, öğretmen.

Giriş

"İş güvenliği" kavramı çalışanların teknik risklere karşı korunmasını ifade ederken, "iş sağlığı" ise tüm çalışanların fiziksel, zihinsel, sosyal, ahlaki ve iyilik hallerinin en üst düzeyde tutulması ve sürdürülmesi anlamına gelmektedir. İşyerlerinde bunu başarmak için kötü sağlık koşullarını ortadan kaldırmak ve olumsuz koşullardan korunmak gerekir. Çalışanlar beden ve ruhen uygun işlere yerleştirilmeli, işin kişiye göre uyarlanması ve kişinin işe uyumu sağlanmalıdır. İş güvenliği ise işyerlerinde iş uygulamaları nedeniyle ve iş sırasında meydana gelebilecek hasar ve arızaların araştırılarak ortadan kaldırılması ve işin sürekliliğinin sağlanması amacıyla yapılan teknik ve sistematik çalışmalar olarak tanımlanmaktadır (Demir, 2006).

Yirminci yüzyılda iş sağlığı ve güvenliğine ilişkin gelişmeler tüm dünyayı ilgilendiren bir konu haline gelmiştir. Birleşmiş Milletler [BM] bünyesindeki Uluslararası Çalışma Örgütü [ILO], İSG ile ilgili konularda önemli çalışmalar yürütmektedir. 1946 yılında BM ile ILO arasında imzalanan anlaşmayla ILO bir ihtisas kuruluşu haline gelmiştir. ILO ve Dünya Sağlık Örgütü [DSÖ] ve bu kuruluşlarla iş birliği yapan birçok kuruluş iş sağlığı ve güvenliği açısından önemli çalışmalar yürütmektedir. Ülkemizin de üyesi olduğu ILO'nun kimyasal maddeler için belirlediği "işyerinde maruz kalma değerleri", iş sağlığı ve güvenliği konusunda alınan kararlar ve oluşturulan uluslararası anlaşmalar İSG sorunlarının çözümüne katkı sağlamıştır. Avrupa Birliği'nin, Aralık-1999'daki zirvesinde, Türkiye'ye adaylık statüsünün tanınmasıyla birlikte, 2003 yılında 4857 sayılı İş Kanunu çıkarılmıştır. Bu kanunun iş sağlığı ve iş güvenliği ile ilgili hükümleri, belki birkaç madde dışında, aynen 1475 sayılı İş Kanunundan aktarılmıştır. Ancak,

4857 sayılı İş Kanunu'na göre çıkarılması gereken yönetmelikler, Avrupa Birliğinin 89/391/EEC sayılı çerçeve direktifine ve diğer bireysel 28 direktiflere göre uyumlaştırılmıştır ve 2003 yılı ile 2004 yılı içerisinde art arda yayımlanmıştır (Çetindağ, 2010).

6331 sayılı İş Sağlığı ve Güvenliği Kanunu'nun 4. maddesi uyarınca işveren, İSG ile ilgili sağlık ve güvenlik önlemlerine uyulup uyulmadığını denetlemek ve ortaya çıkan sorunların çözümlenmesini sağlamakla yükümlüdür. Bu kanunun risk değerlendirmesine ilişkin 10'uncu maddesine göre çalışma ortamının ve çalışanların İSG açısından maruz kaldığı risk faktörlerinin ortadan kaldırılması için gerekli kontrol, ölçüm ve incelemelerin yapılması gerekmektedir. İş Sağlığı ve Güvenliği Kurulları Yönetmeliği'nin 8. maddesine göre İSG kurullarının temel görevi, kurumun niteliğine uygun taslak İSG iç yönergesi hazırlayarak işveren veya işveren vekili onayına sunmaktır. Hazırlanan yönetmeliğin uygulanmasının gözlemlenmesi, gözlem sonuçlarının raporlanması, alınacak önlemlerin belirlenmesinin sağlanması, işyerinin İSG ile ilgili mevcut durumu hakkında yıllık rapor hazırlanması, bir önceki yıla ilişkin çalışmaların değerlendirilmesi ve iş birliği yapılması diğer kurumlarla ilişkiler de bu kurulların diğer görevleri arasındadır (İş Sağlığı ve Güvenliği Kanunu, 2012).

İSG uygulamaları, eğitim kurumlarında çalışanları ve öğrencileri stres, kaygı ve tehlikelerden uzak tutarak güvenli bir eğitim ve çalışma ortamı sağlar. Bu durum okulu oluşabilecek tehlike ve risklerden arındırarak bireylere güvenli bir okul ortamı sağlayacaktır. Öğretmen, öğrenci ve personelin fiziksel ve psikolojik rahatlık ve huzur duygusu okul güvenliği kavramıyla ifade edilmektedir. Bu nedenle İSG uygulamalarıyla oluşturulacak güvenli bir okul ortamı, bireylerin kendilerini daha rahat hissetmeleri ve performanslarını en iyi şekilde göstermeleri açısından önemli görülmektedir (Çay, 2019).

Okul güvenliği planının amacı, başarının ödüllendirildiği ve tüm öğrencilerin tehlikelerden, şiddetten, zararlı bağımlılıklardan ve korkudan uzak, öğretmenlerin öğretebileceği ve öğrencilerin de öğrenebileceği bir ortamda gelişeceği bir okul iklimi yaratmak ve sürdürmektir (Stephens, 1998). Okul yöneticilerinin okul güvenliği konusunda yapması gereken uygulamalar, okulun iklimi, kültürü ve eğitim kalitesi açısından gerekli önlemlerin alınmasıdır. Okul güvenliğine yönelik yapılan planların amacı budur.

Okullarda uygulanan İSG uygulamaları ve sonuçlarına ilişkin çalışmalar yapılmış ancak İSG'nin uygulandığı diğer sektörlerde kullanılan ve İSG uygulamalarının etkililiğinin belirlenmesini, eksikliklerinin ortaya çıkarılmasını sağlayan İSG performansına ilişkin herhangi bir çalışmaya rastlanmamıştır. Bu bağlamda okul yöneticilerinin, öğretmenlerinin, öğrencilerin ve çalışanların İSG konusundaki farkındalık düzeyleri ile İSG uygulamalarına ilişkin görüşleri gibi konularda İSG yönetiminin yeterince etkili olup olmadığını değerlendirecek bir performans ölçeğinin geliştirilmesinin gerekli olduğu ve yöneticilere büyük katkı sağlayacağı düşünülmektedir. Bu amaç doğrultusunda okullardaki İSG uygulamalarının derinlemesine incelenmesi ve durum tespitinin yapılması İSG performans ölçeği geliştirme çalışmalarına büyük katkı sağlayacağı düşünülmektedir.

Yöntem

Nitel araştırma yöntemi ile araştırılmak istenen durumun derinlemesine analizinin yapılması istenmiş ve bu doğrultuda çalışma, istenilen olgunun derinlemesine incelenmesine olanak sağlayan 'fenomenoloji' tasarımı ile gerçekleştirilmiştir. Bu örüntü, bildiğimiz ancak detaylı ve derinlemesine bir anlayışa sahip olmadığımız olgulara odaklanmaktadır (Yıldırım & Şimşek, 2016). Fenomenolojik araştırma iki şekilde ele alınır. Bunlar betimleyici ve yorumlayıcı fenomenoloji yaklaşımlarıdır. Araştırmanın temel amacı araştırmaya katılan okul yöneticilerinin İSG uygulamalarına ilişkin görüş ve deneyimlerini betimlemek olduğundan betimsel fenomenoloji tercih edilmiştir (Ersoy, 2017). Bu bağlamda okul yöneticilerinin İSG uygulamalarını derinlemesine incelemek amacıyla yarı yapılandırılmış görüşme formu uygulanmıştır. Elde edilen veriler NVIVO programında analiz edilmiştir. Araştırmanın evreni İstanbul genelinde 50 ve daha fazla çalışanı bulunan ve İSG uygulamaları yapan okullar olarak belirlenmiştir (İş Sağlığı ve Güvenliği Kanunu, 2012). Evrenin tamamına ulaşmak zaman ve imkanlar doğrultusunda mümkün olmadığından nüfus evrendeki ağırlığıyla orantılı örneklem belirlenmiştir (Yıldırım & Şimşek, 2008). 2021–2022 eğitim-öğretim yılında İstanbul'un 39 ilçesinin 25'i (%64.1) Avrupa Yakasında, 14'ü (%35.9) Anadolu Yakasında yer almaktadır (Millî Eğitim Bakanlığı İstatistikleri, 2020). Bu oran içerisinde Türkiye'deki tabaka veya alt grupları temsil etmeyi amaçlayan örnekleme türü olan 25/39 ve 14/39 oranlarında tabakalı örnekleme yöntemi kullanılarak Avrupa Yakasından altı, Anadolu Yakasından ise üç ilçe belirlenmiştir. Seçilen tabakaların oranları dahilinde, İstanbul'daki ilçeler basit tesadüfi örnekleme yöntemleri kullanılarak kura ile seçkisiz olarak belirlenmiştir (Büyüköztürk vd., 2012, akt. Koç, 2017). Avrupa Yakasından altı ilçe (Esenyurt, Silivri, Bahçeşehir, Fatih, Büyükçekmece, Esenler), Anadolu Yakasından üç ilçe (Kadıköy, Üsküdar, Kartal) seçilmiştir. İSG mevzuatına (Millî Eğitim Bakanlığı [MEB], 2014) uygun olarak 50 ve daha fazla çalışanı olan okullarda okul yöneticisinin işveren vekili olarak görevlendirildiği belirtildiğinden, çalışma grubuna katılım kriteri 50 ve daha fazla çalışanı olan okul yöneticisi olma şartı esas alınmıştır. İlköğretim okulları, ortaokullar, fen liseleri, anadolu liseleri, meslek liseleri ve imam hatip okullarında, amaçlı örnekleme yöntemlerinden biri olan ölçüt örnekleme (Patton, 1990) ile 50 ve daha fazla çalışanı olan okullar tesadüfi olarak belirlenmiştir. Seçilen okullarda nitel araştırma amacıyla hazırlanan yarı yapılandırılmış görüşme formu, bu okullarda çalışma grubu olarak belirlenen okul yöneticilerine uygulanmıştır. Creswell'e (2017) göre fenomenolojide formun uygulanacağı katılımcı sayısı 3 ile 10 arasında olmalıdır. Bu bilgiler doğrultusunda belirtilen okullarda görev yapan 10 okul yöneticisi çalışmaya dahil edilmiştir.

Araştırmanın Etik İzinleri:

Bu çalışmada "Yükseköğretim Kurumları Bilimsel Araştırma ve Yayın Etiği Yönergesi" kapsamında uyulması gerektiği belirtilen tüm kurallara uyulmuştur. Yönergenin ikinci bölümü olan "Bilimsel Araştırma ve Yayın Etiğine Aykırı Eylemler" başlığı altında belirtilen eylemlerin hiçbiri gerçekleştirilmemiştir.

Etik Kurul İzin Bilgileri:

Etik değerlendirmeyi yapan kurulun adı = Kırşehir Ahi Evran Üniversitesi Sosyal ve Beşeri Bilimler Bilimsel Araştırma ve Yayın Etik Kurulu

Etik kurul etik inceleme karar tarihi= 25.03.2022

Etik değerlendirme belgesi konu numarası= 2022/03/45

Bulgular

Analizler sonucunda altı ana kategoriye ulaşılmıştır: İSG Eğitim Etkinliği, İSG Bilinci, İSG Materyal Etkililiği, İSG Yönetmel Etkililiği, Öğretmen ve Öğrenci İSG Tutum ve Davranışları, Pandemi İSG Etkililiği. İSG Materyal Etkililiği ana kategorisi üç alt kategoriye ayrılmıştır: “Görsel Materyal Anlaşılabilirliği”, “Görsel Materyal Etkililiği”, “İSG Materyal Kullanımı Yeterliliği”. İSG Yönetmel Etkililiği: “Yönetimsel Görev ve Sorumluluk Bilinci” ve “Karşılaşılan Yönetmel Sorunlar ve Çözümleri” olmak üzere iki alt kategoriye ayrılmıştır.

Tartışma ve Sonuç

Okul müdürlerinin İSG Eğitim Etkinliği kategorisine ilişkin görüşleri incelenmiş ve genel görüşler İSG eğitimlerinin etkili olmadığı yönünde değerlendirilmiştir. Örgüt ortamındaki tehlike ve risklerden korunabilmek için örgüt çalışanlarına İSG eğitimleri verilmelidir (Akpınar & Ögütoğulları, 2016). Yapılan değerlendirmelerde, okul yöneticilerinin uygulanan İSG eğitimlerini yeterince etkili bulmadıkları ve “Etkili hale getirmek için neler yapılabilir?” yönünde yapılan yorumlarda, ihtiyaçların belirlenmesi ve bu doğrultuda eğitimlerin yapılmasının gerekliliği vurgulanmıştır. Okul yöneticilerinin İSG eğitimlerinin iyileştirilmesine yönelik yaptığı yorumların özellikle eğitimlerin yetkin kişiler tarafından verilmesi doğrultusunda olduğu tespit edilmiştir. Bu doğrultuda eğitim programlarının uygulanabilmesi için belirli yeterliliklere sahip profesyonellere ihtiyaç duyulmaktadır. Bu profesyonellerin iş güvenliği uzmanı, alan uzmanı, işyeri hekimi, amir, koordinatör veya bu alanda eğitim almış çalışanlar olması gerektiği düşünülmektedir. Okullarda yürütülen İSG eğitimlerinin okul paydaşlarının İSG tutum ve davranışları üzerinde büyük etkisi olduğu, özellikle okul yöneticilerinin İSG eğitim sürecinin yönetiminde görsel içeriklerin yanı sıra örnek olay çalışmaları ve uygulamalı anlatımlara da yer verilmesi amaca ulaşılmasında büyük katkı sağlayacağı görülmüştür. İSG eğitimlerinin İSG uygulamalarına katkısının yanı sıra güvenlik bilincini artırıcı etkisinin de olduğu görülmektedir. Özellikle Dursun (2014), çalışma ortamlarında güvenlik bilinci ile İSG davranışları arasındaki ilişkiyi araştırmış ve güvenlik bilincinin geliştirilmesinde İSG eğitimlerinin büyük önem taşıdığını belirlemiştir. Ayrıca mevcut durumdaki eksikliklerin giderilmesi için iş güvenliği ve güvenli davranışın önemini eğitimin her aşamasında vurgulanması gerektiği, İSG eğitimlerinin güvenli davranış ve İSG bilinci ile ilgili faydalarının yanı sıra çalışma ortamında İSG kültürünün gelişmesine de katkı sağlayacağı belirtilmiştir. Genel olarak İSG eğitimlerinin ya yapılmadığı ya da eksik olduğu, İSG eğitimlerinin çalışma ortamındaki kazaların ve risk faktörlerinin önlenmesine katkı sağlamadığı, İSG uygulamalarının asıl amacına hizmet edemediği vurgulanmıştır. Yılmaz (2009), Türkiye’de İSG ile ilgili en önemli konunun İSG eğitimleri olduğunu ancak gerekli önemin gösterilmediğini belirtmiştir. İSG eğitimlerinin etkililiğine vurgu yapılmasının İSG eğitimlerindeki eksikliklerin giderilmesinde faydalı olacağı düşünülmektedir. Bulgular, İSG

eğitim eksikliklerinin sonuçlarına odaklanırken, bu eğitimlerin verilmesinde ve yürütülmesinde görev alan yönetim kademesi veya işveren temsilcilerinden pek bahsedilmediği ayrıca İSG eğitim içeriğine ve okul yöneticilerine yönelik yol gösterici bir çalışmanın da bulunmadığı görülmektedir. Çalışmanın bu durumdan kaynaklanan eksikliklerin giderilmesinde yol gösterici olacağı düşünülmektedir.

İSG bilinci konusunda okul müdürleri, okul paydaşlarının konuya ilişkin farkındalığının yeterli olduğunu, yapılan uygulamaların öğretmenlerin farkındalık düzeyini artırdığını ifade etmiştir (Dursun, 2014). Okul yöneticilerinin İSG bilincine ilişkin yaptıkları yorumlar doğrultusunda özellikle öğretmenlerin güvenlik farkındalıklarının kıdem ve yıla bağlı olarak arttığı gözlemlenmiştir. Bu doğrultuda genç öğretmenlerin İSG uygulaması noktasında yeterli hassasiyete sahip olmadıkları, dolayısıyla yaşanan risk durumlarında istenilen güvenli davranışların gözlemlenmediği tespit edilmiştir. Ayrıca Dursun ve Keser'e (2014) göre örgütte çalışanların güvenlik farkındalıkları iş güvenliği davranışları üzerinde etkili bir faktördür ve çalışanların güvenlik farkındalıkları arttıkça güvenlikle ilgili konulara daha fazla katılım göstermektedirler. Dolayısıyla çalışanların güvenlik bilincini artırıcı faaliyet ve düzenlemelerin iş kazalarının azaltılmasında büyük önem taşıdığı söylenebilir. Bunun için güvenlik misyonu, sloganlar, materyal yayınlar (kütüphane, istatistik, bültenler vb.), logolar, medya araçlarının etkin kullanımı, etkili İSG eğitimleri ve İSG kültürü, güvenlik bilincinin geliştirilmesinde önemli fark yaratacaktır (Dursun & Keser, 2014).

Okul yöneticilerinin “İSG Materyal Etkililiği” kategorisine ilişkin yaptıkları değerlendirmelerde görsel materyallerin anlaşılabilirliği alt kategorisi için “görsel materyallerin anlaşılır olması ve anlaşılabilirliğinin artırılması gerektiği” tespit edilmiştir. Bu alt kategoriye ilişkin değerlendirmeler konunun iyi anlaşıldığını göstermektedir. “Görsel materyal etkililiği” alt kategorisinde okul yöneticileri “görsel materyallerin etkili olduğunu”, “görsel materyallerin etkililiğinin artırılabilirliğini” ve “görsel materyallerin etkili olmadığını” belirtmişlerdir. Baskın görüşün “Görsel materyallerin etkili olmadığı” bulgusuna ulaşılmıştır. Duyu organlarına hitap eden öğretim, teknolojilerle desteklendiği takdirde öğrenilenlerin daha kalıcı olacağı ifade edilmiştir (Erdemir & Bakırcı, 2016). Bu nedenle görsel materyallerin amaca ve hedef kitlenin özelliklerine göre hazırlanması etkililiği artıracaktır. Özellikle görsel algılama sürecinde algıyı yaratmaya yönelik içeriğin kalitesi, etkili ve başarılı bir mesaj sisteminin oluşturulması görsel tasarımın etkililiğini artırmaktadır. Bu doğrultuda tasarımı oluştururken algılama sürecinde karşılaşılan farklı hedef kitle niteliklerine ve beklentilerine uygun tasarım içeriklerinin oluşturulması gerekmektedir. Bu tasarımlar etkili görsel algılama süreci doğrultusunda istenilen sonuçların elde edilmesine, etkili geri bildirim alınmasına ve etkili bir görsel anlayışın oluşturulmasına yardımcı olmaktadır. Okul yöneticilerinin değerlendirmeleri doğrultusunda öğretmenlerin İSG araç ve gereçlerinin (yangın söndürücü, uyarı levhaları, emniyet şeritleri vb.) kullanımında yeterli oldukları ancak öğrencilerin istenilen düzeyde yeterli olmadıkları belirtilmiştir. Bu olumsuz durumun ortadan kaldırılması için öğretmenlerin öğrencilere daha yakın olmaları nedeniyle araç ve gereç kullanımında güvenlik koçluğu görevini üstlenmeleri gerektiği düşünülmektedir. Güvenlik koçluğu yöntemiyle eksik İSG materyallerinin öğretmen ve öğrenciler tarafından kullanımında yaşanan sorunların giderilmesine yardımcı olacağı düşünülmektedir. Okullardaki İSG uygulamalarında İSG bilincinin yönetici ve öğretmenlerden ziyade öğrencilerde geliştirilmesi gerektiği

vurgulanmıştır. İSG eğitimlerinde İSG görsel materyallerinin kullanılması İSG materyallerinin etkililiğinin dolaylı olarak arttırılmasına katkı sağlamaktadır. Bayram'ın (2020) çevrimiçi İSG eğitimlerinin kalitesini araştırdığı çalışmasında, görsel içerikle desteklenen, sürükleyici bir şekilde kurgulanan, akıcı anlatımlarla ifade edilen İSG eğitimlerinin etkililiğinin artacağı belirtilmiştir.

İSG yönetsel etkililik kategorisinde okul yöneticileri tarafından yapılan değerlendirmeler “Yönetsel Görev ve Sorumluluk Bilinci”, “Yönetsel Sorunlar ve Çözüm Önerileri” alt kategorilerinde ifade edilmektedir. Bu alt kategorilerde yapılan değerlendirmelerde görev ve sorumluluk bilincinin yeterli düzeyde olmadığı bulgusuna ulaşılmıştır. Süreç olarak yönetim, bilim olarak, sistemli ve bilimsel bilgi topluluğunu; sanat olarak, bir uygulamayı; bir dizi faaliyet ya da işlemleri ifade eder (Mucuk, 2008). Bu bağlamda yönetimde sorumluluk duygusunun geliştirilmesi, yönetilen konunun bilimsel süreçlerine sistematik bir yaklaşım gerektirir. Bunun için okul yöneticilerinin İSG uygulamaları konusunda yeterli eğitim almaları gerekmektedir. Organizasyonun verimliliği ve etkililiği, organizasyonun hedeflerine ulaşma derecesine bağlıdır. Bu da ancak örgütsel unsurların uyumlu çalışmasıyla sağlanabilir (Genç, 2005). Okul yöneticilerinde sorumluluk bilincinin gelişmesi okuldaki İSG kültürünü olumlu yönde etkileyecektir. Bir örgütteki grup ve bireylerin düşünce, değer, yeterlilik, davranış ve algılama modellerinin bir ürünü olarak tanımlanan güvenlik kültürünün, okul yöneticilerinin liderliğinde oluşturulacağı vurgulanmıştır (Şensöğüt, 2018). Okullarda İSG yönetimi, okul yöneticilerine yüklenen görev ve sorumlulukları artırsa da en ideal eğitim ve öğretimin, en iyi yönetilen İSG uygulamalarıyla mümkün olacağı ifade edilmektedir. Eğitimin aksamaması nedeniyle oluşacak maddi ve manevi kayıpların hem insanlara hem de ülke ekonomisine büyük zarar vereceğini belirtilmiştir. Çalışma ortamından kaynaklanan tehlikeler nedeniyle çalışanlar yaralanmakta, sakatlanmakta veya ölmektedir. İSG uygulamalarının ihmal edilmesi, ekonomik maliyetleri büyük ölçüde arttırdığından ülkelerin en çok odaklandığı sürdürülebilir sosyal ve ekonomik kalkınmayı sekteye uğratacağı ileri sürülmektedir (Serin & Çuhadar, 2015).

Çay'a (2019) göre okullarda görev yapan yöneticilerin bir kısmı İSG uygulamalarının ciddi şekilde yönetildiğini belirtirken, önemli bir kısmı ise bu uygulamaların sadece göstermelik olduğunu ve bu durumun değiştirilmesi için gerekli çalışmaların yapılması gerektiğini ifade etmiştir. Diğer alt kategori olan “yönetsel sorunlar ve çözüm önerileri” ne ilişkin ifade edilen görüşlerin ise bilgi eksikliği, gerekli finansal kaynakların bulunmaması, gerekli önemin verilmemesi, zorunlu İSG uygulamaları ve iş yükünün fazla olması merkezinde değerlendirildiği görülmüştür. Bu alt kategoriler arasında en çok dile getirilen görüşün bilgi eksikliği ve iş yükünün fazla olması ile ilgili olduğu görülmüştür. Benzer bulgulara sahip olan Yılmaz'ın (2009) çalışmasına göre İSG ile ilgili faaliyetlerin eğitim, bilgilendirme, koordinasyon ve konu ile ilgili uzman eksikliği gibi olumsuz koşullar altında yürütüldüğü ifade edilmiştir. 6331 sayılı İSG Kanununun kapsamına özel sektör işyerlerinden sonra 2012 yılında kamu kurumları da bu kanunun kapsamına alınmıştır. Bu kanunla kamu yöneticileri üstlendikleri birçok hukuki sorumluluk ve yükümlülüğü üstlenmek zorunda kalmıştır (Akaner, 2022). Yöneticilere düşen yükümlülüklerin en ağırı olarak görülen 6331 sayılı İSG Kanununun maddesi, işyerlerinde İSG uygulamalarına ilişkin iş ve işlemlerin yürütülmesi sorumluluğunu işveren vekili olarak kamu yöneticilerine yüklemektedir. Bu durum yöneticilerin özellikle

çalışma alanlarında hukuki öncelikleri belirlemede zorluk yaşamalarına neden olabilmektedir. Bunun yanında çalışma ortamındaki risk faktörlerinin belirlenmesine yönelik risk analizleri yapan İSG profesyonellerinin istihdamına ilişkin kanunun sürekli ertelenmesi, risk analizi konusunda yeterli teknik bilgiye sahip olmayan yöneticilerin güvenlik açıklarına neden olabilecek durumların tespiti konusunda kendilerini yetersiz hissetmelerine neden olabilmektedir. Ayrıca okul yöneticilerinin hem eğitim hem de İSG ile ilgili iş yükünün fazla olması, İSG uygulamalarında sorumluluk alma farkındalıklarının azalmasına neden olabilir. Alanyazına ilişkin yapılan araştırma bulgularının İSG uygulamaları ile ilgili belirlenen eksikliklerle birlikte değerlendirilmesinin daha faydalı olacağı düşünülmektedir.

Öğretmen ve öğrenci İSG tutum ve davranışları kategorisine ait görüşlerin öğretmenlerin tutum ve davranışları “olumlu”, “olumsuz” ve “kişiye göre” değişebildiği şeklindedir. Bu kategorinin yoğunlaştığı görüş, öğretmen ve öğrencilerin İSG tutum ve davranışlarının olumsuz olması yönündedir. İnsanlarda düşünce duygu, tutum, algı vb. özellikler davranışları için oldukça önemlidir. Bu yüzden iş güvenliği ile ilgili davranışlar incelenirken, çalışanların İSG ile ilgili tutum ve algıları hakkında bilgi sahibi olmak büyük önem arz etmektedir (Dursun & Keser, 2014). Bu açıdan okul yöneticilerinin İSG'ye yönelik tutumlarının olumlu olduğu ve bunun davranışlarına da olumlu yansıdığı görülmektedir. Okul yöneticilerinin İSG konusunda iyi tutum ve davranışlara sahip olması önemlidir ancak yeterli değildir. Yöneticilerin bunu okul kültürüne de yansıtması gerektiği görülmektedir. Çünkü davranışların topluma yayılmasında örgüt kültürü önemli bir yere sahiptir. Özellikle Nielsen (2014), insan davranışlarının kültürle yakın ilişki içinde olduğunu ve iş güvenliği kültürünün yüksek olduğu ülkelerde iş kazası oranlarının çok düşük seviyelerde görüldüğünü belirtmiştir. Bu bağlamda okul güvenliği kültürüne yansıyan tutumlar yardımıyla okul personelinin, öğretmenlerin ve öğrencilerin davranışlarının bu yönde geliştirilerek İSG risk faktörlerinden ve tehlikeli durumlardan korunmanın sağlanacağı söylenebilir.

Öğretmenlerin tutum ve davranışlarının iyileştirilmesi gerekmektedir. Bu nedenle okul yöneticilerinin okullardaki İSG uygulamalarına ilişkin öğretmenlere verecekleri görev, sorumluluk ve İSG eğitimlerinin, öğretmenlerin İSG bilinci kazanmalarına yardımcı olacağı ve İSG tutum ve davranışlarının olumlu yönde gelişmesine katkı sağlayacağı düşünülebilir (Türüdü, 2019). Çalışanların güvenli davranışlarını belirleyen ve yönlendiren en önemli faktörlerin örgüt yönetiminin İSG konusundaki düşünce, tutum, davranış ve algıları olduğu ifade edilmiştir. Yönetimin İSG uygulamalarına verdiği önemin artmasıyla birlikte çalışanların İSG yönetmelik prosedürlerine, ekipman kullanımına ve eğitimlere olan duyarlılığının da arttığı gözlemlenmiştir (Can & Hüseyinli, 2017). Bu bağlamda araştırmanın bulguları incelendiğinde öğretmen ve öğrencilerin İSG tutum ve davranışlarındaki olumlu değişikliklerin okul yönetiminin yaklaşımlarına bağlı olduğu düşünülmektedir. Yönetimin İSG yaklaşımlarının iyi olduğu okullarda gerçekleştirilen Öztürk'ün (2020) çalışmasına göre, iyi bir İSG kültürü oluşturmayı hedefleyen okul yönetimine sahip meslek lisesi öğrencilerinin İSG kurallarına riayet ettikleri, İSG hakkında bilgi sahibi oldukları ve İSG uygulamalarına ilişkin tutum ve davranışları olumlu olduğu görülmüştür.

Pandemi gibi salgın hastalık durumlarının İSG uygulamalarına olan bakış açısını nasıl etkilediği ile ilgili okul yöneticilerin görüşlerine bakıldığında, görüşlerin geneli pandemi

döneminin, İSG uygulamalarına olan bakış açısını olumlu etkilediği yönündedir. Pandemi döneminde tüm dünyada ve ülkemizde de ciddi tedbirler alınmıştır. Ülkemizde 11.03.2020 tarihinde ilk vaka çıktıktan sonra 13.03.2020’de ülke genelinde ilk ve orta dereceli okullar, üniversiteler tatil edilmiş ve insanların toplu halde bulunabileceği bütün mekanların faaliyetlerine ara verilmiştir. Eğitime verilen araların, öğrenci eğitimi ve öğretimi üzerinde büyük olumsuzlukları olduğu yurtdışı ve yurt içi yapılan araştırmalarda gösterilmektedir. Carlsson vd., (2015) araştırma sonuçlarına göre: Uygulamaya konan on günlük ilave eğitim sonucunda elde edilen standart sapma değerlerinin %1’i kadarının bilgi kullanım testlerinde kristalize zekâ puanlarını önemli ölçüde artırdığı görülmüştür. Okul kapanmalarının etkisi ile yani on iki hafta daha az eğitim almanın standart sapma değerinin %6’sının kaybolmasına sebep olduğu tespit edilmiştir. Uzaktan eğitim, gelişmiş eğitim teknoloji sistemine ihtiyaç duyar fakat dünya üzerinde bu yönde tam olarak hazırlanmış çok az sayıda uzaktan eğitim teknolojileri sistemi mevcuttur. Var olan bu sistemler ile öğrencinin evde normal programını sürdürebilmesi için bilgisayar ve diğer bilişim teknolojilerine sahip olması gerekmektedir. Çevrimiçi olarak ifade edilen uzaktan eğitimde derslerin takip edilebilmesi için sessiz bir oda, uygun şartlar ve bu durumu kanıksamış özellikteki ebeveynler olması gerekmektedir. Fakat bu konuda ülkemizde büyük eşitsizlikler söz konusudur. Özellikle ailelerin sosyal ve ekonomik durumlarının aynı olmadığı görülmektedir (Balcı, 2020). Aytaç’ın (2020) yapmış olduğu çalışmada pandemi sürecinde okul yöneticileri, öğrencilerin öğrenme motivasyonunu sağlayamama ve velilerin öğrenciler için evde öğrenme ortamı oluşturamama gibi sorunlar yaşadıklarını ayrıca karantina altındaki çocukların dört kat daha stres yaşadıklarını bunun yanında psikolojik ve davranışsal sorunlarının oluştuğunu ifade etmiştir. Bu doğrultuda eğitim öğretimin pandeminin etkilerinden korunmak için durdurulması ya da ara verilmesi yerine İSG uygulamalarına ağırlık verilerek sağlık güvenlik kültürünün geliştirilmesini sağlamanın bu durum için daha etkili ve faydalı olacağı düşünülmektedir. Bu durumun okul yöneticilerinin ifade ettikleri ile aynı yönde olduğu görülmüş ve konunun ciddiyetine istinaden alınan önlemlerin sektörlere göre değişiklik göstereceği vurgulanarak bu konuya ilişkin Sağlık Bakanlığı Bilim Kurulu tarafından on bir rehber yayımlanmıştır. Bu rehberde çalışma ortamları ve yapılan işin özellikleri ile çalışma şartları göz önüne alınarak tavsiye edilen tedbirler kamuoyu ile paylaşılmış ve işveren bu tedbirleri almakla yükümlü tutulmuştur (Ateş, 2020). Dolayısı ile okullarda işveren vekili olarak görev yapan okul müdürleri de bu yükümlülüğün altına girmiştir. Bu önlemlerin alınması örgüt ortamlarında yönetilen İSG uygulamalarının ciddiyetini bir kez daha vurgulamış ve devamında İSG yönetiminin uygulandığı hatta uygulanmadığı ortamlarda bile güvenlik ve sağlık kültürünün devam ettiği görülmüştür.

Öneriler

Bu çalışmada elde edilen sonuçlara göre uygulayıcılara çeşitli önerilerde bulunulmuştur.

Okullarda yönetici ve okul personeline İSG uzmanları tarafından verilecek eğitimler İSG hedefleri açısından daha doğru olabilir.

Diğer sektörlerdeki İSG süreç uygulamalarına ilişkin bilgi alışverişinde bulunulabilir.

MEB il ve ilçe teşkilatlarının okul İSG uygulamalarında izlenen yöntemler için OSGB'den yardım alınabilir.

Sadece okullar için İSGYS geliştirilebilir.

Okul güvenliği koçluğuna yönelik çalışmalar yapılabilir.