

# Journal of Naval Sciences and Engineering

Deniz Bilimleri ve Mühendisliği Dergisi

Barbaros Naval Sciences and Engineering Institute  
Barbaros Deniz Bilimleri ve Mühendisliği Enstitüsü

Volume/Cilt:16  
Number/Sayı:2  
November/2020

## PRINTED BY/BASKI

Turkish Naval Academy Printing House/Deniz Harp Okulu Basımevi

## CORRESPONDENCE AND COMMUNICATION ADDRESS/YAZIŞMA VE HABERLEŞME ADRESİ

Milli Savunma Üniversitesi  
Barbaros Deniz Bilimleri ve Mühendisliği Enstitüsü  
Deniz Harp Okulu Yerleşkesi  
Tuzla/İstanbul/Türkiye

**Phone/Telefon** : +90 216 395 26 30  
**Fax/Belgegeçer** : +90 216 395 26 58  
**E-mail/E-posta** : [jnse@dho.edu.tr](mailto:jnse@dho.edu.tr)  
**Web** : <https://dergipark.org.tr/tr/pub/jnse>



**NATIONAL DEFENCE UNIVERSITY  
BARBAROS NAVAL SCIENCES AND ENGINEERING INSTITUTE  
JOURNAL OF NAVAL SCIENCES AND ENGINEERING**

**MİLLİ SAVUNMA ÜNİVERSİTESİ  
BARBAROS DENİZ BİLİMLERİ VE MÜHENDİSLİĞİ ENSTİTÜSÜ  
DENİZ BİLİMLERİ VE MÜHENDİSLİĞİ DERGİSİ**

Volume/Cilt: 16

Number/Sayı: 2

November/Kasım 2020

ISSN: 1304-2025

**Owner on Behalf of the Barbaros Naval Sciences and Engineering Institute  
Barbaros Deniz Bilimleri ve Mühendisliği Enstitüsü Adına Sahibi ve Sorumlusu**

Assoc.Prof.Dr. (Doç.Dr.) Ertan YAKICI

Journal of Naval Sciences and Engineering (JNSE) is a peer reviewed, international, inter-disciplinary journal in science and technology, which is published semi-annually in April and November since 2003. It publishes full research articles, review articles, technical notes, short communications, book reviews, letters to the editor and extended versions of conference papers. Topics of interest include the technological and scientific aspects of the following areas: **Computer Science and Engineering, Electrical and Electronics Engineering, Naval/Mechanical Engineering, Naval Architecture and Marine Engineering, Industrial Engineering and Basic/Social Sciences**. The journal aims to provide a scientific contribution to the increasing needs of Turkish Armed Forces. The papers in the journal are published in English.

Following the Open Access Model of Publishing, Journal of Naval Sciences and Engineering presents a variety of scientific viewpoints. The authors are responsible for the scientific, contextual and linguistic aspects of the articles published in the journal. The views expressed or implied in this publication, unless otherwise noted, should not be interpreted as official positions of the Institution.

Our journal uses “double-blind review”, which means that both the reviewer and author identities are concealed from the reviewers, and vice versa, throughout the review process. The articles submitted to JNSE to be published are free of article submission, processing and publication charges. The accepted articles are published free-of-charge as online from the journal website and printed.

**DATABASES INDEXING OUR JOURNAL / TARANDIĞIMIZ VERİ TABANLARI**

Open Academic Journals Index (OAJI) (13.03.2016)

Asian Digital Library (03.09.2018)

Sobiad Citation Index (31.01.2018)

Idealonline (05.09.2018)

Scientific Indexing Services (SIS) (28.02.2018)

Directory of Open Access Journals (DOAJ) (09.10.2018)

Arastirmax Scientific Publication Index (13.03.2018)

ULAKBİM TR Dizin (14.05.2020)

CiteFactor Academic Scientific Journals (14.05.2018)

Deniz Bilimleri ve Mühendisliği Dergisi (DBMD); uluslararası düzeyde, hakemli, multi-disipliner, Nisan ve Kasım aylarında olmak üzere 2003 yılından bu yana yılda iki kez yayımlanan, bilim ve teknoloji dergisidir. Dergide; **Bilgisayar, Makine, Gemi İnşa, Elektrik/Elektronik, Endüstri Mühendisliği** ile **Temel/Sosyal Bilimler** alanlarında bilimsel nitelikli araştırma makaleleri, derlemeler, teknik notlar, kitap incelemeleri, editöre mektuplar ile konferans ve toplantıların genişletilmiş raporlarına yer verilmektedir. Dergi, Türk Silahlı Kuvvetlerinin artan ihtiyaçlarına bilimsel katkı sağlamayı amaçlamaktadır. Dergide yer alan makaleler İngilizce olarak yayımlanmaktadır.

Açık Erişimli Yayın Politikası izleyen Deniz Bilimleri ve Mühendisliği Dergisi, farklı bilimsel bakış açılarını okuyucularına sunmaktadır. Dergide yayınlanan makalelerin bilim, içerik ve dil bakımından sorumluluğu yazarlarına aittir. Dergide doğrudan veya dolaylı olarak ifade edilen görüşler, kurumun resmi görüşleri olarak görülmemelidir.

Dergimiz, makale değerlendirme sürecinde “çift-kör hakemlik” sistemini kullanmaktadır. Buna göre, değerlendirme süreci boyunca hakemler ve yazarlar birbirlerinin bilgilerini görememektedir. DBMD’ne yayımlanmak üzere gönderilen makaleler; makale gönderim, işlem ve yayın ücretinden muaftır. Kabul edilen makaleler, ücretsiz olarak basılı şekilde ve dergi web sayfasından çevrimiçi (online) olarak yayımlanmaktadır.

© 2020 Copyright by Barbaros Naval Sciences and Engineering Institute

Her hakkı saklıdır.

**NATIONAL DEFENCE UNIVERSITY  
BARBAROS NAVAL SCIENCES AND ENGINEERING INSTITUTE  
JOURNAL OF NAVAL SCIENCES AND ENGINEERING**

**MİLLİ SAVUNMA ÜNİVERSİTESİ  
BARBAROS DENİZ BİLİMLERİ VE MÜHENDİSLİĞİ ENSTİTÜSÜ  
DENİZ BİLİMLERİ VE MÜHENDİSLİĞİ DERGİSİ**

Volume/Cilt: 16

Number/Sayı: 2

November/Kasım 2020

ISSN: 1304-2025

**EDITOR-IN-CHIEF / BAŞ EDİTÖR**

Assoc.Prof.Dr. Ertan YAKICI, National Defence University

**TECHNICAL EDITOR / TEKNİK EDİTÖR**

Asst.Prof.Dr. Özlem AKGÜN, National Defence University

**ASSISTANT EDITOR AND PROOFREADER / YARDIMCI EDİTÖR VE DÜZELTMEN**

Res.Asst. Özgenur AKTAN, National Defence University

**EDITORIAL BOARD / YAYIN KURULU**

Prof.Dr. Ahmet Dursun ALKAN, Yıldız Technical U.  
Prof.Dr. Serhan DURAN, Middle East Technical University  
Prof.Dr. Claudio PENZA, University of Naples  
Prof.Dr. Engin DELİGÖZ, Aksaray University  
Prof.Dr. Rumen KISHEV, Bulgarian Academy of Sciences  
Assoc.Prof.Dr. Egemen SULUKAN, National Defence U.  
Assoc.Prof.Dr. Ertan YAKICI, National Defence U.  
Assoc.Prof.Dr. Mustafa TÜRKMEN, Erciyes University  
Assoc.Prof.Dr. Fatih ERDEN, National Defence U.  
Asst.Prof.Dr. Levent ERİŞKİN, National Defence U.  
Asst.Prof.Dr. Tolga ÖNEL, National Defence U.

**ADVISORY BOARD / DANIŞMA KURULU**

Prof.Dr. A.Arif ERGİN, Yeditepe University  
Prof.Dr. Cemal ZEHİR, Yıldız Technical University  
Prof.Dr. Cengiz KAHRAMAN, İstanbul Technical U.  
Prof.Dr. Drazan KOZAK, University of Osijek  
Prof.Dr. Hakan TEMELTAŞ, İstanbul Technical U.  
Prof.Dr. Atilla İNCECİK, University of Strathclyde  
Prof.Dr. Bettar O. el MOCTAR, University of Duisburg  
Prof.Dr. Cem ERSOY, Bogazici University  
Prof.Dr. Özlem ÖZKANLI, Ankara University

Prof.Dr. Sergej HLOCH, Technical University of Kosice  
Prof.Dr. Yahya KARSLIĞİL, Yıldız Technical University  
Prof.Dr. Nurhan KAHYAOĞLU, Piri Reis University  
Prof.Dr. Süleyman ÖZKAYNAK, Piri Reis University  
Prof.Dr. Serdar PİRTİNİ, Marmara University  
Prof.Dr. Osman TURAN, University of Strathclyde  
Prof.Dr. Giorgio TRINCAS, University of Trieste  
Prof.Dr. Cem SAY, Bogazici University

**REFEREES FOR THIS ISSUE / SAYI HAKEMLERİ**

Bedri Onur KÜÇÜKYILDIRIM  
Doğuş ÖZKAN  
Mehmet Görkem ÜLKAR  
Mehmet ŞAHBAZ  
Nezir AYDIN  
Polat TOPUZ

Rıdvan YAMANOĞLU  
Şükran ŞEKER  
Uğur Buğra ÇELEBİ  
Utku PAMUKSUZ  
Yalçın DURMUŞOĞLU

CONTENTS / İÇİNDEKİLER

*Mechanical Engineering / Makine Mühendisliği*

RESEARCH ARTICLE

**An Open Source Tool for Emission and Energy Analysis of a Generic Ship** 93-116  
(Açık Kaynak Kodlu Gemi Enerji Sistem ve Emisyon Analizi Aracı)  
*Salih Korhan ZORLU, Egemen SULUKAN*

*Industrial Engineering / Endüstri Mühendisliği*

REVIEW ARTICLE

**Survey on Military Operations of Fuzzy Set Theory and its Applications** 117-141  
(Bulanık Kümeler Teorisi ve Uygulamalarının Askeri Operasyonlar  
Üzerine Araştırmaları)  
*Muhammet DEVECİ, Yusuf KUVVETLİ, İbrahim Zeki AKYURT*

*Mechanical Engineering / Makine Mühendisliği*

RESEARCH ARTICLE

**Energy System Analysis and Modelling of an Electric Powered Ferry** 143-170  
(Elektrikle Çalışan bir Feribotun Enerji Sistem Analizi ve Modellenmesi)  
*Fatih YILMAZ, Egemen SULUKAN*

*Mechanical Engineering / Makine Mühendisliği*

RESEARCH ARTICLE

**Investigation of Mechanical Properties of Welding Electrodes Used for High Strength Low Alloy Steels** 171-192  
(Yüksek Mukavemetli Düşük Alaşımli Çelikler için Kullanılan Kaynak  
Elektrodlarının Mekanik Özelliklerinin İncelenmesi)  
*Zeynep TAŞLIÇUKUR ÖZTÜRK, Abdullah Koray PEHLİVAN*

*Naval Architecture and Marine Engineering / Gemi İnşaatı ve Gemi Makineleri Mühendisliği*

RESEARCH ARTICLE

**Generic Naval Vessel Waste Management Model Development in Ship-Life Cycle Assessment (SLCA) and Cost (SLCC)** 193-216  
(Jenerik Bir Savaş Gemisinde Gemi-Yaşam Döngüsü Değerlendirmesi (SLCA) ve Maliyet Modeli (SLCC) Geliştirilmesi)  
*Uğur Buğra ÇELEBİ*

*Electric-Electronic Engineering / Elektrik-Elektronik Mühendisliği*

RESEARCH ARTICLE

**Clustering Based Feature Extraction Methods for Semaphore Flag Recognition** 217-237  
(Simafor Bayrak Tanıma için Kümeleme Tabanlı Öznitelik Çıkarma Yöntemleri)  
*Batuhan GÜNDOĞDU, Deniz KUMLU*



*\*An ethical committee approval and/or legal/special permission has not been required within the scope of this study.*

**AN OPEN SOURCE TOOL FOR EMISSION AND ENERGY  
ANALYSIS OF A GENERIC SHIP\***

**Salih Korhan ZORLU<sup>1</sup>  
Egemen SULUKAN<sup>2</sup>**

*<sup>1</sup>National Defence University, Barbaros Naval Sciences and Engineering  
Institute, Department of Marine Mechanical Engineering, Istanbul, Turkey,  
korhanz1979@gmail.com; ORCID: 0000-0001-5716-1452*

*<sup>2</sup>National Defence University, Turkish Naval Academy, Department of  
Mechanical Engineering, Istanbul, Turkey,  
esulukan@dho.edu.tr; ORCID: 0000-0003-1138-2465*

**Date of Receive: 18.05.2020**

**Date of Acceptance: 01.10.2020**

### ABSTRACT

*Ships embodying a wide range of energy carrier conversion, end-use technologies and emissions, can be considered as a whole energy system and require focused analysis to provide guidance and foresight for naval engineers, ship operators and fleet managers. Considering the emerging technologies in marine industry and the new regulations promulgated by the local or worldwide authorities, benefiting the superpowers of computing technologies became vital in order to let the stakeholders keep their profits up while fulfilling the regulations and restrictions. Since optimizing a system is the focus of all kinds of engineering, software tools aiming to provide guidance for the decision makers have been widely used for the last decades. This study anticipates to bring a comprehensive and open ended software tool solution for the stakeholders and the researchers of the shipping industry and to be the first step for a sophisticated open source software tool which will shape with the help of future researchers.*

**Keywords:** *Ship Energy System, Data Science, Open Source, Python, Energy Analysis.*



## **AÇIK KAYNAK KODLU GEMİ ENERJİ SİSTEM VE EMİSYON ANALİZİ ARACI**

### **ÖZ**

*Gemiler sahip oldukları geniş kapsamlı enerji taşıyıcıları, dönüşüm teknolojileri, son kullanıcı teknolojileri ve gaz salınımları ile kendine has enerji sistemleridir. Bu nedenle gemi enerji sistemlerinin özel olarak ele alınıp incelenmeleri, gemi operatörlerine, filo yöneticilerine, gemi makina ve inşaatı mühendislerine ve diğer tüm gemicilik sektörü paydaşlarına rehberlik sağlaması açısından önem taşımaktadır. Gelişmekte olan denizcilik teknolojilerini ve otoritelerce yayımlanan yeni düzenlemeleri göz önünde bulundururken bilgisayar teknolojilerinin sunduğu güçlerden faydalanmak, sektör paydaşlarının karlılıklarını artırırken aynı zamanda yeni yönetmeliklere ve kısıtlamalara adaptasyon açısından önem arz etmektedir. Tüm mühendislik alanlarının ortak paydasının optimizasyon olması sebebiyle, yazılım araçlarının kullanımı son yıllarda çok yaygınlaşmıştır. Bu çalışmada, gemilerdeki enerji verimliliği ve emisyon konusunda, halihazırdaki düzenlemeleri göz önüne alarak, esnek, özgün ve yerli bir enerji analiz aracı oluşturulması hedeflenmiştir. Tasarlanan bu yazılımı bilgisayar teknolojilerindeki ve gemicilik endüstrisindeki süregelen değişimlere karşı esnek ve adapte edilebilir kılmak amacıyla açık kaynak kodlu programlama dili kullanılmıştır. Böylelikle aracın gelecekteki çalışmalarda kullanılması ve geliştirilebilmesi açısından da fayda sağlanacağı düşünülmüş ve bu aracın, mühendislerin ve diğer sektör paydaşlarının istifade edebileceği daha gelişmiş ve kapsamlı bir aracın ilk adımı olması hedeflenmiştir.*

**Anahtar Kelimeler:** *Gemi Enerji Sistemleri, Veri Bilimi, Açık Kaynak, Python, Enerji Analizi.*

## **1. INTRODUCTION**

Since shipping stands as one of the main elements of the international trade and the transport sector that would not be unfair to claim that shipping sector represent a substantial portion of both environmental pollution and the economy cakes. Concerning the contribution of the shipping transport sector to the global gas emissions, operations and the technology used within the sector have been widely put under scope by engineers, environmental scientists and even by the economists. Although it requires scientific researches and some time to confirm, couple of reports have been emerged claiming that the air pollution levels are decreased throughout the world's busiest cities due to the COVID-19 lock down. If these reports get approved by scientific researches, they will also highlight again the contribution of the transport and shipping sectors to worldwide air pollution. On the other hand, most of the scientific researches so far on this field claim that the demand for shipping will keep rising for the near future and needs to be contemplated in terms of efficiency and its contribution to environmental pollution. In this regard with its 167 main and 3 associated member countries, International Maritime Organization (IMO), an agency of United Nations has been working on this rising issue for the last decades and already promulgated some regulations with regards to the energy efficiency of the ships and the ship born gas emissions which means a challenging and a long path of adaptation awaits all the stakeholders of the shipping sector. Also considering the other parallel regulations put into force by other authorities and some governments, actors of shipping sector varying from ship designers and ship builders to the operators on board should immediately take action and stay vigilant to survive through the rapidly changing circumstances.

In this context while demand for the shipping sector rises every other year emissions are needed to be reduced in order to comply with the stringent measures taken by the authorities. Recent researches and the uncertain circumstances posed worldwide by the latest pandemic especially for the international transport sector will soon fire up new questions to be answered and possible solutions to these questions will tend to bring "new changes" for the sector as well as the World goes back to "new normal".

## *An Open Source Tool for Emission and Energy Analysis of a Generic Ship*

Since science and engineering are always resilient, we would not be disappointed even if we disregard the latest circumstances we are facing throughout the world and keep focusing on optimizing our current systems. So that we can focus on the latest issues we have before the pandemic, keeping in mind that for sure we will see some adverse effects or maybe some new ideas helping engineers to cope with all these issues after the World totally gets through this pandemic.

Ships also embodying a wide range of energy carriers, conversion/enduse technologies and emissions, can be considered as a whole energy system and require focused analyses to provide guidance and foresight for naval engineers, ship operators, fleet managers and other relevant stakeholders throughout the shipping industry. Considering the emerging technologies in marine industry and the new regulations promulgated by the local or worldwide authorities, benefiting the super powers of computing technologies became vital in order to let the stakeholders keep their profits up while fulfilling the regulations and restrictions. Since optimizing a system is the main focus of all kinds of engineering, software tools aiming to provide guidance for the engineers and decision makers have been widely used for the last decades. But as the amount of the data produced and collected by the shipping industry raises, analysing tools require being resilient and adaptable.

This study initially aims to define the current requirements and the regulations with regards to the energy efficiency and the emission control of ships and develop a comprehensive and resilient energy analysis tool solution for ships. Open source and specifically Python programming language has been chosen in order to keep the tool adaptable and resilient due to continuous developments in all the computer science, engineering and the shipping industry. Building the tool using open source coding considered beneficial as it will also give researchers and programmers the opportunity to use and improve the tool for future studies. Considering the wide range of Python libraries available especially on data science, aforementioned tool can be integrated with new modules such as the ones able to detect anomalies, find out possible reasons and provide recommendations in order to eliminate the factor affecting the energy

system of a ship. The tool can also be enhanced with modules enabling the decision maker to compare two or more scenarios on a given ship.

Considering a ship as a single energy system could end up with incorrect results and bearing in mind that our energy system (ship) also interacts with outer energy systems such as sea and atmosphere would let the decision makers achieve more stable and accurate solutions. If we go into details, a ship operating in the North Sea has to interact with a sea temperature around 13°C in May while another ship operating in the Red Sea interacts with a sea temperature around 31°C and some more different atmospheric circumstances. Since a ship's main energy conversion technology is using internal combustion engines which transform chemical energy heavily relying on external conditions such as intake air temperature and coolant water temperature, this situational variation would lead a substantial difference between aforementioned two ships' energy systems and data science provides a great opportunity to overcome these kinds of differing circumstances. In this regard, this study anticipates to raise awareness on the issues of the sector related to the energy efficiency and emissions of ships, bring a comprehensive and open ended solution for the stakeholders and the researchers of the shipping industry and touch the base for a sophisticated open source software tool which will shape with the help of future researchers.

### **1.1. Aim and Research Questions**

The aim of this study is to;

- Review the latest International Maritime Organization (IMO) regulations with regards to energy efficiency of ships and emissions caused by shipping industry to raise more awareness,
- Review what kind of preparations on-going by the stake holders including engineers, shipping companies, organisations and governments to comply with regulations,
- Focus on developing an open-source software tool which is suitable for further improvements.

## *An Open Source Tool for Emission and Energy Analysis of a Generic Ship*

Questions to be answered are;

- What type of data about the performance of the ship should be gathered to build a reference energy system of a ship?
- Considering the resilience of open source programming what kind of improvements could be achieved following the completion of reference energy system?

### **1.2. Review of the Latest International Maritime Organization (IMO) Regulations on Ships' Energy Efficiency and Emissions**

At present, maritime shipping represents 80-90% of international trade. With global Gross Domestic Product (GDP) expected to grow 3.6% per year between 2019 and 2024, global trade volume is also expected to grow at a similar annual rate i.e. 3.8% over the next five years. Therefore, if no action is taken promptly, demand for marine fossil fuels will continue to grow steadily.

Considering the European Commission Joint Research Centre Emissions Database for Global Atmospheric Research (JRC-EDGAR) 2018 report relying on the data from IMO, shipping sector was also responsible for an average of 2.8%<sup>3</sup> of all annual GHGs on a CO<sub>2</sub>-equivalent basis, between 2007 and 2012. Between 2000 and 2017, CO<sub>2</sub> emissions associated with the shipping sector increased at an average annual growth rate of 1.87%. In 2017, the shipping sector was responsible for 677.25 Mt of CO<sub>2</sub> emissions (IRENA, 2019)

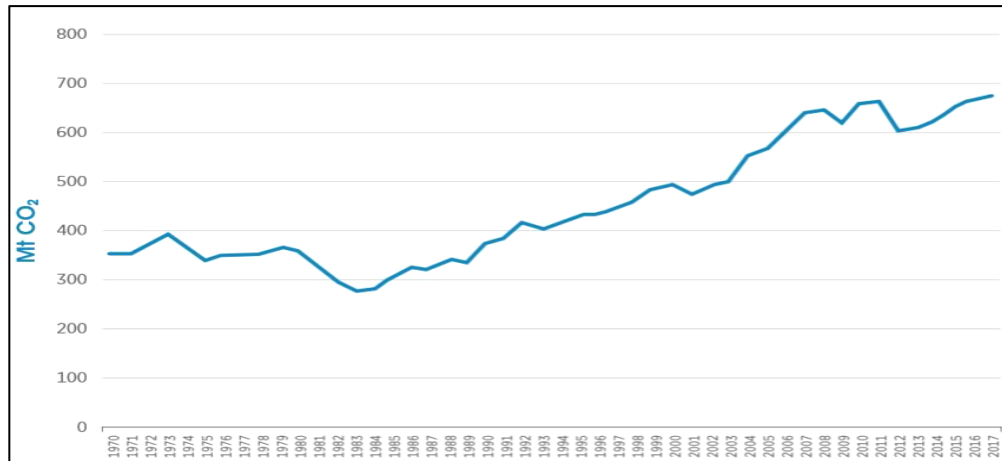

**Figure 1.** Ship born CO<sub>2</sub> emissions based on 1970-2017 JRC-EDGAR 2018 data (IRENA, 2019).

International Maritime Organisation (IMO) is an agency of United Nations (UN) specialised on maritime safety and established in 1958. IMO currently has 174 member countries and 3 associate members. After promulgating the International Convention for the Prevention of Pollution from Ships -as known as MARPOL 73/78- in 1973, a new annex named as the Regulations for the Prevention of Air Pollution from Ships (Annex VI) amended to the convention which seeks to minimize airborne emissions from ships (SO<sub>x</sub>, NO<sub>x</sub>, and other pollutants) and their contribution to local and global air pollution and environmental problems. Annex VI entered into force on 19 May 2005 and a revised Annex VI with significantly increased the emission limits was adopted in October 2008 which entered into force on 1 July 2010. IMO also adopted mandatory technical and operational energy efficiency measures which are expected to significantly reduce the amount of CO<sub>2</sub> emissions from international shipping. These mandatory measures (Energy Efficiency Design Index and Ship Energy Efficiency Management Plan) entered into force on 1st January 2013. (International Maritime Organization, n.d.)

## *An Open Source Tool for Emission and Energy Analysis of a Generic Ship*

Ship Energy Efficiency Management Plan (SEEMP) utilizes Energy Efficiency Operational Index (EEOI) as a monitoring tool and aims to provide guidance to the engineers and ship operators regarding the energy efficiency of the ships.

In addition to the aforementioned measures IMO has also promulgated the pollutant limits such as NO<sub>x</sub>, SO<sub>x</sub> and Green House Gases (GHG) globally and specific to some pre-defined Emission Control Areas (ECA). In this regard some governments and authorities have already started to focus on implementations and researches to be able to comply with these regulations.

In 2015, European Parliament has published a directive on the monitoring, reporting and verification of carbon dioxide emissions from maritime transport (European Parliament, 2015). The regulation requires ships above 5 000 gross tonnage (GT) to report their annual fuel consumption and associated CO<sub>2</sub> emitted during the voyages. Later in 2019 European Federation for Transport and Environment published a report aiming to translate the raw emissions and ship performance data collected from the EU shipping with regards to the European Parliament directive into policy relevant and relatable to general public knowledge (Transport and Environment, 2019). The study concluded that there is a large performance gap between ship design standards and real-world maritime operations considering EEDI and EEOI values. This study also declares the energy efficiency of fleets by giving company names out and ranking them.

Although these efforts does not seem to bring the work forward from where IMO has brought, one can say that these kind of reports would for sure motivate shipping companies to compete with the others by reducing the emissions and raising the energy efficiency of their fleets. Concerning the preparations and additional measures taken by the actors other than IMO and EU, a policy paper named 'Maritime 2050', published by United Kingdom (UK) Department for Transport (DfT) in 2019, stated the UK Government's ambition that "By 2050, the UK will actively drive the transition to zero emission shipping in its waters. (UK Department for Transport, 2019)

Another report prepared for the United Kingdom Department for Transport focused on the future technologies and the current technologies available within the shipping sector in order to minimize the emissions caused by shipping and aimed to provide guidance and decision support for policy makers. This report concluded that the sector should put an end to use of fossil fuels by 2030 in order to comply with the UK Government's Maritime 2050 policy. (UK Department for Transport, 2019)

Concerning the future requirements and demands, a study has also been published by the UK Department for Transport (DfT) and titled Potential Demands on the UK Energy System from Port and Shipping Electrification, focused on 10 biggest shipping ports which represents the 70 percent of total in United Kingdom (UK) and comparing the future energy demand by ports under current technology infrastructure and then the electrified fleets scenario. (UK Department for Transport, 2019)

Considering these works and new policies together with the pre-defined Emission Control Areas within MARPOL Annex VI, it is obvious that some countries and non-governmental organisations have already stepped forward and for sure many more will follow in the near future in order to comply with the regulations and contribute to the global fight to lower the emissions caused by the shipping sector.

## **2. MATERIALS AND METHODS**

As already mentioned in the previous sections the aim of this study is to develop an open source energy and emission analysis tool specific to shipping industry. Building the tool benefitting the open source programming has been considered vital as the secondary aim is to keep the tool resilient and free for further developments and studies. Before starting to develop the tool, a superficial review on the tools available has been conducted. As a result of the review, although there are some of them providing support for academic studies for free, almost all tools available have been identified as commercial and not specific to the ship energy systems. Between the eight tools reviewed, only one of them identified as



## *An Open Source Tool for Emission and Energy Analysis of a Generic Ship*

benefitting the open source programming but again not specific to ship energy systems.

In this regard, another generic review has been conducted in order to decide on the programming language and the platform to be used.

In a report (GitHub-The State of Octoverse, 2020) published by GitHub which is a platform for open-source programmers and owned by Microsoft Inc., Java Script, Python and Java programming languages have been placed as first three of other programming languages in 2019. Considering the latest curve upwards it succeeded and having a huge amount of data science libraries Python Programming Language has been chosen since the secondary objective for this tool is to be able to make data driven analysis. Python programming language is frequently used for artificial intelligence applications and data science which are essential for energy industry analysis.

### **3. RESULTS AND DISCUSSION**

#### **3.1. Development Process**

As all kinds of engineers are focused on optimizing a system, collecting and utilizing more data as we can is an important factor to get better results from analysis. However engineers are already familiar with complex software tools, this study anticipates to build a more user friendly tool which can be used even by a mechanic employed on board a ship who can be considered as the end user of the shipping industry. In this regard, parameter amount required by the tool kept low however some additional parameters have already been included to be used with possible future studies.

##### ***3.1.1. Defining the Software Architecture***

The main objective has been set as to provide all the information will be needed in order to let the tool build and visualize a ship's reference energy system. In this regard a database has been designed to hold the information of primary and second energy carriers, conversion technologies together with end use technologies on board ships.

Considering the possible need by future researches; another database table has been defined to hold generic data of multiple ships. Once technologies identified in relevant database modules, user should be able to create a new ship as a new database item and include pre-defined technologies on their new-defined ship. Thus, tool will be able to understand the relations between the equipment on board the ship. In other words, tool will now have the reference energy system so it can bring it forward by visualising the reference energy system. Some additional specifications are already defined for the reference energy system considering the future researchers who would want the tool to apply specific analysis and/or scenarios on the system. In this regard Sankey diagram has been chosen to visualize the reference energy system. Sankey diagram has been widely used for visualising energy flows throughout energy systems. Later step has been identified as to design a module which the user can enter data specific to a voyage and then let the tool calculate Energy Efficiency Operational Index (EEOI) for the voyage.

Concerning the Energy Efficiency Design Index (EEDI) tool, additional literature review conducted and some sceptical studies were identified.

Nikoletta L. Trivyza, Athanasios Rentizelas and Gerasimos Theotokatos studied on comparative analysis of Energy Efficiency Design Index (EEDI) versus lifetime CO<sub>2</sub> Emissions of ships. This study claimed that EEDI underestimates the effect of technologies for reducing carbon emissions in all the investigated cases and promotes use of lower installed power in order to reduce the emissions. The study also concludes that EEDI is a conservative metric, which however can be used as an approximation to compare alternative solutions early in the design phase. (Trivyza, Rentizelas & Theotokatos, 2020)

In this regard EEDI calculation disregarded for this study since it also aims to help engineers and ship builders during the design phase and there are already some studies claiming that EEDI is not practical in some cases.

### **3.1.2. Designing the Interface**

The modules decided to be developed, coded via using different Python libraries and new written codes. Considering the availability of internet, the tool designed to work on the Web. In doing so, it is aimed to avoid possible installation and compatibility issues which may occur while working on different operating systems.

### **3.1.3. Designing the Database Modules**

Four database tables and concurrently four modules have been created in order to let the user build their own reference energy system. Although there is no mandatory order for the database tables to be filled it is suggested to follow primary energy carriers, conversion Technologies, enduse technologies and ship database fields order.

On the primary energy carrier module, user is required to provide necessary parameters like name, stored energy and efficiency for the primary energy carriers such as fuel tank or batteries. Although there is no energy conversion operation by the primary energy carriers, an efficiency parameter has also been defined in order to calculate possible losses which may occur during long storage periods.

| Ships | Primary Energy Carriers | Conversion Technologies | Enduse Technologies

✕ ✎ Yakit Tanki      PrimaryEnergyCarrier Name:

✕ ✎ Solar Panel      Energy:

Efficiency:

Technical Details:

**Figure 2.** Primary energy carrier module user interface.

User is required to provide following parameters shown in Figure 3 to define conversion technologies such as main diesel engines, generators, boilers, electrical converters etc. Label, source energy, energy consumption per hour, output energy, efficiency, on time percentage and SO<sub>x</sub>, NO<sub>x</sub>, CO<sub>2</sub> emissions should be defined as initial parameters. Although it's not used for the time being, 'on time percentage' parameter has already been defined in order to give the future researchers the opportunity to build modules for hourly or daily basis analysis on the reference energy system.

Ships   Primary Energy Carriers   Conversion Technologies   Enduse Technologies	
Back	
<input type="checkbox"/> GM 8-268	Save
<input type="checkbox"/> GM 4-72	Conversion Label: GM 8-268
<input type="checkbox"/> Tevzi Panosu	Source Energy: Diesel/Gas Oil
<input type="checkbox"/> Trafo	Energy Consumption Per Hour: 100
<input type="checkbox"/> Shaft Generator	Output Energy: Kinetic
	Efficiency: 40
	Power: 1
	OnTime Percentage: 1
	Technical Details: None
	SOx Emission: 1
	NOx Emission: 1
	COx Emission: 1
	Input 1: -----

**Figure 3.** Conversion technologies module user interface.

Same parameters have been defined for the enduse technologies. However, both conversion technologies and end use technologies have the same parameters; these two considered as two different technology groups to let the software tool understand their classification while building the reference energy system.

*An Open Source Tool for Emission and Energy Analysis of a Generic Ship*

| Ships | Primary Energy Carriers | Conversion Technologies | Enduse Technologies

- AC
- Pompa
- Pervane

Enduse Label:

Enduse Type:

Sub System:

Source Energy:

Output Energy 1:

Output Energy 2:

Efficiency:

Power:

OnTime Percentage:

SOx Emission:

NOx Emission:

CO2 Emission:

Technical Details:

**Figure 4.** Enduse technologies module user interface.

Once technology databases are defined user will be able to define a new ship with basic parameters such as ship name, IMO number, area of operation, date of commission, displacement, Length over all (LoA) and Beam over all (BoA). Since the technologies are already defined now the user can pick which equipment to be included to the system from the primary energy carriers, conversion technologies and enduse technologies. As the last step user should define relations between this equipment on board in order to describe the energy transfers throughout the reference energy system.

The screenshot displays a web-based user interface for a ship database. At the top, there is a breadcrumb navigation path: '| Ships | Primary Energy Carriers | Conversion Technologies | Enduse Technologies'. Below this, there are two rows of icons, each containing an EEOI icon, a red 'X' icon, and a GEMI icon labeled 'GEMI 1' and 'GEMI 2' respectively. The main form area contains the following fields and controls:

- Ship Name:
- IMO Number:
- Ship Type:
- Area of Operation:
- Date of Commission:
- LoA:
- BoA:
- Displacement:
- Primary Energy Carrier-1 Label:
- Primary Energy Carrier-1 Device:
- Primary energy carrier1 outputconnection 1:
- Primary energy carrier1 outputconnection 2:
- Primary energy carrier1 outputconnection 3:
- Primary energy carrier1 outputconnection 4:
- Primary energy carrier1 outputconnection 5:
- Primary Energy Carrier-2 Label:

Figure 5. Ship database module user interface.

After all the equipment is associated with the ship, user will be able to visualize the reference energy system by clicking the Sankey diagram link. Figure 6 shows the visual output of the reference energy system created for a hypothetical ship named MV Hasan Pasa. The Sankey diagram module lets user to highlight a specific flow or hub and view details when the cursor hovered on them. Thus, it creates an easier view and makes it more user-friendly even when the reference energy system gets complicated owing to the big numbers of equipment associated with the ship.

*An Open Source Tool for Emission and Energy Analysis of a Generic Ship*

The EEOI module as shown in Figure 7 requires user to provide parameters needed specific to a voyage to be able calculate EEOI value. Once the user provides the cargo carried, distance sailed, fuel types and amounts consumed during the voyage, the module calculates the EEOI value using the Equation 1 provided within International Maritime Organization (IMO) guidelines.

$$EEOI = \frac{\sum_j FC_j \times C_{Fj}}{m_{Cargo} \times D} \quad (1)$$

In this equation  $FC$  stands for amount of fuel consumed in metric tonnes (mT),  $m_{Cargo}$  stands for the mass of cargo carried,  $D$  stands for the distance sailed in nautical miles (NM) and  $C_F$  is Fuel mass to CO<sub>2</sub> mass conversion factor specific to fuel type consumed.  $C_F$  is a non-dimensional conversion factor derivates from fuel consumption measured in a unit of gram and CO<sub>2</sub> gas emission measured in gram based on the carbon content.  $C_F$  values defined for specific fuel types are shown in Table 1.

**Table 1.** Conversion factor ( $C_f$ ) for fuel types (Adapted from IMO Guidelines for Voluntary Use of the Ship Energy Efficiency Operational Indicator).

Type of Fuel	Reference	Carbon Content	$C_f$ (t-CO <sub>2</sub> ) / (t-Fuel)
Diesel/gas oil	ISO 8217 Grades DMX-DMC	0,875	3,206000
Light fuel oil (LFO)	ISO 8217 Grades RMA-RMD	0,86	3,151040
Heavy fuel oil (HFO)	ISO 8217 Grades RME-RMK	0,85	3,114400
Liquefied petroleum gas (LPG)	Propane butane	0,819 0,827	3,000000 3,030000
Liquefied natural gas (LNG)	LNG	0,75	2,750000

#### 4. CONCLUSION

As explained in the previous sections and already proved by scientific and academic studies; transport and specifically the shipping sectors are one of the main contributors of the global emissions. While shipping sector represents a substantial portion of global air pollution cake, it can also be considered as an important factor for local and global economies.

Having both economy and air pollution issues together on the scale shipping sector needs to be resilient in order to balance pros and cons and maintain their profits while also complying with the air pollution regulations.



## *An Open Source Tool for Emission and Energy Analysis of a Generic Ship*

While sector is facing challenging times due to the latest regulations promulgated, some governments and non-governmental organizations already stepped forward by conducting new studies and setting new objectives to be able to comply with the regulations on energy efficiency and emissions of ships. This is an obvious indicant showing that all the stake holders of the sector varying from design engineers, ship builders, ship companies, ship owners and the ship operators on board ships should immediately focus on optimizing and operating their systems in line with the regulations.

Since optimizing a system is the main purpose of all the engineering studies, engineers have been widely benefitting the computer technologies by utilizing enhanced software tools for the last decades. Considering the need and the dependency for data of energy sector one can say that the shipping sector for sure will need new, resilient and ‘specific to sector software tools’ as embodying comprehensive and complicated energy systems in other words, ships.

As depicted in this study, there are already available software tools for the energy analysis but not many of them are practical for the shipping sector and also most of them are commercial and not focused on ships directly. In this regard, this study anticipated to touch the base for a resilient, comprehensive and user-friendly open source web tool for the stake holders of the shipping sector which can help them to conduct energy and emission analysis on their fleets.

Choosing open source programming for coding and Web as the platform have been considered necessary to keep the tool widely available and open to further enhancements by future researchers and programmers. Some possible future developments on the tool already taken into account and additional parameters have been amended to database tables.

Having a wide range of free and available libraries and being one of the most popular open source programming languages, Python programming language has been chosen to build the tool however new coding also required during the development phase.

In the design phase, a database has been defined which will hold the data of primary/secondary energy carriers, conversion and endues technologies in other words all the equipment on board ships. In addition, a database table also defined to hold the ship's data which also lets user to create multiple ships.

Following the design and the coding phases, an imaginary ship and some technologies had been defined on the database by using realistic data to test and showcase the results given by the tool. Once the technologies associated with the ship and the relations between technologies defined, Sankey diagram visualising the ship's reference energy system acquired as shown in Figure 6 and the diagram rendered the reference energy system correctly by visualising all the energy flows and emissions. As the last step, imaginary voyages had been added to ship's voyage history and the tool calculated the Energy Efficiency Operational Index (EEOI) which is a great tool to analyse a ship's energy efficiency while keeping the emissions between limits. This will further give an idea to ship operators of how to optimize voyages in terms of cost efficiency and the emission of a ship.

Overall, the developed tool has been considered as achieved the main objectives of this study. Providing the opportunity for the future researchers to enhance the tool is considered as a great take away. Future studies can bring new modules to life which will let the user to conduct analysis on a ship's reference energy system and visualise the system with more details such as hourly and/or daily basis energy analysis also having the ability to detect abnormalities within a ship's energy system and provide recommendations in order to fix the limping part of the system.

*An Open Source Tool for Emission and Energy Analysis of a Generic Ship*

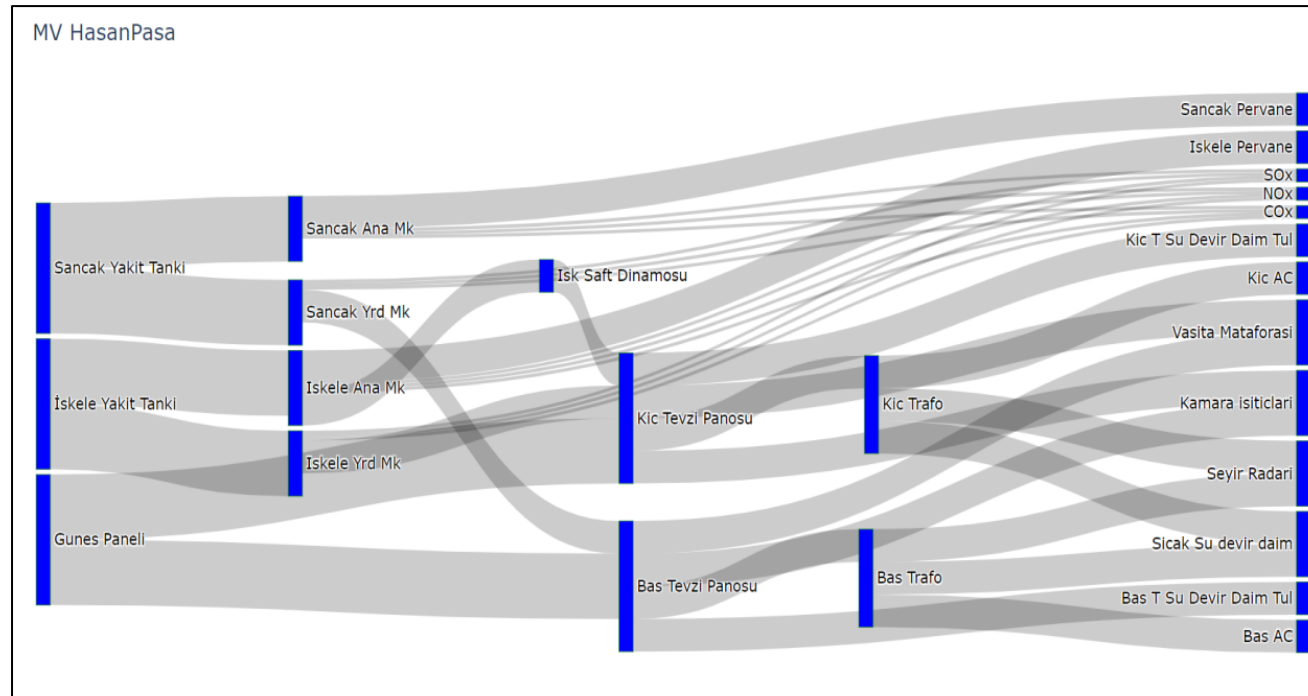

**Figure 6.** Reference energy system output for the imaginary test ship M/V Hasan Pasa.

*Salih Korhan ZORLU, Egemen SULUKAN*

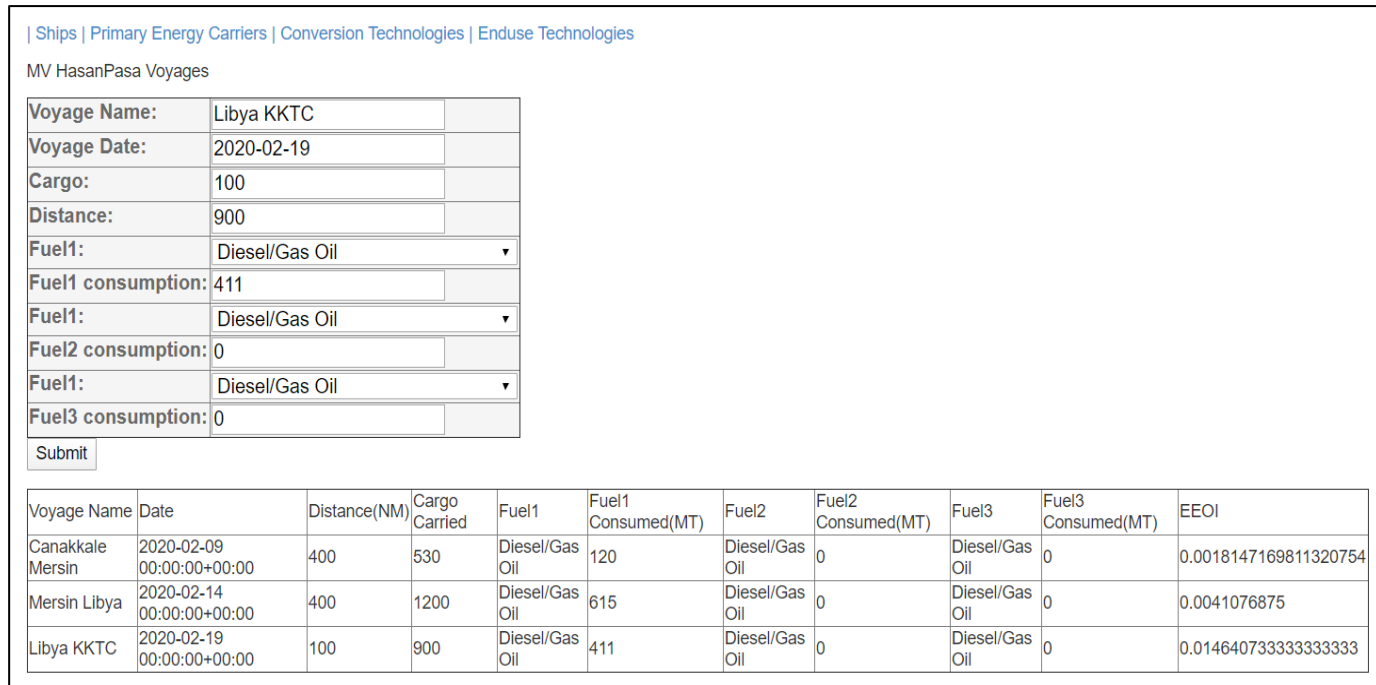

**Figure 7.** EEOI output for the imaginary test ship M/V Hasan Pasa.

*An Open Source Tool for Emission and Energy Analysis of a Generic Ship*

**REFERENCES**

European Parliament. (2015, April). Regulation (EU) 2015/757 of the European Parliament and of the Council of 29 April 2015 on the Monitoring, Reporting and Verification of Carbon Dioxide Emissions from Maritime Transport, and Amending Directive 2009/16/EC. *Official Journal of the European Union (EU)*. Retrieved from <https://eur-lex.europa.eu/legal-content/EN/TXT/PDF/?uri=CELEX:32015R0757&from=EN>

GitHub. (2020). The State of Octoverse. Retrieved from <https://octoverse.github.com/>

International Maritime Organisation. (n.d.). Index of MEPC Resolutions and Guidelines related to MARPOL Annex VI. Retrieved from <http://www.imo.org/fr/OurWork/Environment/PollutionPrevention/AirPollution/Pages/Index-of-MEPC-Resolutions-and-Guidelines-related-to-MARPOL-Annex-VI.aspx>

IRENA (2019). Navigating to a Renewable Future: Solutions for Decarbonising Shipping, Preliminary Findings. *International Renewable Energy Agency (IRENA)*, Abu Dhabi.

Transport and Environment (2019, December). EU Shipping's Climate Record: Maritime CO<sub>2</sub> Emissions and Real-world Ship Efficiency Performance. Retrieved from [https://www.transportenvironment.org/sites/te/files/publications/Study-EU\\_shippings\\_climate\\_record\\_20191209\\_final.pdf](https://www.transportenvironment.org/sites/te/files/publications/Study-EU_shippings_climate_record_20191209_final.pdf)

Trivyza N., Rentizelas A., & Theotokatos G. (2020). "A Comparative Analysis of EEDI versus Lifetime CO<sub>2</sub> Emissions". *Journal of Marine Science and Engineering*. 8(1):61, doi:10.3390/jmse8010061.

UK Department for Transport. (2019, September). Maritime 2050: Navigating the Future. Retrieved from [https://assets.publishing.service.gov.uk/government/uploads/system/uploads/attachment\\_data/file/872194/Maritime\\_2050\\_Report.pdf](https://assets.publishing.service.gov.uk/government/uploads/system/uploads/attachment_data/file/872194/Maritime_2050_Report.pdf)

UK Department for Transport. (2019, July). Maritime Emission Reduction Options. Retrieved from [https://assets.publishing.service.gov.uk/government/uploads/system/uploads/attachment\\_data/file/816015/maritime-emission-reduction-options.pdf](https://assets.publishing.service.gov.uk/government/uploads/system/uploads/attachment_data/file/816015/maritime-emission-reduction-options.pdf)

UK Department for Transport. (2019, July). Potential Demands on the UK Energy System from Port and Shipping Electrification. Retrieved from [https://assets.publishing.service.gov.uk/government/uploads/system/uploads/attachment\\_data/file/816017/potential\\_demands\\_on\\_UK\\_energy\\_system\\_from\\_port\\_shipping\\_notification.pdf](https://assets.publishing.service.gov.uk/government/uploads/system/uploads/attachment_data/file/816017/potential_demands_on_UK_energy_system_from_port_shipping_notification.pdf)

*Journal of Naval Sciences and Engineering*  
2020, Vol. 16, No.2, pp. 117-141  
*Industrial Engineering/Endüstri Mühendisliği*

REVIEW ARTICLE

*\*An ethical committee approval and/or legal/special permission has not been required within the scope of this study.*

**SURVEY ON MILITARY OPERATIONS OF FUZZY SET THEORY  
AND ITS APPLICATIONS\***

**Muhammet DEVECİ<sup>1</sup>**  
**Yusuf KUVVETLİ<sup>2</sup>**  
**İbrahim Zeki AKYURT<sup>3</sup>**

<sup>1</sup>*National Defence University, Turkish Naval Academy, Department of  
Industrial Engineering, Istanbul, Turkey,  
muhammetdeveci@gmail.com; ORCID: 0000-0002-3712-976X*

<sup>2</sup>*Cukurova University, Department of Industrial Engineering, Adana,  
Turkey,  
ykuvvetli@cu.edu.tr; ORCID: 0000-0002-9817-1371*

<sup>3</sup>*Turkish Airlines Flight Academy, Aydın, Turkey,  
zekiakyurt@gmail.com; ORCID: 0000-0003-4817-5267*

**Date of Receive: 17.08.2020**

**Date of Acceptance: 15.09.2020**

**ABSTRACT**

*In recent years, with the increase in investment in countries' military expenditures, the importance of decision-making problems in the military has gradually increased. There are various uncertainties such as vagueness, imprecise or ambiguous in decision-making problems. Decision making is the process of evaluating environmental factors from a holistic perspective, identifying problems and possible alternatives, making a systematic assessment, and identifying the most appropriate decision among them. The aim of this study is to investigate various types of fuzzy set that can be used in military problems under uncertainty. In addition, a detailed literature review of fuzzy decision making problems applied in the military are conducted.*

**Keywords:** *Military Applications, Fuzzy Sets, Multi-Criteria Decision Making (MCDM), New Trends and Applications.*



**BULANIK KÜMELER TEORİSİ VE UYGULAMALARININ  
ASKERİ OPERASYONLAR ÜZERİNE ARAŞTIRMALARI**

**ÖZ**

*Son yıllarda ülkelerin askeri harcamalarına yapılan yatırımların artmasıyla birlikte ordudaki karar alma sorunlarının önemi giderek artmıştır. Karar verme problemlerinde muğlaklık, kesin olmayan veya iki anlamlı gibi çeşitli belirsizlikler vardır. Karar verme, çevresel faktörleri bütüncül bir bakış açısıyla değerlendirme, sorunları ve olası alternatifleri belirleme, sistematik bir değerlendirme yapma ve aralarında en uygun kararı belirleme sürecidir. Bu çalışmanın amacı, belirsizlik altındaki askeri problemlerde kullanılacak çeşitli bulanık set türlerini incelemektir. Ayrıca, orduda uygulanan bulanık karar verme problemlerinin ayrıntılı bir literatür taraması yapılmaktadır.*

**Anahtar Kelimeler:** *Askeri Uygulamalar, Bulanık Kümeler, Çok-Kriterli Karar Verme, Yeni Eğilimler ve Uygulamalar.*

## **1. INTRODUCTION**

Military systems have complex structures and decision mechanisms for different types of real-world problems observed in air, navy and land forces around world armed forces. Weapon systems selection, resource location and allocation, arms transfers and management of military logistics are some examples for these problems. To handle such problems, a number of operations research and management science (OR/MS) tools such as multi-criteria decision making (MCDM), simulation, mathematical programming are commonly utilized by both academicians and practitioners. Studies conducted in military context generally have a significant impact on the performance of the organization since management of military organizations requires large amounts of money and resource (Tozan & Karatas, 2018; Karatas, Yakıcı, & Razi, 2019). Today, as well as the economic power, military force of a country is of great importance. Technological changes and increasing competition in the process of continuous development are triggering countries to increase their military spending in the world reached \$1.8 trillion, with the USA, China, Saudi Arabia, India and France, respectively having the highest budget for defence. In addition, total world military spending increased by 2.6 percent in 2018 to \$1.8 trillion (SIPRI, 2019). Most of the countries making these expenditures were shaken by the crisis in 2008. In the face of this situation, the importance of countries using their military defence costs and limited resources on priority strategies has increased. Table 1 presents countries with highest military expenditure in 2018 (SIPRI Military Expenditure Database, 2018).

**Table 1.** Top 15 military spenders in 2018 (US\$ billion).

<b>Countries</b>	<b>In current 2018 US\$ Billion</b>
USA	\$649
Canada	\$21.6
UK	\$50
France	\$63.8
Germany	\$49.5
Italy	\$27.8
Turkey	\$19.0
Russia	\$61.4
Brazil	\$27.8
Saudi Arabia	\$67.6
India	\$66.5
China	\$250
South Korea	\$43.1
Japan	\$46.6
Australia	\$26.7

Fundamental military problems can be divided into two parts as problems related to planning of resources and operational problems (Wilkins & Desimone, 1993). Each problem has its own structure, characteristics and objective. Since the First World War, OR/MS techniques have been used in military for both planning and other operational problems (Karatas, Razi, & Gunal, 2017). These techniques have enormous impact on planning and managing military operations. Recent advances and developments in optimization techniques have enabled solving larger and more complex problems, resulting in high quality solutions in less computation times. Due to the great contribution of these modelling approaches, military services have saved money and operational research has led to the establishment of the department in many military units. However, operations research techniques are insufficient to completely solve the problems of managers in various decision environments. Some problems restrict the use of operations research techniques such as the difficulty of providing data in accordance with the established model, taking the parametric values used in decision-

making, taking even long-time solutions on the computer, and not allowing the use of non-numerical or linguistic information.

In recent years, fuzzy MCDM approaches have been introduced for various decision-making (DM) problems. The DM process can be categorized as three classes according to the decision environment. These are decision-making under certainty, under risk, and under uncertainty. The focus of this study is to give a brief overview of fuzzy set applications and approaches for military decisions faced under uncertainty. The main contributions of this study are: (i) investigating the most commonly used fuzzy sets in literature, (ii) examining new trends in fuzzy sets theory, and (iii) provide a brief literature review of fuzzy set applications in military problems.

The following section presents an overview of fuzzy set theory and fuzzy sets extensions. Review of literature on military applications that implement fuzzy sets are given in the next section. This section focuses on the literature review and around military applications in an uncertain environment. Final section discusses our results and summarizes our findings.

## **2. FUZZY SET THEORY AND FUZZY SETS EXTENSION**

The fundamentals of fuzzy sets were introduced by Zadeh (1965) to capture uncertainty and vagueness in knowledge. There have been published various fuzzy sets based studies in the literature that deal with uncertainty. Since 1965, fuzzy sets have been successfully implemented in various real-world applications to model uncertainty.

Fuzzy set, fuzzy logic and fuzzy system concepts provide a specific solution by processing linguistic information which is also provided by experts. While each linguistic knowledge corresponds to a fuzzy set, membership degree functions in these fuzzy sets can be decided by making personal preferences. Additionally, due to their capability of providing intermediate values (between mathematical expressions) fuzzy set theory is useful for modelling uncertainty and vagueness (Tozan, Karatas, & Vayvay, 2018). The main purpose of fuzzy logic systems that allow the modeling of daily spoken language is to consider how to solve this language by using this linguistic information (Karaköse & Akın, 2004; Karatas 2017; Karatas &

Akman, 2014; Karatas, 2020). Different types of fuzzy sets and their extensions are explained below:

### 2.1. Type-1 Fuzzy Sets

The concept of Type-1 fuzzy set theory was introduced by Zadeh (1965). A Type-1 fuzzy set is a generalization of a crisp set and single variable which is two-dimensional. It is presented on a universe of discourse  $X$ .

$$A = \{(x, \mu_A(x)) | x \in X\}$$

Where  $\mu_A(x)$  denotes the degree of membership of the element  $x \in X$  to the set  $A$ .  $\mu_A = X \rightarrow [0,1]$  that is a continuous grade.

When  $X$  is continuous,  $A$  can be represented as follows:

$$A = \int_x \mu_A(x)/x$$

The integral sign does not show integration, it shows the collection of all points  $x \in X$ . When  $X$  is discrete,  $A$  can be represented as follows:

$$A = \sum_x \mu_A(x)/x$$

The summation sign does not Show arithmetic addition, it shows the collection of all points  $x \in X$ . It represents the set theoretic operation of union.

### 2.2. Type-2 Fuzzy Sets (T2FSs)

There are two types of T2FSs which consist of general and interval T2FSs, respectively. The concept of general Type-2 fuzzy sets was originally defined by Zadeh in 1975 (Zadeh, 1975) as a generalized and extended traditional fuzzy sets to cope with uncertainty of membership function that is fuzzy and three-dimensional, which provide additional design degrees of freedom (Mendel et al., 2006).

Type-2 fuzzy sets denote  $\tilde{A}$  that belongs to  $X$  universal set. It can be defined as follows (Mendel et al., 2006):

$$\tilde{A} = \{(x, u), \mu_{\tilde{A}}(x, u) | \forall x \in X, \quad \forall u \in J_x \subseteq [0,1], \quad 0 \leq \mu_{\tilde{A}}(x, u) \leq 1\}$$

Where  $J_x$  denotes  $[0, 1]$ .

### 2.3. Interval Type-2 Fuzzy Sets (IT2FSs)

IT2FS developed by Mendel et al. (2006). IT2FS is a simplified version of Type-2 fuzzy set and characterized by two membership functions. An IT2FS allows us to incorporate the uncertainty about the membership function into the fuzzy set theory (Figueroa García, 2015; Deveci, Akyurt, & Yavuz, 2018; Eyoh, John, De Maere, & Kayacan, 2018; Naim & Hagrass, 2012).

IT2FS  $\tilde{A}$  are shown in Figure 1. The footprint of uncertainty (FOU) can be illustrated in Figure 1 as the blue shaded region (Mendel et al., 2006). Some basic definitions are presented as follows (Mendel et al., 2006; Lee & Chen, 2008):

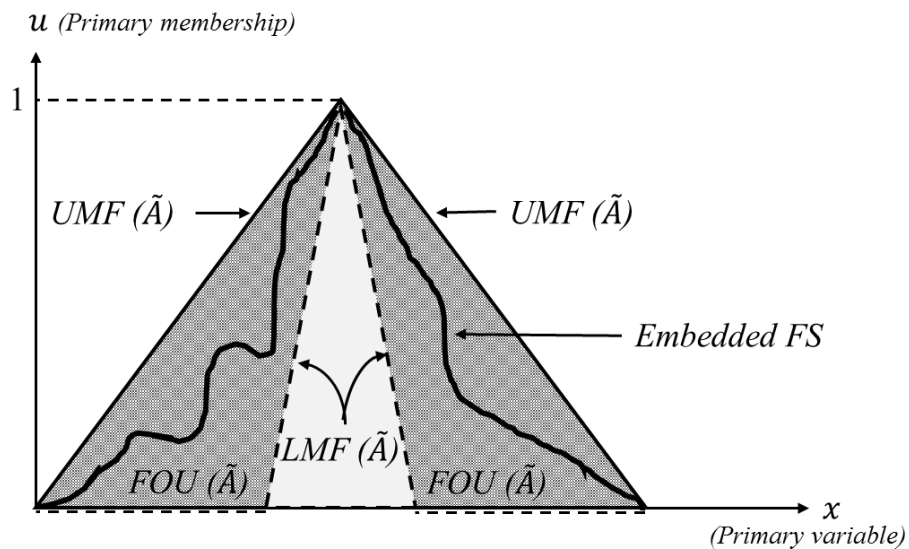

**Figure 1.** Interval Type-2 fuzzy set  $\tilde{A}$  (lower and upper membership function can be denoted as LMF and UMF, respectively).

An IT2FS  $\tilde{A}$  can also be stated as follows (Mendel & John, 2002):

$$\tilde{A} = \int_{x \in X} \int_{u \in J_x} \mu_{\tilde{A}}(x, u) / (x, u)$$

Let  $\mu_{\tilde{A}}$  states a Type-2 membership function.  $\tilde{A}$  Type-2 fuzzy set can be defined as follows (Mendel et al., 2006):

$$\tilde{A} = \int_{x \in X} \int_{u \in J_x} 1 / (x, u),$$

Where  $J_x \subseteq [0,1]$ .

#### **2.4. Interval-Valued Fuzzy Sets (IVFs)**

The concept of IVFs which has interval-valued membership function is introduced by Sambuc in 1975 (Bustince Sola et al., 2014). In the theory of fuzzy sets, it is often difficult to express an expert's opinion exactly on an interval  $[0, 1]$ . Therefore, it is more appropriate to show this degree of accuracy with an interval. Sambuc (1975) and Grattan (1976) stated that it is not enough to present a linguistic expression in the form of fuzzy sets. An IVSs  $A$  expressed on  $(-\infty, +\infty)$  is represented as follows (Ashtiani, Haghghirad, Makui, & Ali Montazer, 2009; Stanujkic, Zavadskas, Brauers, & Karabasevic, 2015).

$$A = \{(x, [x, [\mu_A^L(x), \mu_A^U(x)])])\}$$

$$\mu_A^L(x), \mu_A^U(x): X \rightarrow [0,1] \quad \forall x \in X, \quad \mu_A^L(x) \leq \mu_A^U(x)$$

$$\mu_A(x) = [\mu_A^L(x), \mu_A^U(x)]$$

Where  $\mu_A^L(x)$  and  $\mu_A^U(x)$  indicate the lower and upper limit of membership degree, respectively.

### 2.5. Intuitionistic Fuzzy Sets (IFSs)

The concept of IFS is presented Atanassov (1986), which are characterized by member and non-member function. IFS are an extended version of fuzzy set. An intuitionistic fuzzy set  $A$  in  $X$  is of the form (Atanassov, 1986; Afful-Dadzie, Oplatkova, & Prieto, 2017):

$$A = \{(x, \mu_A(x), \nu_A(x)) | x \in X \rightarrow [0,1]\}$$

Where  $\mu_A(x)$  and  $\nu_A(x)$  are denoted as the degree of membership function and degree of non-membership function, respectively. These membership functions are restricted by  $0 \leq \mu_A(x) + \nu_A(x) \leq 1$ .

And the intuitionistic index (called hesitation) can also be added by Atanassov, given as follows:

$$\pi_A(x) = 1 - \mu_A(x) - \nu_A(x)$$

Where  $0 \leq \pi_A(x) \leq 1$  for each  $x \in X$  and  $\pi_A(x) + \mu_A(x) + \nu_A(x) = 1$ .

### 2.6. Hesitant Fuzzy Sets

Hesitant fuzzy sets (HFS) were proposed by Torra (2010) as a new extension of fuzzy sets to allow the membership degree of an element to be assigned. HFSs are powerful tools for managing simultaneous sources of uncertainty and can better describe the situation (Zhang, Ju, & Liu, 2017).  $H$  is the set of all HFSs that can be expressed mathematically in the following form (Xia & Xu, 2011):

$$H = \{(x, h_H(x)) | x \in X\}$$

Where  $h_H(x)$  is a set of hesitant fuzzy elements in  $[0, 1]$ .

### 2.7. Pythagorean Fuzzy Sets (PFSs)

PFS is a generalized concept of intuitionistic fuzzy sets and introduced by Yager & Abbasov (2013). PFS is a new tool to handle the uncertainty considering the membership grades (Yager, 2016).

$$P = \{(x, P(\mu_P(x), \nu_P(x))) | x \in X\}$$

Where  $\mu_P(x), \nu_P(x) \rightarrow [0,1]$  and  $\mu_P^2(x) + \nu_P^2(x) \leq 1$  for each  $x \in X$ .  $\mu_P(x)$  and  $\nu_P(x)$  are the membership and the non-membership degree of the



element  $x$  to  $X$  in  $P$ , respectively. The hesitant degree  $(\pi_P(x))$  of  $x \in X$  is defined as follows:

$$\pi_P(x) = \sqrt{1 - \mu_P^2(x) - v_P^2(x)}$$

### **2.8. Neutrosophic Fuzzy Sets**

Neutrosophic sets (NSs) and logic which presented by Smarandache (1999) are the generalized the intuitionistic fuzzy sets. It allows cooperation on indeterminacy, hesitation and/or uncertainty. A NS can be characterized by a truth, an indeterminacy, and a falsity membership function. In neutrosophic sets, all three measures are independent and each one can be independently equal to 1 and therefore the sum of these grades can be added up to 3 (Smarandache, 1999; Haibin, Smarandache, Zhang, & Sunderraman, 2010).

$$A = \{ \langle x, (T_A(x), I_A(x), F_A(x)) \rangle | x \in X \}$$

Where  $T_A(x)$ ,  $I_A(x)$  and  $F_A(x)$  denote the truth, indeterminacy and falsity-membership function.

$$0 \leq T_A(x) + I_A(x) + F_A(x) \leq 3$$

### **2.9. Spherical Fuzzy Sets**

Spherical fuzzy set (SFS) is one of the extensions of intuitionistic fuzzy sets introduced by Kutlu & Kahraman (2019). A SFS can be defined as follow:

$$0 \leq \mu_A^2(x) + v_A^2(x) + \pi_A^2(x) \leq 1 \quad \forall x \in X$$

Where  $\mu_P(x)$ ,  $v_P(x)$  and  $\pi_P(x)$  denote the degree of membership, non-membership and hesitancy of  $x$ , respectively.

## **3. LITERATURE REVIEW ON MILITARY APPLICATIONS**

Researchers have been attracted to consider fuzzy sets related problems in the previous works. Different decisions related with the military operations such as weapon selection, arms transfers, vehicle selection problems have

been studied on the literature. Table 2 presents some studies on fuzzy MCDM based military applications.

The weapon selection problem has been proposed for different conditions and decision in the military operations. A weapon selection problem is a complex structure which includes multi-factors in multi-level with multi-hierarchy (Cheng, 1999). The fuzzy sets are suitable for this aim. In the Cheng's (1999) study, three missile systems are evaluated by considering tactics, technology, maintenance, economy and advancement criteria. Li, Huang, & Chen, (2010) proposed a new methodology that considers heterogeneous multi attribute group decision problems by measuring differences between positive and negative ideal solutions via weighted Minkowski distance. They illustrated the proposed approach with solving mission weapon system selection problem for three alternatives with the criteria that are airspace, time, target, missile, anti-jamming performance, shooting availability, maneuverability, man-machine design, C3 function, reliability engineering design, plan expense, expansibility, development schedule and risk. Yang, Wang, Xu, & Li (2014) proposed a fuzzy multi attribute decision making approach for weapon selection problem. The entropy method is applied to evaluate the weights of the criteria and the fuzzified TOPSIS method ranks the order of weapon systems. A case study conducted with seven criteria and three alternatives for missile system selection. Wang, Wang, Xu, & Ni (2014) proposed also weapon selection problem by extending fuzzy measures with dual hesitant fuzzy sets.

Aircrafts are vital for air-force and the selection of the aircrafts is one of the most complex and important problem in the air-forces. Sánchez-Lozano, Serna, & Dolón-Payán (2015) consider an aircraft selection problem in the Spanish Air-Force. They focused both technical and other criteria such as service, human and flying factors together and criteria weighted with analytical hierarchy process. Then, the best aircraft for training is evaluated by TOPSIS method.

Another vehicle selection problem arises in unmanned aerial vehicle assessment and selection domain. As an example, Lin & Hung (2011) proposed a new approach of fuzzy weighting average algorithm for unmanned aerial vehicle selection problem and developed a user-interface for this approach. Mission flexibility, operational suitability and operational

assessment are selected as a main criterion and two-level hierarchical criteria are used for this aim. David, Octavio, David, & Victor (2015) considered autopilots in unmanned aerial vehicles which provides autonomously movements to aircraft. In this study, authors developed a fuzzy based system. The interested reader is also recommended Yakıcı, Karatas, & Yılmaz (2019), Yılmaz, Yakıcı, & Karatas (2019) and Karatas et al. (2019) for a review of UAV planning problems observed in defence and military.

Some management issues also need some decision-making such as human resources decisions. Moon, Lee, & Lim (2010) considers a human resource management topic in the military which is promotion ranking system in Korea. This new system screens the progress on promotion of the candidates with the service rating, multi-area aptitude, growth potential and innovativeness criteria. Fuzzy sets did not apply only MCDM problems in military applications but also other decision-making problems. Bean, Joubert, & Luhandjula (2016) proposed a single item inventory management problem with fuzzy-stochastic multi-objective modeling for considering uncertainties. The proposed approach compared with the classical inventory control approach for different scenarios. Braathen & Sendstad (2004) proposed a simulation game model which is based on fuzzy logic constraint satisfaction problem for a military headquarters' decision process. The application is two-fold as the games for air and land operations. Proposed model enables lots of different actions in the system. Similar management problems such as conflict analysis are studied in the Sutoyo, Mungad, Hamid, & Herawan's study (2016) which is based on soft-set theory. Lu & Wang (2011) proposed a MCDM problem for industrial cooperation program strategies. By using an alternative approach for classical systems, Taiwan's industrial cooperation program offset's is evaluated by policy, ability, economy and environment criteria. Analytical hierarchy process with fuzzy sets is applied for this aim.

There are lots of operational issues and missions in the military and it makes vital to operational decisions and operational decision-making capability in the military systems. Khanmohammadi, Dagli, & Esfahlani (2012) predicted the irregular human behavior during the stressful missions by using fuzzy inference approach. The data obtained from the facial,

movement, environmental and deliberating factors are evaluated with fuzzy inference systems to predict potential irregular behaviors in order to avoid failure on different military missions. Palaniappan, Zein-Sabatto, & Sekmen (2001) studied a multi-objective optimization problem with genetic algorithm for war resource allocation decisions. Multi-objective nature of problems is generally faced on the optimization decisions and in that study, authors proposed a genetic algorithm approach for handling this multi-objective problem. Fuzzy logic systems were used for setting genetic algorithm.

Another problem on the military decision making domain is related to arms transfers. Sanjian (2003) proposed a fuzzy system based models for arms transfers and their impacts of United States and Union of Soviet Socialist Republics. Some decisions were fuzzified such as political relationship, arms import and transfers and the relations were summarized. Juan, Huapu, Xu, Xianfeng, & Huijun (2014) considered the military path selection problem with data envelopment analysis and multi-objective fuzzy decision-making approach. Travel time, risks, response capability and costs were selected as parameters on the decisions.

Fuzzy set qualitative comparative analysis was applied for explaining the effects of NATO's military campaign in Libya (Haesebrouck, 2017). The study integrates burden sharing with balancing threats, politics, and domestic constraints.

The information systems in the military operations are coming crucial with the digitalization. Therefore, software systems related problems are arisen. Fuzzy sets are very important tool in also software coding. In the study of Schenker & Khoshgoftaar (1998), fuzzy case-based reasoning was proposed for fault identifying of a software metrics. The case study was conducted from a military command, control and communication system in order to show the proposed approach's performance. Arulkumaran & Gnanamurthy (2019) proposed a fuzzy-based attack detection system on the mobile adhoc network. The study specifically focused on black hole attacks with considering certificate, energy, packet and trust criteria.

Navy forces have some decisions in the sub-marine systems. Son, Park, & Joo (2014) focused an underwater sub-marine application of fuzzy sets. In

the study, authors proposed a fuzzy  $c$ -means clustering algorithm for detecting a target by using sonar system. Radar signals processing have one of the main applications in the military operations. Salim, Abdel-Aty-Zohdy, & Zohdy (2010) proposed a new approach called as hyper-fuzzy model that ensures to incorporation between variables with historical learning and output predictions in the radar processing.

**Table 2.** Some studies on military problems using MCDM approaches.

Author(s)	Year	Main-criteria	Sub-criteria	Number of alternatives	MCDM problem	Fuzzy numbers	TOPSIS	AHP	FWA	Integral	DEA
Cheng	1999	5	23	3	Evaluating weapon system	Yes					
Li et al.	2010	14	39	3	Weapon system selection	Yes	x				
Moon et al.	2010	4	-	10	Appraisal and promotion ranking system	Yes					
Lin & Hung	2011	3	16	4	Evaluating unmanned aerial vehicle	Yes			x		
Lu & Wang	2011	4	20	6	Evaluating ICP Transactions types	Yes		x		x	
Yang et al.	2014	-	-	-	Weapon system selection	Yes	x				
Wang et al.	2014	-	-	-	Evaluating weapon system	Yes	x				
Juan	2014	3	-	5	Military transport path selection	Yes					x
Sánchez-Lozano et al.	2015	12	-	5	Evaluating military training aircrafts	Yes	x	x			
Sánchez-Lozano and Rodriguez	2020	-	13	4	Training aircraft selection	Yes		x			

#### **4. CONCLUSION**

This study attempts to fill this gap in the military problems that include MCDM applications using fuzzy sets in the current literature. Researchers tend to use different MCDM methods for different problems. There are lots of different MCDM approaches which are used for different aims. Therefore, different fuzzified methods can be used for different problems such as weapon selection problem, resource allocation problems and resource transferring problems.

Data management and cyber security is becoming vital not only the industry but also in the military. Therefore, software systems and cyber security related works is getting valuable for this area. Furthermore, fuzzy sets are easily converted to a decision support system by developing the user-interface can be found in some studies. The computational complexity of the related problems is easily handled with this approach and the systems may change to an expert system by using artificial intelligence methods including fuzzy sets, meta-heuristics (genetic algorithms i.e.), artificial neural networks. Meta-heuristics approaches are preferred to solve complex and combinatorial search problems by many researchers as well as practitioners. These approaches especially are classified with considering their characteristics such as the nature of the search process and use of memory.

Fuzzy sets and meta-heuristic approaches can also be used together in military problems. Firstly, fuzzy sets for importance rates of alternatives can be investigated as in the same manner as proposed for importance of criteria. Secondly, genetic algorithm can be used to see how it provides quality solutions where a large enough population is set. Finally, the problem can be solved using one of the multi-objective optimization algorithms defining a second objective. There are some weaknesses despite the advantages of using fuzzy logic. For example, fuzzy logic depends very much on the expert experience of the rules used in control problem. Since membership functions are found by trial, there may be a waste of time. So it can be less reliable than it is heuristic approach. Therefore, there may be some criticisms for its use in military problems. In addition, the membership

functions can be improved and configured in order to handle uncertainty within the fuzzy sets using well-known meta-heuristics.

There are many different fuzzy sets considered in different military applications. The advantages of fuzzy sets are capable of modeling potentially different types of uncertainty and vagueness. It is also expected that the usage of various types of fuzzy sets such as fermatean fuzzy sets, nonstationary fuzzy sets, picture fuzzy sets, Q-rung orthopair fuzzy sets (q-ROFs) or rough sets introduced in recent years are widely used in the military problems. In addition, different MCDM approaches such as AHP, TOPSIS, VIKOR, TODIM, WASPAS, DEMATEL, COPRAS and so on can be used for military decision making problems.



## REFERENCES

- Afful-Dadzie, E., Oplatkova, Z. K., & Prieto, L. A. B. (2017). "Comparative State-of-the-art Survey of Classical Fuzzy Set and Intuitionistic Fuzzy Sets in Multi-criteria Decision Making", *International Journal of Fuzzy Systems*, 19(3), 726-738.
- Arulkumaran, G., & Gnanamurthy, R. K. (2019). "Fuzzy Trust Approach for Detecting Black Hole Attack in Mobile Adhoc Network", *Mobile Networks and Applications*, 24(2), 386-393.
- Ashtiani, B., Haghghirad, F., Makui, A., & Ali Montazer, G. (2009). "Extension of Fuzzy TOPSIS Method Based on Interval-valued Fuzzy Sets", *Applied Soft Computing*, 9(2), 457-461.
- Bean, W. L., Joubert, J. W., & Luhandjula, M. K. (2016). "Inventory Management Under Uncertainty: A Military Application", *Computers & Industrial Engineering*, 96, 96-107.
- Braathen, S., & Sendstad, O. J. (2004). "A Hybrid Fuzzy Logic/Constraint Satisfaction Problem Approach to Automatic Decision Making in Simulation Game Models", *IEEE Transactions on Systems, Man, and Cybernetics, Part B (Cybernetics)*, 34(4), 1786-1797.
- Bustince Sola, H., Fernandez, J., Hagraas, H., Herrera, F., Pagola, M., & Barrenechea, E. (2014). "Interval Type-2 Fuzzy Sets Are Generalization of Interval-valued Fuzzy Sets: Toward a Wider View on Their Relationship", *IEEE Transactions on Fuzzy Systems*, 23(5), 1876-1882.
- Cheng, C. H. (1999). "Evaluating Weapon Systems Using Ranking Fuzzy Numbers", *Fuzzy Sets and Systems*, 107(1), 25-35.
- David, V. R., Octavio, G. R., David, B. M., & Victor, E. C. (2015, July). Analysis, Design, and Implementation of an Autopilot for Unmanned Aircraft-UAV's Based on Fuzzy Logic. In *Asia-Pacific Conference on Computer Aided System Engineering* (pp. 196-201). IEEE.

Deveci, M., Akyurt, I. Z., & Yavuz, S. (2018). "A GIS-based Interval Type-2 Fuzzy Set for Public Bread Factory Site Selection", *Journal of Enterprise Information Management*. 31(6), 820-847.

Eyoh, I., John, R., De Maere, G., & Kayacan, E. (2018). "Hybrid Learning for Interval Type-2 Intuitionistic Fuzzy Logic Systems as Applied to Identification and Prediction Problems", *IEEE Transactions on Fuzzy Systems*, 26(5), 2672-2685.

Figuroa García, J. C. (2015). "On the Fuzzy Extension Principle for LP Problems with Interval Type-2 Technological Coefficients", *Ingeniería*, 20(1), 101-110.

Grattan-Guinness, I. (1976). "Fuzzy Membership Mapped onto Intervals and Many-Valued Quantities". *Zeitschrift Für Mathematische Logik Und Grundlagen Der Mathematik*, 22(1), 149–160.

Haesebrouck, T. (2017). "NATO Burden Sharing in Libya: A Fuzzy Set Qualitative Comparative Analysis", *Journal of Conflict Resolution*, 61(10), 2235-2261.

Wang, H., Smarandache, F., Zhang, Y., & Sunderraman, R. (2010). "Single Valued Neutrosophic Sets", *Infinite Study*.

Juan, W., Huapu, L., Xu, S., Xianfeng, L., & Huijun, Y. (2014). "The Best Path Analysis in Military Highway Transport Based on DEA and Multiobjective Fuzzy Decision-making", *Mathematical Problems in Engineering*, 2014, 1-6.

Karaköse, M., & Akın, E. (2004). "Tip-1 Bulanık Sistemlerde Tip-2 Bulanık Girişler". *ELECO (Elektrik, Elektronik ve Bilgisayar Mühendisliği Sempozyumu ve Fuarı) Bildiriler Kitabı*, 8-10.

Karatas, M. (2020). "Hydrogen Energy Storage Method Selection Using Fuzzy Axiomatic Design and Analytic Hierarchy Process". *International Journal of Hydrogen Energy*, 45(32), 16227-16238.

Karatas, M. (2017). "Multiattribute Decision Making Using Multiperiod Probabilistic Weighted Fuzzy Axiomatic Design". *Systems Engineering*, 20(4), 318-334.

Karatas, M., & Akman, G. (2014). "An Extension to Multi-Attribute Decision Making Method: Dynamic Fuzzy Axiomatic Design Approach". In *Joint International Symposium on CIE44 and IMSS'14 Proceedings*.

Karatas, M., Razi, N., & Gunal, M. M. (2017). "An ILP and Simulation Model to Optimize Search and Rescue Helicopter Operations". *Journal of the Operational Research Society*, 68(11), 1335-1351.

Karatas, M., Yakıcı, E., & Razi, N. (2019). "Military Facility Location Problems: A Brief Survey". In *Operations Research for Military Organizations* (pp. 1-27). IGI Global.

Khanmohammadi, S., Dagli, C. H., & Esfahlani, F. Z. (2012). "A Fuzzy Inference Model for Predicting Irregular Human Behaviour During Stressful Missions", *Procedia Computer Science*, 12, 265-270.

Kutlu Gündoğdu, F., & Kahraman, C. (2019). "Spherical Fuzzy Sets and Spherical Fuzzy TOPSIS Method". *Journal of Intelligent & Fuzzy Systems*, (Preprint), 1-16.

Lee, L. W., & Chen, S. M. (2008, July). "Fuzzy Multiple Attributes Group Decision-making Based on the Extension of TOPSIS Method and Interval Type-2 Fuzzy Sets". In *International Conference on Machine Learning and Cybernetics* (Vol. 6, pp. 3260-3265). IEEE.

Li, D. F., Huang, Z. G., & Chen, G. H. (2010). "A Systematic Approach to Heterogeneous Multiattribute Group Decision Making". *Computers & Industrial Engineering*, 59(4), 561-572.

Lin, K. P., & Hung, K. C. (2011). "An Efficient Fuzzy Weighted Average Algorithm for the Military UAV Selecting Under Group Decision-making". *Knowledge-Based Systems*, 24(6), 877-889.

Lu, W. M., & Wang, T. C. (2011). "A Fuzzy Multi-criteria Model for the Industrial Cooperation Program Transaction Strategies: A Case in Taiwan". *Expert Systems with Applications*, 38(3), 1490-1500.

Mendel, J. M., & John, R. B. (2002). "Type-2 Fuzzy Sets Made Simple". *IEEE Transactions on Fuzzy Systems*, 10(2), 117-127.

Mendel, J. M., John, R. I., & Liu, F. (2006). "Interval Type-2 Fuzzy Logic Systems Made Simple". *IEEE Transactions on Fuzzy Systems*, 14(6), 808-821.

Moon, C., Lee, J., & Lim, S. (2010). "A Performance Appraisal and Promotion Ranking System Based on Fuzzy Logic: An Implementation Case in Military Organizations". *Applied Soft Computing*, 10(2), 512-519.

Naim, S., & Hagrass, H. (2012, June). "A Hybrid Approach for Multi-criteria Group Decision Making Based on Interval Type-2 Fuzzy Logic and Intuitionistic Fuzzy Evaluation". In *IEEE International Conference on Fuzzy Systems* (pp. 1-8). IEEE.

Palaniappan, S., Zein-Sabatto, S., & Sekmen, A. (2001). "Dynamic Multiobjective Optimization of War Resource Allocation Using Adaptive Genetic Algorithms". *IEEE*, pp. 160-165.

Salim, O. M., Abdel-Aty-Zohdy, H. S., & Zohdy, M. A. (2010, July). Hyper-fuzzy Modeling and Control for Bio-inspired Radar Processing. In *Proceedings of the IEEE 2010 National Aerospace & Electronics Conference* (pp. 392-395). IEEE.

*Survey on Military Applications of Fuzzy Set Theory and its Applications*

Sambuc, R. (1975). Fonctions and Floues: Application a`l'aide Au Diagnostic en Pathologie Thyroïdienne (Doctoral dissertation). *University of Marseille*.

Sánchez-Lozano, J. M., Serna, J., & Dolón-Payán, A. (2015). "Evaluating Military Training Aircrafts Through the Combination of Multi-criteria Decision-Making Processes With Fuzzy Logic. A Case Study in the Spanish Air Force Academy". *Aerospace Science and Technology*, 42, 58-65.

Sánchez-Lozano, J. M., & Rodríguez, O. N. (2020). "Application of Fuzzy Reference Ideal Method (FRIM) to the Military Advanced Training Aircraft Selection". *Applied Soft Computing*, 88, 106061.

Sanjian, G. S. (2003). "Arms Transfers, Military Balances, and Interstate Relations: Modeling Power Balance Versus Power Transition Linkages". *Journal of Conflict Resolution*, 47(6), 711-727.

Schenker, D. F., & Khoshgoftaar, T. M. (1998, November). "The Application of Fuzzy Enhanced Case-based Reasoning for Identifying Fault-prone Modules". In *Proceedings of the Third IEEE International High-Assurance Systems Engineering Symposium* (Cat. No. 98EX231) (pp. 90-97). IEEE.

SIPRI Military Expenditure Database (2018). Retrieved from <https://www.sipri.org/databases/milex>.

SIPRI Yearbook (2018). Armaments, Disarmament and International Security. Retrieved from [https://www.sipri.org/sites/default/files/2018-06/yb\\_18\\_summary\\_en\\_0.pdf](https://www.sipri.org/sites/default/files/2018-06/yb_18_summary_en_0.pdf)

Smarandache, F. (1999). *A Unifying Field in Logics: Neutrosophic Logic. Neutrosophy, Neutrosophic Set, Neutrosophic Probability*. American Research Press.

Son, H. S., Park, J. B., & Joo, Y. H. (2014). “Fuzzy C-means-based Intelligent Tracking Algorithm for an Underwater Manoeuvring Target”. *IET Radar, Sonar & Navigation*, 8(9), 1042-1050.

Sutoyo, E., Mungad, M., Hamid, S., & Herawan, T. (2016). “An Efficient Soft Set-based Approach for Conflict Analysis”. *PloS One*, 11(2): e0148837. doi:10.1371/journal.pone.014883.

Stanujkic, D., Zavadskas, E. K., Brauers, W. K., & Karabasevic, D. (2015). “An Extension of the MULTIMOORA Method for Solving Complex Decision-making Problems Based on the Use of Interval-valued Triangular Fuzzy Numbers”. *Transformations in Business & Economics*, 14(2B), 355-377.

Torra, V. (2010). “Hesitant Fuzzy Sets”. *International Journal of Intelligent Systems*, 25(6), 529-539.

Tozan, H., & Karatas, M. (Eds.). (2018). *Operations Research for Military Organizations*. IGI Global, Hershey PA, USA 17033. doi:10.4018/978-1-5225-5513-1.

Tozan, H., Karatas, M., & Vayvay, O. (2018). “Reducing Demand Signal Variability via a Quantitative Fuzzy Grey Regression Approach”. *Tehnički Vjesnik*, 25(Supplement 2), 411-419.

Wang, L., Wang, Q., Xu, S., & Ni, M. (2014, May). “Distance and Similarity Measures of Dual Hesitant Fuzzy Sets With Their Applications to Multiple Attribute Decision Making”. In *IEEE International Conference on Progress in Informatics and Computing* (pp. 88-92). IEEE.

Wilkins, D. E., & Desimone, R. V. (1993). “Applying an AI Planner to Military Operations Planning”. *Sri International Menlo Park Ca* (Technical No. SRI-TN-534).

Xia, M., & Xu, Z. (2011). "Hesitant Fuzzy Information Aggregation in Decision Making". *International Journal of Approximate Reasoning*, 52(3), 395-407.

Yager, R. R., & Abbasov, A. M. (2013). "Pythagorean Membership Grades, Complex Numbers, and Decision Making". *International Journal of Intelligent Systems*, 28(5), 436-452.

Yager, R. R. (2016). Properties and Applications of Pythagorean Fuzzy Sets. In P. Angelov, & S. Sotirov (Eds.), *Imprecision and Uncertainty in Information Representation and Processing* (pp. 119-136). Springer, Cham.

Yakıcı, E., Karatas, M., and Yılmaz, O. (2019). The Problem of Locating and Routing Unmanned Aerial Vehicles. In H. Tozan, & M. Karatas (Eds.), *Operations Research for Military Organizations* (pp. 28-53). Hershey, PA: IGI Global.

Yang, S., Wang, S., Xu, X., & Li, G. (2014, August). "A Hybrid Multiple Attribute Decision-making Approach for Evaluating Weapon Systems Under Fuzzy Environment". In *11th International Conference on Fuzzy Systems and Knowledge Discovery (FSKD)* (pp. 204-210). IEEE.

Yılmaz, O., Yakıcı, E., & Karataş, M. (2019). "A UAV Location and Routing Problem with Spatio-temporal Synchronization Constraints Solved by Ant Colony Optimization". *Journal of Heuristics*, 25, 673-701.

Zadeh, L. A. (1965). "Fuzzy Sets". *Information and Control*, 8(3), 338-353.

Zhang, W., Ju, Y., & Liu, X. (2017). "Multiple Criteria Decision Analysis Based on Shapley Fuzzy Measures and Interval-valued Hesitant Fuzzy Linguistic Numbers". *Computers & Industrial Engineering*, 105, 28-38.





*Journal of Naval Sciences and Engineering*  
2020, Vol. 16, No.2, pp. 143-170  
*Mechanical Engineering/Makine Mühendisliđi*

RESEARCH ARTICLE

*\*An ethical committee approval and/or legal/special permission has not been required within the scope of this study.*

**ENERGY SYSTEM ANALYSIS AND MODELLING OF AN  
ELECTRIC POWERED FERRY\***

**Fatih YILMAZ<sup>1</sup>**  
**Egemen SULUKAN<sup>2</sup>**

<sup>1</sup> *National Defence University, Barbaros Naval Sciences and Engineering  
Institute, Department of Marine Engineering, Istanbul, Turkey,  
yilmazf58@gmail.com; ORCID: 0000-0001-5652-0265*

<sup>2</sup> *National Defence University, Turkish Naval Academy, Department of  
Mechanical Engineering, Istanbul, Turkey,  
esulkan@dho.edu.tr; ORCID: 0000-0003-1138-2465*

**Date of Receive: 08.05.2020**

**Date of Acceptance: 16.09.2020**

### ABSTRACT

*Today, approximately 85% of world trade is carried out by sea and ships are indispensable elements of transportation, logistics and trade. But on the other hand, approximately 2.5% of global green gas emissions, which have adverse effects on air quality and public health, is originated from ships and maritime transportation activities. Considering this situation, the International Maritime Organization promotes the use of renewable/alternative energy sources on ships, rather than fossil fuels. In the 11<sup>st</sup> Development Plan of Republic of Turkey, it is also aimed to convert the ships used for vehicle and passenger transportation in a short distance into “all-electric” concept. In this study, energy system analysis and modelling of a new generation ferry with a diesel electric propulsion system, which is used for vehicle and passenger transportation, have been carried out by using the Reference Energy System approach and Long-range Energy Alternatives Planning System software. In conclusion of the study, results of analysis related to the ferry’s energy system, which also include theoretical emission estimates for conversion scenario of the ferry’s energy system into hybrid concept, have been presented. Additionally, some suggestions for increasing energy efficiency of the ferry have been presented as well.*

**Keywords:** *Ship Energy Efficiency, Ship Energy System Analysis, Reference Energy System, Electrical Ships, Marine Technology.*

**ELEKTRİKLE ÇALIŞAN BİR FERİBOTUN ENERJİ SİSTEM  
ANALİZİ VE MODELLENMESİ**

**ÖZ**

*Günümüzde, dünya ticaretinin yaklaşık %85'i deniz yolu ile yapılmakta olup gemiler, ulaştırma, lojistik ve ticaretin vazgeçilmez unsurlarıdır. Ancak öte yandan, küresel sera gazı emisyonlarının yaklaşık %2.5'i gemilerden ve deniz taşımacılığı faaliyetlerinden kaynaklanmakta, emisyonların hava kalitesi ve insan sağlığına olumsuz etkileri bulunmaktadır. Bu durumu göz önünde bulunduran Uluslararası Denizcilik Örgütü, gemilerde fosil yakıt yerine yenilenebilir/alternatif enerji kaynaklarının kullanımını teşvik etmektedir. Ülkemizin 11. Kalkınma Planı'nda da kısa mesafeli araç ve yolcu taşımacılığında kullanılan gemilerin "tam elektrikli" hale dönüştürülmesi hedeflenmektedir. Bu çalışmada; Referans Enerji Sistemi yaklaşımı ve Long Range Energy Alternatives Planning System yazılımı kullanılarak, deniz ulaşımında kullanılan yeni nesil diesel elektrik tahrikli bir arabalı feribotun enerji sistem modellemesi ve analizi yapılmıştır. Çalışmanın sonucunda, feribotun enerji sisteminin hibrit konseptte dönüşüm senaryosu için teorik emisyon tahminleri de dahil olmak üzere feribotun enerji sistemine ilişkin analiz sonuçları sunulmuştur. Ayrıca feribotun enerji verimliliğinin artırılmasına yönelik de bazı öneriler de sunulmuştur.*

**Anahtar Kelimeler:** *Gemi Enerji Verimliliği, Gemi Enerji Sistem Analizi, Referans Enerji Sistemi, Elektrikli Gemiler, Deniz Teknolojisi.*

## **1. INTRODUCTION**

In Turkey, especially in the Marmara region, there are intensive domestic (cabotage) cargo, vehicle and passenger transportation activities by sea. İstanbul, Çanakkale and İzmir are the leading cities where the seaway is frequently used in urban transportation. Especially, İstanbul is the leading city of maritime transportation activities as well as of many other business sectors in Turkey. In Istanbul, short-distance passenger and vehicle transportation activities in scope of urban transportation, are carried out by the ships of the İstanbul Metropolitan Municipality, as well as by the passenger and vehicle ferries of private enterprises.

According to the statistics of the Ministry of Transport and Infrastructure (MoTI), number of passengers and vehicles carried by sea in domestic has significantly increased during the last 15 years. For example; the number of vehicles transported by sea in domestic was increased to 13.4 million in 2019 from 6.9 million in 2004. Similarly, the number of passengers transported by sea in domestic was also increased to 150.3 million in 2019 from 112.8 million in 2004. It is stated that providing Special Consumption Tax (ÖTV)-free fuel to the ships carrying passengers and cargo in domestic, which has been implementing since 2003, has a significant effect on those increases (MoTI, 2020).

Turkey is also aware of the importance of maritime transportation at international and domestic level, like other developed countries in the world. Although the maritime transportation has a great importance for development of transportation systems and logistics, economy and trading capacities of countries; on the other hand it is known that approximately 2,5% of global green gas emissions (GHG), which have adverse effects on air quality and public health, originates from ships and maritime transportation activities. Considering that situation, the International Maritime Organization (IMO), as the United Nations (UN) specialized agency with responsibility for the safety and security of shipping and the prevention of marine and atmospheric pollution by ships, has established very important environmental regulations during the last 15 years in accordance with the aim of reducing the Carbon dioxide (CO<sub>2</sub>) emissions from shipping and maritime sector by 50% until 2030 and by 70% until 2050, compared with the year 2008. Briefly, these regulations are related

with the Energy Efficiency Design Index (EEDI) for reducing CO<sub>2</sub> emissions of new ships, Ship Energy Efficiency Management Plan (SEEMP) and Data Collection System (DCS) for Ship Fuel Consumption for existing ships, Sulfur (S) content limits for marine fuel oil, Nitrogen oxide (NO<sub>x</sub>) emission limits for internal combustion marine engines and Emission Control Areas (ECA) in terms of NO<sub>x</sub> and Sulfur oxide (SO<sub>x</sub>) for the different sea areas of the world (IMO, 2019).

It seems so that all these regulations and their additional costs to shipowners have accelerated the maritime industry's efforts to make more use of the alternative/renewable energy sources on board ships and at sea ports. Especially in Northern European countries, which are prominent with their fjords within the ECA areas, all-electric ferries equipped with Li-ion battery energy storage technologies instead of using fossil-based fuels has already started to be widely used in maritime transportation. Many of those all-electric ferries and other kind of all-electric ships such as tug boats, ro-pax, etc. have been built in the Turkish shipyards, especially in the Yalova Shipyards Region. On the other hand, 399<sup>th</sup> item of 11st Development Plan of Turkey, which also complies with the IMO's general environmental objectives, promotes to convert the ships which are used for transportation of vehicles and passengers in a short-distance into environmentally-friendly and energy-efficient fully electrical (all-electric) ships (TBMM, 2013). So, it seems that the all-electric ships will be widely used for domestic maritime transportation in Turkey in the near future as well. However, there are very few numbers of scientific studies on the electrical ships, since they are started to be used only in the last few years.

Therefore, it is expected that this study will contribute to both relevant scientific literature and objectives of the IMO and implementation of 11st Development Plan of Turkey.

## **2. LITERATURE REVIEW**

There are many researches and studies in the national and international literature on reducing greenhouse gas emissions from ships and on increasing energy efficiency of ships. For example, Yiğit (2018) studied on ship design projects to meet ship energy demand from alternative sources

such as renewable energy sources and energy supply from the shore. Talay, Deniz and Durmuşoğlu (2014) studied on methods of increasing energy efficiency in ships, ship design practices, machinery technology, propulsion and propeller systems, operational maintenance-attitude, and expressed a number of methodological suggestions for reducing CO<sub>2</sub> emissions and increasing energy efficiency of ships. Baldi (2016) stated in his Ph.D. thesis study that heat losses occurring in the machinery systems can be recovered efficiently and thus the ship's energy efficiency can be increased, by analyzing energy and exergy to determine the energy flows and inefficiencies in the ship's energy system. Tillig et al. (2016) examined environmental and economic measures to reduce the fuel consumption and exhaust emissions of ships, and stated that in order to reduce energy consumption; the energy flow in the energy system should be analyzed at the component and subsystem level, including the interactions between components. Vassalos & Cichowicz (2014) conducted a methodological study to examine the performance-based energy efficiency of a container ship and its impact on ship design and operation. Johnson et al. (2013) evaluated IMO's Ship Energy Efficiency Management Plan (SEEMP) guide in terms of ISO 50001 standards and International Safety Management (ISM) Code requirements. Durmaz, Kalender and Ergin (2016) experimentally investigated emissions emitted from 883 kW main diesel engine of a 81 meters conventional ferry and annual emissions of the ferry were determined as 4467.3 tons of CO<sub>2</sub>, 97 tons of NO<sub>x</sub>, 6.2 tons of CO, 5.6 tons of HC and 0.77 tons of SO<sub>2</sub>.

In the literature, there are various studies in which the energy systems of ships were analyzed and modelled with the Reference Energy System (RES) approach. For example; Benli, Sulukan and Alkan (2019) studied on RES modelling and analysis of a frigate-type naval ship. Yan et al. (2019) examined energy system components of a cruise ship. Sulukan, Özkan and Sarı (2018) studied on energy consumption characteristics and demand sectors by examining RES modelling and analysis of a generic ship. Yılmaz et al. (2018) established and analyzed a RES model of a crude oil tanker's energy system in order to examine the relationships between energy carriers, technologies and demand sectors. There are also several studies in the literature that show that, RES approach can be applied to different topics

and sectors with the aim of energy and energy planning of countries or a region. For example, Mutluel and Sulukan (2014) established a RES model of residential sector in Turkey in order to provide a technical support to decision-makers. Yophy, Jeffrey and Peng (2011) made an assessment on the future energy and climate policies with the LEAP model application for the long-term forecast of Taiwan's energy supply and demand. Shabbir and Ahmad (2010) analyzed air pollution and energy demand from urban transportation in Rawalpindi and Islamabad with the LEAP energy model. Sulukan et al. (2010) studied on the determination of the optimal energy strategies for Turkey with a MARKAL model.

### 3. METHODOLOGY

In this study, energy system analysis and modelling of a new generation ferry with diesel electric propulsion system, which is used for vehicle and passenger transportation, are carried out by using the Reference Energy System (RES) approach and LEAP (Long-range Energy Alternatives Planning System) software.

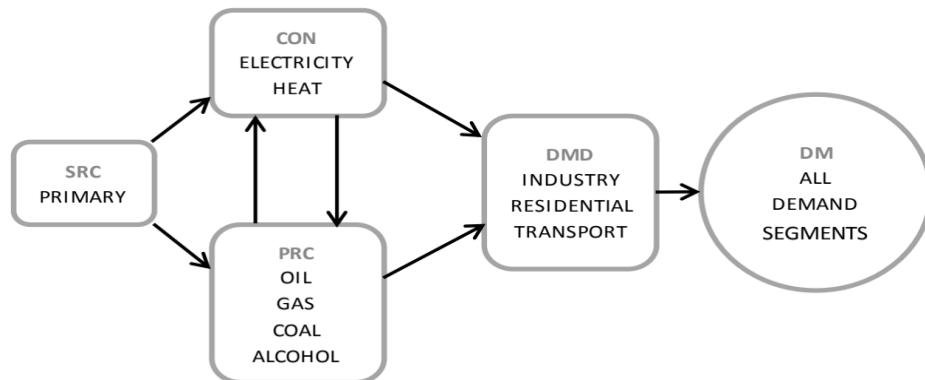

**Figure 1.** A simplified illustration of main components of a typical RES model (Sulukan, Özkan & Sarı, 2018).

The RES is a flowchart showing all possible routes from each primary energy source to each end-use (demand) sectors through various conversion steps (Sulukan, 2017). In other words, the RES is a set of parameters that

reveals the characteristics of technologies and resources used to provide energy balance and is a network of all technological activities required for energy supply and end-use activities. There are usually five main components of a typical RES model which are primary energy sources (SRC), energy conversion technologies (CON), energy processing technologies (PRC), energy end-user (demand) technologies (DMD) and demands (DM) (see Figure 1) (Sulukan, Özkan and Sarı, 2018).

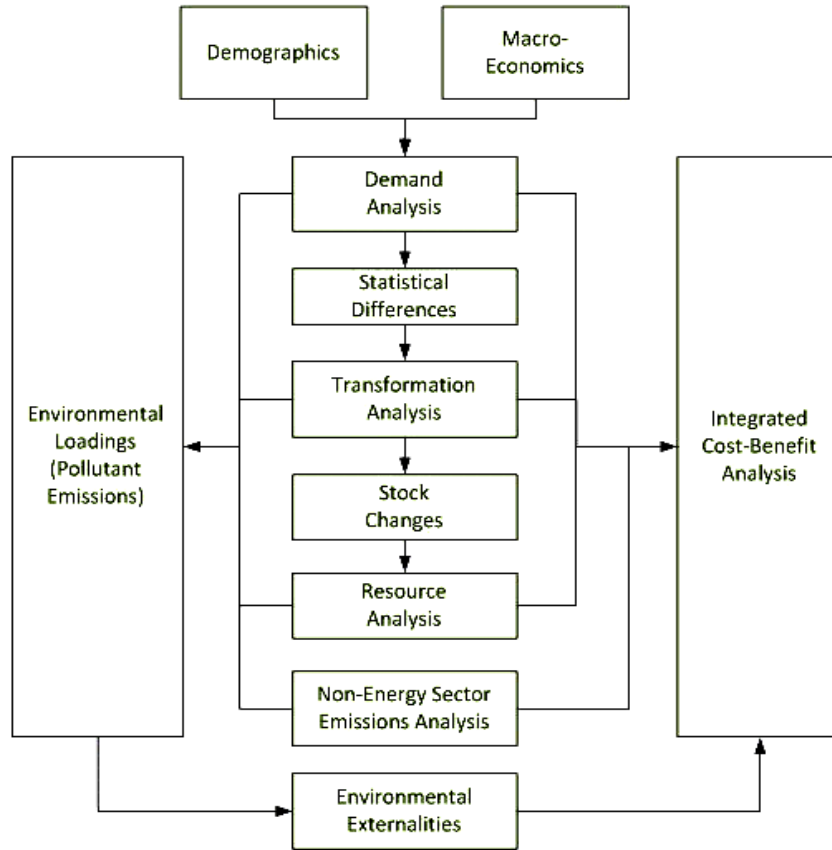

**Figure 2.** General structure of a LEAP model (LEAP, 2019).

In accordance with the RES concept explained above, the RES model of a new generation ferry with diesel electric propulsion system has been



established by using data of 2019, as the reference year, and then, the same model including numerical data of the RES parameters has been created in the LEAP software for analysis. Of course, there are various decision support tools used for modelling energy systems for different purposes. In this study, we have preferred to use the LEAP software for the energy system analysis and modelling of the ferry, since it is complied with the RES concept and has a Technology and Environmental Database (TED) through of which the theoretical emission estimates of energy technologies can be calculated, as well. Figure 2 shows the general structure of a LEAP model (LEAP, 2019). The LEAP can model energy systems according to various scenarios and calculate the energy consumption, conversion and production amounts in an energy system by considering a set of demographics (population etc.), macroeconomics (GDP, prices etc.) and environmental assumptions.

**Table 1.** Technical particulars of the ferry analyzed in this study.

Type	Vehicle & Passenger Ferry
Length (m)	64
Breath (m)	18
Drought (m)	3.3
Speed (knots)	12-13
Vehicle Capacity	80
Passenger Capacity	590
Main Energy System	Diesel Electric Generators (4 x 600 kWh)
Propulsion System	Electric Converters & Motors + Voith Schneider Propellers (VSP)

Table 1 shows that basic technical particulars of the ferry with a diesel electric propulsion system analyzed in this study which is used for short-distance vehicle and passenger transportation in İstanbul and operated by İDO.

#### **4. APPLICATION OF RES CONCEPT TO FERRY**

The RES model for the ferry, which has been developed in scope of this study, is shown in the Figure 3 and Figure 4 below.

##### **4.1. Resource Technologies**

The main energy resource of the ferry is diesel oil (EN 590) which is an imported fossil-based oil product. Diesel oil is only used by diesel generators with internal combustion diesel engines on board ferry. The electricity may also be rarely imported from shore while the ferry is berthed for maintenance.

##### **4.2. Storage Technologies**

The main storage technologies are diesel oil tanks on board the ferry.

## Energy System Analysis and Modelling of an Electric Powered Ferry

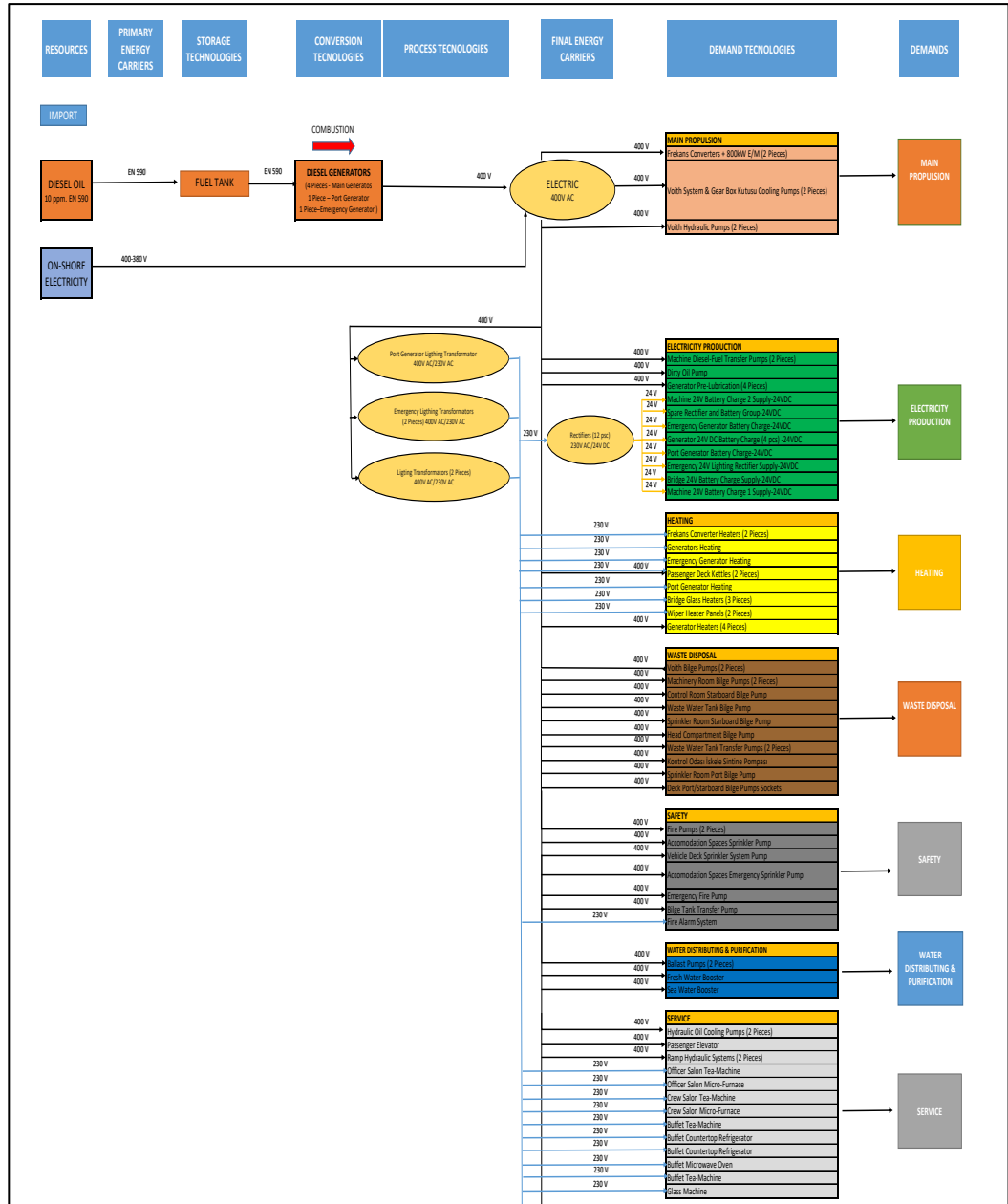

**Figure 3.** The RES model developed for the analyzed ferry.

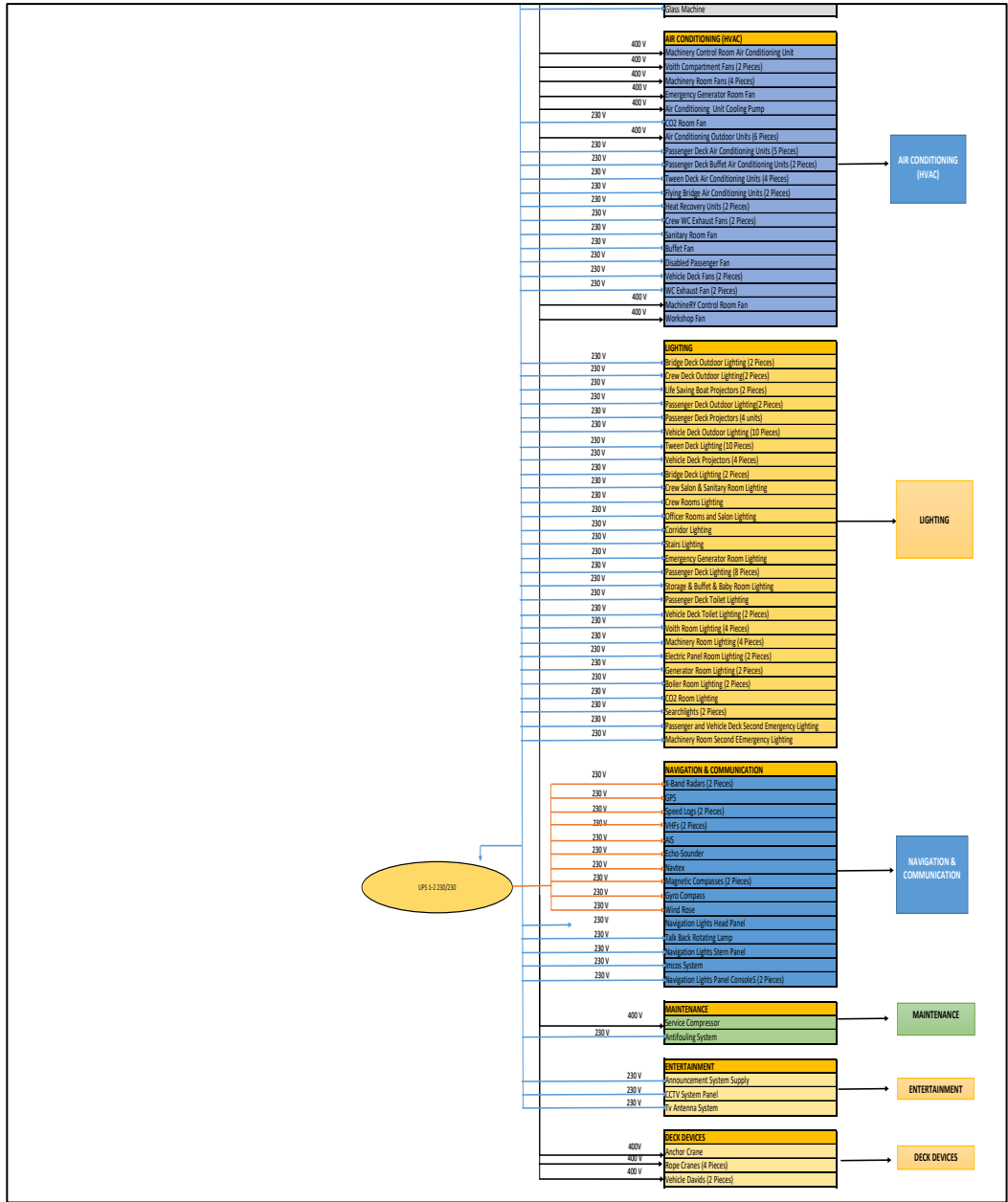

Figure 4. The RES model developed for the analyzed ferry (continued).

### **4.3. Primary Energy Carriers**

The primary energy carrier is diesel oil as well as electricity imported from the shore when necessary.

### **4.4. Conversion Technologies**

In general, the conversion technologies are converting the primary energy carriers to final energy carriers. The main conversion technologies of the ferry's energy system are diesel generators with internal combustion diesel engines which convert the thermal energy of diesel oil to the electricity.

### **4.5. Process Technologies**

In general, the process technologies are changing the form, characteristic or location of the energy. The main process technologies of ferry's energy system are transformers, inverters and UPS which adjust the voltage and frequency of electricity.

### **4.6. Final Energy Carriers**

The final energy carrier is electricity for the analyzed ferry.

### **4.7. Demand Technologies**

In this study, many demand technologies including pumps, ventilation fans and electrical devices etc. in scope of 13 different demand sectors for the ferry have been detected.

### **4.8. Demands**

As seen in the Table 2, demand sectors for the ferry have been described as "Main Propulsion", "Electricity Production", "Air Conditioning (HVAC)", "Safety", "Service", "Heating", "Waste Disposal", "Lighting", "Water Distributing & Purification", "Maintenance", "Navigation & Communication", "Entertainment" and "Deck Devices".

**Table 2.** End-use technologies and demand sectors of the analyzed ferry.

<b>End-Use (Demand) Technologies</b>	<b>Demands</b>	
Frequency Converters + 800 kW E/M (2 Pieces)	Main Propulsion	
Voith System & Gear Box Cooling Pumps (2 Pieces)		
Voith Hydraulic Pumps (2 Pieces)		
Machinery Diesel-Fuel Transfer Pumps (2 Pieces)	Electricity Production	
Waste Oil Pump		
Generator Pre-lubrication (4 Pieces)		
Machine 24V Battery Chargers 2 Supply-24VDC		
Spare Rectifier and Battery Group-24VDC		
Emergency Generator Battery Chargers-24VDC		
Generator 24V DC Battery Chargers (4 pcs) - 24VDC		
Port Generator Battery Charge-24VDC		
Emergency 24V Lighting Rectifier Supply-24VDC		
Bridge 24V Battery Charge Supply-24VDC		
Machinery 24V Battery Charge 1 Supply-24VDC		
Frequency Converter Heaters (2 Pieces)		Heating
Generators Heating		
Emergency Generator Heating		
Passenger Deck Kettles (2 Pieces)		
Port Generator Heating		
Bridge Glass Heaters (3 Pieces)		
Wiper Heater Panels (2 Pieces)		
Generator Heaters (4 Pieces)	Waste Disposal	
Voith Bilge Pumps (2 Pieces)		
Machinery Room Bilge Pumps (2 Pieces)		
Control Room Starboard Bilge Pump		
Waste Water Tank Bilge Pump		
Sprinkler Room Starboard Bilge Pump		
Head Compartment Bilge Pump		
Waste Water Tank Transfer Pumps (2 Pieces)		
Control Room Port Bilge Pump		
Sprinkler Room Port Bilge Pump		
Deck Port/Starboard Bilge Pumps Sockets		

*Energy System Analysis and Modelling of an Electric Powered Ferry*

<b>End-Use (Demand) Technologies</b>	<b>Demands</b>
Fire Pumps (2 Pieces)	Safety
Accomodation Spaces Sprinkler Pump	
Vehicle Deck Sprinkler System Pump	
Accomodation Spaces Emergency Sprinkler Pump	
Emergency Fire Pump	
Bilge Tank Transfer Pump	
Fire Alarm System	
Ballast Pumps (2 Pieces)	Water Distributing & Purification
Fresh Water Booster	
Sea Water Booster	
Hydraulic Oil Cooling Pumps (2 Pieces)	Service
Passenger Elevator	
Ramp Hydraulic Systems (2 Pieces)	
Officer Messroom Tea-Machine	
Officer Messroom Microwave Owen	
Crew Messroom Tea-Machine	
Crew Messroom Microwave Owen	
Buffet Tea-Machine	
Buffet Countertop Refrigerator	
Buffet Countertop Refrigerator	
Buffet Microwave Oven	
Buffet Tea-Machine	
Glasswasher Machine	
Machinery Control Room Air Conditioning Unit	
Voith Compartment Fans (2 Pieces)	
Machinery Room Fans (4 Pieces)	
Emergency Generator Room Fan	
Air Conditioning Unit Cooling Pump	
CO2 Room Fan	
Air Conditioning Outdoor Units (6 Pieces)	
Passenger Deck Air Conditioning Units (5 Pieces)	
Passenger Deck Buffet Air Conditioning Units (2 Pieces)	
Tween Deck Air Conditioning Units (4 Pieces)	
Flying Bridge Air Conditioning Units (2 Pieces)	
Heat Recovery Units (2 Pieces)	

<b>End-Use (Demand) Technologies</b>	<b>Demands</b>
Crew WC Exhaust Fans (2 Pieces)	Lighting
Sanitary Room Fan	
Buffet Fan	
Disabled Passenger Fan	
Vehicle Deck Fans (2 Pieces)	
WC Exhaust Fan (2 Pieces)	
Machinery Control Room Fan	
Workshop Fan	
Bridge Deck Outdoor Lighting (2 Pieces)	
Crew Deck Outdoor Lighting (2 Pieces)	
Life Saving Boat Projectors (2 Pieces)	
Passenger Deck Outdoor Lighting(2 Pieces)	
Passenger Deck Projectors (4 units)	
Vehicle Deck Outdoor Lighting (10 Pieces)	
Tween Deck Lighting (10 Pieces)	
Vehicle Deck Projectors (4 Pieces)	
Bridge Deck Lighting (2 Pieces)	
Crew Messroom & Sanitary Room Lighting	
Crew Rooms Lighting	
Officer Rooms and Salon Lighting	
Corridor Lighting	
Stairs Lighting	
Emergency Generator Room Lighting	
Passenger Deck Lighting (8 Pieces)	
Storage & Buffet & Baby Room Lighting	
Passenger Deck Toilet Lighting	
Vehicle Deck Toilet Lighting (2 Pieces)	
Voith Room Lighting (4 Pieces)	
Machinery Room Lighting (4 Pieces)	
Electric Panel Room Lighting (2 Pieces)	
Generator Room Lighting (2 Pieces)	
Boiler Room Lighting (2 Pieces)	
CO2 Room Lighting	
Searchlights (2 Pieces)	
Passenger and Vehicle Deck Second Emergency Lighting	



*Energy System Analysis and Modelling of an Electric Powered Ferry*

<b>End-Use (Demand) Technologies</b>	<b>Demands</b>
Machinery Room Second Emergency Lighting	Navigation & Communication
X-Band Radars (2 Pieces)	
GPS	
Speed Logs (2 Pieces)	
VHFs (2 Pieces)	
AIS	
Echo-Sounder	
Navtex	
Magnetic Compasses (2 Pieces)	
Gyro Compass	
Wind Rose	
Navigation Lights Head Panel	
Talk Back Rotating Lamp	
Navigation Lights Stern Panel	
Imcos System	
Navigation Lights Panel Consoles (2 Pieces)	Maintenance
Service Compressor	
Antifouling System	Entertainment
Announcement System Supply	
CCTV System Panel	
TV Antenna System	Deck Devices
Anchor Crane	
Rope Cranes (4 Pieces)	
Vehicle Davids (2 Pieces)	

## **5. ENERGY SYSTEM ANALYSIS RESULTS OF FERRY BY LEAP**

### **5.1. LEAP Analysis Results for Ferry's RES Model**

As seen in the Table 3, which shows LEAP analysis results of the ferry's RES energy balance, EN 590 diesel oil with a total thermal energy of 43.5 thousand GJ was consumed in the ferry in 2019.

**Table 3.** LEAP results of ferry's energy balance for RES.

<b>Year: 2019, Units: Thousand Gigajoule (GJ)</b>			
	<b>Electricity</b>	<b>Oil Products</b>	<b>Total</b>
Production	-	-	-
Imports	-	43.5088	43.5088
Exports	-0.0365	-	-0.0365
Total Primary Supply	-0.0365	43.5088	43.4723
Electricity Generation	37.2000	-43.5088	-6.3088
Electricity Transmission and Distribution	-1.8528	-	-1.8528
Total Transformation	35.3472	-43.5088	-8.1616
Main Propulsion	25.9189	-	25.9189
Electricity Production	4.2990	-	4.2990
Heating	0.0502	-	0.0502
Waste Disposal	0.0003	-	0.0003
Safety	0.0032	-	0.0032
Water Distributing & Purification	0.0142	-	0.0142
Service	0.1763	-	0.1763
Air Conditioning (HVAC)	4.3543	-	4.3543
Lighting	0.3596	-	0.3596
Navigation & Communication	0.0383	-	0.0383
Entertainment	0.0800	-	0.0800
Maintenance	0.0151	-	0.0151
Deck Devices	0.0013	-	0.0013
Total Demand	35.3108	-	35.3108
Unmet Requirements	-0.0000	-	-0.0000

According to our LEAP model, the efficiency of the electricity generation process (conversion technologies) by diesel generators was assumed as 85%, and the loss rate in the process of converting electricity into different voltages, types and frequencies (process technologies) was assumed as 5%. According to those assumes, total losses of 8,16 thousand GJ, which equal approximately 18% of diesel oil thermal energy consumed, was occurred in conversion and process technologies, while converting the fossil-based

*Energy System Analysis and Modelling of an Electric Powered Ferry*

diesel oil's thermal energy to electricity and then transmitting and distributing of electricity to demand technologies. 25.9 thousand GJ for "Main Drive", 4.3 thousand GJ for "Electricity Generation", 50 GJ for "Heating", 3 GJ for "Waste Disposal", 3.2 GJ for "Safety", 1.4 GJ for "Water Distributing & Purification", 176.3 GJ for "Service", 4.35 thousand GJ for "Air Conditioning (HVAC)", 359.6 GJ for "Lighting", 38.3 GJ for "Navigation and Communication", 80 GJ for "Entertainment", 15.1 GJ for "Maintenance" and 1.3 GJ for "Deck Devices" of the ferry were consumed.

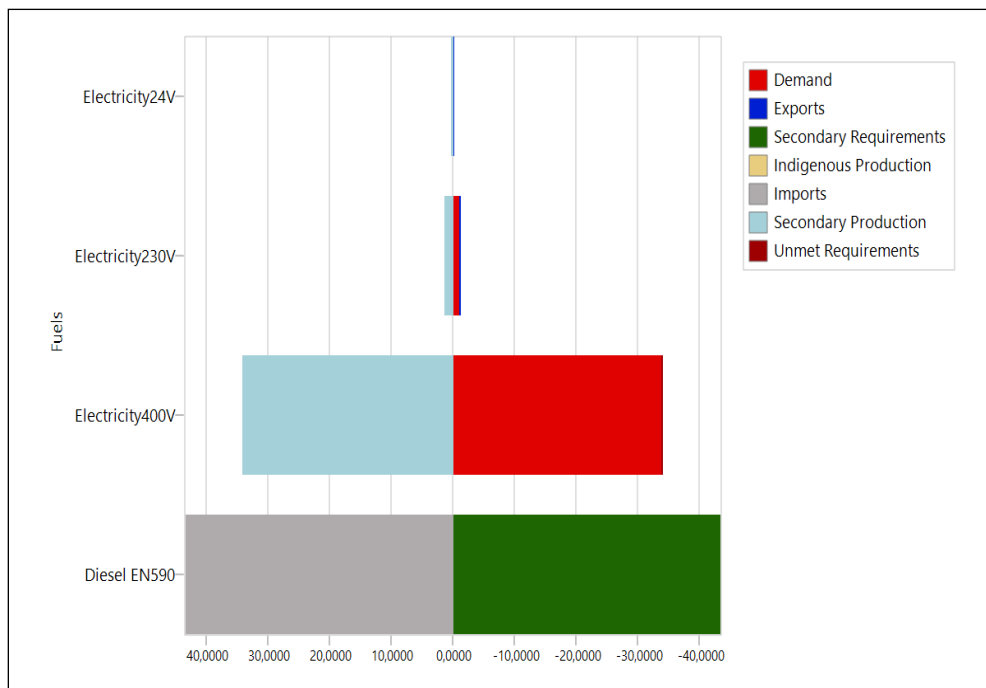

**Figure 5.** Energy balance by energy carriers.

Figure 5, gives a further detailed energy balance of the ferry in terms of energy carriers, and shows that 440V electricity with a total amount of 33.96 thousand GJ, 230V electricity with 1.24 thousand GJ and 24V electricity with 0.108 thousand GJ were used by demand technologies of the ferry and there was a balanced distribution. In addition, most of the

*Fatih YILMAZ, Egemen SULUKAN*

electricity was used for the “Main Propulsion” system, “Electricity Production” and “Air Conditioning (HVAC)” system in the ferry.

*Energy System Analysis and Modelling of an Electric Powered Ferry*

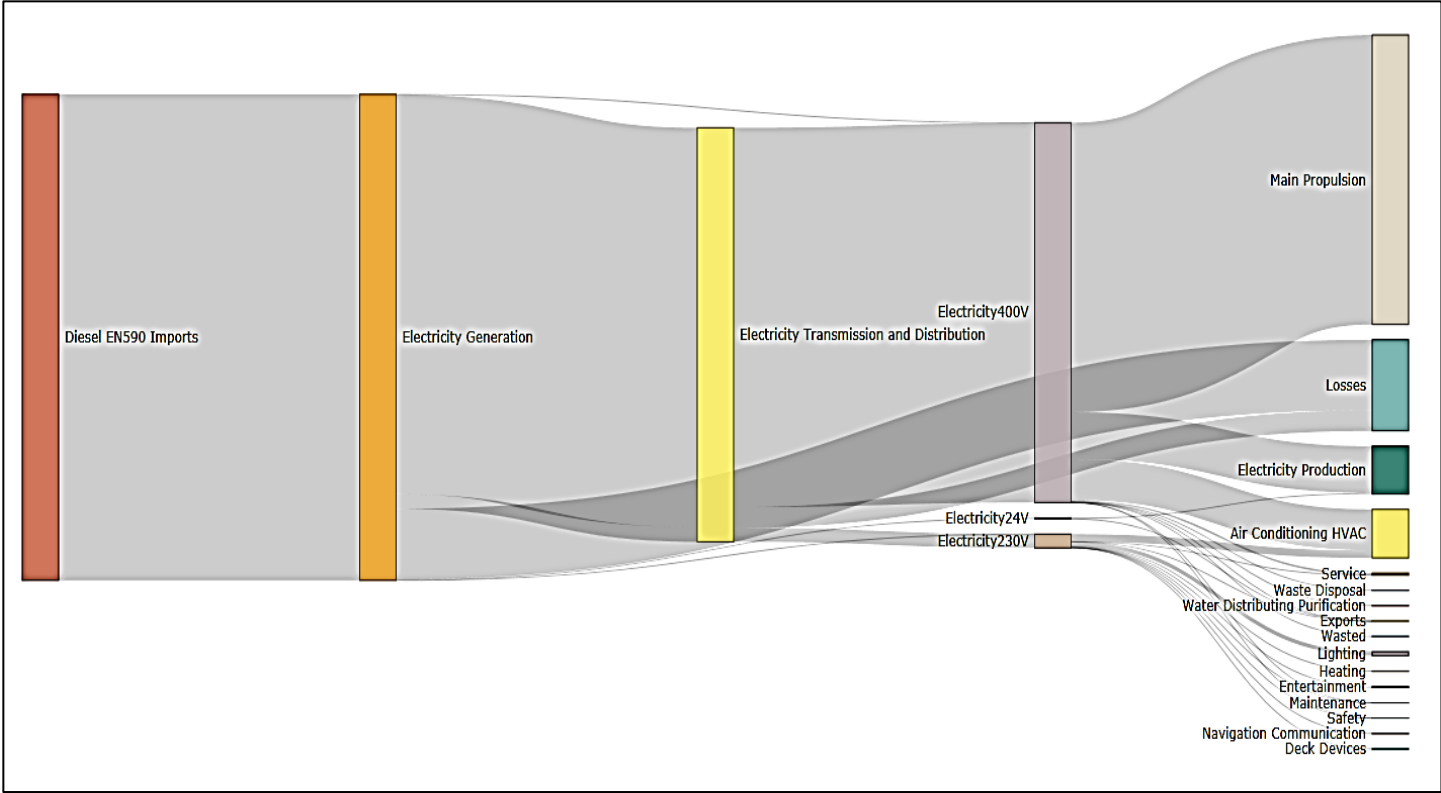

**Figure 6.** LEAP energy flow (Sankey) diagram of the analyzed ferry.

The Sankey diagram is used to visualize the energy balance flow of any system modelled in LEAP. Energy flow (Sankey) diagram provides an overview of energy flows from sources to energy demands. The Sankey diagram produced by LEAP in accordance with the model created in scope of this study, which shows energy flow of the ferry, is shown in Figure 6.

As seen from Table 3 and Figure 6, 35.3 thousand GJ was used by energy demand technologies and 73.4% (25.92 thousand GJ) of which was used for "Main Propulsion", 12.3% (4.35 thousand GJ) for "Air Conditioning (HVAC)" and 12.2% (4.3 thousand GJ) for "Electricity Production" respectively. Therefore, it would be useful to analysis these demand sectors, which have a significant share in the total energy consumption of the ferry. The more detailed analysis results show that 98.6% of a total amount of energy demand for "Main Propulsion" was used by "Frequency Converters", 1.2% by "Voith Hydraulic Pumps" and 0.2% by "Voith Gear Box Cooling Pumps". 72.13% of a total amount of energy demand for "Electricity Production" was used by "Charging" and 27.87% by "Lighting Transformers". 72.6% of a total amount of energy demand for "Air Conditioning (HVAC)" was used by "A/C Outdoor Units", 9.4% by "Heat Recovery Units" and 9.4% by "Machinery Room Fans" respectively.

## **5.2. Theoretical Emission Estimates for Ferry's RES Concept and Hybrid Conversion Scenario**

In this part, LEAP based–theoretical emission estimates for the ferry's RES have been presented. In addition, emission estimates for a scenario, which assumes that the ferry's RES might be converted to a hybrid energy system, have also been presented. This scenario deals with the installation of an energy system based on Lithium-ion battery technology by removing two of the 4 equivalent generators used in the ferry to produce electricity. According to the scenario, total amount of energy to be produced through diesel generators will decrease by 50% compared to ferry's RES, since half of the energy demand of the ferry will be provided with Lithium-ion batteries.

LEAP based–theoretical emission estimates for the ferry's RES and for a scenario which assumes that the ferry's RES might be converted to a hybrid concept are shown in Table 4. The "IPCC Tier 1 Default Emission Factors" tab in the TED database of LEAP was selected for the theoretical emission calculations of fossil-based fuel used by diesel generators of the ferry.

**Table 4.** Theoretical emission estimates of the ferry by LEAP.

<b>Units: Metric Tones CO<sub>2</sub> Equivalent</b>		
<b>Effects</b>	<b>RES (2019)</b>	<b>Hybrid Scenario</b>
Carbon Dioxide	3,156.56	1,578.28
Methane	3.915	1.958
Nitrous Oxide	6.917	3,459
Total	3,167.45	1,583.69

Table 4 shows that the CO<sub>2</sub> and other emissions from the ferry can be reduced by half, if it is assumed that the ferry's energy system is converted to hybrid concept.

## **6. CONCLUSION**

According to the literature review carried out by this study, it has been observed that the Reference Energy System (RES) approach can be used for the analysis of energy systems of ships as well as for the analysis of energy systems in many different fields and sectors.

The RES model based on 2019 data for the ferry analyzed in this study has been developed and presented in Section 4. The LEAP analysis results of ferry's energy system have been also presented in Section 5.

In conclusion, it has been observed that most of the electricity produced based on diesel oil onboard the ferry was used for "Main Propulsion" with a share of 73.4%, "Air Conditioning (HVAC)" with a share of %12.3 and "Electricity Production" with a share of 12.2% respectively and some losses, which is approximately 18% of total diesel oil's thermal energy

consumed, were also occurred in the energy system of the ferry in 2019. Accordingly, it is considered that regular maintenance of diesel generators with internal consumption engines and electricity transmission and distribution equipment is an important factor to increasing operational energy efficiency of the ferry.

According to the theoretical emission estimates as well, it has been also observed that the CO<sub>2</sub> and other emissions from the ferry can be reduced by half, if it is assumed that the ferry's energy system is converted to hybrid concept with the installation of Lithium-ion battery technology.



## **ACKNOWLEDGEMENT**

This article has been produced from M.Sc. Thesis which is entitled as “Energy System Analysis and Modelling of an Electrical/Hybrid Ferry Used for Maritime Transportation: Technical & Environmental Investigation” and was prepared at Marine Mechanical Engineering Department of Barbaros Naval Sciences and Engineering Institute of National Defence University (NDU) in Tuzla, Istanbul, Turkey. This is also a substantially extended version of the paper presented at the 10<sup>th</sup> International 100% Renewable Energy Conference (IRENEC 2020).

The Authors would like to thank to İstanbul Deniz Otobüsleri (İDO) for technical support to obtain more realistic results by using real data and specially thanks to Technical Fuel & Environmental Manager - Oceangoing Chief Engineer Mr. Yavuz ÇATAL for his professional support and technical guidance during the study.

## REFERENCES

Baldi, F. (2016). Modelling, Analysis and Optimisation of Ship Energy Systems. (Thesis for the Degree of Doctor of Engineering). *Chalmers University of Technology, Department of Shipping and Marine Technology*, Gothenburg, Sweden.

Benli, İ. T., Sulukan, E., & Alkan, A. D. (2019). “Developing the Reference Energy System of a Generic Frigate”. *Journal of Naval Sciences and Engineering*, 15(1): 1-20.

Durmaz, M., Kalender, S. S., & Ergin, S. (2016). “Bir Feribottan Yayılan Emisyonların Deneysel Olarak İncelenmesi”. *GİDB Journal*, 6:3-11.

International Maritime Organization (IMO). (2019). UN Body Adopts Climate Change Strategy for Shipping. *IMO*. Retrieved from <http://www.imo.org>

İstanbul Deniz Otobüsleri (İDO). (2020). Filo Tanıtım. *İDO*. Retrieved from <https://www.ido.com.tr/services-new#filomuz>

Johnson, H., Johansson, M., Andersson, K., & Södahl, B. (2013). “Will the Ship Energy Efficiency Management Plan Reduce CO2 Emissions? A Comparison with ISO 50001 and the ISM Code”. *Maritime Policy & Management*, 40(2):177-190.

Long Range Energy Alternatives Planning System (LEAP). (2019). Retrieved from <https://www.energycommunity.org>

Ministry of Transport and Infrastructure (MoTI). (2020). Maritime Statistics. *MoTI*. Retrieved from <https://denizcilikistatistikleri.uab.gov.tr/>

Mutluel, F., & Sulukan, E. (2014, Haziran). Reference Energy System Development for Turkish Residential Sector. *IRENEC 2014 Conference Proceedings Book* (pp.179-186).

Sahabbir, R., & Ahmad, S. S. (2010). "Monitoring Urban Transport Air Pollution and Energy Demand in Rawalpindi and Islamabad Using Leap Model". *Energy*, 35(5): 2323-2332.

Sulukan, E., Özkan D., & Sarı, A. (2018). "Reference Energy System Analysis of a Generic Ship". *Journal of Clean Energy Technologies*, 6 (5): 371-376.

Sulukan, E., Sağlam, M., & Uyar, T. S. (2017). A Native Energy Decision Model for Turkey. In Tanay Sidki Uyar (Ed.), *Towards 100% Renewable Energy: Techniques, Costs and Regional Case-Studies* (pp. 167-177). Springer International Publishing

Sulukan, E., Sağlam, M., Uyar, T. S., & Kırılıdoğ, M. (2010). "Determining Optimum Energy Strategies for Turkey by MARKAL Model". *Journal of Naval Science and Engineering*, 6(1): 27-38.

Talay, A. A., Deniz, C., & Durmuşoğlu, Y. (2014). "Gemilerde Verimi Arttırmak İçin Uygulanan Yöntemlerin CO2 Emisyonlarını Azaltmaya Yönelik Etkilerinin Analizi". *Journal of ETA Maritime Science*, 1(2): 61-74.

The Grand National Assembly of Turkey (TBMM). (2013). Decision on the Approval of the Eleventh Development Plan (2019-2023). *Official Gazette*, 30840 (Mükerrer), 23.07.2013. Retrieved from [www.sbb.gov.tr](http://www.sbb.gov.tr)

Tillig, F., Ringsberg, J., Mao, W., & Ramne, B. (2017). "A Generic Energy Systems Model for Efficient Ship Design and Operation". *Journal of Engineering for the Maritime Environment*, 231(2): 649-666.

Vassalos, D., & Cichowicz, J. (2014). Performance-based Ship Energy Efficiency - The Way Forward. In *Influence of EEDI on Ship Design 2014* (pp. 88-98). London: Royal Institution of Naval Architects.

Yan, Y., Zhang, H., Long, Y., Wang, Y., Liang, Y., Song, X., & Yu, J. J. Q. (2019). "Multi-objective Design Optimization of Combined Cooling, Heating and Power System for Cruise Ship Application". *Journal of Cleaner Production*, 233: 264-279.

Yılmaz, M. A., Sulukan, E., Özkan, D., & Uyar, T. S. (2018). Reference Energy System Design for a Crude Oil Tanker. In *International 100% Renewable Energy Conference (IRENEC) Proceedings Book* (pp. 50-55).

Yiğit, K. (2018). "Gemi Teknolojisinde Alternatif Enerji Sistemlerinin Kullanım Potansiyelinin İncelenmesi". *Gemi ve Deniz Teknolojisi*, 214: 5-18.

Yophy, H., Jeffrey, B. Y., & Peng, C-Y. (2011). "The Long-term Forecast of Taiwan's Energy Supply and Demand: LEAP Model Application". *Energy Policy*, 39(11): 6790-6803.

*\*An ethical committee approval and/or legal/special permission has not been required within the scope of this study.*

**INVESTIGATION OF MECHANICAL PROPERTIES OF WELDING  
ELECTRODES USED FOR HIGH STRENGTH LOW ALLOY  
STEELS\***

**Zeynep TAŞLIÇUKUR ÖZTÜRK<sup>1</sup>**  
**Abdullah Koray PEHLİVAN<sup>2</sup>**

<sup>1</sup> *National Defence University, Turkish Naval Academy, Department of  
Mechanical Engineering, Istanbul, Turkey,*  
[ztozturk@dho.edu.tr](mailto:ztozturk@dho.edu.tr); ORCID: 0000-0002-8253-8159

<sup>2</sup> *Istanbul Gedik University, Institute of Science and Technology, Defence  
Technologies Programme, Istanbul, Turkey,*  
[pehlivanabdullah34@gmail.com](mailto:pehlivanabdullah34@gmail.com); ORCID: 0000-0003-0985-3969

**Date of Receive: 24.08.2020**

**Date of Acceptance: 26.09.2020**

### ABSTRACT

*In this study, GeKa Tempo B65 electrodes are used in the welding of high strength low alloy (HSLA) S355JR steel. It is aimed to increase the impact resistance of the electrodes at minus temperatures. In order to observe the mechanical properties of the materials, tensile, impact energy test and CTOD test are performed. Implicit electric arc welding is chosen as the welding method. Electrodes with three different compositions and grain structures are prepared for welding. Optical microscope is used to observe the surface images of the weld seams. It is observed that the grain structure of the sample, the amount of alloying elements and the heat input during the welding of the sample significantly affect the impact resistance of the welded samples.*

**Keywords:** *High Strength Low Alloy Steel, Electrode Materials, Welding, Mechanical Properties, Microstructure.*

**YÜKSEK MUKAVEMETLİ DÜŞÜK ALAŞIMLI ÇELİKLER İÇİN  
KULLANILAN KAYNAK ELEKTRODLARININ MEKANİK  
ÖZELLİKLERİNİN İNCELENMESİ**

**ÖZ**

*Bu çalışmada GeKa Tempo B65 elektrotları yüksek mukavemetli düşük alaşımlı (HSLA) S355JR çeliğinin kaynağında kullanılmıştır. Eksi sıcaklıklarda elektrotların darbe dayanımının artırılması amaçlanmaktadır. Malzemelerin mekanik özelliklerini incelemek için çekme, çentik darbe testi ve CTOD testi yapılmıştır. Kaynak yöntemi olarak örtülü elektrik ark kaynağı seçilmiştir. Üç farklı bileşime ve tane yapısına sahip elektrotlar kaynak için hazırlanmıştır. Kaynak dikişlerinin yüzey görüntülerini gözlemek için optik mikroskop kullanılmıştır. Numunenin tane yapısının, alaşım elementlerinin miktarının ve numunenin kaynağı sırasındaki ısı girişinin, kaynaklı numunelerin darbe dayanımlarını önemli ölçüde etkilediği görülmüştür.*

**Anahtar Kelimeler:** *Yüksek Mukavemetli Düşük Alaşımlı Çelik, Elektrot Malzemeler, Kaynak, Mekanik Özellikler, Mikroyapı.*

## **1. INTRODUCTION**

High strength low alloy steels (HSLA) are widely used for the production of welded metal structures in various areas of the modern industry, including construction, agriculture, transportation, engineering and defence. These steels have a ferritic-pearlitic or ferritic-bainitic structure. There are some parameters that determine the quality of the weld seam and its connection. Before the welding process, many factors such as material properties should be reviewed. In melting based welding methods, it is mandatory to protect the welding area with auxiliary materials. Appropriate selection of these parameters simplifies working conditions and increases the probability of obtaining the required welding connection (Badkoobeh et al., 2020; Pathak et al., 2020; Berdnikova et al., 2009; Antonini, 2014).

The process of selecting a specific arc welding depends on many factors, including the thickness and type of the base metal, the size and strength of the desired weld, the welding speed or volume, the cost, the location of the material (e.g. vertical or horizontal). Among the covered electrodes used in the electric arc welding method are acidic, cellulosic, oxide covered, basic and rutile electrodes. Electrode selection is made during the design of the welding connection and there is no perfect electrode that can be used in all areas. The electrode that is most suitable for a particular aim is selected by considering a number of factors, especially the type and mechanical properties of the steel. Basic electrodes coated with calcium fluoride are widely used in arc welding. Basic electrodes can be used in any welding position. It gives very good welding seams even at the welding of the components below 0°C. For a good weld seam, basic electrodes should be kept at right angles as far as possible in the welding direction. Basic electrodes are not prone to hot and cold cracking (Ragu et al., 2015; Sjörgen et al., 1984; Oğuz, 1989).

Basic electrodes are manufactured with thick covering. Although they are packed in airtight boxes, they should not be left in damp places for a long time. Due to the moisture, hydrogen embrittlement may occur in the electrodes during welding. Hydrogen embrittlement is not noticeable during welding. It occurs after a certain amount of time, and it is a major problem



*Investigation of Mechanical Properties of Welding Electrodes Used for High Strength Low Alloy Steels*

for the material (Erofeev et al., 2019; Anik et al., 1991). Basic electrodes are subjected to drying at approximately 500°C to prevent this situation. The electrodes used in Russia or Ukraine have high refractive impact energy at minus temperatures. Therefore, there are many parameters to increase the toughness of basic electrodes used at minus temperatures. Some of these are the reduction of grain size, transition temperature and the effect of alloying elements. The alloying elements such as Ni, Cr, and Mo control the ferrite/austenite balance and the mechanical properties. The phase balance and mechanical properties are also influenced by the heat input and cooling rate during welding (Atia et al., 1991).

In order to observe the mechanical properties of the materials, tensile and impact energy tests are performed. The tensile test is a mechanical test performed by applying a longitudinal or axial load at a given elongation rate to a stretching sample sized to predetermined standards (Khayal, 2019). The impact energy test is carried out to examine the mechanical properties of the metals, especially in conditions suitable for brittle breakage and to determine the amount of impact resistance required to break the sample under a force. After the impact test, a material may also have a fracture resistance (Pettarin et al., 2003; Khan et al., 2020). Small grain steels have better yield and tensile strength than coarse grain. The differences between the weld metal and the impact strength of the base metal may seem insignificant, but the fracture toughness of a weld metal may be significantly lower or greater than that of the base metal (Tuma et al., 2006). Fatigue CTOD test method has been developed to easily determine the minimum CTOD value in welded connections. In other words, the "Crack Tip Aperture" test is one of the most common parameters used in the industry. Because the tests are practical and the methods are standardized. The CTOD test successfully analyzes every phase of crack in elasto-plastic fracture mechanics (Ishikawa et al., 1984; Avila et al., 2016; Ay, 1995).

In this study, it is aimed to increase the impact energy of basic electrodes used in the welding of high strength low carbon steels used at minus temperatures and investigation with CTOD test has been done.

## 2. MATERIALS AND METHODS

In this study, S355JR steel was joined to the S355JR by using GeKa Tempo B65 basic electrode with butt welding method. DC (+) was used in the welding. S355JR steel had a size of 20 mm x 180 mm x 400 mm.

The code of S355JR steel was made according to TS EN 10025-2: 2006 quality standard. The number "355" in this code represented the yield strength of the steel. The JR code represented the impact energy at +20 °C. The impact energy of S355 steel at 20°C was 27 J. The chemical composition of S355JR was given in Table 1.

**Table 1.** The chemical composition of S355JR steel.

Steel	%C max	%Si max	%Mn max	%P max	%S max	%Cu max	%N max	%Other
S355JR	0.24	0.55	1.60	0.04	0.04	0.4	0.012	97.11

The composition of the weld metal was given in Table 2 and the mechanical properties of the weld metal were given in Table 3.

**Table 2.** The composition of the weld metal (S355JR).

%C	%Si	%Mn	%Ni	%Mo	%Other
0.06	0.3	1.2	0.8	0.35	97.29

**Table 3.** The mechanical properties of the welding metal (S355JR).

Yield Strength (MPa)	Tensile Strength (MPa)	% Elongation (L <sub>0</sub> =5d <sub>0</sub> )	Impact Energy (-60°C)(MPa)
Min. 550	630-750	Min. 22	Min. 47

*Investigation of Mechanical Properties of Welding Electrodes Used for High Strength Low Alloy Steels*

A total of 10 rows of weldings were made for each electrode. The welding speed, amper and voltage were observed to calculate the heat inputs of each pass. The welded material was shown in Figure 1. The preheating temperature of the electrodes was 80°C and the temperature between passes was 130°C.



**Figure 1.** Welded S355JR and weld seam.

Three different electrodes were used for welding processes. These electrodes were; 6356, 6357, and 6360. Si was added into 6356 coded electrodes. The amount of Si was reduced in the 6357 coded electrodes. Ti was added into the 6360 coded electrodes to decrease the grain size. GeKa Tempo B65 basic electrode had a size of 320 mm x 350 mm.

Since the basic electrodes had a hygroscopic structure, they were subjected to heating before being used in the welding process. After being kept at 250 °C for 2 hours, they were stored at different temperatures in ovens according to their chemical structure. The chemical composition of the samples welded with GeKa Tempo B65 electrode was given in Table 4.

**Table 4.** The chemical composition of the samples welded with GeKa Tempo B 65 electrode.

Electrode	%C	%Si	%Mn	%P	%S	%Cr	%Ni	%Mo	%Cu	%Ti	%V	%Al
6357	0.065	0.447	1.3	0.01	0.05	0.035	0.96	0.192	0.065	0.008	0.017	0.001
6360	0.067	0.477	1.511	0.026	0.012	0.035	0.864	0.214	0.030	0.014	0.021	0.004
6356	0.078	0.63	1.45	0.019	0.007	0.047	0.96	0.2	0.057	0.011	0.017	0.004

The tensile test was performed using Zwick / Roell Z600 tensile device. The impact test was performed by using a Zwick / Roell RKP300 impact test device, controlled by a thermometer. In order to observe the impact resistance of the samples at minus temperatures, dry ice was taken from the CO<sub>2</sub> tubes and placed in a metal container together with the samples. The test (ASTM E23 impact test) was done at -60°C temperature. CTOD (Crack Tip Opening Displacement) test samples (Figure 2) were prepared according to the ISO 15653 CTOD test standard.



**Figure 2.** CTOD test sample.

*Investigation of Mechanical Properties of Welding Electrodes Used for High Strength Low Alloy Steels*

### 3. RESULTS AND DISCUSSION

The welding efficiency of the covered electrode arc welding was taken as 0.8 ( $\eta$ ) with reference to the TS EN 1011-1: 2010 standard. The formulation of the heat input was given in (3.1). Heat inputs of the samples welded with electric arc welding were shown in Table 5, 6 and 7.

$$Q = \frac{\eta \times I \times V \times t}{S \times 1000} \quad (1)$$

- Q: Heat input (J / mm)  
 $\eta$ : Welding efficiency  
 I: Current (A)  
 V: Voltage (V)  
 t: Welding time (seconds)  
 S: Length of the welding piece (mm)

**Table 5.** Heat input values of the sample with code 6357.

Line	Amper (A)	Voltage (V)	Welding Time (Seconds)	Heat Input (J/mm)
1	134	34.7	143	1.329
2	132	34.4	113	1.025
3	131	34.4	130	1.117
4	131	34.7	124	1.127
5	130	34	122	1.348
6	130	34.4	127	1.078
7	130	34	134	1.184
8	129	34.7	138	1.235
9	128	33.7	120	1.035
10	128	33.2	93	0.790

**Table 6.** Heat input values of the sample with code 6360.

<b>Line</b>	<b>Amper (A)</b>	<b>Voltage (V)</b>	<b>Welding Time (Seconds)</b>	<b>Heat Input (J/mm)</b>
1	132	37	123	1.200
2	133	35	110	1.024
3	130	34	125	1.104
4	131	34	134	1.193
5	131	34	132	1.175
6	131	35	127	1.164
7	129	34	134	1.174
8	129	35	138	1.245
9	129	33	115	0.978
10	128	33	68	0.565

**Table 7.** Heat input values of the sample with code 6356.

<b>Line</b>	<b>Amper (A)</b>	<b>Voltage (V)</b>	<b>Welding Time (Seconds)</b>	<b>Heat Input (J/mm)</b>
1	129	35	113	1.020
2	126	34	113	0.968
3	122	34	118	0.978
4	122	33	111	0.949
5	132	34	118	1.058
6	131	34	125	1.112
7	132	33	125	1.088
8	131	33	121	1.045
9	132	33	119	1.036
10	126	33	65	0.54

The mechanical properties of the samples welded with GeKa Tempo B65 electrodes were given in Table 8.

*Investigation of Mechanical Properties of Welding Electrodes Used for High Strength Low Alloy Steels*

**Table 8.** The mechanical properties of the samples welded with GeKa Tempo B65 electrodes.

<b>Electrode Codes</b>	<b>Yield Strength (MPa)</b>	<b>Tensile Strength (MPa)</b>	<b>% Elongation</b>	<b>Impact Energy (-60°C) (J)</b>
6357	619	679	23	79 (±8)
6360	640	706	22	63 (±7)
6356	656	722	22	62 (±7)

According to Table 8; while the yield and tensile strength values of the electrode coded of 6357, in which the Si amount was reduced, were the lowest, the impact resistance value at -60°C was the highest. The electrode coded 6357 had a graphite structure. Among the important details in welding seams were the heat input entering the welding zone and welding swing. Considering these factors, the heat input values of the 6357 coded electrodes were much better than 6360 and 6356 coded electrodes.

Ti was added as a grain thinning element to 6360 coded electrodes. The tensile and yield strength of the sample increased as the grain sizes of the materials became thinner. However, it could be seen that while the tensile and yield strength increased, there was a decrease in the elongation and impact resistance values. The % elongation was 23 mm in the 6357 coded electrode and the % elongation was 22 mm in the 6360 coded electrodes. The impact energies of 6357, 6360, and 6356 coded electrodes were 79J, 63J, 62J, respectively.

It was aimed to determine the effect of Si exactly on the welding seam in the electrode with 6356 code. 0.19% Si was added to 6357 coded electrodes. Considering the results, it was observed that there were not obvious differences in the results between 6356 coded samples and Ti added 6360 coded samples. The yield and tensile strengths were different in the 6356 coded samples with an increased Si and Ti as a grain thinner. For samples

with Ti added 6360 coded and with Si increased 6356 coded, yield strength increased from 640 MPa to 656 MPa and tensile strength increased from 706 MPa to 722 MPa. The elongation and impact resistance values were almost the same.

The tensile and yield strength of the samples welded with GeKa Tempo B 65 electrode was shown in Figure 3. The impact energy of the welded samples with GeKa Tempo B 65 electrode was shown in Figure 4.

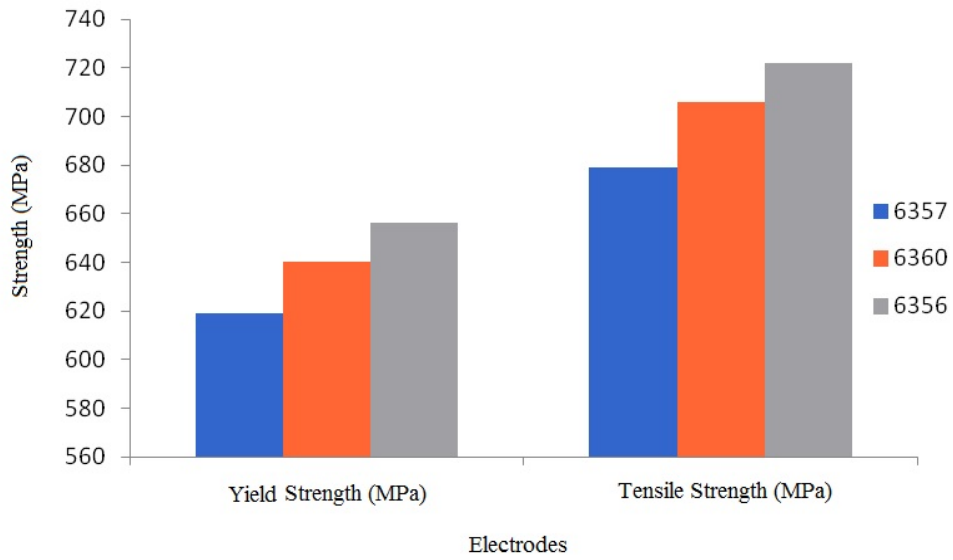

**Figure 3.** The tensile and yield strengths of the samples welded with GeKa Tempo B65 electrode.



*Investigation of Mechanical Properties of Welding Electrodes Used for High Strength Low Alloy Steels*

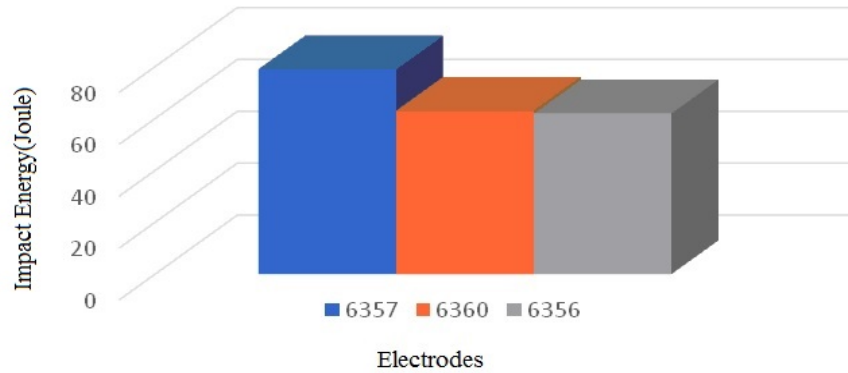

**Figure 4.** The impact energy of the welded samples with GeKa Tempo B 65 electrode.

When the fracture surfaces of the samples were examined as a result of the impact tests, it was observed that the three samples were not brittle. The fracture surfaces of the samples welded with different electrodes after notch impact test were shown in Figure 5.

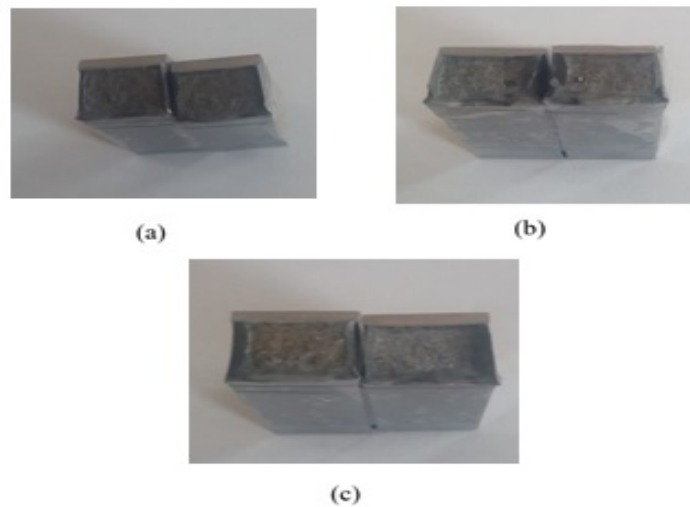

**Figure 5.** The fracture surfaces of the samples after impact test welded with (a) 6356, (b) 6357, and (c) 6360 coded electrode.

CTOD test was performed at  $-10^{\circ}\text{C}$  according to ISO 15653 standard. The macro photographs of three electrodes before CTOD test were given in Figure 6.

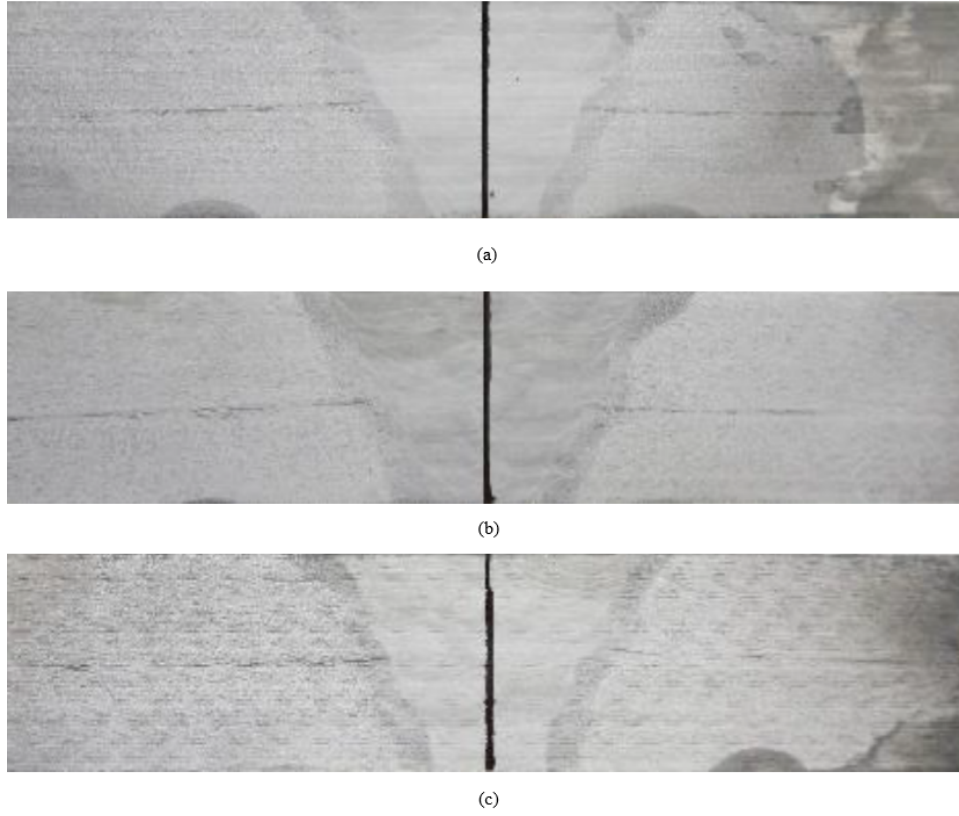

**Figure 6.** The macro photographs of a) 6356, b) 6357, and c) 6360 coded electrodes before CTOD test.

As seen from Figure 6, it was observed that the welding area of 6356 coded electrode and the HAZ (heat affected zone) was very narrow because of the low heat input values during welding. Heat input values were given in Table 7. It was observed that the welding zone of 6357 coded electrode and the HAZ were quite large because of the high heat input values during welding. It was also observed that the welding area of the 6360-code electrode, in

*Investigation of Mechanical Properties of Welding Electrodes Used for High Strength Low Alloy Steels*

which Ti was added as a thinner, and the HAZ were at a medium level. The reason was the medium level of heat input values at the welding of the 6360 coded electrodes.

CTOD test values were given in Table 9. The test conditions of the electrodes were given in Table 10. CTOD test results and crack length measurements were shown in Table 11.

**Table 9.** CTOD Test Values.

<b>Yield Strength at Room Temperature (MPa)</b>	550	<b>Yield Strength at Test Temperature (MPa)</b>	572
<b>Tensile Strength at Room Temperature (MPa)</b>	630	<b>Tensile Strength at Test Temperature (MPa)</b>	656
<b>Support Distance (mm)</b>	64	<b>Sample Type</b>	SENB
<b>Front Crack Temperature</b>	Room Temperature	<b>Front Crack Last Load (N)</b>	4750
<b>Blade Type</b>	Integral	<b>Blade Thickness (mm)</b>	0
<b>Test Speed (mm/min)</b>	1.50	<b>Displacement Control</b>	Displacement

**Table 10.** Test conditions of the electrodes.

	6356	6357	6360
<b>Crack Order Position</b>	NP	NP	NP
<b>Notch Position</b>	Welding Zone	Welding Zone	Welding Zone
<b>Thickness (mm)</b>	15.90	15.87	15.89
<b>Width (mm)</b>	15.98	16.00	15.98
<b>Dimensional Control</b>	Acceptable	Acceptable	Acceptable

CTOD test results and crack length measurements were shown in Table 11.

*Investigation of Mechanical Properties of Welding Electrodes Used for High Strength Low Alloy Steels*

**Table 11.** CTOD test results and crack length measurements.

	6356	6357	6360
<b>Machined Notch Length (mm)</b>	5.50	5.50	5.50
<b>First Crack Front Length (mm)</b>	8.09	7.98	8.24
<b>Front Crack Length (mm)</b>	2.59	2.48	2.74
<b>First Relative Crack Length (a<sub>0</sub>/W)</b>	0.51	0.50	0.52
<b>Validity</b>	Acceptable	Acceptable	Acceptable
<b>Last Crack Front Length (mm)</b>	8.61	8.52	8.77
<b>Average Crack Elongation (mm)</b>	0.51	0.54	0.54
<b>Fracture Type (C,U,M)</b>	M	M	M
<b>Extensometer Displacement (mm)</b>	0.97	1.14	1.01
<b>Load at CTOD Value (kN)</b>	15.89	16.34	15.30
<b>CTOD Value (mm)</b>	0.299	0.355	0.303

According to the results, the best CTOD value was observed in the 6357 coded electrodes, in which the Si amount was reduced. It had also the highest impact resistance. CTOD test allowed to see the breaking mechanism of the material and determine the resistance of the material to the crack progress. The test was carried out by examining the progress of the crack as a result of the notch previously opened on the test sample, a measuring device connected to this notch and the bending was done. During the test, the crack behavior was observed. The main purpose of the test was not to see whether the material cracked against a particular load, but how long it took for it to be critical after the crack is detected. The fracture

values of all three electrodes calculated against extensometer displacement (mm) against the applied load (kN) in the CTOD test were shown in Figure 7.

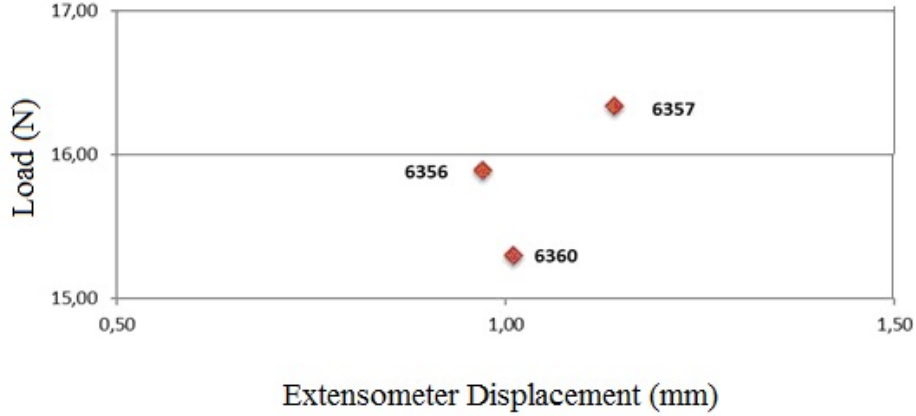

**Figure 7.** The fracture values of three electrodes in CTOD test.

When the test results of CTOD test sample of 6356 coded electrodes (with the increasing the amount of Si), the first crack length was 8.09 mm and the last crack length was 8.61. The average crack elongation was 0.51 mm. In CTOD test, while the load applied to the electrode sample with the increasing the amount of Si was 15.89 kN, the extensometer displacement of the sample was 0.97 mm. The first crack length of 6357 coded electrode was 7.98 mm, the last crack length was 8.52 mm. The average crack elongation was 0.54 mm. The load applied to electrode was 16.34 kN, while the extensometer displacement of the sample was 1.14 mm.

The first crack length of 6360 coded electrode which had a fine grain structure with the addition of Ti, was 8.24 mm and the last crack length was 8.77 mm. The average crack elongation was 0.54 mm. The load applied to electrode the was 15.30 kN, the extensometer displacement of the sample was 1.01 mm.

#### **4. CONCLUSION**

In this study, the increase of the impact energy of basic electrodes used in welding of high strength low carbon steels used at minus temperatures and their investigation with CTOD test had been done. While the grain size of the material and the amount of Si increased, it was observed that high strength low alloy steels only had a positive effect on the yield and tensile strengths of the welding material, but it had a negative effect on impact resistance. If all the electrodes are compared together; the electrode coded 6357 had the highest impact energy (79 J). The impact energy of the 6360 coded electrodes was 63 J, and the impact energy of the electrode coded 6356 was 62 J. Because of the thermal cycles, Si addition and grain thinning had a negative effect on impact resistances. The welding time was determined due to the amount of ampere and voltage used during welding, and the heat input was an important parameter in this regard. Heat input and output were important for the strength of the weld seam. When we examined the fracture surfaces of all three electrodes after notch impact test, it was observed that the three electrodes had not a brittle fracture. Since the welding should be done with the least amount of energy, it was desired to have the lowest level of heat input during welding. The heat input values were low in the electrode coded 6356, in which the Si amount was increased. When macro photos were examined before CTOD test, it was observed that heat affected zone (HAZ) was very narrow in the electrode coded 6356, in which the Si amount was increased. Because of the high heat input values, the HAZ was wide in the electrode coded 6357, in which the Si amount was decreased. The HAZ had a medium width in the electrode coded 6360, in which Ti was added as a thinner. The heat input had also medium level in the electrode coded 6360. The electrode coded 6357, which had a reduced Si amount, had the best toughness value. The average crack elongation values of the 6360(a fine grain structure with the addition of Ti) and 6357(the amount of Si was reduced) coded electrodes were the same. The amount of energy required to break the 6360 coded electrodes was lower than the amount of energy required to break the 6357 coded electrodes. The 6357 coded electrodes with a reduced Si amount had the highest impact resistance and also the highest CTOD value.

## REFERENCES

Anık, S., Tülbentçi, K., and Kaluç, E. (1991). *Örtülü Elektrod ile Elektrik Ark Kaynağı*. Gedik Education Foundation, Welding Technology Education Research and Inspection Institute, Gedik Holding Publications, Istanbul.

Antonini, J. M. (2014). “Health Effects Associated with Welding”. *Comprehensive Materials Processing*, 49-70, doi:10.1016/b978-0-08-096532-1.00807-4.

Atia, L., and Bamberger, M. (2020). “Development of Coated Electrodes for Welding of Super Duplex Steel”. *Heliyon*, Vol. 6, Issue 1, 1-10, doi:10.1016/j.heliyon.2019.e02907.

Ay, İ. (1995). “Uyumsuz Oluşum Gösteren Kaynaklı Yapıların Kırılma Tokluğuna Etki Eden Faktörler ve Bu Yapılarda CTOD Tasarım Eğrisi Yorumu”. *Journal of the Faculty of Engineering Architecture*, 76-84, Balıkesir University.

Ávila, J. A., Lima, V., Ruchert, C. O. F. T., Mei, P. R., and Ramirez, A. J. (2016). “Guide for Recommended Practices to Perform Crack Tip Opening Displacement Tests in High Strength Low Alloy Steels”. *Soldagem & Inspeção*, 21(3), 290–302. doi:10.1590/0104-9224/si2103.05.

Badkoobeh, F., Nouri, A., Hassannejad, H., and Mostaan, H. (2020). “Microstructure and Mechanical Properties of Resistance Spot Welded Dual-phase Steels with Various Silicon Contents”. *Materials Science & Engineering: A*, Vol. 790, 1-13, doi:10.1016/j.msea.2020.139703.

Berdnikova, O., Pozniakov, V., Bernatskyi, A., Alekseitenko, T., and Sydorets, V. (2019). “Effect of the Structure on the Mechanical Properties and Cracking Resistance of Welded Joints of Low-alloyed High-strength Steels”. *Procedia Structural Integrity*, Vol. 16, 89-96, doi:10.1016/j.prostr.2019.07.026.



*Investigation of Mechanical Properties of Welding Electrodes Used for  
High Strength Low Alloy Steels*

Erofeev, V., Grebenshchikova, O., and Troyanovskaya, I. (2019). "Hydrogen Impact on the Origin and Propagation of Welded Cold Cracks in Low-alloy Steels at Low Temperatures". *Materials Today: Proceedings*, Vol. 19, Part V, 1891-1894, doi:10.1016/j.matpr.2019.07.035.

Ishikawa, T., and Tanaka, K. (1984). Proceedings of the 6th International Conference on Fracture (ICF 6). New Delhi, India, 3311-3320.

Khan, Md. R., Pathak, A .K. (2020). "Practical Investigation of FSS (AISI430) Weldments Welded by Pulse MIG Welding". *Mater Today: Proceedings* 22, Part 4:2657-2664. doi:10.1016/j.matpr.2020.03.397.

Khayal, O. M. E. S. (2019). "Laboratory Experiments Tensile Testing". (Preprints). Retrieved from [https://www.researchgate.net/publication/334362493\\_LABORATORY\\_EXPERIMENTS\\_TENSILE\\_TESTING](https://www.researchgate.net/publication/334362493_LABORATORY_EXPERIMENTS_TENSILE_TESTING)

Oğuz, B. (1989). *Ark Kaynağı Elektrod Standartları*. Oerlikon.

Pathak, D., Singh, R. P., Gaur, S., and Balu, V. (2020). "Experimental Investigation of Effects of Welding Current and Electrode Angle on Tensile Strength of Shielded Metal Arc Welded Low Carbon Steel Plates". *Materials Today: Proceedings*, Vol. 26, Part II, 929-931, doi:10.1016/j.matpr.2020.01.146.

Pettarin, V., Frontini, P., and Eliçabe, G. (2003). "Inverse Method for the Analysis of Instrumented Impact Tests of Polymers". *European Structural Integrity Society*, 265–276. doi:10.1016/s1566-1369(03)80101-2.s

Ragu N., S., Balasubramanian, V., Malarvizhi, S., and Rao, A .G. (2015). "Effect of Welding Processes on Mechanical and Microstructural Characteristics of High Strength Low Alloy Naval Grade Steel Joints". *Defence Technology*, Vol. 11, Issue 3, 308-317, doi:10.1016/j.dt.2015.06.001.

Zeynep TAŞLIÇUKUR ÖZTÜRK, Abdullah Koray PEHLİVAN

Sjorgren, B., Hedstrom, L., and Lindstedt, G. (1984). “Urinary Fluoride Concentration as an Estimator of Welding Fume Exposure from Basic Electrodes”. *British Journal of Industrial Medicine*, 41(2):192-196. doi:10.1136/oem.41.2.192.

Tuma, J., Gubeljak, N., Sustarsic, B., and Bundara, B. (2006). “Fracture Toughness of a High-strength Low-alloy Steel Weldment”. *Materials in Technology*. Vol. 40, 263- 268. Retrieved from <http://mit.imt.si/izvodi/mit066/tuma.pdf>

*Journal of Naval Sciences and Engineering*  
2020, Vol. 16, No.2, pp. 193-216  
*Naval Architecture and Marine Engineering/Gemi İnşaatı ve Gemi*  
*Makineleri Mühendisliği*

RESEARCH ARTICLE

*\*An ethical committee approval and/or legal/special permission has not been required within the scope of this study.*

**GENERIC NAVAL VESSEL WASTE MANAGEMENT MODEL  
DEVELOPMENT IN SHIP-LIFE CYCLE ASSESSMENT (SLCA)  
AND COST (SLCC)\***

**Uğur Buğra ÇELEBİ<sup>1</sup>**

<sup>1</sup>*Yildiz Technical University, Department of Naval Architecture and Marine  
Engineering, Istanbul, Turkey,  
[ucelebi@yildiz.edu.tr](mailto:ucelebi@yildiz.edu.tr); ORCID: 0000-0002-2658-1291*

**Date of Receive: 10.07.2020**

**Date of Acceptance: 07.10.2020**

**ABSTRACT**

*Naval vessels are exposed to many of the rules and regulations determined by international treaties, there are few studies on life cycle analysis of these ships. The aim of study is to calculate life cycle impacts and cost analysis of two vital parts of a generic warship and investigate the emission reduction by using Life Cycle Assessment (LCA). Two important parts (valve and lubricating oil) of a generic warship are selected and the wastes and emissions of these parts are calculated by using licensed SimaPro software. The whole life cycle of the valve and lubricating oil is considered including transportation and recycling phases. Besides, Life Cycle Cost (LCC) analysis is implemented to the samples to calculate the benefits obtained by using LCA method. LCC is implemented on the system and its resulting total benefits, which is obtained by recycling process, is approximately 46,400 €. The environmental impacts of waste valve and lubricating oil are calculated by the help of licensed SimaPro software. The results show that recycling waste oil recovers the cost of waste oil separator by 30 % per ship.*

**Keywords:** *Life Cycle Assessment, Life Cycle Cost, Warship, Recycling, Ship Emissions.*

**JENERİK BİR SAVAŞ GEMİSİNDE GEMİ-YAŞAM DÖNGÜSÜ  
DEĞERLENDİRMESİ (SLCA) VE MALİYET MODELİ (SLCC)  
GELİŞTİRİLMESİ**

**ÖZ**

*Savaş gemileri, uluslararası anlaşmalar tarafından belirlenen pek çok kural ve yönetmeliklerden muaf tutulduğundan, bu gemilerin atık ve emisyon yönünden yaşam döngüsü analizi üzerine çok az çalışma vardır. Bu çalışmanın amacı, jenerik bir savaş gemisinin iki bileşeninin çevresel etkilerini ve maliyet analizini hesaplamak ve Yaşam Döngüsü Değerlendirmesi'ni (LCA) kullanarak emisyon azaltımını araştırmaktır. Jenerik bir savaş gemisinin valf ve yağlama yağı sistemleri atıkları, valf ve yağlama yağının tüm kullanım ömrü, nakliye ve geri dönüşüm aşamaları da dahil olmak üzere lisanslı SimaPro yazılımı kullanılarak hesaplanmıştır. Ayrıca, LCA yöntemi kullanılarak elde edilen faydaları hesaplamak için Yaşam Döngüsü Maliyet analizi (LCC) uygulanmıştır ve geri dönüşüm işlemiyle elde edilen toplam faydaların yaklaşık 46.400 € olduğu sonucuna ulaşılmıştır. Atık valf ve yağlama yağının çevresel etkileri hesaplanarak, atık yağın geri dönüşümünün gemi başına atık yağ ayrıştırma maliyetini %30 oranında azalttığını göstermektedir.*

**Anahtar Kelimeler:** *Yaşam Döngüsü Analizi, Yaşam Döngüsü Maliyeti, Savaş Gemisi, Geri Dönüşüm, Gemi Emisyonları.*

## **1. INTRODUCTION**

For Life Cycle Assessment (LCA) to be a holistic approach, a good co-operation should be done between the processes to achieve adequate success (Bilgili & Çelebi, 2013). Navies are very important parts of armed forces in order to protect territorial waters. Fully mission capable navies are strongly relying upon effective logistics and maintenance/repair capability. Ship Life Cycle consist of manufacturing, operation, maintenance/repair, dismantling. The operational phase of naval vessel starts with launching of the ships. Maintenance and repair processes are regularly implemented to the naval vessel by ship and shipyard crew in order to provide excellence in war tasks. LCA can be identified as a holistic assessment of product environmental performance of system including manufacturing, usage and disposal phases. Ship Life Cycle Assessment (SLCA) is a term used to identify LCA methods implemented on ships. SLCA focuses on four main stages (manufacturing, operation, repair/maintenance, dismantling) and their environmental impacts, energy consumptions and minimization techniques. Although there are few studies on SLCA, some comprehensive and innovative studies have been realized particularly over the last decade.

After the industrial revolution, steam powered and steel ships came into prominence for navies. On the other hand, these new ships began to be manufactured by using new and difficult-to-recycle material, which brings new environmental problems. Vessels generate various types of waste. (Stefano, Elvis & Boris, 2009). Hull and machinery systems have their own waste types and, although the main material is same - steel-, the waste management systems must be considered separately (Tamer, Bilgili & Çelebi, 2016).

Solid wastes include packages, rubbish, plastics etc. Liquid wastes include bilge water, ballast water, grey and black water. Gas wastes include emissions to air such as nitrogen oxides, sulfur oxides, carbon dioxide etc. A ship's life cycle (SLCA) can be divided into four main sub-categories as follows: 1. Ship Design and Manufacturing 2. Ship Operation 3. Ship Maintaining 4. Ship Recycling Life Cycle Assessment (LCA) which is a holistic, innovative and sustainable approach for all kinds of materials and products in order to make the production processes more environment-friendly and efficient. LCA systems use material databases to develop an

optimization for products. Since recycling phase is a first phase of a different product, LCA is an infinite process. An efficient design of LCA can reduce the energy consumption, used material amounts and production duration, considerably. Energy and raw materials are accepted as inputs whereas wastes and products are accepted as outputs in LCA. LCA focuses on comparing the environmental performances of different materials, analyzing the environmental impacts of production processes, developing models and evaluating of energy-environment relationship. The general concept of LCA is shown in Figure 1 (Bilgili, Unlugencoglu & Çelebi, 2014).

LCA adopts a holistic approach by analyzing the entire life cycle of a product from raw materials extraction and acquisition, materials processing and manufacture, materials transportation, product fabrication, transportation, distribution, operation, consumption, maintenance, repair and finally disposal/scrapping. (Bilgili & Çelebi, 2013; Tamer, Bilgili & Çelebi, 2016; Shama, 2005). LCA realizes the evaluations with successive and independent processes perspective and it is used for estimating the total environmental impacts caused by the all phases of life cycle including the processes not considered in traditional analysis (SAIC, 2006). LCA can be identified by the help of 6 RE philosophy: Re-think (detailed analyses for the product and its function), re-duce (minimizing the raw material and energy consumption), re-place (using less harmful materials instead of more harmful ones), re-cycle (recyclable materials are chosen), re-use (the product is produced as reusable), re-pair (the product is produced as appropriate for repair) (UNEP, 2006). Figure 1 presents the life cycle of a ship.

In his study, Fet, (2002) presented that LCA method can be used for environmental impact calculation of a ship. He explained that the processes in LCA may change according to explicator and it was emphasized the importance of system constraints that may conflict with each other. Finnveden et al., (2009) reported that LCA is a tool that includes and determines all sources which are used during all phases of life cycle (raw material, manufacturing, operation and disposal). Bilgili & Celebi, (2013) prioritizes waste management model and investigated the impact of LCA method on reducing ship-related wastes and emissions produced during

*Generic Naval Vessel Waste Management Model Development in Ship-Life Cycle Assessment (SLCA) and Cost (SLCC)*

operation phase. The authors resulted that LCA is an innovative, sustainable and holistic method which increases efficiency, decreases costs, emissions and duration. Chatzinikolaou et al., (2016) highlighted that ship life cycle can be subcategorized as manufacturing, operation, maintenance and disposal/recycling and presented that most of the emissions are produced during operation phase. The authors identified a comprehensive LCA concept for ships. They also supported this study with the results of another study which is about greenhouse gases (GHG's). Chatzinikolaou & Ventikos, (2015a) also integrated LCA method to the ship emission estimation studies in order to calculate the impacts of shipping emissions. The authors investigated the difficulties occurred during transportation, adaptation problems of methodology, complexity of choosing suitable system constraints and determining life cycle inventories in their study. Chatzinikolaou & Ventikos, (2015b) developed a new mathematical model, which is related with LCA method, which can analyze ship emissions. They also mentioned that LCA presents alternatives for maintenance/repair and disposal processes of ships. The authors indicated that using LCA increases the environmental performances. Thus, they resulted that LCA must be compounded with transportation process. Celebi et al., (2019) studied implementation of LCA and LCC to a naval vessels.

Kameyama et al., (2004) developed comprehensive software called LIME which can calculate the potential environmental impacts of ships during life cycle. The authors considered the whole life cycle of a bulk carrier including manufacturing, repair, operation and recycling processes. Alkaner & Zhou, (2005) studied on LCA of molten carbonate fuel cells (MCFC) used in shipping sector. They particularly emphasized on LCA of fuel cells which include diesel fuel. Bijwaard & Knapp, (2008) resulted that shipping is relatively safe comparing with other sectors and they indicated that adapting LCA to shipping sector and increasing of inspections will reduce the number of accidents and thus, costs. Chiffi et al., (2009) investigated on the impacts of energy consumption on ships to the environment. As a result of this study, it is reported that energy consumption of shipping increased and thus, development of abatement technologies increased, as well. Vlad (2009) investigated the contribution of mathematical programming to LCA. He used various formulas for various inventory calculations. By the help of

LCA performance analysis, Okasha et al., (2010) studied on the impacts of variable sea conditions to the ship's structural condition. In a recent report published by NATO, there are some studies on the costs of naval systems in LCA of a ship. The report indicates that Life Cycle Cost (LCC) includes all expenses occurred during operation, maintenance and disposal phases. The report also mentions that LCC is a very systematic to create cost allocation for any war program. It is indicated in the report that the obtained cost allocation must be developable, comparable with other methods and be clearly understood (NATO, 2003).

Carvalho et al., (2011) worked on modeling the environmental impacts of ship dismantling process whose data is obtained from Portuguese ship-breaking industry. They used different environmental assessment methods for different ships and they resulted that the impacts are similar. Besides, the authors indicated that environmental performance of a ship is not only related with hull type but also strongly depend on the combining effect of hull and equipment. Bengtsson et al., (2011) indicated that due to the possible future enforcements on fuel quality and exhaust emissions in Emission Control Areas (ECAs), the need for alternative fuel systems or innovative abatement technologies will increase. 4 different fuel types investigated and it was observed that fuels used in ships cause remarkable impacts on environment. Choia et al., (2015) realized the environmental performance and economic feasibility calculations for management of expired materials by using LCA and cost-benefit analysis. Seoa et al., (2015) studied on 4 different CO<sub>2</sub> liquefaction methods for catching and storage of carbons produced related with shipping activities in terms of LCA.

Another important issue in LCA is to evaluate the effect of assumptions taken and uncertainties of the elaborated data (Chatzinikolaou & Ventikos, 2014). LCA calculations processes were based upon the ISO 14040:2006 standards. First, a functional unit was defined in order to determine the restrictions of the system (Bilgili, 2019). Military vessels are very complex products that may be composed of millions of items (Pérez & Toman, 2014).

Thus, NATO, by considering the effects of scheduling and efficiency, takes an active role in cost application methods (NATO, (2008). In another report,



*Generic Naval Vessel Waste Management Model Development in Ship-Life Cycle Assessment (SLCA) and Cost (SLCC)*

NATO explained the subcomponents of warships and costs, in detail. The report presents the costs during the phases of the job definition of ships, pre-feasibility study, project definition, design and development, manufacturing and inventory (NATO, (2006). The main purposes of the document are to reveal the total cost estimation and annual expenses of the ships during design, operation, repair and maintenance processes and to reduce the costs by using LCA methods (US Department of Defense (1983).

In this study, the scheduled maintenance periods are obtained from the manufacturer and total wastes are calculated. A generic frigate is investigated and LCA and LCC are applied to the two types of wastes (lubricating oil and valve) of main and auxiliary engines.

## **2. MATERIALS AND METHODS**

Waste management is a stage of LCA to reduce, minimize or prevent the harmful wastes. For SLCA consists all of the phases of a ship, it provides to see the whole picture and relationships. SLCA is a developing and totally new approach for ship building industry and it will have more usage and importance in the future of sustainable researches for environmental performance (Bilgili & Çelebi, 2013).

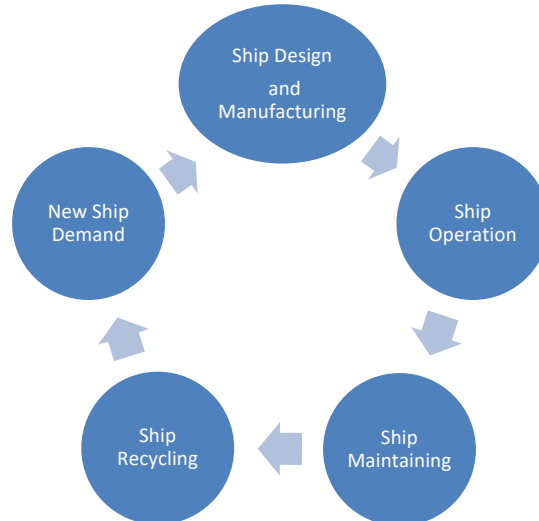

**Figure 1.** Structure overview of SLCA.

In conclusion, the use of a LCA model for analyzing ship waste management makes it possible to supply decision makers with quantitative and qualitative information at different levels, from the assessment of the environmental impacts of the overall system to the understanding of the effects of single operations and process (Stefano, Elvis & Boris, 2009). Cost prediction methods and models are exemplified in the report and a comprehensive guide is developed for LCC applications of multi-national military projects NATO (2007). NATO also identified the life cycle costs based on generic cost allocation and presented detailed information on these costs.

In 2007, the AAP-48 Procedure ‘NATO System Life Cycle Stages and Processes’ was published; this document became the standard handbook for implementation of a structure oriented towards life cycle management and to providing a common methodology for implementing the principles and terminology of this new means of administering ‘systems of interest’ (Galera, Maturana & Leiva, 2011). The maintenance periods of main and auxiliary engines consist of 5 repetitive phases. 300, 90, 30, 10 and 5 maintenances are predicted for phase number from 2 to 6, respectively for main engine. It is assumed that auxiliary engine needs 500, 125, 60, 20 and 5 maintenances for phase number from 2 to 6, respectively. The wastes are identified according to these numbers of maintenances and they are presented in Table 4-8, in detail. Fault status wastes are identified based on recent experiences. The total wastes occurred during scheduled maintenances and fault status is subsequently calculated according to Scenario-1. These wastes are used as input in waste management system based on SLCA. Licensed SimaPro 8.2.3.0 software is used for LCA calculations.

Additionally, SimaPro software is used to calculate environmental LCA impacts of wastes. The software provides an infrastructure for determining the environmental impacts and improvement opportunities, analyzing the total environmental impacts of all life cycle phases, comparing the external factors with internals, developing standards, helping companies to determine the final decisions on life cycle processes. LCA study is implemented for vital parts (valve and lubricating oil) of the generic ship.

### 3. RESULTS AND DISCUSSION

Repetitive periodical maintenances of main and auxiliary engines are extremely important and inevitable processes in order to maintain the presence of a naval vessel in war conditions. In accordance with this purpose, periodical maintenances, which are identified below, are determined and implemented by both the manufacturer and the navy.

#### 3.1. Main Engine Maintenance Periods

Keeping the engines active and the operating and maintenance costs at minimum is merely possible when the maintenance processes are implemented in time and convenient with the directives of the manufacturer. Table 1 presents the maintenance periods of main engine.

**Table 1.** Maintenance periods of main engine.

No	Scheduled Maintenance	Periods
1	Daily checks	Daily
2	Periodic maintenances are applied in the port without removing the engine	150 hours / 6 months
3	Periodic maintenances are applied in the port without removing the engine	300 hours / 1 year
4	Periodic maintenances are applied in the port without removing the engine	1500 hours / 2 years
5	Pre-overhaul is partial overhaul and the engine is removed partially	4500 hours / 6 years
6	Full overhaul is the main overhaul and the engine is completely removed	9000 hours / 12 years

### 3.2. Auxiliary Engine Maintenance Periods

The amount of waste material is calculated considering that total working hours for main and auxiliary engines are 1800 and 5000, respectively. According to these periods, the total waste produced from the engines is presented in Table 3. The information about the amounts of wastes carried out during 5 and 6 maintenance periods are obtained from shipyard.

The lifespan of the generic warship is estimated as 30 years. Because the values in the total column presents the total wastes occurred during a six years period, multiplying these amounts by 5 will give the overall waste amounts during lifespan of the ship. Thus, Table 3 shows that 95,500- and 28,200-liter waste oil, 9,020 and 8,360 lubricating oil/fuel filter waste, 13.5 and 2.5 tons of alloyed scrap steel for main and auxiliary engines, respectively. Table 2 presents the maintenance periods of auxiliary engine

**Table 2.** Maintenance periods of auxiliary engine.

No	Scheduled Maintenance	Periods
1	Daily checks	Daily
2	The maintenance is applied in the port (or at sea) without removing the engine	250 hours / 6 months
3	The maintenance is applied in the port (or at sea) without removing the engine	1000 hours / 1 year
4	The maintenance is applied in the port (or at sea) without removing the engine	2000 hours / 2 years
5	Pre-overhaul is partial overhaul and the engine is removed partially	6000 hours / 6 years
6	Full overhaul is the main overhaul and the engine is completely removed	24000 hours / 12 years

### **3.3. Life Cycle Analysis of Valve**

The alloys of valves produced for main and auxiliary engines are the same. After the end of the lifetime of valves, they are collected and sent to waste collection center. Scrap iron wastes all across the navy are delivered to a facility and recycling process is finished there.

The emissions occurred during manufacturing and recycling processes of the valve is calculated by SimaPro and the results are shown in the following tables. The valve is manufactured in a foreign country, used by the navy and after the end of the lifetime, is sent to iron and steel plant and recycled there. The total transportation distance is assumed as 315 km. Table 4, 5 presents the total amounts of significant wastes of valve.

### **3.4. Life Cycle Analysis of Lubricating Oil**

The lubricating oil used in main and auxiliary engines is supplied from domestic market in accordance with the requirements of manufacturer of the engines. Lubricating oil is produced and after the end of the lifetime, is sent to recycling facility and categorized there. The transportation distance is assumed as 350 km. The categorization process is realized in accordance with the criterion determined in waste oil regulations. The waste oil is analyzed in accredited laboratories. Table 6, 7 presents the total amounts of significant wastes of lubricating oil.

Table 4-8-set out the total estimated amounts of significant wastes of valve and lubricating oil. Manufacturing refers to the wastes occurred during manufacturing phase and transportation phase identifies the wastes occurred during the transportation of valve and lubricating oil to a recycling facility. Recycling processes are different for valve and lubricating oil. Disposal is the last phase for both products. The final discharging region of the wastes is categorized as air, water and soil.

Although SimaPro provides a wide range of various types of wastes, only the wastes which occurred in significant amounts are considered in this paper. The negative values in the tables present the positive effect of the process. For instance, 3.11 kg of iron can be recovered instead of discharging by melting.

**Table 3.** Amounts of wastes of main engine and auxiliary engine.

Type of Waste	Amounts of Wastes of Main Engine and Auxiliary Engine						
	2	3	4	5	6	Fault Status	Total
Liner (Number)	-	-	-	4	20	5	29
Piston (Number)	-	-	-	4	4	1	9
Cylinder head (Number)	-	-	-	4	4	5	13
Injector (Number)	-	-	-	10	5	5	20
Valve (Number)	-	-	-	10	10	10	30
Pump and turbo charger bearing (Number)	-	-	-	14	80	10	104
O-ring/ring/gasket /screw (Number)	2400	720	240	820	175	100	4455
Fuel filter (Number)	-	36	12	4	2	5	59
Lubricating oil filter (Number)	1200	360	120	40	20	5	1745
Lubricating oil (Liter)*	14500	-	-	2000	1000	1600	19100
Thermocouple (Number)	-	-	-	2	2	-	4
Piping system (Meter)	-	-	-	-	6	-	6
Liner (Number)	-	-	-	4	8	2	14
Piston (Number)	-	-	-	4	4	1	9
Cylinder head (Number)	-	-	-	4	1	2	7
Injector (Number)	-	-	1	4	1	1	7
Valve (Number)	-	-	-	4	10	1	15
Pump and turbocharger bearing (Number)	-	-	-	16	25	1	42
O-ring/ring/gasket/screw (Number)	3500	1000	400	88	92	20	5100
Fuel filter (Number)	-	25	12	8	2	1	48
Lubricating oil filter (Number)	700	600	288	28	7	1	1624
Lubricating oil (Liter)*	5040	-	-	400	100	100	5640
Thermocouple (Number)	-	-	-	2	2	-	4
Piping system (Meter)	-	-	-	-	5	-	5

\* Periodic change of lubricating oil is considered performed once in every 500 hours.

*Generic Naval Vessel Waste Management Model Development in Ship-Life Cycle Assessment (SLCA) and Cost (SLCC)*

### **3.5. Life Cycle Cost**

The formula for total system cost is presented in Equation 1. The equation includes various types of expenses which are explained below.

$$C = C_R + C_i + C_O \quad (1)$$

Where;

- C: Total system cost
- C<sub>R</sub>: Research and development cost
- C<sub>i</sub>: Investment cost
- C<sub>O</sub>: Operation and maintenance cost

Research and development cost consist of program management cost, advanced research and development cost, engineering and design cost and equipment development and test cost. While investment cost includes manufacturing cost, construction cost and initial logistic support cost, maintenance cost includes preventive/corrective cost and auxiliary equipment cost. Furthermore, logistics and transportation costs, maintenance training cost and technical data documentation cost are considered as major parts of total system cost.

SimaPro is a widely used and reliable software for obtaining LCA results. SimaPro 8.2.3 software and CML-IA methodology were used to determine environmental impacts categories of abiotic depletion, abiotic depletion (fossil fuels), acidification, eutrophication, global warming, ozone depletion, human toxicity, freshwater aquatic ecotoxicity, marine aquatic ecotoxicity, terrestrial ecotoxicity and photochemical oxidation. The generic ship's environmental impacts of the relevant inputs and outputs defined as a result of the matrix calculations made on the environmental impact coefficients can be seen through the relevant categories.

It is predicted that purifying the waste lubricating oil by the help of waste oil separator onboard would raise the category of the lubricating oil. It is clear that recycling waste lubricating oil, which has an economic value in other industries, can provide numerous benefits for both economy and

environment. The benefits obtained from both lubricating oil and waste scrap during life cycle can be seen in Table 6, 7. Table 8 shows that benefit obtained from recycling parts of main and auxiliary engines.

**Table 4.** The total amount of significant wastes of valve (Manufacturing, Transportation).

Wastes	Manufacturing			Transportation		
	Air	Water	Soil	Air	Water	Soil
CO <sub>2</sub>	0.8 kg	-	-	10.1 kg	-	-
PM	4.5 kg	-	-	12.7 kg	-	-
Ozone	31.8 g	-	-	130.5 g	-	-
NMVOG	0.2 g	-	-	2.2 g	-	-
Mn	2.7 g	-	36 g	4.5 g	-	66.1 g
Mg	195.3 g	49.4 kg	66.1 g	162.7 g	178.4 kg	419.2 g
TSP	-	36.3 kg	-	-	81.8 kg	-
Si	-	7.6 kg	146.8 g	-	0.4 kg	218.8 g
Na	-	8.3 kg	-	-	16.7 kg	-
Fe	-	53 kg	64.3 g	-	116 kg	983 g
Boron	-	0.6 kg	-	-	3.4 kg	-
Pb	-	22.6 g	-	-	246.5 g	-
As	-	37.8 g	-	-	174.9 g	-
Xylene	-	3.7 g	-	-	176.1 g	-
V	-	36.1 g	70.1 mg	-	310.5 g	96.6 mg
Cr	-	0.8 g	0.06 mg	-	13.1 g	2.1 mg
Cyanide	-	3 g	-	-	62.9 g	-
Al	-	-	48.4 g	-	-	481.7 g
Zn	-	-	3.3 g	-	-	13.4 g
Cu	-	-	276.9 mg	-	-	547.7 mg



*Generic Naval Vessel Waste Management Model Development in Ship-Life Cycle Assessment (SLCA) and Cost (SLCC)*

**Table 5.** The total amount of significant wastes of valve (Melting, Disposal).

Wastes	Melting			Disposal		
	Air	Water	Soil	Air	Water	Soil
CO <sub>2</sub>	-0.001 kg	-	-	11 kg	-	-
PM	-0.002 kg	-	-	17 kg	-	-
Ozone	-0.01 g	-	-	162 g	-	-
NMVOG	-0.0002 g	-	-	2.3 g	-	-
Mn	-0.001 g	-	-0.01 g	7.2 g	-	102 g
Mg	-0.05 g	-0.01 kg	-0.05 g	358 g	227.9 kg	485.2 g
TSP	-	-0.006 kg	-	-	118.1 kg	-
Si	-	-0.1 kg	-0.04 g	-	7.4 kg	365.5 g
Na	-	-0.001 kg	-	-	25 kg	-
Fe	-	-3.1 kg	-0.12 g	-	165.6 kg	1047.2 g
Boron	-	-0.0001 kg	-	-	4 kg	-
Pb	-	-0.01 g	-	-	269.1 g	-
As	-	-0.01 g	-	-	212.6 g	-
Xylene	-	-0.02 g	-	-	179.7 g	-
V	-	-0.01 g	-0.02 mg	-	346.6 g	166.7 mg
Cr	-	-0.001 g	-0.0002 mg	-	13.9 g	2.2 mg
Cyanide	-	-0.002 g	-	-	65.9 g	-
Al	-	-	-0.06 g	-	-	530 g
Zn	-	-	-0.02 g	-	-	16.7 g
Cu	-	-	-0.1 mg	-	-	824.5 mg

**Table 6.** The total amount of significant wastes of lubricating oil (Manufacturing, Transportation).

Wastes	Manufacturing			Transportation		
	Air	Water	Soil	Air	Water	Soil
CO <sub>2</sub>	301 tn.lg	-	-	0.002 tn.lg	-	-
PM	51.5 kg	-	-	12.7 kg	-	-
Ozone	1.5 kg	-	-	0.03 kg	-	-
NMVOG	36.4 kg	-	-	2.4 kg	-	-
Mn	118 g	-	0.3 kg	582.6 g	-	0.01 kg
Mg	298.8 g	115.7 kg	0.5 kg	0.1 g	0.2 kg	0.01 kg
TSP	-	64.9 kg	-	-	0.2 kg	-
Si	-	1.8 kg	1.8 kg	-	0.04 kg	0.04 kg
Na	-	297.9 kg	-	-	0.1 kg	-
Fe	-	695.2 kg	0.5 kg	-	0.1 kg	0.03 kg
Boron	-	3.1 kg	-	-	0.01 kg	-
Pb	-	1.4 kg	-	-	0.05 kg	-
Xylene	-	2.4 kg	-	-	0.04 kg	-
V	-	2.1 g	-	-	0.01 g	-
Cr	-	26.6 g	-	-	2.8 g	-
Cyanide	-	404.7 g	-	-	0.8 g	-
Al	-	0.5 kg	0.3 kg	-	0.006 kg	0.01 kg
Zn	-	118.4 kg	-	-	0.2 kg	-
Cr-VI	-	1.8 kg	-	-	0.1 kg	-
CO <sub>2</sub>	301 tn.lg	-	-	0.002 tn.lg	-	-

*Generic Naval Vessel Waste Management Model Development in Ship-Life Cycle Assessment (SLCA) and Cost (SLCC)*

**Table 7.** The total amount of significant wastes of lubricating oil (Incineration, Disposal).

Wastes	Incineration			Disposal		
	Air	Water	Soil	Air	Water	Soil
CO <sub>2</sub>	1.6 tn.lg	-	-	302.5 tn.lg	-	-
PM	273 kg	-	-	620.3 kg	-	-
Ozone	5.9 kg	-	-	7.4 kg	-	-
NMVOG	160 kg	-	-	198.5 kg	-	-
Mn	2.1 g	-	2.2 kg	702.8 g	-	2.5 kg
Mg	27.2 g	71 kg	3.5 kg	326.2 g	187 kg	4 kg
TSP	-	121.6 kg	-	-	186.8 kg	-
Si	-	17.3 kg	9 kg	-	19.1 kg	10.9 kg
Na	-	70.3 kg	-	-	368.3 kg	-
Fe	-	20.2 kg	3.1 kg	-	715.6 kg	3.6 kg
Boron	-	2.4 kg	-	-	5.5 kg	-
Pb	-	87.7 kg	-	-	89.1 kg	-
Xylene	-	1.9 kg	-	-	4.4 kg	-
V	-	3.1 g	-	-	5.2 g	-
Cr	-	206.5 g	-	-	235.9 g	-
Cyanide	-	1083.7 g	-	-	1489.2 g	-
Al	-	2.3 kg	2.3 kg	-	2.8 kg	2.6 kg
Zn	-	4.9 kg	-	-	123.5 kg	-
Cr-VI	-	1.6 kg	-	-	3.5 kg	-
CO <sub>2</sub>	1.6 tn.lg	-	-	302.5 tn.lg	-	-

**Table 8.** Benefit obtained from recycling parts of main and auxiliary engines.

Supplies	Change Amount	Unit Price	Change Period	Total Changed Amount	Benefit
Lubricating oil	~900 liter	0.35 €/l	In every 500 working hours	~124,000 liter	~43,500 €
Scrap iron	~3.2 tons	178 €/ton	In every 5 years	~16 ton	~2,900 €
<b>TOTAL</b>					<b>~46,400 €</b>

#### **4. CONCLUSION**

Life Cycle Assessment (LCA) of a product is used to identify, evaluate and minimize energy consumption and environmental impacts, holistically, across the entire life of the product. Naval vessels have been used for defensive purposes by the countries that have a coastal line for centuries. Production and maintenance of these vessels include many complex processes depending on their missions, weapons and sea condition. Investigating the published military rules show that there are not enough documents and reports on life cycle analysis of military ships. Naval vessels are exempted from the rules and regulations that are determined by international treaties. Extensive use of military and commercial ships results in environmental pollution, waste of energy and misuse of natural resources.

The environmental impacts of valve and waste oil of main and auxiliary engines are calculated with the help of SimaPro. Waste oil cannot be reused as waste oil, again. After analyzing, waste oil is categorized and treated to be proper for disposal or using in different sectors such as construction. Waste oil produced in main and auxiliary engines is categorized as Category-3 and it is disposed by incineration or discharging to soil or water. Discharging waste oil causes great damage to the environment. It is concluded that the total cost of waste oil separator system is 150,000 € and estimated profit by using SLCA method is 50,000 €. The results show that recycling waste oil recovers the cost of waste oil separator by 30 %.

The analysis shows emissions that occur during transportation are non-negligible. It is determined that establishing the shipyards near to recycling/reusing/disposal facilities and modeling the valve and waste oil produced in main and auxiliary engines of a naval vessel by the help of SLCA methodology have positive contribution for both environmental performance and economy. Considering that a war ship has hundreds of systems and devices, it can be concluded that implementing SLCA methodology to whole ship may provide better environmental performance and result in benefits on economy.

*Generic Naval Vessel Waste Management Model Development in Ship-Life  
Cycle Assessment (SLCA) and Cost (SLCC)*

**ACKNOWLEDGMENT**

The author presents special thanks to the Turkish Lloyd for its financial support to buy licensed SimaPro Software.

## REFERENCES

Alkaner, S., and Zhou, P. (2006). “A Comparative Study on Life Cycle Analysis of Molten Carbon Fuel Cells and Diesel Engines for Marine Application”. *Journal of Power Sources*, 158:188–199.

Bengtsson, S., Andersson, K., and Fridell, E. (2011). “Life Cycle Assessment of Marine Fuels: A Comparative Study of Four Fossil Fuels for Marine Propulsion”. *Chalmers University of Technology*, Göteborg, Sweden, ISBN: 1652-9189.

Bijwaard, G. E., and Knapp, S. (2008). “Analysis of Ship Life Cycles: The Impact of Economic Cycles and Ship Inspection”. *Marine Policy*, 33:350-369.

Bilgili, L. (2019). “The Social Cost and Environmental Life Cycle Analysis of Passenger Ships in Istanbul”. *Journal of ETA Maritime Science*, 7(3), 252-263. doi:10.5505/jems.2019.75437.

Bilgili, L., and Celebi, U. B. (2013). Life Cycle Assessment Approach of Waste Management for Ship Operation. In H. Bártolo et al. (Eds.), *Green Design, Materials and Manufacturing Processes* (pp. 269-272). Proceedings of the 2<sup>nd</sup> International Conference on Sustainable Intelligence Manufacturing. *CRC Press*.

Bilgili, L., Unlugencoglu, K., and Celebi, U. B. (2014). Life Cycle Assessment Model Establishment for Ships. *INT-NAM 2014 (Second International Symposium on Naval Architecture and Maritime)*, 1-6, 23-24 October, Istanbul, Turkey, ISBN: 978-605-4123-32-2 (E)

Carvalho, I. S., Antão, P., and Soares, C. G. (2011). “Modelling of Environmental Impacts of Ship Dismantling”. *Ships and Offshore Structures*, 6 (1–2):161–173. doi:10.1080/17445301003776233.

*Generic Naval Vessel Waste Management Model Development in Ship-Life Cycle Assessment (SLCA) and Cost (SLCC)*

Celebi, U. B., Bilgili, L., and Yilmaz, B. (2019). “Life Cycle Cost Analysis for the Yaw Damping System of a Warship from a Financial Viewpoint”. *Brodogradnja*, 70(1), 1-9.

Chatzinikolaou, S., and Ventikos, N. (2014). Applications of Life Cycle Assessment in Shipping. *INT-NAM 2014 (Second International Symposium on Naval Architecture and Maritime)*, 23-24 October 2014, Istanbul, Turkey ISBN: 978-605-4123-32-2 (E).

Chatzinikolaou, S., and Ventikos, N. (2015a). Critical Analysis of Air Emissions from Ships: Life Cycle Thinking and Results. In H. N. Psaraftis (Ed.), *Green Transport Logistics: The Quest For Win-Win Solutions* (pp. 387-412). Springer, ISBN: 978-3-319-17174-6.

Chatzinikolaou, S., and Ventikos, N. (2015b). “Holistic Framework for Studying Ship Air Emissions in a Life Cycle Perspective”. *Ocean Engineering*, 110:113–122. doi:10.1016/j.oceaneng.2015.05.042.

Chatzinikolaou, S., Ventikos, N., Bilgili, L., and Celebi, U. B. (2016). Ship Life Cycle Green House Gas Emissions, Part XV, Chapter 65. In P. Grammelis (Ed.), *Energy, Transportation and Global Warming* (pp. 883-895). Springer, ISBN 978-3-319-30126-6.

Chiffi, C., and Fiorello, D. (2009). “Energy Intensity of Maritime Trades: Evidences from the EX-TREMIS Database”. *Energy Policy*, 37(10):3752–3757. doi:10.1016/j.enpol.2009.07.014.

Choi, J-K., Kelley, D., Murphy, S., and Thangamani, D. (2016). “Economic and Environmental Perspectives of End-of-Life Ship Management”. *Resources, Conservation and Recycling*, 107: 82–91. doi:10.1016/j.resconrec.2015.12.007.

Department of Defense of U.S. (1983). Military Handbook, Life Cycle Cost in Navy Acquisitions. MIL-HDBK-259 (Navy).

Fet, A. M. (2002). "Environmental Reporting in Marine Transport Based on LCA". *Journal of Marine Design and Operations, B (B1)* 1476–1556.

Finnveden, G., Hauschild, M. Z., Ekvall, T., Guinée, J., Heijungs, R., Hellweg, S., Koehler, A., Pennington, D., and Suh, S. (2009). Recent Developments in Life Cycle Assessment. *Journal of Environmental Management*, 91:1–21. doi:10.1016/j.jenvman.2009.06.018.

Jivén, K., Sjöbris, A., Nilsson, M., Ellis, J., Trägårdh, P., and Nordström, M. (2004). LCA-Ship, Design Tool for Energy Efficient Ships - A Life Cycle Analysis Program for Ships. Final Report. MariTerm AB. Retrieved from <http://www.mariterm.se/wp-content/uploads/2016/08/Final-report-LCA-ship.pdf>

Kameyama, M., Hiraoka, K., and Tauchi, H. (2007). Study on Life Cycle Impact Assessment for Ships. *National Maritime Research Institute*, Vol. 7, No. 3, 133-143. Retrieved from <https://www.nmri.go.jp/oldpages2/main/publications/paper/pdf/21/07/03/PNM21070304-00.pdf>

North Atlantic Treaty Organization (NATO) (2006). Ship Costing. Allied Naval Engineering Publication (ANEP). *NATO - ANEP-41*, Ed.4, NATO NG/6 Specialist Team on Ship Costing.

NATO (2008). NATO Guidance on Life Cycle Cost. *NATO - ALCCP-1*, Ed.1.

NATO, and Research and Technology Organisation (2003). Cost Structure and Life Cycle Costs for Military Systems. *NATO, Research and Technology Organisation (RTO) Technical Report*, TR-058, SAS-028.

NATO, and Research and Technology Organization (2007). Methods and Models for Life Cycle Costing. *NATO, Research and Technology Organisation (RTO) Technical Report*, TR-SAS-054.



*Generic Naval Vessel Waste Management Model Development in Ship-Life Cycle Assessment (SLCA) and Cost (SLCC)*

Navarro-Galera, A., Ortúzar-Maturana, R. I., and Muñoz-Leiva, F. (2011). “The Application of Life Cycle Costing in Evaluating Military Investments: An Empirical Study at an International Scale”. *Defence and Peace Economics*, 22:5, 509-543. doi:10.1080/10242694.2010.508573.

Okasha, N. M, Frangopol, D., and Decò, A. (2010). “Integration of Structural Health Monitoring in Life-Cycle Performance Assessment of Ship Structures Under Uncertainty”. *Marine Structures*, 23:303–321. doi: 10.1016/j.marstruc.2010.07.004.

Pérez, R., and Toman, M. (2014). Tuning CAD Tools to Fit Naval Design Requirements. *INT-NAM 2014 (Second International Symposium on Naval Architecture and Maritime)*, 23-24 October 2014, Istanbul, Turkey ISBN: 978-605-4123-32-2 (E).

Scientific Applications International Corporation (SAIC) (2006). Life Cycle Assessment: Principles and Practice. *U.S. Environmental Protection Agency*, Washington, DC, EPA/600/R-06/060.

Seo, Y., You, H., Lee, S., Huh, C., and Chang, D. (2015). “Evaluation of CO<sub>2</sub> Liquefaction Processes for Ship-Based Carbon Capture and Storage (CCS) in Terms of Life Cycle Cost (LCC) Considering Availability”. *International Journal of Greenhouse Gas Control*, 35:1–12. doi: 10.1016/j.ijggc.2015.01.006.

Shama, M. A. (2005). Life Cycle Assessment of Ships. In C. G. Soares, Y. Garbatov, and N. Fonseca (Eds.), *Maritime Transportation and Exploitation of Ocean and Coastal Resources* (pp. 1751-1758), Taylor & Francis Group, London, ISBN 0 415 390362.

Tamer, E., Bilgili, L., and Celebi, U. B. (2016). Waste Management with Life Cycle Analysis Method for Military Ship Machine Systems. *Third Eurasia Waste Management Symposium*, 598-603, Istanbul, Turkey.

UNEP (2006). Background Report for a UNEP Guide to Life Cycle Management - A Bridge to Sustainable Products. *United Nations Environment Programme (UNEP)*, A.A. Jensen and A. Remmen (Eds.).

Vlad, M. (2009). Development and Application of Mathematical Programs for Contribution Analysis in Life Cycle Assessment. (Master's Thesis). *Norwegian University of Science and Technology, Department of Energy and Process Engineering, Master of Science in Energy and Environment*. Retrieved from [https://ntnuopen.ntnu.no/ntnu-xmlui/bitstream/handle/11250/233686/348909\\_FULLTEXT01.pdf?sequence=2&isAllowed=y](https://ntnuopen.ntnu.no/ntnu-xmlui/bitstream/handle/11250/233686/348909_FULLTEXT01.pdf?sequence=2&isAllowed=y)

Zuin, S., Belac, E., and Marzi, B. (2009). "Life Cycle Assessment of Ship-Generated Waste Management of Luka Koper". *Waste Management*, 29(12): 3036–3046.doi:10.1016/j.wasman.2009.06.025.

*\*An ethical committee approval and/or legal/special permission has not been required within the scope of this study.*

**CLUSTERING BASED FEATURE EXTRACTION METHODS FOR  
SEMAPHORE FLAG RECOGNITION\***

**Batuhan GÜNDOĞDU<sup>1</sup>**  
**Deniz KUMLU<sup>2</sup>**

<sup>1</sup> *National Defence University, Turkish Naval Academy, Department of  
Electrical and Electronics Engineering, Istanbul, Turkey,  
[mbgundogdu@dho.edu.tr](mailto:mbgundogdu@dho.edu.tr); ORCID: 0000-0002-9395-7519*

<sup>2</sup> *National Defence University, Turkish Naval Academy, Department of  
Electrical and Electronics Engineering, Istanbul, Turkey,  
[dkumlu@dho.edu.tr](mailto:dkumlu@dho.edu.tr); ORCID: 0000-0002-7192-7466*

**Date Received: 07.10.2020**

**Date of Acceptance: 19.11.2020**

**ABSTRACT**

*Semaphore flag signaling is a visual communication system used by Naval vessels when the radio emissions are under strict control during electronic warfare. This paper presents an autonomous semaphore flag signaling recognition system that translates the RGB images into letters with a high performance at a low cost. A dataset is created for the semaphore flag signals for the English alphabet and the relative angles of the flags are acquired via morphological operations. The summarization of the flag locations is conducted with three methods: binary erosion the shrinking, k-means clustering and hierarchical agglomerative clustering. The resulting features with low dimensionality are then classified with support vector machine classifier with polynomial kernel. The cross-validation experiments show that the proposed methodology yields 99.76% accuracy, with no need for a Kinect sensor and computationally expensive neural network training that requires GPUs, as proposed by the similar works in the literature.*

**Keywords:** *Semaphore Flag Recognition, Histogram of Oriented Gradients, Morphological Image Processing, Support Vector Machines.*

## SİMAFOR BAYRAK TANIMA İÇİN KÜMELEME TABANLI ÖZNİTELİK ÇIKARMA YÖNTEMLERİ

### ÖZ

*Simaför ile bayrak muhaberesi elektronik harp esnasında yayın kontrolü yapılırken gemiler arasında çokça kullanılan bir görsel muhabere yöntemidir. Bu makalede RGB kamera imgeleri ile çalışan, yüksek performanslı ve düşük maliyetli bir otomatik simaför tanıma sistemi önerilmektedir. Bu maksatla İngilizce simaför alfabesindeki harflere tekabül gelen bir veri seti oluşturulmuş ve morfolojik işlemler ile sancaklar arasındaki açılar otomatik olarak tespit edilmiştir. Sancak mevkilerinin özetlemesinde üç metot kullanılmıştır: ikili erozyon ile küçülme, k-ortalamlar ile öbekleme ve hiyerarşik toplayıcı öbekleme. Çok küçük boyutlu uzayda elde edilen öznitelikler ile karar destek makineleri kullanılarak sınıflandırma gerçekleştirilmiştir. Çapraz doğrulama deneyleri ile Kinct algılayıcıya ve hesap bakımından maliyetli sinir ağlarının çalışacağı GPU donanımlarına gereksinim duyulmaksızın %99.76'lık bir başarıya ulaşıldığı gözlemlenmiştir.*

**Keywords:** *Simaför Sancak Tanıma, Yönlü Gradyenlerin Histogramı, Morfolojik İmge İşleme, Karar Destek Makinası.*

## 1. INTRODUCTION

Autonomous human-machine interface (HMI) systems have recently gained interest in the machine learning literature. This paper proposes an autonomous HMI system to facilitate semaphore flag signaling (SFS) recognition. SFS is a visual communication technique that was used for far field communications before the invention of telegraph. It is now mainly used by the Navy under emission control operations either during electronic warfare or while underway replenishment. It is usually employed by means of flags (or lights) and moving them to different angles to depict different letters. This set of symbols can be seen in Figure 1. The aim of this study is to translate the images of flag operators holding flags, into the corresponding letters. This work can be considered as an example of human posture and body gesture recognition applications.

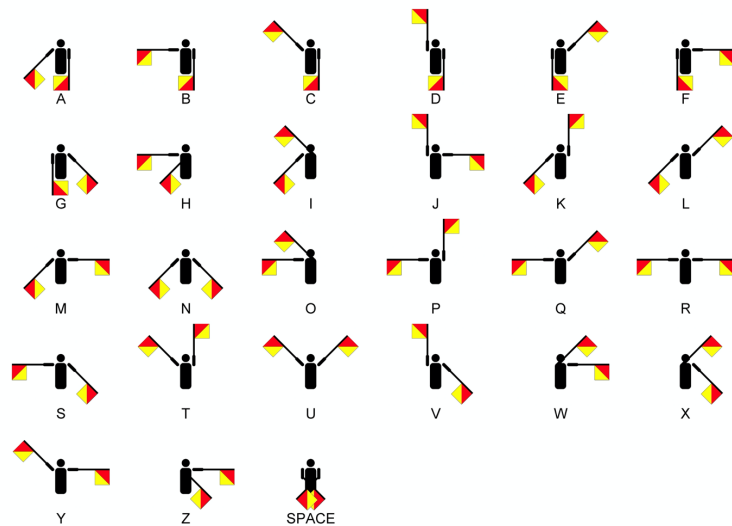

**Figure 1.** The SFS Alphabet.

Several studies have been conducted over the past decade on automated recognition of semaphore flag signaling. The initial work used Kinect sensors to address the problem, since in SFS the information is conveyed via the angles between arms and the body. In (Iwane, 2012), a rule-based table

look-up methodology was proposed, acting on angles of head and elbow measured by a Kinect sensor. This work was implemented over a set of 14 Japanese semaphore characters. In (Hsieh & Shih, 2015), SFS was addressed to use robots as tangible learning companions. This work also depends on Kinect sensor measurements of human holding flags in order to recognize and implement robot interaction. The study was limited to run over 10 semaphore signals selected from the semaphore alphabet given in Figure 1.

To our knowledge, the first work dealing with the whole alphabet set was (Rachmad & Fuad, 2015), in which the geometric calculations were conducted on skeleton image points, obtained by a Kinect sensor. The work used three representative points out of Kinect measurements, i.e. the center of shoulder, right and left elbows and proposed calculating geometric attributes for each letter. Similarly, (Hung, Hsu & Chen, 2015) studied utilizing robots to enhance learning SFS, in the task called situated learning. The authors used 10 selected symbols of the semaphore flag alphabet using a Kinect sensor.

More recent work such as (Zhao et. al, 2016), proposed working on monocular camera images of semaphore flag signals, as Kinect sensor is rarely available on practical applications. They proposed using convolutional neural networks (CNN) trained on raw image pictures, on a selected set of 5 semaphore flag signals. Similarly, (Tian et. al, 2018) proposed using the state-of-the-art feature extractor called Openpose (Cao et. al, 2018), based on deep neural networks. They proposed recognizing the whole set of semaphore alphabet flags, detecting successfully the combinations of 7 main directional angles. More recently, (Motty, Yogitha, & Nandakumar, 2019) used pre-trained CNN's to implement an end-to-end semaphore flag recognition system that operates on images captured by camera. The most recent work approaches the problem with cameras and RGB images, eliminating the necessity for Kinect sensors, though it should be noted that such deep models require greater computational resources like GPUs to be able to provide real-time recognition. A summary of the related work in SFS recognition is also given in Table I.

Our main ambition with this study is to propose a robust feature extraction methodology for a low cost SFS classifier that works over the whole semaphore alphabet. For this, we introduce an area of interest detection methodology that makes use of morphological operations. We detect red regions that are expected to correspond to the semaphore flags and extract the location information of these regions by three methodologies: shrinking by binary erosion, k-means clustering and hierarchical agglomerative clustering (HAC). We compare these three methodologies with each other, as well as the performance of histogram of oriented gradients (HOG) features. As the Kinect sensor is rarely available in practical applications, the more recent research focuses on camera images. Nonetheless, the high-performance systems that use deep features such as Openpose or CNN bottlenecks require costly hardware (e.g. GPUs) for low latency operation, as reported by (Motty., Yogitha, & Nandakumar, 2019). The proposed technique in this work, on the other hand, works on RGB images, with high accuracy and at a comparatively low computational cost. We compare the performance of our system with the baselines with respect to both the accuracy and the run time metrics. In addition to the methodological and applicational novelties stated above, we provide the semaphore dataset RGB images and the feature vectors that we created available online, for further research.

## **2. METHODOLOGY**

The technique proposed in this paper follows a series of image segmentation and morphological processing phases in order to obtain a low dimensional discriminative feature for classification.

We use RGB images as inputs and seek a low-cost subspace for model training, in order to alleviate the need of high performance GPUs, as necessitated by deep models like CNNs. We propose three such methods that seek to find the flag locations and compare them with baseline feature extractors both on accuracy and computation time metrics. Once the feature vectors are obtained, we train SVM-based classifiers to obtain the corresponding letters from the images.

**Table 1.** Summary of different works pertaining to semaphore flag recognition.

Study	Sensor	#Flag Signs	Classifier	Feature Representation
(Iwane, 2012)	Kinect	14	Table look-up and model comparison	Angles of head and elbows
(Hsieh & Shih, 2015)	Kinect	10	Table look-up and model comparison	Skeleton images
(Rachmad & Fuad, 2015)	Kinect	26(full)	Table look-up and model comparison	Three points from skeleton images: Center point of shoulder, right and left wrist
(Hung, Hsu & Chen, 2015)	Kinect	10	Hand position detection for situated learning	Skeleton images
(Zhao et. al, 2016)	Camera	5	CNN	Raw RGB
(Tian et. al, 2018)	Camera	All 26 flags from 7 positional vectors	DNN(openpose)	Raw RGB
(Motty., et. al, 2019)	Camera	26(full)	Pretrained CNN	Raw RGB
This work	Camera	26(full)	SVM	Very low-D position indices HOG PCA



The proposed methodology of detecting the flags is as follows: The big chunks of red pixels that exist on the two flags are emphasized by differencing the red channel from the gray-scale mapping of RGB image.

These emphasized red regions are generally discontinuous due to the shadows on the flag, or due to the occlusion caused by the folding of the flag. We use a big enough median filter to address such discontinuities on the bright regions that correspond to the red portion of the semaphore flag. The resulting image is then quantized to be binary, where the red regions are white and the non-informative rest of the image is cast to black. The shape and size of the median filter should be chosen relative to the size of the flag. With the binary image involving the chunks of white regions that correspond to the flag positions, only the white pixel locations are taken into account and the integer valued pixel addresses are clustered to 2 centroid locations. In the end, all we wish to obtain is a feature vector for each image that would have the coordinates of the center of the two flags, because the information about the letters are conveyed with respect to the relative locations and the angle between the two flags. The feature vector can be expressed as:

$$\mathbf{v} = [R_x, R_y, L_x, L_y] \quad (1)$$

Where R and L stand for right and left, and the superscripts are the 2-D coordinates (See Figure 2).

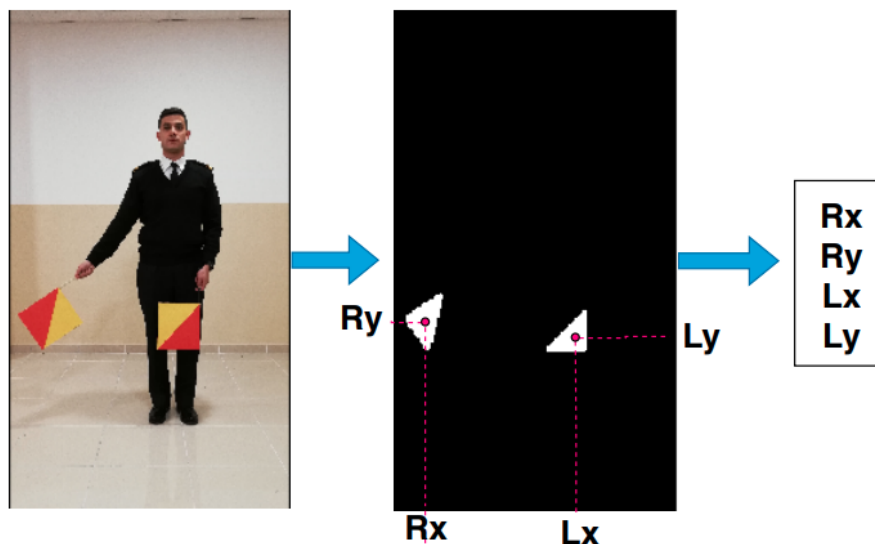

**Figure 2.** Feature extraction for red area detection.

We follow three schemes to obtain the centroid locations for the two clusters of white pixels:

- Shrinking by binary erosion (Rao, Prasada & Sarma, 1976).
- K-means clustering (Lloyd, 1982).
- Hierarchical agglomerative clustering (Day & Edelsbrunner, 1984).

### 2.1. Clustering by Shrinking

The shrinking algorithm conducts erosion on connected white pixels starting from the ones that touch the black pixels, i.e. the outer borders, until they are reduced to one pixel. The advantageous aspect of this algorithm is that it is guaranteed to summarize the right-hand image in Figure 2 as long as the white area is connected. However, the algorithm suffers from inconsistent run-time duration that is dependent on the size of the connected white area. With the shrinking algorithm, an object without holes erodes to a single pixel at or near its center of mass; on the other hand, an object with holes erodes to a connected ring lying midway between each hole and its nearest

outer boundary. Such an effect can be seen on the sample in Figure 3. It should be noted that we apply a median filter that is applied prior to the morphological processing and the effect of this filter is to alleviate such problems.



**Figure 3.** Shrinking behaviors of connected and non-connected objects, the original shapes are given on the left and the shrunk objects are on the right figure.

## 2.2. K-means Clustering

As the second algorithm, we used the k-means clustering to obtain the white pixel clusters, i.e. the flag centroids, since the shrinking algorithm may suffer from non-connected areas. A situation where the white pixels are not connected is quite likely due to the folding of the flags or the occlusion effects. The k-means clustering algorithm is appealing in this application since the number of clusters is definitely known to be two, since we have two flags. For this, the squared Euclidean distance between the addresses of the white pixels and the corresponding centroids are minimized. The assignments of the pixels to the left (L) and right (R) flags and the updates of the centroids are done via expectation minimization. The cost function in the maximization process can be stated as thus:

$$R_x, R_y, L_x, L_y = \underset{R_x, R_y, L_x, L_y}{\operatorname{arg\,min}} J(R_x, R_y, L_x, L_y) \quad (2)$$

$$\begin{aligned}
 J = & \sum_{(i,j) \in L} (i - L_x)^2 + (j - L_y)^2 \\
 & + \sum_{(m,n) \in R} (m - R_x)^2 + (n - R_y)^2
 \end{aligned} \tag{3}$$

K-means clustering approach is faster and more robust than the shrinking-based approach; however, it suffers from the initialization of the centroids. The resulting 4-dimensional vector may not be consistent over all set of images. Therefore, in order to address this aspect, we used the hierarchical agglomerative clustering (HAC) as the third clustering algorithm as a compromise between the shrinking-based approach and the k-means based approach.

### 2.3. Hierarchical Agglomerative Clustering

In the hierarchical agglomerative clustering, new clusters are formed at each iteration starting from the closest pixels. Euclidean distance metric-based dissimilarities are calculated between addresses of each white pixel pair, and then a new cluster is formed to involve the white pixel pair that has the shortest distance at each iteration. On the consequent iterations, white pixels are added to the group to which they are the closest. This procedure is continued until there are two groups left. At each iteration, the distance ( $D$ ) between two clusters  $\mathcal{A}$  and  $\mathcal{B}$  is decided by the minimum distance between points that belong to them:

$$D(\mathcal{A}, \mathcal{B}) = \min_{a \in \mathcal{A}, b \in \mathcal{B}} d(a, b) \tag{4}$$

and the distance update formula between the fusion of the two clusters and another cluster is conducted likewise:

$$D(\mathcal{A} \cup \mathcal{B}, \mathcal{C}) = \min(D(\mathcal{A}, \mathcal{C}), D(\mathcal{B}, \mathcal{C})) \tag{5}$$

Where  $d(a,b)$  is the Euclidean distance metric between the locations of white pixels denoted by  $a$  and  $b$  (Müllner, 2011).

HAC algorithm could be stopped at any iteration and could potentially yield the best clusters so far. For this specific application we continue until there are two clusters, corresponding to the right and left flags.

#### **2.4. Baseline Models**

The low dimensionality representation denoted by the pixel locations is compared to two baseline methods. In the first methodology the principle component analysis (PCA) over the grayscale images is conducted to obtain the lowest dimensionality subspace representation that would give the maximum variance.

As the second baseline, we obtained the histogram of oriented gradients (HOG) (Dalal & Triggs, 2005) representation. HOG has never been used for semaphore recognition tasks, yet it can be seen as an appropriate feature set since it is generally used as a spatio-temporal descriptor that captures the angles in the images. Initially proposed for pedestrian detection, HOG has been successfully used in similar tasks like human action recognition (Ikizler & Duygulu, 2009) hand gesture recognition (Freeman & Roth, 1995), human detection (Zhu, Yeh, Cheng & Avidan, 2006) and explosive detection (Temlioglu, Erer & Kumlu, 2017). In HOG feature extraction, we divide an image of size  $I_x \times I_y$  into blocks of  $B_x \times B_y$  and calculate  $O$  orientated gradients within each block. The normalization of these gradients is taken within  $C_x \times C_y$  cells and the histogram vectors of the gradients are calculated for each cell, yielding a feature vector of size:

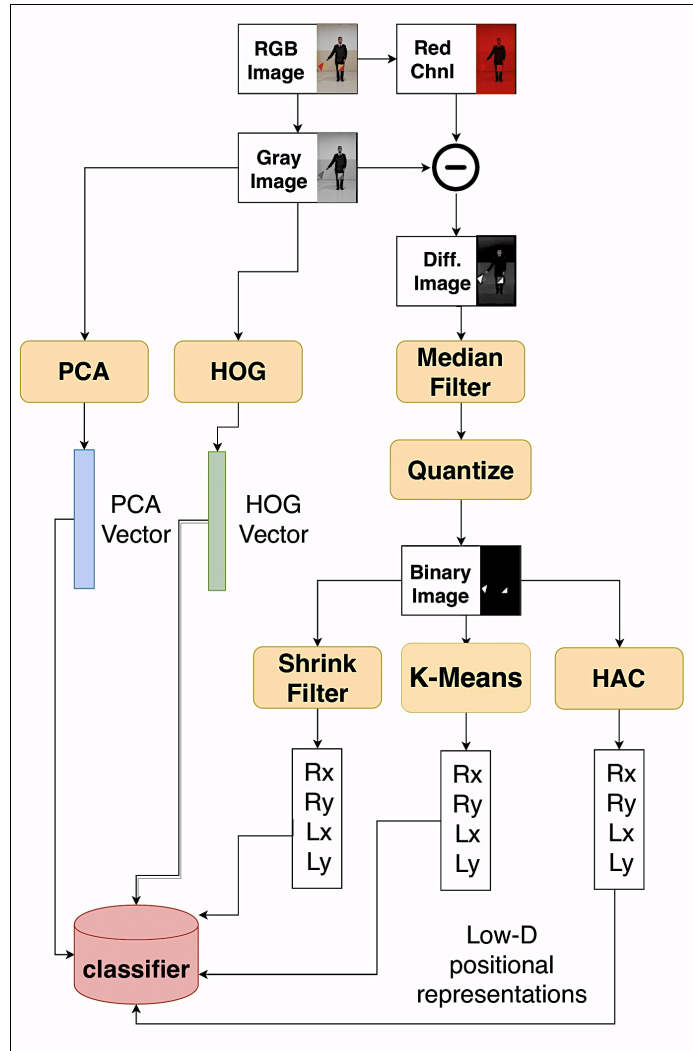

**Figure 4.** The flowchart of the feature extraction methods proposed in this paper.

$$\begin{aligned} HOG &= S_x S_y B_x B_y O \\ S_x &= \left( \frac{I_x}{C_x} - (B_x - 1) \right) \\ S_y &= \left( \frac{I_y}{C_y} - (B_y - 1) \right) \end{aligned} \quad (6)$$

This high dimensional feature vector is expected to convey more discriminative information than the raw image and a PCA is also applied on this feature.

The feature vectors obtained by each of the methodologies are used to train a support vector machine-based classifier (Suykens & Vandewalle, 1999) in order to assess the discrimination power of the proposed models. The flowchart of the methodologies explained in this chapter can be seen in Figure 4.

### **3. EXPERIMENTS**

For the experiments we created a semaphore flag signaling dataset over the whole alphabet and the proposed techniques were compared with various feature dimensions using both accuracy and computation time metrics.

#### **3.1. Dataset**

The semaphore dataset was created by the Naval Academy midshipmen and the semaphore flags provided for educational purposes. Four different students took part in the preparation of the dataset, who has different body sizes. In addition to using different height subjects in dataset creation, we also allowed same lighting and camera distance changes to provide a naturalistic variation of images. The source code of the methodologies explained in this paper and the dataset can be found online at (Gundogdu, 2019). We collected five images from each of the subjects, summing to 20 images for each of the 26 semaphore signs.

### 3.2. Result

For the experiments, we used half of the dataset for training and the other half for testing. We employed this method for 10 different random segmentations of the dataset for each of the features. Table II presents the performance comparison of the techniques proposed in this paper and the baseline techniques. We employed dimensionality reduction and whitening via PCA and investigated various dimension sizes. We also measured the CPU time needed for each feature extraction methodology. As expected, HOG provides a better discrimination when compared to the baseline of pure PCA on raw features.

As for the proposed, morphological processing-based methods, k-means clustering provides fast feature reduction technique that achieves good classification performance. As stated in the methodology section it suffers from the initialization ambiguities.

**Table 2.** Comparison of the methods proposed.

Feature	Dim	Acc (%)	CPU Time (msec)
PCA	4	81.19	9.25
	16	93.90	9.83
	32	95.03	11.52
	64	94.42	15.39
	128	93.49	20.23
HOG	4	45.07	19.85
	16	90.53	19.89
	32	95.65	19.96
	64	97.15	19.98
	128	97.30	20.19
Morph+K-means	4	96.84	9.9
Morph+Shrink	4	99.60	31.94
<b>Morph+HAC</b>	<b>4</b>	<b>99.76</b>	<b>11.75</b>



## Clustering Based Feature Extraction Methods for Semaphore Flag Recognition

On the other hand, both the shrinking and the HAC-based clustering methods outperform the HOG-based features with considerably lower dimensions. With the extraction time of 31.94 milliseconds, shrinking-based clustering is impractical for online execution since the video frames are expected to be processed with 50 frames per second in real time applications. The HAC-based method, on the other hand, achieves the best performance with the fastest processing.

Figure 5 shows the average accuracy of several features with respect to their dimensionality. We see that the HOG-based methods outperform the PCA on raw images when higher dimensional vectors are used. The morphological processing-based methods, on the other hand, achieve a superior performance on the smallest dimensionality as aimed. Figure 6 demonstrates the best classification accuracy of the four feature extraction techniques with respect to the CPU time required. We see that the HAC-based method achieves the best performance with the smallest execution time.

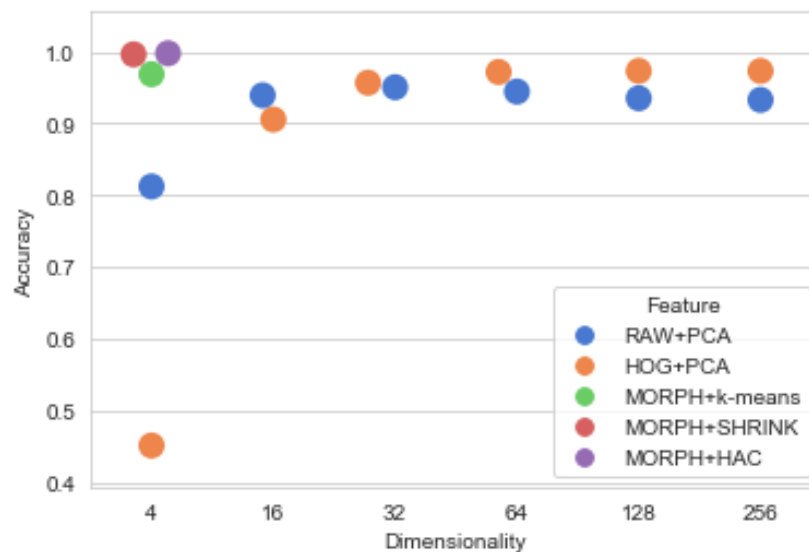

**Figure 5.** Classification accuracy of different methods with respect to feature dimension sizes.

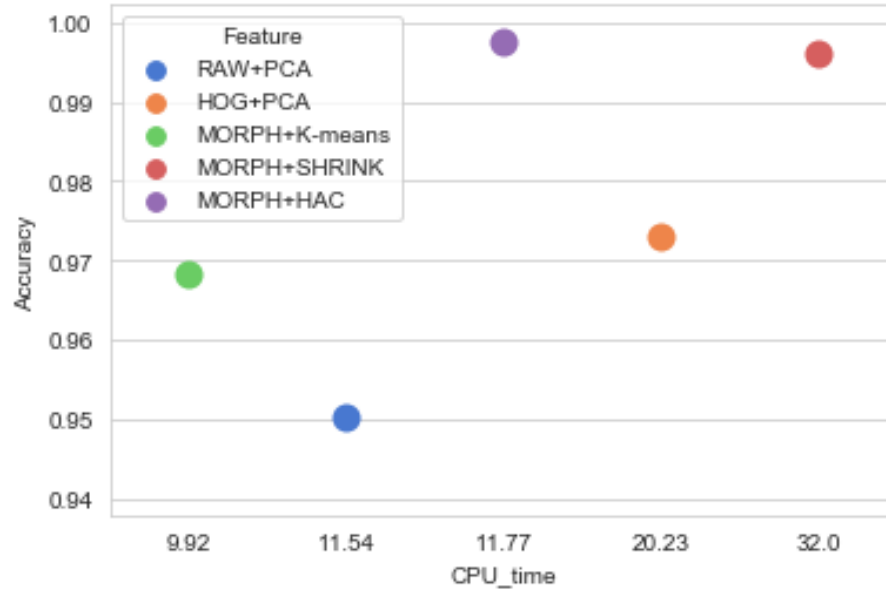

**Figure 6.** Classification accuracy of different methods with respect to feature extraction times.

#### **4. CONCLUSION**

In this paper, we proposed a morphological processing and clustering-based feature extraction methodology for the real-time semaphore flag signaling recognition. The red areas in the semaphore flags were detected and the centroids of the flags are calculated with three clustering methodologies. We compared the proposed methods with the HOG and PCA-based baselines and we showed that the proposed methods could be used as a high-performance low-cost feature extraction technique for the SFS classification tasks.

*Batuhan GÜNDOĞDU, Deniz KUMLU*

**ACKNOWLEDGEMENT**

The authors would like to thank all midshipmen of Naval Academy who took part in generating the semaphore dataset.

## REFERENCES

Cao, Z., Hidalgo, G., Simon, T., Wei, S. E., and Sheikh, Y. (2018). "OpenPose: Realtime Multi-person 2D Pose Estimation Using Part Affinity Field". *arXiv Preprint*. arXiv:1812.08008. Retrieved from <https://arxiv.org/pdf/1812.08008.pdf>

Dalal, N., and Triggs, B. (2005). "Histograms of Oriented Gradients for Human Detection". *IEEE Computer Society Conference on Computer Vision and Pattern Recognition (CVPR'05)*, Vol. 1, pp. 886-893.

Day, W. H., and Edelsbrunner, H. (1984). "Efficient Algorithms for Agglomerative Hierarchical Clustering Methods". *Journal of Classification*, Vol. 1(1), pp. 7-24.

Freeman, W. T., and Roth, M. (1995). "Orientation Histograms for Hand Gesture Recognition". *International Workshop on Automatic Face and Gesture Recognition*, Vol. 12, pp. 296-301.

Gundogdu B. (2019). "Semaphore Flag Signalling Dataset". *Mendeley Data*, V1, doi:10.17632/tc5tnchrs2.1.

Hsieh, S. W., and Shih, Y. (2015). "Using Bioloid Robots as Tangible Learning Companions for Enhancing Learning of a Semaphore Flag-signaling System". *The Asian Conference on Education International Development Official Conference Proceedings*.

Hung, I. C., Hsu, H. H., and Chen, N. S. (2015). "Communicating through Body: A Situated Embodiment-based Strategy with Flag Semaphore for Procedural Knowledge Construction". *Educational Technology Research and Development*, Vol. 63(5), pp. 749-769.

Ikizler, N., and Duygulu, P. (2009). "Histogram of Oriented Rectangles: A New Pose Descriptor for Human Action Recognition". *Image and Vision Computing*, Vol. 27(10), pp. 1515-1526.

Iwane, N. (2012). "Arm Movement Recognition for Flag Signaling with Kinect Sensor". *IEEE International Conference on Virtual Environments Human-Computer Interfaces and Measurement Systems (VECIMS)*, pp. 86-90.

Kara, Y. A., Uçarer, Ö. K., and Gündoğdu, B. (2019). "Automatic Warship Recognition System: Dataset, Feature Representation and Classification Analysis". *27th Signal Processing and Communications Applications Conference (SIU)*, pp. 1-4.

Lloyd, S. (1982). "Least Squares Quantization in PCM". *IEEE Transactions on Information Theory*, Vol. 28(2), pp. 129-137.

Motty, A., Yogitha, A., and Nandakumar, R. (2019). "Flag Semaphore Detection Using Tensorflow and Opencv". *International Journal of Recent Technology and Engineering*, Vol. 7(6).

Müllner, D. (2011). "Modern Hierarchical, Agglomerative Clustering Algorithms". *arXiv preprint*. arXiv:1109.2378.

Pratt, William K. (2013). *Introduction to Digital Image Processing*. CRC Press.

Rachmad, A., and Fuad, M. (2015). "Geometry Algorithm on Skeleton Image based Semaphore Gesture Recognition". *Journal of Theoretical and Applied Information Technology*, Vol. 81(1), pp. 102.

Rao, C. K., Prasada, B., and Sarma, K. R. (1976). "A Parallel Shrinking Algorithm for Binary Patterns". *Computer Graphics and Image Processing*, Vol. 5(2), pp. 265-270.

Suykens, J. A., and Vandewalle, J. (1999). "Least Squares Support Vector Machine Classifiers". *Neural Processing Letters*, Vol 9(3), pp. 293-300.

*Clustering Based Feature Extraction Methods for Semaphore Flag Recognition*

Temlioglu, E., Erer, I., and Kumlu, D. (2017). "Histograms of Dominant Orientations for Anti-personnel Landmine Detection Using Ground Penetrating Radar". *4th International Conference on Electrical and Electronic Engineering (ICEEE)*, pp. 329-332.

Tian, N., Kuo, B., Ren, X., Yu, M., Zhang, R., Huang, B., and Sojoudi, S. (2018). "A Cloud-based Robust Semaphore Mirroring System for Social Robots". *IEEE 14th International Conference on Automation Science and Engineering (CASE)*, pp. 1351-1358.

Wikimedia Commons (n.d.). "Semaphore Signals A-Z". Retrieved from [https://commons.wikimedia.org/wiki/File:Semaphore\\_Signals\\_A-Z.jpg](https://commons.wikimedia.org/wiki/File:Semaphore_Signals_A-Z.jpg)

Zhao, Q., Li, Y., Yang, N., Yang, Y., and Zhu, M. (2016). "A Convolutional Neural Network Approach for Semaphore Flag Signaling Recognition". *IEEE International Conference on Signal and Image Processing (ICSIP)*, pp. 466-470.

Zhu, Q., Yeh, M. C., Cheng, K. T., and Avidan, S. (2006). "Fast Human Detection Using a Cascade of Histograms of Oriented Gradients". *IEEE Computer Society Conference on Computer Vision and Pattern Recognition (CVPR'06)*, Vol. 2, pp. 1491-1498.





## JOURNAL OF NAVAL SCIENCES AND ENGINEERING (JNSE) PUBLISHING RULES

**Submission of Papers:** Manuscripts which are submitted to the journal should not be published elsewhere or sent to be published. Authors are (preferably) requested to submit an electronic copy of their original works to the given "System Address" or one hard copy to the address and a soft-copy to the "E-mail Address" which have been given below. It is necessary for the authors to submit their manuscripts together with the "Copyright Release Form". "Copyright Release Form" can be downloaded from the "Copyright Page" of JNSE's Web Page. Authors are requested to obtain the relevant documents for their studies that require "Ethics Committee Approval and/or Legal/Special Permission" and submit these approval documents to the system together with their study.

**System Address:**

<https://dergipark.org.tr/tr/pub/jnse>

**Address:**

Doç.Dr. Ertan YAKICI  
Milli Savunma Üniversitesi  
Barbaros Deniz Bilimleri ve Mühendisliği Enstitüsü  
Deniz Harp Okulu Yerleşkesi  
34942 Tuzla/İstanbul/Türkiye

**E-mail:** [jnse@dho.edu.tr](mailto:jnse@dho.edu.tr)

**Types of Contributions:** The journal publishes original papers, review articles, technical notes, book reviews, letters to the editor, extended reports of conferences and meetings.

**Manuscript Evaluation Process:** The Peer Review Step:

- The content and layout format of manuscript are examined and the originality of study is checked by iThenticate Software Programme.
- The language and correlation of the English abstract with Turkish abstract are checked.
- Manuscript which has a similarity index above 40% is rejected. The author is informed about the manuscript which has a similarity index between 20% and 40% (must not contain more than 4% from a single source), which is not appropriate for the writing rules of JNSE or needs correction in English and Turkish abstracts and the author is requested to revise the manuscript within "two weeks". Otherwise, the article is considered as a retracted manuscript.

Our journal uses **double-blind** review, which means that both the reviewer and author identities are concealed from the reviewers, and vice versa, throughout the review process. So, the uploaded manuscript does not contain the name, address and affiliation of author(s). The manuscript evaluation steps are as follows:

- Editor is assigned by the Editor-in-Chief.
- The relevant reviewers are assigned by the Editors.
- As a result of the reviewer's evaluation, the manuscript may be rejected, accepted or a correction for the manuscript may be requested.
- If the negative feedback is given by major number of the reviewers the process is terminated and the article is rejected.
- If major/minor revisions are required for the manuscript, the author has to do this revision according to the reviewers' comments in "three weeks".
- If the revision is accepted by the reviewers, the article is accepted.

The Workflow Diagram for the evaluation process can be accessed from the web page of the journal.

The articles submitted to JNSE to be published are free of article submission, processing and publication charges.

The accepted articles are published **free-of-charge** as online from the journal website and printed.

## DENİZ BİLİMLERİ VE MÜHENDİSLİĞİ DERGİSİ (DBMD) YAYIN KURALLARI

**Yazıların Gönderilmesi:** Dergiye gönderilen makaleler başka bir yerde yayımlanmamış ya da yayımlanmak üzere gönderilmemiş olmalıdır. Yayımlanması istenilen yazılar (tercihen) aşağıda verilen “Sistem Adresi”nden yüklenmeli veya aşağıdaki adrese bir kopya kâğıda basılı olarak ve aynı zamanda “E-mail Adresi”ne dijital olarak gönderilmelidir. Dergimize makale gönderen yazarların makaleleriyle birlikte “Yayın Hakkı Devir Formu”nu da göndermeleri gerekmektedir. “Yayın Hakkı Devir Formu”na DBMD Web Sayfasındaki “Telif Hakkı” sayfasından erişilebilmektedir. Yazarların "Etik Kurul İzni ve/veya Yasal/Özel İzin" gerektiren çalışmaları için ilgili izin belgelerini temin etmesi ve bu izin belgelerini çalışmalarıyla birlikte sisteme yüklemeleri gerekmektedir.

**Sistem Adresi:**

<https://dergipark.org.tr/tr/pub/jnse>

**Adres:**

Doç.Dr. Ertan YAKICI  
Barbaros Deniz Bilimleri ve Mühendisliği Enstitüsü  
Deniz Harp Okulu Yerleşkesi  
34942 Tuzla/ İstanbul/Türkiye

**E-mail:** [jnse@dho.edu.tr](mailto:jnse@dho.edu.tr)

**Yazı Türleri:** Dergide; orijinal yazılar, derlemeler, teknik notlar, kitap incelemeleri, editöre mektuplar ile konferans ve toplantıların genişletilmiş raporları yayımlanır.

**Yazıların Değerlendirilme Süreci:** Makalenin Ön Kontrol Süreci:

- Makalenin içeriği ve yazım formatı incelenir ve iThenticate Programı ile benzerlik taraması yapılır.
- Makalenin İngilizce özetinin, Türkçe öz ile uygunluğu ve yazım dili kontrol edilir.
- Benzerlik oranı %40’ın üzerinde olan makale reddedilir. Benzerlik oranı %20 ile %40 arasında olan (tek bir kaynakla benzerlik %5’ten fazla olmamalıdır), yazım formatına uymayan ya da İngilizce ve Türkçe özetinde düzeltme gereken makale yazara bildirilir ve “iki hafta” içerisinde makalenin düzeltilmesi istenir. Aksi takdirde makale geri çekilmiş kabul edilir.

Dergimiz, makale değerlendirme sürecinde **çift-kör** hakemlik sistemini kullanmaktadır. Buna göre değerlendirme sürecinde hakem ve yazarlar birbirlerinin bilgilerini görememektedir. Bu nedenle, yüklenen ön yükleme formatında yazar(lar)ın isim, adres ve bağlı olduğu kuruluş(lar) yer almamaktadır. Makale değerlendirme sürecindeki adımlar ise aşağıdaki gibidir;

- Baş editör tarafından makaleye Editör atanır.
- Editörler makale için hakemleri atar.
- Hakem değerlendirmesi sonucunda makale reddedilebilir, kabul edilebilir veya makalenin düzeltilmesi istenebilir.
- Hakem görüşlerinin çoğunluğu doğrultusunda makale reddedilmiş ise süreç sonlandırılır ve makale reddedilir.
- Makale için majör / minör düzeltme istenirse hakem görüşleri doğrultusunda yazarın gerekli düzeltmeleri en geç “üç hafta” içerisinde yapması istenir.
- Revize edilmiş makale kabul alırsa düzenleme aşamasına geçilir.

Değerlendirme sürecine ilişkin Akış Şemasına, derginin web sayfasından erişilebilir.

DBMD’ye yayımlanmak üzere gönderilen makaleler; makale gönderim, işlem ve yayın ücretinden muafır.

Kabul edilen makaleler, **ücretsiz** olarak basılı şekilde ve dergi web sayfasından çevrimiçi (online) olarak yayımlanmaktadır.

## **JOURNAL OF NAVAL SCIENCES AND ENGINEERING (JNSE) WRITING RULES**

**General:** Manuscripts must be prepared in MS Word, single-spaced with justify. Font: Times New Roman, 12 points. Margins: left 4,5 cm- right 3,5 cm, top 5 cm- bottom 7 cm, header 3,25 cm- footer 6 cm, gutter 0. Paper type: A4. Page numbers should be on the middle of bottom of page with -1-, -2-, -3- etc. format. Using footnotes is not allowed.

**Ethics Committee Approval and/or Legal/Special Permission:** The articles must state whether an ethical committee approval and/or legal/special permission is required or not. If these approvals are required, then it should be clearly presented from which institution, on what date and with which decision or number these approvals are obtained.

**Body of Text:** Follow this order when typing manuscripts: Title, Authors, Abstract, Keywords, Title (Turkish), Abstract (Turkish), Keywords (Turkish), Main Text, Appendix (if any), References.

**Title:** Title should reflect objectives of the paper clearly, be easily understandable and not exceed 15 words.

**Abstracts:** Each paper should have an abstract with 100-200 words and have a structured form, i.e. standard structure of an article (background, purpose, material and methods used, results, conclusion).

**Paper Length:** The manuscript should be minimum 2000 words or 5 pages, maximum 7000 words or 25 pages including references.

**Keywords:** Author must provide some keywords (between 3 and 5) that will be used to classify the paper.

**Unit:** International System of Unit (Système Internationale d'Unités; SI) (<https://www.britannica.com/science/International-System-of-Units>) should be used for all scientific and laboratory data.

**References:** References should be given according to the APA standard as effective from November, 2020 issue.

**Abbreviations and Acronyms:** Standard abbreviations and acronyms should be used for each related discipline. Acronyms should be identified at the first occurrence in the text. Abbreviations and acronyms may also be attached to main text as an appendix.

**Equations and Formulas:** Equations and formulas should be numbered consecutively. These numbers must be shown within parentheses being aligned to the right. In the text, equations and formulas should be referred with their numbers given in parentheses. Comprehensive formulas, not appropriate to be written in the texts, should be prepared in figures.

**Figures and Tables:** Figures and tables should be numbered consecutively. In the text referring to figures and tables should be made by typing "Figure 1." or "Table 1." etc. A suitable title should be assigned to each of them.

## DENİZ BİLİMLERİ VE MÜHENDİSLİĞİ DERGİSİ (DBMD) YAZIM KURALLARI

**Genel Bilgiler:** Yazılar; Microsoft Word'de tek satır aralığı ve iki yana yaslanarak hazırlanmalıdır. Yazı tipi: Times New Roman, 12 punto. Kenar boşlukları: sol 4,5 cm- sağ 3,5 cm- üst 5 cm- alt 7 cm- üst bilgi 3,25 cm- alt bilgi 6 cm, oluk 0. Kâğıt ölçüsü: A4. Sayfa numaraları sayfanın alt ortasında -1-, -2-, -3- vb. şeklinde yer almalıdır. Dipnot kullanılmamalıdır.

**Etik Kurul İzni ve/veya Yasal/Özel İzin:** Makalelerde etik kurul izni ve/veya yasal/özel izin alınmasının gerekip gerekmediği belirtilmiş olmalıdır. Eğer bu izinlerin alınması gerekli ise, izinlerin hangi kurumdan, hangi tarihte ve hangi karar veya sayı numarası ile alındığı açıkça sunulmalıdır.

**Yazı Yapısı:** Yazı şu sırada hazırlanmalıdır: Başlık, Yazarlar, Özet, Anahtar Kelimeler, Başlık (Türkçe), Özet (Türkçe), Anahtar Kelimeler (Türkçe), Ana Metin, Ek (varsa), Referanslar.

**Başlık:** Başlık; açık, net, anlaşılır olmalı ve 15 kelimeyi geçmemelidir.

**Öz (Abstract):** Yazı, 100-200 kelimelik, arka plan, amaç, yöntem, bulgular ve sonuçtan oluşan yapılandırılmış bir özeti içermelidir.

**Sayfa Sayısı:** Dergiye gönderilecek yazıların boyutu, kaynakça dâhil asgari 2000 kelime veya 5 sayfa, azami 7000 kelime veya 25 sayfa arasında olmalıdır.

**Anahtar Kelimeler:** Yazıyı sınıflandırmaya yarayacak, anahtar görevi yapan 3-5 kelime yer almalıdır.

**Birimler:** Yazının uluslararası alanlarda da kolay izlenebilir ve anlaşılabilir olması için Uluslararası Birim Sistemine (<https://www.britannica.com/science/International-System-of-Units>) uygun olarak hazırlanması gerekir.

**Referans:** Referanslar Kasım, 2020 sayısından itibaren geçerli olmak üzere APA standardına göre verilmelidir.

**Notasyon ve Kısaltmalar:** İlgili bilim alanının standart notasyon ve kısaltmaları kullanılmalı, yeni notasyonlar ise metin içinde ilk geçtiği yerde tanımlanmalıdır. Gerekli durumlarda, notasyon ve kısaltmalar ek olarak konulabilir.

**Denklem ve Formüller:** Denklem ve formüller ardışık olarak numaralandırılmalı ve bu numaralar sağa dayalı parantez içinde yazılmalıdır. Metin içinde denklem ve formüllere parantez içinde yazılan numaraları ile atıfta bulunulmalıdır. Metin arasında verilmesi uygun olmayan kapsamlı formüller şekil olarak hazırlanmalıdır.

**Şekiller ve Tablolar:** Şekiller ve tablolar, ardışık olarak numaralandırılmalıdır. Bunlara metin içinde "Şekil 1." veya "Tablo 1." şeklinde atıfta bulunulmalıdır. Her bir şekil ve tablo için uygun bir başlık kullanılmalıdır.

## **Ethical Principles and Publication Policy**

Journal of Naval Sciences and Engineering (hereafter JNSE) is a peer reviewed, international, inter-disciplinary journal in science and technology, which is published semi-annually in November and April since 2003. JNSE is committed to provide a platform where highest standards of publication ethics are the key aspect of the editorial and peer-review processes.

The editorial process for a manuscript to the JNSE consists of a double-blind review, which means that both the reviewer and author identities are concealed from the reviewers, and vice versa, throughout the review process. If the manuscript is accepted in the review stage of the Editorial Process then, the submission goes through the editing stage, which consists of the processes of copyediting, language control, reference control, layout and proofreading. Reviewed articles are treated confidentially in JNSE.

Papers submitted to JNSE are screened for plagiarism with the iThenticate plagiarism detection tool. In case that the editors become aware of alleged or proven scientific misconduct, they can take the necessary steps. The editors have the right to retract an article whether submitted to JNSE or published in JNSE.

Following the completion of the editing stage, the manuscript is then scheduled for publication in an issue of the JNSE. The articles which are submitted to JNSE to be published are free of article submission, processing and publication charges. The accepted articles are published free-of-charge as online from the journal website and printed. The articles that are accepted to appear in the journal are made freely available to the public via the journal's website. The journal is also being printed by National Defence University Turkish Naval Academy Press on demand. The printed version can be accessed free of charge from the libraries of the Turkish Universities.

JNSE has editors and an editorial board which consists of academic members from at least five different universities. JNSE has an open access policy which means that all contents are freely available without charge to the user or his/her institution. Users are allowed to read, download, copy, distribute, print, search, or link to the full texts of the articles, or use them for any other lawful research purposes.

Publication ethics of the JNSE are mainly based on the guidelines and recommendations which are published by the Committee on Publication Ethics (COPE), World Federation of Engineering Organizations (WFEO), Council of Science Editors (CSE) and Elsevier's Publishing Ethics for Editors statements.

The duties and responsibilities of all parties in the publishing process including editors, authors and others are defined below.

### **The Responsibilities of the Authors:**

- Authors are responsible for the scientific, contextual, and linguistic aspects of the articles which are published in the journal. The views expressed or implied in this publication, unless otherwise noted, should not be interpreted as official positions of the Institution.
- Authors should follow the "Author Guidelines" in JNSE's web page on DergiPark.
- Authors should conduct their researches in an ethical and responsible manner and follow all relevant legislation.
- Authors should take collective responsibility for their work and for the content of their publications.
- Authors should check their publications carefully at all stages to ensure that methods and findings are reported accurately.
- Authors must represent the work of others accurately in citations, quotations and references.
- Authors should carefully check calculations, data presentations, typescripts/submissions and proofs.
- Authors should present their conclusions and results honestly and without fabrication, falsification or inappropriate data manipulation. Research images should not be modified in a misleading way.
- Authors should describe their methods to present their findings clearly and unambiguously.
- Authors accept that the publisher of JNSE holds and retains the copyright of the published articles.
- Authors are responsible to obtain permission to include images, figures, etc. to appear in the article.

- In multi-authored publications -unless otherwise stated- author rankings are made according to their contributions.
- Authors should alert the editor promptly if they discover an error in any submitted.
- Authors should follow the publication requirements regarding that the submitted work is original and has not been published elsewhere in any language.
- Authors should work with the editor or publisher to correct their work promptly if errors are discovered after publication.
- If the work involves chemicals, procedures or equipment that have any unusual hazards inherent in their use, the authors must clearly identify these in the manuscript.
- If the work involves the use of animals or human participants, the authors should ensure that all procedures were performed in compliance with relevant laws and institutional guidelines and that the appropriate institutional committee(s) has approved them; the manuscript should contain a statement to this effect.
- Authors should also include a statement in the manuscript that informed consent was obtained for experimentation with human participants. Because the privacy rights of human participants must always be preserved. It is important that authors have an explicit statement explaining that informed consent has been obtained from human participants and the participants' rights have been observed.
- Authors have the responsibility of responding to the reviewers' comments promptly and cooperatively, in a point-by-point manner.

#### **The Responsibilities of the Reviewers:**

- Peer review process has two fundamental purposes as follow: The first purpose is to decide whether the relevant article can be published in JNSE or not and the second purpose is to contribute to the improvement of the weaknesses of the related article before the publication.
- The peer review process for an article to the JNSE consists of a double-blind review, which means that both the reviewer and author identities are concealed from the reviewers, and vice versa, throughout the review process. Reviewed articles are treated confidentially in JNSE.
- Reviewers must respect the confidentiality of peer review process.
- Reviewers must refrain from using the knowledge that they have obtained during the peer review process for their own or others' interests.
- Reviewers should definitely be in contact with the JNSE if they suspect about the identity of the author(s) during the review process and if they think that this knowledge may raise potential competition or conflict of interest.
- Reviewers should notify the JNSE in case of any suspicion regarding the potential competition or conflict of interest during the review process.
- Reviewers should accept to review the studies in which they have the required expertise to conduct an appropriate appraisal, they can comply with the confidentiality of the double-blind review system and that they can keep the details about the peer review process in confidential.
- Reviewers should be in contact with the JNSE in order to demand some missing documents, following the examination of the article, supplementary files and ancillary materials.
- Reviewers should act with the awareness that they are the most basic determinants of the academic quality of the articles to be published in the journal and they should review the article with the responsibility to increase academic quality.
- Reviewers should be in contact with the JNSE editors if they detect any irregularities with respect to the Ethical Principles and Publication Policy.
- Reviewers should review the articles within the time that has been allowed. If they can not review the article within a reasonable time-frame, then they should notify the journal as soon as possible.
- Reviewers should report their opinions and suggestions in terms of acceptance / revision / rejection for the manuscript in the peer review process through the Referee Review Form which is provided by JNSE.
- In case of rejection, reviewers should demonstrate the deficient and defective issues about the manuscript in a clear and concrete manner in the provided Referee Review Form.
- Review reports should be prepared and submitted in accordance with the format and content of the Referee Review Form which is provided by JNSE.
- Review reports should be fair, objective, original and prudent manner.
- Review reports should contain constructive criticism and suggestions about the relevant article.

**The Responsibilities of the Editors:**

-Editors are responsible of enhancing the quality of the journal and supporting the authors in their effort to produce high quality research. Under no conditions do they allow plagiarism or scientific misconduct.

-Editors ensure that all submissions go through a double-blind review and other editorial procedures. All submissions are subject to a double-blind peer-review process and an editorial decision based on objective judgment.

-Each submission is assessed by the editor for suitability in the JNSE and then, sent to the at least two expert reviewers.

-Editors are responsible for seeking reviewers who do not have conflict of interest with the authors. A double-blind review assists the editor in making editorial decisions.

-Editors ensure that all the submitted studies have passed initial screening, plagiarism check, review and editing. In case the editors become aware of alleged or proven scientific misconduct, they can take the necessary steps. The editors have the right to retract an article. The editors are willing to publish errata, retractions or apologies when needed.





## Etik İlkeler ve Yayın Politikası

Deniz Bilimleri ve Mühendisliği Dergisi (Bundan sonra DBMD olarak anılacaktır.); uluslararası düzeyde, hakemli, çok disiplinli, Nisan ve Kasım aylarında olmak üzere 2003 yılından bu yana yılda iki kez yayınlanan, bilim ve teknoloji dergisidir. DBMD yayın etiğinde en yüksek standartların, editöryal ve hakemlik süreçlerinin kilit unsuru olarak değerlendirildiği bir platform sunmayı taahhüt etmektedir.

DBMD'ne gönderilen her bir makale için değerlendirme sürecinde çift-kör hakemlik sistemi uygulanmaktadır. Buna göre, değerlendirme süreci boyunca hakem ve yazarlar birbirlerinin bilgilerini görememektedir. Dergiye gönderilen çalışmaların yazar-hakem ve hakem-yazar açısından süreçlerinde gizlilik esastır. DBMD'ne gönderilen makalelerin değerlendirme sürecindeki inceleme aşamasında kabul edilmeleri halinde, ilgili makaleler için düzenleme aşamasına geçilmektedir. Düzenleme aşamasında, ilgili makaleler yazım formatı ve dilbilgisel yönlerden incelenir. Makalelerin sayfalar üzerindeki biçimi ve yerleşimleri kontrol edilip düzenlenir. Ayrıca referans kontrolü yapılır. DBMD'nde kontrol edilen ve düzenlenen makaleler gizli tutulmaktadır.

DBMD'ne gönderilen makaleler, iThenticate intihal tespit programı aracılığıyla bilimsel çalıntı konusunda kontrol edilir. Editörler, iddia edilen veya kanıtlanmış bir bilimsel kötü kullanımdan ya da usulsüzlükten haberdar olurlarsa bu konuda gerekli adımları atabilirler. Bu anlamda, Editörler gerekli durumlarda DBMD'ne gönderilen ya da DBMD'nde yayınlanmış makaleleri geri çekme hakkına sahiptir.

Düzenleme aşamasının başarılı olarak sonuçlanmasını takiben, ilgili makaleler DBMD'nin bir sayısında yayınlanmak üzere saklı tutulur ve kayıt altına alınır. DBMD'ne yayınlanmak üzere gönderilen makaleler; yazılı materyal gönderme, işleme ve yayınlama süreçlerindeki tüm ücretlerden muaf tutulmaktadır. DBMD'nde yayınlanmak üzere kabul edilen makaleler, derginin internet sitesinden çevrimiçi olarak ücretsiz bir şekilde yayınlanır ve basılır. Dergide yayınlanması kabul edilen çalışmalar, derginin web sitesinden açık erişim ile erişilebilir kılınmıştır. Dergi ayrıca, Milli Savunma Üniversitesi, Deniz Harp Okulu Basımevi tarafından basılmaktadır. Derginin basılı haline Üniversite kütüphanelerinden erişilebilmektedir.

DBMD; editörü ve en az beş değişik üniversitenin öğretim üyelerinden oluşmuş danışman grubu ile açık erişim politikasını benimsemektedir. Buna göre, tüm içerikler ücretsiz olarak kullanıcılar veya kurumlar için ulaşılabilir. Kullanıcıların DBMD bünyesindeki makalelerin tam metinlerini okuma, indirme, kopyalama, dağıtma, yazdırma, arama veya bunlara bağlantı verme ve diğer yasal araştırma amaçları için kullanma hakları saklı tutulmaktadır.

DBMD'nin yayın etiği, temel olarak Yayın Etiği Komitesi (COPE), Dünya Mühendislik Kuruluşları Federasyonu (WFEO), Bilim Kurulu Editörleri (CSE) ve Elsevier'in Editörler için Yayın Etiği açıklamaları kapsamında yayınlanmış yönergelere ve önerilere dayanmaktadır.

Editörler, yazarlar ve diğer taraflar da dâhil edilebilecek şekilde yayın sürecindeki görev ve sorumluluklar aşağıdaki gibi tanımlanmıştır.

### Yazarların Sorumlulukları:

-Yazarlar, dergide yayınlanan makalelerinin bilimsel, bağlamsal ve dilsel yönlerinden sorumlu tutulmaktadır. Dergide ifade edilen veya ima edilen görüşler, aksi belirtilmediği sürece, Enstitünün resmi görüşü olarak yorumlanamaz ve yansıtılamaz.

-Yazarlar çalışmalarında, DBMD'nin DergiPark internet sayfasında yer alan "Yazım Kuralları"na dikkate almalıdır.

-Yazarlar araştırmalarını etik ve sorumlu bir şekilde yürütmeli ve ilgili tüm mevzuatları takip etmelidir.

-Yazarlar çalışmalarını ve yayınlarının içeriği için ortak sorumluluk almalıdır.

-Yazarlar, yöntemlerin ve bulguların doğru bir şekilde raporlandığından emin olmak için yayınlarını her aşamada dikkatlice kontrol etmelidir.

-Yazarlar, başkalarına ait çalışmalarını dolaylı alıntı, doğrudan alıntı ve referanslar ile doğru bir şekilde göstermelidir. Yazarlar, makalelerindeki fikirlerin şekillendirilmesinde etkili ya da bilgilendirici olmuş her türlü kaynağa referans vermelidir.

-Yazarlar çalışmalarındaki hesaplamaları, ispatları, veri sunumlarını ve yazı tiplerini dikkatlice kontrol etmelidir.

- Yazarlar çalışmalarının sonuçlarını dürüstçe; uydurma, çarpıtma, tahrifat veya uygunsuz manipülasyona yer vermeden sunmalıdır. Çalışmalardaki görsel kaynaklar yanıltıcı bir şekilde değiştirilmemelidir.
- Yazarlar, çalışmalarındaki bulguları açık ve net bir şekilde sunmak için araştırma yöntemlerini tanımlamalı ve paylaşmalıdır.
- Yazarlar, yayınlanmış makalelerinin telif haklarını DBMD yayıncısına devrettiklerini kabul etmektedir.
- Yazarlar çalışmalarına çeşitli görsel kaynakları, figürleri, şekilleri vb. dahil etmek için gerekli izinleri almakla yükümlüdür. İlgili çalışmada yer alması gereken resim, şekil vb. anlatımı destekleyici materyaller için gerekli kişilerden ya da kurumlardan izin alınması yazarın sorumluluğundadır.
- Çok yazarlı yayınlarda -aksi belirtilmedikçe- yazar sıralamaları sunulan katkılara göre yapılmalıdır.
- Yazarlar gönderdikleri çalışmada herhangi bir hata tespit ederlerse bu konuda derhal editörü uyarmalıdır.
- Yazarlar dergiye gönderdikleri makalelerin başka bir yerde yayımlanmamış ya da yayımlanmak üzere gönderilmemiş olmaları ile ilgili DBMD'nin DergiPark internet sayfasında yer alan "Yayın Kuralları"na dikkate alınmalıdır.
- Yazarlar, ilgili çalışmaları DBMD'nde yayınlandıktan sonra hata tespit ederlerse bu konuda gerekli düzeltmelerin yapılabilmesi amacıyla derhal editör veya yayıncı ile iletişime geçip onlar ile birlikte çalışmalıdır.
- İlgili çalışmada, doğası gereği kullanımlarında olağandışı tehlikeler barındıran çeşitli kimyasallar veya ekipmanlardan yararlanılmış ise yazarların tüm bunları çalışmasında açıkça belirtmesi ve tanımlaması gerekmektedir.
- İnsanlar ve hayvanların katılımını gerektiren çalışmalar için, yazarlar tüm sürecin ilgili yasalara ve kurumsal yönergelere uygun olarak gerçekleştirildiğinden emin olmalıdır ve ilgili komitelerden etik onay alındığını çalışmalarında açık bir şekilde ifade edip belgelendirmelidir.
- İnsanların katılımını gerektiren çalışmalar için, yazarlar kurumsal etik kurul onayı almakla yükümlüdürler. Yazarlar, katılımcıların süreç ile ilgili olarak bilgilendirildiklerini ve bu anlamda, katılımcılardan gerekli izinlerin alındığını bildirmek ve belgelemek zorundadır. Yazarlar, katılımcıların haklarının gözetildiğini açıklayan açık bir bildirim sunmalıdır. Ayrıca bu süreçte, katılımcıların gizlilik hakları her zaman korunmalıdır.
- Yazarlar, hakemlerin değerlendirmelerini, yorumlarını ve eleştirilerini zamanında ve işbirliği içerisinde dikkate alınmalıdır ve bu konuda, gerekli güncellemeleri yapmalıdır.

#### **Hakemlerin Sorumlulukları:**

- Hakem değerlendirme sürecinin iki temel amacı vardır: İlk amaç, ilgili makalenin DBMD'nde yayınlanıp yayınlanamayacağına karar vermektir ve ikinci amaç, yayından önce ilgili makalenin eksik yönlerinin geliştirilmesine katkıda bulunmaktır.
- DBMD'ne gönderilen her bir makale için değerlendirme sürecinde çift-kör hakemlik sistemi uygulanmaktadır. Buna göre, değerlendirme süreci boyunca hakem ve yazarlar birbirlerinin bilgilerini görememektedir. Dergiye gönderilen çalışmaların yazar-hakem ve hakem-yazar açısından süreçlerinde gizlilik esastır.
- Hakemler, değerlendirme sürecinin gizliliğine saygı göstermelidir.
- Hakemler, değerlendirme sürecinde elde ettikleri bilgileri kendilerinin veya başkalarının çıkarları için kullanmaktan kaçınmalıdır.
- Hakemler, değerlendirme sürecinde yazar(lar)ın kimliğinden şüphe etmeleri ve bu bilginin herhangi bir potansiyel rekabet veya çıkar çatışması yaratacağını düşünmeleri halinde mutlaka DBMD ile iletişime geçmelidir.
- Hakemler, değerlendirme sürecinde şüphe ettikleri potansiyel rekabet veya çıkar çatışması durumlarını DBMD'ne bildirmelidir.
- Hakemler, uygun bir değerlendirme yapabilmek için gereken uzmanlığa sahip oldukları, çift-kör hakemlik sisteminin gizliliğine riayet edebilecekleri ve değerlendirme süreci ile ilgili detayları gizli tutabilecekleri çalışmaların hakemliğini kabul etmelidir.
- Hakemler makaleyi, ek dosyaları ve yardımcı materyalleri incelemelerini takiben bazı eksik belgelere ihtiyaç duymaları halinde bunları talep etmek üzere DBMD ile iletişime geçmelidir.
- Hakemler dergide yayınlanacak makalelerin akademik kalitesinin en temel tespit edicisi olduklarının bilinciyle davranmalı ve akademik kaliteyi artırma sorumluluğuyla inceleme yapmalıdır.
- Hakemler, Etik İlkeler ve Yayın Politikası ile ilgili herhangi bir usulsüzlük tespit etmeleri halinde DBMD editörleri ile irtibata geçmelidir.

- Hakemler, kendilerine tanınan süre içerisinde makaleleri değerlendirmelidir. Şayet uygun bir zaman içerisinde değerlendirme yapamayacaklarsa, bu durumu en kısa zamanda DBMD'ne bildirmelidirler.
- Hakemler, değerlendirme sürecindeki çalışma için kabul etme / yeniden gözden geçirme / reddetme şeklindeki önerilerini DBMD tarafından sağlanan Hakem Değerlendirme Formu aracılığıyla bildirmelidir.
- Sonucu reddetme şeklinde olan değerlendirmeler için hakemler, ilgili çalışmaya dair eksik ve kusurlu hususları Hakem Değerlendirme Formu'nda açık ve somut bir şekilde ortaya koymalıdır.
- Hakem değerlendirme raporlarının, DBMD tarafından sağlanan Hakem Değerlendirme Formu'na uygun biçimde ve içerikte hazırlanması ve gönderilmesi gerekmektedir.
- Hakem değerlendirme raporları adil, objektif, özgün ve ölçülü olmalıdır.
- Hakem değerlendirme raporları, ilgili makale ile ilgili yapıcı eleştiriler ve tavsiyeler içermelidir.

#### **Editörlerin Sorumlulukları:**

- Editörler, derginin bilimsel kalitesini arttırmak ve yazarları bilimsel kalitesi yüksek araştırmalar üretmek için desteklemek ile sorumludur. Hiçbir koşulda, intihal ya da bilimsel kötüye kullanıma izin verilmemektedir.
- Editörler, dergiye gönderilen her çalışmanın çift-kör hakemlik sürecine ve diğer editöryal süreçlere tabi olmasını sağlamaktadır. DBMD'ne gönderilen her çalışma, çift-kör hakemlik sürecine ve nesnel değerlendirmeye dayalı editör kararına bağlı tutulmaktadır.
- DBMD'ne gönderilen her bir çalışma, uygunlukları açısından editör tarafından değerlendirilir ve daha sonrasında, incelenmesi ve değerlendirilmesi amacıyla en az iki uzman hakeme gönderilir.
- Editörler, yazarlar ile çıkar çatışması olmayan hakemleri, çalışmayı değerlendirmek üzere atamakla sorumludur. Çift-kör hakemlik süreci, editör için değerlendirme ve düzenleme aşamalarında katkı sağlamaktadır.
- Editörler, DBMD'ne gönderilen tüm çalışmaların ön kontrol, tarama, intihal kontrolü, değerlendirme ve düzenleme aşamalarından geçmesini sağlar. Editörler iddia edilen veya kanıtlanmış bilimsel kötü kullanımdan haberdar olurlarsa makaleyi geri çekebilirler. Editörler, gerekli durumlarda gönderilen çalışmayı düzeltme, geri çekme veya çalışma hakkında özür yayınlama hakkına sahiptir.

CONTENTS / İÇİNDEKİLER

*Mechanical Engineering / Makine Mühendisliği*

RESEARCH ARTICLE

**An Open Source Tool for Emission and Energy Analysis of a Generic Ship** 93-116  
(Açık Kaynak Kodlu Gemi Enerji Sistem ve Emisyon Analizi Aracı)  
*Salih Korhan ZORLU, Egemen SULUKAN*

*Industrial Engineering / Endüstri Mühendisliği*

REVIEW ARTICLE

**Survey on Military Operations of Fuzzy Set Theory and its Applications** 117-141  
(Bulanık Kümeler Teorisi ve Uygulamalarının Askeri Operasyonlar  
Üzerine Araştırmaları)  
*Muhammet DEVECİ, Yusuf KUVVETLİ, İbrahim Zeki AKYURT*

*Mechanical Engineering / Makine Mühendisliği*

RESEARCH ARTICLE

**Energy System Analysis and Modelling of an Electric Powered Ferry** 143-170  
(Elektrikle Çalışan bir Feribotun Enerji Sistem Analizi ve Modellenmesi)  
*Fatih YILMAZ, Egemen SULUKAN*

*Mechanical Engineering / Makine Mühendisliği*

RESEARCH ARTICLE

**Investigation of Mechanical Properties of Welding Electrodes Used for High Strength Low Alloy Steels** 171-192  
(Yüksek Mukavemetli Düşük Alaşımli Çelikler için Kullanılan Kaynak  
Elektrodlarının Mekanik Özelliklerinin İncelenmesi)  
*Zeynep TAŞLIÇUKUR ÖZTÜRK, Abdullah Koray PEHLİVAN*

*Naval Architecture and Marine Engineering / Gemi İnşaatı ve Gemi Makineleri Mühendisliği*

RESEARCH ARTICLE

**Generic Naval Vessel Waste Management Model Development in Ship-Life Cycle Assessment (SLCA) and Cost (SLCC)** 193-216  
(Jenerik Bir Savaş Gemisinde Gemi-Yaşam Döngüsü Değerlendirmesi (SLCA) ve Maliyet Modeli (SLCC) Geliştirilmesi)  
*Uğur Buğra ÇELEBİ*

*Electric-Electronic Engineering / Elektrik-Elektronik Mühendisliği*

RESEARCH ARTICLE

**Clustering Based Feature Extraction Methods for Semaphore Flag Recognition** 217-237  
(Simafor Bayrak Tanıma için Kümeleme Tabanlı Öznitelik Çıkarma Yöntemleri)  
*Batuhan GÜNDOĞDU, Deniz KUMLU*