

# JOURNAL OF **AVIATION**



**edit**  
PUBLISHING

VOLUME **7**  
ISSUE **2**  
JULY **2023**

[www.javsci.com](http://www.javsci.com)  
[dergipark.gov.tr/jav](http://dergipark.gov.tr/jav)  
e-ISSN 2587-1676

### Editor-in-Chief

Ph.D Vedat Veli Çay (Dicle University), Türkiye

### Associate Editors

Ph.D İnan Eryılmaz (Süleyman Demirel University), Türkiye  
Ph.D Vildan Durmaz (Eskişehir Technical University), Türkiye  
Ph.D Yasin Şöhret (Süleyman Demirel University), Türkiye  
Ph.D Fatih Koçyiğit (Dicle University), Türkiye  
Ph.D Gülaçtı Şen (Balıkesir University), Türkiye  
Ph.D Ömer Osman Dursun (Fırat University), Türkiye  
Ph.D Bahri Baran Koçak (Dicle University), Türkiye  
Ph.D Yusuf Er (Fırat University), Türkiye

### Language Editors

Ph.D Seçil Ulufer Kansoy, Department of Aviation Management in Lüleburgaz Faculty of Aeronautics and Astronautics (Kırklareli University) Türkiye  
Lecturer İbrahim Çapar, School of Foreign Languages (Dicle University), Türkiye

### EDITORIAL BOARD

#### **Mohd Razif Idris, Ph.D**

*Kuala Lumpur University, Malaysian*

#### **Simone Sarmiento, Ph.D**

*Federal Do Rio Grab De Unv. Brazil*

#### **Sukumar Senthilkumar, Ph.D**

*Chon Buk National University, South Korea*

#### **Nicolas Avdelidis, Ph.D**

*Universite Laval, Canada*

#### **Tarcisio Saurin, Ph.D**

*Federal do Rio Grande do Sul Unv. Brazil*

#### **Mary Johnson, Ph.D**

*Purdue University, United States*

#### **Özlem Atalık, Ph.D**

*Anadolu University, Türkiye*

#### **Faruk Aras, Ph.D**

*Kocaeli University, Türkiye*

#### **Sermin Ozan, Ph.D**

*Fırat University, Türkiye*

#### **Mustafa Sabri Gök, Ph.D**

*Bartın University, Türkiye*

#### **Ahmet Topuz, Ph.D**

*Yıldız Technical University, Türkiye*

#### **Mustafa Boz, Ph.D**

*Karabük University, Türkiye*

#### **Melih Cemal Kuşhan, Ph.D**

*Eskişehir Osmangazi University, Türkiye*

#### **Önder Altuntaş, Ph.D**

*Anadolu University, Türkiye*

#### **Ferhan Kuyucak Şengür, Ph.D**

*Anadolu University, Türkiye*

#### **Uğur Soy, Ph.D**

*Sakarya University, Türkiye*

#### **Matilde Scaramucci, Ph.D**

*Estadual Campinas Unviversity, SP, Brazil*

#### **Seçil Ulufer Kansoy, Ph.D**

*Kırklareli University, Türkiye*

#### **Ümit Deniz Göker, Ph.D**

*Astronomical Institute of Czech Academy of Sciences, Czech Republic*

#### **Kumar Shanmugam, Ph.D**

*Masdar Institute of Science & Technology, Abu Dhabi, UAE*

#### **Sonjoy Das, Ph.D**

*Buffalo University, United States*

**Fatih Koçyiğit, Ph.D**

*Dicle University, Türkiye*

**Kasım Kiracı, Ph.D**

*Iskenderun Technical University, Türkiye*

**Hüseyin Tamer Hava, Ph.D**

*Milli Savunma University, Türkiye*

**Haşim Kafalı, Ph.D**

*Muğla University, Türkiye*

**Mustafa Yeniad, Ph.D**

*Yıldırım Beyazıt University, Türkiye*

**Tolga Tüzün İnan, Ph.D**

*Gelişim University, Türkiye*

**Bahri Baran Koçak, Ph.D**

*Dicle University, Türkiye*

**Akansel Yalçinkaya, Ph.D**

*Medeniyet University, Türkiye*

**Cengiz Mesut Bükeç, Ph.D**

*Bahçeşehir University, Türkiye*

**Salvatore Brischetto, Ph.D**

*Polytechnic University of Turin, Italy*

**Hikmat Asadov, Ph.D**

*Azerbaijan National Aerospace Agency*

**Bilal Kılıç, Ph.D**

*Ozyegin University, Türkiye*

**Marco Linz, Ph.D**

*EBS University, Germany*

## JOURNAL INFORMATION

<b>Journal Name</b>	Journal of Aviation
<b>Abbreviation</b>	J. Aviat.
<b>Subjects</b>	Aviation, Aircraft, Aerospace
<b>e-ISSN</b>	2587-1676
<b>Publisher</b>	Edit Publishing; Edit Teknoloji ARGE San. Tic.Ltd. Şti. Diyarbakır, Türkiye
<b>Owner</b>	Vedat Veli Cay
<b>Language</b>	English
<b>Frequency</b>	Tri-annual (March, July, November)
<b>Type of Publication</b>	International, Scientific, Open Access, Double blinded peer review, Widely distributed periodical
<b>Manuscript Submission and Tracking System</b>	JAV uses the submission system of TUBITAK ULAKBİM JournalPark Open Journal Systems - <a href="http://dergipark.gov.tr/jav">http://dergipark.gov.tr/jav</a>
<b>Licence</b>	Journal is licensed under a Creative Commons Attribution 4.0 International License
<b>Legal Responsibility</b>	Authors are responsible for content of articles that were published in Journal
<b>Indexed and Abstracted in</b>	TÜBİTAK ULAKBİM TR Dizin, Crossref, Directory of Open Access Journal (DOAJ), AGORA, AGRIS (Agricultural Science and Technology Information), WorldCat, Google Scholar, SOBIAD, Scilit, ROAD (Directory of Open Access Scholarly Resources), Neliti, International Citation Index, ROOT Indexing, ResearchBib, Index Copernicus International, ESJI, JournalTOCs, TEELS, ResearchGate, Microsoft Academic
<b>Address</b>	Edit Teknoloji Arge Sanayi ve Ticaret Limited Şirketi Dicle Teknokent Dicle Üniversitesi Kampüsü Yiğit Çavuş Mah. Silvan Yolu Üzeri Kat:2 No:26, Diyarbakır, Türkiye
<b>Contact</b>	Ph.D Vedat Veli Cay Phone: +90 532 567 95 97 E-Mail: <a href="mailto:journalofaviation@gmail.com">journalofaviation@gmail.com</a> - <a href="mailto:info@editteknoloji.com">info@editteknoloji.com</a> Web: <a href="http://www.javsci.com">www.javsci.com</a> - <a href="http://dergipark.gov.tr/jav">dergipark.gov.tr/jav</a>



## AIM AND SCOPE

Journal of Aviation (JAV) established in 2017. It is a peer-reviewed international journal to be of interest and use to all those concerned with research in various fields of, or closely related to, Aviation science. Journal of Aviation (JAV) aims to provide a highly readable and valuable addition to the literature which will serve as an indispensable reference tool for years to come. The coverage of the journal includes all new theoretical and experimental findings in the fields of Aviation Science or any closely related fields. The journal also encourages the submission of critical review articles covering advances in recent research of such fields as well as technical notes.

### The scopes include:

- Accounting
- Acoustics
- Aerospace communications
- Air cargo, logistics, and supply-chain management
- Air pollution
- Air traffic management and control
- Air transport policy, regulation, and law
- Airport planning and management
- Airworthiness, reliability, and safety
- Atmospheric flight mechanics
- Attitude dynamics
- Autonomous and unmanned air vehicles
- Big data and data mining
- Brand management
- Business management and strategy
- Combustion and fuels
- Complex systems
- Design and manufacturing
- Dynamics and control of large flexible space structures
- Economics and finance
- Electrical systems in air vehicles
- Electromagnetism and radar
- Environmental issues
- Flight mechanics
- Flight performance
- Fluid dynamics
- History of aviation
- Human and system interaction
- Human factors
- Information processing
- Innovation in aerospace and astronautical technology
- Maintenance, repair, and overhaul
- Management of route, terminal, airspace, and airport operations
- Maneuvering flight vehicles
- Marketing
- Materials and structures
- Navigation, guidance, and control
- Noise
- Novel and trend technologies in aerospace
- Numerical and computational methods
- Optics
- Orbit determination
- Organizational behavior and commitment
- Propulsion systems
- Robotics and intelligent systems
- Safety management system (SMS)
- Signal and image processing
- Space mission analysis
- Standards, procedures, training, and certification in aviation
- Sustainable technologies and development
- System design and development for air vehicles
- Test, instrumentation, and validation
- Trajectory optimization
- Vehicle conceptual design
- Weather and meteorology

Abstracting & Indexing

 <p><a href="#">ULAKBİM TR Dizin</a></p>	 <p><a href="#">Index Copernicus</a></p>	 <p><a href="#">CrossRef</a></p>	 <p><a href="#">ASOS Inde</a></p>
 <p><a href="#">Google Scholar</a></p>	 <p><a href="#">International Scientific Indexing</a></p>	 <p><a href="#">DRJI</a></p>	 <p><a href="#">Bielefeld Academic Search Engine BASE</a></p>
 <p><a href="#">Journal Factor</a></p>	 <p><a href="#">JIFACTOR</a></p>	 <p><a href="#">i2or</a></p>	 <p><a href="#">Rootindexing</a></p>
 <p><a href="#">Science Library Index</a></p>	 <p><a href="#">Academic Keys</a></p>	 <p><a href="#">Eurasian Scientific Journal Index</a></p>	 <p><a href="#">COSMOS.IF</a></p>
 <p><a href="#">Scientific Indexing Services</a></p>	 <p><a href="#">OpenAIRE EXPLORE</a></p>		

CONTENTS

-Research Article-

1.	On Stationarity of Variance Calculation Series <b>Ongun Yücesan</b>	161
2.	Production of Nanostructured Fasteners with High Shear and Fatigue Strength for Using in Aircraft Components <b>Kazım Buğra Gürbüz, Mustafa Taşkın</b>	165
3.	Design and Simulation of a Conformal Micro-Strip Patch Antenna at GNSS L1/ E1 Frequency Band <b>Betül Yılmaz</b>	171
4.	Virtual Training Applications in Aviation BITE Test Application <b>Yunus Sarıkaya, Hakan Aydoğan, Faruk Aras</b>	178
5.	Innovative Morphing UAV Design and Manufacture <b>Sezer Çoban, Tuğrul Oktay</b>	184
6.	Investigation of Dry Sliding Wear Behavior of CFRP Composite Used in New Generation Aircraft Wings <b>Mustafa Gök, Yılmaz Küçük, Murat Pehlivanlı and Azmi Erdoğan</b>	190
7.	Air-traffic Flow Prediction with Deep Learning: A Case Study for Diyarbakır Airport <b>Ömer Osman Dursun</b>	196
8.	Understanding the Sintering Behavior and its Effect on the Thermal Conductivity of YSZ Coatings for Gas Turbine Applications <b>Garip Erdoğan</b>	204
9.	Obtaining Condition Monitoring Data for the Prognostics of the Flight Time of Unmanned Aerial Vehicles <b>Melih Erşen, Mehmet Konar</b>	209
10.	A PESTEL Analysis of The Impacts of COVID-19 Crisis on Air Transportation Sector's Future <b>Adem Pınar</b>	215
11.	Determining and Evaluating The Strategies of Air Cargo Freight Forwarders to Increase Business Volume with AHP Method <b>Filiz Mızrak, Gonca Reyhan Akkartal</b>	226
12.	Stock Price Prediction with Box-Jenkins Models: Delta Airlines Application <b>Muhammed Fatih Yürük</b>	233
13.	Air Cargo Carrier Selection: The Case of Turkey <b>Serdar Alnıpak, Yusuf Can Tunaboşlu, Sefa Ceyhan</b>	242
14.	Drone Technology in Transportation Management: A Systematic Review and Framework for Future Research <b>Muhammed Turgut, Bilal Şeker</b>	251
15.	The Mediating Role of Emotional Labor in Linking Organizational Learning and Organizational Identification in the Aviation Industry <b>Duygu Uludağ, Melis Soyer, Merve Mert</b>	262
16.	Measurement of Process-Performances of Turkish Airports Using Network Data Envelopment Analysis <b>Miraç Eren, Murat Ahmet Doğan</b>	272
17.	Bibliometric Analysis of Academic Publications on Artificial Intelligence and Aviation Keywords with VOSviewer <b>Taha Utkan Uslu, Birsen Açık</b>	284
18.	Investigation of the Effect of the Instrument Landing System on Flights to Konya Airport between 2019-2022 Years <b>Ersin Öktemer, Fatih Alpaslan Kazan</b>	293
19.	Effects of Meteorology Data on Crew Resource Management in Aviation <b>Altuğ Aykan Bayazitoğlu, Habibe Güngör</b>	300

- Review Article -

20.	The Importance of Periodic Oral and Dental Health Examination of Aircrew <b>Gürkan Raşit Bayar, Güneş Sanal, Şükrü Hakan Gündüz, Abdurrahman Engin Demir</b>	310
21.	Elevating Aviation Education: A Comprehensive Examination of Technology's Role in Modern Flight Training <b>Nazmi Dinçer</b>	317

## On Stationarity of Variance Calculation Series

Ongun Yücesan<sup>1\*</sup> 

<sup>1\*</sup>Atılım University, School of Civil Aviation, Avionics Department, 06830, Gölbaşı, Ankara, Türkiye. (ongun.yucesan@atilim.edu.tr)

### Article Info

Received: 29 August 2022  
Revised: 14 March 2023  
Accepted: 30 March 2023  
Published Online: 22 June 2023

#### Keywords:

Stationarity  
Heteroscedasticity  
Variance  
Mean  
Mean Time Between Failure (MTBF)  
Reliability

Corresponding Author: *Ongun Yücesan*

### RESEARCH ARTICLE

<https://doi.org/10.30518/jav.1168121>

### Abstract

While making reliability observations, more samples mean one can make a statistically representative prediction. It is possible to model the failure arrival characteristics statistically using this knowledge. As a natural product of many experiments, a mean and variance figure can be identified for modelling the different occurrences. Even though the different situations can be modelled with such parameters, it may not wholly outline the condition of the product being developed and under test. The variance calculation series derived from the original reliability observation series, which is normally used for simple variance calculation, can be an important consideration. This consideration is rarely encountered. With a mean and a variance figure, a statistical prediction can be made. However, with the very same parameters, another reliability characteristic possessing product or a subcomponent may exist. For this instance, identifying whether the variance calculation series has stationarity and incorporating it in calculations can yield a possible prediction of a more accurate statistical model. In this study, the variance calculation series is considered for their stationary character at hand and is shown to possess such character yielding further modelling possibilities and emphasizing the importance of this consideration.

### 1. Introduction

Reliability predictions are accurate based on relevant observations and experiments on the final product or software artifact. These observations can target to identify a Mean Time Between Failure (MTBF) figure. Experimentation is lengthy, yet the higher number of occurrences results in better statistical significance. An essential factor in an MTBF observation is how consistent the product is. For example, the calculation of a variance figure can measure consistency. This variance or standard deviation can be used along a Gaussian Random Variable for predictions. With these in mind, one can easily predict the Reliability of the system considered.

The predictions based on sole mean value would lack the variances of the conditions altering or different scenarios. Thus including the variance figure makes up for these factors. Nevertheless, the variance figure that is this important on the deviation of outcomes cannot be just judged by mean squared differences. Then it may be wise to consider the individual samples of this calculation for their variability as well. It requires little intuition to see this need; however, if we had five ordered samples as in the following set  $A = \{3, 4, 5, 6, 7\}$ , our sample variance would be 2.5. If we consider another set  $B = \{3, 3, 5, 6, 6.2657\}$  our sample variance would be 2.5001.

The sets are not the same first of all. The mean of set A is 5, and set B has a mean of 4.6531. These two series are statistically very close. The mean values are within 10% of each other. They will have very similar predictions if they are employed for any forecast employing a Gaussian Distribution.

Considering data collected by some manual experiments, one would deem them equal due to human error. However, the results in set A are more uniformly distributed. The results in set B tend to be around 3 and 6 towards the edges of the domain. While considering real-life scenarios with many additional scenarios, two different products can have the same or similar mean and variances. But, one can see that the observations indicate different product characteristics. Set A would feel like it would go off any time, whereas set B would feel like it would go off when 3-unit time has passed.

A third set  $C = \{3.4189, 3.4189, 5.0000, 6.5811, 6.5811\}$  has a mean of 5 and a sample variance of 2.5. This set could feel more resilient once people are told not to continuously work three units of time. Predictions from set C employing the simple set theory would have a zero probability of failure in the domain  $[0, 3.4189]$ . The same mean and variance results from set A would indicate a 0.2 probability of failure in this domain. Set B should indicate a 0.4 probability of failure within this domain with set theory results. Therefore, when an aviation system of taking responsibility for 500 or more people is combined with thousands of additional operational hours, the difference would relate to safe operational durations.

For all the things mentioned, the stationarity of the time series is calculated from squared deviations off the mean figure can be a measure of consistency. This study will refer to the series form squared deviations as *The Variance Calculation Series*. Such measures addressing the change in variability of results are among the few studies attempting to measure the consistency of variations.

The motivation for the philosophical work is presented in the introduction section. The rest of the document includes details of literature and methods followed in Section.2 Materials and Methods. A general presentation and judgement on the outcomes are presented in section 3. Results and Discussion. The paper concludes with section 4. Conclusions.

## 2. Materials and Methods

For the scope of this study, a series from an MTBF observation and build-up effort was also employed within the journal paper, which detailed the testbed as well (Yucesan et al., 2021 and 2022). In a brief explanation, this testbed performs data communication between two entities over a Local Area Network (LAN). In addition, the server is on an Embedded PC that supplies data. However, observations indicated that the query activity could no longer be continued without further reset after a while. The gathering of this query repeat amount data over consecutive times, forms the time series. This activity mimics an industrial workshop internet of things (IIoT) environment.

This workshop activity takes place in a very similar fashion over the Ethernet to newly developed inner-plane communications systems Avionics Full-Duplex Switched Ethernet (AFDX) / Aeronautical Radio Incorporated (ARINC) 664. Further, some probe rocket systems with a low budget (Matevska, 2020) incorporate the Open Platform Collaborations – Unified Access (OPC UA). However, the general system under test (SUT) in this study should be seen as a passive cooled embedded data server working under certain environmental conditions.

The stationarity controls in this study was considered by the employment of the Kwiatkowski, Phillips, Schmidt, and Shin (KPSS) (Kwiatkowski, 1992), Augmented Dickey-Fuller Test (ADF) (Dickey, 1979), and an autocorrelation result. The homoscedasticity (Kipinski, 2011) of the time series indicates that the standard deviation is statistically independent of the previous time samples or constant. The Engle arch test (Engle, 1988) was employed to check this property. All these tests are performed by MATLAB built-in functions. These considerations will reveal whether the variance calculation series is stationary or Independent Identically Distributed (IID). Such a result will ultimately indicate whether a regular random pattern that can be modelled with a known classical distribution accepting a reasonable error exist or not.

## 3. Result and Discussion

In this section, the variance calculation series and the test's results will be presented. The discussion will take place along with the presentation of the available data.

### 3.1. The Variance Calculation Series

As a result of the reliability observations, the series to calculate MTBF has been obtained. The series sample at hand ( $S_i$ ) was removed from the mean value ( $\mu$ ) and squared to get the samples of the variance calculation series ( $V_i$ ) as in Equation (1).

$$V_i = (S_i - \mu)^2 \quad (1)$$

The series  $V_i$  represented can be seen in Figure 1. As we can see, the series generally has a constant deviation figure. The originating series in this manner could have been told to possess homoscedastic characteristics. However, the concern in this paper is the variance calculation series. Even though the

results are grouped mostly nearby, some variations when there are higher reliability occurrences exist. They can be considered as a cost to the producer. However, they would be affecting the mean result and variance result. Still, they would not necessarily validate the IID and stationary considerations. The Gaussian and Exponential are from infinitely long domains. Therefore, any value is possible. Considering the minimum would be zero, worse deviations could have been from an absurdly adverse scenario. Thankfully the reliability observations have a minimum of 0. The mean is around 300 for the originating series visible in Figure 1.

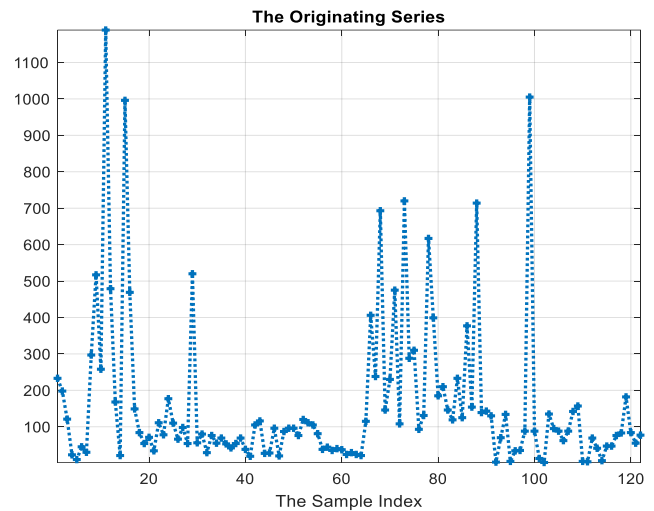


Figure 1. The originating series.

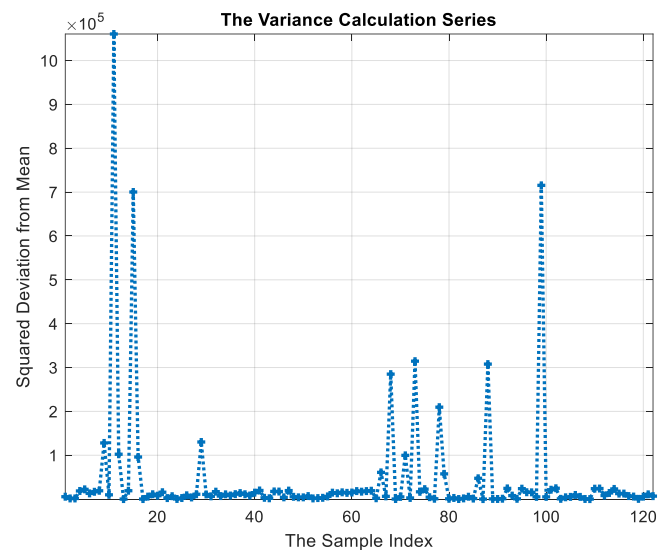


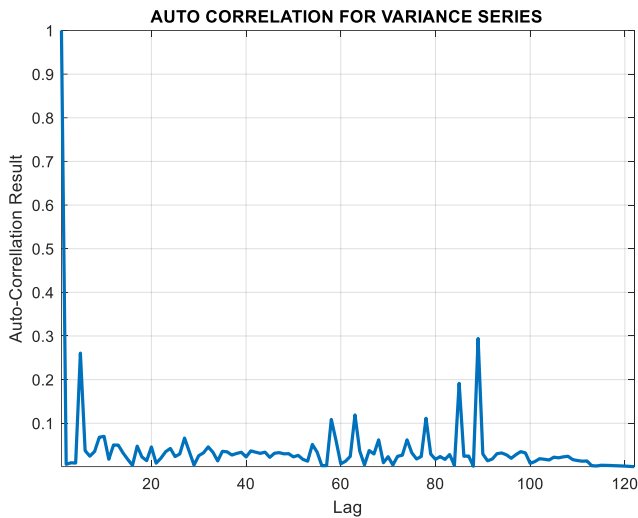
Figure 2. The Variance Calculation Series calculated from the MTBF observations.

The good periods for the duration of operation in originating series are around 70th sample till around 90th sample. However, the period around the 60th sample indicates areas of low reliability. This series was also auxiliary in the originating studies to see how bad the character could be, including all premature and awkward conditions. However, it still possesses some exponential character to findings in the writer's earlier works.



### 3.2. Auto-correlation Results

The Auto-correlation performed over variance calculation series result is available in the Figure 3.



**Figure 3.** Autocorrelation result with regard to the lags.

As shown in Figure 3, the auto-correlation falls below a threshold and stays there. However, long-range lags around 90th lag are more correlated, possibly due to the slightly seasonal characteristic. This seasonality results are due the actual seasons changing the room temperatures and better cooling the passive cooled embedded PC. Similar seasons like November of the previous year and this year present some correlations. The result indicates the stationarity with an acceptable error.

### 3.3. Stationarity and Homoscedasticity Test Results

The outline of the KPSS, ADF, and Engle tests results has for the variance calculation series been reported in Table 1.

**Table 1.** The Stationarity and Homoscedasticity Test Results

Test	Observation
KPSS	Null hypothesis accepted
ADF	Null hypothesis rejected
Engle Test	Null Hypothesis accepted

These tests consider the well-known Auto-Regression (AR) or Auto-Regression Moving Average (ARMA) sort conditions. The KPSS indicates that the null hypothesis is accepted in favor of the existence of an AR equation statistically matching the series at hand. The ADF result rejected the opposing null hypothesis that unit root exists and an AR series statistically matching the series at hand does not exist. Engle's test on the standard deviation constancy is accepted in favor of the null hypothesis that the series does not possess heteroscedastic characteristics against the existence of a complicated formulated alternative. These indicate the existence of a stationary character within the variance calculation series.

### 3.4. Discussion

The stationary character or IID character can indicate the existence of an underlying stochastic process. However, the character of the distribution becomes critical. As a distribution can exist, evident characteristics and predictability arrive. Deviations, on the contrary, would still become important.

An exponential random variable indicates that any failure at any moment is possible. In this case, the variability should have been limited because it does not consider a variance input. A stationarity test can pave the way to predict a pattern and can bring predictability for avoiding awkward situations by being more cautious, using a model incorporating these factors. However, predictability should not mean that this variance series can highly deviate or that the standard deviation of the random process underlying it can be high. Such would result in short possible usage periods. These would be listed at a cost to the producer. An example can be a car company declaring ten years guarantee or else a car company declaring six months guarantee. Because the cost of the guarantee is due the company and lots of failures would not result in competitive pricing. These numbers can be regarded as safe usage periods. Therefore a plane can make the way to Tokyo from Ankara, while another plane with high variability in the variance calculation series can make a voyage safely from Ankara to Istanbul. However, both can be predicted for their probability of failure. Both missions would carry similar risk factors. If the variance series or the originating series were heteroscedastic or non-stationary, a probability for reliability or failure would not be as known as classical distributions, failing to make predictions. By obtaining stationary results as reported, which was presented according to their traditional methods of reporting, illustrates such prediction is possible for at least an example.

### 4. Conclusion

The study reveals that underlying stationarity or IID character can be formulated for the variance calculation series at hand. Such character yields an ability to statistically model the underlying conditions by accepting reasonable error. A study considering this variability is rare. A logical way forward is to identify the underlying statistical distribution for the variance calculation series. This information can be employed for identifying a safe period of usage incorporated along the originating series made for MTBF predictions. The consideration for variance series out of such reliability observations is among the few encountered considerations in literature.

A good future work, therefore, can be the identification of a statistical distribution fitting to the variance series and identifying good methods of incorporating these two series by a statistical method. Since variability in results, even with the same statistical parameters, can affect the safety of a variety of scenarios, as explained in the introduction, it is wise to consider the variance calculation series for reliability predictions.

#### Ethical approval

Not applicable.

#### Conflicts of Interest

The authors declare that there is no conflict of interest regarding the publication of this paper.

#### Acknowledgement

Originating Series was recorded under fund by Tubitak KAMAG 110G007 project performed for Turkish Petroleum Anonymous Partnership (TPAO). However, this study had no funds or support from any governmental or non-governmental organization.

## References

- Dickey, D. A., and W. A. Fuller. (1979). Distribution of the Estimators for Autoregressive Time Series with a Unit Root. *Journal of the American Statistical Association*. Vol. 74, pp. 427-431.
- Engle, R. (1988). Autoregressive Conditional Heteroscedasticity with Estimates of the Variance of United Kingdom Inflation. *Econometrica*. Vol. 96, pp. 893-920.
- Kipiński, L., König, R., Sielużycki, C., & Kordecki, W. (2011). Application of modern tests for stationarity to single-trial MEG data: transferring powerful statistical tools from econometrics to neuroscience. *Biological cybernetics*, 105(3-4), 183–195.
- Kwiatkowski, D., P. C. B. Phillips, P. Schmidt and Y. Shin. (1992) Testing the Null Hypothesis of Stationarity against the Alternative of a Unit Root. *Journal of Econometrics*. Vol. 54, pp. 159-178.
- Machiwal, D., & Sharma, A (2008). Testing homogeneity, stationarity and trend in climatic series at Udaipur – a case study. *Journal of Agrometeorology*, 10(2), 127–135.
- Marcus J Chambers, (1996). Fractional integration, trend stationarity and difference stationarity Evidence from some U.K. macroeconomic time series, *Economics Letters*, Volume 50, Issue 1, Pages 19-24.
- Parey, S., Hoang, T.T.H. & Dacunha-Castelle, D. (2019). Future high-temperature extremes and stationarity. *Nat Hazards* 98, 1115–1134.
- Ulrich K. Müller, (2005). Size and power of tests of stationarity in highly autocorrelated time series, *Journal of Econometrics*, Volume 128, Issue 2, Pages 195-213.
- Yucesan, O., Özkil, A. & Özbek, E. (2021). A Reliability Assessment of an Industrial Communication Protocol on a Windows OS Embedded PC for an Oil Rig Control Application, *Journal of Science, Technology and Engineering Research*, 2 (2), 22-30.
- Yucesan, O., Özkil, A. & Özbek, M. E. (2022). Validity of Exponential Distribution for Modelling Inter-Failure Arrival Times of Windows based Industrial Process Control Data Exchange, *Journal of Science, Technology and Engineering Research*, 3 (1), 1-8.
- Zeybekoğlu, U. & Aktürk, G. (2022). Homogeneity and Trend Analysis of Temperature Series in Hirfanlı Dam Basin. *Türk Doğa ve Fen Dergisi*, 11 (1), 49-58.

---

**Cite this article:** Yucesan, O. (2023). On Stationarity of Variance Calculation Series. *Journal of Aviation*, 7(2), 161-164.



This is an open access article distributed under the terms of the Creative Commons Attribution 4.0 International Licence

Copyright © 2023 Journal of Aviation <https://javsci.com> - <http://dergipark.gov.tr/jav>



# Production of Nanostructured Fasteners with High Shear and Fatigue Strength for Using in Aircraft Components

Kazım Buğra Gürbüz<sup>1</sup> , Mustafa Taşkın<sup>2\*</sup> 

<sup>1</sup> Mersin University, Metallurgical and Material Engineering Department, Mersin, Türkiye. (bugragurbuz89@gmail.com)

<sup>2\*</sup> Mersin University, Metallurgical and Material Engineering Department, Mersin, Türkiye. (taskinmustafa33@gmail.com)

## Article Info

Received: 29 November 2022  
Revised: 11 April 2023  
Accepted: 11 May 2023  
Published Online: 22 June 2023

### Keywords:

HSLA Steels  
Microalloyed  
Heat treatment cyclic  
Multi-axial forging  
Aircraft

Corresponding Author: *Mustafa Taşkın*

## RESEARCH ARTICLE

<https://doi.org/10.30518/jav.1211562>

## Abstract

Multi-axis forging (MAF) and cyclic heat treatment are among the most widely used and easy to apply grain refinement methods. In this study, micro-alloyed steel samples were first subjected to MAF treatments at 880° C. Microstructural analysis showed that the average grain size, which was 13.2 µm initially, decreased to 11.2 µm application of the MAF. As a second-grain refinement technique, cyclic heat treatment was used. Samples were subjected to 1, 3, 5, 7, and 10 cyclic quenching. With this method, it was observed that the average grain size decreased to 2,3 µm. The mechanical tests showed that the second MAF process increased the yield and tensile strength of the material by about 16% while decreasing the elongation by %2. These tests also presented cyclic quenching increased tensile strength of the samples after the first application.

## 1. Introduction

Microalloyed steels or often referred as high strength low alloy (HSLA) steels, are subgroup of low carbon steel that typically contain less than 0,2% carbon, up to 2% manganese, and a small amount of other alloying elements, such as niobium, vanadium, titanium, molybdenum, aluminum (Baker, 2016; Shao et al., 2018). Generally, these steels contain a combination of these alloying elements up to 2%wt in weight to reach yield strength greater than 275 MPa. In many industries such as automotive, aerospace, pipelines, construction, railway, nuclear power plants, and naval industry, micro-alloyed steels are widely used as a structural material due to its remarkable mechanical properties, formability, lightweight and good weldability (Shao et al., 2018; Vervynckt et al., 2012; Shi et al., 2019; Ledermueller, et al., 2020; Ramesh, et al., 2020; Li et al., 2020).

Although each alloying element has different characteristics that alter mechanical properties, the primary purpose of microalloying addition is to obtain ferrite strengthening via solid solution strengthening, precipitation hardening and, most importantly, grain refinement (Vervynckt et al., 2012). Many studies have shown that niobium is one of the most effective alloying elements used to strengthen micro-alloyed steels, by not only retarding recrystallization and growth of ferrite grains but also contribute solid solution strengthening by precipitate into ferrite in the form of Nb (C, N) (Cao et al., 2007; Chen et al., 2013). Vanadium, on the other

hand, is almost entirely soluble in the austenite phase and contributes to the increase in strength by precipitation in the form of V (C, N) during the austenite ferrite transformation (Baker, 2009; Dewi et al., 2020; Lagneborg et al., 1999; Singh et al., 2020). Studies show that titanium is used for the precipitation hardening mechanism and sulphide shape control instead of grain refinement. Although its contribution to precipitation hardening is much more effective than vanadium or niobium, the grain refinement effect is weaker than theirs. Therefore, titanium is often combined with vanadium and niobium for better results (Baker, 2019). Apart from these most commonly used elements, the addition of aluminum usually provides deoxidation of the steel but also prevents grain growth in the Al (N) form (Vervynckt et al., 2012).

Despite the fact that the alloy composition has a specific effect on mechanical properties, the distinctive properties of micro-alloyed steels are mainly determined by the heat treatment, severe plastic deformation and/or thermomechanical processes applied after casting (Majta et al., 2007). There are multiple reasons to use these processes, such as solid solution strengthening and precipitation hardening, but in general superior mechanical properties of micro-alloyed steels rely on grain refinement. Combining the proper chemical composition and process parameters makes obtaining different microstructures, grain sizes, and desired properties possible. Studies show that cyclic heat treatment is more effective than conventional heat treatments to optimize strength, ductility, and toughness (Ray et al., 2003; Wang, et

al., 2007). The primary purpose of the cyclic processes is to reduce the austenite grain size in each cycle to ensure that the final grain size is as fine as possible. Since the grain reduction effect of these treatments depends on controlling the austenite phase, these processes are insufficient in most steels where only austenitic growth can be prevented by operating temperature and waiting time. As for HSLA steels, austenite growth is mainly controlled by micro-alloy elements; therefore, thermal cycles are more effective for these materials. These steels are also known as "Micro-alloyed Steels" due to the small amount of alloying elements they contain. These steels have superior mechanical properties and often better corrosion resistance than rolled carbon steels. Thanks to these properties, HSLA steels are preferred in many fields, especially in the aviation and space sectors (Davis et al., 2001).

Like heat treatment, severe plastic deformation (SPD) techniques focus on grain refinement to increase the mechanical properties of the micro-alloyed steels. In this technique, grain refinement is achieved by imposing large accumulated plastic strains on the material at room or elevated temperatures (Song et al., 2006). There are many SPD methods, such as equal-channel angular pressing (ECAP), accumulative roll bonding (ARB), high-pressure torsion (HPT), and multi-axial forging (MAF), have been successfully applied to grain refinement (Song et al., 2006; Nakao et al., 2011). Among these techniques, MAF stands out because it is relatively simple, easily adaptable for different materials and geometries and can be used to produce large bulk materials (Xia et al., 2013). The material is subjected to high-pressing forces on different axes in the austenite region in the MAF

method. The size and orientation homogeneity of the grains is achieved by rotating the materials 90 ° around their axis at the end of each loading. In this process, slip shear created by the axial loading produces deformed bands in deformed grains in a certain direction. When the order of the load is changed, new deformation bands are formed in different directions from the first bands. The intersection of these bands causes the formation of many sub-particles in the material. As the angles of these sub-grains increase in the continuation of the process, the sub-grains turn into excellent average grains (Huang et al., 2006).

The main purpose of this paper is to determine the appropriate thermal conversion and multi-axial forging parameters that can be used to obtain ultrafine grain in micro-alloyed steels. For this purpose, samples with the same chemical composition were subjected to mechanical and microstructural tests after being subjected to different thermal cycling and multi-axial forging processes.

## 2. Materials and Methods

### 2.1. Preparation of the sample

The micro-alloyed steel, whose composition (by ARL Model 4460 Thermo Scientific spectrometer) is listed in Table 1, was chosen in this study. The chemical composition was investigated according to ASTM E45.

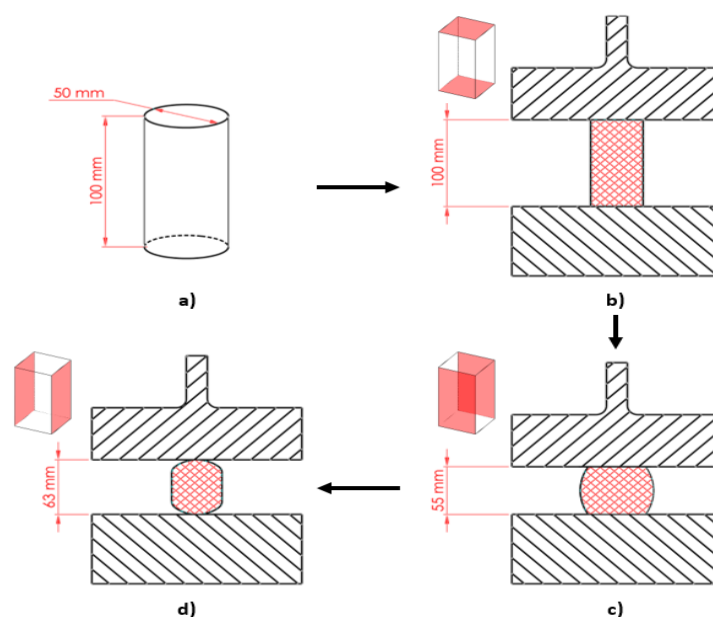
First, the micro-alloyed steel was melted in the induction furnace at 1200 °C. After the preparation of the alloy, the melt was poured into the resin molds, and the physical cleaning of the sample surfaces after solidification.

**Table 1.** Chemical composition of the produced samples (wt%)

C	Mn	V	Ti	Al	Nb	Mo	Ni	Cr	Cu	Si	P	S
0.138	1.468	0.066	0.010	0.017	0.040	0.174	0.049	0.092	0.098	0.363	0.012	0.016

The samples were subjected to multi-axial forging and cyclic quenching for fine grain size. The samples were first subjected to Multi-Axial Forging (MAF) in a hydraulic press to achieve

this. The schematic representation of the forging process is given in Figure 1.



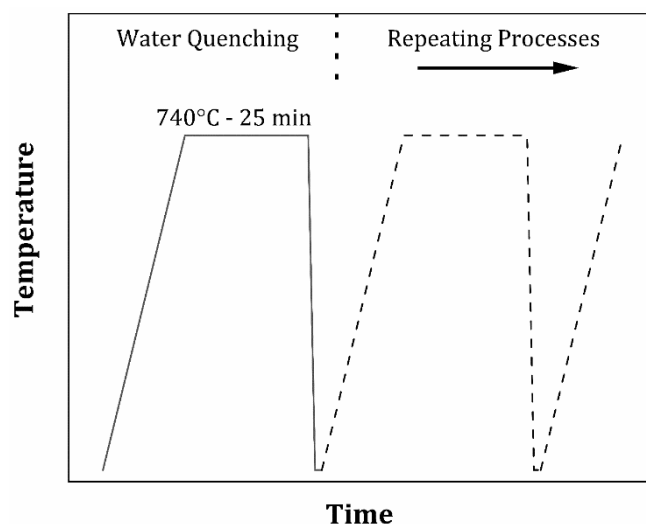
**Figure 1.** Schematic forging steps: **a)** initial dimensions of the samples, **b) – d)** forging in different axes.

A sample was marked as "No.0" and selected as a reference sample. The remaining samples were heated to 880°C and held at this temperature for 60 min to obtain the austenite phase. After the phase transformation, the samples were forged (Figure.1. b – d), with 20% constant strain in all three axes. The samples were directly quenched at the water at room temperature right after the forging was completed. Samples took the form of a slightly curved rectangular prism after forging. The average length and width of the samples were measured as 88 mm by 52 mm, respectively.

When the multi-axial forging was completed, specimens were subjected to cyclic quenching to apply additional grain size reduction. The main purpose of this process is to reduce the final grain size of the materials by repeated austenite → martensite transformation from the  $\alpha + \gamma$  region. Cyclic heat treatment was applied to samples 1, 3, 5, 7, and 10 times, and they were marked as "A.2", "A.3", "A.4", "A.5" and "A.6" respectively. The number of heat treatment cycles and total strain applied to the samples and processing route of the cyclic quenching used on the samples is given in Table 2 and Figure 2. respectively.

**Table 2.** Strain rate and number of the cyclic quenching repeats applied to samples

Sample Code	Total Strain (All Axes) (%)	Cyclic Quenching Repetitions (Times)
No.0.	0	0
A.1.	20	0
A.2.	20	1
A.3.	20	3
A.4.	20	5
A.5.	20	7
A.6.	20	10



**Figure 2.** Cyclic quenching process route applied on the samples

As shown in Figure 2., to transform the  $\alpha$  phase into the  $\alpha + \gamma$  phase, the samples were heated to 740° C and kept at this temperature for 25 minutes to achieve sufficient transformation. After the transformation, the samples were quenched in water at 23° C to obtain martensite from the transformed  $\gamma$  phase. The number of repetitions applied to the

samples was determined according to the numbers indicated in Table 2.

### 2.2. Microstructure observation

Optical microscopy and scanning electron microscopy (SEM) were performed to determine the effect of the applied processes on the average grain size of the specimens. The samples were first cut in appropriate sizes using a Metkon brand Metacut 251 model oil-cooled cutting disc to examine the microstructure in the optical microscope. After sectioning, samples were hot mounted by Tronic brand EcoPress 30 model hot bakelite molding device. The grinding process was applied to each sample under water using sandpaper with SiC particles 80, 120, 240, 600, 800, and 1200 grit sizes, respectively. After the process was completed, the samples were taken to the rough polishing process. Rough polishing was done using 9  $\mu$ m and 6  $\mu$ m Metkon Diapat-M branded diamond suspensions on discs covered with plain fabric cloth, respectively. After rough polishing, 3  $\mu$ m and 1  $\mu$ m Metkon Diapat-M branded diamond suspensions were used, respectively, on the discs covered with velvet fabric for precision polishing. Sanding and polishing processes were carried out using the automatic polishing device (Struers RotoPol-21).

After polishing, the samples were washed with distilled water and alcohol, then dried under warm air. Finally, the samples were etched to reveal the grain boundaries under an optical microscope. Etching was carried out by keeping the sample surfaces in a 4% nital solution at room temperature for 4 minutes. The microstructures were observed by inverted type microscope (Zeiss, Axio).

### 2.3. Mechanical tests

For the tensile test, the samples were prepared according to the DIN 50125: 2016-2 B tensile test standard for metallic materials. This standard obtained a bone-type test specimen of 8 mm diameter and 51 mm length. Three tensile test pieces were prepared in each sample with selected dimensions to perform the tensile test properly and avoid a possible error. The machined parts were tested on tensile tester (Zwick, Roell Z250, 250kN capacity). All tensile tests were carried out at standard 24 ° C and a 0.5 mm/sec speed. The test results were transferred to the computer environment with the TestXper III program, and the raw data required for drawing the stress-strain graph was obtained. The test pieces' elastic modulus, elongation, yield, and tensile strength were calculated using the same program.

A digital hardness tester (Galileo, ErgoTest Digi 25R), was used for the hardness measurements of samples. Five measurements were made at equal intervals along a line passing through the center of each sample to measure the hardness accurately. The hardness values of the samples were calculated by disregarding the largest and the smallest value from the results obtained and finding the average of the remaining three measurement points.

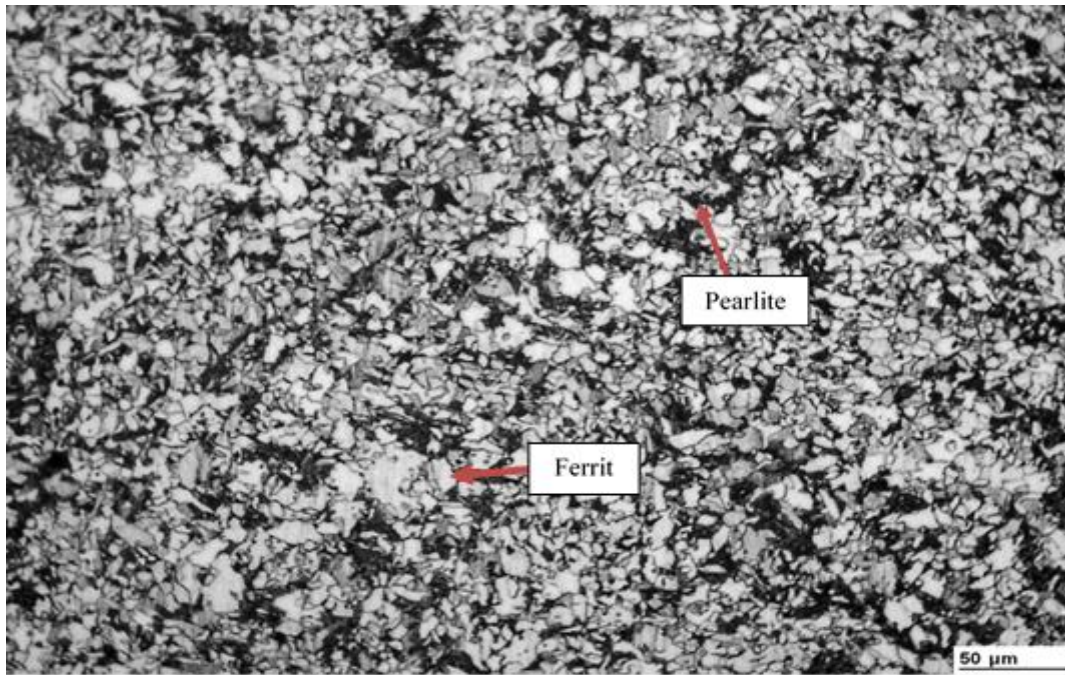
## 3. Result and Discussion

### 3.1. Microstructural Examination

To determine the effect of cyclic quenching, microstructure analysis, tensile and hardness tests were applied to the samples.

The microstructure image was taken at 200x magnification of the part marked with No.0., which belongs to the grain reduction processes applied to the samples, is given in Figure 3.

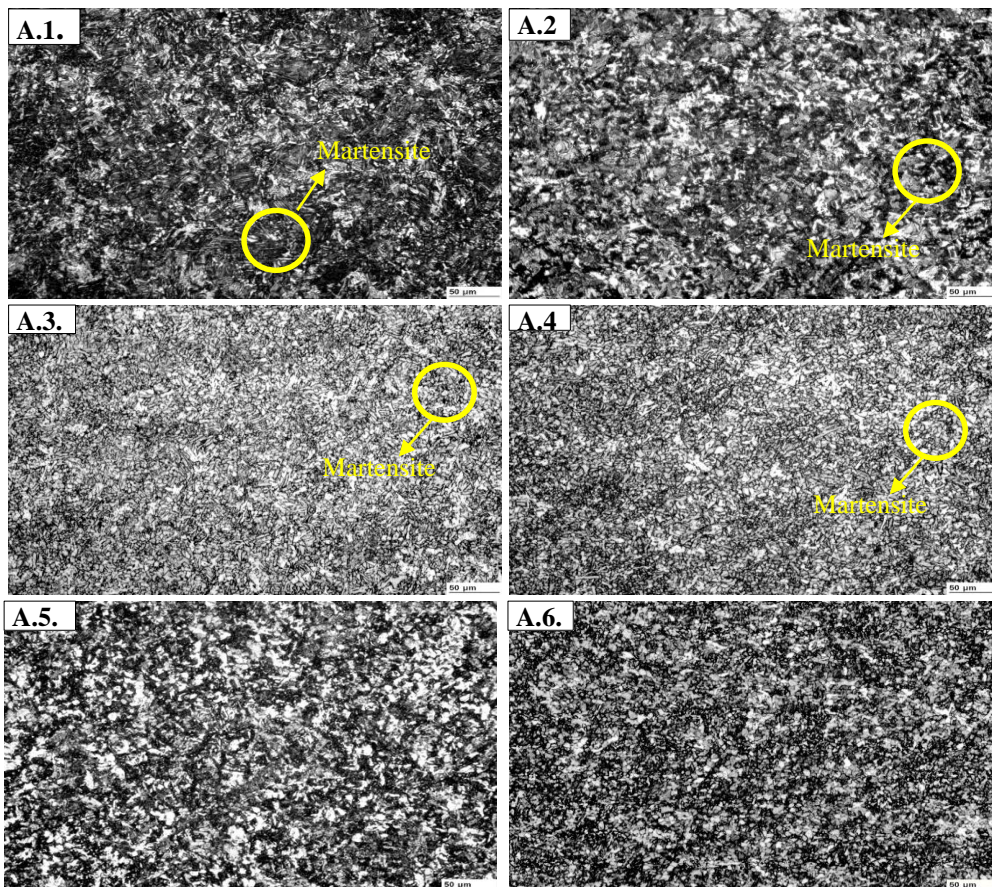




**Figure 3.** Optical microstructure of sample No.0

In the first examination of the microstructure seen in Figure 3, it is clearly seen that the material structure is formed of ferrite (light-colored islets) + pearlite (dark areas). The average grain size of the No.0. sample was determined as 13.3 μm.

The microstructure of the samples that were subjected to the MAF process and cyclic heat treatment was given in Figure 4.



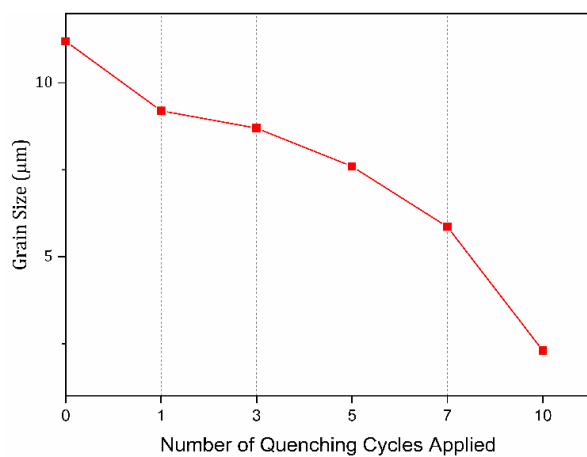
**Figure 4.** Optical microstructures of the samples



From Figure 4, it can be observed that the grain size decreases with each thermal cycle. When the images are examined separately, it is seen that lamellar martensite formation has started in the A.1. sample in addition to the refining of perlite and ferrite phases in No.0. sample. The average grain sizes of the samples calculated by computer are shown in Table 3 and Figure 5. In the material's austenite region, the martensite phase (lamellar structures) formed in addition to ferrite and pearlite is observed in the microstructure after forging in three axes. At the same time, the grain reduction effect of the amount of strain applied to the material is seen.

**Table 3.** Average grain size of the group “A” samples

Sample Code	Cyclic Quenching Repetitions (Times)	Average Grain Size (µm)
A.1.	0	11.2
A.2.	1	9.2
A.3.	3	8.7
A.4.	5	7.6
A.5.	7	5.86
A.6.	10	2.3



**Figure 5.** Average grain size of the samples

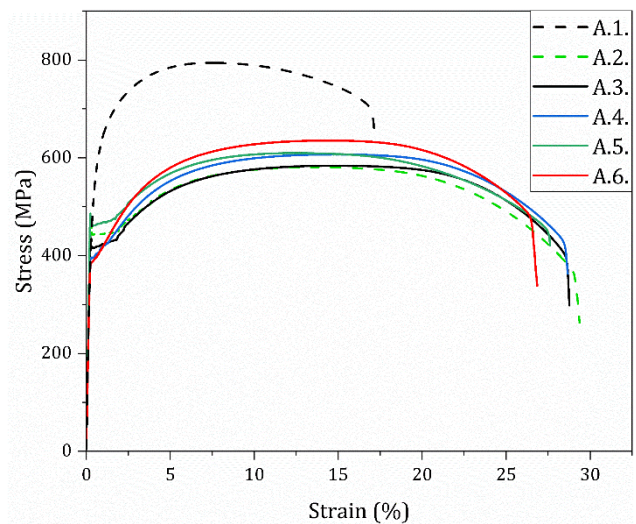
As shown in Table 3 and Figure 5, average grain size reduces with increasing thermal cycles as expected. The initial quenching resulted in an approximately 18% reduction in the average grain size of the material. In addition, it was calculated that cyclic quenching decreased the average grain size of the samples by 22% in 3 repetitions, 32% in 5 repetitions, 48% in 7 repetitions, and finally %79 in 10 repetitions.

### 3.2. Tensile Test

The tensile tests were performed under standard laboratory conditions at 0.5 mm/min loading velocity. Numerical data of the tensile test and the stress-strain curves of these data are given in Tables 5 and Figure 6, respectively.

**Table 5.** Tensile test result of the samples

Sample Code	Elongation (%)	Yield Strength (MPa)	Tensile Strength (MPa)
A.1.	17	512	794
A.2.	29.2	490.3	580.5
A.3.	28.6	438	584
A.4.	28	431	608
A.5.	27.6	460.8	609.5
A.6.	27	389	635

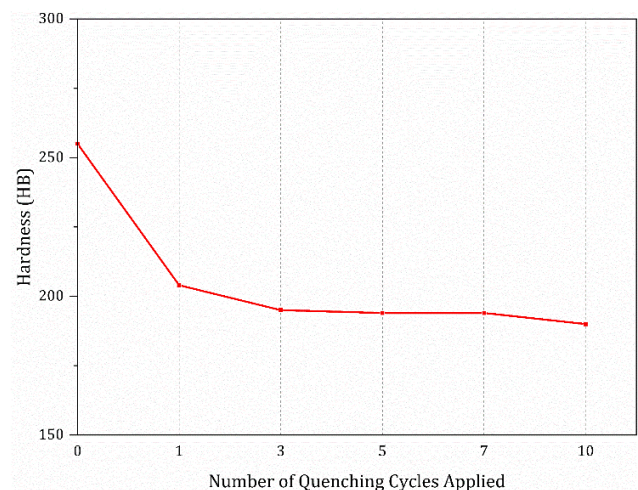


**Figure 6.** Stress – strain curve of samples.

When the strain-strain curve shown in Figure 6 is examined, it is seen that the A.1. sample without heat treatment has the highest yield and tensile strength and the lowest percentage elongation compared to the other samples. It is easily seen from Table 5 that after the initial quenching, the increasing number of quenching cycles increases the tensile strength while decreasing the elongation by a very small amount. Furthermore, it was found that the applied quenching cycles caused almost no change in the toughness of the materials.

### 3.3. Hardness Test

Hardness tests of all samples were done using the Brinell scale. Figure 7 shows the hardness values versus the number of thermal cycles of the samples.



**Figure 7.** Hardness values of the samples

It can be seen in Figure 7 that the first heat treatment significantly reduced the hardness value of the material. On the other hand, seen that the increasing number of thermal cycles has almost no effect on the hardness values of the materials.

## 4. Conclusion

This study investigated the effect of cyclic heat treatment on micro-alloyed steels. The observations are summarized in the following part;

- As a result of the first MAF process, it was observed that there was an approximately 16% reduction in grain size.
- Each quenching cycle resulted in a reduction in the grain size of the samples, as expected.
- After the 10th quenching, the average grain size of the sample was measured as 2,3 μm. This shows that an approximately 83% reduction is achieved with ten quenching cycles.
- Although a decrease in tensile strength was observed after the first quenching process, a specific increase was observed with increasing cycles.
- Even though the elongation increased by approximately 72% after the first quenching process, no significant change was observed in the ongoing quenching cycles.
- Like elongation, initial quenching significantly lowered the hardness of the sample, but increasing the number of cycles was found to have no significant effect on hardness.
- It has been observed that increasing the quenching cycle decreases yield strength while increasing tensile strength. This situation can be interpreted that the quenching cycle causing an increase in plastic-forming capability in the samples.

#### Ethical approval

Not applicable.

#### Conflicts of Interest

The authors declare that there is no conflict of interest regarding the publication of this paper.

#### Acknowledgement

This study was supported by Mersin KOSGEB Directorate.

#### References

- Baker, T.N. (2009). Processes, microstructure and properties of vanadium microalloyed steels. *Materials Science and Technology*, 25(9), 1083-1107.
- Baker, T.N. (2016). Microalloyed steels. *Ironmaking & Steelmaking*, 43(4), 264-307.
- Baker, T.N. (2019). Titanium microalloyed steels. *Ironmaking & Steelmaking*, 46(1), 1-55.
- Cao, J.-c., et al. (2007). Effect of Niobium on Isothermal Transformation of Austenite to Ferrite in HSLA Low-Carbon Steel. *Journal of Iron and Steel Research, International*, 14(3), 52-56.
- Chen, Y., et al. (2013). Effect of dissolution and precipitation of Nb on the formation of acicular ferrite/bainite ferrite in low-carbon HSLA steels. *Materials Characterization*, 84, 232-239.
- Davis, J. R., *Alloying* (2001). Understanding the Basics. ASM International: Materials Park, 193-209.
- Dewi, H.S., Volpp J., & Kaplan A.F.H. (2020). Short thermal cycle treatment with laser of vanadium microalloyed steels. *Journal of Manufacturing Processes*, 57, 543-551.
- Huang, J. and Z. Xu (2006). Evolution mechanism of grain refinement based on dynamic recrystallization in multiaxially forged austenite. *Materials Letters*, 60(15), 1854-1858.
- Lagneborg, R., et al. (1999). Role of vanadium in microalloyed steels. *Scandinavian Journal of Metallurgy*, 28,186-241.
- Ledermueller, C., et al. (2020). Microalloying effects of Mo versus Cr in HSLA steels with ultrafine-grained ferrite microstructures. *Materials & Design*, 185, 108278.
- Li, X., et al. (2020). Acquiring a low yield ratio well synchronized with enhanced strength of HSLA pipeline steels through adjusting multiple-phase microstructures. *Materials Science and Engineering: A*, 785, 139350.
- Majta, J. & Muszka K. (2007). Mechanical properties of ultra fine-grained HSLA and Ti-IF steels. *Materials Science and Engineering: A*, 464(1): p. 186-191.
- Nakao, Y. & Miura H. (2011). Nano-grain evolution in austenitic stainless steel during multi-directional forging. *Materials Science and Engineering: A*, 528(3), 1310-1317.
- Ramesh, R., et al. (2020). Microstructural characterization and tensile behavior of Nd:YAG laser beam welded thin high strength low alloy steel sheets. *Materials Science and Engineering: A*,780,139178.
- Ray, P.K., Ganguly R.I., & Panda A.K. (2003). Optimization of mechanical properties of an HSLA-100 steel through control of heat treatment variables. *Materials Science and Engineering: A*, 346(1), 122-131.
- Shao, Y., et al. (2018). Formation mechanism and control methods of acicular ferrite in HSLA steels: A review. *Journal of Materials Science & Technology*, 34(5), 737-744.
- Shi, R., et al. (2019). Microstructure evolution of in-situ nanoparticles and its comprehensive effect on high strength steel. *Journal of Materials Science & Technology*, 35(9), 1940-1950.
- Singh, A.P. & Pant, G. (2020). Mechanical behaviour of vanadium microalloyed steel under control environment compression. *Materials Today: Proceedings*, 26, 2525-2527.
- Song, R., et al. (2006). Overview of processing, microstructure and mechanical properties of ultrafine grained bcc steels. *Materials Science and Engineering: A*, 441(1), 1-17.
- Vervynck, S., et al. (2012). Modern HSLA steels and role of non-recrystallisation temperature. *International Materials Reviews*, 57(4), 187-207.
- Wang, Q.F., et al. (2007). Refinement of Steel Austenite Grain Under an Extremely High Degree of Superheating. *Journal of Iron and Steel Research, International*, 14(5), 161-166.
- Xia, X.-s., et al. (2013). Microstructure and mechanical properties of isothermal multi-axial forging formed AZ61 Mg alloy. *Transactions of Nonferrous Metals Society of China*, 23(11), 3186-3192.

**Cite this article:** Gurbuz, K.B, Taskin, M. (2023). Production of Nanostructured Fasteners with High Shear and Fatigue Strength for Using in Aircraft Components. *Journal of Aviation*, 7(2), 165-170.



This is an open access article distributed under the terms of the Creative Commons Attribution 4.0 International License

Copyright © 2023 Journal of Aviation <https://javsci.com> - <http://dergipark.gov.tr/jav>

# Design and Simulation of a Conformal Micro-Strip Patch Antenna at GNSS L1/ E1 Frequency Band

Betül Yılmaz<sup>1\*</sup> <sup>1\*</sup>Mersin University, Electrical-Electronics Engineering Department, 33343, Yenişehir, Mersin, Türkiye. (betuly@mersin.edu.tr).

## Article Info

Received: 11 January 2023  
 Revised: 27 April 2023  
 Accepted: 03 May 2023  
 Published Online: 22 June 2023

### Keywords:

Conformal Antenna  
 U-Slot Patch Antenna  
 GNSS Application  
 L1 frequency Band  
 Unmanned Aerial Vehicles

Corresponding Author: *Betül Yılmaz*

## RESEARCH ARTICLE

<https://doi.org/10.30518/jav.1232589>

## Abstract

In this paper, we have designed a conformal U-slot type micro-strip ( $\mu$ -strip) patch antenna to be used in L1 frequency band. First, a primary design of flat, rectangular U-slot  $\mu$ -strip patch antenna is designed around the center frequency of L1 band that is 1575.42 MHz. Then, this design has been converted to a conformal type such that it can be used cylindrical platforms such as missiles. The primary design of conformal U-slot  $\mu$ -strip patch antenna has been optimized for the L1, E1 frequency band between 1563 MHz and 1587 MHz, and 1559 MHz and 1591 MHz; respectively. Then, antenna parameters such as operation bandwidth and the radiation pattern were reported based on the optimized simulation results for this stand-alone conformal antenna. Finally, this antenna has been positioned on a missile model and the antenna simulation is repeated to validate the effectiveness and the usability of this antenna on a realistic platform and the scenario. The real-physics antenna simulation of the final optimized conformal U-slot type  $\mu$ -strip patch antenna mounted on the missile model has shown that this antenna is effectively operation between 1.5442 and 1.6077 GHz such that it can conveniently be used for Global Navigation Satellite System (GNSS) applications of L1 and E1 band.

## 1. Introduction

For the last decade, the use of conformal antennas has been gaining a lot of interest thanks to emerging many applications of missile, unmanned air vehicles (UAVs), and similar platforms (Balderas et al., 2019; Obeidat et al., 2009; Pradhan et al., 2022; Chen et al., 2017; Khalil et al., 2019; Morton et al., 2006). The foremost necessity of using conformal antennas comes from the aerodynamic requirements of these platforms such that any antenna that has to be mounted on such platforms will almost no effect of their flight dynamics on contrary to linear antennas such as dipole or monopole (Ozdemir et al.; 1997).  $\mu$ -strip patch antennas; at this point of view, has the great advantage of being easily produced with conformal features when compared to any other type of antennas. Therefore, it is common to use such planar type of antennas on these kind of platforms (Gaetano et al., 2012; Mondal et al., 2014; Nikolaou et al., 2006).

Among widely used  $\mu$ -strip patch antennas, the U-shaped one has the attractive feature of having wider frequency bandwidth compared to rectangular  $\mu$ -strip patch antenna. Many researchers have put significant effort in understanding the physics behind the resonant frequency and radiation characteristics of U-slot  $\mu$ -strip patch antenna (Tong 2005, Bhattacharjee et al., 2013; Rani et al., 2010; Mishra et al., 2015; Mitha et al., 2018). Tong has given the required formulations for the antenna dimensions based on the common antenna parameters such as effective dielectric constant,

resonant frequency and the bandwidth for the broadband planar U-slot  $\mu$ -strip patch antenna (Tong 2005). Bhattacharjee et al. have given a planar U-slot  $\mu$ -strip patch antenna design for Wireless LAN applications at 2.45GHz (Bhattacharjee et al., 2013). Rani and Dawre have presented a similar design of the same antenna; but this time for satellite communication frequencies between 4 GHz and 6 GHz by applying Genetic algorithm for the optimization of the antenna gain (Rani et al., 2010). All of these studies were for planar type U-slot  $\mu$ -strip patch antennas. There are very few studies that uses conformal designs of U-slot  $\mu$ -strip patch antennas that were reported in the literature (Mishra et al., 2015; Mitha et al., 2018): Mishra and Gupta have proposed a four-stage U-slot  $\mu$ -strip patch antenna to achieve dual band operation around 6.7 and 7.3 GHz (Mishra et al., 2015). Mitha and Pour have designed conformal wideband U-slot  $\mu$ -strip patch antenna for X-band of frequencies (Mitha et al., 2018).

In this study, we present a unique conformal U-slot  $\mu$ -strip patch antenna specially designed to be used GNSS L1/ E1 usages including the frequency band of 1559 MHz -1591 MHz. The other main goal of this study is to use the final design on a realistic platform such as a missile and also assess the performance characteristics. The structure of the paper is as follows: In the next section, a general theory of planar, rectangular U-slot  $\mu$ -strip patch antenna is reviewed. In Sect. III, the numerical design of the rectangular U-slot  $\mu$ -strip patch antenna is achieved for the GNSS L1/ E1 frequencies by the help of antenna simulation and analysis tool of CST Studio



Suite 3D (CST Studio Suite 2023). In Sect. IV; first, the conformal version of the antenna that was designed in the previous section is attained; and afterwards, the associated antenna analysis study for the conformal version of the antenna is presented. Next, the final, optimized conformal U-slot  $\mu$ -strip patch design is put on a realistic missile model and the antenna performance of the whole geometry is investigated and reported. The last section is dedicated to the discussions and the concluding remarks.

## 2. Review of U-Slot $\mu$ -Strip Patch Antenna

A typical geometry of the U-slot rectangular patch antenna is shown in Fig. 1a. The key dimension parameters are marked on the antenna geometry in this figure. First, we review the theory behind the U-slot rectangular patch antenna so that we can use this theoretical primary design to be used for the design of conformal U-slot  $\mu$ -strip patch antenna.

### 2.1. Design Equations for rectangular U-slot $\mu$ -strip patch antenna

The design dimensions of the U-slot  $\mu$ -strip patch antenna are based on the desired center frequency;  $f_c$  and the frequency bandwidth;  $B = f_H - f_L$  of the antenna. Here,  $f_H$  and  $f_L$  stand for higher and lower frequencies of the -10 dB bandwidth of the antenna.

If the dielectric constant of the patch's substrate material is  $\epsilon_r$  and the thickness of the substrate is  $h$ , then the width of conducting patch of the designed antenna can be obtained as follows (Bhattacharjee et al., 2013);

$$W = \frac{c_0}{2f_c} \sqrt{\frac{2}{\epsilon_r + 1}} \quad (1)$$

where  $c_0$  is the velocity of the light in free-space. Then, the effective dielectric constant can be approximately calculated via (Bhattacharjee et al., 2013);

$$\epsilon_{r,eff} = 0.5(\epsilon_r + 1) + 0.5(\epsilon_r - 1) \left[ 1 + 12 \frac{h}{W} \right]^{-1/2} \quad (2)$$

The actual length of patch is obtained by regarding of the effective length  $L_{eff} = c_0 / (2f_c \sqrt{\epsilon_{r,eff}})$  and the length extension on each end by a distance  $\Delta_L$  which is given by (Rani et al., 2010):

$$L = L_{eff} - 2\Delta_L \quad (3)$$

where  $\Delta_L$ , so called the scattering length, can be calculated via (Rani et al., 2010);

$$\Delta_L = 0.412h \frac{\left( \frac{W}{h} + 0.264 \right) (\epsilon_{r,eff} + 0.3)}{\left( \frac{W}{h} + 0.8 \right) (\epsilon_{r,eff} - 0.258)} \quad (4)$$

For the rectangular U-slot  $\mu$ -strip patch antennas, the design procedure proposed in (Bhattacharjee et al., 2013; Rani et al., 2010) can be incorporated to achieve an initial design.

The parallel arms of the U-shaped slot are also parallel to the length side of the patch.  $L_s$  and  $W_s$  are horizontal and vertical widths of U-slot arms, respectively. Nominal values for the initial values of  $L_s$  and  $W_s$  can be initially appointed as

(Tong 2005, Bhattacharjee et al., 2013; Rani et al., 2010; Weigand et al., 2003)

$$\begin{aligned} L_s &= \frac{\lambda_c}{60} \\ W_s &= \frac{\lambda_c}{60} \end{aligned} \quad (5)$$

where  $\lambda_c$  is the center wavelength. Then, the slot width  $W_i$  can be calculated by (Tong 2005, Weigand et al., 2003);

$$W_i = \frac{c_0}{f_L \epsilon_{r,eff}^{1/2}} - 2(L_{eff} - L_s) \quad (6)$$

where the length of the slot  $L_i$  is selected such that it should satisfy the inequalities of

$$\begin{aligned} \frac{L_i}{W} &\geq 0.3 \\ \frac{L_i}{W_i} &\geq 0.75 \end{aligned} \quad (7)$$

As the last rectangular U-slot  $\mu$ -strip patch antenna, the slot spacing from edge can be approximated as (Tong 2005, Weigand et al., 2003);

$$S_s \approx L - L_s + 2\Delta_{L-L_s-S_s} - \frac{1}{\sqrt{\epsilon_{eff}(pp)}} \left( \frac{c_0}{f_H} - (2L_i + W_i) \right) \quad (8)$$

where

$$\epsilon_{eff}(pp) = 0.5 \left( (\epsilon_r + 1) + \frac{(\epsilon_r - 1)}{\left( 1 + \frac{12h}{W_i - 2W_s} \right)^{1/2}} \right) \quad (9)$$

and

$$2\Delta_{L-L_s-S_s} = 0.824h \frac{(\epsilon_{eff}(pp) + 0.3) \left( \frac{W_i - 2W_s}{h} + 0.262 \right)}{(\epsilon_{eff}(pp) - 0.258) \left( \frac{W_i - 2W_s}{h} + 0.813 \right)} \quad (10)$$

## 3. Design and Simulation of Rectangular U-slot $\mu$ -strip patch antenna

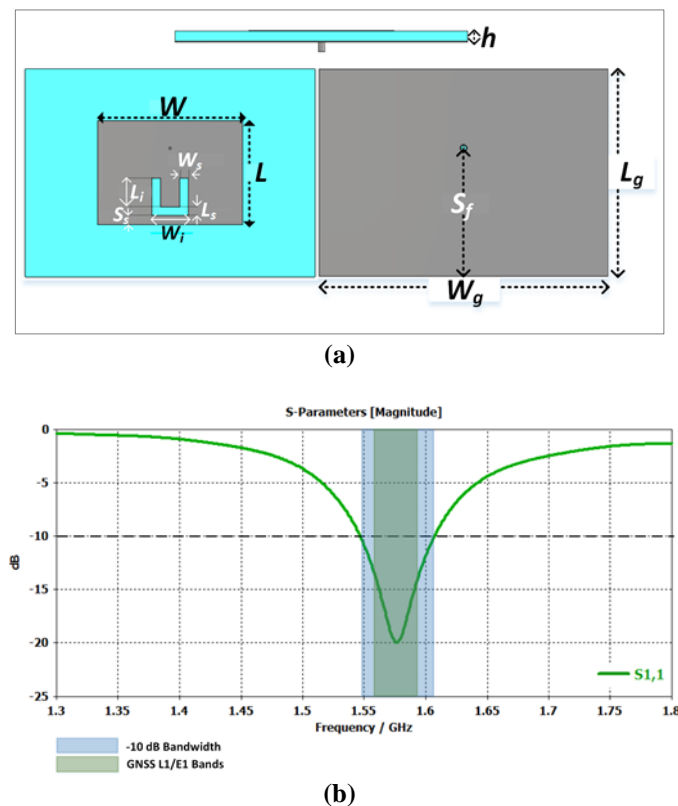
Based on the formulations that have listed in Sect. II, we have started with a preliminary design of the rectangular U-slot  $\mu$ -strip patch antenna by the help of CST Studio Suite 3D antenna design and analysis tool (CST Studio Suite 2023). For the substrate the commercially available and widely used substrate material of high-density polyethylene (HDPE) (Khouaja et al., 2021) whose dielectric constant is 2.4 with a substrate thickness of 1.5 mm was selected. The thickness of the copper material was 100  $\mu$ m. The feeding of the antenna was accomplished via a coaxial feed that has a nominal characteristic impedance of 50 $\Omega$ .

The initial design parameters were calculated by using the formulas given in equations between (1) and (10) and, then the optimization toolbox of CST has been utilized to make the design around the center frequency of the L1 band. The design of the rectangular U-slot  $\mu$ -strip patch antenna has been finalized as given in Fig. 1a. The optimized and final

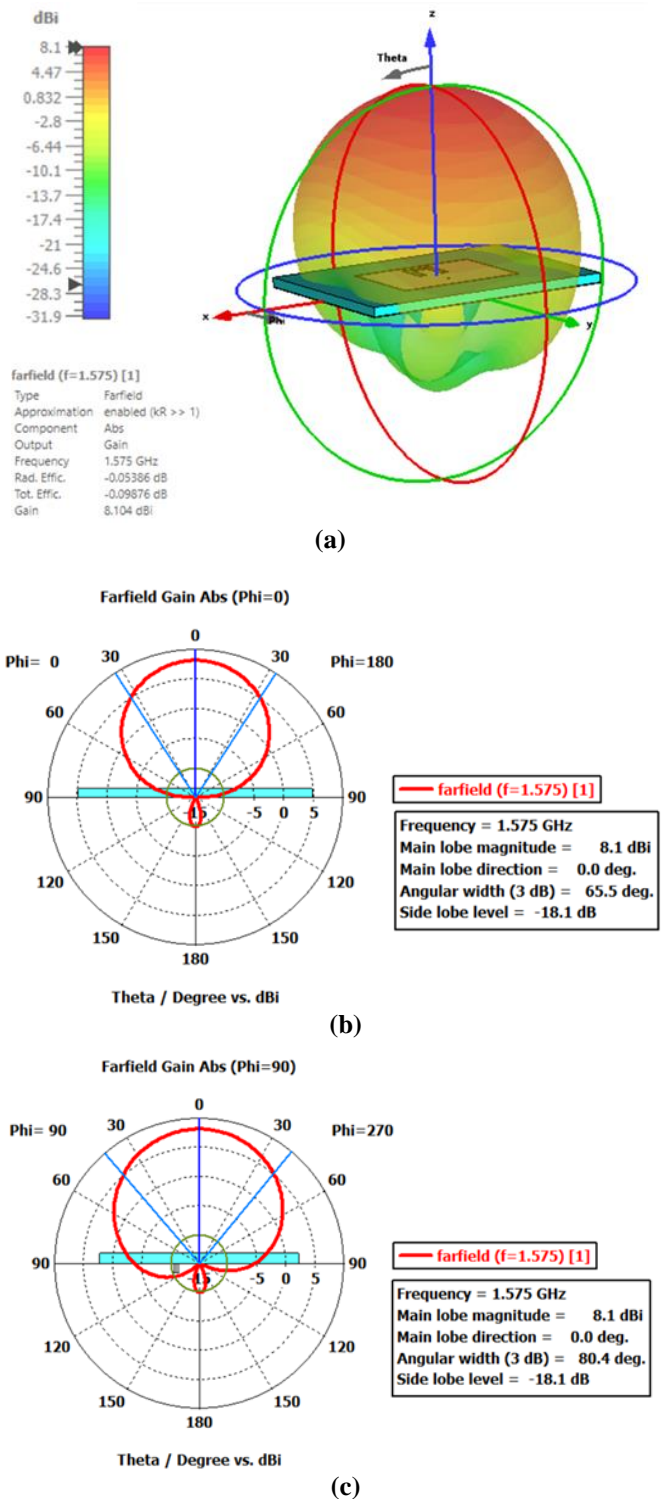


parameters of the designed rectangular U-slot  $\mu$ -strip patch antenna are listed in the middle column of Table I.

Simulation results for the final designed rectangular U-slot  $\mu$ -strip patch antenna are reported in Fig.1 and Fig.2. The reflection coefficient ( $S_{11}$ ) plot of the designed antenna is given in Fig 1b in which we can see that the antenna provides  $S_{11}$  performances at least -10 dB for the frequencies between 1.5466 and 1.6070 GHz. Therefore, one can easily observe that the antenna's operational bandwidth covers the frequency bands of GNSS L1/E1. The radiation pattern simulation results for the designed antenna are shared in Fig. 2. First, the three-dimensional (3D) radiation pattern of the antenna is depicted in Fig. 2a. By looking at the radiation pattern of the antenna, it is observed that the antenna's radiation direction is almost towards to upper hemisphere that is very suitable with the GNSS L1/ E1 applications such as using it as an GPS receiver antenna. A more detailed analysis of the radiation pattern of the designed antenna is given in Fig. 2b and 2c using the two-dimensional (2D) radiation pattern plots in dB scale. The 2D E-plane ( $\phi = 0^\circ$ ) and H-plane ( $\phi = 90^\circ$ ) patterns are plotted with respect to different  $\theta$  angles as plotted in Fig. 2b and Fig. 2c, respectively. These patterns clearly show that this antenna is well directive towards zenith (z) direction with a gain of 8.1 dB. The half-power beam width (HPBW) values of  $65.5^\circ$  and  $80.4^\circ$  for the E-plane ( $\phi = 0^\circ$ ) and H-plane ( $\phi = 90^\circ$ ) patterns are achieved, respectively. Based on these analyses, we can easily conclude that this antenna can be conveniently used for GPS applications with good fidelity as the most of the pattern locates at the upper hemisphere of the antenna.



**Figure 1.** (a) The geometry, and (b) reflection coefficient ( $S_{11}$ ) simulation result for the designed U-slot rectangular patch antenna



**Figure 2.** Radiation pattern of the designed U-slot rectangular patch antenna: (a) 3D pattern, (b) 2D E-plane ( $\theta$ ) pattern at  $\phi = 0^\circ$ , and (c) 2D H-plane ( $\theta$ ) pattern at  $\phi = 90^\circ$

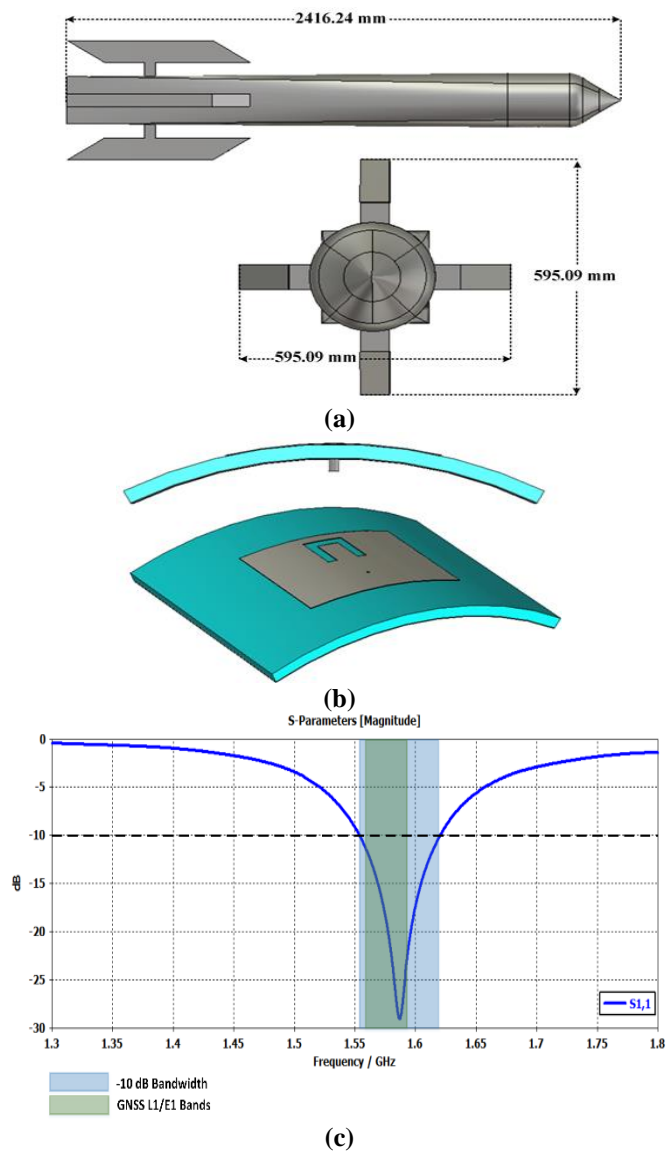
#### 4. Design and Simulation of Conformal U-Slot $\mu$ -Strip Patch Antenna

##### 4.1. Conformal U-Slot $\mu$ -Strip Patch Antenna: Stand Alone

After completing the rectangular, flat design of U-slot rectangular patch antenna, its conformal version is tried by the help of CST. For the conformal version of this antenna, a missile model whose CAD in Fig. 3a was considered to be able

to bend the antenna accordingly. This missile has the size of  $2.4\text{ m} \times 0.6\text{ m} \times 0.6\text{ m}$ .

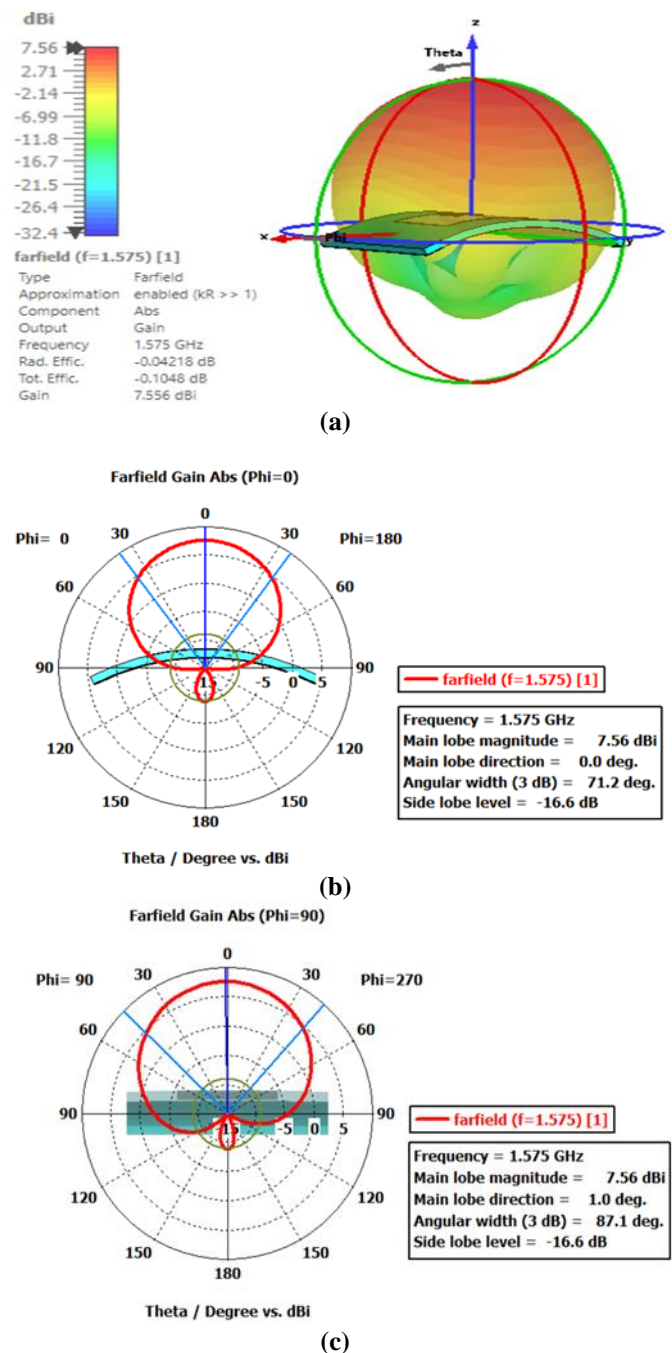
Using the bending tool of the CST, the designed rectangular U-slot  $\mu$ -strip patch antenna has been bent as depicted in Fig. 3b. Then, this antenna has been optimized to be able to such that the antenna dimensions are finalized as listed along the last column of Table I. The simulation of this optimized, final conformal U-slot  $\mu$ -strip patch antenna was accomplished by the help of CST software. The reflection coefficient performance is drawn with respect to frequency as shared in Fig. 3c. By examining this figure, it is obvious that the -10 dB bandwidth of this conformal antenna is 67 MHz ranging from 1.553 and 1.620 GHz that obviously covers the whole GNSS L1/E1 frequency band as illustrated in Fig. 3c.



**Figure 3.** The missile model that the antenna to be put on, (b) the designed conformal antenna after CST optimization, (c) reflection coefficient ( $S_{11}$ ) simulation result for the designed U-slot conformal patch antenna

The radiation pattern simulation results for the designed conformal U-slot  $\mu$ -strip patch antenna are given in Fig. 4. First, the 3D radiation pattern of the antenna is depicted in Fig. 4a. As expected, the directivity of the conformal antenna which was 8.1 dB is a little bit decreased when compared to that of rectangular antenna since the effective antenna aperture has also been reduced. However, the antenna's radiation

direction is again almost towards to upper hemisphere that is well appropriate with the GNSS L1/ E1 usages. A supplementary comprehensive analysis of the radiation pattern of the designed conformal antenna is shared in Fig. 4b and 4c via 2D radiation pattern plots. The 2D E-plane ( $\phi = 0^\circ$ ) and H-plane ( $\phi = 90^\circ$ ) patterns are plotted with respect to different  $\theta$  angles as given in Fig. 4b and Fig. 4c, respectively. These patterns evidently demonstrate that this antenna is healthy directive towards upward direction with a gain of 7.56 dB. The -3B beamwidth performances for E-plane ( $\phi = 0^\circ$ ) and H-plane ( $\phi = 90^\circ$ ) radiation patterns were obtained as  $71.2^\circ$  and  $87.1^\circ$ , respectively. Therefore, these figures successfully claim that this antenna can be suitably used for GNSS L1/ E1 applications.

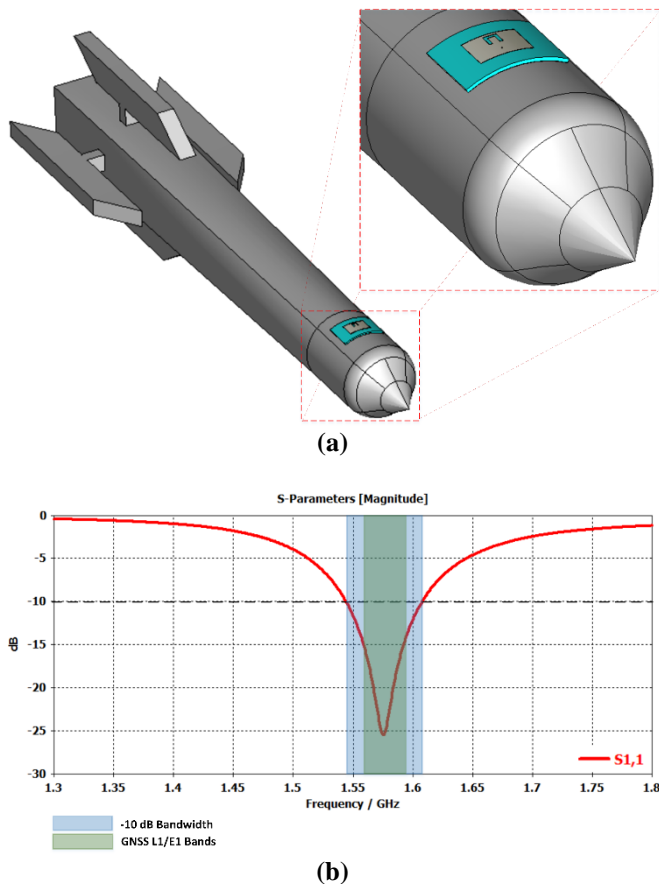


**Figure 4.** Radiation pattern of the designed conformal U-slot patch antenna: (a) 3D pattern, (b) 2D E-plane ( $\theta$ ) pattern at  $\phi = 0^\circ$ , and (c) 2D H-plane ( $\theta$ ) pattern at  $\phi = 90^\circ$

### 4.2. Conformal U-Slot $\mu$ -Strip Patch Antenna on a Missile Model

Once the conformal U-slot  $\mu$ -strip patch antenna design, optimization and simulation has been completed, it is mounted on the missile model as illustrated in Fig. 5a. To do that, the aluminum model has been cut from the region where the antenna was mounted such that the coax feeding is now located in the inner side of the model.

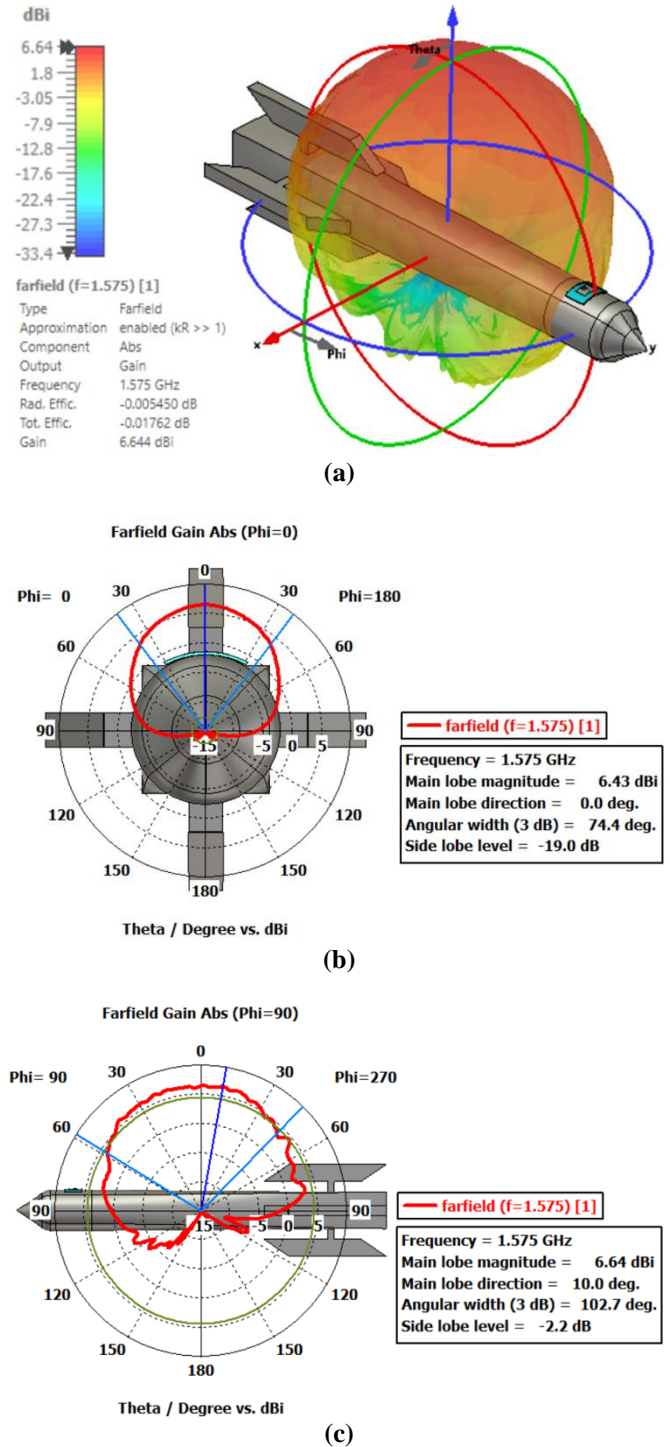
Next, the CST simulation of conformal antenna mounted on the missile model has been completed with the designed antenna dimensions finalized in the previous subsection. Achieved antenna parameters are given in order. First, the reflection coefficient result was obtained as given in Fig. 5b. It is clear from the figure that the -10 dB bandwidth of conformal U-slot  $\mu$ -strip patch antenna mounted on the missile model is 64 MHz ranging from 1.544 and 1.608 GHz. We observe a loss of 3 MHz bandwidth that does not affect the usage of designed antenna for the GNSS L1/E1 applications since the antenna still covers the frequency range between 1559 MHz and 1591 MHz.



**Figure 5.** The conformal antenna mounted on the missile model, (b)  $S_{11}$  simulation result for the conformal antenna mounted on the model

Obtained results for the radiation pattern simulation of the designed conformal U-slot  $\mu$ -strip patch antenna mounted on the missile model are depicted in Fig. 6. First, the 3D radiation pattern of the antenna is depicted in Fig. 6a. By looking at the radiation pattern of the antenna, the pattern is again upward directed suitable for the GNSS L1/E1 applications. The gain of the antenna together with the missile model is found as 6.64 dB that is approximately 0.95 dB lower than that of stand-alone antenna case. Therefore, the effect of the missile platform to the antenna gain is less than 1 dB. 2D E-plane ( $\phi =$

$0^\circ$ ) and H-plane ( $\phi = 90^\circ$ ) antenna radiation patterns are depicted in Fig. 6b and Fig. 6c, respectively. The HPBW results for E-plane ( $\phi = 0^\circ$ ) and H-plane ( $\phi = 90^\circ$ ) radiation patterns were obtained as  $74.4^\circ$  and  $102.7^\circ$ , respectively. Therefore, the main lobes patterns were a little bit widened with a small decreased amount of gain as expected. Based on these frequency bandwidth and radiation pattern analyses, it can be deduced that our conformal U-shaped  $\mu$ -strip patch antenna can be reliably used GNSS L1/E1 practices.



**Figure 6.** Radiation pattern of the designed conformal U-slot patch antenna on top of the missile model: (a) 3D pattern, (b) 2D E-plane ( $\theta$ ) pattern at  $\phi = 0^\circ$ , and (c) 2D H-plane ( $\theta$ ) pattern at  $\phi = 90^\circ$



**Table 1.** Design parameters of rectangular/conformal u-slot  $\mu$ -strip patch antenna

Design Parameters		Rectangular U-slot $\mu$ -strip Patch Antenna (mm)	Conformal U-slot $\mu$ -strip Patch Antenna (mm)
Patch width	$W$	77.15	79.09
Patch length	$L$	55.8	55.03
Ground width	$W_g$	154.3	157.84
Ground length	$L_g$	111.6	110.05
Feed inset from edge	$S_f$	69.24	68.28
Slot width	$W_i$	19.6	20.09
Slot length	$L_i$	20.05	19.77
Slot spacing from edge	$S_s$	5.14	5.07
Slot thickness (horizontal, vertical)	$L_s, W_s$	$W_s = L_s = 4.59$	$W_s = 4.71, L_s = 4.53$
Substrate thickness	$h$	1.5	1.5

## 5. Conclusion

In this paper, we have designed a special conformal U-slot  $\mu$ -strip patch antenna to be used in the L1/E1 frequency band 1563 MHz-1587 MHz and 1559 MHz-1591 MHz, respectively. The dimensions for the rectangular version of the antenna were calculated using theoretical formulas that were specially developed for rectangular U-slot  $\mu$ -strip patch antenna. Then CST software has been utilized using these initial, calculated values of the dimensions to be used during the optimization. Once the rectangular version of the antenna was finalized, its conformal version was designed and optimized thanks to the CST optimization tool. The antenna parameters were reported such that they are in good agreement with the requirements of GNSS L1/E1 applications such as GPS. Finally, the optimized conformal U-slot  $\mu$ -strip patch antenna was put on a metal missile model and its performance was checked. It has been seen from the CST simulation results that the final, optimized antenna has slightly less operational frequency bandwidth compared to that of stand-alone conformal antenna. Such a small reduction of 3 MHz is acceptable and does not exceeds the extremes of GNSS L1/E1 frequency bands. Hence, this antenna can be conveniently and reliably used for the goal range of frequencies with achieving the radiation pattern requirements. This is because of the fact that the operational frequency band of final, optimized conformal antenna ranges from 1544 MHz to 1608 MHz; whereas, the GNSS L1/E1 frequency band is actually inside this band; i.e., from 1559 MHz and 1591 MHz.

## Ethical approval

Not applicable.

## Conflicts of Interest

The authors declare that there is no conflict of interest regarding the publication of this paper.

## References

Balderas, L.I., Reyna, A., Panduro, M.A., Del Rio, C. and Gutiérrez, A.R. (2019). Low-Profile Conformal UWB Antenna for UAV Applications. *IEEE Access*, 7, 127486-127494.

Bhattacharjee, P., Hanumante, V. and Roy, S. (2013). Design of U-Slot Rectangular Patch Antenna for Wireless LAN at 2.45GHz. 9th International Conference on Microwaves, Antenna, Propagation and Remote Sensing 11th – 14th December, Jodhpur, INDIA, 132-135.

Chen, C. and Zheng, H. (2017). Design of a dual-band conformal antenna on a cone surface for missile-borne. In *Proceedings of the 2017 Sixth Asia-Pacific Conference on Antennas and Propagation (APCAP)*, 16–19 October 2017, Xi’an, China, 1–3.

CST Studio Suite, <https://www.3ds.com/products-services/simulia/products/cst-studio-suite/> last verified: 07/01/2023.

Gaetano, D., Ammann, M.J., McEvoy, P., John, M., Keating, L. and Horgan, F. (2012). Proximity study of a conformal UWB directional antenna on water pipe. *Microw. Opt. Technol. Lett.*, 54(8), 1982-1986.

Khalil, H., Rafique, U., Ahmed, M.M., Rahman, S. and Nazar, W. (2019). A Comparative Study of Conformal Antenna Arrays for Aerodynamic Applications. In *Proceedings of the 2019 Photonics & Electromagnetics Research Symposium—Fall (PIERS—Fall)*, 17–20 December 2019, Xiamen, China, 3211–3217.

Khouaja, A., Koubaa, A. and Daly, H.B. (2021). Dielectric properties and thermal stability of cellulose high-density polyethylene bio-based composites. *Industrial Crops and Products*, 171, 113928.

Mishra, P. and Gupta, P. (2015). Compact U-Slotted Dual Band Conformal Microstrip Antenna. *International Journal of Engineering Research & Technology (IJERT)*, 4(12),167-171.

Mitha, T. and Pour, M. (2018). Conformal Wideband Microstrip Patch Antennas on Cylindrical Platforms. *Progress in Electromagnetics Research Letters*, 80, 1-6.

Mondal, S. and Sarkar, P.P. (2014). Design of an ultrawideband conformal metal antenna. *Microw. Opt. Technol. Lett.*, 56(2), 430-434.

Morton, T.E. and Pasala, K.M. (2006). Performance analysis of conformal conical arrays for airborne vehicles. *IEEE Trans. Aerosp. Electron. Syst.*, 42(3), 876–890.

Nikolaou, S., Ponchak, G.E., Papapolymerou, J. and Tentzeris, M.M. (2006). Conformal double exponentially tapered slot antenna (DETTSA) on LCP for UWB applications. *IEEE Trans. Antennas Propag.*, 54(6), 1663-1669.

Obeidat, K., Rojas, R.G. and Raines B. (2009). Design of antenna conformal to V-shaped tail of UAV based on the method of Characteristic Modes. 2009 3rd European Conference on Antennas and Propagation, 23-27 March 2009, Berlin, Germany, 2493-2496.

Ozdemir, C. and Ling, H. (1997). Joint time-frequency interpretation of scattering phenomenology in dielectric-coated wires. *IEEE Transactions on Antennas and Propagation*, 45(8), 1259-1264.

- Pradhan, S. and Gupta, B. (2022). High-Gain Dual-Mode Cylindrical Rectangular Patch Antenna for Airborne Applications. *IEEE Transactions on Aerospace and Electronic Systems*, 58(5), 4168-4179.
- Rani, A. and Dawre, R.K. (2010). Design and Analysis of Rectangular and U slotted Patch for Satellite Communication. *International Journal of Computer Applications*, 12(7), 36-40.
- Tong, C.H.M. (2005). System Study and Design of Broad-band U-slot Microstrip Patch Antennas for Aperiodic Structures and Opportunistic Arrays. Master Thesis, Naval Postgraduate School, Monterey, California, 1-109.
- Weigand, S., Huff, G.H., Pan, K.H. and Bernhard, J.T. (2003). Analysis and design of broad-band single-layer rectangular U-slot microstrip patch antennas. *IEEE Transactions on Antennas and Propagation*, 51(3), 457-468.

---

**Cite this article:** Yilmaz, B. (2023). Design and Simulation of a Conformal Micro-Strip Patch Antenna at GNSS L1/ E1 Frequency Band. *Journal of Aviation*, 7(2), 171-177.



This is an open access article distributed under the terms of the Creative Commons Attribution 4.0 International License

Copyright © 2023 *Journal of Aviation* <https://javsci.com> - <http://dergipark.gov.tr/jav>

## Virtual Training Applications in Aviation BITE Test Application

Yunus Sarıkaya<sup>\*</sup>, Hakan Aydoğan<sup>2</sup>, Faruk Aras<sup>3</sup>

<sup>1\*</sup> Kocaeli University, Faculty of Aeronautics and Space Sciences, Aviation Electrical Electronics, Kocaeli, Türkiye. (yunusrky@gmail.com)

<sup>2</sup> Usak University, Technical Sciences Vocational School, Department of Electric and Energy, Usak, Türkiye. (hakan.aydogan@usak.edu.tr)

<sup>3</sup> Kocaeli University, Faculty of Aeronautics and Space Sciences, Aviation Electrical Electronics, Kocaeli, Türkiye. (faruk.aras@kocaeli.edu.tr)

### Article Info

Received: 24 January 2023

Revised: 06 June 2023

Accepted: 10 June 2023

Published Online: 22 June 2023

### Keywords:

Virtual Education in Aviation

Practical Training

Aviation

MUVE

Corresponding Author: *Yunus Sarıkaya*

### RESEARCH ARTICLE

<https://doi.org/10.30518/jav.1241442>

### Abstract

In this study, the objective is to scientifically examine the usability of multi-user virtual environments as an alternative solution to traditional methods in order to enhance the effectiveness and create widespread opportunities for training applications in aviation, which are difficult and risky to implement on actual aircraft. For this purpose, a virtual environment application was developed, specifically focusing on the examination of Built-In Test Equipment (BITE) test procedures conducted by maintenance personnel during aircraft maintenance. The application included the design of a Multi-Function Control and Display Unit (MCDU) in the virtual environment. The benefits and limitations of the virtual environment application were discussed, highlighting how the challenging and risky working conditions can be efficiently transformed into practical training scenarios in various contexts, promoting the development and reinforcement of skills for personnel. Despite the extensive use of multi-user virtual environments in various fields, it is evident that there is scarce research conducted in the aviation maintenance and repair sector. This study serves as a significant initiative to draw attention to the potential usability of multi-user virtual environments for educational purposes in the aviation maintenance and repair sector.

## 1. Introduction

Adapting to a wide range of technologies and keeping up with the demands of the modern era holds significant importance for individuals. With the advancement of technology, it becomes inevitable for the foundations of education to evolve in certain aspects. Among the various applications in education, the internet has gained a significant role by facilitating the creation and support of learning activities, encompassing a broad spectrum in the field of education (Hill, J.R. Han, S.R.A., 2001). However, web-based education has proven to be insufficient due to its reliance on text, images, and vector graphics, which led to the rapid development of virtual reality technologies that offer high levels of interactivity to users (Özdiñç, F. & Tüzün, H., 2010). The increasing use of computers in today's society, coupled with the expanding digital world and the technological infrastructure supporting it, has prompted a serious consideration of virtual environments in education. Education-focused virtual applications provide users with not only flexibility through 3D visuals but also interactive experiences (Lei, Z. et al., 2021). As internet usage has become more widespread alongside technological advancements, multi-user virtual environments have emerged as three-dimensional online spaces where participants from different fields can interact with each other and computer-generated objects (Dalgarno, B. and Hedberg, J., 2001). These environments

have found significant application in education, offering users the opportunity to engage with others and digital objects in immersive three-dimensional settings (Dede, C. et al., 2005). The growing effectiveness of virtual environments over time has led to companies choosing them for staff training purposes. In addition to advancements in various other fields, virtual environments have become increasingly relevant in the field of education (Kayabaşı, Y., 2005). Virtual applications in education are gaining popularity and becoming more preferable (Winkelmann, K. et al., 2020).

Researchers from METU (Middle East Technical University) have developed a "virtual school" project, as depicted in Figure 1, where participants with avatars can engage in three-dimensional virtual environments for educational purposes (TRT Haber, 2021).



Figure 1. METU Virtual School Project (TRT Haber, 2021)

This article examines the effective implementation of virtual environments in the aviation field, which can be used for personnel training in various domains. The Introduction section of the article discusses research related to the integration of education into virtual environments through technological advancements. The Materials and Methods section focuses on the educational needs in the aviation field and provides an example study and proposed solutions to address these needs. The Result and Discussion section presents the findings of the research and the results obtained from the example study. In the Conclusion section, the importance of the study conducted throughout the article and the expectations for the future are addressed.

In the literature, numerous studies have been conducted to examine the contributions of virtual environments to educational activities. A research conducted by Jones and Warren emphasized that virtual environments offer more reliable and enduring experiences compared to real-world applications (Jones, J. G., & Warren, S. J., 2008). Ibáñez et al. found that three-dimensional virtual environments provide highly immersive experiences in self-directed learning processes (Ibáñez, M.B. et al., 2011). In a study conducted by Davy Tsz Kit Ng during the COVID-19 pandemic, the significant need for aviation educators, who train professionals in the industry, to change their teaching methods in order to facilitate sustainable learning during the pandemic was highlighted (Ng, D.T.K., 2022). Along with the opportunities provided by three-dimensional environments, there can also be challenges such as technical requirements, avatar and usability difficulties, getting lost in the environment, being drawn to the attractiveness of the environment, engaging in inappropriate dialogues, and experiencing attention distractions (Harris, A. L. & Rea, A., 2009).

Thanks to advancements in technology, accessing resources that contribute to individual development has become easier, while also providing a platform for self-directed learning. Parallel to these advancements, progress in software and hardware has laid a foundation for educational applications in three-dimensional virtual environments. Virtual environments offer participants a safe, interactive, and realistic learning experience, allowing them to enhance their skills in complex tasks. Around 80 educational institutions, including Harvard University, utilize three-dimensional virtual environments in their distance learning systems (Bell, L. et al., 2007). In a study by Berge, it was emphasized that when simulation and peer interaction contents are appropriately designed, there is significant potential for education and instruction to take place in multi-user virtual environments (Berge, Z.L., 2008). In a study conducted by Dimitrios et al., the use of virtual educational environments was highlighted to support remote and online learning. Additionally, the participating students reported that virtual environments increased their motivation to learn and provided a more enjoyable experience (Bolkas, D. et al., 2021).

## 2. Materials and Methods

Due to advancing technology and industry demands, the training requirements in the aviation sector are gaining increasing importance. Particularly in the field of maintenance, the reinforcement of theoretical training with practical training takes a considerable amount of time. Performing practical exercises on an aircraft, especially for pilots, is challenging due to limited resources and high costs.

To meet these needs, companies invest significant amounts of money to acquire simulators, ensuring that pilots receive sufficient training. This enables critical situations that pilots may encounter during operations to be simulated, preparing them for safer flights in real-life operations. Moreover, training sessions using simulator applications are also conducted for maintenance personnel, specifically for training in engine startup procedures during the maintenance process.

Indeed, the challenging motor failure scenarios listed below, which are difficult to encounter or practice in real life, can be efficiently conducted through simulation. As a result, potential issues that may arise during engine startup can be experienced and addressed during training sessions.

- Engine failure
- Tailpipe fire
- Engine/APU (Auxiliary Power Unit) fires
- Bird strikes
- Engine/APU startup
- Exposure to rain, snow, hail, storms, sand, or volcanic ash

However, it is not always feasible for maintenance personnel to utilize these simulator systems. Due to the following reasons, alternative solutions have been sought instead of relying solely on simulator systems provided through manufacturers for practical training:

- High costs
- Limitations on the number of participants (typically four individuals per training session)
- Priority usage needs of the flight crew
- Limited availability within specific time frames
- Access issues during maintenance and modification processes

Performing practical training for maintenance personnel on actual aircraft is another solution; however, due to the following factors, practical training in virtual environments has started to be evaluated by organizations:

- Planning
- Suitability of the aircraft
- Disassembly/assembly capabilities
- Impact on ongoing maintenance
- Adverse effects on work processes, etc.

This article aims to scientifically examine the feasibility of alternative solutions introduced to the traditional methods in order to provide maintenance practice training and reinforce acquired knowledge in aviation, where certain maintenance applications are risky to perform on actual aircraft.

For this purpose, a practical study is conducted to explore the applicability of multi-user virtual environments, with a specific focus on Second Life (SL), which is the most commonly used platform among the multi-user environments (Second Life, 2022b) as shown in Figure-2.

Due to its high graphic requirements, SL requires advanced hardware features such as a powerful graphics card and operating system on the user's computer. The minimum computer requirements for SL (version: 6.6.8.576737) on Windows are provided in Table-1 (Second Life, 2022a). Minimum computer requirements for other operating systems can be viewed on the website [www.secondlife.com/system-requirements](http://www.secondlife.com/system-requirements). With advancing technology and new graphic



designs, user computers need to have good performance values. Although the limitations given in the table are sufficient for SL, users, especially those who want to develop products within SL, are advised to prefer computers with next-generation graphics cards. This situation can create a negative perception as it may increase user costs.

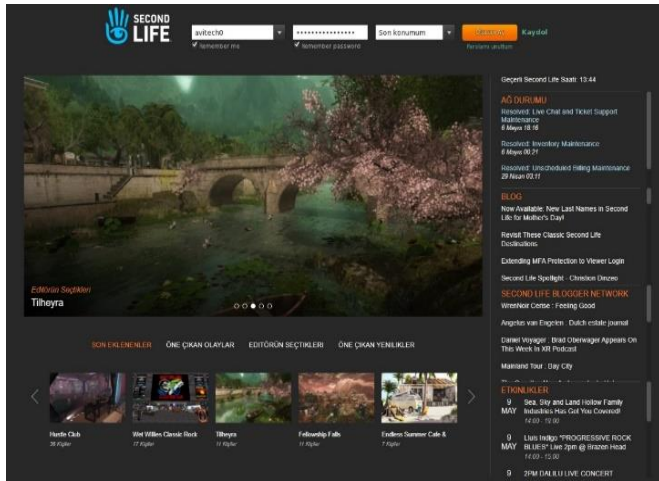


Figure 2. Second Life Main Page (Second Life, 2022b).

Table 1. Minimum computer requirements for SL (Second Life, 2022a)

Windows	Minimum Requirements	Recommended
Internet Connection:	Cable or DSL	Broadband internet connection
Operating System:	Windows® 8 (latest Service Pack)	Windows® 10 or 11 64-bit (latest Service Pack)
Computer Processor:	CPU with SSE2 support, 2 cores	CPU with SSE2 support, 8 cores
Computer Memory:	4 GB	8 GB or more
Screen Resolution:	1024x768 pixels	1920x1080 pixels
Graphics:	OpenGL 3.2	OpenGL 4.6

SL provides the opportunity for product development through a simple three-dimensional design tool, as shown in Figure-3. Users can design the objects they need in three dimensions using the object creation menu shown in Figure-4. They can save previously designed objects to their inventories and reuse them later when needed, as demonstrated in Figure-5 through the inventory menu. If the project requires software control, the necessary software can be implemented using a script, as shown in Figure-6. Linden Scripting Language (LSL) is used for scripting within SL, and examples of how commands are used are provided to guide users in understanding how to use the desired commands. In SL, users are represented as avatars. Therefore, when entering SL, a user avatar should be selected, and a username and password must be determined.

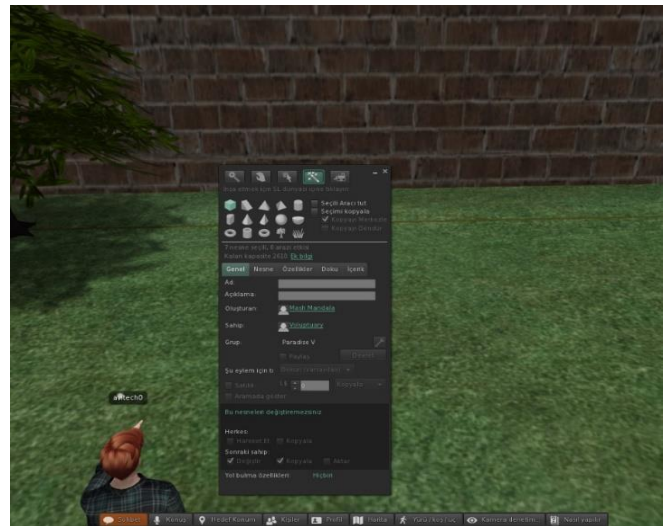


Figure 3. 3D Design Tool

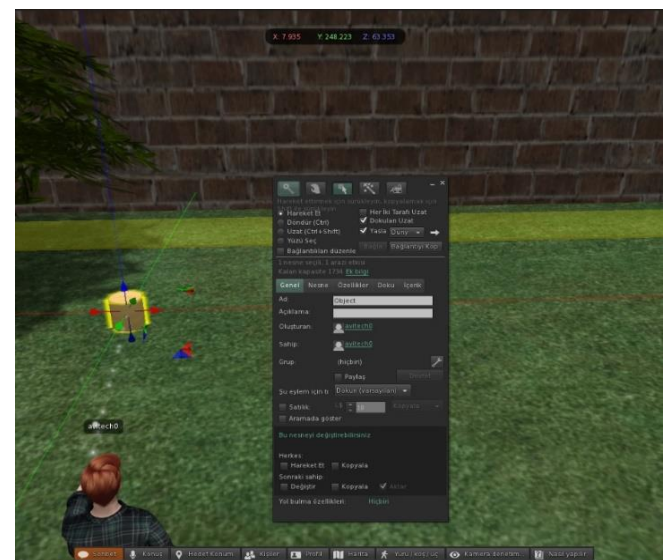


Figure 4. Object Create Menu

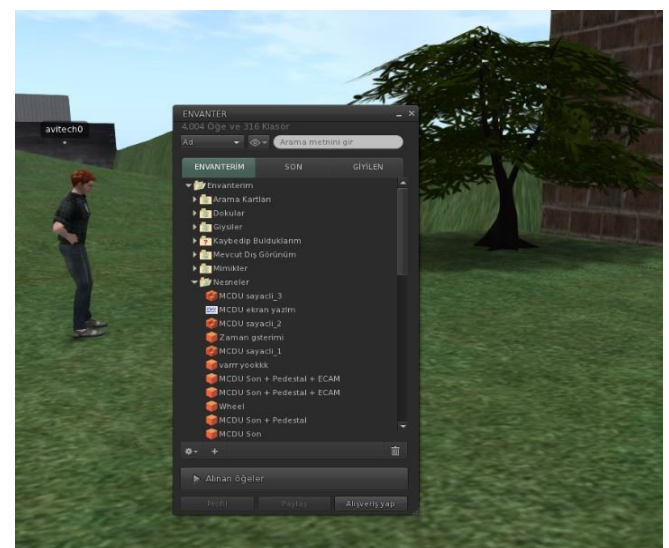


Figure 5. Inventory Menu



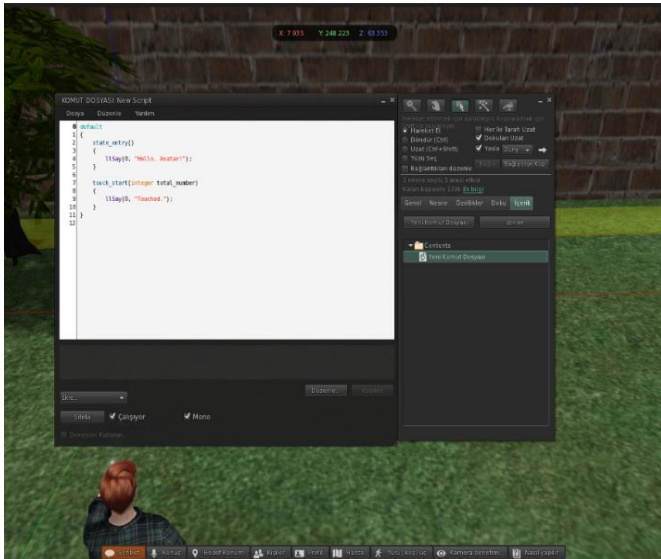


Figure 6. Command File

After troubleshooting and repairing aircraft systems, it is necessary to verify the maintenance work. This verification process is performed through the computer that manages the respective system and is known as Built-In Test Equipment (BITE) test. This validation procedure, which is carried out via a central control unit called Multi-Function Control and Display Unit (MCDU), indicates whether the maintenance has been successfully completed or not. In this study, the Multi-Function Control and Display Unit (MCDU) of the Airbus A320 aircraft and the Slat Flap Control Computers (SFCC), which are wing structures of the aircraft and play a significant role during flight phases, are addressed.

Using the SL application, as shown in Figure-7, a virtual model of the MCDU belonging to the Airbus A320 aircraft has been created, and the BITE test application of the SFCC has been conducted.



Figure 7. 3D A320 MCDU Prepared with SL

During this test, all screen displays have been designed to resemble the real ones. If needed, the user can navigate to any stage of the test or even return to the beginning by pressing the "return" key. Since the test is not performed on an actual aircraft, the maintenance verification results are randomized,

either positive or negative. A positive result indicates that the maintenance procedure has been successfully carried out, while a negative result requires the participant to follow the maintenance manual accordingly. This allows the participant to experience both scenarios during the test.

In the practical training conducted on aircraft or simulator systems obtained from manufacturers, there is a limitation on the number of participants, allowing a maximum of 4 participants to receive training simultaneously. As depicted in Figure-8, this virtual environment work (MCDU) can be replicated and duplicated for multiple users. Since each participant undergoes a different process, they can acquire distinct experiences concurrently. Consequently, training can be conducted without limitations on the number of participants.

However, conducting training on real aircraft entails risks such as prolonged training duration, equipment malfunctions, and potential errors during training. Therefore, virtual environments can be more appealing for businesses. Moreover, since aircraft or hangar environments are not necessarily required for training, more flexible training planning can be achieved. It is believed that creating classes in various selected environments can enhance participants' enthusiasm for training.

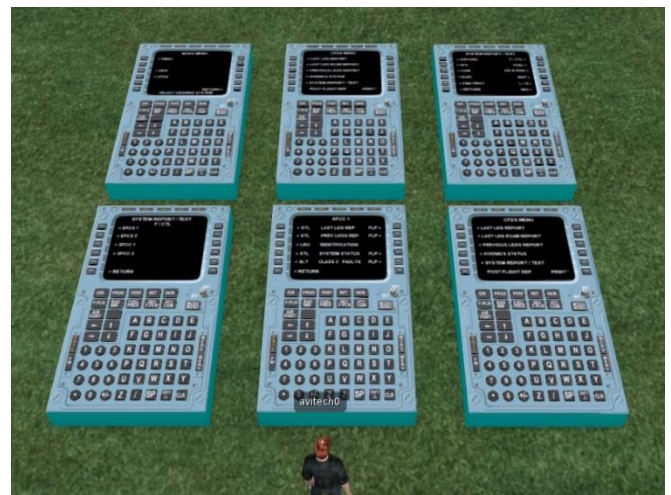


Figure 8. Replicated MCDUs in Virtual Environment

The study was shared with a group of technicians working in the industry, and their opinions were collected. The work was found to be interesting by the users, and positive feedback was received indicating potential for future development and contribution to the industry. However, it was observed that younger employees who are relatively more computer-savvy adapted more easily to the virtual environment, while older individuals with less interest in computers had difficulties in adaptation.

Experiments were conducted with 10 participants in each age group (20-29, 30-39, 40-50) consisting of maintenance technicians, and the results obtained are presented in Table-2. The adaptation score took into account factors such as program entry, control of the avatar, and ability to perform the application. Participant opinions were considered for the categories of efficiency, applicability, and benefits to the industry.

**Table 2.** Participant Evaluations

	Age 20 – 29	Age 30 – 39	Age 40 – 50
Adaptation	10 positive	7 positive 3 negative	4 positive 6 negative
Efficiency	10 positive	8 positive 1 negative 1 neutral	5 positive 3 negative 2 neutral
Applicability	10 positive	8 positive 1 negative 1 neutral	5 positive 3 negative 2 neutral
Benefit Provided	9 positive 1 neutral	8 positive 2 neutral	6 positive 1 negative 3 neutral

This study has demonstrated that advanced designs in virtual environments can provide users with the opportunity to experience numerous scenarios that are difficult and risky to implement in reality, enabling them to gain repeated experience. It has also shown that these virtual environments can serve as an alternative method to traditional learning approaches. However, it should be noted that maintenance application training conducted on real aircraft remains crucial for participants to physically interact with the aircraft and grasp the seriousness of the job.

### 3. Result and Discussion

The conclusions drawn from the research and the conducted study can be listed as follows:

With the advancement of technology and the widespread availability of internet infrastructure, multi-user virtual environments have become extensively utilized in the field of education.

The utilization of multi-user virtual environments in aviation education is an effective method that enables users to gain practical experience and translate their theoretical knowledge into practice.

The ability to repeatedly apply the same scenario makes multi-user virtual environments a preferred choice for reinforcement training.

The ability of virtual environments to be applied independently of time and location allows participants to connect to the system (multi-user virtual environment) through their personal computers from any preferred environment (home, office, café, etc.). This offers opportunities for self-improvement, making it a preferred choice for participants.

The minimum computer requirements necessary for the efficient operation of multi-user virtual environments, along with their high costs and the financial constraints of participants, limit their personal usage.

Individuals with a higher interest in computers find it easier to adapt to virtual environments, while those with less interest require more time to adapt.

The absence of participant limitations in virtual environments allows for the opportunity to provide training to multiple participants simultaneously in aviation maintenance education planning.

### 4. Conclusion

Thanks to the opportunities provided by virtual environments, challenging working conditions can be effectively transformed into practical training scenarios with diverse contexts, facilitating the development and reinforcement of skills for personnel.

The widespread adoption of virtual environments in the aviation industry will help companies reduce costs and enable efficient and relatively easier personnel training.

Conducting practical training in virtual environments instead of real aircraft in aviation maintenance will reduce potential risks.

No matter how successful maintenance application training in virtual environments may be, it cannot completely replace maintenance training conducted on actual aircraft.

This exemplary study and its obtained results demonstrate that practical training required in the maintenance field can be designed in multi-user virtual environments. Consequently, personnel can receive training independently of time and location using their personal computers. Moreover, the training can be reinforced by the participants through the repetition of these exercises.

In the field of aviation maintenance training, the future is expected to witness a greater adoption and implementation of multi-user virtual environments. Through further research and advancements in this area, users will be able to become better-trained and skilled maintenance technicians.

### Ethical approval

Not applicable.

### Conflicts of Interest

The authors declare that there is no conflict of interest regarding the publication of this paper.

### References

- Bell, L., Pope, K., & Peters, T. (2007). Digital libraries on the MUVE: A virtual adventure. *Bulletin of the American Society for Information Science and Technology*, 33(4), 29–29.
- Berge, Z. L. (2008). Multi-User Virtual Environments for Education and Training? A Critical Review of “Second Life.” *Technology*, 48(3), 27–31.
- Bolkas, D., Chiampi, J. D., Fiotti, J., Gaffney, D. (2022). First Assessment Results of Surveying Engineering Labs in Immersive and Interactive Virtual Reality. *Journal of Surveying Engineering*, 148(1), 0733-9453.
- Dalgarno, B. and Hedberg, J. (2001). 3D Learning Environments in Tertiary Education. Meeting at the Crossroads. 18th Annual Conference of the Australasian Society for Computers in Learning in Tertiary Education (ASCILITE), 33–36.
- Dede, C., Clarke, J., Ketelhut, D. J., Nelson, B., & Bowman, C. (2005). Students’ Motivation and Learning of Science in a Multi-User Virtual Environment. 1–8.
- Harris, A. L., & Rea, A. (2009). Web 2.0 and Virtual World Technologies: A Growing Impact on IS Education. *Journal of Information Systems Education*, 20(2), 137–144.
- Hill, J.R. Han, S.R.A. (2001). Build It and They Will Stay: A Research-Based Model for Creating Community in Web-Based Learning Environments. 192–199.

- Ibáñez, M.B. Rueda, J.J.G. Galán, S. Maroto, D. Morillo, D. and Delgado-Kloos, C. (2011). Design and Implementation of a 3D Multi-User Virtual World for Language Learning. *Educational Technology & Society*, 14(4), 2–10.
- Jones, J. G., & Warren, S. J. (2008). Three-Dimensional Computer-Based Online Learning Environments. 911–920.
- Kayabaşı, Y. (2005). Sanal Gerçeklik ve Eğitim Amaçlı Kullanılması. *The Turkish Online Journal of Educational Technology-TOJET*, 4(3), 151–158.
- Lei, Z. Zhou, H. Hu, W. Deng, Q. Zhou, D. Liu, Z.W. Gao, X. (2021). 3-D Interactive Control Laboratory for Classroom Demonstration and Online Experimentation in Engineering Education. *IEEE Transactions on Education*, 64(3), 276-282.
- Ng, D.T.K. (2022). Online lab design for aviation engineering students in higher education: a pilot study. *Interactive Learning Environments*,
- Özdiç, F., & Tüzün, H. (2010). Student Opinions About Three-Dimensional Virtual Orientation Implementation. *4th International Computer Education and Instructional Technologies*, 840–844.
- Second Life. (2022a). Second Life Computer Requirements. <https://www.secondlife.com/system-requirements>
- Second Life. (2022b). Sedond Life Main Page. <https://secondlife.com/>
- TRT Haber. (2021). Sanal Okul Teknolojisi. <https://www.trthaber.com/haber/bilim-teknoloji/turk-arastirmacilardan-metaverse-ile-sanal-okul-teknolojisi-635852.html>
- Winkelmann, K. Keeney-Kennicutt, W. Fowler, D. Macik, M.L. Guarda, P.P. Ahlborn, C.J. (2020). Learning gains and attitudes of students performing chemistry experiments in an immersive virtual world. *Interactive Learning Environments*, 28(5), 620-634.

---

**Cite this article:** Sarikaya, Y. Aydogan, H. Aras, F. (2023). Virtual Training Applications in Aviation BITE Test Application. *Journal of Aviation*, 7(2), 178-183.



This is an open access article distributed under the terms of the Creative Commons Attribution 4.0 International Licence

**Copyright © 2023 Journal of Aviation** <https://javsci.com> - <http://dergipark.gov.tr/jav>



## Innovative Morphing UAV Design and Manufacture

Sezer Çoban<sup>1\*</sup> , Tuğrul Oktay<sup>2</sup> 

<sup>1\*</sup>İskenderun Technical University, Department of Airframe and Powerplant Maintenance, 31200, İskenderun, Hatay, Türkiye. (sezer.coban@iste.edu.tr)

<sup>2</sup>Erciyes University, Aeronautical Engineering, 38030, Kayseri, Türkiye, (tugruloktay52@gmail.com)

### Article Info

Received: 24 February 2023

Revised: 26 May 2023

Accepted: 30 May 2023

Published Online: 22 June 2023

#### Keywords:

UAV

Design

Manufacture

Morphing

Corresponding Author: *Sezer Çoban*

### RESEARCH ARTICLE

<https://doi.org/10.30518/jav.1253901>

### Abstract

In this study, an unmanned aerial vehicle (UAV) with passive pre-flight and active in-flight morphing capability was designed and manufactured. First of all, conceptual design work was done. Wing and tail, which are the main carriers, were selected to ensure maximum lift, minimum drag and stability of the UAV. Liquid fuel engines were preferred due to their high power and airtime. The engine, which enables the controlled and uncontrolled flight of the UAV, has been run-in to make it safer and more efficient before being used in real-time flights. Profiles were selected by analyzing the tail set consisting of the rudder and the elevator. The nose cone of the unmanned aerial vehicle was produced by improving the aerodynamic performance. In the aircraft geometry, the passive morphing mechanism, which is performed once before the flight, and the active morphing mechanism, which is performed continuously during the flight, are manufactured using servo motors. This improved the flight performance and made it possible to fly in some unfavorable conditions. The most basic superior feature of the manufactured UAV from the existing UAVs is its ability to morphing.

### 1. Introduction

In recent years, morphing unmanned aerial vehicles (UAVs) have received significant attention from researchers in the field of aerospace engineering. A number of studies have been conducted to investigate the design and optimization of morphing UAVs. For instance, a study by Harvey et al. (2022) presented a review of the current state of the art in morphing UAV design and control, including various morphable wing structures, actuation systems, and control strategies. Another study by Joshi et al. (2004) proposed a new morphing wing design for UAVs that can change its wing shape in flight to improve aerodynamic performance and stability. Similarly, a study by Thill et al. (2010) focused on the development of a flexible wing structure for UAVs that can change its wing shape to adjust the wing aspect ratio and improve flight efficiency. These studies demonstrate the potential of morphing UAVs to revolutionize the field of aerospace engineering and enhance the performance and versatility of UAVs.

The manufacturing of unmanned aerial vehicles (UAVs) has been the subject of numerous studies in recent years. The challenges and considerations involved in UAV manufacturing have been explored by authors such as (Konar, 2019), who conducted a study on the fabrication and assembly of UAVs. Another study by Sofla et al. (2010) investigated the use of additive manufacturing techniques for the production of lightweight UAV structures. The cost-effectiveness of

different manufacturing processes for UAVs was evaluated by Vocke et al. (2011) in their study. These studies provide insight into the efforts being made to address the challenges associated with UAV manufacturing and to find the most efficient and cost-effective methods for producing UAVs.

Unmanned aerial vehicles (UAVs) have revolutionized the way we gather information and data from the air. Fixed-wing small unmanned aerial vehicles (sUAVs), in particular, have become increasingly popular due to their versatility and ease of use. With their compact size, lightweight design, and long flight times, fixed-wing sUAVs are well-suited for a variety of applications, including environmental monitoring, surveying, and aerial photography (Çoban et al, 2018).

In recent years, advancements in technology have enabled the development of highly advanced fixed-wing sUAVs, equipped with a range of sensors, cameras, and other payloads. These capabilities have enabled fixed-wing sUAVs to gather critical data in a wide range of environments and conditions, from remote, inaccessible areas to urban landscapes (Oktay et al, 2017).

Despite their many advantages, there are still numerous challenges associated with the use of fixed-wing sUAVs, including safety, reliability, and regulatory compliance. As such, there is a growing need for research into the design and development of fixed-wing sUAVs, as well as their applications and limitations (Çoban, 2019).

Morphing wing technology has been widely studied in recent years, with a focus on improving the aerodynamic performance and maneuverability of aircraft. Research in this

area has explored various aspects of morphing wing design and performance, including the optimization of wing shapes, the use of computational fluid dynamics to investigate wing aerodynamics, and the integration of smart materials in wing design and control.

Studies such as Min et al. (2010) have presented research on the morphing wing design and performance optimization, while L Vasista et al. (2012) investigated the effect of wing geometry on wing performance using computational fluid dynamics. The use of smart materials in morphing wing design and control has been examined by Ameduri et al. (2020). A review of recent developments in morphing wing technology was conducted by Popov et al. (2010), highlighting the advances in this field.

The importance of wing analysis for the design and development of high-performing aircraft has been demonstrated in these studies, highlighting the potential of morphing wing technology to enhance aerodynamics and maneuverability (Gomez et al, 2011).

The morphing of the wing and tail in unmanned aerial vehicles (UAVs) can significantly affect the lift and drag forces experienced by the vehicle. By changing the shape of the wing and tail in flight, the aerodynamic performance of the UAV can be improved, resulting in improved lift and reduced drag (Gamboa et al, 2007). The morphing of the wing and tail allows the UAV to adapt to changing flight conditions and optimize its aerodynamics in real-time. For example, the wing and tail can be adjusted to increase lift during takeoff and landing, and to reduce drag during cruising flight. This results in improved efficiency, maneuverability, and stability for the UAV (Konar, 2020). Computational fluid dynamics simulations and wind tunnel experiments have been conducted to investigate the effect of wing and tail morphing on lift and drag in UAVs. The results of these studies have shown that the morphing of the wing and tail can significantly improve the aerodynamic performance of UAVs, leading to increased lift and reduced drag. (Friswell, et al, 2006).

## 2. Materials and Methods

### 2.1. Airfoil selection

Taking into account the ease of fabrication and easy access to the data, NACA 2415 series fin structures were chosen for the design and production of the wing, which is the main carrier element, and the horizontal tail, which is the stability and control surface. The variation of the lift and drag coefficients of the NACA 2415 series airfoil structures with the angle of attack (AoA) was obtained in figure 1 using the XFLR5 program. The graphic results showing the variation of pitching moment with angle of attack and the variation of lift coefficient and drag coefficient are also given in figure 3.  $4^{\circ}$  AoA is the angle of attack at which maximum efficiency is achieved. Analyzes were performed at a speed of 0.05 M (54 km/h = 15 m/s) at Re number 280000.

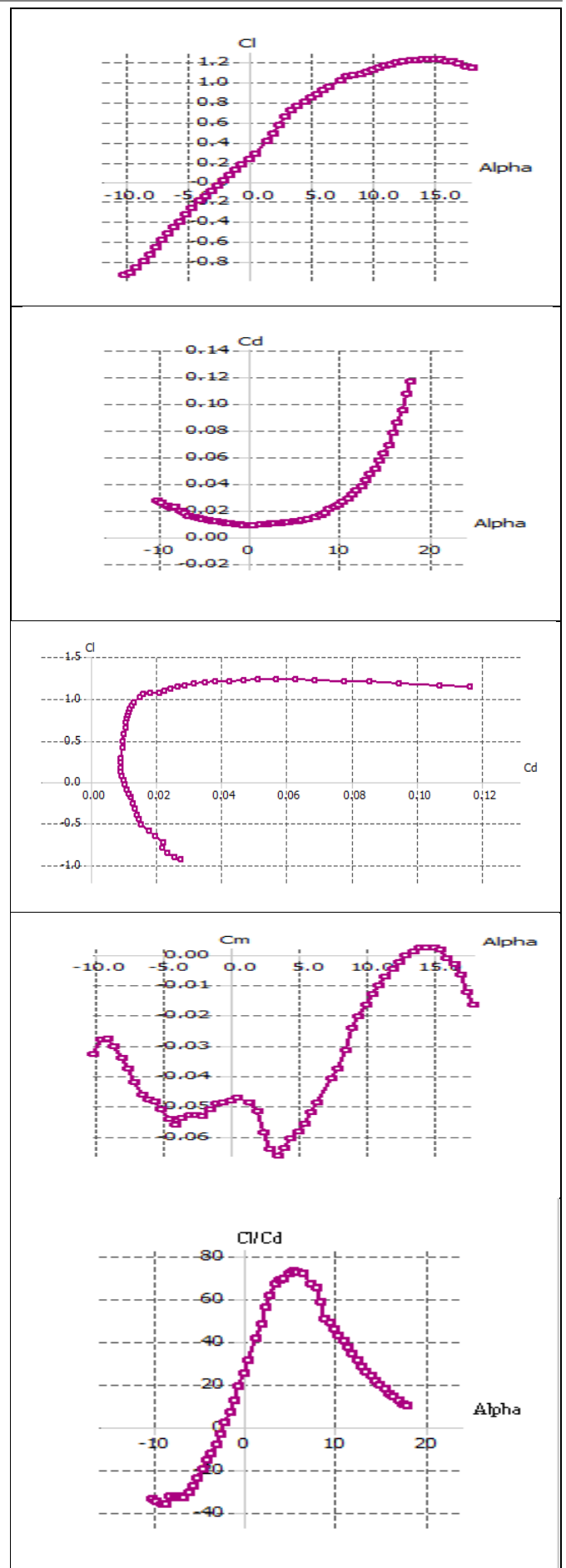


Figure 1. The variation of the lift and drag coefficients of the NACA 2415 series airfoil structures with the AoA

### 2.2. Airfoil Analysis

The wingspan of the UAV is 4000 mm. Rectangular blade structure has been chosen for easy production and the blade cord length is 400 mm. The wing can morph up to 10%. The solid model of the selected airfoil NACA 2415 is given in figure 2.

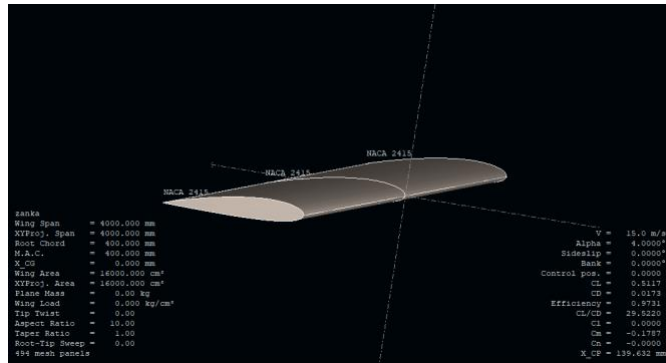


Figure 2. Solid model of wing profil

The force analysis results of the selected airfoil are given in figure 3.

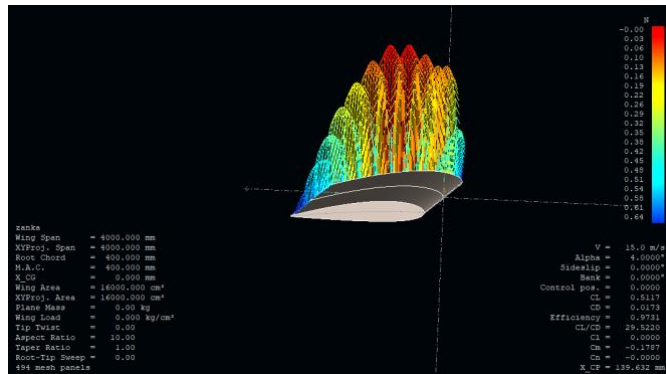


Figure 3. Wing force analysis

### 2.3. UAV Passive and Active Morphing Mechanism Manufacture Stages

Necessary wing section drawing was made. The necessary production drawing for the forward-backward (passive) morphing of the wing was made. A profile drawing was made for the active morphing of the extended wing. As a result of the drawings, the wing section was cut on the balsa with laser cutting. The production drawing required for the back and forth morphing of the wing was cut on the control plate with laser cutting. The metamorphosed wing was constructed from styrofoam material using hot wire. The necessary mechanical equipment was installed to attach the wing back and forth morphing to the fuselage. The alternating elongated wing was covered with composite. The necessary movement mechanism for the alternating elongated wing was installed. The necessary electronics for the metamorphosed elongated wing were installed. The battery system required for the electronics of the metamorphosed elongated wing was installed.

### 2.4. UAV Power Group Preference

Liquid fuel engine was preferred due to its high power and airtime. Plastic and wooden propellers were preferred considering the factors of being widespread and easy to obtain. Propellers suitable for the engine were preferred. An external receiver battery was preferred to feed the control receiver. Due

to the high current and charging time, the lipo battery was preferred. For the control of UAV and morphing system, a fourteen-channel model controller was preferred. High speed and torque digital servo was preferred. The ignition system suitable for the engine was preferred. High power power box was preferred for power group control. Fuel system suitable for engine and fuel was preferred.

### 2.3. UAV Manufacturing Stages

The profiles that formed the structure of the wing of the unmanned aerial vehicle were drawn using the CAD program. The wing profiles created with the help of CAD program were transferred to program to be cut on the CNC machine. First of all, styrofoam in suitable sizes was adjusted for the wing cutting of the UAV. Styrofoam was meticulously placed under the hot wire of the cutting table. After that, the wing profiles drawn in Auto CAD were cut with a CNC machine ,as shown in Figure 4.



Figure 4. Obtaining the wing of the UAV from the CNC machine

After the profiles of UAV were cut on the CNC machine, the profiles cut on the cutting machine were freed from unnecessary parts. Border drawings were made in accordance with the lateral surface dimensions of the profiles. The drawings were cut on plywood with laser cutting. Plywood cut borders were glued to the side surfaces of the cut profiles with the help of epoxy. In order to ensure the smoothness of the new piece, the outer surfaces were carefully sanded and made ready for placement on carbon pipes.



Figure 5. Threading the profiles of UAV into carbon pipes

The measurements of the gaps on the leading edge of the wing were taken. In the light of these dimensions, a leading edge drawing was made to complete the profile. Appropriately sized styrofoams were selected. The parts drawn in the



computer program were cut on the selected styrofoam. Sanding was done to ensure the smoothness of the cut parts.

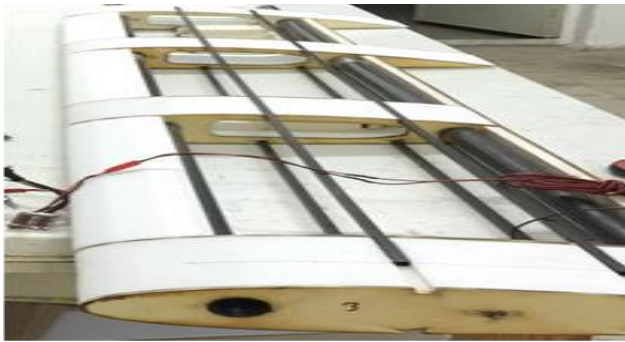


Figure 6. Conformity check and fixation

The nerves of the moving part of the morphing mechanism at the wing tip were aligned with the help of carbon pipes. Aligned nerves were glued with epoxy. Then the carbon pipes were fixed with epoxy. As in figure 7, suitable points were selected and holes were drilled for the mounting of the moving parts of the morphing mechanism to the wing profile. Movement mechanism parts that could move freely in the drilled holes were mounted. A healthy and continuous course of movement was observed.



Figure 7. Installation of the morphing mechanism on the UAV

The morphing mechanism profile was placed on the tested mechanism, as in Figure 8. The movement of the profile was carried out on the assembly. A healthy opening and closing movement was observed.



Figure 8. Installation of morphing mechanism on UAV

The profile with the trailing edge banded was coated as in figure 9 and made ready to form a fiber mold. In this way, the adhesion of the fiber fabric, which was adhered with epoxy, to the profile surface was prevented. The coated profile was re-coated with a separate coating that is more resistant to epoxy. An appropriate amount of fiber fabric was cut for the profile prepared for the fiber coating.



Figure 9. Coating

Appropriately sized slots were made on the wing to place the servos as in figure 10. The locations of the screws required to fix the servos on the blade were determined and marked. Holes were drilled in the marked areas with the help of a drill. Appropriate sized screws were inserted into the drilled holes. Thanks to these screws, the servos placed in the slots were fixed on the wing.

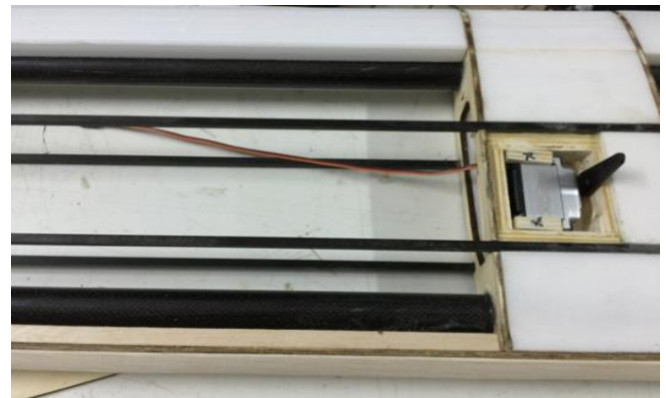


Figure 10. Adding servo motor to the wing

The drawings of the skeleton parts that formed the fuselage were made in a computer program. The parts whose drawings were made were cut with laser cutting. By gluing the appropriate parts together, the fuselage skeleton began to be formed as in figure 11. The epoxy applied parts were compressed with hinges to ensure the strength of the bonding. While the glued parts were left to dry, the nose and tail of the fuselage were glued separately. After the tail part was combined, it was glued to the fuselage skeleton. After the tail part was glued, the nose part was glued to complete the fuselage skeleton and left to dry.

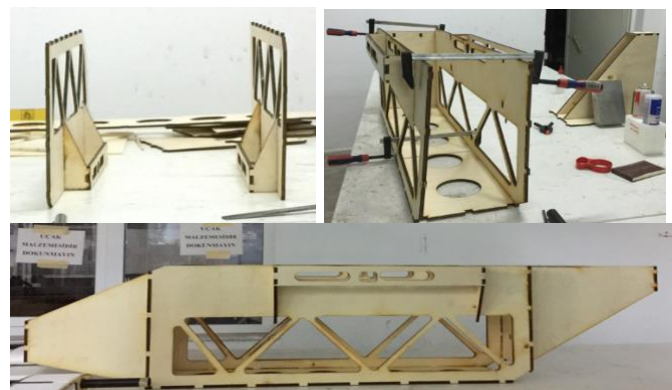


Figure 11. Fuselage Manufacturing

The fuselage size was taken for the foam coating that formed the outer surface of the fuselage. Drawings were made in a computer program in line with these dimensions. The

drawing was made concrete by cutting it on the CNC machine. The cut parts were tried on the fuselage. Inappropriate areas were sanded to ensure full compliance. The same process was applied for all foam parts, and they were made ready to be glued as in figure 12. After ensuring the integrity of the parts, they were glued and fixed on the fuselage. The open areas on the upper surface were covered with plywood cut in accordance with.



Figure 12. Covering the fuselage with foam

Balsas of suitable sizes were cut for the coating of the airfoil skeleton, the internal structure of which was completed. The cut pieces were glued onto the wing profile skeleton and covered. The newly created surface was sanded and smoothed. After the wing skeleton was covered with balsa, the fiber piece completing the morphing mechanism, which was cut in appropriate sizes, was mounted on the balsa at the tip with small screws, as in figure 13. It was observed that the moving part, which went in and out of its interior, worked easily after this region was mounted. After the necessary joints were made, the wing was remounted on the fuselage.



Figure 13. Wing - Body Assembly

In order not to disturb the aerodynamics of the engine of the UAV, it was deemed appropriate to place it behind the fuselage.



Figure 14. UAV engine mount

The final version of the UAV with nose wheel landing gear is shown in Figure 15 after production.



Figure 15. The final version of the UAV

### 3. Results and Discussion

Wingtip morphing, that is, passive morphing, enables UAVs to have higher maneuverability. The movement of the wingtip control surfaces makes it easier to perform maneuvers such as quick turns, tight bends and more precise flight controls. Wingtip morphing reduces wingtip drag and improves aerodynamic efficiency. Control surfaces reduce the effects of wingtip vortices in flight and help the wings produce lift more effectively. Wing tip morphing increases the flight stability of UAVs. Thanks to the movement of the control surfaces, the imbalances that may occur during the flight can be corrected and stability can be achieved. This provides a more controlled and safe flying experience. Wingtip morphing can improve the performance of UAVs in high speed flight. The movement of the control surfaces can reduce the overloads that can occur at high speeds and help the blades direct the airflow more effectively. Increasing the wing's area provides the possibility to produce greater lift and have greater load carrying capacity. The large wing area allows the UAV to carry heavier loads and fly more stably over long distances. Reducing the area of the wing allows the UAV to experience less resistance at high speeds. The small wing area reduces air resistance and allows the UAV to reach higher speeds. This allows the UAV to operate more effectively and efficiently in missions that require speed.

The wing's reciprocating motion, or active morphing, provides speed and lift control during flight. The wing's backward movement reduces lift with increasing speed, while its forward movement produces additional lift when speed decreases. In this way, the UAV can provide an optimized lift at different speeds and flight situations. The wing's ability to move back and forth enables the UAV to be effective over a wider speed range. You can fly at higher speeds with forward motion, while better control can be achieved at lower speeds with reverse motion. This allows the UAV to gain flexibility in various missions and adapt to different speed requirements. The wings that can move back and forth increase the maneuverability of the UAV. Especially during turns and bends, faster and sharper maneuvers can be made by changing the position of the wing. This ensures that the UAV can be controlled more precisely and display more dynamic flight performance. The back and forth movement of the wing increases the flight stability of the UAV. The backward movement of the wing increases stability, helping the UAV to fly smoothly and controllably. It also provides stable flight by changing the position of the control surfaces and corrects any instability that may occur during flight.

### 4. Conclusion

Passive morphing can be briefly defined as minor physical



changes in aircraft geometry, performed once prior to flight, aimed at optimizing flight performance. Why do we change the location of the component with a certain position only once before the flight? If the wing and tail were fixed in the longitudinal axis and other axes, after the payload is placed, due to the change in the center of gravity, more or less ballast load must be added depending on the situation. This will cause an increase in the total weight and will affect performance parameters such as energy consumption, maximum range, airtime, maximum ceiling, maximum speed more or less negatively. Placing the aerodynamic center of the wing slightly in front of the aircraft's center of gravity instead of using the ballast load easily eliminates the negative situation that the ballast load will create.

Active morphing can be briefly defined as small physical changes in aircraft geometry that are continuously made during flight, aimed at optimizing flight performance. Instead of adding such a complex mechanism, why not fly an aircraft with a long wing and horizontal tail? First of all, it should be known that active morphing is a very good backup system in unexpected situations. It is a known situation that there are limits on the wing length as well. As an example, the width of the runway may not allow it in some cases, as well as for other reasons such as increase in drag force, negative impact on aerodynamic fines, increase in fuel consumption, decrease in airtime.

#### Ethical approval

Not applicable.

#### Conflicts of Interest

The authors declare that there is no conflict of interest regarding the publication of this paper.

#### Acknowledgement

This work was supported by Research Fund of The Scientific and Technological Research Council of Turkey (TUBITAK) under Project Number: 115M603.

#### References

Ameduri, S., & Concilio, A. (2020). Morphing wings review: aims, challenges, and current open issues of a technology. *Proceedings of the Institution of Mechanical Engineers, Part C: Journal of Mechanical Engineering Science*, 0954406220944423.

Çoban, S. (2019). Simultaneous tailplane of small UAV and autopilot system design. *Aircraft Engineering and Aerospace Technology*.

Çoban, S., & Oktay, T. (2018). Simultaneous Design of a Small UAV (Unmanned Aerial Vehicle) Flight Control System and Lateral State Space Model. *Journal of Aviation*, 2(2), 70-76.

Friswell, M. I., & Inman, D. J. (2006, April). Morphing concepts for UAVs. In 21st Bristol UAV systems conference (pp. 13-1).

Gamboa, P., Aleixo, P., Vale, J., Lau, F., & Suleman, A. (2007). Design and testing of a morphing wing for an experimental UAV. University of beira interior covilha (portugal).

Gomez, J. C., & Garcia, E. (2011). Morphing unmanned aerial vehicles. *Smart Materials and Structures*, 20(10), 103001.

Harvey, C., Gamble, L. L., Bolander, C. R., Hunsaker, D. F., Joo, J. J., & Inman, D. J. (2022). A review of avian-inspired morphing for UAV flight control. *Progress in Aerospace Sciences*, 132, 100825.

Joshi, S., Tidwell, Z., Crossley, W., & Ramakrishnan, S. (2004). Comparison of morphing wing strategies based upon aircraft performance impacts. In 45th AIAA/ASME/ASCE/AHS/ASC structures, structural dynamics & materials conference (p. 1722).

Konar, M. (2019). Redesign of morphing UAV's winglet using DS algorithm based ANFIS model. *Aircraft Engineering and Aerospace Technology*, 91(9), 1214-1222.

Konar, M. (2020). Simultaneous determination of maximum acceleration and endurance of morphing UAV with ABC algorithm-based model. *Aircraft Engineering and Aerospace Technology*.

Min, Z., Kien, V. K., & Richard, L. J. (2010). Aircraft morphing wing concepts with radical geometry change. *The IES Journal Part A: Civil & Structural Engineering*, 3(3), 188-195.

Oktay, T., & Coban, S. (2017). Lateral autonomous performance maximization of tactical unmanned aerial vehicles by integrated passive and active morphing. *International Journal of Advanced Research in Engineering*, 3(1), 1-5.

Önal, M., Çoban, S., Yapici, A., & Bilgiç, H. H. (2019). Araştırma Makalesi/Research Article DOI: 10.30518/jav. 633775. *Journal of Aviation*, 3(2), 106-112.

Popov, A. V., Grigorie, T. L., Botez, R. M., Mébarki, Y., & Mamou, M. (2010). Modeling and testing of a morphing wing in open-loop architecture. *Journal of Aircraft*, 47(3), 917-923.

Sofla, A. Y. N., Meguid, S. A., Tan, K. T., & Yeo, W. K. (2010). Shape morphing of aircraft wing: Status and challenges. *Materials & Design*, 31(3), 1284-1292.

Thill, C., Etches, J. A., Bond, I. P., Potter, K. D., & Weaver, P. M. (2010). Composite corrugated structures for morphing wing skin applications. *Smart Materials and Structures*, 19(12), 124009.

Uzun, M., & Çoban, S. (2021). Aerodynamic Performance Improvement with Morphing Winglet Design. *Journal of Aviation*, 5(1), 16-21.

Uzun, M., Özdemir, M., Yıldırım, Ç. V., & Çoban, S. (2022). A novel biomimetic wing design and optimizing aerodynamic performance. *Journal of Aviation*, 6(1), 12-25.

Vasista, S., Tong, L., & Wong, K. C. (2012). Realization of morphing wings: a multidisciplinary challenge. *Journal of aircraft*, 49(1), 11-28.

Vocke III, R. D., Kothera, C. S., Woods, B. K., & Wereley, N. M. (2011). Development and testing of a span-extending morphing wing. *Journal of Intelligent Material Systems and Structures*, 22(9), 879-890.

**Cite this article:** Coban, S., Oktay, T. (2023). Innovative Morphing UAV Design and Manufacture. *Journal of Aviation*, 7(2), 184-189.



This is an open access article distributed under the terms of the Creative Commons Attribution 4.0 International Licence

**Copyright © 2023 Journal of Aviation** <https://javsci.com> - <http://dergipark.gov.tr/jav>

# Investigation of Dry Sliding Wear Behavior of CFRP Composite Used in New Generation Aircraft Wings

M. Sabri Gök<sup>1</sup> , Yılmaz Küçük<sup>1</sup> , Murat Pehlivanlı<sup>2</sup>  and Azmi Erdoğan<sup>3\*</sup> 

<sup>1</sup>Bartın University, Faculty of Engineering, Architecture and Design, Mechanical Engineering, Bartın, Türkiye. (msabrigok@bartin.edu.tr, ykucuk@bartin.edu.tr).

<sup>2</sup>Bartın University, Graduate School of Education, Department of Mechanical Engineering, Bartın, Türkiye (mpehlivanli@tai.com.tr).

<sup>3\*</sup>Bartın University, Faculty of Engineering, Architecture and Design, Metallurgical and Materials Engineering, Bartın, Türkiye. (aerdogan@bartin.edu.tr).

## Article Info

Received: 29 April 2023  
Revised: 30 May 2023  
Accepted: 06 June 2023  
Published Online: 30 June 2023

### Keywords:

CFRP  
Dry-sliding wear  
Laying angle  
Composite

Corresponding Author: Azmi Erdoğan

## RESEARCH ARTICLE

<https://doi.org/10.30518/jav.1253901>

## Abstract

In this study, it is aimed to examine the effect of reinforcement laying angle on wear resistance of CFRP composites used in the automotive and aerospace industries. Experiments were carried out on Ball-On-Disc wear device under 1, 3 and 5 N loads at room temperature. 3D optical microscope was used to determine the volume losses in the samples. The worn surface morphology of the samples was examined with the help of SEM (Scanning Electron Microscopy). In the test results, the volume losses of the samples increased depending on the increasing loads and shear rate. It has been understood that the change of the laying angle is important in the dry-sliding resistance of the samples. The wear resistance of the samples produced with 45 degree laying was better at both sliding speeds and all loads. It has also been understood that the laying angle is also effective in the coefficient of friction. Delamination, plastic deformation type dominant wear mechanisms have occurred.

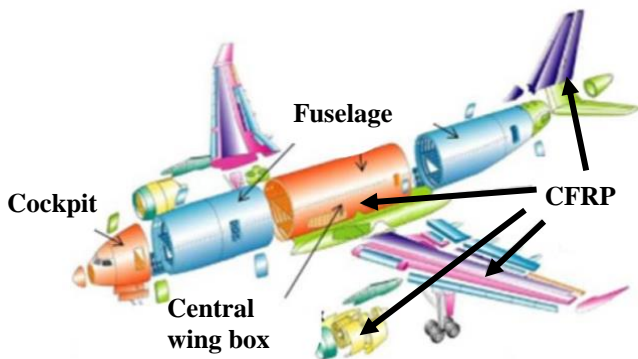
## 1. Introduction

Researchers are constantly working to make human life more comfortable and to extend the life of the materials used. Therefore, existing materials are constantly being improved and replaced with smart and innovative materials. Due to their low cost, ease of manufacture and lightness, polymeric composites replace traditional materials such as metals and ceramics. In this way, innovative materials are created by taking advantage of the synergistic effect in the content of the composite material (Hamamcı et al., 2018; Kursuncu et al., 2020). A polymer is a large molecule (macromolecules) made up of repeating structural units. These subunits are typically linked by covalent chemical bonds (Kulkarni et al., 2012). Polymers and their composites may exhibit some properties that cannot be obtained or are difficult to obtain in metal and ceramic materials (Boztoprak and Kartal, 2019; Erdogan et al., 2021). Polymers and polymer composites are widely used in various tribological applications such as rollers, gears and dry plain bearings due to their inherent advantages such as high specific strength, corrosion resistance and self-lubricating behavior. It is widely accepted that the tribological performance of polymeric materials can be improved by using various fillers or reinforcing fibers (Man et al., 2021). Polymer matrix composites can be used in oil-free dry sliding applications due to their low friction, high durability and good solvent resistance properties (Erdogan et al., 2021).

Generally, the mechanical properties of polymers are insufficient for many structural purposes. Since their hardness and strength are low compared to metals and ceramics, their usage areas are limited. These disadvantages can be eliminated by adding additives to polymers (Karthik et al., 2020; Polanec et al., 2021). It is possible to produce polymer matrix composites using different types of reinforcing materials. The nature of the reinforcement directly affects the final physical and mechanical properties of the composite. With reinforcements, properties such as hardness, strength and thermal expansion of the polymer matrix can be improved. In addition, thanks to the superior tribological properties of the polymer matrix such as high wear resistance, self-lubrication, vibration and corrosion resistance, the use of composite materials in wear parts is constantly expanding. In addition to these features, they are preferred due to their recyclability, ease of production and low cost (Erdoğan et al., 2019; Kursuncu et al., 2020).

Since polymer composite materials exhibit high specific strength and hardness compared to monolithic metal alloys, they have attracted wide attention in various engineering fields, especially in aerospace applications (Çakır and Berberoğlu, 2018; Kessler, 2012; Sari and Sinmazçelik, 2007). Typically, composites consist of a matrix and a reinforcing element. While the reinforcing element serves to carry the load, the matrix serves as a load transfer tool between the reinforcements (Ateş and Aztekin, 2011; Jesson and Watts, 2012; Koç and Demirel, 2019). The matrix is more ductile than

the reinforcing elements and therefore the reinforcing agent is often used as a strength enhancer. When the matrix and the reinforcement are combined efficiently, the resulting material can show very high strengths. In addition to their structural properties, composites are used in electrical, thermal and environmental applications (Karthik et al., 2020). In addition, the equipment required for the production of polymer matrix composites is simpler. Therefore, polymer matrix composites developed gradually and soon became popular for structural applications (Karthik et al., 2020).



**Figure 1.** CFRP and other composite parts used in an aircraft (Mohamed, 2013).

Polymer matrix composites are the most widely used composite type on the market, and the two main application sectors (by value) are the automotive industry (over 30%) and the aerospace industry (over 20%) (Thomas et al., 2014). An example of a CFRP composite used in any aircraft is given in Figure 1. Apart from this, it is possible to see CFRP composite in many parts used in assembly (Mohamed, 2013). Carbon fiber reinforced polymers (CFRP) are characterized by exceptional specific strength and stiffness properties that make them particularly suitable for lightweight structures in the aerospace industry (Kumar et al., 2021; Kuo et al., 2018; Seeholzer et al., 2021). In this study, the dry-sliding wear behavior of CFRP composite material produced at different laying angles was investigated. It has been tried to understand how the laying angle has an effect on the wear behavior of the sample.

**2. Materials and Methods**

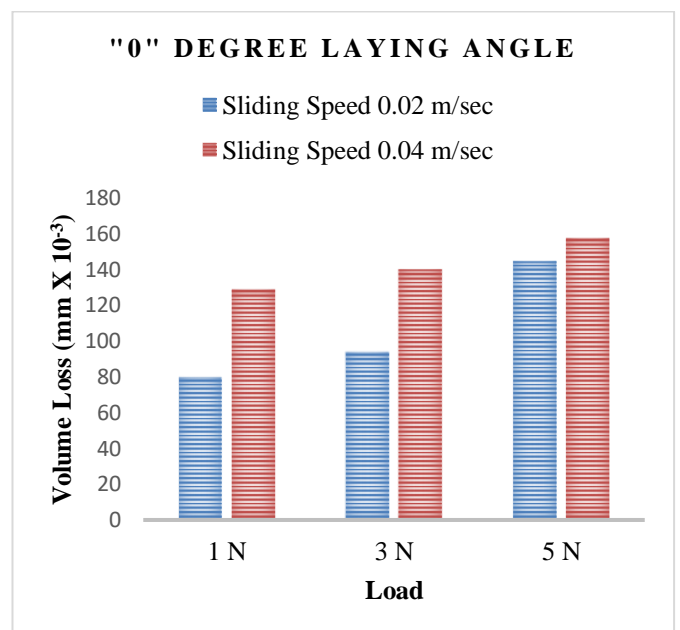
Composite materials were produced in the form of plates by hand-laying method. The production process was carried out using two different laying angles, “45” degrees and “0” degrees. CFRP composite specimens were produced with a width of 25 mm and a thickness of 5 mm. Reciprocating type dry-sliding wear tests were performed at room temperature using a 6 mm diameter Al<sub>2</sub>O<sub>3</sub> ball using a Ball-on-disc tribometer device (TURKYUS POD). The hardness of Al<sub>2</sub>O<sub>3</sub> balls used in the experiments is 15 GPa. Wear tests were carried out under loads of 1, 3 and 5 N. Another variable used in the tests is the sliding speed and it was applied as 0.02 m/sec and 0.04 m/sec for a total of 15 minutes. Total sliding distance is 18-36 m and wear stroke length is 5.5 mm. In order to increase the accuracy and validity of the results obtained from the experiments, each experiment was performed 3 times and average values were taken. After the wear tests, the volume losses of the samples were determined by taking a 3D

profilometer image from the formed wear trace section. Cross-sectional images were taken from at least 4 parts of the groove formed by the abrasive ball on the sample, and their average value was used in the volume loss calculation. The images of the worn surfaces of the samples were taken on the TESCAN MAIA3 XMU brand SEM device.

**3. Result and Discussion**

Composites produced as polymeric materials and polymer matrix are used successfully in many applications. As in metallic materials, important parameters emerge in wear resistance depending on the material, counter surface, environment and operating conditions in polymer-based materials. In Figure 2, the volume loss values occurring in the sample produced with “0” degree laying angle, which was subjected to wear test at different sliding speeds and under three different loads, are given. There is an increase in the volume losses of the samples depending on both the load and the sliding speed. However, it is seen that this increase is not directly proportional in terms of applied wear load. It is possible to explain the increase in volume loss in the sample due to the increasing load simply by using the term hardness. Hardness can be defined as the resistance of a material against another material trying to sink from its surface.

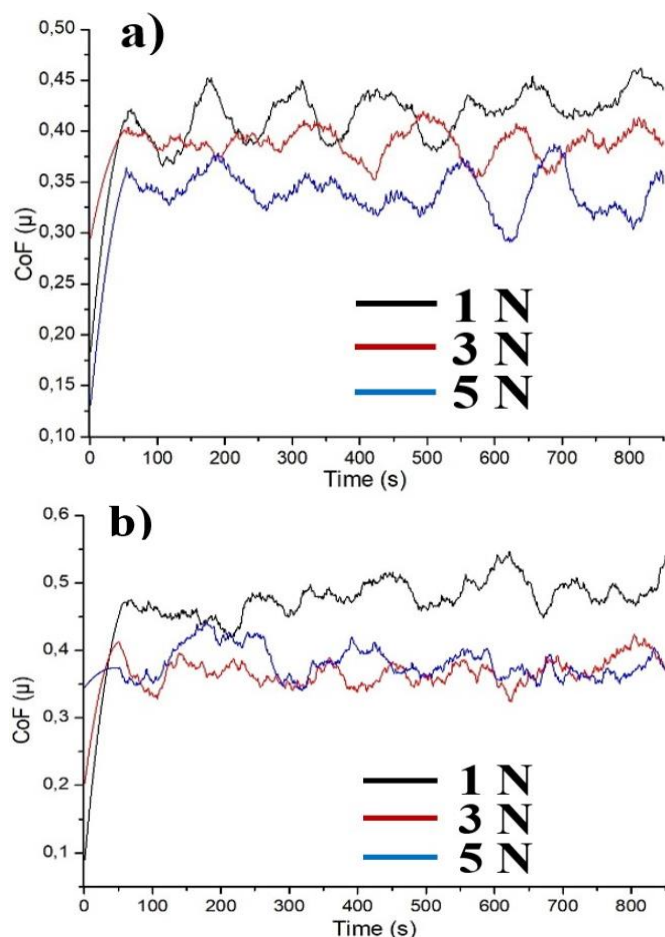
If the force applied on a sample with the same hardness is increased, the rate of penetration of the object to the opposite surface will increase. Therefore, it will penetrate the opposite surface more. This sinking rate will create a compressive force on the sample and a deformation will occur depending on the yield strength of the material. The deformation will increase with the increase of the applied load. In this case, more material will be accumulated in front of the penetrating tip due to its relative motion. In other words, the amount of material that resists the cutting force of the ball will be more. Due to the ongoing relative movement, material transfer will start from the surface and there will be a change in the profile of the wear trace on the sample surface. As a result, if the shear force is sufficient, the increase in the load will be effective in increasing the volume loss of the material.



**Figure 2.** Volume losses in composites produced with “0” degree laying angle depending on shear rate and load.



As can be seen from the wear loss (Figure 1) graph, another parameter that affects the volume losses in the samples is the shear rate. It is seen that the volume losses increase with the increase of the sliding speed. It should not be forgotten that the increase in the applied sliding speed will increase the wear losses. Apart from this, two different possibilities can be presented for the variation in wear losses that can be caused by the sliding speed. The first of these is the sudden increase in heat that occurs during friction. The thermal increase that occurs during the mutual friction of two objects may have different effects depending on the material properties. For example, in a metallic material, the oxidation that occurs due to the increase in temperature can reduce friction and even material loss. However, the effect on a polymeric matrix will be different. In polymeric materials, the temperature increase due to friction causes the matrix to soften. For this reason, the matrix deforms more easily. This, in turn, increases material loss, resulting in a decrease in wear resistance. Another effect of the increase in the sliding speed is the increase in the impact effect. As the sliding speed increases, the abrasive ball moving on the material will create a more dynamic effect on the part accumulated behind it. This will create a higher impact effect with high sliding speed and will increase the wear losses.



**Figure 3.** Depending on the sliding speed and load, the COF values occurring in composites produced with a "0" degree laying angle are a) 0.02 m/sec, b) 0.04 m/sec.

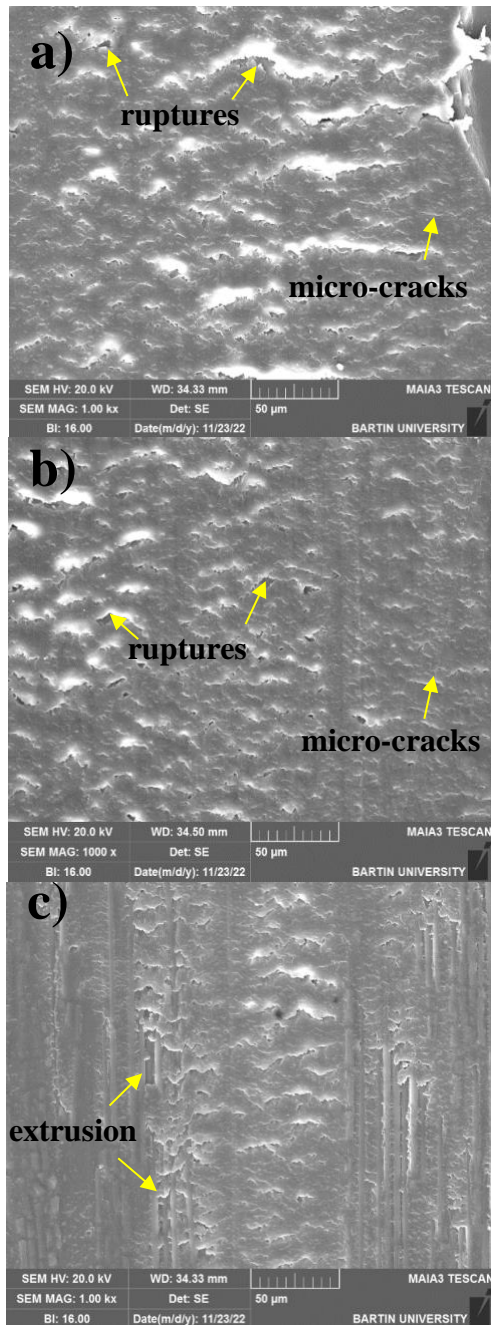
The coefficient of friction (COF) values of the samples obtained at different sliding speeds are given in Figure 3a-b. Although the COF values of the samples were close to each other, the increasing shear rate had an effect on the COF value. This effect is the change in peaks and valleys after steady-state

wear, rather than an increase in the COF value. While the peaks that occurred as a result of the increase and decrease of COF at low shear rate showed a triangular formation (Figure 3a), these peaks were blunted with increasing shear speed (Figure 3b). This situation can be seen much more clearly, especially at increasing loads. It is possible to say that the flash heating caused by the increasing load and sliding speed on the material surface causes this situation. The high COF value, which is seen at the beginning and called run-in, is attributed to the cleaning of the surface roughness. With the start of the wear process, the abrasive tip makes contact with the opposite surface only above the roughness. At this point, a high contact pressure occurs because the contact area is very small. Due to the high contact pressure, the friction coefficient increases rapidly. As the roughness peaks flatten over time and wear marks begin to form, the contact area between the abrasive ball and the sample expands and the friction coefficient reaches average values.

SEM wear trace photographs of the samples produced with a "0" degree laying angle and subjected to the wear test at a sliding speed of 0.02 m/sec under three different loads are given in Figures 4a-c. Although the increased shear rate was effective in the wear losses of the samples, there was no critical change in the wear mechanisms. As a result of the wear process carried out under low load (1 N) (Figure 4a), micro-fatigues on the sample surface and adhesion related ruptures occurring perpendicular and angular to the wear path caused by these fatigues are observed. As a result, there was material separation from the surface by the union of these tears. It is seen that the effect of micro-fatigue increases with the increase of the load of 3 N, thus the micro-cracks become more prominent, and then the cracks that come to the macro-size form wider. It is understood that with the increase of the load 5 N, besides the abrasion damage mentioned above, the carbon fibers begin to appear with the severity of the abrasion. It is noteworthy that the polymer, which acts as a matrix between the abrasive ball and carbon fibers, creates slight elongations in the form of extrusion.

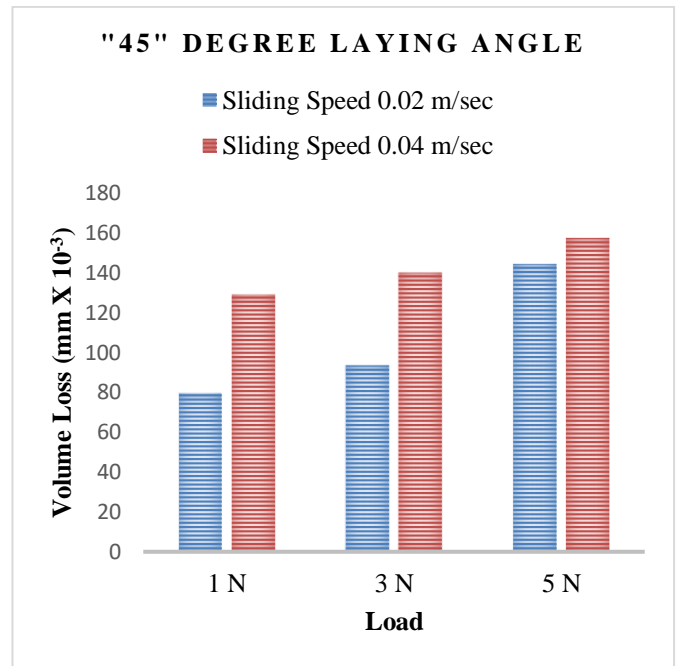
In Figure 5, the volume loss values of the samples, which were subjected to abrasion test under different sliding speeds and loads after being produced with a "45" degree laying angle, are given. Although similar volume losses are observed with "0" degree laying angle in the experiments carried out under 1 N load at a sliding speed of 0.02 m/sec, it is seen that the volume loss is relatively reduced at 3 N load. It can be seen from the graph that this situation becomes more evident under a load of 5 N. Similar volume losses under 1 N load are due to the fact that the abrasive works on the polymer matrix rather than the carbon fiber reinforcements at this load. Therefore, neither the effect of carbon fiber carbons nor their laying angles could be observed in this region. However, the change in volume losses between the two layings is striking with the increase of the load of 3 N. While a ratio difference of approximately 2% occurred between two pavings at 1 N load due to volume loss, this ratio increased to 8-9% at 3 N load and up to 12% at 5 N load. The increase in the reinforcing ratio of the carbon fibers on the bottom surface with the polymer matrix at 3 N load, and the operation of a mechanism that prevents the polymer matrix from flowing with the reinforcement under 5 N load, played a role in the decrease in volume losses. Although a noticeable volume loss is observed at 1 and 3 N loads with the increase in sliding speed, it is understood that this value is similar to the value obtained at 0.02 m/sec sliding speed at 5 N load.



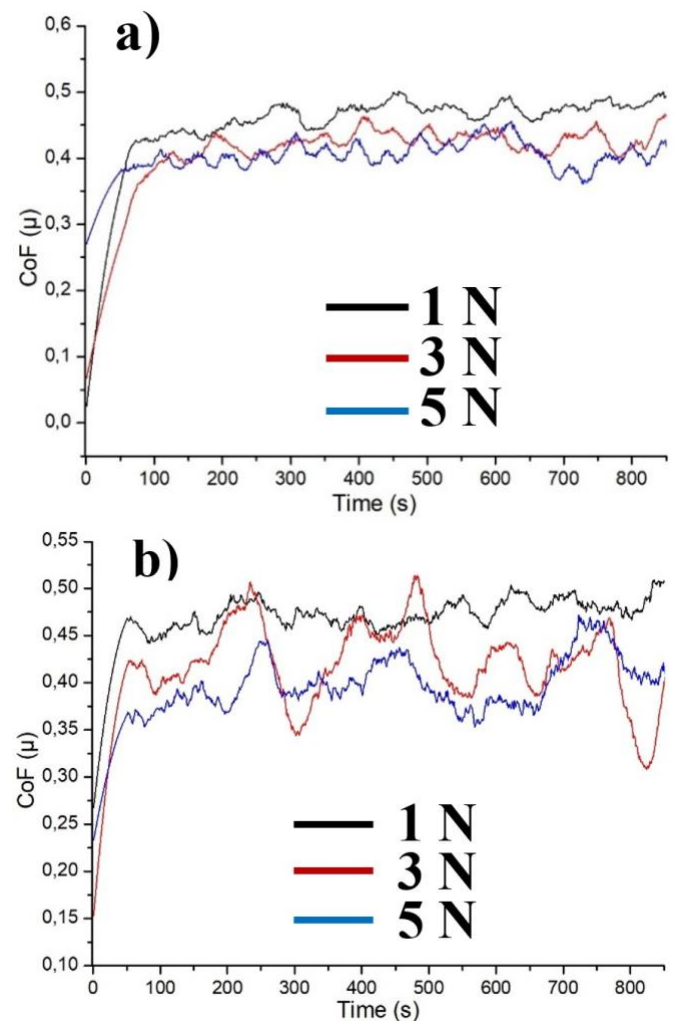


**Figure 4.** SEM images of worn surfaces due to load in composites produced with a "0" laying angle at a shear rate of 0.02 m/sec: a) 1 N, b) 3 N, c) 5 N.

The COF values obtained at different shear rates of the samples produced with a "45" degree laying angle are given in Figure 6 a-b. A striking situation in both graphs is the decrease in COF values with increasing load. It is understood that the samples exit the run-in mechanism and show a stable COF value after approximately 100 s of sliding time at low shear speed. As the reason why the COF value decreases with the increase in the load is interpreted in the previous graphs, it will not be mentioned again here. However, it can be seen that peak and valley formations are much more severe, especially at loads of 3 and 5 N, with an increase in shear speed. Here, the heat caused by friction may play a role in the decrease of the COF value, as well as an increase in the COF value due to adhesions that occur due to sudden cooling or adhesions.



**Figure 5.** Volume losses in composites produced with "45" degree laying angle depending on shear rate and load.



**Figure 6.** Depending on the sliding speed and load, the COF values occurring in composites produced with a "45" degree laying angle are a) 0.02 m/sec, b) 0.04 m/sec.



**Figure 7.** SEM images of the worn surfaces due to the load in composites produced with a “45” degree laying angle at a shear rate of 0.02 m/sec: a) 1 N, b) 3 N, c) 5 N.

The SEM wear trace photographs of the samples produced with a "45" laying angle and subjected to the wear test at a sliding speed of 0.02 m/sec under three different loads are given in Figure 7a-c. It is seen that micro and macro cracks are formed in the direction perpendicular to the wear trace of the matrix surface, which is under the compressive and tensile stresses, as in the sample produced with a "0" degree laying angle. However, it is seen that the width of the traces perpendicular to the wear direction is less and the damage to the surface is lower when compared to the sample whose cracks were produced with zero degree laying and subjected to the wear test. When the SEM (Figure 7b) wear trace photograph of the sample, which was subjected to the test at a sliding speed of 0.02 m/s under 3 N load, is examined, it is seen that the damage caused on the surface by the forces resulting from friction has increased. Because it can be clearly seen that the width of the cracks that occur and perpendicular to the wear mark increase and the gap between them increases. The SEM wear trace photograph of the sample, which was produced with a "45" degree laying angle and subjected to wear treatment at a 5 N load, 0.02 m/sec sliding speed, is given

in Figure 7c. Especially on the left side of the SEM image, the silhouette of the carbon fibers embedded under the polymer matrix can be seen with a 45 degree lay angle. However, when the degree of damage is compared to the damage of the samples produced with zero degree paving, it is seen that 45 degree paving is more resistant in all three loads.

#### 4. Conclusion

In this study, the effect of laying angle on the wear resistance of CFRP (Carbon fiber reinforced plastic) composites produced with different laying angles was investigated. In addition, these parameters were also tested as variables to determine the possible effects of load and sliding speed. In the tests performed with the ball-on-disc method, it was observed that the laying angle, the applied load and the sliding speed had different effects on the wear resistance of the composites.

- The increase in load facilitated material loss due to increased compressive forces and reduced wear resistance. The increase in shear rate also caused an increase in volume losses.
- It was determined that the wear resistance of the composites produced with the "45" degree laying angle was higher. The effect of the laying angle became more evident with the increase in the load.
- It has also been understood that the laying angle is also effective in the coefficient of friction.
- Micro and macro cracks and extrusion type wear mechanisms were observed on the SEM wear surfaces of the samples.

#### Ethical approval

Not applicable.

#### Conflicts of Interest

The authors declare that there is no conflict of interest regarding the publication of this paper.

#### References

- Ateş, E., & Aztekin, K. (2011). Density and compression strength properties of particulated and fiber reinforced polymer composites. *Journal of the Faculty of Engineering and Architecture of Gazi University*, 26(2), 479–486.
- Boztoprak, Y., & Kartal, İ. (2019). Bor Nitrür Partikülleriyle Takviyelendirilmiş Vinil Ester Matrisli Kompozitlerin Mekanik Özelliklerinin İncelenmesi. *El-Cezeri Fen ve Mühendislik Dergisi*, 2019(1), 43–50.
- Çakır, M., & Berberoğlu, B. (2018). E-Cam Elyaf Takviyeli Epoksi Matrisli Kompozit Malzemelerin Elyaf Oranındaki Artış İle Mekanik Özelliklerindeki Değişimlerin İncelenmesi. *El-Cezeri Fen ve Mühendislik Dergisi*, 5(3), 734–740.
- Erdoğan, A., Gök, M. S., Koç, V., & Günen, A. (2019). Friction and wear behavior of epoxy composite filled with industrial wastes. *Journal of Cleaner Production*, 237.
- Erdogan, A., Gök, M. S., Kurşuncu, B., Kiraz, T., & Demirel, B. (2021). Mechanical and tribological properties of waste iron scale reinforced polypropylene composite. *Industrial Lubrication and Tribology*, 73(2), 388–395.

- Hamamcı, B., Çiftci, M., & Aktaş, T. (2018). Karadeniz Fen Bilimleri Dergisi The Black Sea Journal of Sciences Fonksiyonel Derecelendirilmiş Kirişlerin Serbest Titreşim Analizi. Karadeniz Fen Bilimleri Dergisi, 8(2), 119–130.
- Jesson, D. A., & Watts, J. F. (2012). The interface and interphase in polymer matrix composites: Effect on mechanical properties and methods for identification. *Polymer Reviews*, 52(3–4), 321–354.
- Karthik, K., Rajamani, D., Manimaran, A., & Udaya Prakash, J. (2020). Wear behaviour of hybrid polymer matrix composites using Taguchi technique. *Materials Today: Proceedings*, 33, 3186–3190.
- Kessler, M. R. (2012). Polymer matrix composites: A perspective for a special issue of polymer reviews. *Polymer Reviews*, 52(3–4), 229–233.
- Koç, V., & Demirel, M. (2019). Epoksi Reçine-MgO Polimer Matrisli Kompozit Malzemelerin Üretilmesi ve Pin On Disk Abrasiv Aşınma Özelliklerinin İncelenmesi. *Fırat Üniversitesi Mühendislik Bilimleri Dergisi*, 31(1), 1–10.
- Kulkarni, V., Butte, K., & Rathod, S. (2012). Natural Polymers – A Comprehensive Review. *International Journal of Research in Pharmaceutical and Biomedical Sciences*, 3(4), 1597–1613.
- Kumar, P., Joshi, R. S., & Singla, R. K. (2021). Sliding wear behaviour of CP titanium laminates produced by large strain extrusion machining. *Wear*, 477(September 2020), 203774.
- Kuo, C., Wang, C., & Ko, S. (2018). Wear behaviour of CVD diamond-coated tools in the drilling of woven CFRP composites. *Wear*, 398–399(September 2016), 1–12.
- Kursuncu, B., Erdogan, A., Gok, M. S., & Demirel, B. (2020). Investigation of mechanical and tribological properties of different grain size iron scale reinforced polymer composite. *Polymers and Polymer Composites*, 1–8.
- Man, Z., Wang, H., He, Q., Kim, D. E., & Chang, L. (2021). Friction and wear behaviour of additively manufactured continuous carbon fibre reinforced PA6 composites. *Composites Part B: Engineering*, 226(April), 109332.
- Mohamed, H. (2013). Trimming of cfrp aircraft components. 1–14.
- Polanec, B., Zupanič, F., Bončina, T., Tašner, F., & Glodež, S. (2021). Experimental investigation of the wear behaviour of coated polymer gears. *Polymers*, 13(20).
- Sari, N., & Sinmazçelik, T. (2007). Erosive wear behaviour of carbon fibre/polyetherimide composites under low particle speed. *Materials and Design*, 28(1), 351–355.
- Seeholzer, L., Kneubühler, F., Grossenbacher, F., & Wegener, K. (2021). Tool wear and spring back analysis in orthogonal machining unidirectional CFRP with respect to tool geometry and fibre orientation. *International Journal of Advanced Manufacturing Technology*, 115(9–10), 2905–2928.
- Thomas, C., Borges, P. H. R., Panzera, T. H., Cimentada, A., & Lombillo, I. (2014). Epoxy composites containing CFRP powder wastes. *Composites Part B: Engineering*, 59, 260–268.



This is an open access article distributed under the terms of the Creative Commons Attribution 4.0 International Licence

Copyright © 2022 Journal of Aviation <https://javsci.com> - <http://dergipark.gov.tr/jav>

**Cite this article:** Gok, M.S, Kucuk, Y., Pehlivanlı, M., Erdogan, A. (2023). Investigation of Dry Sliding Wear Behavior of CFRP Composite Used in New Generation Aircraft Wings. *Journal of Aviation*, 7(2), 190-195.



# Air-traffic Flow Prediction with Deep Learning: A Case Study for Diyarbakır Airport

Ömer Osman Dursun<sup>1\*</sup> 

<sup>1\*</sup>Firat University, School of Civil Aviation, Department of Avionic, Elazığ, Türkiye. (oodursun@firat.edu.tr)

## Article Info

Received: 31 May 2023  
Revised: 22 June 2023  
Accepted: 23 June 2023  
Published Online: 30 June 2023

### Keywords:

Aviation  
Deep learning  
Aircraft prediction  
Long-short term memory

Corresponding Author: Ö. Osman Dursun

## RESEARCH ARTICLE

<https://doi.org/10.30518/jav.1307741>

## Abstract

Aviation industry develops rapidly. So the continuous growth of the aviation, accurate predictions play a crucial role in managing air traffic and optimizing airport operations. The prediction process involves various factors such as weather conditions, airport traffic, flight schedules, and historical data. Advanced techniques like machine learning contribute to enhancing the accuracy of predictions. In this context, air traffic data belonging to Diyarbakır province were utilized to predict the number of arrival aircraft to the airport using both traditional Autoregressive (AR) model and deep learning architecture, specifically the stacked Long Short-Term Memory (LSTM) model. The results indicate that the stacked LSTM model outperformed the AR model in terms of air traffic estimation. The AR model had a quite poorly MSE value of 48043.35 and an RMSE value of 219.18, while the stacked LSTM model achieved a significantly higher MSE value of 0.03 and an RMSE value of 0.17. The lower MSE values obtained by the stacked LSTM model indicate its ability to make more accurate predictions compared to the AR model. The stacked LSTM model's predictions were closer to the actual values, resulting in a more realistic estimation of air traffic. Accurate predictions enable efficient resource management, passenger planning, and airport security measures. Continuous efforts in predicting aircraft landings are necessary for the effective functioning of the aviation industry. In this study highlights the importance of predicting the number of aircraft landings at airports.

## 1. Introduction

The aviation industry holds an increasingly significant role worldwide in today's era (Bakreen, Markovskaya, Merzlikin, & Mottaeva, 2022). Air transportation plays a vital role in swiftly, safely, and efficiently moving people and goods from one point to another. However, this rapid growth and development have led to an increase in airport traffic, posing a significant challenge for the aviation sector. In this context, predicting the number of aircraft landing at an airport has become crucial for the efficient and safe operation of the aviation industry (Jo & Chang, 2023).

Airports serve as crucial hubs for passenger and cargo transportation worldwide (Li & Zhao, 2023). Thousands of aircraft land and take off at different airports every day. Airport traffic has evolved into a complex and dense network. This situation requires meticulous coordination and regulation of flights and landings at airports. Therefore, predicting the number of aircraft landings has become a critical tool for effectively managing airport operations (Bombelli, Santos, & Tavasszy, 2020; Tanrıverdi, Ecer, & Durak, 2022).

Predicting aircraft landings is of great importance for air traffic management and airport capacity planning. Accurately forecasting the number of landings at an airport ensures the

smooth flow of air traffic, enables planning of landing sequences, optimizes runway utilization, and provides the necessary gaps between flights. Additionally, airport operators, air traffic control units, and airline companies rely on these predictions for efficient resource management and personnel planning (Dalmau, 2022).

Predicting aircraft landings involves a complex process that encompasses various factors. Weather conditions, airport traffic, flight schedules, historical data, and intuitive factors are the fundamental elements of prediction models. Weather conditions significantly impact the number of landings at an airport. For example, dense fog, strong winds, or storms can reduce or even cancel landings. Moreover, airport traffic can influence the simultaneous occurrence of flights and landings at a specific airport. Particularly at major international airports, the demands of multiple airlines to land at the same time can affect the accuracy of predictions (Mondoloni & Rozen, 2020).

Accurate predictions of aircraft landings are not only essential for effectively managing airport operations but also for airline companies, travel agencies, passengers, and airport security. Precise landing predictions facilitate efficient allocation of resources utilized in flight planning and prevent the exceeding of airport facility capacities. They also assist passengers in adjusting their travel plans and provide advance



notice of potential delays or cancellations. In terms of airport security, predictions enable the implementation of necessary security measures and proper allocation of resources.

Prediction models employ various methods and techniques to forecast aircraft landings. These models perform statistical analyses based on historical data and evaluate current weather conditions to generate predictions. Machine learning and artificial intelligence techniques have contributed to the development of more advanced prediction models. These technological advancements hold great potential for increasing the accuracy of predictions and enhancing the efficiency of airport operations.

In this study, the number of arriving aircraft at Diyarbakir Airport was estimated for air traffic flow. The total number of arrival flights at Diyarbakir Airport between 2008 and 2023 was taken into account. Since the data were collected on a monthly basis, they exhibit a time-dependent pattern. Consequently, time series estimation was performed using both traditional autoregressive (AR) models and a deep learning architecture called Stacked Long Short Term Memory (LSTM). Both of models were compared in terms of prediction accuracy.

This study examined the process of predicting aircraft landings and emphasized the importance of such predictions. Detailed information was provided about the methods and techniques used in prediction models, along with their impact on airport operations and potential future developments. Recognizing the significance of accurate predictions in managing aircraft traffic and ensuring the efficiency of airport operations, continuous efforts in the field of aircraft landing prediction are crucial.

The study is organized as follows. The second part provides a comprehensive literature review. The third section covers the data utilized in the study, the data normalization process, and the models employed. In the fourth, the estimation results obtained from the AR and Stacked LSTM models are compared and analyzed. The final section presents the overall conclusion of the study.

## 2. Literature Review

Jiang and Luo (2022) conducted a comprehensive examination of the utilization of graph neural networks in various traffic forecasting problems, including road traffic flow, speed forecasting, passenger flow forecasting in urban rail transportation systems, and demand forecasting in passenger transportation platforms. They also provided an extensive list of available open data and source codes for each problem and identified future research directions (Jiang & Luo, 2022).

Mendez et al. (2023) presented a hybrid model that combines a Convolutional Neural Network (CNN) and a Bidirectional Long-Short-Term Memory (BiLSTM) network. The model was applied for long-term traffic flow prediction on urban routes. The hybrid model leverages the CNN's capability to extract hidden-value features from the input model and the BiLSTM's ability to understand the temporal context. To assess the effectiveness of the model, four streets in the city of Madrid with distinct characteristics were selected, and the performance of the proposed model was compared to eight

commonly used baseline models (Méndez, Merayo, & Núñez, 2023).

Gravio et al. (2015) aimed to improve the safety assessment of Air Traffic Management (ATM) and create proactive safety indicators. They utilized the Aviation Performance Factor and the Analytical Hierarchy Process to develop a statistical model for safety events and used Monte Carlo simulation, along with analytical models based on historical data, to estimate safety performance (Di Gravio, Mancini, Patriarca, & Costantino, 2015).

Kotegawa et al. (2010) developed and compared three algorithms based on the node characteristics of airports to improve existing air traffic forecasting methods used by the United States Federal Aviation Administration and to add new routes to air traffic. They utilized artificial neural networks and logistic regression algorithms for estimation. Each algorithm was fed with historical data and validated by comparing the accuracy and precision of the predicted new city pairs using the knowledge of actual new city pairs that emerged (Kotegawa, DeLaurentis, & Sengstacken, 2010).

Tacson and Olariaga (2021) conducted a medium-term traffic forecast for Bogotá-El Dorado International Airport in Colombia and assessed the impact of future demand on the airport's runway capacity. Due to the complexity of aviation forecasting, they employed System Dynamics (SD) as the analysis approach. The results indicated the necessity of expanding the airport's runway system after mid-2019, as the current capacity utilization rate reaches approximately 100%, requiring two to three runways for normal operations. Starting from October 2022, it was determined that three runways will be needed, and this trend is projected to continue until the final simulation period in 2023 (Tascón & Díaz Olariaga, 2021).

Solvoll et al. (2020) examined and compared traffic forecasting methods for a Norwegian airport using various quantitative approaches. They specifically focused on two estimation methods: changes in infrastructure and traffic forecasting (Solvoll, Mathisen, & Welde, 2020).

Standfuss et al. (2021) investigated the impact of the disparity between predicted and actual traffic on established performance indicators in European Air Traffic Management. They conducted regression models using cross-sectional and panel data to analyze the correlation between prediction quality and ANSP performance. The study revealed that the actual traffic counts often fell outside the STATFOR confidence intervals. Consequently, many ANSPs faced unreliable forecasts. Additionally, the research demonstrated a statistically significant relationship between forecast quality and air traffic punctuality as well as service provider productivity (Standfuss, Fricke, & Whittome, 2022).

## 3. Materials and Methods

The study utilized air traffic data that represents the total number of domestic and international flights related to Diyarbakir province. The next step involved applying the normalization process to the obtained passenger data. The air traffic prediction was conducted by modeling the normalized data using the Autoregressive (AR) and stacked LSTM methods. Fig. 1 presents the flowchart of the study.

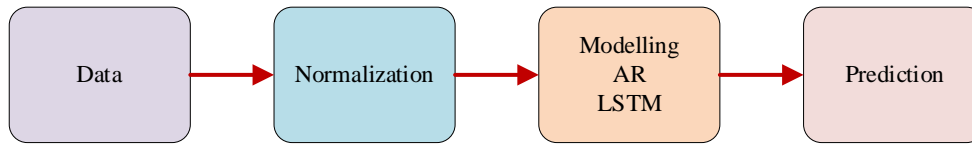


Figure 1. Flowchart of the study

3.1. Data

The data on the number of planes in the air traffic at Diyarbakır Airport from January 2008 to the end of May 2023 was obtained from the General Directorate of State Airports Authority. The passenger data was collected on a monthly basis throughout the years. The total number of aircraft was calculated by summing the number of domestic and international arrival aircraft at Diyarbakır Airport on a monthly basis (DHMI, n.d.). For the training of the AR and stacked LSTM models, 80% of the total 185 data points were utilized, while the remaining 20% was reserved for testing (Guo, Lao, Hou, Li, & Zhang, 2021; Song et al., 2020).

The Fig. 2 shows the domestic, international, and total air traffic for Diyarbakır Airport. Upon examining the figure, it can be observed that the domestic air traffic varies between 0 and 1600, while the international air traffic is limited to a range of 0-100 aircraft. Additionally, when the period between 2019 and 2021, which coincides with the pandemic, is examined, a significant decrease in domestic air traffic is evident, along with a slight decrease in international air traffic. However, after the pandemic period, specifically after 2021, it can be noticed that there is a surge in both domestic and international air traffic.

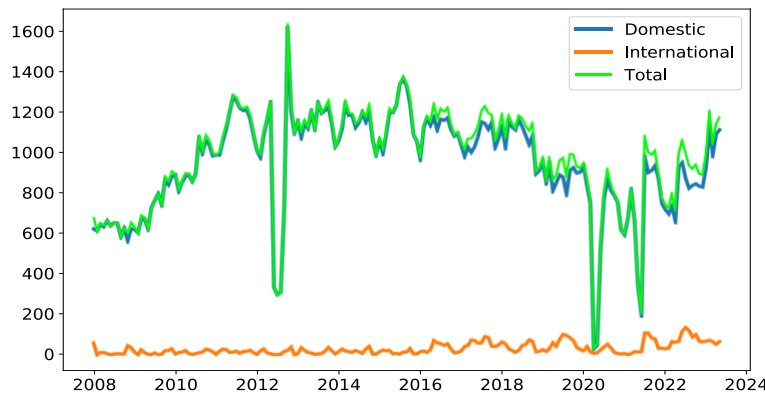


Figure 2. Air traffic of Diyarbakır Airport by year

3.2. Normalization

Normalization enables the handling and comparison of data with different data distributions on a unified scale. In this study, the min-max normalization method was utilized. The original dataset undergoes a linear transformation using the min-max normalization method, resulting in the dataset being scaled to the range of [0-1]. The mathematical expression for the min-max normalization method is shown in Equation 1.

$$x' = \frac{x_t - x_{min}}{x_{max} - x_{min}} \tag{1}$$

Here,  $x'$  represents the normalized data,  $x_t$  represents the input value at time  $t$ ,  $x_{max}$  is the largest number in the dataset, and  $x_{min}$  is the smallest number in the dataset (Song et al., 2020). By subtracting the minimum value and dividing it by the range (maximum minus minimum), the data is transformed to a normalized scale between 0 and 1.

3.3. Auto regressive model

Auto regressive model (AR) is one of the statistical methods used for time series prediction. The AR model investigates a linear relationship with the past values of the variable. It tries to predict future values based on the relationships it has developed. The AR model is represented by Equation 2.

$$x_t = c + \phi_1 x_{(t-1)} + \phi_2 x_{(t-2)} + \dots + \phi_p x_{(t-p)} + \varepsilon_t \tag{2}$$

Here:

- $x_t$  represents the value of the time series at time  $t$ .
- $c$  is the constant term.
- $\phi_1, \phi_2, \dots, \phi_p$  are the auto-regression coefficients representing the relationships with past values.
- $x_{(t-1)}, x_{(t-2)}, \dots, x_{(t-p)}$  are the values at  $p$  time steps before  $x_t$ .
- $\varepsilon_t$  is the error term of the time series, indicating the deviation from the expected value.

This is the mathematical representation of the AR model. It tries to predict the current value using weighted combinations of past values. The predictive abilities of auto regressive models vary depending on how the past values are utilized. Generally, a higher auto regression order ( $p$ ) relies on a longer history. Higher order models can capture more complex relationships, but they require more data and increase the complexity of the model (Shakeel, Tanaka, & Kitajo, 2020).

3.4. Long short term memory

Long Short-Term Memory (LSTM) is a type of artificial neural network that is particularly useful in dealing with sequential

data, such as time series data and natural language processing. It is an extension of traditional Recurrent Neural Networks (RNNs) designed to address the issue of capturing long-term dependencies (Dursun & Toraman, 2021).

LSTM introduces a memory cell as its basic building block, which allows it to remember and access information over long periods of time. The memory cell consists of three main components: an input gate, a forget gate, and an output gate. These gates regulate the flow of information into and out of the memory cell.

The input gate determines how much of the incoming information should be stored in the memory cell. It takes into account the current input  $x_t$  and the previous hidden state  $h_{t-1}$  of the LSTM to decide which information is relevant and should be stored. The input gate is computed using the sigmoid ( $\sigma$ ) activation function. Input gate formulation is shown in Equation 3.

$$i_t = \sigma(W[h_{t-1}, c_{t-1}, x_t] + b_i) \quad (3)$$

The forget gate controls the extent to which the previous memory content should be retained or forgotten. It considers the current input  $x_t$  and the previous hidden state  $h_{t-1}$  to determine which information is no longer useful and should be discarded from the memory cell. The forget gate is also computed using the sigmoid ( $\sigma$ ) activation function. Equation 4 represents the forget gate.

$$f_t = \sigma(W[x_t, c_{t-1}, h_{t-1}] + b_f) \quad (4)$$

The output gate determines how much of the memory cell's content should be exposed to the next hidden state and used for making predictions. It considers the current input  $x_t$  and the updated memory cell content  $c_t$  to decide which information is relevant for the current time step. The output gate is computed using the sigmoid ( $\sigma$ ) activation function. The output gate is given in Equation 5.

$$o_t = \sigma(W[h_{t-1}, c_t, x_t] + b_o) \quad (5)$$

The memory cell is updated based on the input gate, forget gate, and the current input  $x_t$  and previous hidden state  $h_{t-1}$ . The cell state update equation is stated in Equation 6.

$$c_t = i_t \times \tanh(W[h_{t-1}, c_{t-1}, x_t] + b_c) + f_t \times c_{t-1} \quad (6)$$

Here,  $c_t$  represents the updated cell state at time step  $t$ ,  $c_{t-1}$  is the previous cell state, and  $\tanh$  is the hyperbolic tangent activation function.

Finally, the hidden state  $h_t$  is computed based on the output gate and the updated cell state. The hidden state represents the output of the LSTM at each time step and can be used for making predictions or passed on to subsequent layers. The equation for the hidden state is denoted as in Equation 7 (Aygun, Dursun, & Toraman, 2023). The structure of LSTM is shown in Fig. 3.

$$h_t = o_t * \tanh(c_t) \quad (7)$$

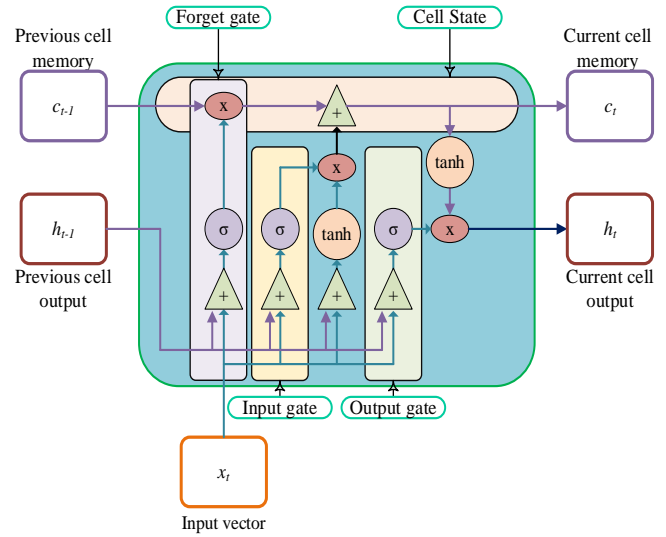


Figure 3. LSTM architecture

### 3.5. The evaluation criteria

In the recommended study, the performance measurement considered Mean Squared Error (MSE) and Root Mean Squared Error (RMSE), and they were evaluated. The equations for MSE and RMSE, which are performance metrics, can be seen in Equations 8-9. MSE serves as a function that measures the error rate and performance of the model. It calculates how different the model's prediction is from the actual value. The lower the difference between the actual and predicted values, the better the prediction. If the MSE value approaches 0, it indicates a good prediction (Kızrak & Bolat, 2019; Shakeel et al., 2020).

$$MSE = \frac{1}{n} \sum_{t=1}^n (x_t - \bar{x}_t)^2 \quad (8)$$

$$RMSE = \sqrt{\frac{1}{n} \sum_{t=1}^n (x_t - \bar{x}_t)^2} \quad (9)$$

Here,  $n$  is the number of samples,  $x_t$  is the number of aircraft in  $t$  time,  $\bar{x}_t$  is the estimated number of aircraft number in  $t$  time.

## 4. Result and Discussion

In this section, the performance evaluation criteria for both the AR and LSTM models, the hyperparameter tuning of the stacked LSTM model, and the evaluation of prediction results have been discussed.

In this study, no parameter settings were applied for the AR model. However, in the newly proposed stacked LSTM model, the following parameter configurations were used:

- Optimization Algorithm: Adam
- Loss Function: Mean Squared Error (MSE)

The hyperparameters of the LSTM model were determined using the brute force method. The model architecture consists of a three-layer stacked LSTM structure.

The hyperparameter values were tested as follows:

- Number of Cycles: 100, 200, 400 (The best result was obtained at 100 cycles).
- Cluster Size: 2, 4, 8 (The best result was obtained with a cluster size of 4).
- Output Layer Number: 1 (The LSTM model has a single output layer).

For each layer of the model, the following values were tried as memory blocks:

- First LSTM Layer: 16
- Second LSTM Layer: 32
- Last LSTM Layer: 64

The best performance was achieved with these memory block values.

The learning rate (*lr*) was explored in the range of  $[10^{-1}, \dots, 10^{-4}]$ . The best learning rate was found to be  $lr = 10^{-3}$ . When the learning rate was set to  $10^{-4}$ , the model started to memorize instead of learning.

In the air traffic estimation using the AR model, the MSE value was found to be 48043.35 and the RMSE value was 219.18. On the other hand, the stacked LSTM model yielded an MSE value of 0.03 and an RMSE value of 0.17. When comparing the two models based on the MSE values, it is evident that the stacked LSTM model, with an MSE value close to zero, provided more accurate predictions than the AR model. This indicates that the stacked LSTM model achieved a more realistic estimation compared to the AR model. A comprehensive overview of the performance evaluations for both models can be seen in Table 1.

**Table 1.** Performance evaluation of the models

	AR		Stacked LSTM	
	MSE	RMSE	MSE	RMSE
	48043.35	219.18	0.03	0.17

80% of the 185 air traffic data for Diyarbakır province from 2008 to 2023, a total of 148 data points, were used for training

the AR and stacked LSTM models. The remaining 20% of the data, 37 data points, were reserved for testing.

After the training process, the models were evaluated using the test data. The estimated values and actual values are presented in Table 2. Considering the first row of Table 2, the actual air traffic data for Diyarbakır was recorded as 1173. The AR model predicted this value as 987.6, while the stacked LSTM model predicted it as 1029.1.

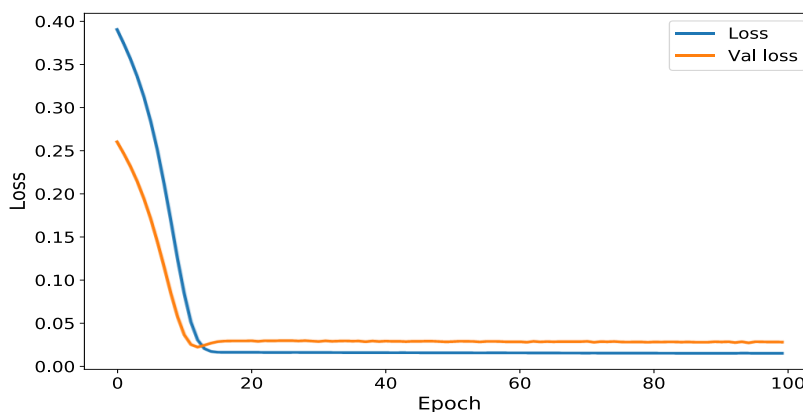
**Table 2.** Actual and forecast results

Actual	Predicted	
	AR	Stacked LSTM
1173	987.6	1029.1
1140	987.3	1004.7
1047	987	1099.4
1202	986.6	1071
992	986.2	973.2
889	985.6	981.9
896	984.9	962.8
940	984.1	1004.7
920	983.2	920.2
937	982.1	1034.9

Loss values are used to measure the error between the model's predicted output and the actual output. The validation loss (Val loss) specifically indicates the error during the training phase. It is desirable for both the loss and validation loss values to approach zero as the training progresses. A decreasing loss and validation loss signify that the model is learning and improving its predictions. However, it's important to strike a balance and avoid overfitting, where the model becomes too specialized to the training data and performs poorly on new, unseen data.

The line chart in Fig. 4 illustrates the variation of the loss function for the proposed stacked LSTM model based on the number of epoch. Upon analyzing the graph, it becomes evident that the loss value for both the training and test data decreases as the iterations progress.

In this study, MSE was utilized as the loss function. The small value of MSE indicates that the proposed model provides accurate estimations. Throughout the learning process, both the training and test data values gradually approached zero. The loss graph depicted in Fig. 4 demonstrates that the model did not suffer from overfitting or memorization.



**Figure 4.** Stacked LSTM loss function

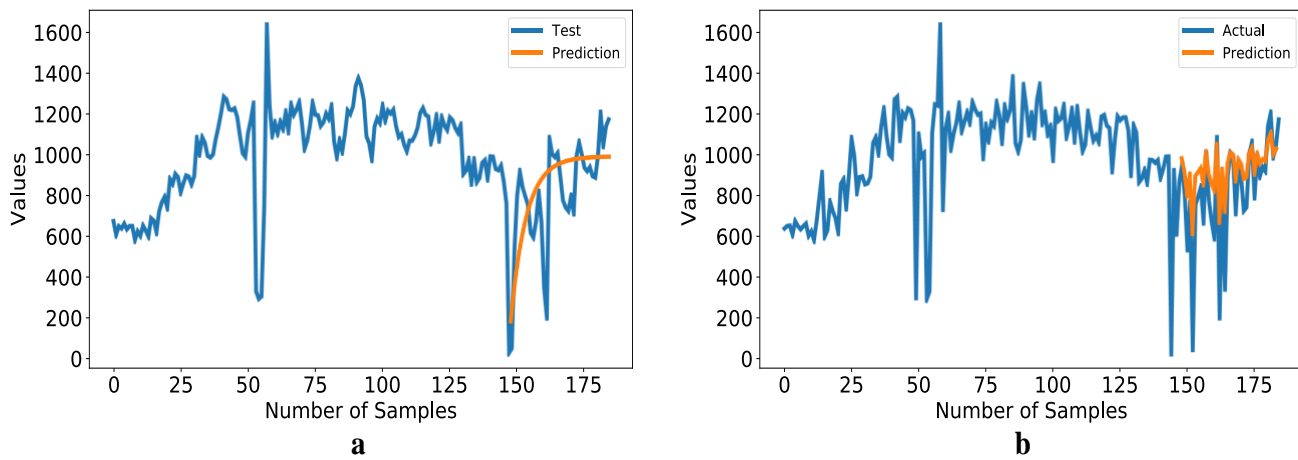
In addition, when comparing the estimations of the test data from both the AR and stacked LSTM models with the original data, it is observed that the estimation of the AR model deviates significantly from the original data, whereas the

estimation of the stacked LSTM model closely aligns with the original data. This indicates that the stacked LSTM model provides better air traffic estimation for Diyarbakır province compared to the AR model.



Fig. 5a displays the estimation of the AR model, while Fig. 5b showcases the estimation of the stacked LSTM model. Both figures present the raw passenger data, which is divided into training and test datasets. The divergence between the AR

model's estimation and the original data is apparent in Fig. 4a, whereas the estimation of the stacked LSTM model in Fig. 4b exhibits a closer match to the original data.



**Figure 5.** a) Prediction values of AR model b) Prediction values of Stacked LSTM model

First, we employed the AR method, which aimed to establish a linear model by considering associated with aircraft numbers. Through AR analysis, we sought to identify the relationships between these time series and accurately predict the number of aircraft. The results of AR model showed promising performance in capturing the overall trend and providing reasonable estimates of aircraft numbers. However, it is important to note that the AR approach assumes a linear relationship between the time series and the target variable, which may limit its ability to capture nonlinear dynamics and intricate patterns in the data.

To overcome the limitations of AR, we also explored the stacked LSTM method, which is specifically designed to handle sequential data and capture long-term dependencies. LSTM introduces memory cells and gating mechanisms that enable the model to retain and selectively utilize information over extended periods. By incorporating these mechanisms, LSTM can effectively capture temporal dynamics and complex patterns in aircraft traffic.

In our experiments, we trained an LSTM model using historical data on aircraft numbers and their corresponding time series. The stacked LSTM model exhibited superior performance compared to AR in capturing the intricate patterns and nonlinear relationships present in the data. By leveraging its ability to retain memory and propagate information over time, the stacked LSTM model was able to make more accurate predictions of aircraft numbers, even when faced with fluctuations and seasonality in the data.

Furthermore, the stacked LSTM model's capability to handle input sequences of varying lengths proved advantageous when dealing with different time intervals and temporal resolutions. This flexibility allows the model to adapt to different forecasting horizons and capture short-term as well as long-term trends in aircraft traffic.

However, it is important to note that the effectiveness of the stacked LSTM method is highly dependent on the availability and quality of training data. A sufficient amount of high-quality historical data is necessary to train the model effectively and capture the underlying patterns and dynamics in aircraft traffic.

In summary, our findings indicate that stacked LSTM outperformed AR in predicting aircraft numbers, showcasing its ability to capture complex temporal dependencies and nonlinear relationships. The stacked LSTM model's flexibility, memory retention, and adaptability to varying input sequences make it a powerful tool for forecasting aircraft traffic. Nonetheless, it is crucial to consider the specific characteristics of the dataset and the problem context when choosing between AR and LSTM, as the performance of each method may vary depending on the specific scenario.

In this study will help aviation authorities and policymakers make informed decisions. Additionally, the study will provide several advantages in addressing various challenges in the future planning of the aviation industry.

**Advantages:**

- By estimating air traffic, the adequacy of airport infrastructure and facilities such as runways, aprons, and passenger waiting areas can be evaluated.
- Air traffic estimation can determine whether an airport will be sufficient in the future or if there is a need for an additional airport in a specific location.
- Predicting air traffic enables airline companies to plan their flights and manage their crew effectively.

However, the study has some limitations. It relies on monthly temporal data from a relatively short time period spanning from 2008 to 2023, and it does not utilize various other features. Nevertheless, this research contributes to the utilization of deep learning models in the aviation industry, which remains largely unexplored from both industrial and academic perspectives.

**5. Conclusion**

In this study, an analysis was conducted on predicting air traffic using AR and stacked LSTM (Long Short-Term Memory) methods. Various features and datasets were

experimented with to compare the performance of both methods and evaluate their abilities to capture the complexities of aircraft traffic.

AR method aimed to build a linear model by considering different features associated with aircraft counts. Through AR analysis, we aimed to determine the relationships between these features and accurately predict aircraft counts. The results obtained demonstrated that the AR model performed quite poorly in predicting aircraft counts. However, the AR method may have limitations in capturing time dependencies and complex relationships present in the data.

On the other hand, the LSTM method offers a more complex and flexible approach. LSTM is known for its ability to capture long-term dependencies and complex relationships over time. We attempted to predict aircraft counts using this method, and the results were quite promising. LSTM can better capture temporal changes and handle dynamic patterns, which can lead to more accurate predictions in aircraft traffic.

Our comparative analysis indicated that LSTM outperformed AR method in terms of performance. Its more complex architecture and ability to capture dependencies in time series data demonstrated the effectiveness of LSTM in predicting aircraft numbers. However, the LSTM method may require more data and involve a more intricate modeling process.

In conclusion, deep learning methods such as LSTM show superior performance compared to traditional methods as AR in predicting aircraft counts. However, both methods have their own advantages and limitations, and the choice of method may depend on the dataset and problem context.

This study serves as a starting point to compare AR and LSTM methods in predicting aircraft counts. Further research can explore advanced variations of LSTM or other deep learning techniques to enhance the accuracy of air traffic predictions. Additionally, incorporating more diverse and comprehensive datasets can provide further insights into the performance and limitations of these methods in real-world scenarios.

### Ethical approval

Not applicable.

### Conflicts of Interest

The authors declare that there is no conflict of interest regarding the publication of this paper.

### References

Aygun, H., Dursun, O. O., & Toraman, S. (2023). Machine learning based approach for forecasting emission parameters of mixed flow turbofan engine at high power modes. *Energy*, 271(January), 127026.

Bakreen, S., Markovskaya, E., Merzlikin, I., & Mottaeva, A. (2022). Development of the approach to the analysis of aviation industry's adaptation to seasonal disruptions. *Transportation Research Procedia*, 63, 1431–1443.

Bombelli, A., Santos, B. F., & Tavasszy, L. (2020). Analysis of the air cargo transport network using a complex network theory perspective. *Transportation Research Part E: Logistics and Transportation Review*, 138(April), 101959.

Dalmau, R. (2022). Predicting the likelihood of airspace user rerouting to mitigate air traffic flow management delay. *Transportation Research Part C: Emerging Technologies*, 144(August), 103869.

DHMİ. (n.d.). DHMİ. Retrieved December 13, 2016, from <http://www.dhmi.gov.tr/istatistik.aspx>

Di Gravio, G., Mancini, M., Patriarca, R., & Costantino, F. (2015). Overall safety performance of Air Traffic Management system: Forecasting and monitoring. *Safety Science*, 72, 351–362.

Dursun, Ö. O., & Toraman, S. (2021). Uzun Kısa Vadeli Bellek Yöntemi ile Havayolu Yolcu Tahmini. *Journal of Aviation*, 5(1), 241–248.

Guo, J., Lao, Z., Hou, M., Li, C., & Zhang, S. (2021). Mechanical fault time series prediction by using EFMSAE-LSTM neural network. *Measurement: Journal of the International Measurement Confederation*, 173 (October 2020), 108566.

Jiang, W., & Luo, J. (2022). Graph neural network for traffic forecasting: A survey. *Expert Systems with Applications*, 207(December 2021), 117921.

Jo, A. H., & Chang, Y. T. (2023). The effect of airport efficiency on air traffic, using DEA and multilateral resistance terms gravity models. *Journal of Air Transport Management*, 108(January), 102364.

Kızrak, M. A., & Bolat, B. (2019). Uçak Motoru Sağlığı için Uzun-Kısa Süreli Bellek Yöntemi ile Öngörücü Bakım. *Bilişim Teknolojileri Dergisi*, 103–109.

Kotegawa, T., DeLaurentis, D. A., & Sengstacken, A. (2010). Development of network restructuring models for improved air traffic forecasts. *Transportation Research Part C: Emerging Technologies*, 18(6), 937–949.

Li, X., & Zhao, Y. (2023). Evaluation of sound environment in departure lounges of a large hub airport. *Building and Environment*, 232(January).

Méndez, M., Merayo, M. G., & Núñez, M. (2023). Long-term traffic flow forecasting using a hybrid CNN-BiLSTM model. *Engineering Applications of Artificial Intelligence*, 121(March), 106041.

Mondoloni, S., & Rozen, N. (2020). Aircraft trajectory prediction and synchronization for air traffic management applications. *Progress in Aerospace Sciences*, 119(20).

Shakeel, A., Tanaka, T., & Kitajo, K. (2020). Time-series prediction of the oscillatory phase of eeg signals using the least mean square algorithm-based ar model. *Applied Sciences (Switzerland)*, 10(10).

Solvoll, G., Mathisen, T. A., & Welde, M. (2020). Forecasting air traffic demand for major infrastructure changes. *Research in Transportation Economics*, 82(September 2019), 100873.

Song, X., Liu, Y., Xue, L., Wang, J., Zhang, J., Wang, J., Cheng, Z. (2020). Time-series well performance prediction based on Long Short-Term Memory (LSTM) neural network model. *Journal of Petroleum Science and Engineering*, 186(November 2019), 106682.

Standfuss, T., Fricke, H., & Whittome, M. (2022). Forecasting European Air Traffic Demand - How deviations in traffic affect ANS performance. *Transportation Research Procedia*, 59, 105–116.

Tanrıverdi, G., Ecer, F., & Durak, M. Ş. (2022). Exploring factors affecting airport selection during the COVID-

19 pandemic from air cargo carriers' perspective through the triangular fuzzy Dombi-Bonferroni BWM methodology. *Journal of Air Transport Management*, 105(June).

Tascón, D. C., & Díaz Olariaga, O. (2021). Air traffic forecast and its impact on runway capacity. A System Dynamics approach. *Journal of Air Transport Management*, 90(September 2020).

---

**Cite this article:** Dursun, O.O. (2023). Air-traffic Flow Prediction with Deep Learning: A Case Study for Diyarbakır Airport. *Journal of Aviation*, 7(2), 196-203.



This is an open access article distributed under the terms of the Creative Commons Attribution 4.0 International Licence

**Copyright © 2023 Journal of Aviation** <https://javsci.com> - <http://dergipark.gov.tr/jav>

# Understanding the Sintering Behavior and its Effect on the Thermal Conductivity of YSZ Coatings for Gas Turbine Applications

Garip Erdoğan<sup>1\*</sup> 

<sup>1</sup>Sakarya University, Metallurgical and Materials Eng. Dept. Materials Under Extreme Conditions Lab., Sakarya Turkiye, (gerdogan@sakarya.edu.tr)

## Article Info

Received: 09 June 2023  
Revised: 16 June 2023  
Accepted: 30 June 2023  
Published Online: 01 July 2023

### Keywords:

Thermal Barrier Coatings  
Plasma Spray  
Thermal Conductivity  
Sintering  
Gas Turbine

Corresponding Author: *Garip Erdoğan*

## RESEARCH ARTICLE

<https://doi.org/10.30518/jav.1312453>

## Abstract

Thermal barrier coatings are essential to protect the combustion chamber liner material from harsh environments in modern gas turbines used in aerospace and land-based power generation facilities. As there are several different materials to produce thermal barrier coatings, the conventional thermal barrier coating is yttria stabilized zirconia (YSZ). The most common method to manufacture YSZ coating is plasma spraying method due to its flexibility and rapid production capacity. Using plasma spraying, often requires understanding the process parameters effect on the coating structure. As there are many parameters to control coating process the main outcome of all parameters is the particle temperature and velocity during the spraying process hence the coating properties such as hardness, porosity ratio and deposition rates. Furthermore, not only produced microstructure but also during the service conditions sintering behavior also be considered. Sintering behavior of thermal barrier coatings results declining of their thermal insulation properties. Therefore, in this study we have evaluated sintering effect of on the thermal conductivity of the plasma sprayed yttria stabilized zirconia coatings. To achieve this objective, we produced free-standing coatings and subjected them to heat treatment, followed by measurements of their thermal conductivities. The results of this study will contribute to a better understanding of the sintering behavior and its impact on the thermal performance of thermal barrier coatings.

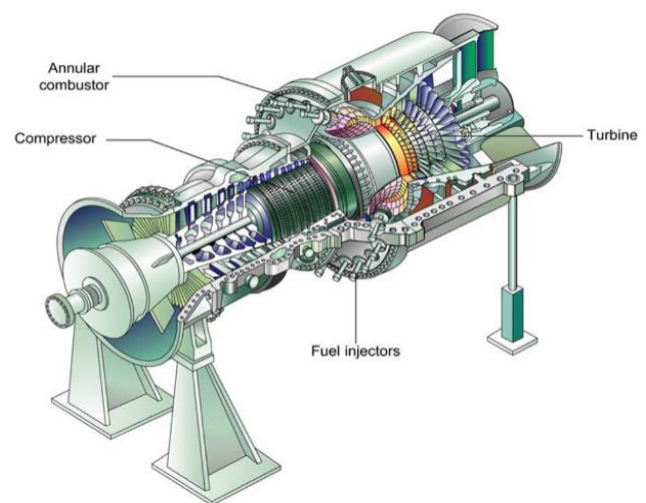
## 1. Introduction

Gas turbines are used in various industries, from power generation to aviation and combatant marine and civil aircraft. Gas turbines play a critical role in aviation, powering multiple aircraft types with their efficient and reliable operation. A gas turbine is a continuous-flow internal combustion engine that propel the aircraft in the air by converting the heat of fuel and air combustion to mechanical energy. Gas turbines used in aviation are designed to meet stringent performance requirements, ensuring safe and efficient flight operations, especially in extreme working conditions.

Aviation gas turbines have several vital stages, including a compressor, combustor, turbine, and exhaust system. A Schematic of a gas turbine is given in Fig 1. Each component performs a necessary function in the overall operation of the gas turbine.

The compressor is a central component of gas turbines. It draws air in and compresses before entering the combustion chamber. The compressor enhances the engine's overall efficiency by increasing the air available for combustion multi-stage axial compressors are typically used in aircraft gas turbines. Due to their excellent mechanical properties and resistance to high temperatures, these compressors are typically made from high-strength alloys such as titanium and nickel-based super alloys (Caron & Khan, 1999). These

materials ensure that the compressor can withstand the high speeds, and pressure differentials.



**Figure 1.** Schematic of a gas turbine (Boyce, 2012)

The combustor is the main place where the combustion process takes place to produce the necessary power. A controlled combustion of fuel and air to produce hot gases. Combustors are typically made of materials that can withstand



extreme thermal and chemical environments. Advanced materials such as Ceramic Matrix Composite (CMC) and Thermal Barrier Coating (TBC) are used in the combustion chamber to ensure excellent heat resistance and thermal insulation(Grady, 2013). These materials help protect the combustion chamber from thermal stress and improve durability.

The turbine is a critical component that extracts energy from the hot gases produced during combustion. The turbine is connected to the compressor via a shaft, allowing it to drive the compressor and other accessories. The turbine's primary role is to convert the energy in the high-temperature, high-pressure gases into mechanical work, powering the compressor and other aircraft systems. Turbines are typically multi-stage radial turbines featuring multiple rows of blades that efficiently extract energy from the hot gases.

These turbines are constructed using advanced materials and innovative designs to ensure optimal performance. High-strength, high resistance to creep, nickel-based super alloys, are commonly employed due to their exceptional mechanical properties and resistance to high temperatures and stresses.

The continuous advancements in gas turbine technology have led to significant improvements in aircraft performance, fuel efficiency, and environmental impact. Ongoing research and development efforts focus on enhancing the efficiency of gas turbines used in aviation, reducing emissions, and exploring alternative fuel options.

Demands on the more efficient gas turbines have turned researchers to increase the operating temperature of a gas turbine to relatively high temperatures. Higher temperatures enable the combustion process to be more efficient, resulting in improved fuel consumption and reduced emissions(Clarke et al., 2012). This enhanced combustion efficiency directly translates into higher power output and lower fuel consumption, making gas turbines more economically viable and environmentally friendly(Boyce, 2012; Ozgurluk et al., 2018).

However, high-temperature operation requires durable specifically engineered materials that must stand the extreme temperatures experienced within the turbine environment, often exceeding 1000°C (1832°F). This extreme condition can lead to thermal fatigue, creep, oxidation, and degradation of the turbine components, resulting in reduced performance and potential failure(Coble, 1963). Nickel-based super alloys are used in gas turbine hot sections because of their excellent high-temperature properties(Caron & Khan, 1999). Moreover, along with cooling, thermal barrier coatings (TBCs) have extended their usage for even higher temperatures. TBCs are typically two layered coatings system consisting of a metallic bond coat and yttria stabilize zirconia to enhance thermal insulation and protection against oxidation.

The bond coat acts as an intermediary layer, providing adhesion between the TBC and the substrate material. It helps to minimize thermal stresses by allowing for differential expansion and contraction between the substrate and the ceramic topcoat. Typically, the bond coat is composed of a diffusion barrier, such as MCrAlY (where M represents various elements such as nickel, cobalt, and iron), which forms a protective oxide layer and enhances the oxidation resistance of the underlying material.

Thermal barrier coatings (TBCs) play a crucial role in protecting turbine blades, combustion chambers and the areas of exposed to high heat fluxes due to the extreme operating conditions in modern gas turbines, particularly in the aerospace industry. Gas turbines are used in both aerospace and land-based power generation plants. The conventional high-temperature insulation material is yttria-stabilised

zirconia (YSZ) known for its high melting temperature and durability at extreme conditions, making it particularly suitable for demanding aerospace applications. TBCs help to reduce temperature of the metallic materials along with the applied cooling and increase the overall durability and lifetime of engine components.

Among the various techniques available for producing TBCs, plasma spraying has sustained its importance in the aerospace industry due to its flexibility and rapid production capabilities. Producing YSZ based coatings with atmospheric plasma spraying often relies on the controlling spraying parameters to control the coating properties and morphology. For example, low insulation properties could be obtained by increasing the porosity ratio of the coating structure while trading off its hardness.

However, TBCs undergo a densification phenomenon known as sintering of the ceramic topcoat material at high temperatures, leading to changes in its microstructure and properties over time. Change in the microstructure of the topcoat, potentially reduces its ability to provide effective thermal insulation.(Cipitria et al., 2009; Deshpande, 2013)

In this study, we investigated the sintering behavior of a conventional yttria-stabilized zirconia (YSZ) coating. The coating was subjected to a temperature of 1150°C for varying durations of 0, 50, and 100 hours to simulate the thermal exposure experienced during gas turbine operation. Our objective was to evaluate the impact of sintering on the mechanical and thermal properties of the YSZ coating.

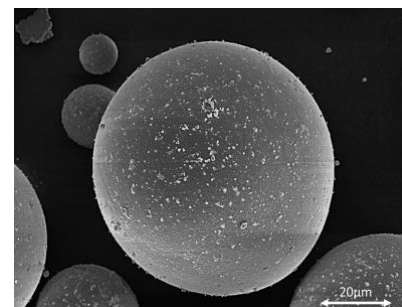
## 2. Materials and Methods

Commercially available yttria stabilize zirconia (Oerlikon Metco- 204NS) were used to produce the coatings. Plasma spraying was carried out using with F4MB plasma spraying gun and the plasma spraying parameters were given in Table 1. Coatings were produced on a stainless steel without applying a bond coat. Plasma spraying process were continued to obtain at least 1mm coating thickness. After obtaining the desired thickness, coatings were peeled off from the substrate mechanically. Spraywatch 2ii high speed camera were used to measure the particle temperatures and velocities with a focus distance 20cm(Cizek & Khor, 2012).

**Table 1.** Plasma spraying parameters.

Argon Flow (NLPM)	Hydrogen Flow (NLPM)	Current (Ampere)	Spray Dist. (mm)	Powder Feed
60	8	450	150	30g/min

Figure 2 shows the used powder SEM image. The powder consists of spherical particles from agglomerated particles.



**Figure 2.** SEM image of the used powder for plasma spraying.

Heat treatment were carried out in a laboratory type furnace. Mechanically removed free-standing coatings were placed in the furnace at 1150°C degrees for 50 and 100 hours under atmospheric conditions. The furnace was set to heat up and cool down for 5°C per minute.

Porosity measurement was performed using Archimedes' Principles. In order to achieve the consistency of the measurement for each heat treatment steps same samples were used. Densities and open porosities of the coatings were determined according to Archimedes' principle. Because this immersion method only allows the determination of open porosities, image analysis (IA) was also used (OpenCV, Python). These examinations were performed based on micrographs taken from optical microscopy at 200x magnification. Measurements were repeated at 10 different areas for each sample.

Thermal properties of the samples were measured using LFA 1000 laser flash thermal conductivity measurement device with 5 watts of laser power. This measurement uses half time for temperature increase of the other side of the sample and gives the thermal diffusivity of the measured sample then, thermal conductivity was calculated using Eq 1, where density  $\rho$  was obtained by Archimedes' principle at room temperature. Specific heat capacity  $C_p$  values were adopted from literature (Clark III & Taylor, 1975; Vassen et al., 2000)

$$\lambda = D_{th} C_p \rho. \tag{1}$$

Mechanical tests were carried out using a micro indentation device that registers the force and depth of the indenter tips. All tests were conducted for a maximum 100mN force threshold. When the force reached a defined value 5 seconds wait time was utilized to better prevent and monitor the porosity effect while determining the mechanical properties.

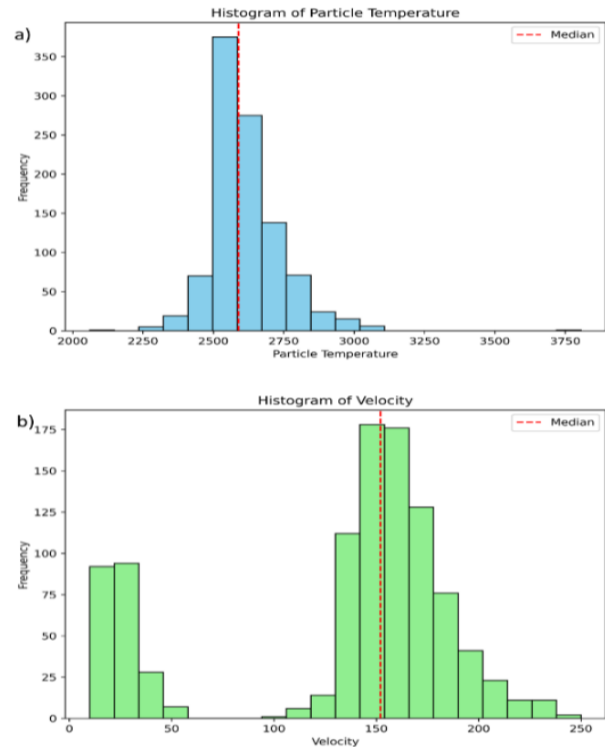
### 3. Result and Discussion

Figure 3 provides valuable insights into the plasma spraying process by illustrating the measured particle temperature and velocities. The graph reveals significant information about the distribution of these parameters, which play a crucial role in determining the quality and structure of the resulting coatings.

The particle temperature displayed a Gaussian-type curve, this temperature variation can arise due to factors such as particle size and carrier gas flow rate. It is important to note that achieving a narrow distribution in particle temperature is desirable for obtaining a homogeneous coating structure in terms of evenly melting the particle. All of the plasma spraying parameters concentrate and produce the output as particle temperature and velocity. Therefore, these values are essential for evaluating the plasma spraying parameters.

In contrast to the temperature distribution, the particle velocity distribution in Figure 3 exhibits two distinct peaks. This indicates the presence of particles with different velocities during the plasma spraying process. This dual-peak profile can be attributed to various factors, including differences in particle size, injection velocity, and the interaction of particles with the plasma jet. However, it is important to note that such distinct velocity profiles can adversely affect coating quality. The presence of two separate velocity peaks often leads to the formation of loosely bonded particles and porosity in the coating. These phenomena occur because particles with different velocities experience different levels of interaction with the substrate

and other particles. As a result, the porosity ratio of the coating is affected from the particle velocity rather than the temperature of the particles.



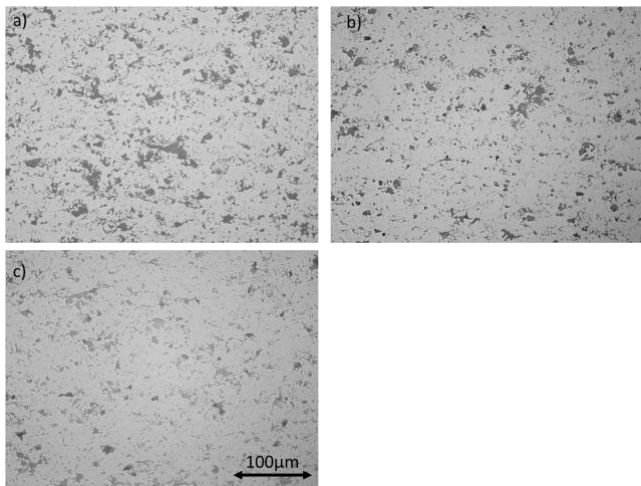
**Figure 3.** Distribution of the a) particle temperature b) particle velocity during spraying.

Figure 4 presents the scanning electron microscopy (SEM) micrographs of the samples. The micrographs reveal that the coatings exhibit a crack-free structure. Dark areas within the coating structure can be observed, corresponding to porosities or voids. Comparing with the particle velocity values these voids often comes from the low velocity particles because during the impact to the substrate low velocity does not ensure adequate adhesion.

As the testing time increased, a noticeable reduction in the number of dark spots, representing porosities, was observed. This suggests that the sintering process, induced by the prolonged exposure to high temperatures, led to the densification of the coating. The reduction in porosities indicates an improvement in the coating's microstructure and overall density(Karaoglanli, 2023)

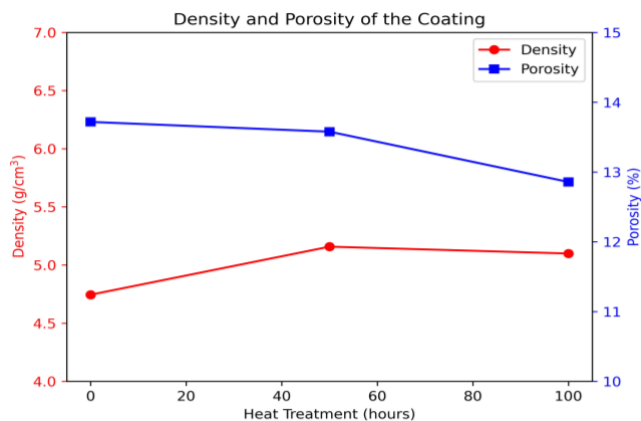
Figure 5 displays the density and porosity values of the coating at varying heat treatment times. In the as-sprayed condition (0 hours), the coating exhibited a lower density and a higher porosity ratio. This observation is reasonable as the as-sprayed coating typically possesses a high degree of micro defects and porosity coming from the nature of the plasma spraying.

As the heat treatment time increased, the porosity of the coating gradually decreased and dropped below 13%. Simultaneously, the density of the coating displayed a linear trend after 50 hours of heat treatment. This behaviour can be attributed to the initial stages of the heat treatment process, during which microdefects originating from the plasma spraying process undergo a recovery stage. The heat treatment helps in the healing and densification of the coating's microstructure, resulting in a reduction in porosity and an increase in density(Vassen et al., 2000).



**Figure 4.** Cross section SEM images samples a) as sprayed b) 50h heat treated c) 100h heat treated.

Furthermore, it is important to note that the Archimedes principle, used to measure the density in this study, considers only open porosity. Therefore, after 50 hours of heat treatment, where the open/close porosity remained relatively unchanged, the density value appeared to plateau.



**Figure 5.** Density (left) and porosity (right) results of the samples.

Figure 6 displays the thermal conductivity values of the samples with different heat treatment times. The results demonstrate that the as-sprayed sample exhibited a lower thermal conductivity compared to the 50-hour and 100-hour heat-treated samples. Interestingly, the thermal conductivity of the as-sprayed sample increased after reaching a temperature of 800°C, which deviates from the typical behavior of thermal conductivity decreasing with increasing temperature.

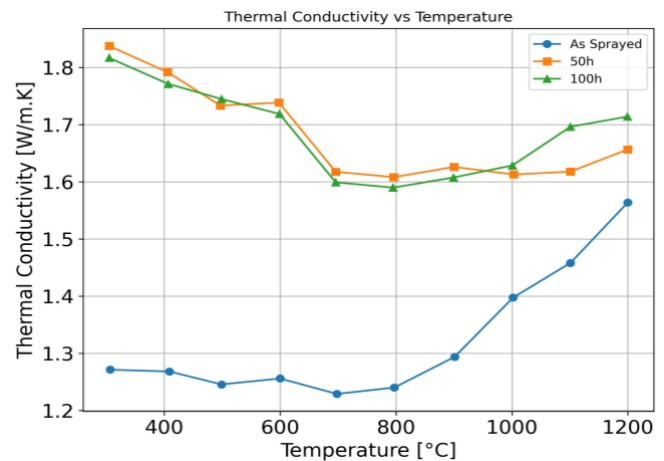
The thermal conductivity behavior of materials is often described by different models, which consider the unique characteristics of metals and nonmetals. The effect of temperature on thermal conductivity differs between these two classes of materials. In metals, the dominant mechanism for heat conduction is the mobility of free electrons. According to the Wiedemann-Franz law, the thermal conductivity of metals is approximately proportional to the product of the absolute temperature (measured in kelvins). On the other hand, in nonmetals, heat conduction predominantly occurs through lattice vibrations known as phonons. Unlike in metals, the phonon mean free path in nonmetals is generally not significantly reduced at higher temperatures. As a result, the thermal conductivity of nonmetals remains relatively constant at elevated temperatures. Considering these types of behaviors of materials, heat conduction in thermal barrier coatings occurs

by phonon vibrations (Clarke & Phillpot, 2005). Phonon vibration also is affected by the impurities or point defects in the crystal structure of non-metallic systems.

On the as-sprayed sample the increasing heat conductivity observation is the result of the micro defects coming from the rapid solidification during the plasma spraying process. The observed increase in thermal conductivity for the as-sprayed sample at temperatures above 800°C can be attributed to the presence of macro strains and micro-cracks within the coating structure (Bansal & Zhu, 2007)

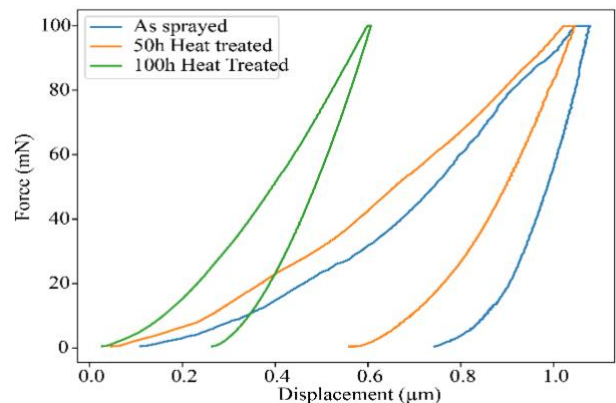
During the measurement samples were subjected to the heat resulting a recovery as it was observed with the density measurement.

Heat-treated samples did not show an increase with increasing temperature as it was expected. These findings suggest that controlling the microstructure of the coating can have a significant impact on achieving lower thermal conductivities. The mitigation of sintering effects, which contribute to the densification of the coating, may be a potential avenue for achieving even lower thermal conductivity and, consequently, improving the thermal performance of gas turbine components.



**Figure 6.** Measured thermal conductivity of samples.

Fig 7 presents the micro indentation test for single measurements. It can be observed that the maximum penetration depth ( $h_{max}$ ) decreases with increasing annealing time, whereas the slope of the unloading curve increases. This behavior can be attributed to the progressive densification of the coating as it was also observed in porosity measurements. Same finding also observed in a similar work that evaluated mechanical properties of YSZ coatings (Zotov et al., 2009).



**Figure 7.** Force and displacement curves of the samples obtained from the micro indentation test.



### 3. Conclusion

We have successfully produced YSZ coating with plasma spraying and heat treatment to the sample to investigate their sintering behavior and its effect on the thermal properties. The findings revealed as sprayed coating showed the lowest thermal conductivity while having a higher porosity. While heat-treated samples showed a similar thermal conductivity value, it was observed sintering still continued to occur as it was found from density and porosity measurements. This finding indicates that the initial microstructure of the coating might have micro defects in the crystal structure of the sprayed YSZ particles lowering the thermal conductivity properties. This finding also implies that employing micro defects or porosity to coating structure without compromising the mechanical properties helps to lower the thermal conductivity of the TBCs. Further research is needed to explore advanced techniques for mitigating sintering effects and developing more efficient and durable TBCs for gas turbine applications.

### Ethical approval

Not applicable.

### Conflicts of Interest

The authors declare that there is no conflict of interest regarding the publication of this paper.

### References

- Bansal, N. P., & Zhu, D. (2007). Effects of doping on thermal conductivity of pyrochlore oxides for advanced thermal barrier coatings. *Materials Science and Engineering: A*, 459(1–2), 192–195.
- Boyce, M. P. (2012). 11—Materials. In *Gas Turbine Engineering Handbook (Fourth Edition)* (pp. 493–514). Butterworth-Heinemann.
- Caron, P., & Khan, T. (1999). Evolution of Ni-based superalloys for single crystal gas turbine blade applications. *Aerospace Science and Technology*, 3(8), 513–523.
- Cipitria, A., Golosnoy, I. O., & Clyne, T. W. (2009). A sintering model for plasma-sprayed zirconia TBCs. Part I: Free-standing coatings. *Acta Materialia*, 57(4), 980–992.
- Cizek, J., & Khor, K. A. (2012). Role of in-flight temperature and velocity of powder particles on plasma sprayed hydroxyapatite coating characteristics. *Surface and Coatings Technology*, 206(8–9), 2181–2191.
- Clark III, L. M., & Taylor, R. E. (1975). Radiation loss in the flash method for thermal diffusivity. *Journal of Applied Physics*, 46(2), 714–719.
- Clarke, D. R., Oechsner, M., & Padture, N. P. (2012). Thermal-barrier coatings for more efficient gas-turbine engines. *MRS Bulletin*, 37(10), 891–898.
- Clarke, D. R., & Phillpot, S. R. (2005). Thermal barrier coating materials. *Materials Today*, 8(6), 22–29.
- Coble, R. L. (1963). A Model for Boundary Diffusion Controlled Creep in Polycrystalline Materials. *Journal of Applied Physics*, 34(6), 1679–1682. <https://doi.org/10.1063/1.1702656>
- Deshpande, S. (2013). High Temperature Sintering and Oxidation Behavior in Plasma Sprayed TBCs [Single Splat Studies] Paper 1—Role of Heat Treatment Variations. *Journal of Surface Engineered Materials and Advanced Technology*, 03(01), 106–115. <https://doi.org/10.4236/jsemat.2013.31A015>
- Grady, J. E. (2013). CMC Technology Advancements for Gas Turbine Engine Applications. <https://ntrs.nasa.gov/search.jsp?R=20140000458>
- Karaoglanli, A. C. (2023). Structure and durability evaluation of blast furnace slag coatings and thermal barrier coatings (TBCs) under high temperature conditions. *Surface and Coatings Technology*, 452, 129087.
- Ozgurluk, Y., Doleker, K. M., & Karaoglanli, A. C. (2018). Hot corrosion behavior of YSZ, Gd<sub>2</sub>Zr<sub>2</sub>O<sub>7</sub> and YSZ/Gd<sub>2</sub>Zr<sub>2</sub>O<sub>7</sub> thermal barrier coatings exposed to molten sulfate and vanadate salt. *Applied Surface Science*, 438, 96–113.
- Vassen, R., Cao, X., Tietz, F., Basu, D., & Stöver, D. (2000). Zirconates as New Materials for Thermal Barrier Coatings. *Journal of the American Ceramic Society*, 83(8), 2023–2028.
- Zotov, N., Bartsch, M., & Eggeler, G. (2009). Thermal barrier coating systems—Analysis of nanoindentation curves. *Surface and Coatings Technology*, 203(14), 2064–

**Cite this article:** Erdogan, G. (2023). Understanding the Sintering Behavior and its Effect on the Thermal Conductivity of YSZ Coatings for Gas Turbine Applications. *Journal of Aviation*, 7(2), 204-208.



This is an open access article distributed under the terms of the Creative Commons Attribution 4.0 International License

Copyright © 2023 Journal of Aviation <https://javsci.com> - <http://dergipark.gov.tr/jav>



# Obtaining Condition Monitoring Data for the Prognostics of the Flight Time of Unmanned Aerial Vehicles

Melih Erşen<sup>1</sup> , Mehmet Konar<sup>2\*</sup> 

<sup>1\*</sup>Cappadocia University, Vocational College, Aircraft Technology, 50400, Nevşehir, Turkey. (e-mail: melih.ersen@kapadokya.edu.tr)

<sup>2</sup>Erciyes University, Faculty of Aeronautics and Astronautics, Aeronautical Electrical and Electronics, 38039, Kayseri, Turkey. (e-mail: mkonar@erciyes.edu.tr)

## Article Info

Received: 05 June 2023  
Revised: 20 June 2023  
Accepted: 26 June 2023  
Published Online: 01 July 2023

### Keywords:

UAV  
Flight Time  
Range Increase  
Prognostic

Corresponding Author: Mehmet Konar

## RESEARCH ARTICLE

<https://doi.org/10.30518/jav.1309731>

## Abstract

In recent years, the use of Unmanned Aerial Vehicles (UAVs) that can fly at low and medium altitudes has become widespread in the world. Knowing the airtime and the maximum range that the UAVs, which are used in critical missions, especially in the military field, are important for the reliability of the mission to be carried out. Therefore, in this study, the creation of a data set to calculate the flight time and range of the UAV using the prognostic method, which is one of the heuristic methods, is discussed.

For this purpose, a fixed-wing UAV was used in this study to create the data set to be used in the prognostic methods. The UAV used in flights has a weight of 2.5 kg, a wingspan of 1.3 m, and a body length of 1 m. In addition, thanks to the control card used in the UAV, both manual and autonomous flights were made. The flight data of the UAV was transferred to the Ground Control Station (GGS) instantly.

As a result, data sets were obtained from manual and autonomous flights to be used in the prognostic method. By using these data sets, it will be possible to calculate the duration and range of the UAV in the future flights.

## 1. Introduction

Unmanned aerial vehicles (UAVs) have become popular in many civilian and military fields in recent years due to their potential to be used in challenging and critical areas and to offer solutions in a wide range of applications.

The remaining flight time of UAVs in the air depends on the payload, the length of the mission range, the capacity of the battery used in the UAV (Konar, 2019), atmospheric conditions such as temperature, pressure and wind, and many parameters (Arik et al., 2018, Oktay et al., 2018). However, one of the limitations of UAVs during the flight time is that this dependence constantly changes according to the flight environment (Coban, 2019, Coban et al., 2019, Mátyás et al., 2019).

For this reason, the use of UAVs in critical missions that require high flight time is unreliable. Unexpected discharge of the battery of the UAV during flight will result in loss of material and equipment, and more importantly, the failure of the intended mission. As a result, the need for reliable diagnostic and prognostic models that can predict the current Battery Health Status (BHS) and Remaining Flight Time of the UAV is increasing day by day. Studies in this field are of great interest both in the literature and in practical applications (Schacht-Rodríguez et al., 2019).

BHS is one of the critical parameters regarding how much energy is left in the battery. It is used as a diagnostic measure

in batteries, as it is accepted as the basic building block of BHS's battery management system. (Andre et al., 2013). However, this diagnostic may not be used to directly measure the condition of the battery.

For this reason, a number of battery diagnostic approaches have been proposed in the literature, such as the voltage-temperature thermal runaway method (Tran et al, 2022), the median expectation-based diagnostic approach (Khalid et al., 2015), the Bayesian statistical approach (Saha et al., 2007), the ampere-hour integral method (Yang et al., 2015), the particle filtering approach (Yan et al., 2017), the open-circuit voltage method (Lee et al., 2008), the extended kalman filter (Wu et al. al., 2016).

Remaining Useful Life (RUL) is defined as the time when the performance of equipment used in a system first falls to the failure threshold (Zhang et al., 2018). If RUL can be predicted with high accuracy, precautionary measures can be taken to repair and maintain the equipment used. Model-based and data-driven methods can be used in RUL methodologies (Hu et al., 2014).

Lithium-Polymer (Li-Po) batteries, which are frequently used in UAVs, have a nonlinear and time-varying dynamic electrochemical process throughout the discharge process. Therefore, the use of model-based approaches in Li-Po batteries may not be useful in practice, as too many parameters and complex calculations are required during the discharge process. (Eleftheroglou et al., 2019). As a result, model-based

approaches are mostly used for theoretical research and battery status determination (Lin et al., 2015). Data-driven approaches, on the other hand, do not require prior knowledge of the physics of the system, as they rely on measured data to derive the discharge process of Li-Po batteries.

In this study, it was aimed to obtain data sets for data-based prognostic methods. In order to realize this aim, a fixed-wing UAV has been produced. After the production, the manual and autonomous flight tests of the UAV were successfully carried out, and useful data were obtained to be used in the data-based prognostic model, and these data are presented in the third section. In the last section, conclusions and discussions are given.

## 2. Materials and Methods

Aviation started in the early 1900s and developed rapidly in parallel with technological developments. However, as a result of the globalization and modernization experienced in the field of technology in the world in recent years, the production of UAVs which is a new type of aircraft operating in many fields has begun. Demands for cheap and practical aircraft are increasing day by day, especially in military and civilian areas. These increasing demands have reduced the need for manned aircraft. Produced UAVs can perform high-risk missions without putting the pilot's life in danger unnecessarily. For this reason, UAVs have become an important industry for many military and civil aircraft manufacturers. In addition, UAVs have become one of the remarkable research areas for academia in terms of cheap cost and accessibility (Keane et al., 2013).

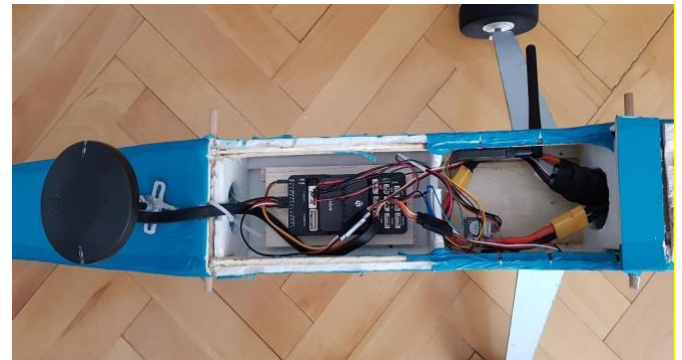
Today, UAVs, which have many different types and areas of use, are mostly classified according to their weight and the maximum altitude they can reach. Nano UAVs, which have the lowest value in terms of flight weight and altitude are generally used in tracking and monitoring in the military field. Micro UAVs with a flight weight of between 100g and 1000g and a flight altitude of less than 500 feet are mostly flown as a hobby. The UAVs used in this study with a flight weight of between 1 kg and 20 kg and a flight altitude of less than 5000 feet fall into the category of mini UAVs. Tactics, which have higher values according to flight weights and flight altitudes, are frequently used in military and agricultural spraying areas in Medium Altitude Long Endurance and High Altitude Long Endurance UAVs.

In this section, the UAV and the components of the UAV produced for the study are introduced. In addition, the importance of the method used is presented.

### 2.1. Produced UAV and Components

The UAV produced for this study is fixed wing. The UAV, which has an overhead wing and a standard tail configuration, has a body length of 100 cm, a wingspan of 130 cm and a weight of 1400 g. The main reason for using fixed wing UAV in this study is that the flight characteristics are quite stable. In addition, it can easily perform the desired tasks in autonomous flights. The fuselage view of the fixed-wing UAV is given in Figure 1. There is sufficient space inside the body for the placement of electronic components. It is aimed that all necessary electronic cards, sensors and batteries to be used for this purpose can be easily placed inside the body. For the body of the UAV, it was made using depron material with a thickness of 6 mm and a density of 30 kg / m<sup>3</sup>. Depron body

is covered with model coating. In Figure 2, the 3D model of the UAV drawn in the computer environment is given.

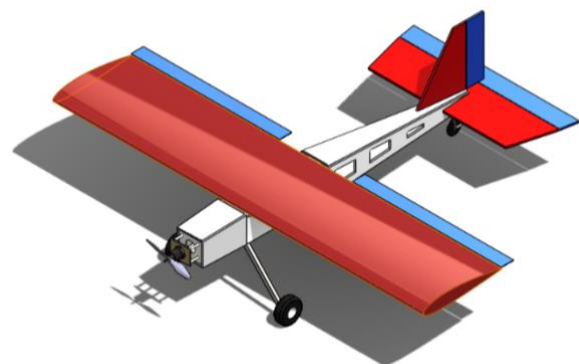


**Figure 1.** Electronic components of the produced UAV inside the body

The propulsion of the fixed-wing UAV produced is provided by a 1100 Kv brushless electric DC motor. The power required for the flight of the UAV is provided by a 3-cell Li-Po battery with a capacity of 3300 mAh and a discharge value of 25C.

In fixed-wing UAV systems, propellers are needed to get the thrust from the engine. Unlike other aircraft, this issue is of great importance in single-engine fixed-wing aircraft. Considering this situation, the compatibility of the engine, Electronic Speed Control Unit, propeller and battery used in the study is very important.

Pixhawk Cube, one of the stable and safe flight control cards with open source code system, was chosen for the flight control card used in the study. The Pixhawk Cube, which has a dual-core processor, meets the high processor capacity needed for the planning of autonomous flights required for this work. In addition, a telemetry system capable of broadcasting at 433 MHz is connected to the Pixhawk Cube used in the UAV. The telemetry system can provide data transfer directly compatible with the Pixhawk Cube. In addition, the flight data of the UAV can be monitored directly over GGS with APM planner and Ground Control software on the computer.



**Figure 2.** 3D model of UAV

### 2.2. Importance of the Method Used

It is important that the user can monitor the flight data that affects the performance of the UAV. The most important of the flight data obtained is the battery status data. Therefore, it is important to monitor the change in the voltage value of the battery in real time. Depending on the type of battery used, each battery has a different threshold. If the battery voltage drops below the threshold value, deterioration may occur in the

battery cells. As a result, battery life will be greatly reduced. The threshold voltage value for Ni-CD batteries, which are frequently used in UAVs, is 1.2 Volts, while the threshold voltage value for Li-Po batteries is 3.7 volts. If the flight operation continues below this threshold value, it will not be possible to use the battery properly. Li-Po batteries are packages created by the combination of many cells. The breakdown of any cell in the pack will directly affect the total voltage of the battery.

The amount of current drawn from the battery used in the UAV directly affects many different flight parameters of the UAV. Chief among these are the flight speed of the UAV, its altitude and the number of revolutions of the engine mounted on the UAV. The more these parameter values increase, the more the current drawn from the battery will increase accordingly. As a result, the remaining useful life of the battery will be reduced.

The produced UAV needs to climb to a certain altitude in order to perform its flight in a healthy way after the moment of take-off. This propulsion is provided by the brushless DC motor attached to the UAV. The power required for the rotation of the motor is provided by the Li-Po battery.

One manual flight and one autonomous flight data graph are presented from the flight tests. The diagram of how the data is received and transferred during the flight is given in Figure 3.

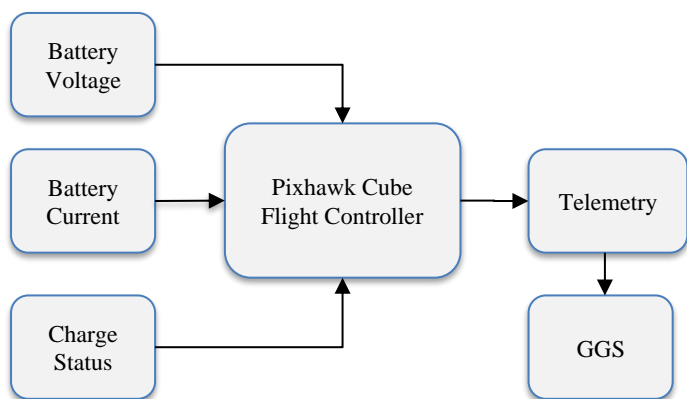


Figure 3. Scheme of receiving data from the UAV

### 3. Implementation Phase

During the successful flight tests of the produced UAV, many different parameters such as battery voltage from the controller inside the UAV, current drawn from the battery, percent capacity of the battery, flight altitude, air temperature and air pressure at the time of flight were successfully transferred to GGS. Among these parameters, the effect of battery voltage, current drawn from the battery and the percent capacity of the battery on the flight time of the UAV has been observed. Many flight tests were carried out within the scope of the study. The main charts created from the Pixhawk Cube flight control card and post-flight data are included in this section. The obtained data sets can be used to calculate flight time (seconds, sec) and range in data-based prognostic methods.

The image of the UAV taken before the manual and autonomous flight on the model airstrip is given in Figure 4. Their routes are shown in Figure 4, respectively.



Figure 4. Pre-take-off image of the produced UAV

Figure 5, Figure 6, Figure 7 and Figure 8 show the routes of the first, second, third and fourth flights performed manually on the Talas Municipality model airstrip, respectively. In Figure 9, the flight route performed in autonomous mode is given. Thus, the flight routes of the UAV became visual. The blue lines represent the flight path of the UAV in stabilized mode, the red lines represent the flight of the UAV in manual mode, and the purple color represents the flight of the UAV in the autonomous mode.

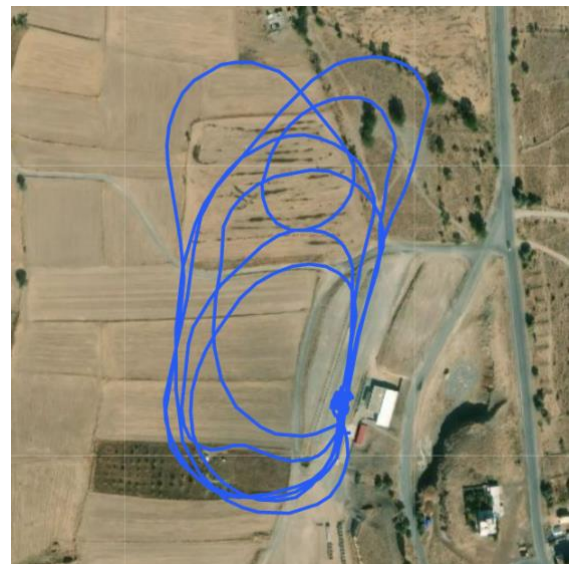


Figure 5. The 1st flight route of the UAV

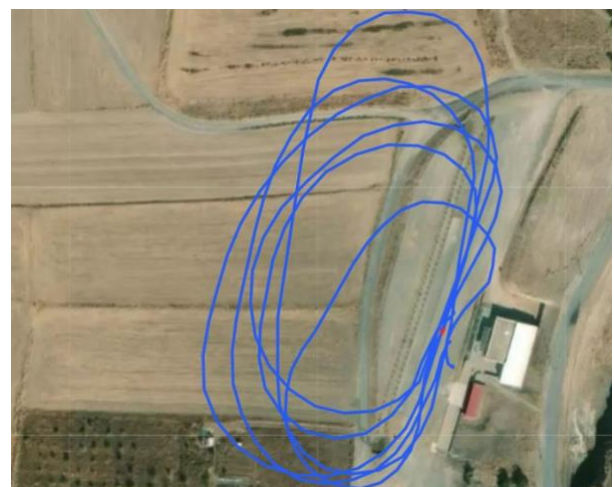


Figure 6. The second flight route of the UAV





Figure 7. The 3rd flight route of the UAV

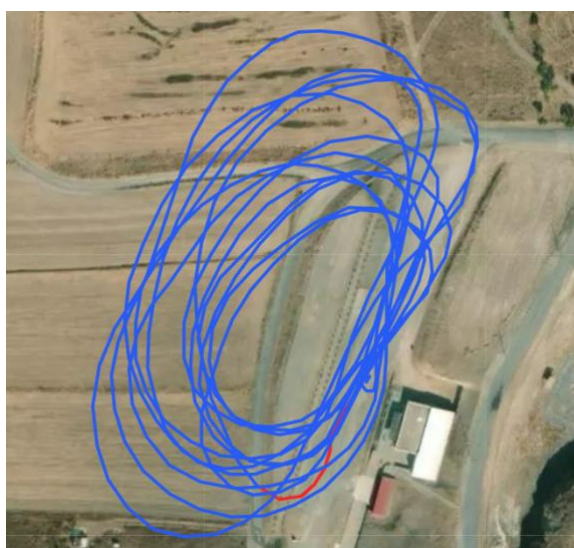


Figure 8. The 4th flight route of the UAV



Figure 9. The 5th flight route of the UAV

In Figure 10, Figure 11, Figure 12, Figure 13 and Figure 14, the current-time graphs drawn from the battery during the flight time of the UAV are presented. It has been observed that

the current drawn from the battery increases up to 25 Amps (A) when instantaneous power is drawn from the UAV for propulsion. In this way, the flight characteristics of the UAV can be estimated by looking at these data. As a result of the data received, no unusual situation was observed in the battery.

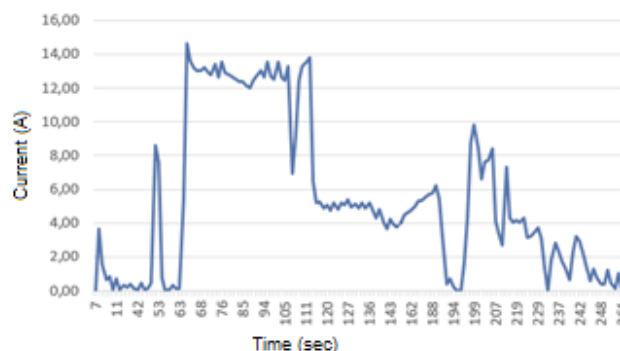


Figure 10. Current-time graph of the 1st flight of the UAV

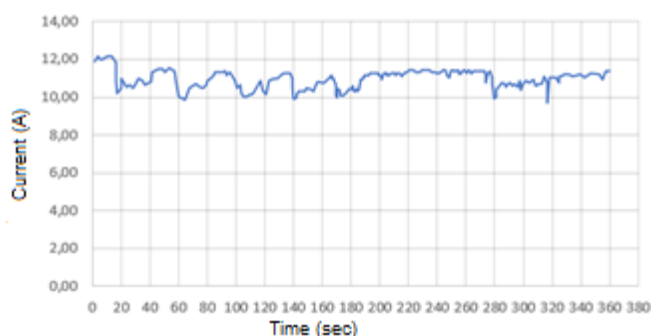


Figure 11. Current-time graph in the 2nd flight of the UAV

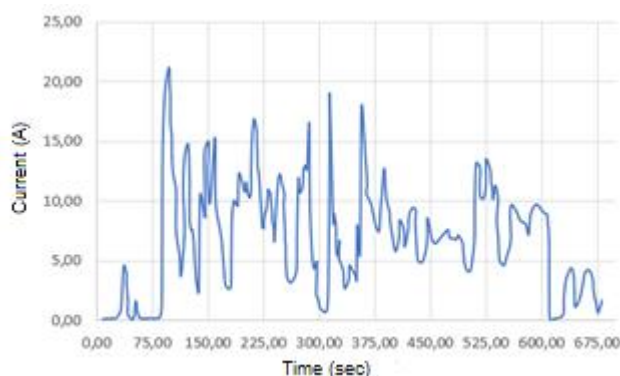


Figure 12. Current-time graph of the 3rd flight of the UAV

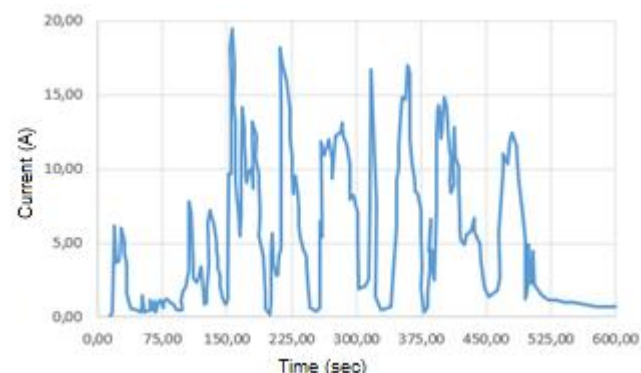


Figure 13. Current-time graph of the 4th flight of the UAV



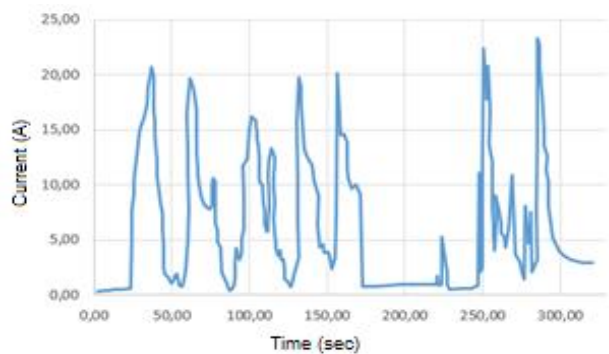


Figure 14. Current-time graph of the 5th flight of the UAV

In Figure 15, Figure 16, Figure 17, Figure 18 and Figure 19, the battery voltage-time graphs taken after five different flights with the UAV are presented. These flights were carried out with a 3S 3300 mAh fully charged battery. The fully charged battery voltage is 12.6 V. Since the battery was under load during the flight, the measured voltage decreased to 10 Volts momentarily.

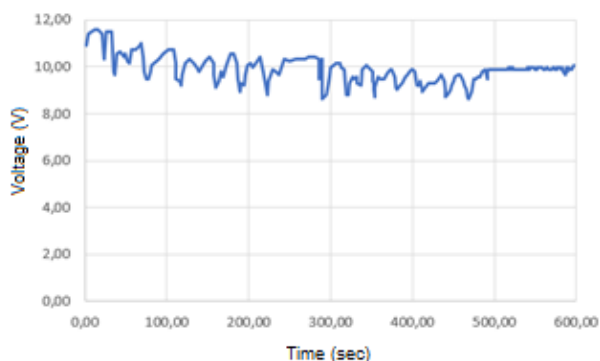


Figure 15. Voltage-time graph of the 1st flight of the UAV

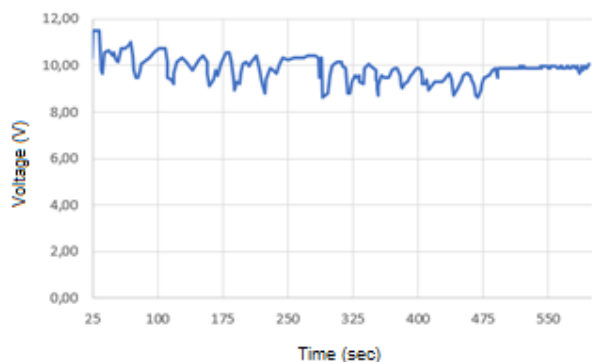


Figure 16. Voltage-time graph in the 2nd flight of the UAV

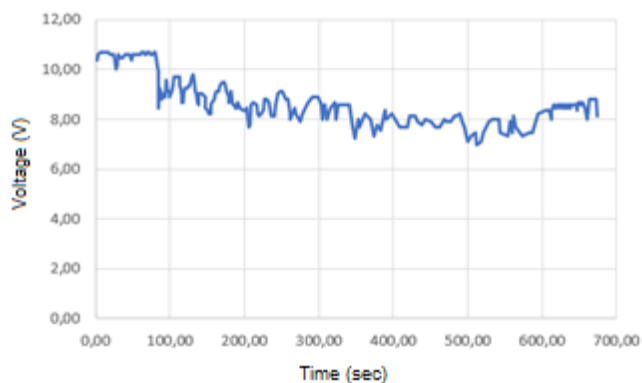


Figure 17. Voltage-time graph of the 3rd flight of the UAV

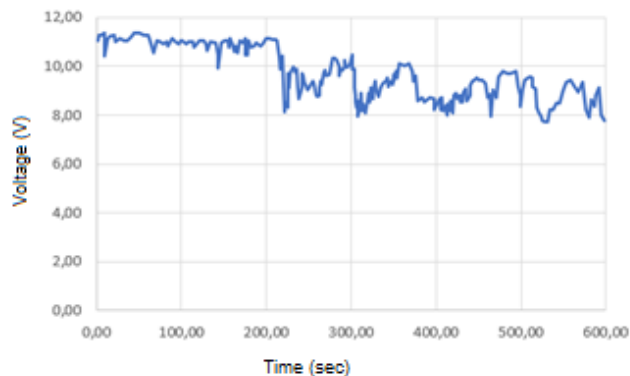


Figure 18. Voltage-time graph of the 4th flight of the UAV

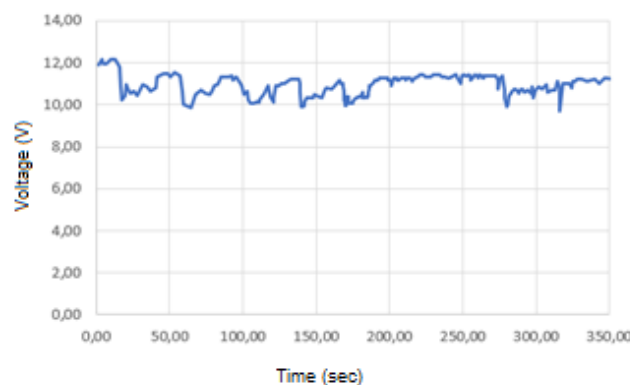


Figure 19. Voltage-time graph of the 5th flight of the UAV

#### 4. Conclusion and Discussion

In this study, it is aimed to obtain the necessary condition monitoring data for the calculation of the remaining useful life of the batteries used in fixed-wing UAVs by using prognostic methods. A total of 4 flights in manual and stabilized modes and 1 flight in autonomous mode were successfully completed with the produced UAV. During the flight, wind-related problems affecting the stability of the UAV were encountered. In long-haul flights, there were breakouts while data was being transferred from the UAV via the telemetry system. During manual, stabilized and autonomous flight, graphs of current drawn from the battery, graphs of voltage drawn from the battery, graphs of flight altitude, discharge graphs of the battery and graphs of the remaining battery percentage were taken from the UAV. As a result of the test flights, useful data was selected for the training of the prognostic software. The selected data has been converted into numerical data in the excel environment. In this way, situation monitoring data to be used in the prognostic software that will be used to calculate the flight time of the UAV in future flights were created. It is anticipated that the data in this study can be used to calculate the flight time of prognostic methods in military and civilian areas. In addition, it is thought that this study will shed light on researchers who will conduct studies on sportive aviation and prognostic methods.

#### Ethical approval

Not applicable.

#### Conflicts of Interest

The authors declare that there is no conflict of interest regarding the publication of this paper.

#### Acknowledgement

This study was supported by the Scientific Research Projects Unit of Erciyes University with the FYL-2020-9999 project code. Thank you for supports.

## References

- Andre, D., Appel, C., Soczka-Guth, T., and Sauer, D. U. (2013). Advanced mathematical methods of SOC and SOH estimation for lithium-ion batteries. *Journal of Power Sources*, 224, 20-27.
- Arik, S., Turkmen, I., and Oktay, T. (2018). Redesign of morphing UAV for simultaneous improvement of directional stability and maximum lift/drag ratio. *Advances in Electrical and Computer Engineering*, 18(4), 57-62.
- Coban, S., and Oktay, T. (2017). A review of tactical unmanned aerial vehicle design studies. *The Eurasia Proceedings of Science Technology Engineering and Mathematics*, 1, 30-35.
- Coban, S. (2019). Different autopilot systems design for a small fixed wing unmanned aerial vehicle. *Avrupa Bilim ve Teknoloji Dergisi*, 17, 682-691.
- Coban, S., Bilgic, H. H., and Oktay, T. (2019). Designing, dynamic modeling and simulation of ISTEICOPTER. *Journal of Aviation*, 3(1), 38-44.
- Eleftheroglou, N., Zarouchas, D., Loutas, T., Mansouri, S. S., Georgoulas, G., Karvelis, P., ... and Benedictus, R. (2019). Real time diagnostics and prognostics of UAV lithium-polymer batteries. In *Proceedings of The Annual Conference of the PHM Society*, 11 (1), 1-8.
- Hu, C., Jain, G., Tamirisa, P., and Gorka, T. (2014, June). Method for estimating capacity and predicting remaining useful life of lithium-ion battery. In *2014 International Conference on Prognostics and Health Management*, 1-8.
- Keane, J. F., and Carr, S. S. (2013). A brief history of early unmanned aircraft. *Johns Hopkins APL Technical Digest*, 32(3), 558-571.
- Khalid, H. M., Ahmed, Q., and Peng, J. C. H. (2015). Health monitoring of li-ion battery systems: A median expectation diagnosis approach (MEDA). *IEEE Transactions on Transportation Electrification*, 1(1), 94-105.
- Konar, M. (2019). GAO Algoritma tabanlı YSA modeliyle İHA motorunun performansının ve uçuş süresinin maksimizasyonu, *Avrupa Bilim ve Teknoloji Dergisi*, 15, 360-367
- Lee, S., Kim, J., Lee, J., and Cho, B. H. (2008). State-of-charge and capacity estimation of lithium-ion battery using a new open-circuit voltage versus state-of-charge. *Journal of Power Sources*, 185(2), 1367-1373.
- Lin, C., Tang, A. and Wang, W. (2015). A review of SOH estimation methods in lithium-ion batteries for electric vehicle applications. *Energy Procedia*, 75, 1920-1925.
- Mátyás, P., and Máté, N. (2019). Brief history of UAV development. *Repüléstudományi Közlemények*, 31(1), 155-166.
- Oktay, T., Arik, S., Turkmen, I., Uzun, M., and Celik, H. (2018). Neural network based redesign of morphing UAV for simultaneous improvement of roll stability and maximum lift/drag ratio. *Aircraft Engineering and Aerospace Technology*, 90(8), 1203-1212.
- Saha, B., Poll, S., Goebel, K., and Christophersen, J. (2007, September). An integrated approach to battery health monitoring using bayesian regression and state estimation. In *2007 IEEE Autotestcon*, 646-653.
- Schacht-Rodríguez, R., Ponsart, J. C., Garcia-Beltran, C. D., Astorga-Zaragoza, C. M., and Theilliol, D. (2019, June). Mission planning strategy for multirotor UAV based on flight endurance estimation. In *2019 International Conference on Unmanned Aircraft Systems (ICUAS)*, 778-786.
- Tran, M. K., Mevawalla, A., Aziz, A., Panchal, S., Xie, Y., and Fowler, M. (2022). A review of lithium-ion battery thermal runaway modeling and diagnosis approaches. *Processes*, 10(6), 1192.
- Yan, W., Zhang, B., Dou, W., Liu, D., and Peng, Y. (2017). Low-cost adaptive lebesgue sampling particle filtering approach for real-time li-ion battery diagnosis and prognosis. *IEEE Transactions on Automation Science and Engineering*, 14(4), 1601-1611.
- Zhang, Y., Xiong, R., He, H., and Pecht, M. G. (2018). Long short-term memory recurrent neural network for remaining useful life prediction of lithium-ion batteries. *IEEE Transactions on Vehicular Technology*, 67(7), 5695-5705.
- Wang, H., Wang, X., Wang, L., Wang, J., Jiang, D., Li, G., ... and Jiang, Y. (2015). Phase transition mechanism and electrochemical properties of nanocrystalline MoSe<sub>2</sub> as anode materials for the high performance lithium-ion battery. *The Journal of Physical Chemistry C*, 119(19), 10197-10205.
- Wu, C., Zhu, C., Sun, J., and Ge, Y. (2016). A synthesized diagnosis approach for lithium-ion battery in hybrid electric vehicle. *IEEE Transactions on Vehicular Technology*, 66(7), 5595-5603.

**Cite this article:** Ersen, M., Konar, M. (2023). Obtaining Condition Monitoring Data for the Prognostics of the Flight Time of Unmanned Aerial Vehicles. *Journal of Aviation*, 7(2), 209-214.



This is an open access article distributed under the terms of the Creative Commons Attribution 4.0 International License

**Copyright © 2023 Journal of Aviation** <https://javsci.com> - <http://dergipark.gov.tr/jav>

# A PESTEL Analysis of The Impacts of COVID-19 Crisis on Air Transportation Sector's Future

Adem Pinar<sup>1\*</sup> <sup>1\*</sup> School of Business, Shenandoah University, 1460 University Drive, Winchester, VA 22601, United States. (adempinar@yahoo.com)

## Article Info

Received: 02 March 2023  
 Revised: 31 May 2023  
 Accepted: 07 June 2023  
 Published Online: 09 July 2023

### Keywords:

Covid-19  
 Aviation  
 Transportation  
 PESTEL analyses

Corresponding Author: Adem Pinar

## RESEARCH ARTICLE

<https://doi.org/10.30518/jav.1259307>

## Abstract

In this study, the Covid-19 pandemic, which has significantly impacted the aviation industry, is examined from six external factors including political, economic, sociological, technological, environmental, and legal using a PESTEL analysis. Initially, flight restrictions were implemented due to the Covid-19 pandemic, and airline companies were also affected by government-imposed social distancing measures. Economically, the Covid-19 pandemic has been particularly damaging to passenger transportation, with some countries experiencing a recovery but others facing employment issues in the industry. Sociologically, there has been an increase in reluctance to fly and changes in consumer behavior and habits, with a decrease in demand for unnecessary products. This process has also led to a number of positive developments from a technological standpoint, such as the rapid development and deployment of new vaccines and health monitoring technologies, as well as a decrease in emissions from the industry. This study is original in its examination of the Covid-19 pandemic impacts on the aviation industry using a PESTEL analysis. Based on the study's findings, strategies should focus on restructuring the aviation industry for Covid-19 pandemic readiness and recovery, including promoting restructured travel packages, low-cost flights, and popular routes. Emphasis on energy efficiency and environmental sustainability is crucial.

## 1. Introduction

The outbreak of COVID-19 in December 2019 in China and its subsequent declaration as a pandemic by the World Health Organization on March 11, 2020, have had a noteworthy influence on several industries. Including healthcare, transportation, global supply chains, communication, and manufacturing. The threat of the pandemic disease has led to the implementation of new policies, such as travel restrictions and the closure of national borders by countries, which have caused a significant disruption in air and sea transportation, a halt in passenger transport services, and a striking increase in the costs of commercial goods. These disruptions have had a profound impact on the international transportation industry (Vo & Tran, 2021; Zimmerling & Chen, 2021).

The Covid-19 crisis has had a significant impact on the aviation industry in many ways. When examined from a political perspective, flight restrictions began in the early months of 2020 due to the pandemic, causing the global cost per kilometer per passenger to drop by up to 65%. Airlines were affected by social distancing restrictions implemented by governments, and Ryanair and Delta airlines even opposed these measures (Heiets & Yibing, 2021).

From an economic standpoint, Covid-19 has dealt a major blow to the aviation industry, particularly in passenger transportation. While some countries experienced recovery during the pandemic process (Su et al., 2022; Vieira et al.,

2022), rising fuel prices and the crisis in Ukraine led to employment issues in many countries' aviation sectors (Deveci et al., 2022). Sociologically, the Covid-19 pandemic has increased concerns about flying, changed consumer behaviors and habits, and reduced demand for unnecessary products. Another sociological issue could be the potential increase in prejudice towards Asian races in Western societies due to the virus originating from China. From a technological perspective, the rapid development of new vaccines, health monitoring technologies, contactless delivery systems such as drones, and the proliferation of e-commerce can be seen as positive effects of the pandemic (Heiets & Yibing, 2021).

Regarding the environmental effects of the pandemic, besides the positive effects such as improved air quality due to reduced CO2 emissions, clean beaches, and reduced environmental noise, negative effects such as increased waste and decreased recycling can also be considered among the pandemic's negative impacts (Irfan et al., 2022). As for the its effects on legal issues, the restriction of human rights and freedoms, healthcare workers' rights and job security, and mandatory mask and vaccine requirements in emergency situations, especially regarding travel, have been the subject of debate in many countries, affecting the aviation industry as well (Kang & Disemadi, 2021; Kaya et al., 2021).

In this study, the effects of the COVID-19 pandemic on the aviation sector is investigated by conducting a comprehensive PESTEL (political, economic, sociological, technological, environmental, and legal) analysis (Fahey & Narayanan, 1986;

Sammut-Bonnici & Galea, 2014). The research questions guiding this study are:

How did the COVID-19 pandemic impact the aviation industry in terms of political, economic, sociological, technological, environmental, and legal factors?

What were the contrasting effects of the COVID-19 pandemic on global and domestic passenger and cargo flights?

Based on these research questions, the research hypothesis was that the COVID-19 pandemic significantly affected the aviation industry, resulting in a range of consequences such as changes in government policies, economic downturn, shifts in consumer behavior, technological advancements, environmental implications, and legal considerations. By analyzing the PESTEL factors, it is aimed to gain a comprehensive understanding of the positive and negative effects of the pandemic on the aviation sector and identify the short, medium, and long-term trends in its impact.

In the second part of the study, the literature was reviewed, in the third part, the methodology was explained and the effects of COVID-19 on the aviation sector were presented in light of the criteria. In the fourth part, conclusions were drawn, and future research was suggested. In this study, the term "pandemic" refers to the COVID-19 pandemic that began in China in 2020.

## 2. Literature Review

The effects of the pandemic on the aviation industry has been studied in the literature by considering both global and local dimension. Heiets and Yibing (2021) analyzed the global effects of the pandemic through a PEST analysis, identifying

short and long-term solutions from a political, economic, social, and technological perspective. Avcı et al. (2022) examined the effects of the pandemic on the air cargo sector, noting that aircraft have undergone modifications. Metehan et al. (2021) investigated airline companies decision parameters (strategic and financial) during the pandemic crisis through data envelopment analysis, revealing the requirements for a robust structure.

In terms of future-oriented analyses, Kurnaz and Žilinskienė (2022) examined the problems of the aviation sector during the pandemic and made projections for the post-pandemic period on a global scale. Serrano and Kazda (2020) evaluated the effects of this crisis on the future of airports. Many studies have been conducted on the effects of the COVID-19 crisis on the aviation industry at the country level (Table 1.b.). Onianwa (2022) examined the impact of the pandemic on Nigeria's air cargo sector, Deveci et al. (2022) investigated the effects of the pandemic on Turkey's civil aviation sector, Vieira et al. (2022) analyzed the effects of the pandemic on Brazil's airline transportation and CO2 emissions, and finally, Su et al. (2022) found that the air passenger transportation sector in China, where the COVID-19 outbreak began, recovered more quickly than other countries. To summarize the literature review, it can be concluded that the majority of research regarding the effects of the COVID-19 pandemic on the aviation sector has focused either on a regional level (Table 1.b) or has examined the topic within a global context (Table 1.a) but with narrow parameters, such as financial crises or future ramifications exclusively.

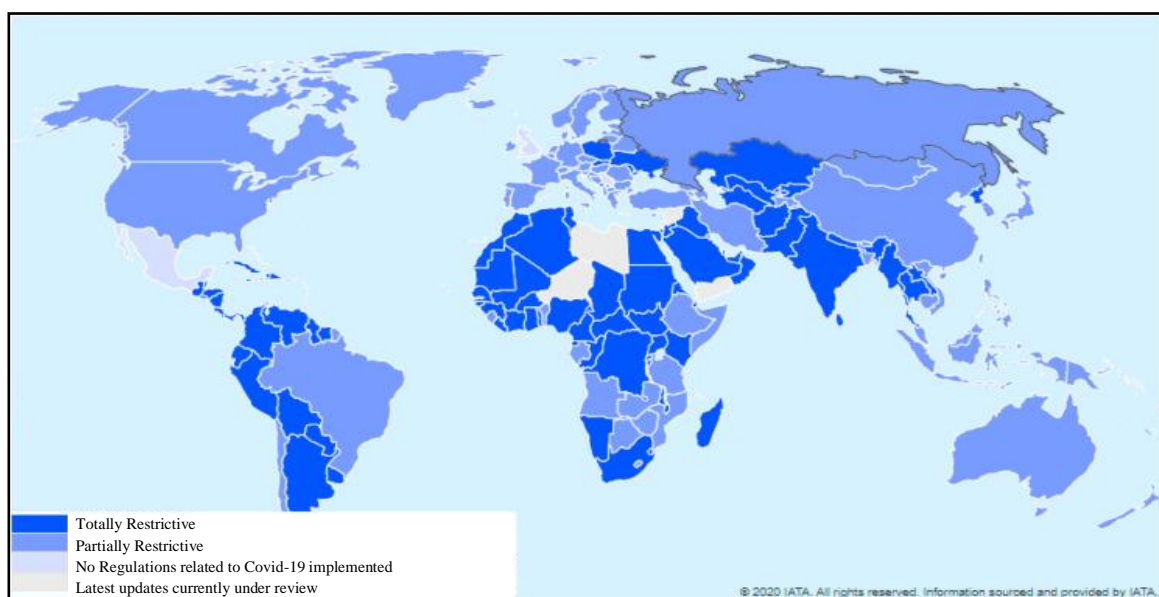
**Table 1.a** Literature Review (Global Impacts of COVID-19)

No.	Author(s) and Year	Topic of the Study	Methodology	Findings
1	(Heiets & Yibing, 2021)	The Effects of COVID-19 Pandemic on Aviation	PEST Analysis	Political, economic, social, and technological impacts were identified and short and long-term solution proposals were presented.
2	(Kurnaz & Žilinskienė, 2022)	The Impacts of COVID-19 on the Future of Aviation	Analyses	It was indicated that although the difficulties during the pandemic period are starting to improve, lessons must be learned for the future from these problems.
3	(Avcı et al., 2022)	The Effects of COVID-19 Pandemic on Air Cargo Sector	Analyses	It was noted that cargo demand increased during this period, some passenger aircrafts were modified, and passenger and cargo (combi) transportation began.
4	(Serrano & Kazda, 2020)	The Future of Airports in the Post-COVID-19 Period	Explanatory Analyses	The future of airports was examined according to three different scenarios and it was predicted that designs related to safety and other issues will be renewed.
5	(Metehan et al., 2021)	Analysis of Strategic and Financial Decision Factors of Airline Companies During the COVID-19 Crisis	Data Envelope Analyses	The financial structures of airline companies were analysed and the necessary parameters to set up a good financial structure during the COVID-19 crisis were identified.
6	(Atalan & Atalan, 2022)	The Impact of Air Transportation on the Spread of COVID-19	Analyses	As a result of the analysis of the first 8 months of the pandemic period, it was suggested that air transportation directly affected the spread of the pandemic and measures should be continued.



**Table 1.b** Literature Review (Regional Impacts of COVID-19)

No.	Author(s) and Year	Topic of the Study	Methodology	Findings
1	(Su et al., 2022)	Impact of COVID-19 on China's air transportation sector	Moran index and econometric models	The Chinese aviation sector was severely affected by the COVID-19 crisis, with transportation in major cities recovering before the global aviation sector.
2	(Onianwa, 2022)	Impact of the pandemic on air transportation in Nigeria	Analysis	Global cooperation and information sharing are recommended to mitigate the negative effects of the pandemic.
3	(Deveci et al., 2022)	Impact of the pandemic on Turkey's civil aviation sector	Analysis	Increased cargo flights, decreased passenger transportation, and negative effects on personnel salaries and unemployment were observed.
4	(Vieira et al., 2022)	Impact of the pandemic on Brazil's air transportation and CO2 emissions	Analysis	Despite a 68% decrease in passenger numbers at the beginning of the pandemic, Brazil's aviation sector saw a 64% increase in 2021.
5	(Kang & Disemadi, 2021)	Legal perspective of the pandemic, case study of Indonesia	Normative research	The pandemic's effects on travel freedom, occupational safety, quarantine, and other legal and human rights issues were evaluated in Indonesia.,
6	(Daon et al., 2020)	2020 Pandemic risk in air transportation	Probabilistic analysis	A scenario analysis showed that the risk of future pandemics in East Asian airports is higher than that in airports in India, Brazil, and Africa.
7	(Kökény et al., 2022)	Impact of COVID-19 on European airlines	Data analysis and sampling	Different business models of European airlines resulted in varying effects of the pandemic.
8	(Perez & Camargo, 2022)	Economic impact of the pandemic on air transportation sector	Regional Input-Output Model	Only the economic cost of the pandemic on air transportation in Texas Austin was identified.
9	(Nižetić, 2020)	Impact of COVID-19 on mobility, energy, and environment in air transportation sector	Analysis	A decrease of 89% in flights and an improvement of up to 3.5% in emissions were observed in the Croatian region at the beginning of the pandemic.



**Figure 1.** Global Flight Restrictions as of May 31, 2020 due to the Pandemic (IATA, 2020)

### 3. Methodology and Application

PEST analysis, proposed by Fahey and Narayanan in 1986, has evolved into PESTEL analysis by adding environmental and legal dimensions over time. The ETPS (economic, technological, political, and social) framework proposed by Aguiar was modified to STEP method by the Arnold Brown Institute. Later, the macroeconomic dimensions of environmental factors were added, resulting in the STEPE framework, and finally, in the 1980s, the legal dimension was also incorporated into the analysis, resulting in the current PESTEL approach (Yüksel, 2012). After explaining the PESTEL methodology in this section, the impact of the pandemic on the air transportation industry will be examined using this approach.

#### 3.1. Methodology

The PESTEL analysis is based on examining external factors in six areas: political, economic, sociological, technological, environmental, and legal. Political factors (P) refer to a range of aspects, including government interventions and lobbying activities. Economic factors (E) primarily address the macroeconomic landscape of the external environment, while also encompassing cyclical economic concerns. Social factors (S) encompass sociological, cultural, and demographic factors of the external environment. Technological factors (T) encompass technology-related initiatives, incentives, technological infrastructure, technological advancements, and external factors that influence technological progress (Ho, 2014). Economic factors (E) may cover many issues, such as unemployment, domestic and foreign debt, national income, investment incentives, budget deficit, and fiscal policies depending on the subject. Environmental factors generally include topics such as carbon dioxide emissions, urbanization, environmental pollution, traffic, public health, and recycling.

Several studies have highlighted the importance of PESTEL analysis in different areas. Yüksel (2012) acknowledges that while PESTEL analysis provides a general idea about the macro environmental conditions of a company, it lacks an integrated approach. To address this, the study proposes a multi-criteria decision-making model that combines AHP and ANP techniques to model the relationships between PESTEL factors. Song et al. (2017) utilize the PESTEL framework to analyze the waste-to-energy incineration industry in China, identifying obstacles and providing suggestions for policy changes and efficient project operation. Gregoric (2014) applies PESTEL analysis to tourism destinations, comparing and analyzing Croatia and Qatar in terms of political, economic, socio-cultural, technological, ecological, and legal factors, particularly in the context of the MICE (Meetings, Incentives, Conferences, and Exhibitions) industry. Matović (2020) emphasizes the significance of PESTEL analysis for startup success, proposing its use as a tool to evaluate the business environment and improve competitiveness. Çitilci and Akbalık (2020) emphasize that PESTEL analysis is essential for environmental scanning, providing a comprehensive understanding of factors that cannot be controlled or affected by an organization. These studies demonstrate the diverse applications of PESTEL analysis in assessing macro-environmental factors and guiding strategic decision-making processes in various domains.

PESTEL analysis, which is used in strategic management, has two main functions for organizations. The first is to

provide a better understanding of the environment in which the organization operates, and the second is to provide data and information that will enable the organization to predict future situations and conditions (Yüksel, 2012). In this study, using the PESTEL methodology, the effects of the pandemic, which has deeply affected our lives in many ways, on the aviation industry will be examined.

The utilization of the PESTEL methodology in this research showcases its robustness and advantage in providing a comprehensive approach by considering all six external factors: political, economic, sociological, technological, environmental, and legal. This allows for a holistic analysis of the impact of the COVID-19 pandemic on the aviation industry. While other methods may focus solely on one factor, the strength of PESTEL lies in its ability to consider multiple dimensions, providing a more comprehensive understanding of the challenges faced by the industry. However, it is important to note that the extensive scope of PESTEL may also be considered a potential disadvantage, as it may overlook certain specific influences on the industry, such as cultural, ethical, and competitive factors.

#### 3.2. Analyses

Based on the experiences gained from epidemic diseases such as SARS, Ebola, and influenza, it has been observed that air travel provides a suitable environment for the spread of pandemic diseases (Sun, Wandelt, Zheng et al., 2021). Similarly, numerous studies have suggested that intercontinental air transportation has played a significant role in the spread of the COVID-19 pandemic (Atalan & Atalan, 2022; Daon et al., 2020). Therefore, the aviation industry has been affected by external factors in many ways during the COVID-19 pandemic. In this section, six factors that have affected the aviation industry during the pandemic are examined in detail using a PESTEL analysis (Table 2).

Under the political aspect, it has been observed that governments declared full or partial flight bans at the beginning of the pandemic (Figure 1). As a result of these bans, many airports were closed, and longer flight connections were established. As seen in Figure 2, there was a significant decrease in passenger numbers in March 2020, and although passenger numbers have slowly increased in the following months, even in 2021 and 2022, they have not yet reached the 2019 level. As seen in Table 3, there is still more than 30% decline in global passenger numbers in the South Africa and Southeast Asia regions compared to the same period in 2019.

During the pandemic, governments financed these companies, especially to prevent an increase in unemployment and to prevent airlines from going bankrupt. Many governments supported large companies operating internationally and provided more support to local Chinese airlines. Consequently, supported companies have experienced fewer economic losses (Abate et al., 2020; Warnock-Smith et al., 2021; Zimmerling & Chen, 2021).

The current economic downturn in the aviation industry has led to unemployment rates ranging between 7% and 13% that are expected to only recover in the next 5-6 years (Sobieralski, 2020). It is considered that not all airlines have been equally affected by the pandemic, with companies focusing on international markets and discretionary leisure travel being less financially supported and therefore more affected by the crisis and expected to have a longer recovery period (Warnock-Smith et al., 2021). While passenger airlines have suffered significant losses, cargo carriers or combination (passenger and freight) airlines have increased their profits

after the relaxation of flight restrictions. The improvement in profitability in the cargo sector has resulted in changes to the designs of some passenger aircraft to make them suitable for freight transportation.

The economic impact of the Covid-19 pandemic on the aviation industry has been significant, as evidenced by the available data on revenues, costs, profitability, and various performance metrics (IATA, 2022 December). A thorough examination of these statistics helps support the claims made in the article regarding the economic effects of the pandemic.

The data (Table 4) reveals a sharp decline in revenues for the global commercial airlines in 2020, with a staggering-54.4% year-over-year decrease. However, there has been a gradual recovery in subsequent years, with revenue increasing by 32.4% in 2021 and 43.6% in 2022. Despite this recovery, it is important to note that revenues in 2022 still remain down by-13.2% compared to 2019 levels. Passenger growth, measured by Revenue Passenger Kilometers (RPK), was severely impacted in 2020, with a dramatic decline of -65.8% year-over-year. However, there has been a rebound in passenger growth in 2021 and 2022, with increases of 21.8% and 69.4% respectively. Nevertheless, when compared to 2019, passenger growth in 2022 is still down by -29.4%.

Expenses for airlines experienced a decline of -37.9% in 2020 due to cost-cutting measures, but showed an upward trend in 2021 and 2022, with increases of 11.8% and 33.6% respectively. Despite these increases, expenses in 2022 are still down by -7.3% compared to 2019 levels. Profitability, as indicated by operating profit and net profit, saw a negative trend in 2020, with significant losses recorded. However, there has been improvement in subsequent years, with operating profit moving from -110.8 billion dollars in 2020 to 3.2 billion dollars in 2022. Similarly, net profit improved from -137.7 billion dollars in 2020 to 4.7 billion dollars in 2022. These improvements are reflected in the return on invested capital, which increased from -19.3% in 2020 to 0.6% in 2022.

Regarding ATK (the total cargo capacity available for transportation, measured in ton kilometers) we observe a decline in capacity growth, with a significant decrease of -44.3% in 2020. However, there has been a recovery in subsequent years, with capacity growth increasing by 16.2% in 2021 and 23.7% in 2022. When compared to 2019, capacity growth in 2022 is still down by -19.9%. When it comes to ASK (the total seat capacity available for transportation, measured in seat kilometers) the data reveals a decline in passenger capacity growth, with a significant decrease of -35.3% in 2020. Similar to ATK, there has been a gradual recovery in subsequent years, with capacity growth increasing by 16.2% in 2021 and 23.7% in 2022. However, when compared to 2019, passenger capacity growth in 2022 is still down by -29.4%. Similarly, the decline in passenger yield in 2020 can be attributed to reduced demand, travel restrictions, and changes in consumer behavior. The subsequent recovery indicates an improvement in passenger demand and an increase in ticket prices. On the other hand, the significant increase in cargo yield in 2020 reflects the surge in demand for air cargo services during the pandemic, driven by the need for medical supplies, e-commerce growth, and global supply chain disruptions. While the growth rate moderated in the following years, cargo

yield remained higher than pre-pandemic levels, indicating sustained demand for air freight services. By considering the yield data alongside other key performance metrics, we can gain a comprehensive understanding of the financial dynamics within the aviation industry. These insights contribute to a more nuanced analysis of the economic impact of the pandemic and the subsequent recovery patterns, allowing for a better evaluation of the industry's resilience and adaptation to the changing market conditions.

From a social perspective, studies have shown that the pandemic-related layoffs have caused stress and job insecurity among flight attendants, leading to reduced service quality and negatively impacting the trust and loyalty of employees towards their companies (Athanasiadou & Theriou, 2021; Battisti et al., 2022; Sim et al., 2022). It has been observed that companies focusing on social responsibility projects can mitigate these effects. The decrease in trust in the aviation industry due to the pandemic has also led to similar concerns among individuals' trust in those around them (Lamb et al., 2021).

When examining the technological impacts, it is observed that the hygiene and distance rules brought to the agenda due to COVID-19 have led to the development of contactless technologies, a decrease in documentation and face-to-face communication requirements, and an increase in the use of facial recognition technologies. It has been revealed that artificial intelligence and machine learning techniques are increasingly used in demand forecasting for passenger numbers and pilot training (Heiets & Yibing, 2021; Sun, Wandelt, & Zhang, 2021). All these technological developments are expected to lead to the redesign of aircraft, a reduction in fuel consumption, and the reconstruction of airports as smart airports by developing their technological infrastructure in the near future.

In the environmental domain, many positive effects of the pandemic can be seen, such as a decrease in emission levels, an improvement in air quality, and a relatively slower rate of global warming. With regard to legal issues, the protection of airline workers' rights, compliance with health and hygiene rules, and maximum passenger capacity on planes have been brought to the agenda and necessary changes have been made by reviewing legislation in many countries (Rachmat & Susetio, 2021).

Even the Covid-19 pandemic had a significant impact on the air industry, as of March 2023 there are positive signs of recovery in global international air connectivity (IATA, 2023). As it can be seen from Figure 3, overall international air connectivity stood at 79% of its pre-pandemic level. Africa has exceeded its 2019 level with 104% connectivity, while Latin America & the Caribbean and the Middle East are approaching pre-Covid levels at 97% and 98%, respectively. Europe and North America are currently at 87% of their 2019 levels. Asia-Pacific has shown a strong increase of 40 percentage points over the past year, with further improvements expected as travel restrictions are lifted. International air connectivity has recovered faster than domestic connectivity, playing a crucial role in driving economic growth and enhancing global trade, investment, tourism, and travel. This highlights the industry's resilience and gradual recovery from the pandemic's impact.

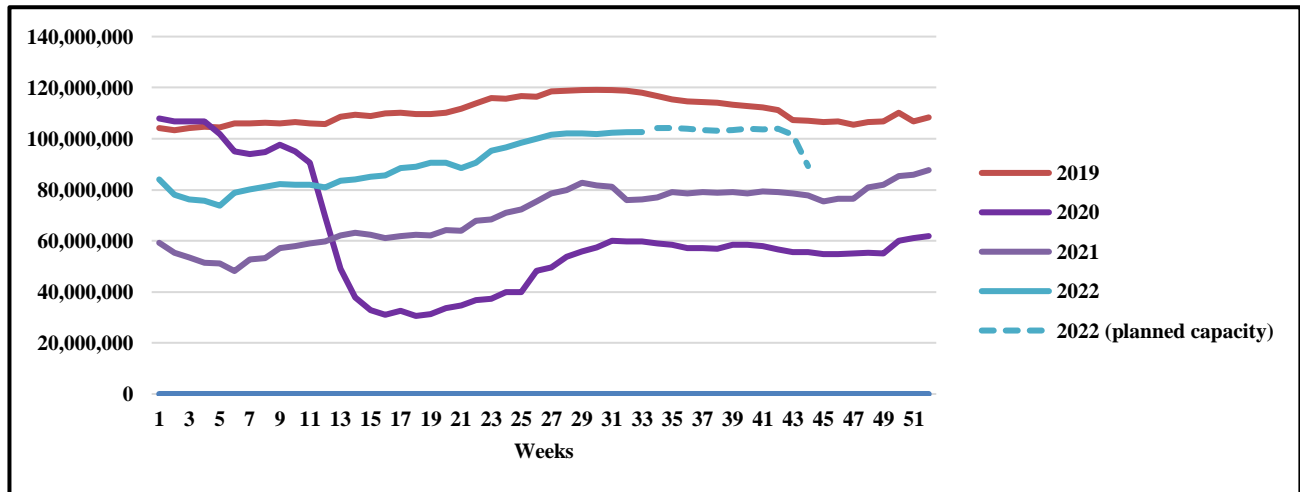


Figure 2. Global Air Passenger Transport Situation (OAG, 2022)

Table 2.a PESTEL Analyses

Field	Topic	Results and Effects	Reference
Political	Closure of airports	At the start of the pandemic, more than 600 airports out of 3,700 worldwide were closed, resulting in longer flight connections.	(Bao et al., 2021)
	Government support for aviation	Most governments prioritize high-support for sectors such as aviation or tourism to protect economic activity and employment. While large companies operating internationally are often supported by governments, international airlines targeting the Chinese market experienced significant economic losses compared to local companies due to less support.	(Abate et al., 2020) (Warnock-Smith et al., 2021)
Economic	Differential impact of pandemic on companies according to wage policy	Due to governments providing support primarily to larger aviation companies during the early months of the pandemic, low-wage airlines faced significant economic difficulties.	(Kökény et al., 2022)
	Economic impact of COVID-19 on the aviation sector	In 2020, the total loss in the Texas Austin aviation sector alone was estimated at USD 1.02 billion, with a total loss of 3.87 thousand jobs, USD 229.97 million in personal income, and a loss of value-added estimated at USD 514.20 million.	(Perez & Camargo, 2022)
	Unemployment in the aviation sector due to COVID-19	Unemployment rates in the aviation industry are expected to increase by 7-13% and require a recovery period of 5-6 years.	(Sobieralski, 2020)
Social	Impact of pandemic-related stress on flight attendants	Pandemic-related stress has increased job insecurity and work-related stress among flight attendants, leading to a decrease in social service behavior, with indirect effects on job insecurity and community-oriented service behavior.	(Sim et al., 2022)
	Relationship between the mental state of young people and COVID-19 with regard to air travel	There is a significant relationship between the mental state of the younger generation regarding air travel experience and the negative impact of COVID-19.	(Battisti et al., 2022)
	Emotional and social perspectives of airline passengers	Due to concerns regarding pandemic risks, a lack of trust in the airline industry's ability to take necessary precautions, and other factors, individuals have increased their personal precautions (e.g. masks, distancing, hygiene).	(Lamb et al., 2021)
	COVID-19-related unemployment and social responsibility activities of firms	COVID-19-related unemployment has negatively affected employee trust and loyalty in aviation companies. Additionally, social responsibility activities of firms during this period have increased employee trust and loyalty towards their company.	(Athanasiadou & Theriou, 2021)



**Table 2.b** PESTEL Analyses (cont.)

Field	Topic	Results and Effects	Reference
Technological	Structural changes in aircraft	The pandemic has led to a redesign of passenger aircraft to carry cargo due to the cargo demand surpassing passenger transportation.	(Sun, Wandelt, & Zhang, 2021)
	Technological impacts on fuel and emissions after COVID-19	Future technologies are expected to reduce fuel consumption and emissions of carbon dioxide and nitrogen compounds by more than half in airline operations.	(Grewe et al., 2021)
	Development of technological infrastructure at airports	Airports that use contactless technologies, facial recognition systems for passport and health checks, and generally contactless technologies are being built.	(Heiets & Yibing, 2021) (Sun, Wandelt, & Zhang, 2021)
	Effects of COVID-19 on technology	The COVID-19 crisis has led to new technologies and developments in 3D printing, personal protective equipment, communication, distance learning, telemedicine, vaccines, and respiratory equipment.	(Zimmerling & Chen, 2021)
	Use of artificial intelligence in demand forecasting and pilot training	After the stagnation period caused by COVID-19, some airlines are using data science and machine learning techniques to forecast passenger numbers. Artificial intelligence techniques have also become widespread in pilot training.	(Sun, Wandelt, & Zhang, 2021)
Environmental	Effects of the pandemic on carbon dioxide emissions and air temperature	Projections for South America by 2050 suggest that COVID-19 restrictions will contribute to reducing global warming and emissions. In the Croatian region, a decrease of 1.8% to 3.5% in carbon dioxide emissions was observed.	(Calderon-Tellez & Herrera, 2021) (Nizetić, 2020)
	Effects of the pandemic on air pollution	Pandemic measures such as reduced air transportation, remote work, and consumption restrictions have led to improved air quality in Turkey.	(Dursun et al., 2022)
Legal	Global and local travel restrictions and bans	The aviation industry has been economically affected, especially due to the decrease in the number of air passengers. Restrictions in 11 cities in China have reduced COVID-19 cases in those cities, but initial restrictions were only effective for a short period.	(Bao et al., 2021), (Li et al., 2020)
	Implementation of legal regulations on various issues	Legal regulations regarding the protection of the rights of airline employees during crisis situations, compliance with health and hygiene rules, maximum passenger capacity on planes, and other related issues should be made by all countries.	(Rachmat & Susetio, 2021)

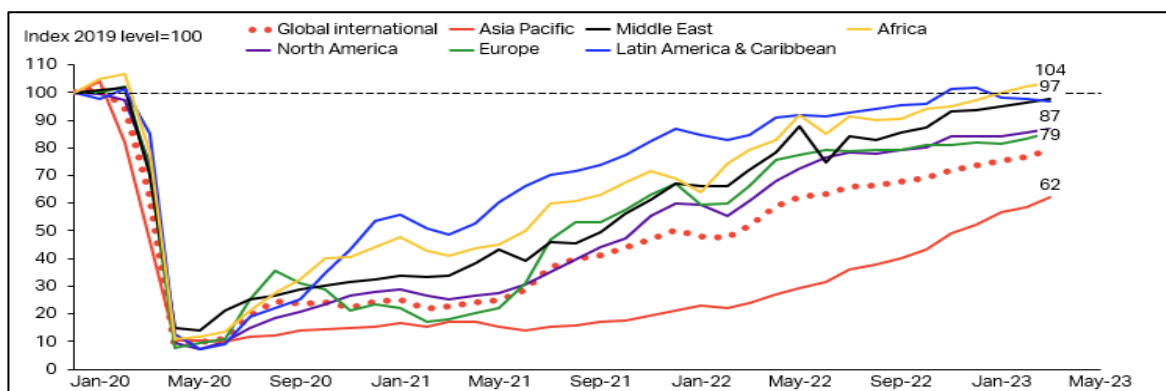
**Table 3.** Change in Air Passenger Numbers from August 2019 to August 2022 (OAG, 2022)

Region	Domestic	International	Total
South Africa	-40.1%	-31.6%	-36.9%
Southeast Asia	-13.6%	-54.4%	-30.7%
Southwest Pacific	-12.3%	-43.0%	-21.3%
Eastern Europe	16.8%	-31.7%	-18.0%
Northeast Asia	3.3%	-81.8%	-17.9%
Middle East	-13.1%	-16.7%	-16.0%
America (Southern)	-8.0%	-27.6%	-11.3%
Europe (West)	-9.9%	-11.4%	-11.0%
Europe (North)	-5.4%	-8.8%	-8.3%
America (North)	-6.7%	-13.1%	-7.7%
Caribbean	-19.5%	-5.1%	-6.5%
Eastern Africa	9.7%	-13.4%	-5.4%
South Asia	-1.1%	-8.4%	-3.1%
West Central Africa	31.0%	-6.5%	7.4%
America (Upper South)	14.1%	-6.8%	8.7%
Central America	10.4%	8.3%	9.6%
Central Asia	19.0%	4.8%	11.7%
Total	-3.5%	-26.1%	-13.1%

**Table 4.** Global economic parameters for airline industry (IATA, 2022 December)

Parameters	Years		
	2020	2021	2022*
<b>Revenues, \$ billion</b>	<b>382</b>	<b>506</b>	<b>727</b>
% change year over year	-54.4%	32.4%	43.6%
% change vs 2019		-39.6%	-13.2%
Passenger, \$ billion	189	239	438
Cargo, \$ billion	138.5	204.2	201.4
<b>Traffic volumes</b>			
Passenger growth, RPK, % change year over year	-65.8%	21.8%	69.4%
% change vs 2019		-58.3%	-29.4%
Cargo growth, CTK+MTK, % change year over year	-9.9%	18.8%	-8.0%
% change vs 2019		7.0%	-1.6%
Cargo tonnes, millions	55.4	65.6	60.3
World economic growth, % change year over year	-3.5%	5.8%	2.9%
Passenger yield, % change year over year	-9.1%	3.8%	8.4%
Cargo yield % change year over year	52.5%	24.2%	7.2%
<b>Expenses, \$ billion</b>	<b>493</b>	<b>551</b>	<b>737</b>
% change year over year	-37.9%	11.8%	33.6%
% change vs 2019		-30.6%	-7.3%
Fuel, \$ billion	80	103	222
% of expenses	16%	19%	30%
Non-fuel, \$ billion	413	448	515
cents per ATK (non-fuel unit cost)	48.1	44.9	41.7
% change year over year	22.7%	-6.7%	-7.2%
Capacity growth, ATK, % change year over year	-44.3%	16.2%	23.7%
% change vs 2019		-35.3%	-19.9%
Flights, million	16.9	20.1	27.9
Break-even weight load factor, % ATK	76.8%	67.2%	68.3%
Weight load factor achieved, % ATK	59.5%	61.7%	67.5%
Passenger load factor achieved, % ASK	65.2%	66.9%	78.9%
<b>Operating Profit, \$ billion</b>	<b>-110.8</b>	<b>-45.1</b>	<b>-9.3</b>
% margin	-29.0%	-8.9%	-1.3%
<b>Net Profit, \$ billion</b>	<b>-137.7</b>	<b>-42.0</b>	<b>-6.9</b>
% margin	-36.0%	-8.3%	-1.0%
per departing passenger, \$	-76.22	-19.20	-2.02
<b>Return on Invested Capital, %</b>	<b>-19.3%</b>	<b>-8.0%</b>	<b>-1.7%</b>

\* Forcast as of 2022 December



**Figure 3.** IATA Global Air Connectivity Index 2020-2023

## 4. Results and Discussion

### 4.1. Results

Regarding political factors, governments implemented full or partial flight bans and travel restrictions at the beginning of the pandemic, leading to airport closures and longer flight connections. Additionally, there was a significant decline in passenger numbers in March 2020, with gradual but incomplete recovery in subsequent months. Notably, the South Africa and Southeast Asia regions experienced more than a 30% decline in global passenger numbers compared to the same period in 2019.

In terms of economic factors, governments provided financial support to prevent airlines from going bankrupt, although the level of assistance varied for international and local airlines. Passenger airlines faced significant losses, while cargo carriers or combination airlines saw increased profits following the relaxation of flight restrictions. Revenues for global commercial airlines sharply declined in 2020 but showed a gradual recovery in subsequent years, albeit still below 2019 levels (IATA, 2022b). Similarly, passenger growth and capacity experienced a substantial decline in 2020, followed by a rebound in 2021 and 2022, but remaining below 2019 levels.

Concerning sociological factors, layoffs resulted in stress and job insecurity among flight attendants, impacting service quality and employee trust and loyalty. However, companies that focused on social responsibility projects were able to mitigate some of the negative effects on employee morale. Trust in the aviation industry also decreased, raising concerns about trust among individuals.

Regarding technological factors, the hygiene and distance rules brought about by the pandemic led to the development of contactless technologies and reduced face-to-face communication requirements. The use of facial recognition technologies increased, and artificial intelligence and machine learning were integrated into demand forecasting for passenger numbers and pilot training. These technological advancements are expected to contribute to aircraft redesign, fuel consumption reduction, and the development of smart airports.

The pandemic had positive environmental effects, including decreased emission levels, improved air quality, and a slower rate of global warming. These outcomes have raised environmental awareness and are likely to influence future industry practices.

In terms of legal factors, legislation in many countries was reviewed and amended to address issues such as airline workers' rights, compliance with health and hygiene rules, and maximum passenger capacity on planes.

### 4.2. Discussion

The findings of this study highlight the significant impact of the COVID-19 pandemic on the aviation industry across various dimensions and these findings highlight the multifaceted challenges faced by the aviation industry during the pandemic and provide insights for future strategies and decision-making processes.

This study has several limitations. Firstly, it primarily focuses on analyzing the effects of the COVID-19 pandemic on the aviation sector using the PESTEL framework, which may not encompass all potential influences on the industry, such as cultural, ethical, and competitive factors. Secondly, the study is confined to examining the initial impact of the

pandemic and its short, medium, and long-term effects, thereby potentially overlooking future developments that could have further implications for the industry. Lastly, the research acknowledges that most studies on the effects of the pandemic in the aviation sector have been conducted at either regional or limited global levels, thereby potentially missing out on capturing the specific challenges and dynamics faced by individual countries or regions.

In comparing this research with the study "Understanding the pandemic's impact on the aviation value chain" (IATA, 2022b) several similarities and differences emerge. Both studies recognize the significant economic losses suffered by the aviation industry during the pandemic. They both highlight the challenges faced by airlines, which consistently generated substantial economic losses even before the pandemic, and acknowledge the varying performance and resilience of different sectors within the aviation value chain. However, there are also notable differences between the two studies. This research primarily focuses on the effects of the COVID-19 pandemic on the aviation sector through the PESTEL framework, while the IATA (2022b) report provides an analysis of the entire aviation value chain. It focuses on specific economic losses experienced by different sectors within the value chain, with air cargo carriers and freight forwarders standing out as exceptions due to increased demand and yield. It also emphasizes the importance of collaboration and mutual efforts among value chain partners to enhance performance, improve efficiency, and generate higher returns.

So, both studies shed light on the detrimental impact of the pandemic on the aviation industry. While this research concentrates on the COVID-19 effects through the PESTEL framework, the report mostly deals with examination of the aviation value chain, its sectors, and their performance.

## 5. Conclusion

This study employed a comprehensive PESTEL analysis to examine the profound impact of the COVID-19 pandemic on the aviation industry. Through the examination of political, economic, sociological, technological, environmental, and legal factors, it is evident that the pandemic has had far-reaching consequences on the industry, particularly in terms of passenger transportation. The findings of this study underscore the urgent need for the development of effective strategies to address the challenges faced by the aviation industry in the post-pandemic era. These strategies should encompass both short-term measures to enhance pandemic readiness and long-term efforts for industry recovery and resilience.

For future studies, it is suggested that research focuses on the development of global-scale initiatives for industry recovery, combining PESTEL analysis with multi-criteria decision-making methods. Additionally, efforts may be directed towards restructuring travel packages, exploring low-cost flight options, and identifying popular routes to facilitate industry recovery. Furthermore, environmental sustainability should be prioritized, with the exploration of energy-efficient practices and innovative solutions to reduce fuel consumption and minimize the industry's ecological footprint.

Supporting the well-being of airline employees and fostering a positive work environment are also essential considerations. Future studies may explore social responsibility projects to mitigate the sociological impacts of the pandemic on the workforce.

Technological advancements, such as the adoption of contactless technologies and the integration of artificial intelligence and machine learning, may be further explored to enhance operational efficiency and decision-making processes. Continued vigilance in complying with health and hygiene regulations, protecting workers' rights, and regularly reviewing legislation are critical in navigating the post-pandemic landscape.

In conclusion, future studies may focus on developing strategies for industry recovery, environmental sustainability, employee well-being, and leveraging technological advancements. By utilizing comprehensive analysis frameworks and considering multi-criteria decision-making methods, the aviation industry may build resilience and adapt to the changing market conditions.

### Ethical approval

Not applicable.

### Conflicts of Interest

The authors declare that there is no conflict of interest regarding the publication of this paper.

### References

- Abate, M., Christidis, P., & Purwanto, A. J. (2020). Government support to airlines in the aftermath of the COVID-19 pandemic. *Journal of Air Transport Management*, 89, 101931.
- Atalan, A., & Atalan, Y. A. (2022). Analysis of the Impact of Air Transportation on the Spread of the COVID-19 Pandemic. In *Challenges and Opportunities for Transportation Services in the Post-COVID-19 Era* (pp. 68-87). IGI Global.
- Athanasiadou, C., & Theriou, G. (2021). Corporate Social Responsibility (CSR) Employee Outcomes in the Aviation Industry during the COVID-19 Pandemic Era. A Conceptual Framework. *Management and Business Research Quarterly*, 18.
- Avcı, S., Çengel, Ö., & Kibritci Artar, O. (2022). Implications of COVID-19 pandemic on air cargo transportation.
- Bao, X., Ji, P., Lin, W., Perc, M., & Kurths, J. (2021). The impact of COVID-19 on the worldwide air transportation network. *Royal Society open science*, 8(11), 210682.
- Battisti, E., Giachino, C., Iaia, L., Stylianou, I., & Papatheodorou, A. (2022). Air transport and mood in younger generations: The role of travel significance and COVID-19. *Journal of Air Transport Management*, 102230.
- Calderon-Tellez, J. A., & Herrera, M. M. (2021). Appraising the impact of air transport on the environment: Lessons from the COVID-19 pandemic. *Transportation research interdisciplinary perspectives*, 10, 100351.
- Çitilci, T., & Akbalık, M. (2020). The importance of PESTEL analysis for environmental scanning process. In *Handbook of Research on Decision-Making Techniques in Financial Marketing* (pp. 336-357).
- Daon, Y., Thompson, R. N., & Obolski, U. (2020). Estimating COVID-19 outbreak risk through air travel. *Journal of travel medicine*, 27(5), taaa093.
- Deveci, M., Çiftçi, M. E., Akyurt, İ. Z., & Gonzalez, E. D. S. (2022). Impact of COVID-19 pandemic on the Turkish civil aviation industry. *Sustainable Operations and Computers*, 3, 93-102.
- Dursun, S., Sagdic, M., & Toros, H. (2022). The impact of COVID-19 measures on air quality in Turkey. *Environmental Forensics*, 23(1-2), 47-59.
- Fahey, L., & Narayanan, V. K. (1986). *Macroenvironmental analysis for strategic management (The west series in strategic management)*. St. Paul, Minnesota: West Publishing Company.
- Gregoric, M. (2014). PESTEL analysis of tourism destinations in the perspective of business tourism (MICE). In *Faculty of Tourism and Hospitality Management in Opatija. Biennial International Congress. Tourism & Hospitality Industry* (p. 551).
- Grewe, V., Gangoli Rao, A., Grönstedt, T., Xisto, C., Linke, F., Melkert, J., Middel, J., Ohlenforst, B., Blakey, S., & Christie, S. (2021). Evaluating the climate impact of aviation emission scenarios towards the Paris agreement including COVID-19 effects. *Nature Communications*, 12(1), 1-10.
- Heiets, I., & Yibing, X. (2021). The Impact of the COVID-19 Pandemic on the Aviation Industry. *Journal of Aviation*, 5(2), 111-126.
- Ho, J. K.-K. (2014). Formulation of a systemic PEST analysis for strategic analysis. *European academic research*, 2(5), 6478-6492.
- IATA. (2020). *Interactive Coronavirus (Covid-19) Travel Regulations Map (Powered by Timatic)*. IATA. Retrieved 31 May 2020 from <https://www.iatatravelcentre.com/international-travel-document-news/1580226297.htm>
- IATA. (2022 December). *Industry Statistics (Fact Sheet)*. <https://www.iata.org/en/iata-repository/publications/economic-reports/global-outlook-for-air-transport-december-2022-data-tables/>
- IATA. (2022b) *Understanding the pandemic's impact on the aviation value chain*, McKinsy Company Report, <https://www.iata.org/en/iata-repository/publications/economic-reports/understanding-the-pandemics-impact-on-the-aviation-value-chain/>
- IATA. (2023). *International air connectivity closing in on pre-COVID levels*. <https://www.iata.org/en/iata-repository/publications/economic-reports/international-air-connectivity-closing-in-on-pre-covid-levels/>
- Irfan, M., Ahmad, M., Fareed, Z., Iqbal, N., Sharif, A., & Wu, H. (2022). On the indirect environmental outcomes of COVID-19: short-term revival with futuristic long-term implications. *International journal of environmental health research*, 32(6), 1271-1281.
- Kang, C., & Disemadi, H. S. (2021). The COVID-19 Pandemic Outbreak Impact And Prevention From Legal Perspective: An Indonesian Experience. *CoMBInES-Conference on Management, Business, Innovation, Education and Social Sciences*,
- Kaya, S., Khan, M. D., & Mujtaba, A. (2021). A review of legal impacts of COVID-19 studies: Trends and future challenges. *International Journal of Innovation, Creativity and Change*, 15(8), 511-520.
- Kökény, L., Kenesei, Z., & Neszveda, G. (2022). Impact of COVID-19 on different business models of European airlines. *Current issues in tourism*, 25(3), 458-474.
- Kurnaz, S., & Žilinskienė, D. (2022). The Effects of the COVID-19 Pandemic and the Future of Aviation. In *Digitalization and the Impacts of COVID-19 on the Aviation Industry* (pp. 53-72). IGI Global.



- Lamb, T. L., Ruskin, K. J., Rice, S., Khorassani, L., Winter, S. R., & Truong, D. (2021). A qualitative analysis of social and emotional perspectives of airline passengers during the COVID-19 pandemic. *Journal of Air Transport Management*, 94, 102079.
- Li, J., Huang, C., Wang, Z., Yuan, B., & Peng, F. (2020). The airline transport regulation and development of public health crisis in megacities of China. *Journal of Transport & Health*, 19, 100959.
- Matović, I. M. (2020, September). PESTEL Analysis of External Environment as a Success Factor of Startup Business. In *ConScienS Conference Proceedings* (pp. 96-102).
- Metehan, A., Eroğlu, Y., & Seçkiner, S. (2021). COVID-19 Krizinde Operasyonel Aksaklık Altındaki Havayolu Şirketlerinin Stratejik ve Finansal Karar Faktörlerinin Analizi. *Havacılık ve Uzay Çalışmaları Dergisi*, 2(1), 70-88.
- Nižetić, S. (2020). Impact of coronavirus (COVID-19) pandemic on air transport mobility, energy, and environment: A case study. *International Journal of Energy Research*, 44(13), 10953-10961.
- OAG. (2022). COVID-19 AIR TRAVEL RECOVERY. Official Aviation Guide. <https://www.oag.com/coronavirus-airline-schedules-data>
- Onianwa, O. I. (2022). COVID-19 Pandemic and Air Transport Business in Nigeria: An Analysis. In *Global Air Transport Management and Reshaping Business Models for the New Era* (pp. 20-38). IGI Global.
- Perez, R., & Camargo, A. C. (2022). The Economic Impact of COVID-19 in the Air Transportation Industry: Estimates From a Regional Input-Output Model. In *Challenges and Opportunities for Transportation Services in the Post-COVID-19 Era* (pp. 88-103). IGI Global.
- Rachmat, M. N., & Susetio, W. (2021). Legal Analysis in Airlines Business Over Middle of Covid-19 Pandemic at Indonesia. *Journal of Multidisciplinary Academic*, 5(4), 315-320.
- Sammot-Bonnici, T., & Galea, D. (2014). PEST analysis.
- Serrano, F., & Kazda, A. (2020). The future of airports post COVID-19. *Journal of Air Transport Management*, 89, 101900.
- Sim, M., Kim, H., & Choe, Y. (2022). Does COVID-19 induce stress influence job insecurity, general job stress, pro-social service behavior at work place?: A case of aviation industry. *한국관광학회 국제학술발표대회집*, 91, 827-828.
- Sobieralski, J. B. (2020). COVID-19 and airline employment: Insights from historical uncertainty shocks to the industry. *Transportation research interdisciplinary perspectives*, 5, 100123.
- Song, J., Sun, Y., & Jin, L. (2017). PESTEL analysis of the development of the waste-to-energy incineration industry in China. *Renewable and Sustainable Energy Reviews*, 80, 276-289.
- Su, M., Hu, B., Luan, W., & Tian, C. (2022). Effects of COVID-19 on China's civil aviation passenger transport market. *Research in Transportation Economics*, 101217.
- Sun, X., Wandelt, S., & Zhang, A. (2021). Technological and educational challenges towards pandemic-resilient aviation. *Transport Policy*, 114, 104-115.
- Sun, X., Wandelt, S., Zheng, C., & Zhang, A. (2021). COVID-19 pandemic and air transportation: Successfully navigating the paper hurricane. *Journal of Air Transport Management*, 94, 102062.
- Vieira, J. P. B., Braga, C. K. V., & Pereira, R. H. (2022). The impact of COVID-19 on air passenger demand and CO2 emissions in Brazil. *Energy Policy*, 164, 112906.
- Vo, T. D., & Tran, M. D. (2021). The impact of covid-19 pandemic on the global trade. *Int. J. Soc. Sci. Econ. Invent*, 7, 1-7.
- Warnock-Smith, D., Graham, A., O'Connell, J. F., & Efthymiou, M. (2021). Impact of COVID-19 on air transport passenger markets: Examining evidence from the Chinese market. *Journal of Air Transport Management*, 94, 102085.
- Yüksel, I. (2012). Developing a multi-criteria decision making model for PESTEL analysis. *International Journal of Business and Management*, 7(24), 52.
- Zimmerling, A., & Chen, X. (2021). Innovation and possible long-term impact driven by COVID-19: Manufacturing, personal protective equipment and digital technologies. *Technology in Society*, 65, 101541.

**Cite this article:** Pınar, A. (2023). A PESTEL Analysis of The Impacts of COVID-19 Crisis on Air Transportation Sector's Future. *Journal of Aviation*, 7(2), 215-225.



This is an open access article distributed under the terms of the Creative Commons Attribution 4.0 International Licence

**Copyright © 2023 Journal of Aviation** <https://javsci.com> - <http://dergipark.gov.tr/jav>

# Determining and Evaluating the Strategies of Air Cargo Freight Forwarders to Increase Business Volume with AHP Method

Filiz Mızrak<sup>1\*</sup> , Gonca Reyhan Akkartal<sup>2</sup> 

<sup>1</sup>Istanbul Medipol University, Business and Administration Department, Istanbul, Türkiye. (fmizrak@medipol.edu.tr)

<sup>2</sup>Istanbul Medipol University, Logistics Management Department, Istanbul, Türkiye. (gonca.akkartal@medipol.edu.tr)

## Article Info

Received: 09 March 2023  
Revised: 30 April 2023  
Accepted: 19 May 2023  
Published Online: 09 July 2023

### Keywords:

Strategic Management  
Aviation Industry  
Freight Forwarders  
International Logistics

Corresponding Author: *Filiz Mızrak*

## RESEARCH ARTICLE

<https://doi.org/10.30518/jav.1262860>

## Abstract

Air cargo forwarders plays an essential role in air cargo transportation process. They provide service providing communication between the stakeholders in the supply chain. However, there is a fierce competition in this sector due to huge number of companies. For this reason, this companies need to respond to changes in the globalization era by applying some strategies. In this scope, the aim of this study is to determine and weight the strategies that forwarders operating in the air cargo sector can implement to increase their business volumes, using the studies in the literature, interviews with 10 experts working in different forwarder companies in Turkey, and the AHP method. Although strategies for companies to increase their business volumes examined in various studies, there is no study specifically for 'Air cargo transport companies'. In addition, any study using the AHP method for the sector has not been found in the literature. In this context, the study is unique in terms of sectoral practice and methodology. The finding of the study suggests that staff trainings to improve customer relations is the most important criteria for air cargo freight forwarders.

## 1. Introduction

With the effect of globalization, the change in markets, products and customer demands necessitated a change in the marketing understanding of the enterprises. Global marketing envisages that the existing marketing functions will be focused on global markets with the effect of globalization. With the changing strategies and activities of businesses operating in global markets, the concept of competition has left its place to global competition. In this respect, global competition is a phenomenon that businesses need to analyze to acquire the new marketing understanding (Ng, K. T et al., 2022).

Air logistics, which is a component of modern logistics, plays an important role in international trade due to the services it provides for the efficient transportation of small and value-added materials. The development of international trade improves air logistics, and along with this development, the economy in general and international trade are also developing (Cay & Kocuyigit, 2023). However, if air logistics does not develop, some economic constraints arise. The development of the global supply chain and the increase in international competition position air logistics in a special field in economic development because a global supply chain should be developed to increase economic efficiency, reduce inventory costs, and accelerate the flow of raw materials and commodities on a global scale. In addition, the acceleration of life increases the demand for trade and services to be met more

quickly. In this context, air logistics is important for the development of modern economy with its characteristic features such as fast, safe, and long-distance material flow (Merkert, 2022).

Air cargo forwarders are commercial institutions that provide service by providing communication between the stakeholders in the supply chain. Forwarders who are members of IATA (International Air Transport Association) are organizations authorized by IATA that can issue documents on behalf of the airline, coordinate loading and unloading, determine freight, and fulfill customs formalities. These agents can contact airline companies directly and request direct airline reservations to ship products. In fact, it is not possible for the shippers who will export with air cargo to contact the airline companies directly. Carriers' direct shippers to these forwarders. Agencies that are members of IATA have the authority to represent the airline company in cargo services to be made with all member airlines (Zhu et al., 2022).

The aim of this study is to analyze the investment strategies of forwarders working in the air cargo sector. There are very few studies in the literature in this area. With this study, the gap in the literature will be filled and a source will be provided for future studies. Benefiting from studies in literature and interviews with 10 specialists working indifferent freight forwarder companies in Turkey, criteria set has been determined. To weight these criteria, AHP method has been applied. Thanks to this analysis, criteria can be ordered according to their importance and investment strategies can be

proposed to air cargo forwarders. In this scope, this study is unique in terms of sector and applied method.

In the second part of study after the introduction part, recent studies on the concept of freight forwarders and strategies that companies apply to increase business volume have been analyzed. In the methodology section, content of interviews and information about interviewees have been given. Besides, steps of AHP method have been explained. In the next part, application of AHP method with predetermined criteria have been fulfilled and findings have been demonstrated. Last but not the least, the conclusion part has proposed the most important strategy that air cargo forwarders can invest on.

## 2. Literature Review

In this part, recent studies in literature on concept of freight forwarders and strategies that companies, specifically operating in logistic sector have been analyzed.

### 2.1. Concept of Freight Forwarder

Companies that see themselves as logistics service producers specializing in the transportation and storage of goods to be transported on behalf of the carrier are called freight forwarders. They are intermediary organizers who usually provide a wide range of services in the follow-up of domestic transport, preparation of shipping and export documents, shipping, booking process, freight negotiation and freight consolidation, insurance of cargo and filling insurance claims. Freight forwarders usually provide their own bills of lading or document delivery and consolidation services of their agents and partners (overseas shipping companies) at the destination (Van, 2022).

The works and services provided by freight forwarders are generally considered as fulfilling export and customs documentation, port, insurance and terminal obligations and handling. Some of these businesses have a wide range of services, while others specialize in a few services or geographic scopes. Forwarders serve as agents or representatives of businesses within the framework of changing legal regulations by taking their place in the processes. The main task of freight forwarder companies is to organize, coordinate and deliver the cargo from the shipper to the consignee. It is the freight forwarder company that is responsible for the timely delivery of the goods, provided that the quantity and quality are maintained within the specified or specified time frame. It should be known that in the wrong decision to be made by the freight forwarder, inefficiency and companies will suffer losses. Freight forwarder companies follow the day in operation and can use modern methods and information technologies effectively (Feng et al., 2020).

Air cargo forwarders are commercial institutions that provide service by providing communication between the stakeholders in the supply chain. Forwarders who are members of IATA (International Air Transport Association) are organizations authorized by IATA that can issue documents on behalf of the airline, coordinate loading and unloading, determine freight, and fulfill customs formalities. These agents can contact airline companies directly and request direct airline reservations to ship products. In fact, it is not possible for the shippers who will export with air cargo to contact the airline companies directly. Carriers' direct shippers to these forwarders. Agencies that are members of IATA have the authority to represent the airline company in cargo services to be made with all member airlines (Amaruchkul and Lorchirachoonkul, 2011).

In addition, forwarders cooperate with agencies abroad to organize custom formalities in the destination or receiving the cargo and fulfilling door to door deliveries. In this scope, it is essential for forwarders to improve their relations with the agencies abroad. Leading forwarders in Air Cargo sector such as DHL, DB Schenker, UPS, FedEx, Expeditors have wide agency network all over the world which provides them competitive advantage in the personnel of the agencies with IATA membership, provide operational information such as cargo handling, loading, storage, packaging, basic sales, and training on dangerous goods transportation, and provide well-equipped and conscious service (Ha et al, 2016).

### 2.2. Strategies to Increase Business Volume

It has been observed that the strategies implemented by companies to increase their business volumes are frequently encountered in the literature. However, there are very few studies in literature about freight forwarders and possible strategies they have applied to increase their business volume. Therefore, strategies and tactics in general applied by companies operating specifically in service business has been analyzed to support the analysis of the strategy.

#### 1. Staff training to improve customer relations

Today, change takes place very quickly and dynamically. In this age of change, businesses must be ready and adapt to all developments to survive. This harmony is only possible with education. Because education is a process that develops individuals, gives necessary information, and brings them to certain standards. The prerequisite for the success of the training given in the enterprises is to organize the training according to the needs of the employees (Appelbaum and Fewster, 2004).

Education has an important function for individuals to be successful in their working lives and to adapt to changing conditions. Due to the inadequacy of the information obtained in educational institutions or the limited application areas, it is necessary to train not only the individuals working in the enterprise, but also the new employees who will enter the enterprise. Today, businesses undergo some in-service trainings for their personnel both at the beginning of their work and throughout their working lives, especially since employees can keep up with the rapid developments in information and technology, follow professional developments closely, and work efficiently for themselves and their workplaces. Thus, businesses try to provide the highest efficiency from them by giving them the features they need. Under intense competition conditions, businesses that attach necessary and sufficient importance to education can continue their activities by developing, but it is increasingly difficult for businesses that do not attach the necessary importance to this issue to continue their activities (Itani et al., 2019).

The objectives of businesses include making profit and making life permanent. Achieving these goals is possible by working effectively and efficiently. Effective and efficient operation of the enterprise is possible if the qualifications of the personnel are suitable for the requirements of the job. Training of newly recruited or employed personnel plays an important role in the effective and efficient operation of enterprises. The purpose of personnel training is to ensure that the personnel work effectively and efficiently by making changes in their knowledge, ability and skill level (Chen, 2022).

In recent years, the importance of personnel training has begun to be emphasized as much as the development of infrastructure works of rail systems, which are frequently used in the sense of urban logistics. To ensure the passenger visit, it

is important that the team and personnel are knowledgeable, especially in logistics. 'In order to perceive a whole railway service, we need to evaluate hospitality of staffs and crews, and provide the information during train delays such as the train schedule and the conditions of equipment of vehicles and stations. In these studies, the train information in Japanese transportation service is focused on, and an appropriate effect of transport information for the passenger's behavior is analyzed and an appropriate concept of information service is presented for the railway transportation system' (Kohtsuki & Izumi, 2014)

The aviation sector is an important mode of transportation in the world, both in passenger and cargo transportation, which is increasing day by day. Customer relationship management has an important role in gaining competitive advantage in the market. 'SCI in the airline industry involves a network of passengers, shippers, freight forwarders, shipping carriers, logistics service providers, and agents who perform various value-added activities, usually sequentially, to add value for consumers' (Alshurideh et al., 2019).

## 2. Improving relations with suppliers

In today's dynamic competitive environment, the importance of unique collaborations established by successful businesses with their customers and suppliers is undeniable. The success of the technological and organizational changes that businesses make to increase their organizational performance largely depends on the development of mutual trust and cooperative relations with suppliers and customers. Relationships based on cooperation offer additional tactics to businesses and contribute positively to the success of their activities to increase their competitiveness, regardless of their strategic structure (Dmytriyeu et al., 2021).

Today, there is a trend between suppliers and their customers from the traditional competitive relationship to a new model based on cooperation. This long-term, very close relationship and "win-win" philosophy emphasizes a better approach than the "win-lose" philosophy inherited from the competitive relationship. The joint approach of the parent company and the sub-industries is necessary to meet the expectations of the market, and these expectations lead to a "common life" in the relations between the parent company and the sub-industry. Due to this common life, main companies and sub-industries can realize an effective production thanks to the strategic support they provide to each other (Akkartal & Uludağ, 2022).

At the beginning of optimizing the procurement strategy is the improvement of relations with transport companies. In line with changing technology and customer expectations, strategic partnership provides companies with a competitive advantage. Especially with the pandemic, there have been changes in the competitive strategies of companies. 'Covid-19 completely changed the firms' critical supply chain strategy for improving competition. Additionally, according to the customer's expectations, firms focus on responsiveness and flexibility to support logistics functions' (Akkartal & Uludağ, 2022). In addition, the concept of sustainability in air cargo logistics is an indicator that increases the growth in sales. Therefore, improving relations with business partners provides a sustainable competitive advantage.

## 3. Marketing Strategies

The understanding of income maximization is a systematic management approach that enables businesses to increase

income in the short term and increase profits in the long term. The effort to increase the income is directly proportional to the size of the market shares of the enterprises. Their market shares are growing by protecting their existing customers as well as making potential customers active customers. In addition to the pressure on businesses to acquire potential customers, there is a fear of leaving existing customers. For this reason, creating loyal customers in the market and attracting customers with a good image can lead businesses to maximum income and maximum profitability in the long run (Varadarajan, 2010).

The structure of the product in airline businesses differentiates the entire profitability path from other businesses. This differentiation can be explained by evaluating the marketing mix of airline companies. Being in the service sector, a significant part of the personnel of the airline companies puts effort into marketing efforts. Ticket sales and reservation, sales representatives, market researchers, analysts, ground services etc. are some of them. All these transactions in contact with the customer cause the sales and marketing process to become dynamic (Varadarajan, 2010).

One of the ways to be ahead of the global competition in the aviation industry, where competitive advantage is increasing day by day, is to manage marketing strategies. The development of market relations is due to the high level of competition, which forces the management of organizations to review the management strategies used in order to maintain their competitive position in the world market. However, the aviation industry declined with the pandemic. For this reason, airline companies should review their marketing strategies to maintain their competitive advantage. 'In recent years, the outbreak of COVID-19 has caused unprecedented damage to the global aviation industry' (Varadarajan, 2010).

## 4. Improvement of the Agency Network

Liberalization activities in air transport have expanded the volume of the aviation sector and changed its structure, with the modern service quality approach and the creation of global collaborations. Increasing sector volume has increased competition in the sector and increasing competition has led airline companies to form global collaborations or partnerships. In today's market conditions, it is seen that the increasing competition with globalization is not between airline companies but between global cooperation groups (Cheung et al., 2020).

The factors driving the liberalization of the aviation market can be identified as market access, market entry, capacity and price. Liberalization movements through these factors determine the structure of the market. The abundance of restrictive regulations on these elements before liberalization made it difficult for airline companies to reach new markets and take an active role in new markets. With liberalization, these factors that limit the decisions, actions and flexibility of airline companies have been alleviated over time, which has strengthened the competitive environment (Ukwandu et al., 2022).

The opportunities and technological developments created by liberalization have reduced the pressure on national borders and ensured the formation of global integrity. As a direct result of globalization, with the reduction of coercive factors such as customs, tariffs, quotas, and capital restrictions applied between countries, global markets have been established where international mobility of products, services and especially capital is provided under more comfortable conditions. The convenience of goods, services, information, and capital transitions in the market has offered businesses the



opportunity to take a more active role in new markets with the cooperation and partnerships they have established (Marcela et al., 2002).

In the last period of the 20th century, with the effect of liberalization and globalization, airline companies have been directed to follow different strategies. After the liberalization movement gained momentum, more than 380 collaborations were established between 171 international airline companies in 1996. One of the success criteria in international partnerships is undoubtedly the correct selection of the partner or partners. It should be evaluated whether the partners or partnerships have complementary and supportive qualities in terms of the business, and analysis should be made by providing correct information on this subject (Kellner et al., 2015).

Developing the agency network plays a key role in meeting customer demands and increasing market share in the aviation industry. According to some, while increasing the capacity, according to others, it reduces the costs. Partnerships with government agencies can also be established when building this network.' It is possible that in a policy network some government agencies are more powerful due to their attributes or relations (popularity effect or preferential attachment in the social network terms). In general, popularity effect plays a main role at the early stage of a network's formation while preferential attachment's role is more gradual.' (Sun and Cao, 2018)

5. Development of IT infrastructure

The efficient and effective realization of transportation, which is an important part of logistics, is highly dependent on the informatics infrastructure. At the beginning of this, there are instantaneous changing customer demands and instant sharing of information. In the supply chain, there is continuity of money, goods, and information flow from the beginning to the end of the process. For this reason, one of the most important steps in improving the business volume in the aviation sector with the rapidly developing technology is to develop the information technology infrastructure. 'Globalization of market and business competition over the previous few years has changed the business landscape. To respond to business competition, organizations are using new information technologies to provide quality services, achieve cost leaderships and attain sustainable competitive advantages' (Abeyrathna et al., 2019)

Importance of IT structure in enterprises has been stressed in several studies in literature. One of them is 'The digital capability of a business is fundamental to remaining competitive on today's market. Digital technologies are rapidly changing and evolving, which in turn increases competition and the need for companies to innovate quickly. It has never been more dangerous for companies to neglect the importance of digital technologies' (Molchanova, 2020).

In another study by Lian 2021, the positive of improved technologies has been stressed as 'In aircraft maintenance practices, the feasible utilization of information technology such as Big Data analysis, Internet of Things mode, AI Scenarios, can improve maintenance efficiency and safety. Establishing maintenance data analysis system, technical data analysis, intelligent expert troubleshooting system, materials and tools sharing system, can be beneficial to allocate integrated resources, implement safety management comprehensively, and dynamically achieve the purpose of controlling or reducing risks to an acceptable safety level' (Lian, 2021).

Furthermore, application of Blockchain technology in supply chain has been explained and exemplified in many

studies in literature. One of them is by Li et al., 2020; 'With the extensive application and reform of Blockchain technology in the fields of finance and supply chain, the further development of Blockchain technology has increasingly attracted great interest of air transport industry.'

However, while developing the IT infrastructure by considering local and global competitors in the market is costly in the aviation industry, it provides a superior competitive advantage in long-term flexibility, agility and meeting changing customer demands. It also contributes to the creation of an effective and efficient agency network. In addition to all these, it provides convenience in meeting the increasing demand in the aviation industry and increases logistics performance. 'Organizations are increasingly turning to information technology (IT) to help them respond to respond unanticipated environmental threats and opportunities' (Tallon et al., 2019). Moreover, internet of things applications also plays an important role concerning increasing capacities of air cargo firms (Abdelhadi & Akkartal, 2019).

3. Methodology

The purpose of this study is to determine and weight the strategies that forwarders operating in air cargo sector can apply to increase their business volumes, benefiting from studies in literature, interviews with 10 specialists working indifferent freight forwarder companies in Turkey and AHP method.

As a result of the literature review and interviews with air cargo specialists, 5 criteria have been determined. Table 1 gives information about the interviewees.

Table 1. Interviewee Information

Order	Position	Experience (year)
1	Sales Executive	3
2	Air Export Supervisor	10
3	Air Export Supervisor	8
4	Air Export Manager	20
5	Air Export Specialist	3
6	Air Import Specialist	4
7	Air Import Manager	19
8	Air Import Manager	10
9	Sales Manager	22
10	Marketing Specialist	5

To determine the importance levels of the criteria obtained, the relevant criteria have been scored by the sector representatives interviewed. The significance levels of the criteria have been obtained using the AHP method. This method was developed by Saaty in the 1970s, which allows the researcher to make a hierarchical modeling.

3.1. AHP Method

AHP is a basic approach that is frequently used in decision making, proposed by Thomas L.Saaty (1980) in the 1970s. It is designed to choose the most accurate and best one among multiple alternatives that are compared with each other according to different criteria. In short, the AHP technique is a method that reduces difficult and complex decision problems to pairwise comparison matrices and tries to reach a solution from there.

AHP is one of the most preferred very useful techniques for decision making. By hierarchically structuring people's mindsets and ideas, they compare similar pairs according to a certain common feature and judge the intensity of importance of one factor relative to another (Saaty and Hu, 1998).

Since AHP does not only reach a solution with numerical factors, but also includes subjective factors in the system, it is considered an improvement over other decision-making method.

Application steps of the AHP method. AHP has a systematic infrastructure and by applying this infrastructure to every problem, the solution is easily reached. The steps of the AHP method are as follows (Saaty and Hu, 1998).

Step 1: The main target, criteria and alternatives are determined.

First, the problem to be solved must be defined and it is determined whether it can be solved mathematically with AHP. Then, the goal to be achieved in the solution of the problem is determined and the criteria to reach this goal are found. Finally, our problem becomes solvable with AHP by identifying alternatives whose criteria we will compare with each other.

Step 2: Creating the hierarchy structure.

The AHP system consists of a 3-level hierarchy shown in Figure 5.2. While the top step of the hierarchy indicates the target to be achieved, the 3rd level indicates the alternatives that can be selected to reach the target, and the 2nd level indicates the criteria by which the alternatives will be compared with each other.

Step 3: Pairwise Comparison of Criteria

The criteria that are planned to be used in the solution are compared with each other in pairs and their importance levels are determined according to each other. While making this comparison, the comparison scale developed by Saaty is used.

**Table 2.** Pair-wise comparison scale for AHP preferences

Numerical Rating	Verbal Judgements of Preferences
9	Extremely preferred
8	Very strongly to extremely
7	Very strongly preferred
6	Strongly to very strongly
5	Strongly preferred
4	Moderately to strongly
3	Moderately preferred
2	Equally to moderately

How important is which of the two criteria over the other? By answering the question, a pairwise comparison matrix is created.

Step 4: Normalizing the Pairwise Comparison Matrix

In order to normalize the matrix, each column is summed up in itself and each row of the matrix is divided by the total in the column where it is located, and normalization is performed.

Step 5: Calculation of Criterion Weights

To find the weight of each criterion, the weighting process is completed by taking the average of each row in the normalized matrix.

Step 6: Calculating Consistency

After the actions taken, the consistency of the matrix is checked to determine whether the decision makers exhibit consistent behavior. For a matrix to be considered consistent, the consistency value must be less than 10%. The consistency calculation is done with the following steps.

1. The pairwise comparison matrix is multiplied by the weighted eigenvector matrix and then each value is divided by the corresponding eigenvector.

2. The average of each value obtained in the first line is taken and this maximum eigenvalue is expressed as  $\lambda_{max}$ .

3. The consistency ratio calculation is performed in 2 stages. First, the consistency index (CI) is calculated.

Equation 1: Consistency Index

$$CI = (\lambda_{max} - n) / (n - 1). \tag{1}$$

4. After calculating the consistency index, the Random Consistency Index (RI) is calculated.

**Table 3,** Average Random Consistency

Size of Matrix	1	2	3	4	5	6	7	8	9	10
Random consistency	0	0	0.5	0.8	1.1	1.2	1.3	1.4	1.4	1.4

Source: Saaty, T. L. (1990). An exposition of the AHP in reply to the paper "remarks on the analytic hierarchy process". Management science, 36(3), 259-268,

Consistency rate is calculated with below formula

Equation 2: Consistency rate

$$CR = CI / RI \tag{2}$$

The result is expected to be less than 0.1. If it is lower than this rate, the result is considered consistent, if it is higher, the result is considered inconsistent.

#### 4. Results and Discussions

In the study, the tactics, and strategies that forwarders in the air cargo sector can apply in order to increase their business volumes have been determined after the literature review and interviews with 10 experts working in the sector. To determine the criteria, the questions asked after the demographic characteristics of the person are as follows.

- What are the strategies and tactics that Air Cargo Transport Companies can apply in the long and short term to improve their business volume in general?
- Can you give examples of the strategies and tactics applied to increase the business volume in the businesses you work with? Do you think they are successful?
- Can you rank these strategies and tactics in order of importance?

- Is there an application that you think is specific to air cargo shipping companies?

Taking into consideration both interviews and studies in the literature in the same field, criteria set has been formed as follows:

**Table 4.** Criteria set for the analysis

Criteria no#	Criteria
1	Staff trainings to improve customer relations
2	Improving relations with carriers
3	Marketing Strategies
4	Improvement of Agency Network
5	Development of IT structure

After the criteria has been determined, 3 of the interviewees have been asked to make pairwise comparisons using Saaty’s 1-9 scale in line with their own knowledge and experience. Pairwise comparison matrices have been found by taking the geometric averages of the answers given by the participants. These matrices reflect the consensus of experts. In the application, a four-level AHP model was created. After the importance levels of the criteria have been obtained, the consistency levels have been measured by using randomness indicators. The table containing the importance levels, consistency levels of the criteria of the study and the final ranking of the criteria is given below.

**Table 5.** Final Ranking of Criteria

Criteria	Weights
Staff trainings to improve customer relations	0.5021
Improving relations with carriers	0.1462
Marketing Strategies	0.0563
Improvement of Agency Network	0.1544
Development of IT structure	0.1410

Consistency rate is 0,01269409 which is below 0.1. It suggests that the result is consistent.

## 5. Conclusion

Today, international companies apply different strategies to market the goods and services they produce to foreign countries more effectively. Not only the quality of the product, but also every stage of the journey of the product to the consumer markets has been the subject of foreign trade, thus global competition. International companies producing goods and services have realized the importance of transferring their products to global markets quickly and reliably. For international companies to compete in the global market, it is important that their countries have infrastructures suitable for this purpose. Logistics infrastructure is one of the important indicators that reflect a country's view of foreign trade. Transportation emerges as a critical phenomenon here, and its sub-unit, air cargo transportation, has begun to be used as a strategic tool in global commercial competition.

Air cargo forwarders plays an essential role in air cargo transportation process. They provide service providing communication between the stakeholders in the supply chain. However, there is a fierce competition in this sector due to huge number of companies. For this reason, this companies need to respond to changes in the globalization era by applying some strategies. In this scope, the purpose of this study is to determine and weight the strategies that forwarders operating in air cargo sector can apply to increase their business volumes, benefiting from studies in literature, interviews with 10 specialists working indifferent freight forwarder companies in Turkey and AHP method.

As a result of the interviews and literature review, following criteria has been determined; staff trainings to improve customer relations, improving relations with carriers, marketing strategies, improvement of agency network, development of IT structure. Thanks to AHP method (The Analytic Hierarchy Process), these criteria has been weighted. Based on this analysis, the most important strategy that air cargo freight forwarders can apply has been determined as ‘staff trainings to improve customer relations (0,5021)’ followed by ‘improvement of agency network (0,1544), ‘Improving relations with carriers (0,1462), ‘development of IT structure (0,1410), ‘marketing strategies (0,0563). This ranking suggest that it is very essential for companies operating in this field to provide trainings to its staffs especially on customer relationship management. Of course, other strategies used in the analysis should not be ignored and forwarders need to make required investment on these areas to improve their business volume.

Conducted interviews with the specialist and use of multi-criteria decision-making techniques in an integrated manner will facilitate business analysts and decision makers in the quantitative evaluation of subjective and objective criteria. In the future studies the relations between the criteria can be analyzed and compared using different multi-criteria techniques.

The topic of the study is expected to fill the gap in the literature and will be a guide for future studies. For future studies, different multi-criteria decision making techniques can be applied and results can be compared.

## Ethical approval

Not applicable.

## Conflicts of Interest

The authors declare that there is no conflict of interest regarding the publication of this paper.

## References

- Abdelhadi, A., & Akkartal, E. (2019). A framework of IoT implementations and challenges in Warehouse Management, Transportation and Retailing. *Eurasian Business & Economics Journal*, pp. 25-41.
- Abeyrathna, A. G., Tissera, P. S., & Rajapakshe, W. (2019, March 11). Usage of Information Technology on Employee Commitment: Airport & Aviation Industry in Sri Lanka (AASL). *Asian Journal of Economics, Business and Accounting*, pp. 1-15.
- Akkartal, G. R., & Uludağ, C. Ç. (2022, december 25). Evaluation of competition strategies applied in logistics management during the pandemic process: A research on logistics companies in İstanbul. *BMIJ*, pp. 21-41.

- Alshurideh, M., Alsharari, N. M., & Al Kurdi, B. (2019, February 27). Supply Chain Integration and Customer in the Airline Industry. Scientific Research Publishing, pp. 392-414.
- Kohtsuki, S., & Izumi, T. (2014). A Study of the Usable Concept of Transportation Information Services for the High Value-Added Railway Transportation Infrastructure. 2014 Proceedings of PICMET '14: Infrastructure and Service Integration, (pp. 3396-3404).
- Le, T. A., Nguyen, T. T., Trinh, T. A., & Nguyen, T. P. (2021). Factors Affecting Quality of Working Life: A Study on Front-line Employees in Vietnamese Aviation Sector. Transportation Research Procedia, pp. 118-126.
- Li, J., Peng, Z., Liu, A., He, L., & Zhang, L. (2020). Analysis and Future Challenge of Blockchain in Civil Aviation Application, International Conference on Computer and Communications (ICCC), Chengdu, China, (pp. 1742-1748). China: IEEE.
- Lian, X. (2021). Application Prospects of New Information Technology in Aviation Maintenance Industry. The International Symposium on Mechatronics and Industrial Informatics (ISMII), Zhuhai, China, pp. 288-291.
- Molchanova, K. (2020). A Review of Digital Technologies in Aviation Industry. In K. Molchanova, Logistics in aviation (pp. 69-77). Ukraine.
- Sun, Y., & Cao, C. (2018, January 10). The evolving relations between government agencies of innovation policymaking in emerging economies: A policy network approach and its application to the Chinese case. Research Policy, pp. 592-605.
- Tallon, P. P., Queiroz, M., Coltman, T., & Sharma, R. (2019). Information technology and the search for organizational agility: A systematic review with future research possibilities, The Journal of Strategic Information Systems, pp. 218-232.
- Yiu, C. Y., Ng, K. K., Yu, S. C., & Yu, C. W. (2022, September 20). Sustaining aviation workforce after the pandemic: Evidence from Hong Kong aviation students toward skills, specialised training, and career prospects through a mixed-method approach. Transport Policy, pp. 179-192.
- Ng, K. T., Fu, X., Hanaoka, S., & Oum, T. H. (2022). Japanese aviation market performance during the COVID-19 pandemic-Analyzing airline yield and competition in the domestic market. Transport Policy, 116, 237-247.
- Merkert, R. (2022). Air Cargo Logistics: The Dawning of a Golden Decade? In Global Logistics and Supply Chain Strategies for the 2020s: Vital Skills for the Next Generation (pp. 135-149). Cham: Springer International Publishing.
- Zhu, L., Wu, Y., Smith, H., & Luo, J. (2022). Optimisation of containerised air cargo forwarding plans considering a hub consolidation process with cargo loading. Journal of the Operational Research Society, 1-20.
- Van Asch, T. (2022). The forwarders' power play effect on competition in the air cargo industry. In The Air Transportation Industry (pp. 361-381). Elsevier.
- Feng, B., Jiang, Z., & Lai, F. (2020). Robust approach for air cargo freight forwarder selection under disruption. Annals of Operations Research, 291, 339-360.
- Amaruchkul, K., & Lorchirachoonkul, V. (2011). Air-cargo capacity allocation for multiple freight forwarders. Transportation Research Part E: Logistics and Transportation Review, 47(1), 30-40.
- Appelbaum, S. H., & Fewster, B. M. (2004). Safety and customer service: Contemporary practices in diversity, organizational development and training and development in the global civil aviation industry. Management Research News, 27(10), 1-26.
- Itani, O. S., Goad, E. A., & Jaramillo, F. (2019). Building customer relationships while achieving sales performance results: Is listening to the holy grail of sales? Journal of Business Research, 102, 120-130.
- Chen, Z. (2022). Artificial intelligence-virtual trainer: Innovative didactics aimed at personalized training needs. Journal of the Knowledge Economy, 1-19.
- Dmytriiev, S. D., Freeman, R. E., & Hörisch, J. (2021). The relationship between stakeholder theory and corporate social responsibility: Differences, similarities, and implications for social issues in management. Journal of Management Studies, 58(6), 1441-1470.
- Varadarajan, R. (2010). Strategic marketing and marketing strategy: domain, definition, fundamental issues, and foundational premises. Journal of the Academy of Marketing Science, 38, 119-140.
- Cheung, T. K., Wong, C. W., & Zhang, A. (2020). The evolution of aviation network: Global airport connectivity index 2006-2016. Transportation Research Part E: Logistics and Transportation Review, 133, 101826.
- Ukwandu, E., Ben-Farah, M. A., Hindy, H., Bures, M., Atkinson, R., Tachtatzis, C., ... & Bellekens, X. (2022). Cyber-security challenges in aviation industry: A review of current and future trends. Information, 13(3), 146.
- Marcela Herrera Bernal, S., Burr, C., & Johnsen, R. E. (2002). Competitor networks: international competitiveness through collaboration: the case of small freight forwarders in the high-tech forwarder network. International Journal of Entrepreneurial Behavior & Research, 8(5), 239-253.
- Kellner, F., & Igl, J. (2015). Greenhouse gas reduction in transport: analyzing the carbon dioxide performance of different freight forwarder networks. Journal of Cleaner Production, 99, 177-191.
- Saaty, T. L., & Hu, G. (1998). Ranking by eigenvector versus other methods in the analytic hierarchy process. Applied Mathematics Letters, 11(4), 121-125.

**Cite this article:** Mızrak, F., Akkartal, G.R. (2023). Determining and Evaluating the Strategies of Air Cargo Freight Forwarders to Increase Business Volume with AHP Method. Journal of Aviation, 7(2), 226-232.



This is an open access article distributed under the terms of the Creative Commons Attribution 4.0 International License

**Copyright © 2023 Journal of Aviation** <https://javsci.com> - <http://dergipark.gov.tr/jav>



# Stock Price Prediction with Box-Jenkins Models: Delta Airlines Application

Muhammed Fatih Yürük<sup>1\*</sup> 

<sup>1\*</sup>Dicle University, School of Civil Aviation, 34469, Sur, Diyarbakır, Türkiye. (mfatih.yuruk@dicle.edu.tr)

## Article Info

Received: 04 April 2023  
Revised: 12 May 2023  
Accepted: 06 June 2023  
Published Online: 13 July 2023

### Keywords:

Aviation  
Box-Jenkins  
ARIMA  
ARMA

Corresponding Author: Muhammed Fatih Yürük

## RESEARCH ARTICLE

<https://doi.org/10.30518/jav.1277250>

## Abstract

The aviation industry has a great impact on the economic development of countries. This industry is effective in increasing the global gross domestic product both directly and indirectly. The share of airline companies in this economic development is important. This study, it is tried to estimate the monthly stock price of an airline company that contributes to economic growth. In the study, the monthly prices of shares of Delta Airlines, which are among the largest airline companies in America, traded in the New York Stock Exchange (NYSE), covering the period of 2010 January-2021 December, were included. Stock prices are from Box- Jenkins models; It has been tried to estimate using Autoregressive Models (AR), Moving Average Models (MA), Autoregressive and Moving Average Model (ARMA). In the study, the (AR) model was included in the prediction modelling because it provided the assumptions. The result of the study showed that the Box- Jenkins approach gave successful results in the estimation outputs.

## 1. Introduction

Aviation has been an industry that occupies a very important place in human history. Thanks to this industry, billions of people have gained the freedom to travel quickly, comfortably and reliably. After the Second World War, with the shift of military equipment and technology to civil aviation, different trade areas emerged in this industry. The process, which started with passenger transportation, has started to serve many sectors in cargo transportation, tourism trade and different trade areas in the later stages. Civil aviation, which contributes to the economic growth of countries on a global scale, employs the unemployed and millions of career planning through many airline companies and airports around the world. Aviation, which is a fast mode of transportation, increases the tourism industry by transporting billions of people from one country to another, and the economic growth of countries increases positively with the growth of tourism. Air transport mode takes its place as the first choice of travellers. With the increasing trend of air transport, the bond between countries is getting stronger. The aviation industry helps people understand and respect cultural and social differences by bringing people of different religions, languages and races together. In other words, it helps the manifestation of peace in the world. The coming of peace will bring economic stability to the world. The aviation industry is an important factor contributing to economic growth. Aviation

has brought trade awareness with it. As can be seen in Figure 1, the growth of this sector brings many technological growths with it. The use of value-added products in the aviation industry will increase the global sales volume of these products. Many new sectors will emerge with the growth of the aviation industry. This related commercial relationship causes the valuation of airline companies.

The aviation sector has a fragile structure that is directly affected by risks arising from many different factors, such as economics, safety, and health. The fact that this sector, which is open to risks, takes important measures makes it necessary to create strong strategies that can be implemented. For this reason, new strategic approaches to the aviation sector have been developed and have started to be implemented. (Kavak and Kaygın, 2021). The aviation sector has grown, developed, and set an example for the world under the leadership of the United States of America (USA) throughout history. For this reason, the US aviation sector was subjected to examination in the study.

Figure 1 shows the air transport industry and its economic impacts. As seen in the figure, air transport is divided into two as aviation sector and the civil aviation sector. Sectors that directly affect the aviation transportation industry; airlines, airports and services, Air navigation and civil aviation-related sectors. Suppliers, the manufacturing industry, and business services indirectly affect the air transport industry. In summary, the air transport industry affects many sectors and will contribute to economic prosperity and growth. In this

study, the estimation of stock prices of Delta Airlines, one of the airline companies, which is one of the parts of such an important sector, has been studied. In the literature, it is seen that the Box-Jenkins method is rarely used in the aviation sector. For this reason, the study, it was tried to estimate the

stock value of an airline company in the aviation sector by using the Box-Jenkins method.

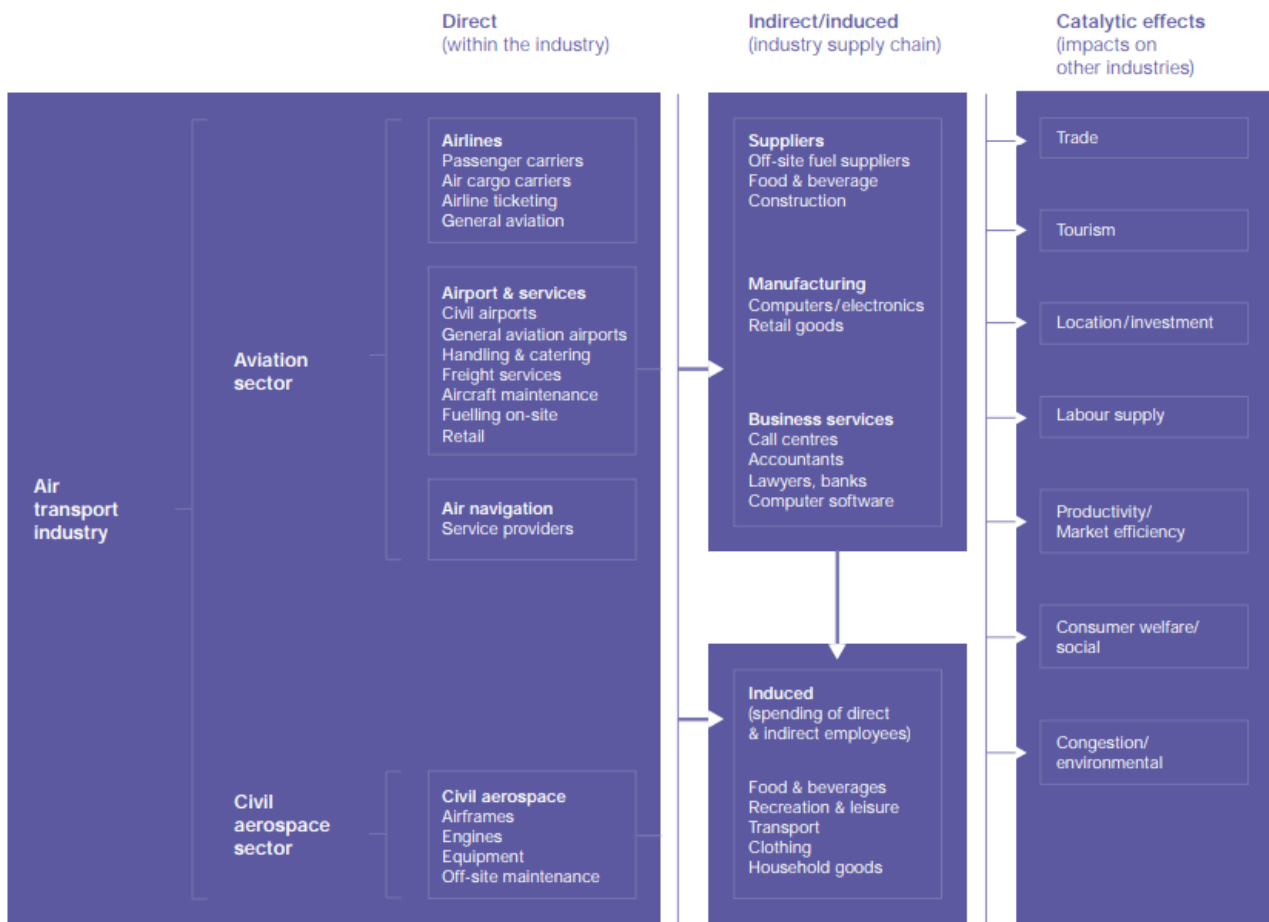


Figure 1. The Air Transport Industry Andean its Economics impacts (Icao, 2012)

## 2. Impact of Aviation on Global Employment and GDP

Aviation has positive effects on the growth and well-being of countries. This effect on a global scale can be seen more clearly in Figure 2. 87.7 million jobs are supported by the aviation industry. Tourism, directly and indirectly, induces this support and takes the form of a catalytic effect. Globally, 11.3 million people work in the aviation industry. 18.1 million people work in aviation-related indirect jobs. As can be seen in Table 1, 13.3 million of the 87.7 million jobs were created by European countries, while 46.7 million of them were created by European countries. It forms the Asia-Pacific region.

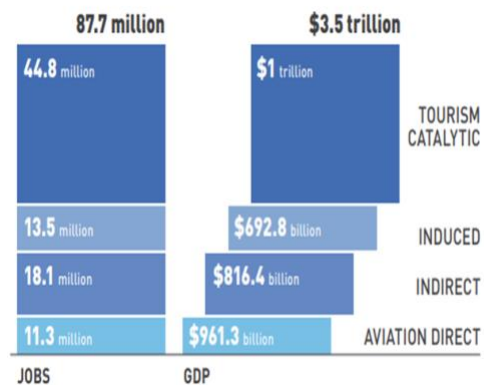


Figure 2. Impact of Aviation on Global Employment and GDP (2019), (aviationbenefits, 2020)

The global economic benefit of aviation can be seen in the gross domestic product. The aviation industry provides global economic support with a total gross domestic product of \$3.5 trillion. \$961.3 billion of this was directly contributed by the aviation industry, while \$816.4 billion was provided by the indirect effect of aviation.

**Table 1.** Statistical Information of Aviation by Regional

Region	Jobs supported	GDP supported	Passengers (2019)	% of global passengers
AFRICA	7.7m	\$63 bn	115m	2.5%
ASIA-PACIFIC	46.7 m	\$944 bn	1.7 bn	37%
EUROPE	13.5m	\$991 bn	1.2 bn	26%
LATIN AMERICA AND THE CARIBBEAN	7.6m	\$187 bn	356 m	7.7%
MIDDLE EAST	3.3m	\$213 bn	192 m	4.2%
NORTH AMERICA	8.8m	\$1.1 tm	1 bn	22.7%

Source: (aviationbenefits, 2020)

According to the information given in Table 1, the contribution of aviation to the gross domestic product is led by North America, with \$1.1 tm; then, with \$991.1 bn, Europe's contribution to the economy with aviation is seen. The Asia-Pacific region holds 37% of global passenger transport, carrying 1.7 thousand passengers in 2019. Then, respectively, Europe (26%), North America (22.7%), and Latin America and the Caribbean region share 7.7% of the total in global passenger transport.

### 3. Literature

In the literature, it is seen that the Box-Jenkins method is used for predictive modelling in many areas. In the studies, it is stated that the estimation performance of the method gives successful results. That is why the Box-Jenkins method is used quite often. In the literature, it is seen that the Box-Jenkins method is rarely used in the connection of the aviation sector with finance. It has been seen that the method is mostly used in the aviation sector for issues such as transportation demand and passenger demand. For this reason, the connection between aviation and the finance branch was dealt with in the study, and a forecast model was developed.

Bircan and Karagöz (2003) Jenkins method to predict the future of exchange rates by giving general information about time series, Box- Jenkins models are examined, and the application phases of the Box-Jenkins method are explained. The most appropriate estimation model was determined for the 132-month exchange rate series covering the period of January 1991 and December 2002.

Doğan and Ersel (2009) analyzed the export and import series using Box-Jenkins models. The monthly export and import series for the period January 2003–May 2008 were analyzed. In these analyses, calculations were made in dollar terms, and parity differences and price changes were not taken into account. Although it was thought that political and similar developments had an impact on the volume of foreign trade, such developments were not evaluated as much as possible. According to the findings, it is predicted that foreign trade deficits will continue to be an important problem in 2009 as well.

Suleman and Sarpong (2012) used the Box- Jenkins approach to model milled rice production using time-series data from 1960 to 2010 when the Ghana government called for a doubling of rice production due to the increasing rice demand in the country. The analysis revealed that ARIMA (2, 1, 0) was the best model for estimating milled rice production.

Ahmad (2012) applied the Box-Jenkins auto-regressive integrated moving average (ARIMA) modelling approach for time series analysis of monthly average prices of Omani crude

oil over a period of 10 years. The identified models were then estimated and compared in terms of the significance of parameter estimates, mean square errors, and their adequacy using the Modified Box-Pierce (Ljung-Box) Chi-Square statistic. Based on these criteria, a multiplicative seasonal ARIMA (1,1,5) x (1,1,5) x (1,1,5) x (1,1,5)<sub>4</sub> model is proposed for short-term forecasting. In his study, the author shows that the ARIMA modelling approach is an effective tool in time series analysis. Moreover, the proposed model for Oman's crude oil prices is suggested as a useful alternative for short-term forecasting.

Özer and İlkdoğan (2013), world cotton prices were analyzed with the ARIMA model using a 102-month data set covering the period of January 2004 and June 2012. ARIMA (1,1,1) (1,0,1) 12 seasonal model was determined as the most suitable model. According to this model, it is estimated that the world cotton price average will be 1.49 dollars in the 2012–2013 season, 1.57 dollars in the 2013–2014 season, and 1.55 dollars in the 2014–2015 season.

Okereke and Bernard (2014) developed a model to estimate Nigeria's GDP using the Box- Jenkins approach in their study. Autocorrelation function (ACF) and partial autocorrelation function (PACF) graphs of logarithmically transformed and differentiated series showed that the best model would be SARIMA (2, 1, 2) x (1, 0, 1). The ACF and PACF of the residuals from the constructed model behaved similarly to the white noise process, confirming the adequacy of the model. Then, using the model, Nigeria's one-year GDP is estimated.

Dritsak (2015) used econometric techniques to look into the trading habits of the Athens Stock Exchange (ASE). The serial correlation results indicate that the weak-form efficacy hypothesis of ASE should be rejected. In addition, Augmented Dickey-Fuller and Phillips-Perron tests confirm the existence of unit roots in the levels of stock prices. This shows that the future values of stock prices cannot be defined from past values, and the random walk hypothesis is compatible with the autoregressive integrated moving average (0, 1, 2) model. The findings of this study showed that the ASE may not be very efficient, and it may be difficult to predict future stock prices. Overall, this study highlights the importance of using econometric procedures to analyze the behavioral characteristics of stock market indices. The results suggest that the ASE may not be very efficient, and investors may need to consider alternative strategies to predict future stock prices.

Çelik (2017) theoretically examined the effects of the air transport industry in his study. In his study, the author also mentioned the economic dimension while explaining what purposes the air transport industry serves. In addition, the contributions of aviation have been analyzed by taking into account regional differences in the global market. As a result of the study, problems and solutions that may prevent the development of this industry, which is important for many sectors, have been proposed.

Nyoni (2019) Jenkins used the ARIMA technique to model and estimate the CPI in the UK. Diagnostic tests using annual time series data from 1960 to 2017 show that the K series is I(2). In his study, the author proposes the ARIMA (1,2) model to estimate the CPI in the UK. Diagnostic tests also show that the optimal model presented is stable and acceptable. The results of the study show that the CPI in the UK will continue its sharp upward trend over the next ten years.

Sharma and Phulli (2020) used the Box- Jenkins ARIMA model to estimate India's future military spending. The model is built on a dataset of 60 years of Indian military spending

from 1960 to 2019. This research proposes an ARIMA (0, 1, 6) model for optimal estimation of India's military expenditure with an accuracy of 95.7%. The model functions as a moving average (MA) model and predicts 36.94% steady-state exponential growth in India's military spending through 2024.

#### 4. Materials and Methods

Box- Jenkins as a method in the study (Box and Jenkins, 1976) was used. Box- Jenkins, which is frequently used in predicting the future in the field of finance and gives very successful outputs, takes its place in the literature as a univariate model. In studies where this method is used, it is important to make the assumptions of the Box-Jenkins method that the series consist of data obtained at equal time intervals and that they are discrete and stationary. The Box Jenkins method was developed based on the assumption that time-dependent random events and time series related to these events are scholastic processes. For this reason, Box- Jenkins models are called linear stationary stochastic models (Bircan and Karagöz, 2003). The Box- Jenkins technique is a method used to analyze and forecast time series. This method is based on discrete, linear stochastic processes and includes different estimation models such as autoregressive, moving average, autoregressive-moving average, and integrated autoregressive-moving average. AR (p), MA (q), and ARMA (p,q) models are used for stationary processes, while ARIMA (p,d,q) models are used for non-stationary processes. These models are used to predict changes and trends in time series and are frequently used in fields such as finance, economics, and meteorology. The Box- Jenkins technique is an effective method for analyzing and estimating data in time series. This method draws attention, especially to the ARIMA model, which is used to predict changes in non-stationary processes. In this way, it is possible to make accurate predictions using time series analysis, which has an important place in fields such as finance, economics, and meteorology (Hamzaçebi and Kutay, 2004).

In the study, the monthly prices of the stocks of Delta Airlines, which are among the largest airline companies in America and trade on the New York Stock Exchange (NYSE), covering the period between January 2010 and December 2021, are included. The data is taken from the <https://www.investing.com/> website.

#### 4.1. Linear Stationary Stochastic Models

##### 4.1.1. Autoregressive Models (AR)(p)

The observed yt series with the p-th degree autoregressive process is equal to the total value of the disruptive term with the weighted average of the yt values going backwards for the p period. The equation with an autoregressive process is written as follows.

$$y_t = m + \alpha_1 y_{t-1} + \alpha_2 y_{t-2} + \dots \dots \alpha_p y_{t-p} + u_t \quad (1)$$

In Equation 1, “m” is a constant and relates to the mean of the stochastic process. If the autoregressive process is stationary  $\mu$ , the mean remains constant regardless of time. The higher the p-value, the shorter or longer the equation will be. In a stationary series, when the coefficients of the above equation are enclosed in parentheses,  $1 - \alpha_1 - \alpha_2 - \dots \dots \alpha_p < 1$  (Kutlar, 2017).

##### 4.1.2. Moving Average Patterns (MA)(q)

In the MA(q) model, the Yt value is the linear function of the backward error terms of the series and its mean over q periods. The MA(q) models are generally represented as follows:

$$Y_t = \mu + a_t - \theta_1 a_{t-1} - \theta_2 a_{t-2} - \dots - \theta_q a_{t-q} \quad (2)$$

Here  $a_t, a_{t-1}, a_{t-2}, \dots \dots a_{t-q}$  error terms,  $\theta_1, \theta_2, \dots, \theta_q$  coefficients for error terms,  $\mu$  a constant that is the mean of the process (Hamzaçebi and Kutay, 2004).

##### 4.1.3. Autoregressive and Moving Average Model (ARMA)

When series are not expressed by AR or MA models alone, they are expressed by a combination of autoregressive and moving average models. Models created in this way are expressed as ARMA in the literature (Kutlar, 2017). ARMA (p, q) models are written as follows:

$$Y_t = \Phi_1 Y_{t-1} + \Phi_2 Y_{t-2} + \dots + \Phi_p Y_{t-p} + \delta + a_t + \theta_1 a_{t-1} - \theta_2 a_{t-2} - \dots - \theta_q a_{t-q} \quad (3)$$

In the ARMA equation numbered (3),  $Y_{t-1}, Y_{t-2}, \dots \dots Y_{t-p}$  the past observation values,  $\Phi_1, \Phi_2, \dots \dots \Phi_p$  the coefficients of the past observation values,  $\delta$  the constant value,  $a_t, a_{t-1}, a_{t-2} \dots \dots, a_{t-q}$  refers to (Hamzaçebi and Kutay, 2004).

##### 4.1.4. Autoregressive Integrated Moving Average Model (ARIMA)

ARIMA (p, d, and q) models are a type of ARMA (p, q) models and are used frequently. Unlike ARMA models, ARIMA models are made stationary by taking the d- order difference of non-stationary series. Since some macro variables are not stationary in nature, their difference is necessary, and such series have to be differentiated. Therefore, in ARIMA models, the ARMA estimation made for the first or d'th order difference instead of the main series is actually used as the ARIMA estimation (Kutlar, 2017).

ARIMA models are widely used in time series analysis. These models are used to predict future values and are particularly useful for economic, financial, and social data. ARIMA models can predict future values by considering series trends, seasonal effects, and other factors. ARIMA models are popular because of their high predictability. These models are used to understand the causes and effects of changes in time series. Similar to ARMA models, ARIMA models use statistical analysis methods and mathematical formulas to predict future trends using the history of the data.

The Box-Jenkins method is a four-step method for predicting time series. In the first stage, model determination, the appropriate Box- Jenkins model is determined. In the second stage, parameter estimation, parameters suitable for the determined model are estimated. In the third stage, the Test of Conformity, the suitability of the determined model to the data set is tested by statistical methods. If the model is found suitable, the last stage is passed; otherwise, it is returned to the first stage to determine another model. The most suitable model selected in the last stage, estimation, is used for forecasting (Kaynar and Taştan, 2009).



5. Result and Discussion

In the study, the monthly prices of the stocks of Delta Airlines, which are among the largest airline companies in America and trade on the New York Stock Exchange (NYSE), covering the period between January 2010 and December

2021, are included. These periods include 144 observations. In order to apply the Box- Jenkins method, the series must first be made stationary, if not already stationary. For this, the logarithm of Delta Airlines stocks was taken and the Augmented Dickey -Fuller test (ADF) applied.

Table 2. Stability Test Results

Augmented Dickey -Fuller Unit Root Test Results							
logdelta		Intercept		Trend-Intercept		None	
		Level	I. Difference	Level	I. Difference	Level	I. Difference
ADF Test statistic	t -Static	-1.334	-11.588	-1.115	-11,591	0.681	-11,563
	prob.	0.613	0.000	0.922	0.000	0.862	0.000
MacKinnon	1%	-3.477	-3.477	-4.024	-4.024	-2.581	-2.581
	5%	-2.882	-2.882	-3.442	-3.442	-1.943	-1.943
Critical Values	10%	-2.578	-2.578	-3.145	-3.146	-1.615	-1.615

Phillips-Perron Unit Root Test Results							
logdelta		Intercept		Trend-Intercept		None	
		Level	I. Difference	Level	I. Difference	Level	I. Difference
Phillips-Perron test	t -static	-2.565	-11,642	-1.309	-11,643	0.591	-11,624
	prob.	0.587	0.000	0.882	0.000	0.843	0.000
MacKinnon	1%	-3.477	-3.477	-4.024	-4.024	-2.582	-2.582
	5%	-2.882	-2.882	-3.442	-3.442	-1.943	-1.943
Critical Values	10%	-2.578	-2.578	-3.145	-3.146	-1.615	-1.615

For determining the Box-Jenkins model suitable for the dataset, the stationarity of the series was determined by using the version Eviews 12 program. For the determination of the stationary state of the series, Dickey-Fuller and Phillips-Perron unit root tests were used. In the two tests, constant, constant, and trend were examined at level, and the first difference was for unconstant and trendless. The results are shown in Table 2. As seen in the table, According to Dickey-Fuller and Phillips-Perron unit root test results, it is seen that the series whose

logarithms are taken become stationary at the first difference. At the next stage, an appropriate AR model was trying to be created. The statistical significance of the coefficients from AR (1 to 10) was investigated. As seen in Table 3, the coefficients of the AR (1) model are statistically significant, while the other AR coefficients are not. The AR (1) coefficient probe value was found to be smaller than the margin of error.

Table 3. (AR) Coefficients Statistical Results

Variable	Coefficient	Std. error	t-Statistics	prob
C	3.230733	0.452083	7.146328	0.0000
AR(1)	1.012148	0.093408	10.83583	0.0000
AR(2)	0.081026	0.138395	0.585468	0.5592
AR(3)	-0.030050	0.131089	-0.229231	0.8190
AR(4)	-0.080996	0.129549	-0.625214	0.5329
AR(5)	-0.058687	0.126034	-0.465642	0.6422
AR(6)	0.057485	0.133915	0.429264	0.6684
AR(7)	0.089810	0.123859	0.725096	0.4697
AR(8)	-0.176035	0.132744	-1.326119	0.1871
AR(9)	0.088625	0.155931	0.568356	0.5708
AR(10)	0.003249	0.111053	0.029253	0.9767
SIGMASQ	0.009905	0.001120	8.841836	0.0000
R-squared	0.977060	Mean dependent var		3.368417
Adjusted R-squared	0.975148	SD dependent var		0.659397
SE of regression	0.103950	Akaike info criterion		-1.582814
sum squared resid	1.426347	Schwarz criterion		-1.335329
log likelihood	125.9626	Hannan-Quinn criterion		-1.482250
F-statistic	511.1018	Durbin-Watson stat		1.994665
Probe(F-statistic)	0.000000			

Then, the AR(2) and AR(10) coefficients were removed because they were not significant and the calculation was performed again by leaving only the AR(1) coefficient. The calculated statistical values are shown in Table 4. For the

AR(1) model, the Logdelta series is defined by its own historical values and the historical values of the errors. As seen in the table, the R<sup>2</sup> value is 0.9762, representing the explanatory power of the model. Logdelta explains about 98%

of the total with its autoregressive moving average time. Other criteria taken into account in explaining the power of the model are Akaike, Schwarz and Hannan-Quinn criteria. It is desirable that these criteria are close to 2.

**Table 4. AR Model Results**

Variable	Coefficient	Std. error	t-Statistics	prob
C	3.219040	0.451358	7.131893	0.0000
AR(1)	0.987668	0.013679	72,20237	0.0000
SIGMASQ	0.010270	0.000884	11.62225	0.0000
R-squared	0.976215	Mean dependent variable		3.368417
Adjusted R-squared	0.975878	SD dependent variable		0.659397
SE of regression	0.10413	Akaike info criterion		-1.673233
sum squared resid	1.478876	Schwarz criterion		-1.611362
log likelihood	123.4728	Hannan-Quinn criterion		-1.648092
F-statistic	2893,562	Durbin-Watson static		1.935585
Probe (F-statistic)	0.000000			

After passing the significance criterion of the coefficients, it was investigated whether there was an autocorrelation problem among the regression error terms calculated for AR (1). The autocorrelation test results are shown in Table 5. According to the table, at all delays (probe values)  $H_0$  The hypothesis of no autocorrelation was accepted ( $p>0.05$ ).

**Table 5. Autocorrelation Test Results**

Autocorrelation	Partial Correlation	AC	PAC	Q-Stat	Prob
		1 0.018	0.018	0.0455	
		2 0.083	0.083	1.0616	0.303
		3 0.079	0.077	1.9973	0.368
		4 -0.004	-0.013	2.0001	0.572
		5 -0.052	-0.065	2.4060	0.662
		6 -0.023	-0.027	2.4840	0.779
		7 0.054	0.066	2.9244	0.818
		8 -0.116	-0.106	4.9989	0.660
		9 -0.027	-0.032	5.1111	0.746
		10 -0.041	-0.036	5.3770	0.800
		11 0.014	0.038	5.4093	0.862
		12 -0.011	0.004	5.4295	0.909
		13 0.056	0.048	5.9275	0.920
		14 0.120	0.107	8.2481	0.827
		15 0.081	0.083	9.3075	0.811
		16 0.069	0.035	10.078	0.815
		17 0.011	-0.023	10.097	0.862
		18 -0.056	-0.087	10.630	0.875
		19 -0.019	-0.009	10.689	0.907
		20 -0.000	0.017	10.689	0.934
		21 -0.062	-0.047	11.349	0.937
		22 0.017	0.034	11.397	0.954
		23 -0.024	-0.002	11.499	0.967
		24 0.008	0.037	11.511	0.977
		25 0.044	0.059	11.847	0.982
		26 -0.100	-0.128	13.632	0.968
		27 -0.043	-0.080	13.965	0.973
		28 -0.141	-0.164	17.550	0.917
		29 -0.056	-0.074	18.122	0.923
		30 0.037	0.065	18.380	0.936
		31 0.032	0.058	18.571	0.949
		32 -0.053	-0.035	19.097	0.953
		33 -0.064	-0.058	19.870	0.953
		34 -0.019	-0.028	19.942	0.964
		35 -0.026	0.009	20.073	0.972
		36 0.023	-0.001	20.175	0.979

**Table 6. Root Test**

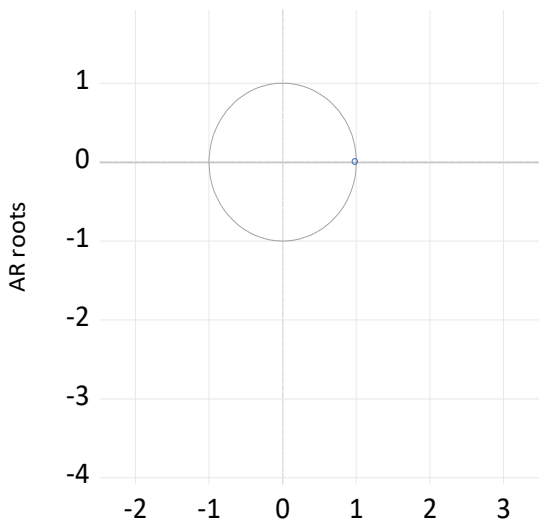
AR Root(s)	modulus	Cycle
0.987668	0.987668	

AR (1) autocorrelation criterion phase after passing then MA model for calculations made. the appropriate AR coefficient. find of the process same in MA made. MA (1–10), all coefficients are tried, and the statistical aspect is significant (Table 7).

**Table 7. (MA) Coefficients statistical Results**

Variable	Coefficient	Std. error	t-Statistics	prob
C	3.354203	0.107375	31,23815	0.0000
MA(1)	1.124798	0.210174	5.351744	0.0000
MA(2)	1.188941	0.303041	3.923365	0.0001
MA(3)	1.220896	0.242030	5.044392	0.0000
MA(4)	1.176389	0.147092	7.997618	0.0000
MA(5)	1.173329	0.351344	3.339544	0.0011
MA(6)	1.287544	0.586742	2.194397	0.0300
MA(7)	1.340641	0.639562	2.096188	0.0380
MA(8)	1.054550	0.506463	2.082187	0.0393
MA(9)	0.738812	0.313844	2.354072	0.0200
MA(10)	0.301485	0.125648	2.399446	0.0178
SIGMASQ	0.012606	0.003805	3.313332	0.0012

Although all coefficients between MA (1–10) are significant, according to the Box-Jenkins assumption, there should be no autocorrelation problem among regression error terms. Then, for all models between MA (1) and MA (10), a



**Figure 3. Inverse Roots of AR/MA Polynomial(s)**

In the next step, it was checked whether the assumption of the method, that the unit roots are within the circle, was met. In Figure 3, it is tested whether the roots are within the unit circle. Since the condition of the root could not be fully diagnosed graphically, it was also analyzed tabularly. Table 6 shows that the modulus value is less than 1. In this case, it fulfills the assumption that the roots are inside the unit circle.

test is applied to determine whether there is autocorrelation between regression error terms. The autocorrelation test results are shown in Table 8. According to the autocorrelation test results, the null hypothesis  $H_0$ : There is no autocorrelation in all lagged variables should be rejected. If the prob value is  $p < 0.05$  even with only one lag, the hypothesis cannot be rejected. As seen in the table, the P value is less than 0.05 in all lags. In this case, the hypothesis cannot be rejected. In other words, there is autocorrelation in the MA model system.

Until this stage of the study, AR and MA models have been investigated. Statistically significant results were obtained for the AR model. While statistically significant results were obtained for the coefficients of MA models, the autocorrelation test, which is one of the assumptions of the model, was not passed, and autocorrelation was detected in the system. As seen in Table 9, the ARMA model was investigated in the next stage of the study.

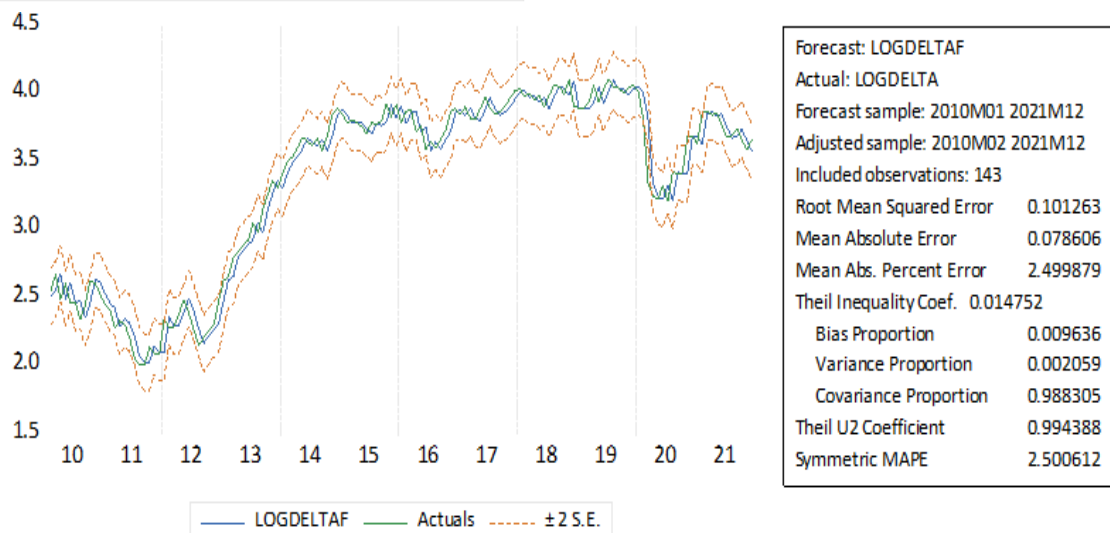
**Table 8.** Autocorrelation Test Results

Autocorrelation	Partial Correlation	AC	PAC	Q-Stat	Prob
		1 0.058	0.058	0.4926	
		2 0.162	0.159	4.3578	
		3 0.219	0.208	11.539	
		4 0.214	0.188	18.408	
		5 0.191	0.140	23.933	
		6 0.133	0.048	26.610	
		7 0.190	0.088	32.164	
		8 0.204	0.110	38.603	
		9 0.212	0.126	45.583	
		10 0.286	0.210	58.373	
		11 0.278	0.214	70.630	0.000
		12 0.074	-0.055	71.511	0.000
		13 0.162	-0.043	75.713	0.000
		14 0.221	0.038	83.610	0.000
		15 0.161	0.023	87.854	0.000
		16 0.161	0.044	92.137	0.000
		17 0.124	-0.017	94.688	0.000
		18 0.099	-0.119	96.335	0.000
		19 0.155	-0.070	100.38	0.000
		20 0.132	-0.055	103.35	0.000
		21 0.073	-0.109	104.25	0.000
		22 0.148	0.024	108.00	0.000
		23 0.059	-0.042	108.60	0.000
		24 0.101	-0.068	110.39	0.000
		25 0.167	0.038	115.33	0.000
		26 0.041	-0.046	115.64	0.000
		27 0.116	0.037	118.07	0.000
		28 -0.032	-0.098	118.26	0.000
		29 0.034	-0.079	118.47	0.000
		30 0.091	-0.000	119.99	0.000
		31 0.034	0.026	120.20	0.000
		32 0.018	0.003	120.27	0.000
		33 -0.010	-0.071	120.29	0.000
		34 0.039	-0.018	120.58	0.000
		35 0.039	-0.015	120.87	0.000
		36 0.038	0.030	121.16	0.000

**Table 9.** ARMA Model Statistical Results

Variable	Coefficient	Std. error	t-Statistics	prob
C	3.325202	0.325742	10.20808	0.0000
AR(1)	1.261006	1.933252	0.652272	0.5155
AR(2)	0.001731	2.441511	0.000709	0.9994
AR(3)	-0.216219	0.993071	-0.217728	0.8280
AR(4)	-0.036788	1.201533	-0.030618	0.9756
AR(5)	0.196291	0.472625	0.415321	0.6786
AR(6)	-0.703700	0.470290	-1.496312	0.1372
AR(7)	0.500307	1.358818	0.368193	0.7134
AR(8)	0.518601	1.043355	0.497051	0.6200
AR(9)	-0.442250	1.502167	-0.294408	0.7689
AR(10)	-0.083253	1.255334	-0.066319	0.9472
MA(1)	-0.289378	35.23554	-0.008213	0.9935
MA(2)	-0.194852	23.41657	-0.008321	0.9934
MA(3)	-0.004044	37.93141	-0.000107	0.9999
MA(4)	0.068051	56.92074	0.001196	0.9990
MA(5)	-0.255161	16.13284	-0.015816	0.9874
MA(6)	0.575987	135.2412	0.004259	0.9966
MA(7)	0.026000	46,54341	0.000559	0.9996
MA(8)	-0.770750	161.2620	-0.004779	0.9962
MA(9)	-0.065412	13,08348	-0.005000	0.9960
MA(10)	-0.090430	25.44553	-0.003554	0.9972
SIGMASQ	0.008352	0.327177	0.025529	0.9797

The model that satisfies the Box-Jenkins assumptions should be found. The coefficients between AR (1–10) and MA (1–10) were added to the equation, and it was investigated whether they were statistically significant. As seen in the table, except for the coefficient C, the other values are not statistically significant. Since the coefficients are not significant, there is no need to proceed to the other stages of the assumptions. Since the assumptions were not met, the MA and ARMA models were not constructed. Only the AR (1) model was continued to be studied. After the model was determined, the estimation phase was started.



**Figure 4.** Forecast chart and Guess Result

Figure 4 shows the prediction performance of the AR (1) process. While the blue line graph shows the prediction graph of the model, the green line graph contains the actual sample values. It is seen that the actual values and the predicted values are close to each other. When the statistical results of the prediction results are analyzed, it is desirable that the Theil inequality coefficient value is small. Theil Inequality Coef. value in this study is 0.014752. This value is divided into three parts: bias proportion, variance proportion, and covariance proportion. Among these values, the bias proportion shows the systematic error of the model and is an important value. This value is intended to be quite small. In this study, the bias proportion value of the model was found to be 0.009636, which is a very small value. The variance proportion value indicates how much of the unpredictable part of the model is not captured. In other words, it indicates how much of the uncertainty is not captured. It is desirable that this value be small. The covariance proportion value gives information about the non-systematic error. It is also known as an innocent error. The sum of the theil inequality coefficient value is 1. It is important for the success of the forecasting model that the majority of this total value of 1 is collected in the covariance proportion value. The root mean squared error, mean absolute error, and mean abs.percent error values, which express the output performance of the forecasting model, were analyzed. In the study, the root mean squared error was 0.0101, the mean absolute error was 0.0786, and the mean absolute percent error was 2.4998. The small values of these values indicate that the prediction outputs are close to the actual values.

## 6. Conclusion

The airline sector has accelerated the convergence of countries, leading to an increase in the volume of trade between countries. The increase in imports and exports will result in the growth of global gross domestic product. Countries that attach importance to the aviation industry are the countries that seize the competitive edge in the world. A measure of the economic and political power of countries is the number of aircraft in their inventory. Due to this importance, the shares of the aviation industry are valued higher on the world stock markets. In this study, the monthly prices of the stocks of Delta Airlines, one of the largest airline companies in the United States, traded on the New York Stock Exchange (NYSE) for the period between January 2010 and December 2021 are estimated by the Box-Jenkins method. Financial forecasting models have an important place in the literature. By creating a strong forecasting model, decision makers can be more stable in their investment decisions. The portfolio formed by selecting appropriate financial instruments will earn more. Investors' gains will ensure the economic development of their countries. In this study, a model has been developed to predict the price of stocks. The model output gave statistically successful results. Investors will be able to be more courageous in their near-term investment decisions with financial forecasting models.

In the literature, there is no study on forecasting the stocks price of existing airline companies in the aviation sector with the Box-Jenkins method. However, there are studies on stock price forecasting with the Box-Jenkins method. Dritsak (2015) applied the Box-Jenkins method for stock price forecasting. His study fits the ARIMA (0, 1, 2) model. However, the Theil inequality coefficient could not predict ASE stocks correctly

in this model. In this study, the AR (1) model met the assumptions, and the model was constructed. Dritsak (2015) stated that the Theil inequality coefficient is not suitable for accurate prediction in the model he created. When the statistical results of the estimation results are examined, it is desirable that the Theil Inequality Coef. value be small. In this study, the Theil Inequality Coef. value is 0.014752, which means that it is suitable for accurate estimation. In future studies, the forecast performance comparison can be made by adding different methods together with the Box-Jenkins method for stock price estimation of airline companies

## Ethical approval

Not applicable.

## Conflicts of Interest

The authors declare that there is no conflict of interest regarding the publication of this paper.

## References

- Ahmad, M. I. (2012). Modelling and forecasting Oman crude oil prices using Box-Jenkins techniques. *International Journal of Trade and Global Markets*, 5(1), 24-30.
- Aviationbenefits. (2020). Aviation: Benefits Beyond Borders. <https://aviationbenefits.org/downloads/aviation-benefits-beyond-borders-2020/>.
- Bircan, H. & Karagöz, Y. (2003). With Box-Jenkins Models An Application on Monthly Exchange Rate Forecasting. *Kocaeli University Journal of Social Sciences* (6), 49-62.
- Box, G. & Jenkins, G. (1976). Time series analysis: forecasting and control. GEP.
- Çelik, D. S. (2017). The Airline Transport Industry And Its Economic Impacts The Journal of International Scientific Researches, 2(8), 82-89.
- Doğan, C. & Ersel, D. (2009). Forecasting Turkey balance of trade with Box-jenkins models. *Economics Business and Finance*, 24(276), 52-73.
- Dritsak, C. (2015). Box-Jenkins Modeling of Greek Stock Prices Data. *International Journal of Economics and Financial Issues*, 5(3), 740-747.
- Hamzaçebi, C. & Kutay, F. (2004). Electric Consumption Forecasting Of Turkey Using Artificial Neural Networks Up To Year 2010. *Journal of the Faculty of Engineering and Architecture of Gazi University*, 19(3).
- Icao. (2012). The air transport industry and its economic impacts. [https://www.icao.int/Meetings/wrds2011/Documents/JointWorkshop2005/ATAG\\_SocialBenefitsAirTransport.pdf](https://www.icao.int/Meetings/wrds2011/Documents/JointWorkshop2005/ATAG_SocialBenefitsAirTransport.pdf).
- Kavak, O. & Kaygın, E. (2021). A chronological overview of the effects of economic crises on the civil aviation sector. *Sakarya University Graduate School of Business Journal*, 3(1), 181-186.
- Kaynar, O. & Taştan, S. (2009). Comparasion Of Mlp Artifical Neural Network And Arima Method In Time Series Analysis. *Erciyes University Journal of Faculty of Economics and Administrative Sciences* (33), 161-172.
- Kutlar, A. (2017). *Applied Time Series with EvIEWS* (Vol. 1st edition). Istanbul: Umuttepe Publications.
- Nyoni, T. (2019). Forecasting UK consumer price index using Box-Jenkins ARIMA models: University Library of Munich, Germany.
- Okereke, O. E. & Bernard, C. B. (2014). Forecasting Gross Domestic Product In Nigeria Using Box-Jenkins



- Methodology. Journal of Statistical and Econometric Methods, 3(4).
- Özer, O. O. & İlkdoğan, U. (2013). The World Cotton Price Forecasting By Using Box-Jenkins Model Journal of Tekirdag Agricultural Faculty, 10(2), 13-20.
- Sharma, D. & Phulli, K. (2020). Forecasting and Analyzing the Military Expenditure of India Using Box-Jenkins ARIMA Model: arXiv.org.
- Suleman, N. & Sarpong, S. (2012). Forecasting Milled Rice Production in Ghana Using Box-Jenkins Approach. International Journal of Agricultural Management and Development (IJAMAD), 02(2), 147585.

---

**Cite this article:** Yuruk, M.F. (2023). Stock Price Prediction with Box-Jenkins Models: Delta Airlines Application. Journal of Aviation, 7(2), 233-241.



This is an open access article distributed under the terms of the Creative Commons Attribution 4.0 International Licence

Copyright © 2023 Journal of Aviation <https://javsci.com> -  
<http://dergipark.gov.tr/jav>

## Air Cargo Carrier Selection: The Case of Turkey

Serdar Alnıpak<sup>1</sup>, Yusuf Can Tunaboğlu<sup>2\*</sup>, Sefa Ceyhan<sup>3</sup>

<sup>1</sup> İstanbul Nişantaşı Üniversitesi İktisadi, İdari ve Sosyal Bilimler Fakültesi Havacılık Yönetimi Bölümü, İstanbul, Türkiye. (serdar.alnıpak@nisantasi.edu.tr)

<sup>2\*</sup> İstanbul Nişantaşı Üniversitesi İktisadi, İdari ve Sosyal Bilimler Fakültesi Havacılık Yönetimi Bölümü, İstanbul, Türkiye. (yusufcan.tunaboğlu@nisantasi.edu.tr)

<sup>3</sup> İstanbul Nişantaşı Üniversitesi İktisadi, İdari ve Sosyal Bilimler Fakültesi Havacılık Yönetimi Bölümü, İstanbul, Türkiye. (sefa.ceyhan@nisantasi.edu.tr)

### Article Info

Received: 21 February 2023

Revised: 30 March 2023

Accepted: 05 April 2023

Published Online: 09 July 2023

#### Keywords:

Aviation

Aviation Management

Air Cargo

Air Cargo Selection

Multi-Criteria Decision Making

Corresponding Author: Yusuf Can

Tunaboğlu

### RESEARCH ARTICLE

<https://doi.org/10.30518/jav.1254490>

### Abstract

In this study, 5 companies operating in Turkey and carrying out the most air cargo shipments in 2021 (Turkish Cargo, MNG Airlines and Transportation, ACT Air Cargo, ULS Airlines Cargo Transportation and Sunexpress Cargo Transportation.) were investigated. The aim is to evaluate and analyze them according to different criteria. These are 12 different criteria: Breadth of the network, the productivity of employees, adequacy of equipments, flexibility, undamaged delivery, image, cost, customer information systems, handling customer requests and complaints, special cargo handling capabilities, flight frequency, and punctuality. In the research design, using the Multi Criteria Decision Making (MCDM) method, the opinions of 9 different experienced and active experts in the sector were used to evaluate the relevant criteria. A scale of 1 to 5 was used in the evaluation of the companies, with a value of 5 representing the maximum benefit for this criterion. As a result of the research, it was found that the most significant criteria in selecting air cargo companies are undamaged delivery, costs, and on-time delivery. In addition, (1) image, (2) flexibility, and (3) special cargo handling capabilities are among the results of the research, which are the least significant criteria. Another important result of this research is that Turkish Cargo is ranked first and MNG Airlines and Transportation is ranked second.

## 1. Introduction

Logistics is one of the most important factors that enable a country to compete on the global stage. (Demirbilek et al., 2018). Logistics is one of the basic requirements for international trade (Gani, 2017; Klaus, 2009). However, it is not enough to meet these requirements alone. At this point, air transportation, which provides fast and reliable transportation services, is of great importance (Akoğlu & Fidan, 2020). Indeed, it is well known that air transportation is the mode of transportation which offers the greatest time advantage in freight transportation (Alshurideh et al., 2019).

Air transportation consists several activities that also serve service production (Öztürk & Onurlubaş, 2019). Agencies, carriers, insurance companies, and customs agents that provide the service in question work are inseparable elements of a whole (Doğan, 2003). Looking at these activities from a

holistic perspective, it is clear that the airline industry is critically important at the national and international levels (Niosi & Zhegu, 2005). For example, the fact that air cargo traffic in the world will change between 0 and 70 million tons between 2004 and 2022 is the most important indicator of this situation. Another significant indicator relates to the Turkish air cargo sector. In fact, the Turkish air cargo industry has grown ten times faster than the world average. In addition, 145 companies operating in the Turkish air cargo sector received 15 new licenses.

The airport with the most license applications is Atatürk Airport (AHL). Esenboğa Airport (Ankara) and Adnan Menderes Airport (İzmir) are also among the airports with the most license applications. Thus, the breadth of Turkey's air cargo network is an indisputable fact. Especially the data from the last ten years are crucial at this point. Information on the above data are shown in Figure 2.

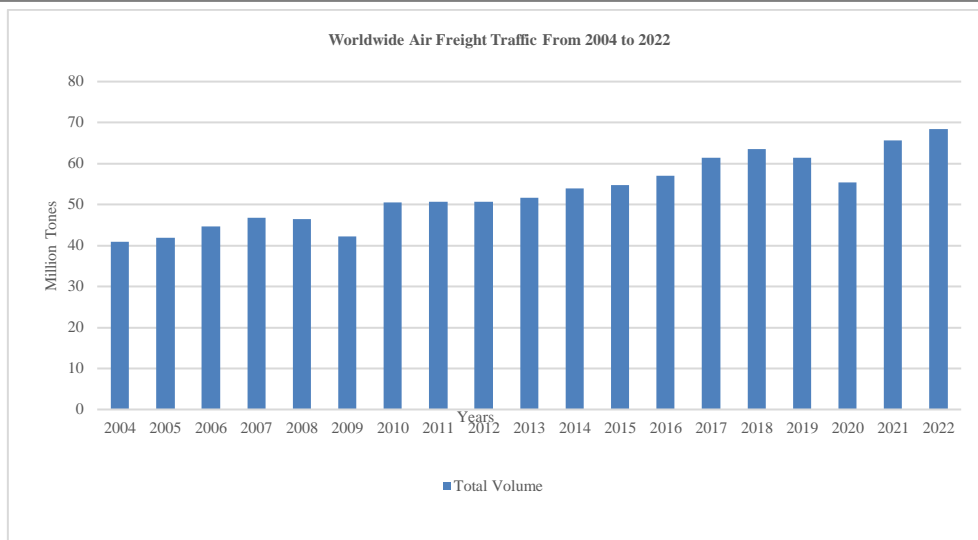


Figure 1. Worldwide freight traffic between 2004 and 2022 (Statista, 2023)

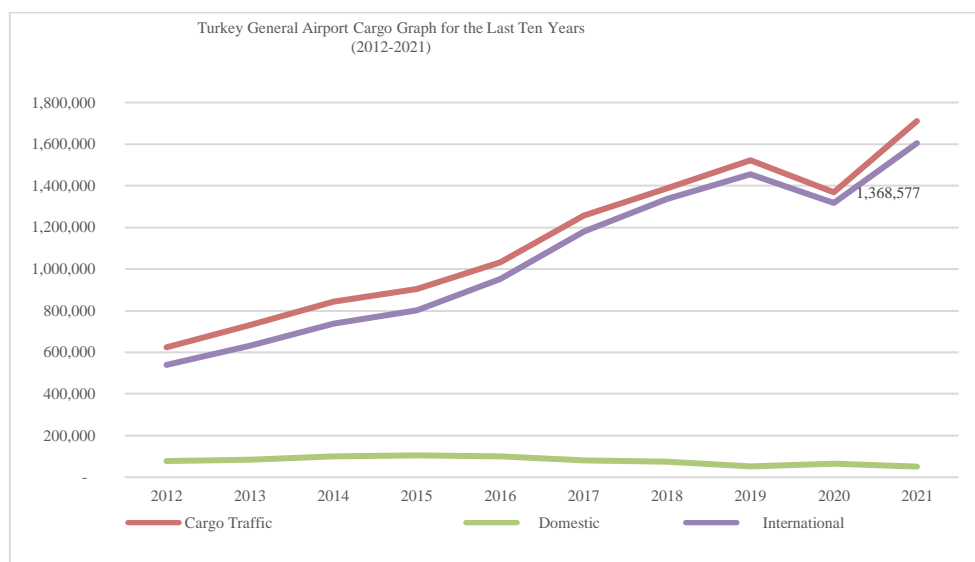


Figure 2. Ten years of air freight transport data in Turkey (DHMI, 2022)

After the publication of the Civil Aviation Law in Turkey, the process of harmonization with the European Union came to the fore and the modernized airports started their operations. Within this process, reciprocal aviation agreements were signed with 159 countries. In the agreements concluded with these countries, the flight points and the number of flights are opened for cargo traffic. According to the 2011 data, 27 of the 346 aircraft are cargo aircraft. This number increased to 489 in 2015, and the number of airports increased to 60 in 2015 (Demirbilek et al., 2018). When cargo traffic data is analyzed, it is known that the total cargo traffic (1,368,577 tons) in 2020 decreased by 10.10% compared to 2019. When analyzing the cargo traffic in 2021 compared to 2020, it is found that there is an increase of 12.40% in cargo traffic (1,711,151 tons). On the other hand, domestic freight traffic, which decreased in 2020 (22.27%), exceeds the 2019 level by 61.90% in 2021. Similarly, international freight traffic, which decreased by 9.56% in 2021, exceeded the 2019 level by 10.17% in 2021.

In analyzing the estimated cargo and freight traffic at Turkish airports for 2022-2024, a total of 4,298,340 tons of cargo, mail and baggage traffic is predicted for domestic and international routes. In addition, 1,805,881 tons of cargo traffic is expected (DHMI, 2022). The most important result of this

statistical data is the increase in the desire of companies that want to receive logistics services from a single source to take an active role in air cargo transportation (UTKIAD, 2023). In this case, it can be seen that the selection of the air carrier by the airlines operating in Turkey is of crucial importance. In order to address this importance, the relevant literature was reviewed and the weighting of the criteria for airline preference and evaluation of the companies in this sector was determined.

When examining the relevant literature, it has been found that there are studies such as Akoğlu & Fidan, 2020; Demirbilek et al., 2018; Niosi & Zhegu, 2005; Öztürk & Onurlubaş, 2019 which include different types of criteria. However, answering the question of which of these criteria is more important will be useful to both the relevant literature and practitioners. According to this purpose, an assessment was made by considering many criteria and companies collectively and 3 different multi criteria decision making methods were used together in this study.

## 2. Theoretical Review

The literature contains numerous studies on the selection of transportation companies in different sectors (Brooks 1990).

She examined the criteria used by shippers in Eastern Canada to evaluate ocean container carriers. Murphy et al., (1997) examined carrier selection using 18 criteria on both the carrier and shipper sides and found that both parties had similar expectations. Ergin,(2011) studied the selection of container carriers in the supply chain using the Fuzzy Analytical Hierarchy Process (AHP) and found that the most important criterion in carrier selection is safety. In their study, Kent & Parker (1999), examined the preferences of shippers, export carriers, and container ship carriers based on 18 criteria and found that damage, loss, and equipment adequacy that can occur in deliveries make significant differences. Wen & Lai (2010) concluded in their study using 8 criteria in air transportation that customers are willing to pay more for high-quality service.

In examining the literature on the criteria that are effective in selecting the carrier that is the subject of the study, similar results to this study were found for the criterion of the adequacy of equipment. A study conducted by Rajkarnikar (2010) emphasized the need for the use of high-quality and up-to-date equipment in handling the loads to be transported, arguing that the safety of the loads to be transported would be compromised if the equipment used to transport the loads was inadequate. Kent & Parker (1999) conducted a survey of transportation companies in their study and found that equipment adequacy is one of the most important criteria for transportation companies.

The relevant literature also contains numerous studies on worker competence. These studies argue that employee competence increases staff productivity and creates a well-functioning organizational climate (Chen et al., 2008). In another similar study, it is emphasized that logistics companies should focus on employee competence and that it is necessary to give importance to staff training in this direction (Punnakitikashem et al., 2013). Another criterion evaluated in this study is network width. Regarding network width, Bottani & Antonio (2006) emphasized that criteria such as service quality and on-time delivery are important for freight forwarders in competition, and argued that the width of the logistics network is also a differentiator.

Regarding the flexibility criterion, the flexibility problem of an airline investing in regional charter flights in Brazil was analyzed using 11 different criteria (Gomes et al., 2014). In another study on the flexibility criterion, Jharkharia & Shankar (2005) divided flexibility into price flexibility and operational flexibility and argued that payment and price flexibility would promote long-term relationships.

When examining the image criterion, one comes across many different studies. When examining the literature on this criterion, it was found that the results of this study are opposite. Example: In a study conducted by Maharani & Wahyuni (2021), a questionnaire was sent to 118 air cargo companies operating in Indonesia. From the results of the survey, the factors that affect customer loyalty are transportation safety, transportation security, and image, respectively. In the study where similar results as in this study were obtained with the criterion of undamaged delivery, the image criterion was mentioned as one of the most important factors, in contrast to our study. Again, in contrast to the results obtained with the image criterion used in our study, another study by Sarıođlan

& Yabacı (2018) argued that consumers who purchase goods or services from mail-order companies consider image during their repurchase behavior and that image reduces the elasticity of demand. In another study by Liou & Chuang (2010), the effect of corporate image and reputation on preference was examined using the Multi-Criteria Decision Making (MCDM) method at an international airport in Taiwan, and it was found that the criterion gave the company an advantage in decision making. Marketing strategies were also considered in these reviews.

Another criterion of this research is timely delivery. Studies conducted according to this criterion are also included in the relevant literature. For example, in a study by Yimga (2017), it was found that an increase in delays in air travel at airports has a negative impact on the probability of choosing a product. The study by Dođić et al., (2018) examined the selection of the appropriate type of aircraft. Suzuki's (1999) study on punctuality concluded that passengers who experience frequent delays are more likely to switch airlines and that undelayed service is important for their market share.

In addition to the studies mentioned above, there are numerous studies on the criteria for handling customer complaints and claims. In the study conducted by Simpson et al., (2002), it was argued that supplier evaluation generally focuses on basic aspects such as price and quality, but that today the importance of communication and customer satisfaction has increased even more. Tan (2002) emphasized the importance of information security and suggested that good suppliers in the aviation industry should be protected and supplier switching should be avoided.

Yaseen et al., (2022) emphasized that service quality affects passenger satisfaction and that there is a positive correlation between passenger satisfaction and service quality. Finally, Suresh (2016) concluded in his study that customer satisfaction is directly proportional to service quality.

Another criterion of this research is cost. In the research conducted by Degraeve et al., (2004), it was found that 19.5% of costs can be saved by evaluating purchasing for companies in terms of airline selection. Seristo (1996), on the other hand, in his survey of 28 managers of 17 European airlines, emphasized that the most important factor in supplier selection is cost. In addition, the relevant literature also includes studies that emphasize that airline pricing policies should be consistent and that stable pricing is important for consumer choice (Taneja, 2017; McIvor et al., 2003).

The literature search on the customer information systems criterion, which is another criterion of the study, found studies that reached similar conclusions to our study. For example, Kannan et al., (2011) identified information systems as the least important criterion in selecting container transportation companies for Indian shippers in their study. Similarly, Kent & Parker (1999) in their study found that cargo tracking is neither very important nor very unimportant and that cargo tracking can be done by employees.

The criterion of carrying special cargo cannot be met by most of the freight forwarding companies operating in this sector due to the lack of equipment, and companies that can meet these conditions are sought by the freight forwarders who want to carry special cargo, especially in the air cargo sector (Şeker & Korkmaz, 2021). Since this situation is only applicable in certain business sectors, it may be last in the list of carrier selection criteria in general. In the doctoral thesis of Ergin (2011), the criterion of special transportation was discussed in different industries and the criterion of special



transportation was in the last place in the order of importance, similar to our work in all industries.

For the criterion of undamaged delivery, there are some studies conducted in the literature under the heading of safety.

Ho et al., (2017) concluded in their study that safety during the transportation is one of the most important criteria that international transportation companies in Taiwan value when selecting a transportation company.

### 3. Materials and Methods

The authors used 3 different methods of multicriteria decision-making (MCDM) in this study. The SWARA method was used to weigh the identified criteria, and the CODAS and Gray Relational Analysis methods were used to evaluate the companies. The following sections describe the respective methods and application steps.

#### 3.1. SWARA (Step-Wise Weight Assessment Ratio Analysis) Method

The SWARA method, introduced to the literature by Keršulienė et al., (2010), is a subjective method based on pairwise comparisons used to weight the criteria among MCDM methods. Among the most important advantages of this method is the fact that the number of pairwise comparisons between criteria is less and there is no need to use a (1-9) scale (Yücenur & İpekçi, 2021). The method starts with the decision maker (DM) ranking the relevant criteria from important to unimportant and then determining the relative importance of the criteria. In this context DM is asked how much criteria  $j$  is more important than criteria  $(j + 1)$  and this value is defined as the comparative priority value ( $s_j$ ). The values in this comparison are assigned between 0 and 1 and in multiples of 5 (e.g., the first criterion is 5% more important than the other criterion). After this stage, the  $k_j$  coefficient values are calculated according to Equation (1). The  $k_j$  value of the criterion that the decision maker considers most important is defined as 1 (Ayçin, 2019).

$$k_j = \begin{cases} 1, & j = 1 \\ s_j + 1, & j > 1 \end{cases}, j = 1, 2, \dots, n \quad (1)$$

After calculating the  $k_j$  coefficients, the  $q_j$  values (corrected weight) are obtained using equation (2) (Bircan, 2020).

$$q_j = \begin{cases} 1, & j = 1 \\ \frac{q_{j-1}}{s_j}, & j > 1 \end{cases}, j = 1, 2, \dots, n \quad (2)$$

In the final stage of the method, the criterion weights ( $w_j$ ) have been calculated using equation (3) (Ayçin, 2019). In the case of more than one DM, the final weighting values can be calculated by taking the geometric means of the weighting values calculated for each criterion separately (Elmas & Özkan, 2021).

$$w_j = \frac{q_j}{\sum_{j=1}^n q_j} \quad (3)$$

#### 3.2. CODAS (Combinative Distance-Based Assessment) Method

CODAS is a method introduced to the literature in 2016 by Ghorabae et al. (2016) based on the assumption that the alternative furthest from the negative ideal is the most appropriate. In this method, the evaluations have been made in the context of Euclidean distance. In addition, the taxicab

distance is also included in the calculations, according to the difference of the Euclidean distance values to a specified parameter ( $\tau$ ) (Aytekin, 2022). In this context, the CODAS method basically evaluates the decision-making units (DMU) in the  $l^2 -$  norm indifference space (Kabak & Çınar, 2020). It is recommended to use a threshold parameter in the range of 0.01-0.05 (Ghorabae et al., 2016). Generally, this value is considered to be 0.02 (Kabak & Çınar, 2020). Depending on the threshold parameter used, a relative evaluation matrix is formed using the threshold function ( $\Psi$ ), which includes Euclidean and Taxicab distance measures, and DMUs are ranked from highest to lowest according to the values obtained (Aytekin, 2022). The method consists of 7 steps. These are;

*Step 1: Create the decision matrix (X):* The initial matrix is created as shown in equation (4).

$$X = [x_{ij}]_{n \times m} \quad (4)$$

*Step 2: Normalization of the decision matrix:* These calculations are performed according to equation (5), depending on whether the relevant criteria are benefit-oriented ( $J^+$ ) or cost-oriented ( $J^-$ ).

$$f_{ij} = \begin{cases} \frac{x_{ij}}{\max_i x_{ij}}, j \in J^+ \\ \frac{\min_i x_{ij}}{x_{ij}}, j \in J^- \end{cases} \quad (5)$$

*Step 3: Weighting the normalized decision matrix:* In this step, the criteria weights ( $w_j$ ) as given in equation (6) are used to calculate the elements ( $r_{ij}$ ) that form the normalized decision matrix. Note that  $w_j$  takes values in the range of 0-1 ( $0 < w_j < 1$ ).

$$r_{ij} = w_j * f_{ij} \quad (6)$$

*Step 4: Calculation of the negative ideal solution values ( $ns_j$ ):* The corresponding calculations are performed using equation (7).

$$ns_j = \min_i x_{ij} \quad (7)$$

*Step 5: Calculation of the distances of the DMUs from the negative ideal solution:* In this step, the Euclidean distance of each DMU is calculated using equation (8) and the Taxicab distance is calculated using equation (9).

$$E_i = \sqrt{\sum_{j=1}^n (r_{ij} - ns_j)^2} \quad (8)$$

$$T_i = \sum_{j=1}^n |r_{ij} - ns_j| \quad (9)$$

*Step 6: Construction of the relative evaluation matrix (G):* Equation (10) and Equation (11) are used.

$$G = [h_{ik}]_{m \times n} \quad (10)$$

$$h_{ik} = (E_i - E_k) + (\Psi(E_i - E_k) * (T_i - T_k)), \quad k \in \{1, \dots, m\} \quad (11)$$

$\Psi$  expressed in equation (11), is determined by equation (12).

$$\Psi(x) = \begin{cases} 1, & |x| \geq \tau \\ 0, & |x| < \tau \end{cases} \quad (12)$$

*Step 7: Calculation of DMU scores ( $H_i$ ):* In this step, the scores of the relevant DMUs are calculated using Equation (13), the relevant values are ranked from the highest to lowest,

and the DMU in the first rank is determined as the most suitable alternative.

$$H_i = \sum_{k=1}^m h_{ik} \tag{13}$$

### 3.3. Gray Relational Analysis (GRA) Method

The GRA method is a ranking and classification procedure based on the *Gray System Theory* that can be applied to both quantitative and linguistic variables. The method defines the degree of influence (gray relationship degree) between factors (Wen, 2004; Yıldırım, 2014; Üstünişik, 2007). It is a method in which a reference set with ideal values for the criteria in the decision matrix is created and the gray relationship degrees of the DMUs with these values are determined (Aytekin, 2022). The method consists of 6 steps. These are;

*Step 1: Create the initial decision matrix (X):* This matrix ( $m \times n$ ), where the number of alternatives (DMU) is  $m$  and the number of criteria is  $n$ , is shown in equation (14).  $x_i(j)$  defines alternative  $i$ 's value according to the criteria  $j$ .

$$X = \begin{bmatrix} x_1(1) & x_1(2) & \dots & x_1(n) \\ x_2(1) & x_2(2) & \dots & x_2(n) \\ \dots & \dots & \dots & \dots \\ x_m(1) & x_m(2) & \dots & x_m(n) \end{bmatrix} \tag{14}$$

$i = 1, 2, \dots, m; j = 1, 2, \dots, n$

*Step 2: Creating the reference set:* The reference set ( $x_0 = (x_0(j))$ ) is created by determining the ideal values for each criterion included in the decision problem. The reference set depends on the decision matrix depending on the structure of the problem (for the benefit-oriented criteria, the relevant criterion is the highest in the matrix; for the cost-oriented criteria, the lowest value in the matrix is taken) or the ideal values can be determined independently of the decision matrix.

*Step 3: Normalization of (X):* Different equations are used depending on whether the relevant criteria are benefit or cost oriented. Equation (15) is used for the benefit-oriented and equation (16) for the cost-oriented criteria. In addition, if the values in the matrix contribute positively to the purpose according to the determined optimal value ( $x_{ob}(j)$ ), equation (17) is used.

$$x_i^* = \frac{x_i(j) - \min_j x_i(j)}{\max_j x_i(j) - \min_j x_i(j)} \tag{15}$$

$$x_i^* = \frac{\max_j x_i(j) - x_i(j)}{\max_j x_i(j) - \min_j x_i(j)} \tag{16}$$

$$x_i^* = \frac{|x_i(j) - x_{ob}(j)|}{\max_j x_i(j) - x_{ob}(j)} \tag{17}$$

The normalized decision matrix ( $X^*$ ) is shown in equation (18).

$$X^* = \begin{bmatrix} x_1^*(1) & x_1^*(2) & \dots & x_1^*(n) \\ x_2^*(1) & x_2^*(2) & \dots & x_2^*(n) \\ \dots & \dots & \dots & \dots \\ x_m^*(1) & x_m^*(2) & \dots & x_m^*(n) \end{bmatrix} \tag{18}$$

*Step 4: Determine the distances ( $\Delta_{oi}$ ) of the DMUs from the reference values:* In this step, the absolute value matrix is created. The absolute value of the difference between  $x_0$  and  $x_i^*$  ( $\Delta_{oi}(j)$ ) is used to create this matrix. The  $\Delta_{oi}$  matrix is formed using the obtained values. These calculations are

performed using equation (19) and the corresponding matrix is formed as in equation (20).

$$\Delta_{oi}(j) = |x_0(j)^* - x_i^*(j)| \quad i = 1, 2, \dots, m; j = 1, 2, \dots, n \tag{19}$$

$$\Delta_{oi} = \begin{bmatrix} \Delta_{o1}(1) & \Delta_{o1}(2) & \dots & \Delta_{o1}(n) \\ \Delta_{o2}(1) & \Delta_{o2}(2) & \dots & \Delta_{o2}(n) \\ \dots & \dots & \dots & \dots \\ \Delta_{om}(1) & \Delta_{om}(2) & \dots & \Delta_{om}(n) \end{bmatrix} \tag{20}$$

*Step 5: Create the gray relational coefficient matrix:*  $\Delta_{max}$  in equation (21) represents the largest change in value in the matrix and is calculated as  $\max_i \max_j \Delta_{oi}(j)$ .  $\Delta_{min}$  represents the smallest change in value in the matrix and  $\min_i \min_j \Delta_{oi}(j)$  is calculated as  $\Delta_{oi}(j)$ ,  $\Delta_i$ , represents the  $j$  value in the difference data series  $\zeta$  is defined as a discriminant coefficient and takes a value in the range of [0,1]. This coefficient normally has the value 0.5.

$$\gamma_{oi}(j) = \frac{\Delta_{min} + \zeta \Delta_{max}}{\Delta_{oi}(j) + \zeta \Delta_{max}} \tag{21}$$

*Step 6: Calculation of gray relationship degrees ( $\Gamma_{oi}$ ):* At this stage, the weight values ( $w_i$ ) of the criteria are important. If the criteria weights are equal, the gray relationship degree ( $\Gamma_{oi}$ ) is calculated according to equation (22), if they are different, according to equation (23). Each alternative is ranked according to these values and the first alternative is evaluated as the most suitable alternative (Demir et al., 2021; Aytekin, 2022).

$$\Gamma_{oi} = \frac{1}{n} \sum_{j=1}^n \gamma_{oi}(j) \quad \text{ve } i = 1, 2, \dots, m \tag{22}$$

$$\Gamma_{oi} = \sum_{j=1}^n [w_i(j) * \gamma_{oi}(j)] \quad \text{ve } i = 1, 2, \dots, m \tag{23}$$

### 3.4. Findings

The aim of this study is to evaluate and analyze the 5 companies (Turkish Cargo, MNG Airlines and Transportation, ACT Air Cargo, ULS Airlines Cargo Transportation and Sunexpress Cargo Transportation) operating in Turkey, which handled the most air cargo in 2021, in line with 12 different criteria determined by the authors as a result of the literature research. These criteria are; Scale of network (C1); Adequacy of Employees (C2); Adequacy of Equipments (C3); Flexibility (C4); Undamaged Delivery (C5); Image (C6); Costs (C7); Customer Information Systems (C8); Approach to Customer Requests and Complaints (C9); Special Cargo Handling Capabilities (C10); Flight Frequency (C11) and On-Time Delivery (C12). To determine the weighting of these criteria, the opinions of 9 experts (DM) who know the air freight sector and have been and are actively involved in the relevant topic were obtained.

It should be noted that there is no limitation on the number of decision makers in MCDM methods (Dehdasht et al., 2017). A scale (1-5) was used in the evaluation of the companies, and the opinions of 8 experts experienced in this field were obtained. The value of 5 on each scale is scaled to represent the maximum usefulness for that criterion. For example, 5 means "very affordable" for the cost criterion and "very adequate" for the adequacy of the equipment. Consistent with this information, the weighting values determined by the SWARA method for each DM and the resulting final criteria weighting values are shown in Table 1 and Table 2, respectively.

**Table 1.** Criteria weights determined on the basis of decision makers according to the SWARA method

Criteria	DM1	DM2	DM3	DM4	DM5	DM6	DM7	DM8	DM9
C1	0.094	0.069	0.092	0.068	0.106	0.071	0.071	0.083	0.078
C2	0.051	0.105	0.060	0.161	0.057	0.075	0.075	0.070	0.095
C3	0.051	0.063	0.066	0.115	0.058	0.072	0.075	0.069	0.094
C4	0.067	0.049	0.050	0.056	0.076	0.068	0.071	0.078	0.090
C5	0.154	0.121	0.114	0.096	0.112	0.112	0.110	0.094	0.111
C6	0.046	0.060	0.055	0.072	0.052	0.061	0.062	0.077	0.061
C7	0.117	0.123	0.112	0.083	0.118	0.102	0.110	0.104	0.100
C8	0.068	0.080	0.080	0.062	0.076	0.087	0.086	0.082	0.070
C9	0.054	0.088	0.076	0.075	0.061	0.100	0.091	0.085	0.071
C10	0.074	0.052	0.097	0.054	0.084	0.067	0.068	0.081	0.055
C11	0.078	0.076	0.088	0.065	0.088	0.083	0.079	0.084	0.064
C12	0.147	0.116	0.111	0.091	0.111	0.101	0.104	0.093	0.110

**Table 2.** Final weight values calculated according to the SWARA method

Criteria	Final w <sub>j</sub>
Undamaged Delivery	0.10845
Costs	0.10578
On-Time Delivery	0.10444
Adequacy of Employees	0.08266
Approach to Customer Requests and Complaints	0.07992
Scale of Network	0.07898
Flight Frequency	0.07778
Customer Information Systems	0.07759
Adequacy of Equipments	0.07463
Special Cargo Handling Capabilities	0.06814
Flexibility	0.06581
Image	0.06182

As shown in Table 1, the most important criteria in selecting air carriers are undamaged delivery, cost and on-time delivery. These three criteria are close to each other and have similarities with the rankings in the literature. The least important criteria in this area are image, flexibility, and special cargo handling capabilities. As a result of the evaluations made by the experts, the average values of the scores obtained by the companies according to the relevant criteria are presented in Table 3. This table also determines the initial matrix (X). The reference value of each criterion was set as 5 in the solution steps for the GRA method. In agreement with the values in

Tables 1 and 2, the DVB scores obtained by CODAS and GRA methods in the steps mentioned in Sections 3.2 and 3.3 are presented in Table 4 and Table 5, respectively. According to Tables 4 and 5, it can be observed that the relevant companies are in the same order for both methods. In this context, Turkish Cargo is selected in the first rank according to both the distance from the ideal reference values and by the furthest distance from the negative ideal. The relevant company was followed by MNG Airlines and Transportation.

**Table 3.** Average score of the companies according to criteria

Weights of Criteria	0.08	0.08	0.07	0.07	0.11	0.06	0.11	0.08	0.08	0.07	0.08	0.10
DMU	C1	C2	C3	C4	C5	C6	C7	C8	C9	C10	C11	C12
Turkish Cargo	4.38	4.63	5.00	2.50	4.25	5.00	2.38	4.00	3.75	4.00	4.63	4.50
MNG Airlines and Transportation	3.00	3.38	3.75	3.00	3.63	3.63	3.00	3.75	2.88	3.38	3.13	3.75
ACT Air Cargo	2.50	2.88	3.25	3.00	3.13	1.88	2.63	2.50	2.50	2.63	2.25	3.38
ULS Airlines Cargo Transportation	2.25	3.00	2.88	2.88	2.75	1.75	2.38	2.75	2.13	2.75	2.00	2.88
Sunexpress Cargo Transportation	2.75	4.00	3.88	2.88	3.25	3.63	3.25	2.88	3.00	2.63	3.38	3.75

**Table 4.** Values and rankings of companies according to the method CODAS

DMU	$E_i$	$T_i$	$H_i$	Ranking
Turkish Cargo	0.11	0.35	1.22	1
MNG Airlines and Transportation	0.06	0.20	0.22	2
ACT Air Cargo	0.02	0.06	-0.70	4
ULS Airlines Cargo Transportation	0.01	0.02	-0.90	5
Sunexpress Cargo Transportation	0.06	0.19	0.16	3

**Table 5.** Gray Relationship Degrees and Rankings of Companies

DMU	C1	C2	C3	C4	C5	C6	C7	C8	C9	C10	C11	C12	$\Gamma_{ot}$	Ranking
Turkish Cargo	0.69	0.74	1.00	0.33	0.60	1.00	0.33	0.56	0.53	0.54	0.80	0.68	0.63	1
MNG Airlines and Transportation	0.41	0.40	0.46	0.38	0.45	0.54	0.40	0.50	0.40	0.42	0.44	0.46	0.43	2
ACT Air Cargo	0.35	0.33	0.38	0.38	0.38	0.34	0.36	0.33	0.37	0.33	0.35	0.40	0.36	4
ULS Airlines Cargo Transportation	0.33	0.35	0.33	0.37	0.33	0.33	0.33	0.36	0.33	0.35	0.33	0.33	0.33	5
Sunexpress Cargo Transportation	0.38	0.52	0.49	0.37	0.39	0.54	0.43	0.37	0.42	0.33	0.48	0.46	0.42	3

#### 4. Conclusion

Air cargo carriers play a key role in the success of logistics business processes. The study of an important sector at this level by researchers has both theoretical and practical significance. In this sense, 5 air cargo companies operating in Turkey in 2021 were studied and 12 different criteria were identified. The mentioned criteria were identified through relevant literature review and accessibility to the experts. These criteria are; scale of network; adequacy of employees; adequacy of equipments; flexibility; undamaged delivery; image; costs; customer information systems; approach to customer requests and complaints; special cargo handling capabilities; flight frequency and on-time delivery.

The opinions of 9 experts who work in the industry and have experience in their field were obtained for criteria weighting process. These expert opinions on carrier selection were analyzed according to SWARA method and it was found that the most important criteria were (1) undamaged delivery, (2) costs and (3) on-time delivery respectively. These results of the study are also confirmed by the relevant literature. Besides the criteria with the least importance are (1) image, (2) flexibility and (3) special cargo handling capabilities. When the results of the research are analyzed at the company base, it is concluded that Turkish Cargo. ranks first and MNG Airlines and Transportation ranks second. Looking at similar studies in the literature (Durak & Yılmaz, 2016), in their study, using the Analytic Hierarchy Process (AHP) method, they evaluated the choice of airline according to the criteria of price, speed, reliability, flexibility and sociability, and the most important criterion in choosing an airline was price and the second most important criterion was speed. have concluded that these results show similar results with our study. In another study, it was found that the most important criterion among the reasons for preferring airlines was price and fare frequency (Yurttas, 2007). In another study, it was concluded that price and punctuality are among the three most important criteria

for choosing an airline that is carried out in more than one period while the potential demand is known (Liao & Rittscher, 2007). All these studies in the literature show that studies on carrier selection provide similar results as the present study.

In this study authors aimed to make an assessment by considering many criteria and companies collectively and 3 different multi criteria decision making methods were used together. Considering the results of this research and relevant literature from a holistic perspective, it can be concluded that air cargo transportation which is one of the important parts of logistic activities acts according to the relevant criteria. Also, strategic planning of air cargo transportation is based on these. For future studies how importance weights of related criteria have been changed according to different countries.

The limitations of this study are as follows; the air cargo industry has a very large volume as a universe. It is not possible, both in terms of time and cost, to reach this entire stage. For this reason, one of the main limitations of the study is the number of samples available in the air cargo sector. Another important problem of this study is that the personnel working in the air cargo sector do not have information about companies other than the companies whose names are known in this sector. For this reason, another limitation of the study is to reach personnel who are familiar with the less known companies in the air cargo sector. Another limitation of the study is that participants were limited to air cargo sector employees, so general conclusions could not be drawn for the entire air cargo sector.

The final limitation of the study was that participants had to have experience in the air cargo industry, which made it difficult to find participants. A few suggestions emerge from the data that emerge from the research findings. First, air cargo companies should consider the criteria mentioned in the study in order of importance and direct the corresponding business activities in this direction. In other words, it would be beneficial for air cargo companies to align their strategic



objectives according to the findings of this research and establish a corresponding action plan. The second point is the contribution to the relevant literature. The studies in the relevant literature show that the criteria in air cargo companies are limited, so it would be beneficial for future research to develop these criteria and conduct more comprehensive studies. In addition, it is important to consider other criteria that have been established in the international literature on air cargo companies and design future research within this framework.

### Ethical approval

The study received ethical approval from the Nisantasi University's Ethics Board (2023/7).

### Conflicts of interest

The authors declare that there is no conflict of interest regarding the publication of this paper.

### References

- Akoğlu, B. & Fidan, Y. (2020). Dünyada Hava Kargo Taşımacılığı ve Türkiye'nin Yeri. *Ekonomi İşletme ve Yönetim Dergisi*, 4(1), 30-51.
- Alshurideh, M., Alsharari, N. M. & Al Kurdi, B. (2019). Supply Chain Integration and Customer Relationship Management in the Airline Logistics. *Theoretical Economics Letters*, 9(02), 392.
- Ayçin, E. (2019). Çok Kriterli Karar Verme: Bilgisayar Uygulamalı Çözümler. Ankara: Nobel Yayınevi.
- Aytekin, A. (2022). Çok Kriterli Karar Analizi. Ankara: Nobel Yayınevi.
- Bailey, D., Goonetilleke, A. & Campbell, D. (2003). A New Fuzzy Multicriteria Evaluation Method for Group Site Selection in GIS. *Journal of Multi-Criteria Decision Analysis*, 12(6), 337-347.
- Ballis, A. (2003). Airport Site Selection Based on Multicriteria Analysis: The Case Study of The Island of Samothraki. *Operational Research*, 3, 261-279.
- Bircan, H. (2020). ÇKKV Problemlerinde Kriter Ağırlıklandırma Yöntemleri. Ankara: Nobel Yayınevi.
- Bottani, E., & Rizzi, A. (2006). A Fuzzy Topsis Methodology to Support Outsourcing of Logistics Services. *Supply Chain Management: An International Journal*, 11(4), 294-308.
- Brooks, R., M. (1990). Ocean Carrier Selection Criteria in a New Environment. *Logistics and Transportation Review*, 26(4), 339-355.
- Chen, C. J., Huang, J. W. & Hsiao, Y. C. (2010). Knowledge Management and Innovativeness: The Role of Organizational Climate and Structure. *International Journal of Manpower*.
- Degraeve, Z., Labro, E. & Roodhooft, F. (2004). Total Cost of Ownership Purchasing of a Service: The Case of Airline Selection at Alcatel Bell. *European Journal of Operational Research*, 156(1), 23-40.
- Dehdasht, G., Mohamad Zin, R., Ferwati, M.S., Mohammed Abdullahi, M., Keyvanfar, A. & McCaffer, R. (2017). "Dematel-Anp Risk Assessment in Oil and Gas Construction Projects", *Sustainability*, 9(8), 1420.
- Demir, G., Özyalçın, A.T. ve Bircan, H. (2021). Çok Kriterli Karar Verme Yöntemleri ve ÇKKV Yazılımı ile Problem Çözüm. Ankara: Nobel Yayınevi.
- Demirbilek, A., Sabri, Ö. Z. & Fidan, Y. (2018). Lojistik Performans Endeksi ve Havayolu Kargo Taşımacılığı İlişkisi: 2007-2016 Türkiye Örneği. *Ekonomi İşletme ve Yönetim Dergisi*, 2(1), 1-24.
- DHMI. (2023, January 24) <https://www.dhmi.gov.tr/Sayfalar/Istatistikler.aspx>
- Doğan, A. (2013). "Hava Kargo Taşımacılığının Türkiye Ekonomisindeki Yeri" Ankara Üniversitesi, Sosyal Bilimler Enstitüsü, İktisat Anabilim Dalı, Doktora Tezi, 2013.
- Dožić, S., Lutovac, T. & Kalić, M. (2018). Fuzzy AHP Approach to Passenger Aircraft Type Selection. *Journal of air transport management*, 68, 165-175.
- Durak, M. Ş., & Yılmaz, A. K. (2016). Airline Selection Criteria at Air Cargo Transportation Industry. *Transport & Logistics*, 16(40), 10-18.
- Elmas, B. ve Özkan, T. (2021). Ulaştırma ve Depolama Sektörü İşletmelerinin Finansal Performanslarının Swara-Ocra Modeli ile Değerlendirilmesi. *İşletme Akademisi Dergisi*, 2(3), 240-253.
- Ergin, A. (2011) Tedarik Zinciri Yönetiminde Konteyner Taşıyıcı Firma Seçimi ve Türkiye'deki Uygulaması. İstanbul Üniversitesi Fen Bilimleri Enstitüsü, Doktora Tezi, 2011.
- Gani, A. (2017). The Logistics Performance Effect in International Trade. *The Asian Journal of Shipping and Logistics*, 33(4), 279-288.
- Ghorabae, M. K., Zavadskas, E. K., Turskis, Z. & Antucheviciene, J. (2016). A New Combinative Distance-Based Assessment (CODAS) Method for Multi-Criteria Decision-making. *Economic Computation and Economic Cybernetics Studies and Research*, 3(50), 25-44.
- Gomes, L. F. A. M., De Mattos Fernandes, J. E. & De Mello, J. C. C. S. (2014). A Fuzzy Stochastic Approach to the Multicriteria Selection of an Aircraft for Regional Chartering. *Journal of Advanced Transportation*, 48(3), 223-237.
- Ho, T. C., Chiu, R. H., Chung, C. C., & Lee, H. S. (2017). Key Influence Factors for Ocean Freight Forwarders Selecting Container Shipping Lines Using the Revised Dematel Approach. *Journal of Marine Science and Technology*, 25(3), 6.
- Jharkharia, S. & Shankar, R. (2007). Selection of Logistics Service Provider: An Analytic Network Process (ANP) Approach. *Omega*, 35(3), 274-289.
- Kabak, M. (Editor), & Çınar, Y. (Editor), (2020). Çok Kriterli Karar Verme Yöntemleri: MS Excel® Çözümlü Uygulamalar. Ankara: Nobel Yayınevi.
- Kannan, V., Bose, S. K., & Kannan, N. G. (2011). An Evaluation of Ocean Container Carrier Selection Criteria: an Indian Shipper's Perspective. *Management Research Review*.
- Kent, J. L., & Stephen Parker, R. (1999). International Containership Carrier Selection Criteria: Shippers/Carriers Differences. *International Journal of Physical Distribution & Logistics Management*, 29(6), 398-408.
- Keršuliene, V., Zavadskas, E.K., & Turskis, Z. (2010). Selection of Rational Dispute Resolution Method by Applying New Step-Wise Weight Assessment Ratio Analysis (SWARA). *Journal of Business Economics and Management*, 11(2), 243-258.

- Klaus, P. (2009). Logistics Research: a 50 Years' March of Ideas. *Logistics Research*, 1(1), 53-65.
- Liao, Z., & Rittscher, J. (2007). Integration of Supplier Selection, Procurement Lot Sizing and Carrier Selection Under Dynamic Demand Conditions. *International Journal of Production Economics*, 107(2), 502-510.
- Liou, J. J. & Chuang, M. L. (2010). Evaluating Corporate Image and Reputation Using Fuzzy MCDM Approach in Airline Market. *Quality & Quantity*, 44, 1079-1091.
- Maharani, T. & Wahyuni, S. (2021). The Effect of Service Quality and Brand Image in the Air Cargo Industry on Customer Satisfaction and Loyalty of PT Garuda Indonesia (Persero). In *International Conference on Business and Engineering Management (ICONBEM 2021)* (pp. 71-83). Atlantis Press.
- McIvor, R., O'Reilly, D. & Ponsonby, S. (2003). The Impact of Internet Technologies on the Airline Industry: Current Strategies and Future Developments. *Strategic Change*, 12(1), 31-47.
- Murphy R., P., Daley M., J. & Hall, P., H. (1997). Carrier Selection: Do Shippers and Carriers Agree or Not? *Logistic and Transportation Review*, 33(1), 67-72.
- Niosi, J. & Zhegu, M. (2005). Aerospace clusters: local or global knowledge spillovers? *Industry & Innovation*, 12(1), 5-29.
- Öztürk, D. & Onurlubaş, E. (2019). Havayolu Taşımacılığında Hizmet Kalitesinin AHP ve TOPSIS Yöntemleri ile Değerlendirilmesi. *Gümüşhane Üniversitesi Sosyal Bilimler Dergisi*, 10, 81-97.
- Punnakitikashem, P., Buavaraporn, N. & Chen, L. (2013). An Investigation of Factors Affecting Lean Implementation success of Thai Logistics Companies. In *24th POMS Annual Conference* (pp. 1-10).
- Rajkarnikar, P. R. (2010). Adequacy and Effectiveness of Logistic Services in Nepal: Implication for Export Performance.
- Sarioğlan, M. & Yabancı, F. (2018). A Study on the Role of Food and Beverage Service Quality in the Preference of Air Transport Companies. *Journal of Tourism and Gastronomy Studies*, 399, 418.
- Şeker, Ö. & Korkmaz, O. Kahramanmaraş İlindeki Dondurma Üreticilerinin Soğuk Zincir Taşıyıcı Seçiminde Kullanmış Oldukları Kriterler ve Bu Kriterlerin Önem Derecelerinin AHP Yöntemi İle Belirlenmesi. *Finans Ekonomi ve Sosyal Araştırmalar Dergisi*, 6(4), 860-877.
- Seristo, H. (1996). The Executive View on the Cost Problem of European Airlines. *European Business Review*, 96(4), 14-17.
- Simpson, P. M., Siguaw, J. A. & White, S. C. (2002). Measuring the Performance of Suppliers: an Analysis of Evaluation Processes. *Journal of Supply Chain Management*, 38(4), 29-41.
- Statista. (2023, January 24) <https://www.statista.com/statistics/564668/worldwide-air-cargo-traffic/>
- Suresh, H. (2016, October). An Unsupervised Fuzzy Clustering Method for Twitter Sentiment Analysis. In *2016 International Conference on Computation System and Information Technology for Sustainable Solutions (CSITSS)* (pp. 80-85). IEEE.
- Suzuki, K. National Aviation and Space Collection about army MO-6 and old photo album; Kokuritsu Kagaku Hakubutsukan shozo no koku uchu shiryō. Moshiki 6 gata to furui shashincho kara. Japan.
- Tan, K. C. (2002). Supply Chain Management: Practices, Concerns, and Performance Issues. *Journal of Supply Chain Management*, 38(4), 42-53.
- Taneja, N. K. (2017). *Simpli-Flying: Optimizing the Airline Business Model*. Routledge.
- Üstünişik, N., Z. (2007). ‘‘Türkiye’deki İller ve Bölgeler Bazında Sosyo Ekonomik Gelişmişlik Sıralaması Araştırması: Gri İlişkisel Analiz Yöntemi ve Uygulaması’’. Gazi Üniversitesi Fen Bilimleri Enstitüsü, Yayınlanmamış Yüksek Lisans Tezi, 2007
- UTKIAD, 2023, January 25) [utikad.org.tr](http://utikad.org.tr)
- Wen, C., H. & Shan, C., L. (2010) Latent Class Models of International Air Carrier Choice. *Transportation Research Part E: Logistics and Transportation Review* 46 (2), 211-221.
- Wen, K.L. (2004). *Grey Systems: Modeling and Prediction*. Yan's Scientific Research Institute, USA.
- Yaseen, A., Yaseen, F., Noor, H., Raza, H., Yousaf, I., Shehzad, H. & Toor, J. (2022). The Impact of Service Quality on Customer Satisfaction in Aviation. *DASC Research Center*, 1(2).
- Yıldırım, F.B. (Editor) & Önder, E. (Editor), (2020). *Operasyonel, Yönetmel ve Stratejik Problemlerin Çözümünde Çok Kriterli Karar Verme Yöntemleri*. Bursa: Dora Yayınları.
- Yimga, J. (2017). Airline On-Time Performance and Its Effects on Consumer Choice Behavior. *Research in Transportation Economics*, 66, 12-25.
- Yücenur, G.N. ve İpekçi, A. (2021). Swara/Waspas Methods for a Marine Current Energy Plant Location Selection Problem. *Renewable Energy*, 63, 1287-1298.
- Yurttaş, B. (2007). *Havayolu Ulaştırmasında Yolcuların Seçim Ölçütleri Üzerine Bir Uygulama* (Doctoral Dissertation, DEÜ Sosyal Bilimleri Enstitüsü).

**Cite this article:** Alnıpak, S., Tunaboğlu, Y.C., Ceyhan, S. (2023). Air Cargo Carrier Selection: The Case of Turkey. *Journal of Aviation*, 7(2), 242-250.



This is an open access article distributed under the terms of the Creative Commons Attribution 4.0 International License

**Copyright © 2023 Journal of Aviation** <https://javsci.com> - <http://dergipark.gov.tr/jav>

# Drone Technology in Transportation Management: A Systematic Review and Framework for Future Research

Muhammed Turgut<sup>1\*</sup> , Bilal Şeker<sup>2</sup> 

<sup>1\*</sup>Tarsus University, Customs Management Department, 33400, Tarsus, Mersin, Türkiye. (muhammedturgut@tarsus.edu.tr)

<sup>2</sup>Ford Otosan A.Ş., Order Planning & Inventory Management Department, Gebze, Kocaeli, Türkiye. (bilalseker41@gmail.com)

## Article Info

Received: 05 April 2023  
Revised: 26 April 2023  
Accepted: 05 May 2023  
Published Online: 09 July 2023

### Keywords:

Drone in Delivery  
Drone in Logistics  
Drone in Transportation  
Drone Technology

Corresponding Author: Muhammed Turgut

## RESEARCH ARTICLE

<https://doi.org/10.30518/jav.1277694>

## Abstract

This study examines the current state of the drone technology literature in detail, both academically and industrially. It describes the advantages and disadvantages of drones in the use of logistics activities, the methods used in the studies and the gaps in the literature. In addition, this study aims to reveal the academic efforts about drone-based transportation systems that will have a say in the future and which areas require effort in the future. In this article, a systematic literature review (SLR) about the use of drones in the transportation industry has been carried out. In total, 56 articles published in Elsevier's Scopus, Thomson Reuter's Web of Science, IEEE Xplore and ScienceDirect (Elsevier) databases were examined in detail. The findings show that the use of drones in transportation activities is an effective method. However, the fact that it is a technology that has just been integrated into business processes reveals that there are aspects that need to be developed. Especially in the last ten years, they found that businesses have benefited from drone technology in their transportation activities that increased their last mile delivery speed, efficiency, accessibility and customer satisfaction.

## 1. Introduction

Logistics has become one of the indispensable elements of modern economies (Patchou et al., 2019). It is possible to perform an effective and efficient operation by adapting the developing technologies to logistics. In the age of technology, the logistics industry continues to grow rapidly. The rapid increase in demand in the e-commerce industry and the desire of consumers to receive their products as soon as possible pushed businesses to seek new delivery methods (Merkert and Bushell, 2020). Increasing logistics demand can only be realized with fast, convenient, modern and automated logistics operations (Lai et al., 2020). Unmanned aerial vehicles (UAVs) are being used more frequently by both the military and the civilian sector as a result of technological advancements and falling costs (Thiels et al., 2015). Unmanned aerial vehicles are employed extensively in the military, although their application in civil activities is still in its infancy (Kuru et al., 2019). Unmanned aerial vehicles, or UAVs, commonly known as "drones," are acknowledged as a prevalent future means of transportation for a variety of applications in the logistics sector (Javadi and Winkenbach, 2021). Drones and unmanned aerial vehicles have shown promise as a supply chain and logistics option (Merkert and Bushell, 2020). Unmanned aerial vehicles (UAVs) called drones are autonomous flying machines (Rabta et al., 2018). The fact that it has a high delivery speed compared to traditional logistics (Thiels et al., 2015) and that there is no

need for a physical infrastructure (Foth, 2017) makes the drone-based logistics system advantageous. Additionally, it supports green logistics and is more eco-friendly than truck delivery. These distinctive characteristics of drone logistics offer benefits for drone logistics distribution. Many businesses such as Amazon, Wal-Mart, Google, UPS, 7-Eleven and Domino have tested and started to operate drones for the delivery of small packages (Lai et al., 2020).

Unmanned aerial vehicles' speed, flight capabilities, and autonomous operations enable businesses to respond quickly and efficiently (Rejeb et al., 2020). Numerous logistics processes are optimized with the help of drones, resulting in advantages in terms of speed and cost in supply chains for operations including warehousing, inventory management, transportation, and route planning (Shavarani et al., 2018). Despite the fact that the specifics of drone-based delivery operations are still being worked out and are subject to future government regulations, they differ significantly from conventional truck-based delivery operations (Chen et al. 2021).

It is expected that drone-based logistics systems, which have started to have an impact on designs and operations, will directly affect operations and planning in the future. Academic study on a variety of features of drone-based logistics systems is being done (Javadi and Winkenbach,

(2023)

2021). In this study, we seek answers to the following research question:

- What are the studies on drone logistics?
- What are the advantages and challenges in drone logistics?
- What theories and techniques have been employed in current research?
- What inferences have been drawn from existing research?
- What are the gaps in the literature on drone logistics?

For this purpose, we make the following contributions in our work. First, we classify the existing literature by conducting an extensive literature review on unmanned aerial vehicles. Secondly, we identify the advantages and disadvantages by reviewing and synthesizing the literature. Third, we identify the methods and theories used in the existing literature to guide those who will study in this field. As a result of the determinations made, we identify gaps in the literature. Considering these contributions, this study reveals the academic efforts about drone-based logistics systems that will have a say in the future and which areas require effort in the future.

## 2. Drone Technology in Transportation Management

Logistics activities, which have been constantly developing and changing from the past to the present, have left behind important milestones (Bonsor, 2018). One of these touchstones is drone transportation, which has emerged with the latest technology. Drones, also known as unmanned aerial vehicles, are already being used by some supply chain firms to do a variety of labor-intensive operations that are time-consuming, expensive, and high-efficiency.

The whole structure of the international air transportation and freight transport industry, especially in private delivery and warehousing, has been significantly impacted by the globalization of the world economy and its accompanying activities (Tumenbatur and Tanyas, 2021). With this, freight forwarder companies meet customer demands for delivery of goods, especially in terms of comprehensive services, delivery management, shipment processing, formalities, cargo picking and consolidation, etc. They significantly expanded the range of services on these issues (Marintseva et al., 2019). Businesses are implementing cutting-edge techniques to increase responsiveness and efficiency in the logistics sector. Drone use in logistics-related transportation tasks is a significant step in this direction (Sah et al., 2021).

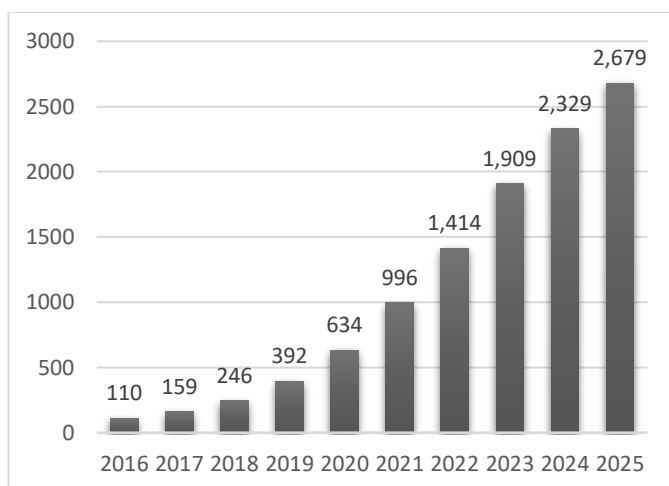


Figure 1. Projected Sales Units (Thousands) for Commercial Drones (Statista, 2019).

Figure 1 clearly shows that Dorne sales have increased significantly over the years. There are many reasons and developments that support this increase. Drone technology emerges as one of the important innovations of distribution operations in commercial activities (He, 2020). It is predicted that drones will be able to replace traditional operation methods in many commercial activities in the next 5 years, both in developing drone technologies and the rapid expansion in the diversity of their fields of activity. It is assumed that these developments will have a positive impact on drone sales. With less human operations and security infrastructure, drones significantly reduce work time and costs. They also contribute to the development of data analytics that enable companies to better understand and predict business performance (Garg, 2021). E-commerce companies have seen considerable growth in the number of daily parcels that need to be delivered in recent years, particularly in the number of exacting client expectations. In this aspect, the distribution method has significantly increased in cost, especially for the final mile. Businesses have started looking for creative autonomous delivery options for the final kilometer in order to stay competitive and keep up with expanding demand, such as autonomous drones/drones, which are a promising alternative for the logistics sector. Drone delivery systems have started to take off as a new way to lower delivery costs and delivery times in response to the success of drones in surveillance and remote sensing. In the upcoming years, it is anticipated that autonomous drone sharing systems would be a necessary logistics solution for the sector (Benarbia and Kyamakya, 2021).

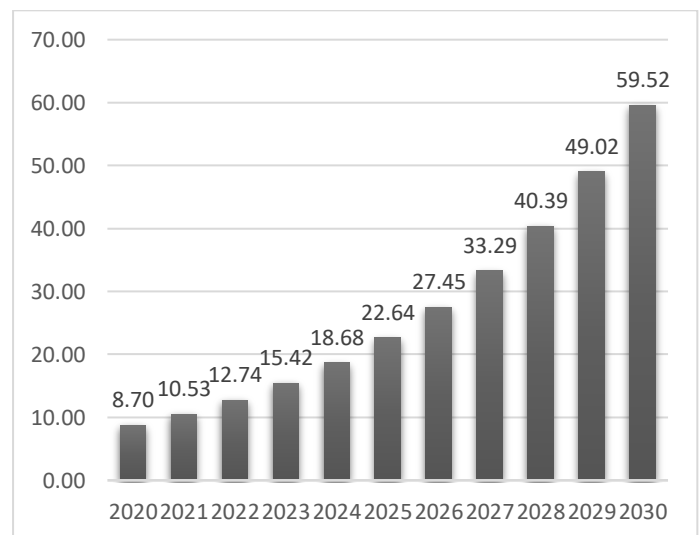


Figure 2. Market size of drone transport by years. (Precedence Research, 2020)

When the report on the market size of drone transport by the research organization Precedence Research, published in 2020, is examined, it is estimated that the industry, which has a market share of 12.7 billion dollars in 2022, will have a market size of close to 60 billion by 2030. Figure 2 clearly shows that the market size will increase rapidly every year and that this mode of transportation will be one of the leading transportation modes in the market in the future. On the other hand, milkrun drone transportations, may be a method of transport that is thought to be popular in the future and this may support to extend market size of Drone. Milk Run; It is a logistics system named after a milkman who delivers the milk



(2023)

loaded in his vehicle to the distribution points and returns to the milk facility by collecting empty milk bottles from the same points on his return. In general terms, it is the supply of products by the manufacturer company from the suppliers at the specified points within the scope of a certain system, and the delivery of the supplied products to the facility of the manufacturer company. When moving to collect products again, it is to take the recycled packages or returns from the manufacturer and deliver them to the suppliers. Members of this cycle will not regulate transport operations but will be involved in the milk-run cycle and process.

One of the problems considered regarding drone transportation is the density of the drone's route point. The fact that the drone prototypes that will carry out the transportation process today are designed for single package delivery has created the need for a separate carrier drone for each shipment. It is predicted that this situation will negatively affect the drone traffic in the sky and the loss of time and energy that will occur on the routes where the drone visits. The most important solution proposal produced in the face of this problem is the idea of adapting the milk-run system to the drone transportation sector. This system, whose positive effects are undeniable in terms of economy, time and energy management; In the future, with the increase in drone carrying capacity and battery life, it is a realistic solution. System; It envisages that several packages to be delivered will be loaded onto the drone at once and distributed. However, there is no such drone or system plan among the transport drone prototypes created today.

### 3. Research Method

The purpose of this study, which aims to comprehend current trends and identify existing gaps in the scientific literature, was to apply a systematic literature review (SLR) as a research approach. In order to make an objective and valid evaluation, it is necessary to systematically examine the basis of a literature (Denyer & Tranfield, 2009; Gligor & Holcomb, 2012). A review is called "systematic" if it is based on clearly formulated questions, identifies relevant studies, evaluates the quality of studies, and summarizes methodology (Khan et al., 2003). Systematic studies use techniques to minimize biases and errors, as they cover published studies in a comprehensive manner. At the same time, they help to save time by providing information about the procedures and results of previous studies for the reviewers (Cook et al., 1997).

First, a preliminary list of keywords was determined. The initial list of search terms was not specified before to the search but instead developed during the course of the significant reading that was done while this study was being written. With this preliminary list, it was determined what other keywords that would reflect our work would be. (Table1) Related publications in the study published between 2016-2022 were found after a detailed online search to organize and synthesize. The titles and abstracts of the selected articles were reviewed. Articles outside the purview of the study were culled from the corpus after a thorough search among the authors. The main reason why 2016 was chosen as the starting year is that the concept of drone logistics is a phenomenon that emerged especially after Industry 4.0 technologies. It has become a concept that has received a lot of attention in the scientific literature since 2016. A literature review of the last six years provides a sufficiently comprehensive analysis of research in this area. As a result, over the past six years, the following significant online databases have been targeted: Elsevier's Scopus, Thomson Reuter's Web of Science, IEEE Xplore, and ScienceDirect (Elsevier). This research shows that the concept of drone logistics was accepted by academics and practitioners during the research and development years. In this study, we review and classify related studies to get an idea about drone logistics. After the necessary eliminations were made in the literature, 56 articles on drone logistics were taken into consideration. After examining each article, the articles were examined by classifying them according to topics and methodological approaches. This review's two major goals are to identify, classify, and summarize the present literature on drone use in logistics management as well as to pinpoint potential areas and avenues for further study.

#### Research Questions

The research questions we address in this study are:

RQ1: What studies have been done on drone logistics?

RQ2: What are the advantages and challenges in drone logistics?

RQ3: What theories and methods have been used in existing research?

RQ4: What conclusions have been drawn from existing research?

RQ5: What are the gaps in the literature on drone logistics?



Figure 3. Methodology Flow Chart

### 4. Studies on Drone Logistics

Within the scope of the study, Elsevier's Scopus, Thomson Reuter's Web of Science, IEEE Xplore, and ScienceDirect (Elsevier) were scanned and 56 studies were found and examined. The scope and contributions of these studies are

given in the table below. Literature subject abbreviations are described as follows.

AI: Artificial Intelligence

UAVSC: Unmanned Aerial Vehicle Supply Chain

DSC: Drone Supply Chain Journal of Aviation.

**Table 1.** Literature Studies

References	Subject	Objective	Method	Contribution
Hua and Zhang	AI	In this study, a design for using drone technology combined with artificial intelligence in short-range deployments is proposed.	Modelling	With this study, artificial intelligence technology and drone technology are discussed from a macro perspective. It will help to increase the efficiency and lighten the human burden in short-distance transportation.
Fang & Hai	DSC	In this study, a model has been developed considering the constraints such as demand model, performance constraints, airspace constraints, load and durability of unmanned aerial vehicles.	Modelling	It contributes to the calculation of transportation costs in the use of UAVs in transportation.
Meincke and Geike	UAVSC	In this study, the use and potential of UAVs in cargo ground services are theoretically examined and simulated.	Simulation	A study that examines the importance of UAVs in air cargo supply chain processes and contributes to their use.
Varigonda et al.,	UAVSC	A multi-configuration unmanned aerial vehicle was created in this project to carry medical supplies.	Simulation	For the application of unmanned aerial vehicles in the medical field, a simulation was created.
Cvitanic	DSC	This study provides an overview of drone technology in transportation engineering problems with current drone transportation applications.	Literature Review	The use of drone technology in transportation activities has been examined, and its costs and benefits have been revealed.
Canetta et al.,	UAVSC	In this study, businesses providing services to the UAV industry in Switzerland were analyzed by MCDM method.	Modelling	The role of decision support systems in the use of UAVs has been examined.
Lai et al.,	DSC	In terms of national rules, technical safety, technical equipment, efficiency, risk prevention, and audience preference limits, this study assessed the demand from clients for drone logistics services.	Modelling	The Functional Distribution of Drone Logistics has been studied.
Troudi et al.,	DSC	This study addresses a problematic drone delivery package in an urban location.	Modelling	For the drone delivery fleet, a post-production analysis approach has been created.
Liu et al.,	DSC	This study focuses on truck and drone dual routing problem solving.	Modelling	Modeling is done for drone vehicle routing in low demand situations.
Olivares et al.,	DSC	This study proposes the use of a fleet of drones within a plastics manufacturing plant.	Modelling	A drone use model was developed during the transportation phase.
Das et al.,	UAVSC	This study proposes a new model that synchronizes drones and delivery trucks.	Modelling	A model has been developed that minimizes costs and maximizes customer service level.
Triche et al.,	UAVSC	This study investigated the usage of unmanned aerial vehicles in Malawi's healthcare operations.	Case Study	It highlights the effects of UAV use in the healthcare industry.
Iranmanesh et al.,	DSC	It suggests a path optimization algorithm for a data-carrying and -transmitting drone communication network.	Modelling	It has developed a new approach to smart transportation system and data communication.
Nyaaba and Ayamga	DSC	A systematic literature review of drone use in healthcare was conducted.	Literature Review	The study revealed the importance of drone use in medical interventions on the African continent.
Koshta et al.,	DSC	This study outlined the obstacles to the widespread use of delivery drones.	Modelling	It gives decision-makers and regulators a thorough insight to help open the door for the use of delivery drones.
Smith et al.,	DSC	In this study, the main problems in front of the public's use of drones were examined.	Survey	In this study, the perspective of societies on drone logistics has been evaluated and suggestions have been made in this regard.

Gonzalez-R et al.,	DSC	In this study, a network design was made using the mathematical model to expand the operating range of the drones. Suggestions were made for the installation of charging stations at suitable points in order not to interrupt the journeys of the drones and to meet their charging needs.	Modelling	A method has been developed to model the optimum installation points of charging stations.
Zhu et al.,	DSC	In the research, it is discussed that after an unexpected disaster, unmanned aerial vehicles (UAVs) deliver the necessary materials for first aid to the need demand points for humanitarian aid application.	Modelling	Ensuring the fastest distribution of medical supplies required for post-disaster first aid applications by using the assignment problem
Raj et al.,	DSC	This study seeks to identify these crucial success variables and the connections between them.	Modelling	Crucial success variables for drone use in logistics have been established
Mualla et al.,	DSC	In this study, the most used methodologies were revealed by using the ISO software quality model.	Modelling	Comparison of agent-based simulation methods in unmanned aerial vehicles
Ghelichi et al.,	DSC	The logistics routes of a drone fleet are optimized in this study to ensure the prompt delivery of medical supplies.	Modelling	Developing an optimum model by simulating the transportation of medical equipment to rural areas
Javadi et al.,	DSC	This article compares the delivery models using trucks and drones. A mathematical model has been developed to provide a synchronized timing and routing with the truck in the return of the drones sent for package delivery from the trucks.	Modelling	Truck and Drone Routing Algorithm (TDRA) is explained through two realistic case studies with created examples.
Chen et al.,	DSC	In this study, the policies to be implemented on how retailers should make the decisions they will encounter in drone-based delivery operations, when the drone delivery will be offered, which delivery capacity will be maintained and how much will be charged for these deliveries are emphasized.	Modelling	In order to find close to ideal closed form solutions, the paper develops a Markov decision process (MDP) framework and presents two heuristic methods.
Leon-Blanco et al.,	DSC	In the study, a model proposal that will support a minimum time loss by synchronizing a truck and more than one drone is emphasized.	Modelling	Synchronizing multiple drone movements with the truck is discussed.
Merkert et al.,	DSC	This study measured consumers' perceptions of drone delivery compared to traditional mail delivery.	Survey	It revealed the consumer view towards drone deliveries.
Mahroof et al.,	DSC	This study focuses on how to incorporate innovative solutions into agricultural supply chains, especially environmentally, economically, ethically and socially appropriate modes of transport.	Modelling	An efficiency-enhancing study on the use of drone transportation in the agricultural sector
Osakwe et al.,	DSC	A social and cognitive study on whether the utilize of drones in delivery processes will be accepted for end users in the coming years.	Literature Review	Consumer trends were examined in terms of drone use in shopping.
Merkert et al.,	DSC	In the study, which deals with the rapid spread of drone use and the negative effects of the uncontrolled growth of drone fleets, the importance of regulatory policies on this issue is highlighted.	Literature Review	Addressing threats and opportunities to enable the controlled proliferation of drone use in the future.
Chen et al.,	DSC	A study on establishing a relationship between base stations and drones	Literature Review	Integrating 5G and beyond technologies into drones by making use of base stations
Troudi et al.,	DSC	A VRP system is modeled to size and manage the drone fleet in logistics operations.	Modelling	Logistic Support Approach for Drone Delivery Fleet
Pan et al.,	DSC	In this study, a mixed uniform sampling approach called the Improved Compact Cuckoo Search Algorithm is used.	Modelling	Application of the Improved Compact Cuckoo Search Algorithm to Locate the Drone Logistics Center
Johannessen et al.,	DSC	In order to optimize the weight restrictions of flying and delivered loads in drones, several research based on tandem models and the traveling salesman problem are described in the study.	Modelling	A model is presented for drone transport of 6.5 million annual full analytical volume.
Erceg et al.,	DSC	Different examples of the worldwide use of drones in logistics are presented in the study. The problems are analyzed by giving examples of the legal regulation in Croatia.	Literature Review	Worldwide Legislation of Unmanned Aerial Vehicle Systems in Logistics and Examples of Their Use in Croatia

### 5. Advantages and Disadvantages of Drone Use

Compared to conventional delivery techniques, drone delivery has many benefits. It has many benefits, especially for last-mile deliveries where businesses must satisfy customer demand for quicker and less expensive delivery. Particularly in rural and distant places where delivery is challenging, drones offer a practical means to distribute goods. Like any technology, drone technology has many benefits. The literature studies of the advantages described in short articles below are shown in Table 2.

- It saves on distribution costs.
- It paves the way for faster deliveries.
- It provides the opportunity to reach hard-to-reach areas.
- They lessen CO2 emissions and city traffic.
- It aids in maintaining inventory and warehouse movement under control.
- No shifts are necessary because the drone can work around-the-clock, every day of the year.

**Table 2.** Advantages of Using Drones in Logistics

Advantages	References
Drones use advanced navigation systems to determine routes in logistics operations. Authentication and advanced facial recognition systems for target delivery can also be integrated in their technologies. Its smart system determines the fastest and optimum route for delivery and also checks the degree of security of the delivery with weather controls. For these reasons, it is less costly than traditional logistics operations.	(Hau & Zhang, 2019)
It can be commissioned to carry out vital deliveries no matter what the terrain conditions.	(Varigonda & Others, 2021)
Drone use in transportation can improve delivery efficacy and efficiency while lowering fuel and labor costs. Additionally, it may result in a discernible decrease in greenhouse gas emissions.	(Pinto and Lagorio, 2022)
Drones have environmental benefits such as less air and noise pollution. Also, in Logistics, buying a fleet of drones is much cheaper than buying a fleet of traditional trucks.	(Raj and Sah, 2019)
Drones have benefits including moving faster in the air than on ground and getting around traffic in busy places.	(Mualla et al., 2021)
The most important benefits of drones are that they do not get stuck on road network boundaries, do not need pilots, are low cost and do not need a high level of infrastructure compared to traditional transportation vehicles.	Ghelichi and Others (2021)
Drones provide fast delivery for small/light packages. On the other hand, drone applications have provided a range of solutions, particularly for the rural distribution of medical supplies and emergency packages, where there is frequently underdeveloped road infrastructure in rural areas and limited availability of resources for infrastructure improvements.	(Javadi et al., 2021)
The use of drones in agriculture can create social benefits due to pesticide application and the support of waste with real-time data.	(Mahroof et al., 2021)
Drone deliveries offer the advantage of faster delivery and reduced complexity, as well as reduced privacy risks.	(Osakwe et al., 2022)
In the construction industry, drones are used for city and construction planning. This is less costly than using a conventional aircraft.	(Merkert and Bushell, 2020)
Drones can fly great distances, delivering life-saving medical supplies to people in hard-to-reach communities. This technology can be used to deliver goods to villages where visits by health workers are not regular and are less frequented for delivery. Another important advantage of drones is their energy consumption. Small UAVs powered by batteries consume much less energy than other means of transport.	(Garg, 2021)
As they are not affected by external factors such as traffic jams, drones also offer the flexibility needed to deliver where and when customers want.	(Yoo et al., 2018).
By using drone sharing networks for end-user delivery, emissions and the consumption of fossil fuels are reduced.	(Benarbia ve Kyamakya, 2021)
In B2C activities, drone technology has shortened delivery times compared to traditional methods and increased efficiency by reducing unsuccessful delivery rates.	(Mangiaracina et al., 2019)

In Table 2, many scientific studies expressing the added value created by the use of drones are shared. When the studies are examined, it can be said that the most important advantage of drones is that there is no need for pilots, they are less costly, they offer fast transportation, effective and efficient operations, and less infrastructure needs compared to traditional transportation vehicles. Additionally, one of the key

benefits of drone technology is its support to the usage of low-carbon fuels and emissions reduction. Drone delivery systems face challenges in terms of development and success, just like many other sectors that are implementing new technologies. These obstacles include logistical, technological, and security concerns as well as legal ones. The information on the disadvantages of using drones is shown in Table 3 below.

**Table 3.** Disadvantages of Using Drones in Logistics



Disadvantages	References
Since it is a new technology, service network, return load planning, the absence of waiting stations during the new load plan appear as important questions at present.	(Hau & Zhang, 2019)
The limited flight distance and capacities are among the most important obstacles in drone transportation.	(Dorling et al., 2016)
Climate conditions, especially stormy weather conditions, can prevent drones from working.	(Varigonda et al., 2021)
Drones have high energy consumption and limited energy capacity.	(Mualla et al., 2021)
Drones typically cannot carry large and irregularly sized packages	(Javadi et al., 2021)
Lack of a safe place to drop packages at delivery points.	(Merkert et al., 2022)

In Table 3, the disadvantages in scientific studies with drone logistics are given. Despite tremendous attempts to advance drone delivery technology, there are still significant obstacles to drone delivery. These obstacles include the payload of drones, restricted flight range, bureaucratic procedures, and legal restrictions. Other important disadvantages are that the return load planning, service network and waiting station infrastructure have not been matured yet.

### 6. Theories and Methods Used in Current Studies

In this part of the study, the theories and methods used in the literature on the use of drones in logistics are discussed in detail. A total of 56 studies were reviewed from Elsevier's Scopus, Thomson Reuter's Web of Science, IEEE Xplore, and ScienceDirect (Elsevier) at the beginning of the study. In the continuation of the study, 33 articles were used among these articles that were thought to contribute to the study. Considered in the examinations, (Hua and Zhang, 2019) optimized the logistics processes by using artificial intelligence technology and drone technology in their study. In their study, (Fang and Hai, 2020) calculated the demand and costs in the last mile distribution using the Dynamic Allocation Algorithm method. (Meincke and Geike, 2018) analyzed the use of unmanned cargo planes in air cargo processes through simulation. According to (Varigonda et al., 2021) simulated the design, emulation, manufacturing and finally testing of UAVs that can land and take off without the need for a runway. In the study of (Canetta et al., 2017), they performed their analysis using the AHP technique, which is one of the multi-criteria decision-making methods. (Lai et al., 2020) analyzed customer demands using the KANO model. (Liu and Other, 2018) developed a drone truck routing model in their study. (Olivares et al., 2017) tried to solve the problem of routing the drone fleet using various heuristics and simulation. (Das et al., 2020) used Collaborative Pareto Ant Colony Optimization algorithm and Non-dominated Sorting Genetic Algorithm II (NSGA-II) methods in their study. (Triche et al., 2020) conducted a case study in their study. (Iranmanesh et al., 2019) used the Weighted Flight Path Planning algorithm in their study. (Nyaaba and Ayamga, 2021) examined the use of drones in medical activities in Africa using a systematic literature review. (Koshta et al., 2022) tried to identify obstacles by using the Gray Decision-Making Trial and Evaluation Laboratory technique in their study. (Smith et al., 2022) tried to determine the public's perception of drones and obstacles by using the survey method. In their study, (Gonzalez-R et al., 2020) used simulated annealing (SA) algorithm with an intuitive approach. (Pinto et al., 2022) utilizes a mathematical model and a heuristic technique to solve a network design issue that combines two infrastructure investment goals. (Zhu et al., 2020) analyzed the structure of

risk belief systems using the network analysis method. (Raj and Sah, 2019) used the DEMATEL method, which is a multi-criteria decision-making technique combined with a gray-based approach. (Ghelichi et al., 2022) presented an optimization-based approach for the prompt distribution of assistance supplies to disaster-affected regions by A Chance Constrained Programming and Sample Average Approximation methods. (Javadi et al., 2021) presented a mathematical model and heuristic approach using Mixed-Integer Linear Programming and Truck and Drone Routing Algorithm. (Merkert et al., 2022) measured consumers' perceptions of drone delivery using the survey method. (Chen et al., 2021) developed a Markov decision process (MDP) and presented a near-optimal decision-making process with two heuristic solution approaches. (Leon-Blanco et al., 2022) developed a new agent-based system using the Truck-multi-Drone Team Logistics Problem (TmDTL) method in their study. (Mahroof et al., 2021) modeled and analyzed it using Interpretive structural modeling (ISM) methodology to help uncover 12 agricultural challenges that hinder its movement within the supply chain. In the study of (Troudi et al., 2017), it was seen that a VRP system was modeled to size and manage the drone fleet in logistics operations. In the study by (Pan et al., 2020), in order to find a drone logistics hub, the Improved Compact Cuckoo Search Algorithm using mixed uniform sampling technology was used. In the study of (Johannessen et al., 2021), dual models and multiple studies based on the traveling salesman problem were discussed in order to optimize the weight limits of flight and transported loads in drones, and a model for the transport of 6.5 million annual full analytical volume by drone was presented.

### 7. Limitations of the Study

The technical specifications of the drones are excluded from the scope of the research. Ownership of drones is beyond the scope of the research. The purposes of use of drones, whether there are legal regulations of the states or not are excluded from the purpose of the study.

### 8. Findings at the end of the Study

In the future, drones are expected to be a widespread form of transportation for a variety of logistics-related uses. The constant and high travel speed of drones compared to conventional vehicles, the fact that they do not need physical road infrastructure, the direct travel and the fact that they are not exposed to traffic make this transportation stand out. It has been noted that logistics businesses can speed up deliveries and make their systems more responsive by using drone transportation (Jawadi and Winkenbach, 2021).

Drone transportation makes positive contributions to the prevention of increasing urban traffic, solving the problems

caused by rapid growth in e-commerce, and congested business processes, especially in metropolitan cities. It has been observed that it has been employed by well-known businesses like Walmart, Amazon, and even some pizza delivery services, significantly enhancing the speed and effectiveness of deliveries. It is predicted that drone transportation, which is currently used in restricted areas, will be used more frequently in the future with high-capacity vehicles equipped with precise controls, GPS mapping and flight planning, geofencing, and bigger carrying capacities (Sarder, 2020).

On the other hand, drone applications have provided a number of solutions, especially for the rural distribution of medical supplies and emergency packages, where there is frequently underdeveloped road infrastructure in rural areas and limited availability of resources for infrastructure improvements (Jawadi and Winkenbach, 2021).

In addition, it is predicted that this most important technology will be preferred more in the coming period, as drones do not get stuck in road network boundaries, do not need pilots, are low cost and do not need a high level of infrastructure compared to traditional transportation vehicles (Ghelichi and Others, 2021). While the share of drone technology in transportation activities is currently around 12 billion dollars, it is expected to reach 60 billion dollars by 2030 (Precedence Research, 2020). These figures clearly show that drone transport will grow very rapidly in the sectoral market and increase its share. For this reason, it is recommended that businesses and public institutions that have not yet started to use this technology in their transportation activities should immediately implement business development applications that will integrate this technology into their business processes.

One of the important elements of drone technology is the rapid delivery of deliveries. Drones deliver packages by flying above these barriers, which are crucial for transportation because they are unaffected by poor road conditions or traffic congestion. Drones can deliver packages from origin to destination on the most convenient route and delivery time can be accurately estimated. Thus, drones not only provide incredibly quick delivery services but also the necessary freedom to deliver where and when customers desire (Yoo et al., 2018).

Additionally, the transportation industry is crucial in the spread of greenhouse gases, which have a variety of negative effects on the environment, including air, water, and global warming. According to this viewpoint, using drone sharing systems for end-user delivery can help reduce emissions and the need for fossil fuel energy sources. Drone-based delivery systems have the potential to replace a sizeable chunk of the current systems that rely on cars and motorcycles for short distances because they are predicted to have a substantially smaller carbon footprint. Additionally, drone-based delivery will significantly contribute to lowering accident rates and traffic jams, particularly in areas where the road network is already overused (Benarbia and Kyamakya, 2021). Despite substantial attempts to advance drone delivery technology, constraints inherent in organizing drone deliveries, such as constrained flying range, cumbersome administrative procedures, legal snags, and drone payloads, are among the main factors delaying drone delivery's advancement (Dorling et al., 2016).

## 9. What are the Gaps in The Literature on Drone Logistics

With the use of drones, some positive results have been achieved, such as reduced costs in transportation operations, shortened processes and reduced delivery errors. However, the fact that the use of this technology in logistics and transportation activities is still very new brings many shortcomings. It has been observed that there are some important gaps such as the fact that the states have not yet put into effect the legal regulations on this issue and that they cannot be used in large-scale transportation operations. In addition to these gaps, there are some important problems such as the lack of waiting stations for drones, the inability to plan for the return load, limited energy times, and the inability to deliver in safe areas. When civil applications of drone technology are investigated, its use in end product delivery, routing and optimization, medical equipment transportation and agricultural activities comes to the fore. In the research, no studies were found in the direction of using these technologies in capacity increase studies and in the field of passenger transportation. As a result of the study, it was found that there is a void in the literature regarding how to increase these technologies' carrying capacity, carry out long-distance transportation, leave the deliveries in safe areas, and use them for passenger transportation.

## 10. Conclusion and Recommendation

In this study, 56 articles from Elsevier's Scopus, Thomson Reuter's Web of Science, IEEE Xplore, and ScienceDirect (Elsevier) were examined. The pandemic epidemic that we have been experiencing recently revealed the necessity of an automation system that is free of human factor from business processes. In particular, the interruption of supply chains and the limited access of societies to vital factors such as food, cleaning and health materials have made us think of the existence of an unmanned process management in logistics and transportation operations. It is aimed that this study, which we have done at this point, will be a guide for researchers and industry professionals. During the study, many international sources were examined, and it was determined which models were used in these studies. The advantages and disadvantages of this new technology for businesses were also discussed. As a result of all these researches, it is seen that especially in the last ten years, businesses have benefited from drone technology in their transportation activities. As a result of this experience, when businesses analyzed their business processes, they found that they increased their final delivery speed, efficiency, accessibility and customer satisfaction.

Researchers and practitioners alike can learn from this study. Considering the details of the study, it is seen that drone waiting and charging stations are now considered as an important problem. In addition, the most important problems of drone transportation are the inability to plan the return load in drone deliveries, the need to improve the speed and capacity of drone transport, the need for a safe area in delivery, and the development of drones with the ability to carry in adverse climatic conditions. In the examination, it is clearly seen that there are gaps in these areas in academic studies. In addition, it has been determined that there is a gap in the use of these technologies in the field of passenger transportation. All these factors can be included in future studies as research questions, and it is recommended that these technologies be discussed in detail, especially in the legal, administrative and social dimensions.

## Ethical approval

Not applicable.

### Conflicts of Interest

The authors declare that there is no conflict of interest regarding the publication of this paper.

### References

- Benarbia, T., & Kyamakya, K. (2021). A literature review of drone-based package delivery logistics systems and their implementation feasibility. *Sustainability*, 14(1), 360.
- Bonsor, K. (2018). How Maglev trains work. Retrieved from, <https://science.howstuffworks.com/transport/engines-equipment/maglev-train.html>.
- Canetta, L., Mattei, G., & Guanzioli, A. (2017, June). Multi criteria analysis applied on value chain definition in unmanned aerial vehicle (UAV) sector. In 2017 International Conference on Engineering, Technology and Innovation (ICE/ITMC) (pp. 1096-1103). IEEE.
- Chen, H., Hu, Z., & Solak, S. (2021). Improved delivery policies for future drone-based delivery systems. *European Journal of Operational Research*, 294(3), 1181-1201.
- Chen, J., Wang, W., Zhou, Y., Ahmed, S. H., & Wei, W. (2021). Exploiting 5G and blockchain for medical applications of drones. *IEEE Network*, 35(1), 30-36.
- Chen, X., Ulmer, M. W., & Thomas, B. W. (2019). Deep Q-learning for same-day delivery with a heterogeneous fleet of vehicles and drones. arXiv preprint arXiv:1910.11901.
- Cook, D.J., Greengold, N.L., Ellrodt, A.G., & Weingarten, S.R. (1997), "The relation between systematic reviews and practice guidelines", *Annals of Internal Medicine*, Vol. 127 No. 3, pp. 210-6
- Cvitanić, D. (2020). Drone applications in transportation. In 2020 5th International Conference on Smart and Sustainable Technologies (SpliTech) (pp. 1-4). IEEE.
- Das, D. N., Sewani, R., Wang, J., & Tiwari, M. K. (2020). Synchronized truck and drone routing in package delivery logistics. *IEEE Transactions on Intelligent Transportation Systems*, 22(9), 5772-5782.
- Denyer, D., & Tranfield, D. (2009), "Producing a systematic review", in Buchanan, D. and Bryman, A. (Eds), *The Sage Handbook of Organizational Research Methods*, Sage Publications, London, pp. 671-89, Ch. 39.
- Dorling, K., Heinrichs, J., Messier, G. G. & Magierowski, S. (2016). Vehicle routing problems for drone delivery. *IEEE Transactions on Systems, Man, and Cybernetics: Systems*, 47(1), 70-85.
- Erceg, A., Erceg, B. Č., & Vasilj, A. (2017). Unmanned aircraft systems in logistics—legal regulation and worldwide examples toward use in Croatia. *Business Logistics in Modern Management*.
- Fang, Z., & Hong-Hai, Z. (2020, September). A Method for "Last mile" Distribution Demand for Drones. In 2020 IEEE 5th International Conference on Intelligent Transportation Engineering (ICITE) (pp. 561-564). IEEE.
- Foth, J. (2017). We haven't considered the true cost of drone delivery medical services in Africa. URL <https://qz.com/africa/1090693/zipline-drones-in-africa-like-rwanda-and-tanzania-have-an-opportunity-cost/>.
- Garg, P. K. (2021). Unmanned aerial vehicles: An introduction. *Mercury Learning and Information*.
- Ghelichi, Z., Gentili, M., & Mirchandani, P. B. (2022). Drone logistics for uncertain demand of disaster-impacted populations. *Transportation research part C: emerging technologies*, 141, 103735.
- Gligor, D. M., & Holcomb, M. C. (2012). Understanding the role of logistics capabilities in achieving supply chain agility: a systematic literature review. *Supply Chain Management: An International Journal*.
- Gonzalez-R, P. L., Canca, D., Andrade-Pineda, J. L., Calle, M., & Leon-Blanco, J. M. (2020). Truck-drone team logistics: A heuristic approach to multi-drop route planning. *Transportation Research Part C: Emerging Technologies*, 114, 657-680.
- He, Z. (2020). The challenges in sustainability of urban freight network design and distribution innovations: a systematic literature review. *International Journal of Physical Distribution & Logistics Management*, 50(6), 601-640.
- Hua, H. Y., & Zhang, Z. (2019). Application of artificial intelligence technology in short-range logistics drones. In 2019 8th International Symposium on Next Generation Electronics (ISNE) (pp. 1-4). IEEE.
- Iranmanesh, S., Raad, R., Raheel, M. S., Tubbal, F., & Jan, T. (2019). Novel DTN mobility-driven routing in autonomous drone logistics networks. *IEEE access*, 8, 13661-13673.
- Johannessen, K. A., Comtet, H., & Fosse, E. (2021). A Drone Logistic Model for Transporting the Complete Analytic Volume of a Large-Scale University Laboratory. *International Journal of Environmental Research and Public Health*, 18(9), 4580.
- Khan, K.S., Kunz, R., Kleijnen, J. & Antes, G. (2003), "Five steps to conducting a systematic review", *Journal of the Royal Society of Medicine*, Vol. 96 No. 3, pp. 118-121.
- Koshta, N., Devi, Y., & Chauhan, C. (2022). Evaluating Barriers to the Adoption of Delivery Drones in Rural Healthcare Supply Chains: Preparing the Healthcare System for the Future. *IEEE Transactions on Engineering Management*.
- Kuru, K., Ansell, D., Khan, W., & Yetgin, H. (2019). Analysis and optimization of unmanned aerial vehicle swarms in logistics: An intelligent delivery platform. *Ieee Access*, 7, 15804-15831.
- Lai, M. C., Liu, D., & Tsay, W. D. (2020). Functional deployment of drone logistics. In 2020 IEEE 2nd Eurasia Conference on Biomedical Engineering, Healthcare and Sustainability (ECBIOS) (pp. 1-4). IEEE.
- Leon-Blanco, J. M., Gonzalez-R, P. L., Andrade-Pineda, J. L., Canca, D., & Calle, M. (2022). A multi-agent approach to the truck multi-drone routing problem. *Expert Systems with Applications*, 195, 116604.
- Liu, J., Guan, Z., & Xie, X. (2018). Truck and drone in tandem route scheduling under sparse demand distribution. In 2018 8th International Conference on Logistics, Informatics and Service Sciences (LISS) (pp. 1-6). IEEE.
- Mahroof, K., Omar, A., Rana, N. P., Sivarajah, U., & Weerakkody, V. (2021). Drone as a Service (DaaS) in promoting cleaner agricultural production and Circular Economy for ethical Sustainable Supply Chain development. *Journal of Cleaner Production*, 287, 125522.
- Mangiaracina, R., Perego, A., Seghezzi, A., & Tumino, A. (2019). Innovative solutions to increase last-mile delivery efficiency in B2C e-commerce: a literature

- review. *International Journal of Physical Distribution & Logistics Management*.
- Marintseva, K., Yun, G., & Vasilenko, I. (2021). Delivery of special cargoes using the unmanned aerial vehicles. In *Research Anthology on Reliability and Safety in Aviation Systems, Spacecraft, and Air Transport* (pp. 1564-1587). IGI Global.
- Meincke, P., Asmer, L., Geike, L., & Wiarda, H. (2018). Concepts for cargo ground handling of unmanned cargo aircrafts and their influence on the supply chain. In *2018 8th International Conference on Logistics, Informatics and Service Sciences (LISS)* (pp. 1-10). IEEE.
- Merkert, R., & Bushell, J. (2020). Managing the drone revolution: A systematic literature review into the current use of airborne drones and future strategic directions for their effective control. *Journal of Air Transport Management*, 89, 101929.
- Merkert, R., Bliemer, M. C., & Fayyaz, M. (2022). Consumer preferences for innovative and traditional last-mile parcel delivery. *International Journal of Physical Distribution & Logistics Management*.
- Moshref-Javadi, M., & Winkenbach, M. (2021). Applications and Research avenues for drone-based models in logistics: A classification and review. *Expert Systems with Applications*, 177, 114854.
- Moshref-Javadi, M., Hemmati, A., & Winkenbach, M. (2020). A truck and drones model for last-mile delivery: A mathematical model and heuristic approach. *Applied Mathematical Modelling*, 80, 290-318.
- Mualla, Y., Bai, W., Galland, S., & Nicolle, C. (2018). Comparison of agent-based simulation frameworks for unmanned aerial transportation applications. *Procedia computer science*, 130, 791-796.
- Nyaaba, A. A., & Ayanga, M. (2021). Intricacies of medical drones in healthcare delivery: Implications for Africa. *Technology in Society*, 66, 101624.
- Olivares, V., Córdova, F., & Durán, C. (2017). Transport logistics and simulation model for fleet of drones in a Mass Customization System. In *2017 CHILEAN Conference on Electrical, Electronics Engineering, Information and Communication Technologies (CHILECON)* (pp. 1-6). IEEE.
- Osakwe, C. N., Hudik, M., Řiha, D., Stros, M., & Ramayah, T. (2022). Critical factors characterizing consumers' intentions to use drones for last-mile delivery: Does delivery risk matter?. *Journal of Retailing and Consumer Services*, 65, 102865.
- Pan, J. S., Song, P. C., Chu, S. C., & Peng, Y. J. (2020). Improved compact cuckoo search algorithm applied to location of drone logistics hub. *Mathematics*, 8(3), 333.
- Patchou, M., Sliwa, B., & Wietfeld, C. (2019). Unmanned aerial vehicles in logistics: Efficiency gains and communication performance of hybrid combinations of ground and aerial vehicles. In *2019 IEEE Vehicular Networking Conference (VNC)* (pp. 1-8). IEEE.
- Pinto, R., & Lagorio, A. (2022). Point-to-point drone-based delivery network design with intermediate charging stations. *Transportation Research Part C: Emerging Technologies*, 135, 103506.
- Precedence Research (2020). *Drone Logistics and Transportation Market Size, Share, Growth Analysis*. Retrieved from <https://www.precedenceresearch.com/drone-logistics-and-transportation-market>.
- Rabta, B., Wankmüller, C., & Reiner, G. (2018). A drone fleet model for last-mile distribution in disaster relief operations. *International Journal of Disaster Risk Reduction*, 28, 107-112.
- Raj, A., & Sah, B. (2019). Analyzing critical success factors for implementation of drones in the logistics sector using grey-DEMATEL based approach. *Computers & Industrial Engineering*, 138, 106118.
- Rejeb, A., Rejeb, K., Simske, S. J., & Treiblmaier, H. (2021). Drones for supply chain management and logistics: a review and research agenda. *International Journal of Logistics Research and Applications*, 1-24.
- Sah, B., Gupta, R., & Bani-Hani, D. (2021). Analysis of barriers to implement drone logistics. *International Journal of Logistics Research and Applications*, 24(6), 531-550.
- Sarder, M. D. (2020). *Logistics transportation systems*. Elsevier.
- Shavarani, S. M., M. G. Nejad, F. Rismanchian, & G. Izbirak. (2018). "Application of Hierarchical Facility Location Problem for Optimization of a Drone Delivery System: A Case Study of Amazon Prime Air in the City of San Francisco." *The International Journal of Advanced Manufacturing Technology* 95 (9–12): 3141–3153.
- Smith, A., Dickinson, J. E., Marsden, G., Cherrett, T., Oakey, A., & Grote, M. (2022). Public acceptance of the use of drones for logistics: The state of play and moving towards more informed debate. *Technology in Society*, 68, 101883.
- Statista (2019). *Commercial Drones are Taking Off*. Retrieved from <https://www.statista.com/chart/17201/commercial-drones-projected-growth/>
- Thiels, C. A., Aho, J. M., Zietlow, S. P., & Jenkins, D. H. (2015). Use of unmanned aerial vehicles for medical product transport. *Air medical journal*, 34(2), 104-108.
- Triche, R. M., Greve, A. E., & Dubin, S. J. (2020). UAVs and their role in the health supply chain: A case study from Malawi. In *2020 International Conference on Unmanned Aircraft Systems (ICUAS)* (pp. 1241-1248). IEEE.
- Troudi, A., Addouche, S. A., Dellagi, S., & El Mhamedi, A. (2017). Post-production analysis approach for drone delivery fleet. In *2017 IEEE International Conference on Service Operations and Logistics, and Informatics (SOLI)* (pp. 150-155). IEEE.
- Troudi, A., Addouche, S. A., Dellagi, S., & Mhamedi, A. E. (2018). Sizing of the drone delivery fleet considering energy autonomy. *Sustainability*, 10(9), 3344.
- Tümenbatur, A. & Tanyaş, M. (2021). Havalimani Kenti Kavramı: Türkiye'deki Bazı Havalimanlarının Karşılaştırılması. *Beykoz Akademi Dergisi*, 9 (1), 108-119.
- Varigonda, V. K., Borole, A., Hudge, A., Yadav, C., & Annamalai, V. K. (2021). Feasibility of Multi-Configuration Unmanned Aerial Vehicle for Last Mile Delivery of Medical Supplies. In *2021 Asian Conference on Innovation in Technology (ASIANCON)* (pp. 1-7). IEEE.
- Yoo, W., Yu, E., & Jung, J. (2018). Drone delivery: Factors affecting the public's attitude and intention to adopt. *Telematics and Informatics*, 35(6), 1687-1700.
- Zhu, X., Pasch, T. J., & Bergstrom, A. (2020). Understanding the structure of risk belief systems concerning drone



delivery: A network analysis. *Technology in Society*, 62, 101262.

**Cite this article:** Turgut, M., Seker, B. (2023). Drone Technology in Transportation Management: A Systematic Review and Framework for Future Research. *Journal of Aviation*, 7(2), 251-261.



This is an open access article distributed under the terms of the Creative Commons Attribution 4.0 International Licence

**Copyright © 2022 Journal of Aviation** <https://javsci.com> - <http://dergipark.gov.tr/jav>

# The Mediating Role of Emotional Labor in Linking Organizational Learning and Organizational Identification in the Aviation Industry

Duygu Uludağ<sup>1\*</sup>, Melis Soyer<sup>2</sup>, Merve Mert<sup>3</sup>

<sup>1\*</sup>Nisantasi University, Aviation Management Department, 34398, Maslak, İstanbul, Türkiye. (duygu.uludag@nisantasi.edu.tr).

<sup>2</sup>Nisantasi University, Aviation Management Department, İstanbul, Türkiye. (melis.soyer@nisantasi.edu.tr).

<sup>3</sup>Nisantasi University, Aviation Management Department, İstanbul, Türkiye. (merve.mert@nisantasi.edu.tr).

## Article Info

Received: 29 March 2023  
Revised: 11 May 2023  
Accepted: 30 May 2023  
Published Online: 13 July 2023

### Keywords:

Organization  
Organizational learning  
Organizational identification  
Emotional labor  
Aviation management

Corresponding Author: *Duygu Uludağ*

## RESEARCH ARTICLE

<https://doi.org/10.30518/jav.1273252>

## Abstract

In our study examined the mediating role of emotional labor in the effect of organizational learning on organizational identification. The purpose of the study is to measure the effect of organizational learning on organizational identification and to examine the mediating effect of emotional labor on the dimensions of learning. There are studies showing that organizational learning has a direct effect on organizational identification, but the mediating role of emotional labor has not been investigated.

The population of the study was the employees of ground services in the aviation sector of the Marmara region, 400 employees were reached through random sampling and data were collected through questionnaires. According to the results of the research, organizational learning is effective on organizational identification and emotional labor plays mediating role in this effect. In this context, emotional labor has a mediating role in the effect of managerial commitment, systemic perspective, transparency and experimentation and informational transaction and integration on organizational identification, which are sub-dimensions of organizational learning.

## 1. Introduction

Although they provide a competitive advantage in business, profitability and sustainability are concepts that are not as valuable today as they were in the past. Today's researches are concerned with people and their feelings in organizations, and the importance of 'is increasing day by day. With the changes in the external environment, the importance of the relationship between the employees and the organization has increased. At the beginning of the 20th century, more emphasis was placed on creating an emotional bond between the employees and the company to ensure the continuity of the working relationship and thus increase productivity. Another concept that has been brought to the forefront in some studies is the concept of "organizational identification." Organizational identification was first presented in the literature by Freud as an emotional bond that individuals form with other individuals (Gautam et al., 2004). The word recognition was first used by E. Tolma in 1943 in his company. The first study on this concept was conducted by March and Simon and was included in the management literature. In the service industry, customers consider the attitude of employees when they evaluate the service quality of a company. In the service sector, communication with customers is considered one of the main elements of quality. The concept of emotional labor also shapes communication with customers. The concept

of emotional labor first entered the literature with the publication of Arlie Hochschild's book "Managed Hearts: The Commercialization of Human Emotions" in 1983, and since then the interest in this topic has increased day by day (Kaya & Özhan, 2012).

Emotions are not something specific, visible or tangible in terms of their existence and properties. However, in today's conditions, watches have become one of the most concrete determinants of the working environment and have a material value. Especially in recent years, with the rapid expansion of the service sector, emotional labor has become a necessary and common part of many service sectors and many professional fields, including the aviation sector (Begenirbaş, 2013).

One of the most important advantages of the concept of organizational learning is an advantageous position in competition and the possibility to transform this advantage into a sustainable operation (Drucker, 1993). The knowledge and experience that organizations acquire during this process is one of the most important factors that enable them to prepare for and experience future situations.

The first part of the research presents conceptual and relational information about organizational learning, organizational identification, and emotional labor. The second part includes the research model, hypotheses, research methods used, analysis of data, and interpretation of results. Finally, in the concluding part, evaluations are made in

accordance with the data obtained and the limitations of the research, and suggestions are made for future studies.

## 2. Conceptual Framework

### 2.1. Organizational Learning

Organizational learning is an important process for organizations to remain competitive in today's rapidly changing environment. Organizational learning involves acquiring new knowledge, skills, and behaviors that can improve organizational performance. It's not only about the acquisition of knowledge, but also about how knowledge is shared and integrated within the organization. The success of organizations depends on new products and services that are created when new ideas and information enter the organization in an ever-changing and evolving market and competitive environment. Therefore, learning as one of the most important factors in change processes is of particular importance (Seçilmiş et al., 2018). The process of organizational learning includes four basic components: Acquisition of knowledge, dissemination of knowledge, utilization of knowledge, and retention of knowledge (Argyris & Schoen, 1978).

Organizational learning refers to the process of acquiring new knowledge, skills, and behaviors that an organization acquires based on its experiences and observations. It is expected that as the level of learning in organizations increases, new information will emerge and be disseminated, leading to an increase in organizational performance. Organizational learning is a process that involves learning new information and using that information by interpreting it to improve organizational performance (Marquardt, 1996). Organizations that engage in organizational learning can more easily adapt to a changing environment and improve the quality of their products and services while gaining a competitive advantage. Organizational learning contributes to high employee satisfaction by ensuring that facilities participate in continuous improvement studies.

Organizational learning is the use of experience and knowledge gained by organizations in the process or acquired from the environment for situations that may arise in the future (Trim & Lee, 2004). It would not be wrong to define the organizational learning process as a knowledge-based and dynamic process. The organizational learning process is a process that evolves from individual actions to groups and finally to the actions of organizations. The steps of these processes help organizations to form guiding models for the decision-making stages (Cyert & March, 1963). Achieving the highest organizational benefit depends on systematic implementation of the learning process. If employees do not engage in learning activities, organizations will not be able to sustain organizational learning and will lose their competitiveness (Demirel & Tohum, 2018).

### 2.2. Organizational Identification

Organizational identification refers to the degree of affiliation and commitment employees feel toward their organizations (Ashfort & Mael, 1989). The concept of organizational identification is important for understanding the relationship between employees and their organizations and the impact of this relationship on employee behavior. A strong sense of identification among employees with their organizations means that they have a strong sense of commitment and loyalty to their organizations. At the same time, a strong sense of identification with the organization indicates that employees defend their organization by making it their own. On the other hand, employees who do not identify

strongly with their organization tend to engage in behaviors that are detrimental to their organization, such as turnover, sabotage, and absenteeism (Dutton et al., 1994)

For organizational identification to occur, individuals in the organization must identify with the values, goals, and characteristics of the organization. An employee's level of organizational identification in an organization indicates the degree to which his or herself is connected to membership in that organization. If this affiliation is central to the self, if it is more important than other social group affiliations, it means that there is a high degree of identification for the individual (Altaş, 2021). Individuals who identify with their organization accept the characteristics of their organization as their own. For example, an employee of Turkish Airlines may adopt customer-oriented, visionary, and innovative characteristics and perceive these characteristics as his or her own. In this case, the employee may believe that the organization has the same characteristics as he does because he is in the organization (Baykal et al., 2018). The more similar the prestige of the organization and the values of the individual, the more effective the identification process. Social, environmental, cultural, and economic factors also play an important role in the relationship between individuals and organizations in terms of organizational identification. An increase in the level of identification is observed when the cultural infrastructures of organizations match those of individuals.

The process of organizational identification includes cognitive and emotional components. Cognitive identification involves understanding the goals, values, and norms of the organization. Emotional identification involves an emotional attachment to the organization and a sense of pride and belonging in being part of the organization (Riketta, 2005). Organizations should work to develop the concept of identification in terms of the elements they have. A high level of organizational identification is an important process for promoting positive outcomes for both organizations and individuals.

### 2.3. Emotional Labor

Emotional labor refers to the process of managing the emotions of others to create a positive experience for customers as well as managing their own emotions to perform a task effectively (Hochschild, 1983). Emotional labor creates an important source of stress by revealing the situation that employees have to suppress their own emotions or act as if they have emotions that they do not really feel in order to meet their emotional expectations (Grandey, 2000).

Emotional labor is more prevalent in the service, hospitality, health, and education sectors, which are concerned with leaving a positive impression on customers. For example, even if a flight attendant is afraid or feels anxious, he or she should remain calm to counter a stressful situation on an airplane and avoid stressing passengers. Similarly, a healthcare worker who is confronted with difficult situations must maintain his or her calm. In such cases, employees use the emotional labor factor to create positive experiences for the people in front of them. The way employees control and present their behavior and emotions during interactions with customers is an important issue. The emotional aspect and presentation of work is the most critical element, especially for employees who interact directly with customers (Mavi & Yeşil, 2021).

Research shows that emotional labor has both positive and negative effects on employees. Employees who can successfully manage their emotions have a positive impact on job satisfaction and self-esteem (Ashforth & Humphrey, 1993). On the other hand, employees who cannot fully express their emotions may not be able to cope with emotional stress, which can lead to burnout. This is one of the negative effects of emotional labor on employees. On the other hand, emotional labor can lead to emotional exhaustion, especially when employees feel that they cannot express their true feelings (Hochschild, 1983).

#### 2.4. Relations Between Concepts

Organizational learning and organizational identification are important concepts in the field of organizational behavior. Organizational learning refers to the process of acquiring various knowledge and skills to enhance institutional performance and adapt to a changing environment (Argote & Miron-Spektor, 2011). The concept of organizational identification, on the other hand, is the process that shows the level of commitment and integration of individuals to their organizations (Mael & Ashfort, 1992). The concept of organizational identification positively affects the concept of organizational learning. The more employees identify with their organization, the higher their commitment to their organization (Zhang et al., 2011). It is important to create a learning culture that promotes employee engagement, retention, and performance in organizations. Employees contribute to the long-term success of institutions when they identify with their institution and thus learn.

Organizational learning and organizational identification are two important interrelated concepts. Organizational learning, while it refers to the process of acquiring and applying new knowledge and skills within an organization, organizational identification refers to the degree to which an individual identifies with his or her organization.

According to the research of Saks and Ashforth (2000), organizational learning has a positive effect on organizational identification. When employees perceive their organization as a learning organization that values and supports the acquisition of new knowledge and skills, they are more likely to identify with their organization.

Organizations that place a high value on organizational learning tend to have higher levels of employee identification with their organization (Crossan et al., 1999). Organizational learning can facilitate the integration of new employees into the organization. New employees often face a steep learning curve when they join an organization, and the organization's ability to support and facilitate their learning has a significant impact on their identification with the organization. Companies with a learning culture tend to be more attractive to potential employees looking for growth and development opportunities (Edmondson, 1999).

Organizational learning can have a positive impact on identification with the organization, leading to better outcomes for employees. Organizational learning can facilitate the integration of new employees into the organization and help employees identify with the organization's goals. This identification can lead to higher levels of engagement and motivation, which in turn leads to better job performance and lower turnover rates.

In general, research shows that the relationship between organizational learning and organizational identification is reciprocal and mutually supportive. When organizations value and support learning, employees are more likely to identify

with their organizations. Along with organizational learning and organizational identification, high levels of employee engagement, motivation, increased job performance, and lower turnover rates can be observed. When employees identify with their company, they are also more willing to share knowledge, which facilitates learning within the company.

The concept of organizational learning has four sub-dimensions: managerial commitment, systems perspective, openness and experimentation, knowledge transfer, and integration (Jerez-Gomez, 2005). Studies on the relationship between all these sub-dimensions and the concept of organizational identification have been investigated separately. It has been shown that there is a reciprocal and supportive relationship between the sub-dimensions of organizational learning and the concept of organizational identification.

The concepts of managerial commitment and organizational identification are interrelated constructs. Managerial commitment refers to the extent to which leaders are committed to achieving their organizational goals. This concept of commitment is reflected in managers' willingness to make sacrifices for the good of the organization, as well as the time and effort they devote to their work (Meyer, et al., 2002). Organizational identification refers to the extent to which employees feel a sense of belonging and loyalty to their organization (Ashforth & Mael, 1989). This definition is reflected in the extent to which employees adopt the values and goals of the organization and align their behavior with the behavior of the organization.

Studies have shown that there is a positive relationship between managerial commitment and organizational identification. Leaders who demonstrate a high level of commitment to their organization are more likely to develop a sense of identification among their employees. This identification leads to positive outcomes for the organization, such as higher job satisfaction, job performance, and organizational commitment (Meyer et al., 2002).

A study conducted by Nishii and Mayer (2009) found that employees who strongly identify with their organization are more likely to perceive their managers as committed to the organization's goals and values. This perception increases employees' commitment to the organization and their willingness to act in ways that benefit the organization.

The relationship between managerial commitment and organizational identification is an important area of research that has significant implications for organizational outcomes. Leaders with high levels of commitment to their organization develop a sense of identification among their employees, which leads to positive organizational outcomes. Therefore, it is very important for organizations to foster and develop their leaders' commitment to the organization in order to improve organizational identification and overall performance.

The systems perspective reflects complex systems consisting of interconnected parts in which organizations interact with each other to achieve their goals. From this perspective, organizations are defined as open systems that interact with their external environment to achieve their goals (Katz & Kahn, 1978). Research has shown that a systems perspective can have a positive impact on organizational outcomes such as job satisfaction, organizational commitment, and job performance (Bakker et al., 2004). Employees who adopt a systems perspective are more likely to feel a sense of belonging and ownership, which can lead to positive outcomes toward the organization.



The systems perspective is an important concept for understanding organizations, and its relationship to organizational identification has important implications for organizational outcomes. Organizations that emphasize the systems perspective develop a greater sense of identification among their employees, leading to positive outcomes such as increased job satisfaction, organizational commitment, and job performance.

The relationship between openness and experimentation and organizational identification is assessed in terms of organizational culture. Shaping the behaviors of individuals in an organization, sharing values, beliefs, and practices are expressed through organizational culture (Cameron & Quinn, 2011). Openness is characterized by a willingness to listen to new ideas, embrace change, and challenge the status quo. On the other hand, experience means taking risks, trying new things, and learning from mistakes. These two cultural dimensions support the creation of an environment in which employees are encouraged to be creative and innovative, which can lead to increased job satisfaction, commitment, and organizational identification (Shin & Zhou, 2007).

Studies have shown that organizations that encourage openness and experimentation tend to have higher levels of employee identification with the organization (Shin & Zhou, 2007; Parker et al., 2006). When employees feel that their ideas are valued and they have the opportunity to experiment, they are more likely to identify with the organization and its goals. However, employees' adoption of the organization's values and goals is reflected in the extent to which they align their behavior with the organization's behavior. With openness and experience; it is one of the important dimensions that can create an environment where employees are encouraged to be creative and innovative, and that supports the emergence of positive activities for the organization with the increase of organizational identification.

Knowledge transfer and integration refers to the process of sharing knowledge and expertise among individuals within the organization. Knowledge transfer helps individuals learn new skills, improve job performance, and ultimately contribute to the success of the organization (Argote & Ingram, 2000). At the same time, knowledge transfer and integration play a crucial role in employees' identification with their organization (Liao et al., 2009).

According to the study, it was found that employees of organizations that emphasize knowledge transfer and knowledge integration have a higher tendency to identify with the organization (Liao et al., 2009). When employees feel that their knowledge and experience are valued, they are more likely to identify with the organization and its goals. The compatibility of employee behavior with organizational behavior depends on the extent to which employees adopt the organization's values and goals.

The concepts of organizational learning and emotional labor are interrelated. Organizational learning refers to the process of acquiring knowledge and skills that enhance an organization's ability to adapt to changing conditions, improve its performance, and achieve specific goals. Emotional labor, on the other hand, refers to the effort, planning, and control required to exhibit certain emotions in a work environment.

Emotional labor can affect organizational learning by affecting employee engagement and job satisfaction. Situations where employees need to give emotional labor in challenging processes can cause burnout, stress, decrease in learning and development motivation. At the same time, organizational learning can affect emotional labor by creating

a culture of continuous learning and improvement. When employees feel supported in their development and have access to learning opportunities, they can increase job satisfaction and customer interactions by managing their emotions. The fact that emotional labor can be a component of organizational learning and that organizational learning creates a culture of development in the form of continuous learning by affecting employee commitment reflects the connection between emotional labor and organizational learning.

Grandey et al. (2012) a study by; He argues that emotional labor affects emotional burnout and job satisfaction of employees and this situation is also reflected in learning motivation. In this study, it is found that employees who engage in unreal or compulsive emotional labor are more likely to experience emotional exhaustion, which leads to a decrease in motivation to learn and develop. At the same time, employees who feel that emotional labor is not supported by the organization have lower job satisfaction, which affects their willingness to participate in learning and development opportunities.

Emotional labor also affects the way organizations as a whole learn and adapt. According to Ashkanasy and Humphrey (2011), emotional labor helps create a positive organizational culture that supports learning and innovation. Organizations create a more conducive environment for learning and growth by encouraging employees to constructively manage their emotions. Studies suggest that organizations can improve employee well-being by supporting emotional labor and creating a culture of continuous learning and improvement. Organizational learning and emotional labor are closely related concepts that have a significant impact on individual and organizational performance. Therefore, it is important for organizations to recognize the role of emotional labor in the learning process and create an environment that supports learning.

The concept of emotional labor and organizational identification are two important elements in the field of organizational psychology. Emotional labor; which refers to the process of dealing with emotions as part of one's work; It refers to the degree to which individuals identify with the organization. There is a positive relationship between organizational identification and emotional labor. Specifically, individuals who identify strongly with their organization expend more emotional labor to meet organizational expectations and norms (Van Jaarsveld, et al., 2010). At the same time, the amount of emotional labor depends on the type of organizational identification an employee experiences. While there are employees who identify more strongly with their organization because they believe in the organization's values and mission, there are employees who identify with their organization because of the organization's reward system and the benefits it provides (Ashforth & Mael, 1989). The relationship between the concepts of organizational identification and emotional labor indicates that employees' commitment to their organization influences their emotional experiences and behaviors.

Diefendorff et al. (2005) argue that emotional labor can have a positive impact on organizational identification. Specifically, the study found that individuals who perform emotional labor are more likely to identify with their organization. This relationship was observed to be stronger for individuals who act superficially (imitating the necessary emotions without attempting to actually feel them) than for

individuals who act deeply (attempting to actually feel the emotions required for their work).

Groth et al. (2009) argue that emotional labor can also negatively affect organizational identification under certain conditions. In the work concept, the perception of emotional labor as a kind of emotional disharmony (i.e., a conflict between one's own feelings and the emotions demanded by the job) leads to lower organizational identification. This effect is especially true for employees who are strongly committed to their work and have a strong need for autonomy.

In general, the relationship between emotional labor and organizational identification is complex and depends on several factors. However, emotional labor plays an important role in how individuals perceive their organization and how they identify with it. In this context, the following hypotheses have been formed based on theoretical evidence;

H1: Organizational learning is effective on organizational identification and emotional labor has a mediating role in this effect.

H2: Emotional labor has a mediating role in the effect of managerial commitment on organizational identification.

H3: Emotional labor has a mediating role in the effect of systemic perspective on organizational identification.

H4: Emotional labor has a mediating role in the effect of transparency and experimentation on organizational identification.

H5: Emotional labor has a mediating role in the effect of informational transaction and integration on organizational identification.

### 3. Method

This study is a descriptive and descriptive research. In this type of research, it is aimed to reveal the existing situation about an event. Questionnaire technique was used as a data collection method. In the application of the questionnaire form to individuals, convenience sampling method was used among non-random sampling methods.

The compliance of the current study with ethical principles was approved by the Nisantaşı University Ethics Committee with meeting number 2023/13. Data were collected via the Internet from individuals working in the aviation industry in Turkey in March 2023. All participants were informed that participation was voluntary, that all data would be kept confidential and that the identity of the participant would not be disclosed. Participants who were willing to participate in the study were presented with an online questionnaire.

#### 3.1. Data Collection

The universe of research consists of aviation workers in Turkey. In this study, the effect of organizational learning on organizational identification through emotional labor is investigated. The random sampling method was used as the sampling method. The prepared questionnaire was applied to the people who are currently working at the airports in Turkey through the Internet. The study was conducted by giving the questionnaire used in the study to 425 people. However, the questionnaires of 25 people that were incomplete were not included in the study. Consequently, the final sample of the study was set at 400 (194 (%48.5) female, 206 (%51.5) male) people.

#### 3.2. Measures

Participants in the study were asked a total of 40 questions, which consisted of three different scales and demographic questions. All questions except the demographic questions were asked on a 5-point Likert scale (1: "strongly disagree," 5: "strongly agree"). The emotional labor scale, which is the mediating variable of the survey, was developed by Pala and Sürgevil in 2016 and consists of a total of 12 questions. The organizational learning scale, which is the dependent variable of the study, was developed by Jerez-Gomez (2005). The organizational learning scale, totaling 16 questions and 4 dimensions, used 5 questions to measure managerial commitment, 3 questions to measure systemic perspective, 4 questions to measure transparency and experimentation, and 4 questions to measure information transaction and integration. Scale for identification with the organization that is the outcome variable of the study; The scale developed by Mael and Ashforth (1992) and adapted by Eker (2015) was used. The scale consists of a total of 12 questions.

#### 3.3. Data Analysis

Basically, the data collected online were analyzed using the SPSS package program. Later, erroneous parts were detected and removed from the program. Then, the reliability and validity of the scales used in the instruments were analyzed. The organizational learning rules included four dimensions (managerial commitment, systemic perspective, transparency and experimentation, information processing and integration), and these dimensions were assessed using the confirmatory factor analysis method. In addition, the general statistics and the boundaries between variables were examined. To test mediation models in research, Hayes et al. (2017) used the guidance PROCESS Macro (Model 4). The AMOS 21 program was used for confirmatory factor analysis. 95% confidence intervals were determined based on large data sets reconstructed from original sources using the bootstrap method. This method allows the modeling of multiple regression consumption.

### 4. Results

#### 4.1. Reliability and Validity Analyses of the Scales

The reliability values of the scales of the questionnaire are given in Table 1. It was found that the expressions in the scales have values between 0.74 and 0.94 with a margin of error of 0.05 in the 95% confidence interval.

**Table 1.** Reliability Analysis Results of Scales

Scales	Cronbach Alfa
Organizational Learning (OL)	0.94
Managerial Commitment (MC)	0.82
Systemic Perspective (SP)	0.87
Transparency and Experimentation (TE)	0.84
Informational Transaction and Integration (ITI)	0.84
Organizational Identification (OI)	0.83
Emotional Labor (EL)	0.74

In addition, a factor analysis was conducted for the scales measuring organizational learning. The result of the Kaiser-Meyer-Olkin (KMO) test was calculated as 0.963 to ensure the adequacy of the data from the sample we used for the organizational learning scale. On the other hand, Barlett's test for sphericity with  $p < 0.01$  is valid for the organizational learning scale. Accordingly, the results of KMO test show that the data are suitable for factor analysis (Table 2). The result of

factor analysis for the organizational learning scales shows that there is no item with factor loading less than 0.58 (Table 3).

**Table 2.** KMO and Bartlett's Test Result

KMO and Bartlett's Test		Organizational Learning
Kaiser-Meyer-Olkin Measure		0.963
Sample fit test		
Bartlett	Approximate Ki-Kare	3987.432
Testi	Df	120
	Sig.	0.000

As a result of the confirmatory factor analysis for the organizational learning in research scale, the presence of the dimensions of managerial commitment, systemic perspective, transparency and experimentation, information transaction, and integration, which are the four sub-dimensions of the scale, was verified and the construct validity of the scale was revealed.

**Table 3.** Factor Analysis Results on Organizational Learning Dimensions

Subdimensions	Perception Dimensions	Factor Loads	Total Variance (%)
Managerial Commitment	S1	0.79	69.835
	S2	0.69	
	S3	0.65	
	S4	0.61	
	S5	0.58	
Systemic Perspective	S6	0.81	
	S7	0.73	
	S8	0.82	
Transparency and Experimentation	S9	0.69	
	S10	0.73	
	S11	0.71	
	S12	0.62	
Informational Transaction and Integration	S13	0.61	
	S14	0.70	
	S15	0.70	
	S16	0.63	

Examination of the results of the confirmatory factor analysis shows that the degree of freedom ( $\chi^2/df$ ) is less than 3 (2.283). From this point of view, it can be said that the statistical result of the first adjustment is adequate. Moreover, the "GFI" value of 0.93 is at an acceptable level. The "RMSEA" value is 0.057 and is at an acceptable level with a confidence interval of 90%. In addition, the "NFI" 0.94, "CFI" 0.94, "GFI" 0.93, "AGFI" 0.91, "IFI" 0.96, "RFI" 0.93 values were found to be acceptable. These results indicate the construct validity of the scale and the reliable measurement of its dimensions.

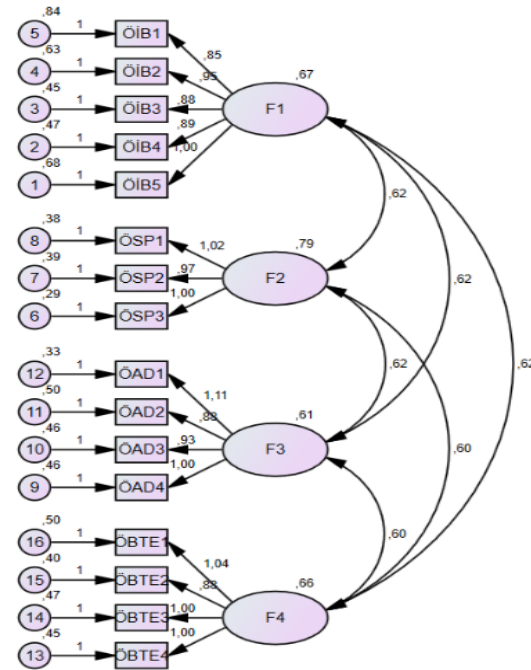
**Table 5.** Correlation Analysis Results

Variables	M	SD.	1	2	3	4	5	6	7
1.Organizational Learning	3.82	0.78	1						
2.Organizational Identification	3.66	0.58	0.733**	1					
3.Emotional Labor	3.65	0.54	0.807**	0.677**	1				
4.Managerial Commitment	3.76	0.84	0.929**	0.607**	0.845**	1			
5.Systemic Perspective	3.73	0.95	0.872**	0.763**	0.615**	0.745**	1		
6.Transparency and Experimentation	3.89	0.83	0.925**	0.667**	0.707**	0.808**	0.756**	1	
7. Informational Transaction and Integration	3.88	0.84	0.907**	0.663**	0.726**	0.775**	0.718**	0.804**	1

Note. SD= Standard Deviation, M= Mean, N = 400, \*\*p < 0.01

**Table 4.** Fit Index Values Obtained from Confirmatory Factor Analysis with the Amos Program

Fit Indexes	Good Fit Values	Acceptable Fit Values	Achieved Values
RMSEA	0.00≤RMSEA≤0.05	0.05≤RMSEA≤0.08	0.05
NFI	0.95≤NFI≤1.00	0.90≤NFI≤0.95	0.94
CFI	0.95≤CFI≤1.00	0.90≤CFI≤0.95	0.96
GFI	0.95≤GFI≤1.00	0.90≤GFI≤0.95	0.93
AGFI	0.90≤AGFI≤1.00	0.85≤AGFI≤0.90	0.91
IFI	0.95≤IFI≤1.00	0.90≤IFI≤0.95	0.96
RFI	0.95≤RFI≤1.00	0.90≤RFI≤0.95	0.93
$\chi^2/df$	0 ≤ $\chi^2/df$ ≤ 2	2 ≤ $\chi^2/df$ ≤ 3	2.283



**Figure 1.** Confirmatory Factor Analysis Result

**4.2. Correlation Analysis Results**

The means, standard deviations, and correlation results of all variables in the current study are shown in Table 5.

The results of the correlation analysis show that there is a positive and significant relationship between organizational learning, organizational learning sub-dimensions, and organizational identification [ $r=0.733, p<0.01; r=0.607, p<0.01; r=0.763, p<0.01; r=0.667, p<0.01; r=0.663, p<0.01$ ].

In addition, there is a positive and significant relationship between emotional labor and the sub-dimensions of organizational learning [ $r=0.845, p<0.01; r=0.615, p<0.01; r=0.707, p<0.01; r=0.726, p<0.01$ ]. Moreover, it is found that there is a positive and significant relationship between

emotional labor, organizational identification, and organizational learning [r=0.807, p<0.01; r=0.677 p<0.01].

4.3. Results and Hypothesis

In the present study, the results for determining the mediating role of emotional labor in the relationship between organizational learning and organizational identification are presented in Table 6.

Table 6. Testing the mediation effect of organizational learning on organizational identification

	Model 1 (OI)		Model 2 (EL)		Model 3 (OI)	
	B	T	B	T	B	T
OL	0.54***	21.51	0.56***	27.27	0.39***	9.47
EL	-	-	-	-	0.26***	4.34
R <sup>2</sup>	0.53		0.65		0.55	
F	462.70		743.82		251.17	

Note. N= 400, OI= Organizational Identification, EL= Emotional Labor

\*\*\* p < 0.001

In this table, three different submodels were created according to our model (Table 6). Model 1 analyzed the effects of organizational learning on organizational identification. According to this model, the effect of organizational learning on organizational identification is positive (b = 0.54, p < 0.001). Model 2 analyzed the effect of organizational learning on emotional labor. The effect of organizational learning on emotional labor was also positive (b = 0.56, p < 0.001). Finally, Model 3 presents the effect of organizational learning and organizational identification on emotional labor. Organizational learning (b = 0.39, p < 0.001) and emotional labor (b = 0.26, p < 0.001) had a positive effect on organizational identification. As can be seen in Table 7, the mediation effect of emotional labor was statistically significant.

Table 7. Direct and Indirect Effects of Organizational Learning on Organizational Identification

Total Effects of Organizational Learning on Organizational Identification						
		Unstand.	SE	LLCI	ULCI	
		0.54	0.02	0.495	0.594	
Direct Effects of Organizational Learning on Organizational Identification						
		0.39	0.042	0.315	0.480	
Indirect Effects of Organizational Learning on Organizational Identification (Emotional Labor)						
Ind.	Med.	Dep.	Unstand.	SE	LLCI	ULCI
OL	> EL	> OI	0.14	0.035	0.080	0.215

Note. Ind. = Independent, Med.=Mediation, Dep. = Dependent, N=400

As can be seen in Table 8, organizational learning in Model 1 has managerial commitment (b = 0.37, p < 0.001), systemic perspective (b = 0.46, p < 0.001), transparency and experimentation (b = 0.46, p < 0.001), and information transaction and integration (b = 0.45, p < 0.001) have a positive effect on organizational identification.

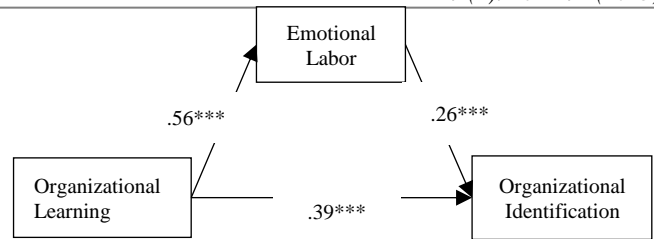


Figure 2. The Mediator Role Emotional Labor in the Effect of Organizational Learning on Organizational Identification

Similarly, organizational learning has managerial commitment (b = 0.54, p < .001), systemic perspective (b = 0.35, p < 0.001), transparency and experimentation (b = 0.46, p < 0.001), and information transaction and integration (b = 0.46, p < 0.001) have a positive effect on emotional labor. Finally, the subdimensions of organizational learning and emotional labor had a positive effect on organizational identification (Model 3). Consequently, the subdimensions of organizational learning and emotional labor had a positive effect on organizational identification.

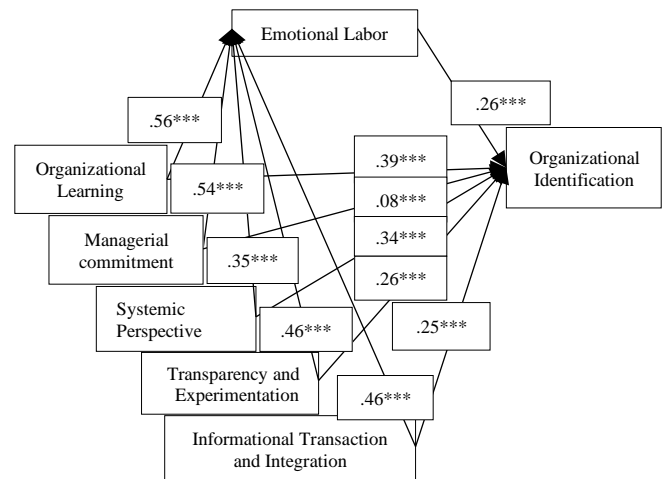


Figure 3. Mediator Role of Emotional Labor in the Effects of Sub-Dimensions of Organizational Learning on Organizational Identification, \*\*\*p < 0.001

Table 8. Testing the Mediation Effect of Emotional Labor on the Effect of Sub-Dimensions of Organizational Learning on Organizational Identification

	Model 1 (OI)		Model 2 (EL)		Model 3 (OI)	
	B	T	B	T	B	T
MC	0.37***	6.31	0.54***	31.51	0.08***	1.76
EL	-	-	-	-	0.61***	8.35
R <sup>2</sup>	0.36		0.71		0.46	
F	232.21		993.41		171.11	
SP	0.46***	23.57	0.35***	15.57	0.34***	14.84
EL	-	-	-	-	0.35***	8.89
R <sup>2</sup>	0.58		0.37		0.65	
F	555.61		242.52		371.91	
TE	0.46***	17.87	0.46***	02.33	0.26***	7.75
EL	-	-	-	-	0.43***	8.44
R <sup>2</sup>	0.44		0.49		0.52	
F	319.62		397.20		223.73	
ITI	0.45***	17.67	0.46***	21.09	0.25***	7.16
EL	-	-	-	-	0.44***	8.18
R <sup>2</sup>	0.43		0.52		0.52	
F	312.51		444.83		215.71	

Note. N= 400, OL= Organizational Learning, OI= Organizational Identification, EL= Emotional Labor, MC= Managerial Commitment, SP= Systemic Perspective, TE= Transparency and Experimentation, ITI= Informational Transaction and Integration \*\*\* p < 0.001



**Table 9.** The Indirect Effects of the Sub-Dimensions of Organizational Learning on Organizational Identification

Ind.	Med.	Dep.	Unstand.	SE	LLCI	ULCI
MC	> EL	> OI	0.3352	0.0474	0.2461	0.4306
SP	> EL	> OI	0.1260	0.0174	0.0932	0.1617
TE	> EL	> OI	0.2037	0.0281	0.1518	0.2613
ITI	> EL	> OI	0.2016	0.0274	0.1533	0.2602

Note. N = 400, OI= Organizational Identification, EL= Emotional Labor, MC= Managerial Commitment, SP= Systemic Perspective, TE= Transparency and Experimentation, ITI= Informational Transaction and Integration, \*\*\*p < 0.001

**Table 10.** Summary Table of Hypotheses

Hypothetical Relationship	Mediation	Results
H1: OL → OI and OL → EL → OI	EL	<b>Accepted</b>
H2: MC → EL → OI	EL	<b>Accepted</b>
H3: SP → EL → OI	EL	<b>Accepted</b>
H4: TE → EL → OI	EL	<b>Accepted</b>
H5: ITI → EL → OI	EL	<b>Accepted</b>

Note. N = 400, OL= Organizational Learning, OI= Organizational Identification, EL= Emotional Labor, MC= Managerial Commitment, SP= Systemic Perspective, TE= Transparency and Experimentation, ITI= Informational Transaction and Integration

Table 10 shows the results of the hypotheses. According to the table, H1, H2, H3, H4 and H5 are accepted.

## 5. Conclusion

There are many examples of the fact that organizations, and therefore the markets in which they are located, can reach international dimensions by crossing national borders, and that organizations that cannot adapt to the necessary changes, having reached that dimension, can disappear. . It is a fact that every institution with capital has access to constantly changing and developing information and technologies. In this case, it is very important to differentiate from other organizations and adapt to the changes and differences in the world order. What will be different from other organizations is the element of access, understanding and development of information, especially people. As management and traditional organizations have changed, the fact that people are emotional beings has become more important.

In this context, with the learning concept of organizations, it will be easier for individuals to identify with their organizations. This study was conducted to investigate the impact of organizational learning on organizational identification, in which emotional labor plays a mediating role.

The identification supported by organizational learning will also lead individuals to act with their emotions. It is an important value that the leader has skills such as understanding the emotional needs of their employees, meeting their human and material needs, conveying the sense that they are an important individual to the organization, and the ability to empathize with employees. The fact that the leader possesses these qualities is a reflection of the organization in the eyes of the employees. It is just as important for organizations to hire effective employees as it is to keep them in the organization. One of the biggest human resource issues facing companies today is employee turnover. Various measures can be taken to combat this situation, and many problems arise, such as the cost and time lost in finding new personnel, the negativity of existing employees in this compensation process, the

associated decline in performance, and the fluctuations in product and quality. Organizational identification: it increases the sense of doing business together. But identification is more than a collaborative activity. These emotions that enable individuals to act collectively are essentially a sense of empathy.

The identification supported by organizational learning will also lead individuals to act with their emotions. As the service sector has become more important, the conditions of competition in this sector have also become more difficult. Customer satisfaction and service quality are mainly influenced by face-to-face communication between service providers and recipients. For this reason, emotions become even more important in the service sector, where communication is often face-to-face and service providers are expected to satisfy customers to the maximum by putting their emotions first. The human element, which plays an important role in the formation of societies and institutions, involves its emotions in this educational process. Emotions become elements that directly influence all learning processes of people. Understanding the emotions of individuals and institutions can be challenging for many reasons. First of all, each individual and society is different; the fact that their environmental, social, and cultural structures differ from each other means that the emotional impact on institutions differs. Therefore, it is very difficult to capture and analyze emotional reflections in a single classification.

In İyem and Yıldız's (2017) study examining the relationship between flight attendants' emotional work behaviors and their alienation dimensions, flight attendants intensely suppress their emotions in the work environment. Emotional conflict and effort were found to be positively related to the meaninglessness, powerlessness, and isolation dimensions of alienation. In addition, sincere behavior was found to be related to performance, and flight attendants were found to experience intense isolation. It was concluded that suppression of emotions leads to emotional alienation. Çolak (2022) conducted a study on flight attendants of different ages and experience at an airline. She concluded that the emotional competencies of cabin crew have a significant positive impact on their performance. The concept of emotional labor plays a mediating role, especially in studies conducted in labor-intensive fields such as the service sector (Li & Wang, 2016; Wu et al., 2017; Potipiroon et al., 2019).

In studies conducted in this context, a high level of emotional labor is a factor that increases work performance and engagement. At the same time, research has shown that there is a positive relationship between organizational learning and organizational identification. Emotional labor acts as a mediator in the processes of organizational learning and organizational identification of aviation employees.

Based on the research findings, it has been determined that organizational learning significantly influences organizational identification, and emotional labor plays a mediating role in this relationship. Additionally, emotional labor acts as a mediator between managerial commitment, systemic perspective, transparency and experimentation, and informational transaction and integration, which are sub-dimensions of organizational learning, and organizational identification. The research suggests that emotional labor plays a crucial role in the impact of various factors on organizational identification within the context of organizational learning.

Today's conditions directly affect the environment in which institutions carry out their activities and the target groups they address. All technological developments in the

field of production and services affect many points, including the organizational structures of institutions. It is quite normal that the concepts of organizational learning, emotional work and organizational identification are interwoven when making plans for the future in this time when everything is developing rapidly both in production and consumption and all trends are spreading. The emotions of the personnel in the institutions are directly reflected in the learning process. They develop by merging with the learning of the organizations, and thus the identification of the individual with the organization and the ability to control their emotions.

Organizations can continue their life as long as they learn, and they can identify individuals with their organizations. The ability to learn empowers employees to develop new ideas, evaluate them, and incorporate them into decision making. At this stage, institutional support for employee education and evaluation of emerging innovative ideologies is an important stage for organizational learning. The role of institutions should be to support employees who are developing at the same time as their managers. Developing employees through learning also means developing organizations, managing emotions, and increasing feelings.

Organizations are a place where there is a close connection between emotions and reason. Emotions direct attention and shape thoughts. Emotions influence what we think and perceive and keep us focused. Employees who feel valued, excited, and proud will think about ways to improve their organization and look for opportunities to do so. He comments on feedback from supervisors, customer feedback, and positive market changes and gives them positive feedback. In this case, he has used all of his intellectual abilities; they extend to creative, flexible, and analytical thinking. Employees who live in fear, resentment and pain lose most of their intellectual abilities and therefore begin to think solidly, primitively, messily, simply and superficially. It is very important for companies to understand this relationship between emotional states and intellectual performance and to use human resources as positively as possible. In order to increase employees' identification with the organization, the company should be managed efficiently by giving priority to emotion management practices in enterprises.

In our country, there is a need for studies in various fields to clearly understand the impact on employees and organizations of the strategies to be chosen in the concept of organizational learning, organizational identification, and emotional labor. It would be beneficial if the topic was studied in different occupational groups to compare the results. The study was conducted in the Marmara region and a very limited sample could be obtained. All hypotheses made based on the research results were confirmed and it is expected that the study will contribute to the literature. The research is related to the aviation sector and cannot be generalized to the service sector.

### Ethical Approval

This study protocol received ethical approval from Nisantasi University's Ethics Committee by the Decision Number 2023/13 (2023/03/22).

### Conflicts of Interests

The authors declare that there is no conflict of interest regarding the publication of this paper.

## References

- Altaş, S. S. (2021). Sağlık çalışanlarının örgütsel özdeşleşme, örgütsel bağlılık, örgütsel güven ve örgütsel destek algıları arasındaki ilişkiler. *İşletme araştırmaları dergisi*, 13(1), 875-891.
- Argote, L., & Ingram, P. (2000). Knowledge transfer: A basis for competitive advantage in firms. *Organizational behavior and human decision processes*, 82(1), 150-169.
- Argote, L., & Miron-Spektor, E. (2011). Organizational learning: From experience to knowledge. *Organization science*, 22(5), 1123-1137.
- Argyris, C., & Schön, D. (1978). *Organizational learning: a theory of action prospective*. Reading, Pennsylvania, USA: Addison-Westly
- Ashforth, B. E., & Humphrey, R. H. (1993). Emotional labor in service roles: The influence of identity. *Academy of management review*, 18(1), 88-115.
- Ashforth, B. E., & Mael, F. (1989). Social identity theory and the organization. *Academy of management review*, 14(1), 20-39.
- Ashkanasy, N. M., & Humphrey, R. H. (2011). Current emotion research in organizational behavior. *Emotion review*, 3(2), 214-224.
- Bakker, A. B., Demerouti, E., & Verbeke, W. (2004). Using the job demands-resources model to predict burnout and performance. *Human resource management: Published in Cooperation with the School of Business Administration, The University of Michigan and in alliance with the Society of Human Resources Management*, 43(1), 83-104.
- Baykal, E., Zehir, C. & Köle, M. (2018). Hizmetkar liderlik firma performansı ilişkisinde örgütsel özdeşleşmenin aracı etkisi. *Akademik hassasiyetler*, 5 (9), 111-133.
- Cameron, K. S., & Quinn, R. E. (2011). *Diagnosing and Changing Organizational Culture: Based on the Competing Values Framework*. New Jersey: John Wiley & Sons.
- Crossan, M. M., Lane, H. W., & White, R. E. (1999). An organizational learning framework: From intuition to institution. *Academy of management review*, 24(3), 522-537.
- Çolak, N. (2018). Duygusal emeğin iş performansına etkisi, havacılık sektöründe bir uygulama. *FSM mesleki bilimler dergisi*, 1(1), 112-127.
- Demirel, Y. & Tohum, E. U. (2018). Örgütsel öğrenmenin örgütsel vatandaşlık davranışı üzerine etkisi. *MANAS Sosyal araştırmalar dergisi*, 7 (2), 277-295.
- Diefendorff, J. M., Croyle, M. H., & Gosserand, R. H. (2005). The dimensionality and antecedents of emotional labor strategies. *Journal of vocational behavior*, 66(2), 339-357.
- Dutton, J. E., Dukerich, J. M., & Harquail, C. V. (1994). Organizational images and member identification. *Administrative science quarterly*, 239-263.
- Edmondson, A. (1999). Psychological safety and learning behavior in work teams. *Administrative science quarterly*, 44(2), 350-383.
- Grandey, A. A. (2000). Emotional regulation in the workplace: A new way to conceptualize emotional labor. *Journal of occupational health psychology*, 5(1), 95.
- Grandey, A., Foo, S. C., Groth, M., & Goodwin, R. E. (2012). Free to be you and me: a climate of authenticity

- alleviates burnout from emotional labor. *Journal of occupational health psychology*, 17(1), 1.
- Groth, M., Hennig-Thurau, T., & Walsh, G. (2009). Customer reactions to emotional labor: The roles of employee acting strategies and customer detection accuracy. *Academy of management Journal*, 52(5), 958-974.
- Hochschild, A. R. (1983). *The managed heart: Commercialization of human feeling*. Berkeley: University of California Press.
- İyem, C., & Yıldız, F. Z. (2017). Gökyüzündeki gösteri: kabin memurlarının duygusal emek süreçlerine yönelik bir araştırma. *Söke işletme fakültesi priene uluslararası sosyal bilimler dergisi*, 1(1), 11-22.
- Katz, D., & Kahn, R. L. (1978). *The social psychology of organizations* (Vol. 2, p. 528). New York: Wiley.
- Li, M., & Wang, Z. (2016). Emotional labour strategies as mediators of the relationship between public service motivation and job satisfaction in Chinese teachers. *International journal of psychology*, 51(3), 177-184.
- Liao, H., Toya, K., Lepak, D. P., & Hong, Y. (2009). Do they see eye to eye? Management and employee perspectives of high-performance work systems and influence processes on service quality. *Journal of applied psychology*, 94(2), 371.
- Mael, F., & Ashforth, B. E. (1992). Alumni and their alma mater: A partial test of the reformulated model of organizational identification. *Journal of organizational Behavior*, 13(2), 103-123.
- Marquardt, M. J. (1996). *Building the learning organization: A systems approach to quantum improvement and global success*. McGraw-Hill Companies.
- Mavi, Y. & Yeşil, S. (2021). Covid-19 korkusu'nun duygusal emek, çalışan performansı, iş tatmini, yaşam doyumu üzerine etkisi: bir alan araştırması. *Yaşar Üniversitesi e-dergisi*, 16 (63), 1078-1104.
- Meyer, J. P., Stanley, D. J., Herscovitch, L., & Topolnytsky, L. (2002). Affective, continuance, and normative commitment to the organization: A meta-analysis of antecedents, correlates, and consequences. *Journal of vocational behavior*, 61(1), 20-52.
- Nishii, L. H., & Mayer, D. M. (2009). Do inclusive leaders help to reduce turnover in diverse groups? The moderating role of leader-member exchange in the diversity to turnover relationship. *Journal of Applied Psychology*, 94(6), 1412.
- Potipiroon, W., Srisuthisa-ard, A., & Faerman, S. (2019). Public service motivation and customer service behaviour: Testing the mediating role of emotional labour and the moderating role of gender. *Public management review*, 21(5), 650-668.
- Parker, S. K., Williams, H. M., & Turner, N. (2006). Modeling the antecedents of proactive behavior at work. *Journal of applied psychology*, 91(3), 636.
- Riketta, M. (2005). Organizational identification: A meta-analysis. *Journal of vocational behavior*, 66(2), 358-384.
- Saks, A. M., & Ashforth, B. E. (2000). The role of dispositions, entry stressors, and behavioral plasticity theory in predicting newcomers' adjustment to work. *Journal of organizational behavior*, 21(1), 43-62.
- Seçilmiş, C., Kodaş, & Kodaş, D. (2017). Örgütsel öğrenme yeteneği ve yaratıcılık süreci ilişkisi: Eskişehir'deki mutfak çalışanları üzerine bir araştırma. *Journal of tourism and gastronomy studies*, 5(3), 150-167.
- Shin, S. J., & Zhou, J. (2007). When is educational specialization heterogeneity related to creativity in research and development teams? Transformational leadership as a moderator. *Journal of applied Psychology*, 92(6), 1709.
- Trim, P. R., & Lee, Y. I. (2004). Enhancing customer service and organizational learning through qualitative research. *Qualitative Market Research: An International Journal*.
- Van Jaarsveld, D. D., Walker, D. D., & Skarlicki, D. P. (2010). The role of job demands and emotional exhaustion in the relationship between customer and employee incivility. *Journal of management*, 36(6), 1486-1504.
- Wu, X., Shie, A. J., & Gordon, D. (2017). Impact of customer orientation on turnover intention: Mediating role of emotional labour. *International journal of organizational analysis*, 25(5), 909-927.
- Zhang, A. Y., Tsui, A. S., & Wang, D. X. (2011). Leadership behaviors and group creativity in Chinese organizations: The role of group processes. *The leadership quarterly*, 22(5), 851-862.

**Cite this article:** Uludağ, D., Soyer, M., Mert, M. (2023). The Mediating Role of Emotional Labor in Linking Organizational Learning and Organizational Identification in the Aviation Industry. *Journal of Aviation*, 7(2), 262-271.



This is an open access article distributed under the terms of the Creative Commons Attribution 4.0 International Licence

**Copyright © 2022 Journal of Aviation** <https://javsci.com> - <http://dergipark.gov.tr/jav>

# Measurement of Process-Performances of Turkish Airports Using Network Data Envelopment Analysis

Miraç Eren<sup>1</sup> , Murat Ahmet Doğan<sup>2\*</sup> 

<sup>1</sup>Ondokuz Mayıs University, Economics Department, 55139, Atakum, Samsun, Türkiye. (mirac.eren@omu.edu.tr)

<sup>2\*</sup>Samsun University, Aviation Management Department, Samsun, Türkiye. (muratahmet.dogan@samsun.edu.tr)

## Article Info

Received: 12 May 2023

Revised: 17 June 2023

Accepted: 21 June 2023

Published Online: 09 July 2023

### Keywords:

Türkiye's Airports

Performance

Network Data Envelopment

DEA

Efficiency

Benchmarking

Corresponding Author: *Murat Ahmet Doğan*

## RESEARCH ARTICLE

<https://doi.org/10.30518/jav.1296416>

## Abstract

The air transportation industry is continuously broadening by adding new airports operating with huge investments. Hence, increasing efficiency and productivity in this industry is becoming critical. At the same time, efficiency calculations are also an important tool used to identify weaknesses and contribute to the improvement of the performance of enterprises. Nevertheless, Classic DEA models are commonly insufficient to determine the efficiency of a system due to ignorance of its internal structure and the treatment of the system as a black box. Therefore, if a production system can be divided into subprocesses by using network DEA model, the results will be more plausible and satisfying. Within this scope, this paper aims to evaluate the efficiencies of 39 out of 56 airports in Türkiye from 2015 to 2019. The results indicate that less-populated airports managed by private entrepreneurs are more efficient than others. Moreover, another characteristic of these efficient airports is that they are both domestically and internationally preferred for leisure trips.

## 1. Introduction

Globalization has increased economic activity all around the world. This was implemented first by preferring road transport, then sea transport, and finally air transport. The development of technology has provided a contribution to change this preference. All these developments have contributed to the rapid growth of the industry in Türkiye, as in many other countries. However, significant developments in passenger and freight transportation have been recorded in the transportation sector. In addition, the development of industrialization, population growth, and urbanization contribute to the increase in economic activities and make it easier for people to travel for touristic purposes. All these factors allow for the steady development of transport demand. In this progression, the preference for air travel for traveling to nearby or distant countries in personal or group leisure and business travel has a share.

The deregulation process of the aviation industry has led both airlines and airports into a more competitive and dynamic market. This movement started in America and then expanded to other countries. Before COVID-19, the global air transport industry contributed 4.1% of worldwide GDP in revenue and supported over 85 million worldwide jobs (ATAG, 2020). In the last five years, the air transport industry has contributed an average of 7 percent of revenue to Türkiye's GDP (TUIK,

2020). This acceleration was provided by completing the deregulation of Türkiye's air transport industry, which was started in the 1980s. After 2003, Türkiye's aviation industry, especially passenger and cargo transportation as shown in Figure-1. Cargo traffic is primarily based on Istanbul airports. Passenger traffic is also influenced by dense economic activity and tourist destinations.

The Directorate-General of the State Airports Enterprise (DHMI) is the authority to enforce the rules, manage and control the Turkish airports, which are 56 (green-point in Figure-2) as of 2021. Figure-2 shows the actual active commercial airports in Türkiye. Most of them are being managed by the public authority (DHMI), some of them (such as Istanbul, Ankara, İzmir, Antalya, Alanya, Bodrum, Dalaman) are being managed by private entrepreneurs.

The air transport sector is constantly expanding with new airports (Bloomberg, 2021). Therefore, governments are always trying to develop policies to improve the efficiency of airport operations. The quantitative description of efficiency is a comparison of the inputs used and the outputs realized. They use some methodologies to rate performance in air transport to help public authorities determine whether some airports can be considered more efficient than others (Stichhauerova & Pelloneova, 2019).



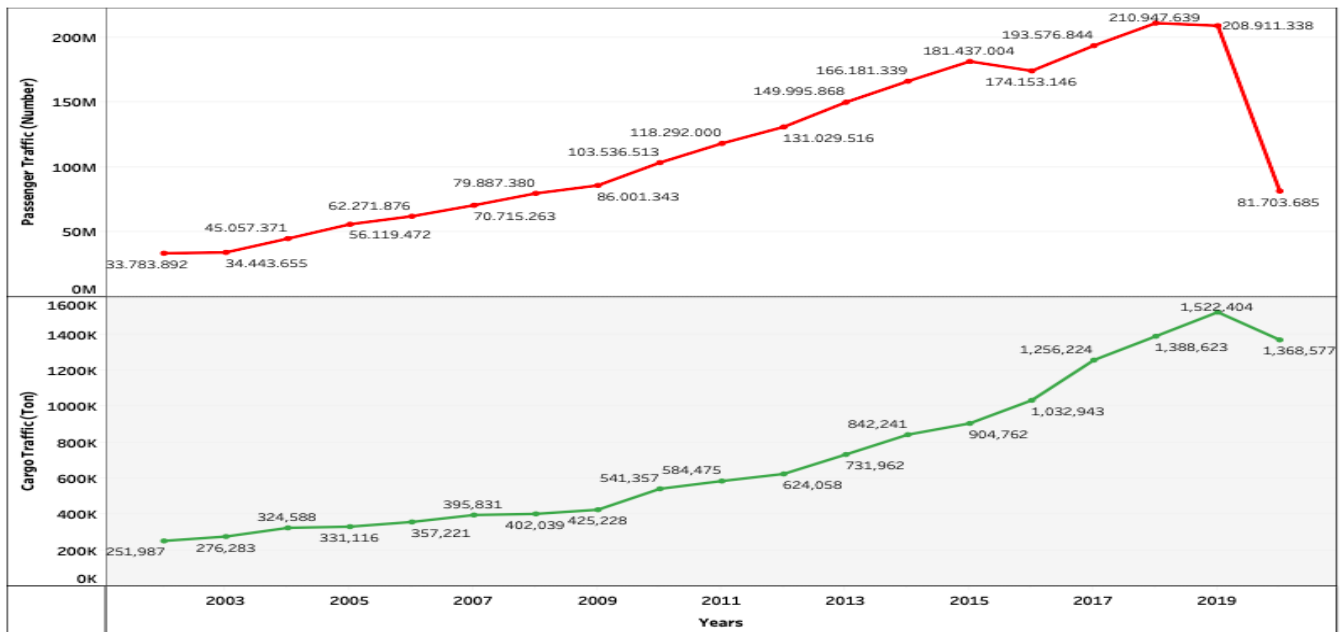


Figure 1. Turkish Airports Total Traffic (DHMI, 2020)

This study aims to evaluate the efficiency of 39 airports in Türkiye (shown in yellow in Figure 2) between 2015 and 2019 using the Network DEA model. Out of the 56 total airports in Türkiye, 17 airports were not included in the study as their data were not available. The introduction is followed by a literature review focusing on the use of DEA and other techniques in the evaluation of airport efficiency. Then, the research methodology is presented, including the sample of airports that will be Finally, the results of the analyses are presented.



Figure 2. Active Turkish Commercial Airports in 2021 (own illustration)

## 2. Literature Review

Looking at overall economic and financial performance, industry figures generally show that the airport industry is achieving relatively high profit margins. One of the main questions with airport costs is whether economies of scale exist and whether unit costs decrease as output increases (Graham, 2018). From a cost perspective, a significant reason for the long-term concept of economies of scale is that airports tend to have a relatively high share of the fixed costs associated with the provision of infrastructure (runway and terminal) and certain services (security, safety) to be performed relatively independently of the traffic levels. Similarly, it can be assumed

that economies of scale may well exist due to a few disadvantageous factors for larger airports, such as the need to coordinate or replicate services and facilities efficiently. Especially in the case of multiple terminals, the shortage of cheap sources (land and labor), higher costs associated with reducing environmental impacts, and difficulties with ensuring adequate surface access to and from the airport pose significant challenges (Kamp et al., 2007). Furthermore, profit alone cannot be a robust and comprehensive indicator of true economic performance. Therefore, one of the most popular airport economic empirical research areas is related to productivity and economic performance. Consequently, in the last two decades there has been considerable interest in the use of economic techniques to produce a single multidimensional measure of performance or efficiency. In general, three main methods have been used: total factor productivity (TFP), which is an average index number approach; the most popular is the data envelopment analysis (DEA) method, which relates a weighted input index to a weighted output index using a linear programming technique (Graham, 2018).

In this perspective, applied studies were represented with these methods Barros (2008); Bazargan and Vasigh (2003); Fung et al. (2008); Gillen and Lall (1997); Hooper and Hensher (1997); Lin and Hong (2006); Pathomsiri et al. (2008); Pels et al. (2001); Sarkis (2000); Yoshida (2004). In addition to these studies, in the last decade, some selected studies are represented in Table-2. This selection was made to show different regions' studies with contemporary methods. While the earliest studies used the classic DEA approach to analyze airports, current studies focus on new techniques with DEA (Lee & Kim, 2018; lo Storto, 2018; Merkert & Mangia, 2014; Olfat et al. 2016; Pacagnella Junior et al., 2020). In this context, this study presents a new technique for Türkiye's airport efficiency measurement firstly. Consequently, existing research has classified the service process or stage as having serial, parallel, or interrelated stages. The common feature of all these approaches is that each process stage has its own inputs and outputs and operates at a more acceptable level, allowing for intermediate flows between processes (Lozano et al., 2009). In other words, this approach can reveal the efficiency losses between processes more clearly. Moreover,

this study shows inefficiencies that the management team at airports in Türkiye should be aware of and pay more attention to. It also enables the inclusion of external factors in the modeling. Another contribution of this study is the first-time application of population as an exogenous factor for Turkish airports.

Application of new DEA models and the operational variables, environmental variables, or factors (such as population, GDP, GDP per Capita) can affect the efficiency score of airports (Lozano et al., 2009; Merkert & Mangia, 2014). However, a few studies considered these environmental factors to the airports' efficiencies (Chi-Lok & Zhang, 2009; Ha et al., 2013; Tsui et al., 2014; Yu, 2010). Considering the region examined by this study, it is seen that two-stage network data envelopment analysis was not performed by taking environmental factors into account. In addition to this, the

study shows the differences in efficiency scores as an efficiency gap between private and publicly operated airports in Türkiye.

### 3. Materials and Methods

#### 3.1. Data

The dataset was collected from DHMI's annual reports between 2015 and 2019 (DHMI, 2015, 2016, 2017, 2018, 2019). The available airports (yellow) are shown in Figure 2. In addition, 17 airports were not included in the sample because the required quantitative data was not available. Table 1 shows the data categorization and fully explains the variables, with referenced studies explaining why these variables were selected.

**Table 1.** Efficiency Data Classification

Input/Output	Variables	Explanation	Resources
4	Runway (m <sup>2</sup> )	The total area of ground on which aircraft take off and land in the airport	Olfat et al. (2016)
	Apron (m <sup>2</sup> )	The total area of tarmac in an airport, outside a hangar for parking aircraft	Lozano et al. (2009)
	Terminal (m <sup>2</sup> )	The total area of departure and arrival building at an airport	Lozano et al. (2013)
	Employees	Number of people employed in an airport	Merkert and Mangia (2014)
Intermediate Outputs	Terminal Capacity	The total capacity of departure and arrival building at an airport	Yu (2010)
	Runway Capacity	The total capacity of aircraft take off and land in the airport	
Environmental (Exogenous) Factor	Population	The people living in cities	Ha et al. (2013)
	Air Traffic	Total number of aircraft's takeoff and landing from the airport	Wanke and Barros (2017)
Outputs	Passenger Traffic	Total number of passengers who arrive and depart from the airport	Pathomsiri et al. (2008)

Turkish airports are managed both privately and publicly. For this reason, the number of employees can vary considerably. Since there is no access to the number of staff at public and privately operated airports, an assumption has been made on the number of staff. With this assumption; the number of employees is based on DHMI employee numbers for each airport. With this assumption, it is considered that the personnel structure can be considered homogenous at each airport.

#### 3.2. Network Data Envelopment Analysis

DEA has been extensively performed to evaluate the relative effectiveness of decision-making units (DMUs). This is applied to the same inputs to produce the same outputs since Charnes et al. (1978). It is indicated that each DMU performs efficiently. It is calculated for converting inputs to outputs compared to other DMUs. While reducing inputs or increasing output will improve their performance, an issue of more significant concern to inefficient DMUs is what factors cause inefficiency (Kao & Hwang, 2010). To solve this problem, much effort has been devoted to breaking down overall efficiency into components to identify sources of inefficiency (Banker et al., 1984). With the studies of Färe & Grosskopf (1996) and Seiford & Zhu (1999), the production process was divided into sub-processes. A model of two studies Kao (2014) and Kao & Hwang (2010) is applied to measure Turkish airports within this framework. This network DEA model is input-oriented and constant to return scale (CRS). Therefore, the results will be the same when the constant return scale (CRS) and the variable return scale (VRS) are applied to the

model. This model generalizes the relational two-stage structure that allows both stages to consume an exogenously supplied input and produce final outputs, as shown in Figure 3.

Network DEA Model:

$$E_k = \max \sum_{r=1}^s U_r \times Y_{r0}$$

*i: inputs (i = 1, ..., m)*  
*r: outputs (r = 1, ..., s)*  
*l: intermediate outputs (l = 1, ..., t)*  
*p: process (p = 1, ..., q)*  
*j: DMU (j = 1, ..., n)*

Subjects to:

$$\sum_{i=1}^m U_i \times X_{i0} = 1$$

$$\sum_{r=1}^s U_r \times Y_{rj} - \sum_{i=1}^m U_i \times X_{ij} \leq 0, \quad j = 1, \dots, n$$

$$\left\{ \sum_{r \in O^p} U_r \times Y_{rj}^p + \sum_{l \in M^p} w_l \times Z_{lj}^p \right\} - \left\{ \sum_{i \in I^p} U_i \times X_{ij}^p + \sum_{l \in M^{(p-1)}} w_l \times Z_{lj}^{(p-1)} \right\} \leq 0,$$

$$j = 1, \dots, n, p = 1, \dots, q$$

$$U_r, U_i, W_l \geq \varepsilon$$

$$r = 1, \dots, s; i = 1, \dots, m; l = 1, \dots, t$$

$$E_0^p = \left( \sum_{r \in O^p} U_r^* \times Y_{rj}^p + \sum_{l \in M^p} W_l^* \times Z_{lj}^p \right) \div \left( \sum_{i \in I^p} U_i^* \times X_{ip}^p + \sum_{l \in M^{(p-1)}} w_l \times Z_{lj}^{(p-1)} \right)$$

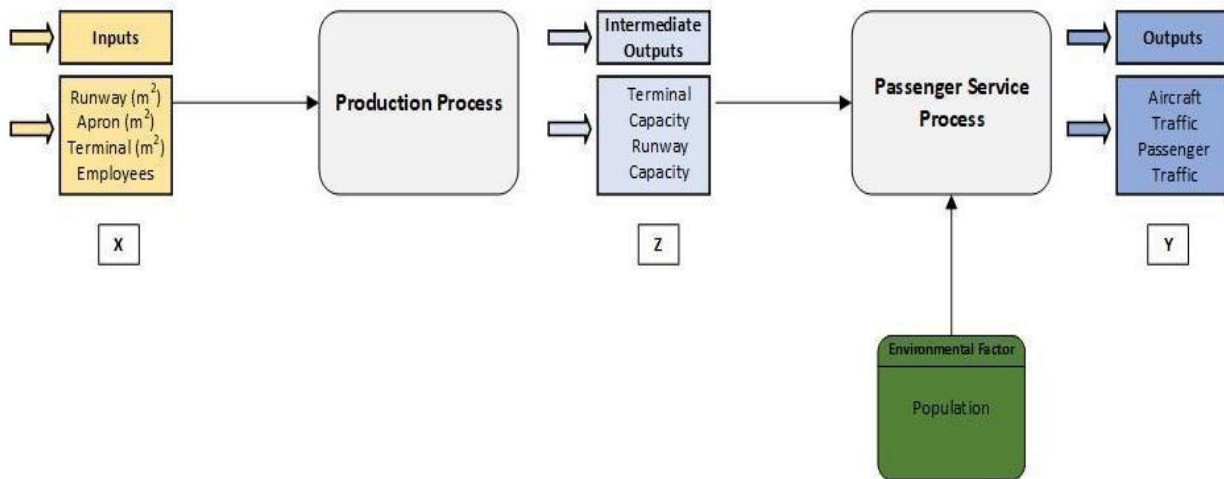


Figure 3. Network DEA Flow Chart with Environmental (Exogenous) Factor (own illustration)

#### 4. Findings

The Network DEA model was solved via version 28.4 of The General Algebraic Modeling System (GAMS) software

system, a high-level modeling system for mathematical optimization. The results obtained are as follows:

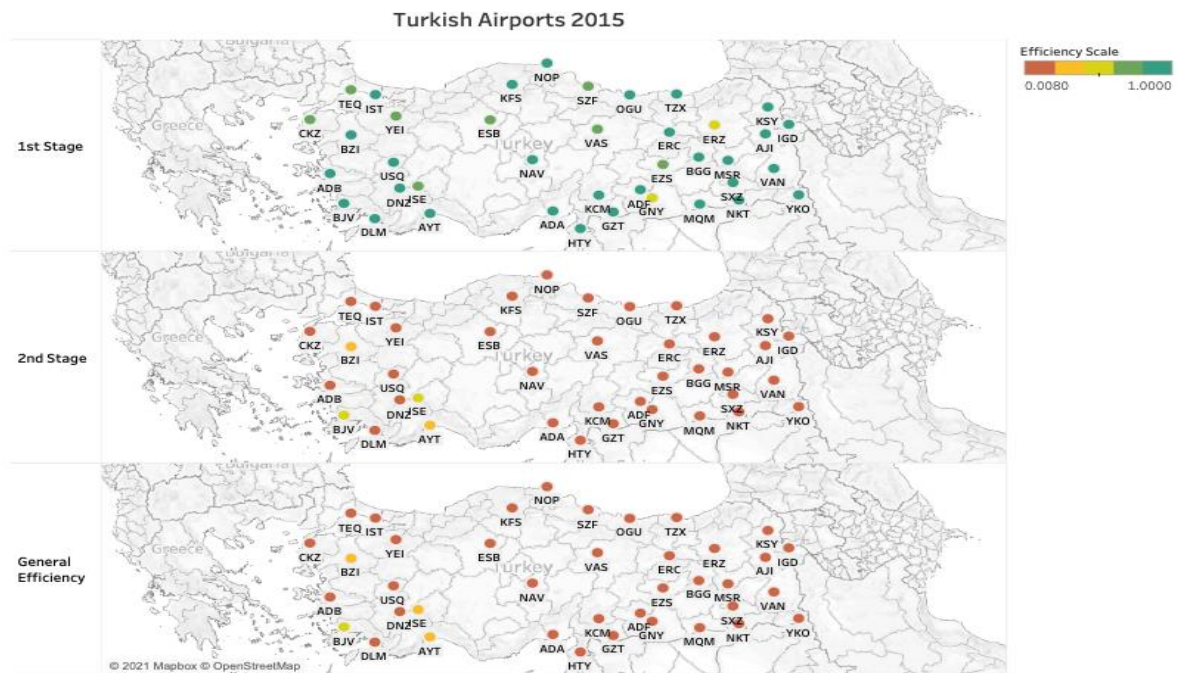


Figure 4. 2015 Network DEA Results (own illustration)



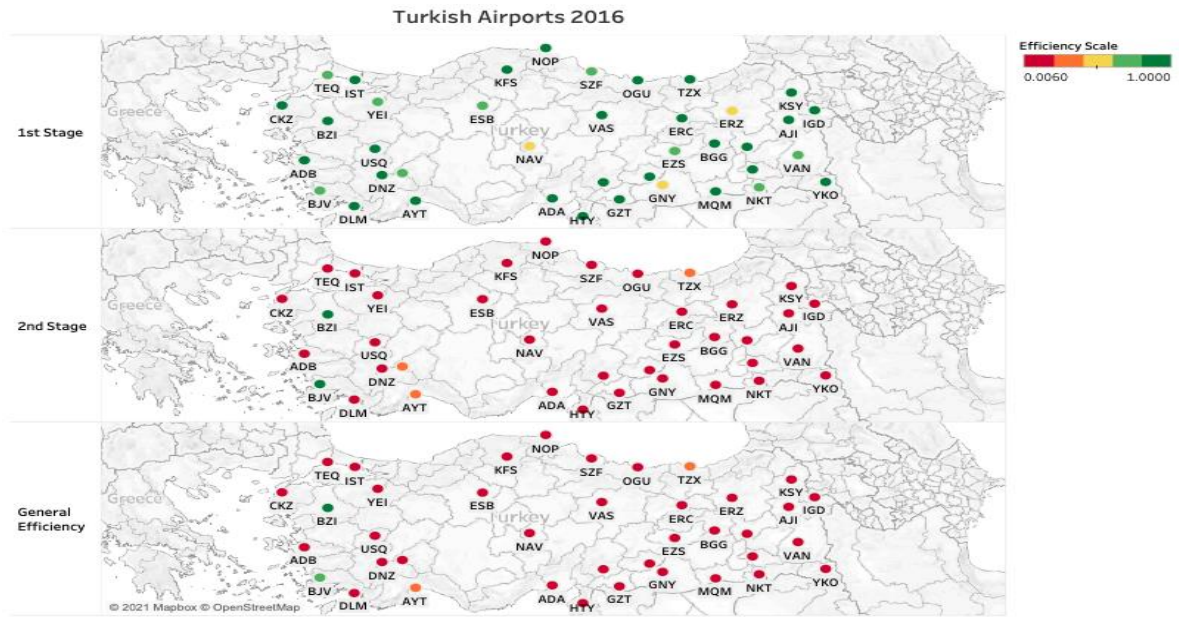


Figure 5. 2016 Network DEA Results (own illustration)



Figure 6. 2017 Network DEA Results (own illustration)

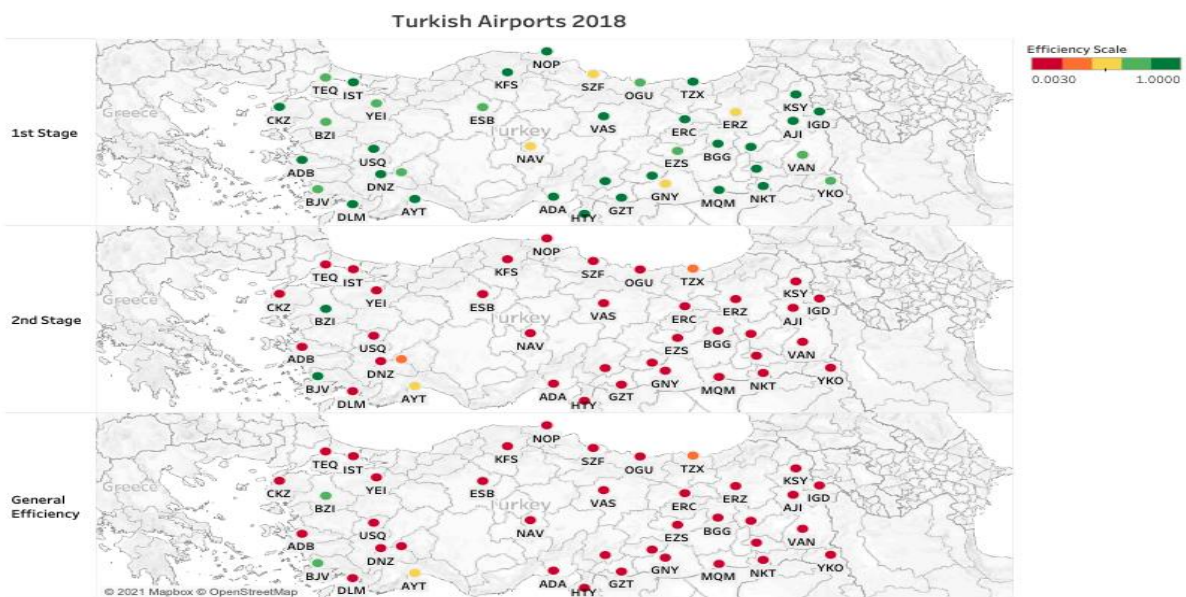


Figure 7. 2018 Network DEA Results (own illustration)



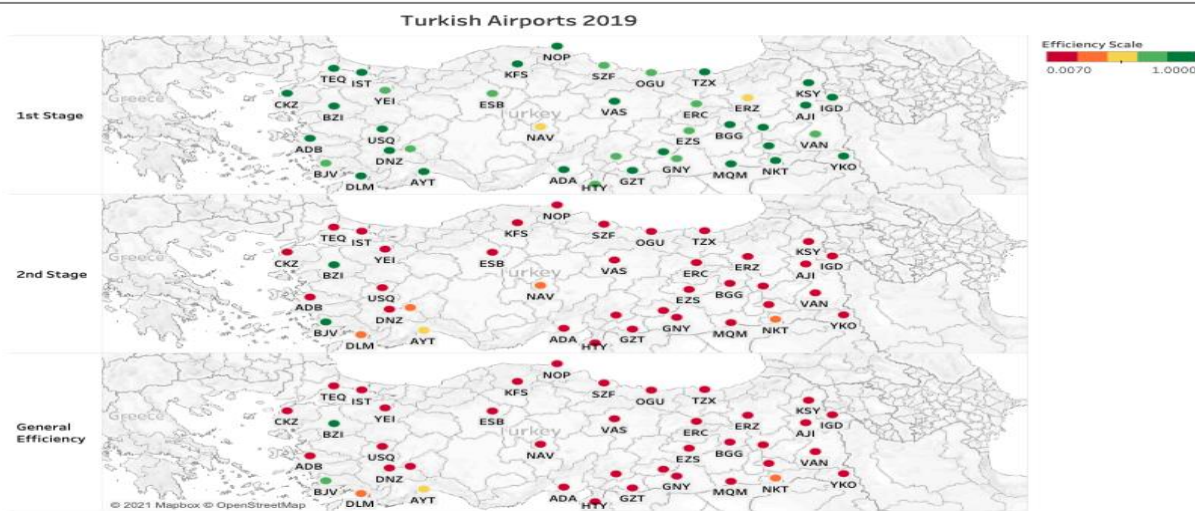


Figure 8. 2019 Network DEA Results (own illustration)

The model results are colored using an efficiency scale and shown on a map of Türkiye with airports from Figure 4 to Figure 8. In addition, the full results of the model are given in the appendix. Airports in densely populated areas are more efficient than those in less densely populated areas, according to Örcü et al. (2016). However, this study shows that less populated airports such as BZI (Balıkesir Koca Seyit) and BJV (Milas-Bodrum) may be more efficient than others. Moreover, these airports are efficient in all phases of the different study periods. Tourism seems to have a significant impact on this result. Because both domestic and international airports are preferred for leisure travel. However, other airports with the same characteristics, such as AYT (Antalya) and DLM (Dalaman) are not efficient in this period. Moreover, it has

been observed that airports also have an impact on the efficiency of the managers who manage them. Therefore, in this study, a two-dimensional plot graph is used to reveal the relationship between efficiency and management type (public or private). The plot is shown in Figure 9. The percentage of efficiency disclosed for each airport can be used to interpret both dimensions. The further an airport of a given size is from zero, the more critical that stage is for efficiency. In other words, it is desirable that the coordination efficiency score is closest to the perfect coordinate (1,1). A cursory glance at Figure 9 reveals that private entrepreneurs (except ESB-Ankara) are more efficient than airports controlled by public authorities.

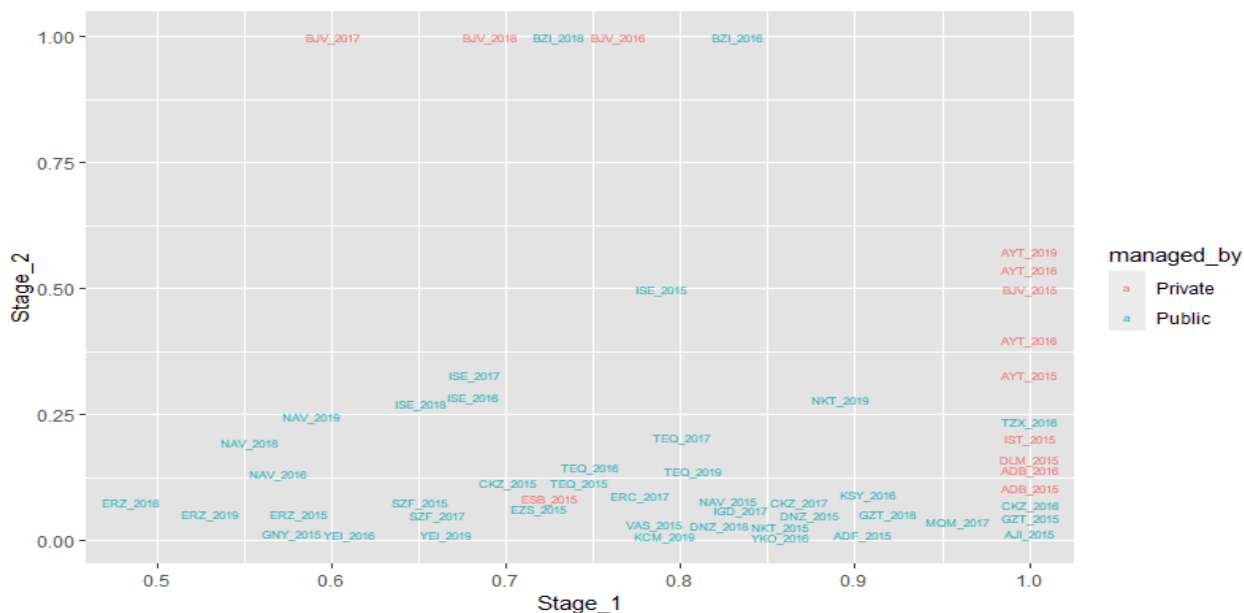


Figure 9. Efficiency Distribution of Airports by Management Type

### 5. Conclusion

Classical DEA models, which ignore its internal structure and treat the system as a black box, are usually used to determine the efficiency of a system. However, efficiency calculations aim to identify areas of weakness so that reasonable efforts can be made to improve performance. Therefore, when a

production system can be divided into two sub-processes, more satisfactory results can be obtained in the analysis. In summary, more informative results can be obtained if the interactions of the processes within the system are taken into account. In order to avoid the possibility of multiple solutions that would distort the comparison, the efficiency of the first sub-process is maximized in a second stage under the

constraint of keeping the overall efficiency score at the same level. In this model, the overall efficiency is the product of the efficiencies of the two subprocesses. This mathematical relationship between overall efficiency and component efficiencies appropriately captures the expectations of the overall process and the relationship between the two subprocesses.

For this purpose, 39 Turkish airports are analyzed in two stages of network DEA in this study. This is the first study to measure Turkish airports together with environmental factors in a two-stage network DEA. The population variable is an environmental factor that is analyzed to see how it affects airport efficiency. The results showed that this factor positively affects the efficiency score of airports with tourist attractions. According to this result, it is considered that future research would be useful to evaluate the extent to which environmental factors affect the efficiency of airports. In addition, the plot graph provides convincing evidence of the link between efficiency and management type at airports in Türkiye. When airports managed by the public and private sectors are compared, the private sector is more efficient. In conclusion, this study represents a new approach to determining the efficiency of airports in Türkiye. Globally, the environmental impacts of aviation are both evaluated and studies are being carried out by international and national authorities to take precautions. In future studies, the network model in this study or a new stage network model approach and other environmental factors can be taken into account to evaluate the issue in different dimensions. Environmental considerations should be investigated both globally and locally.

#### Ethical approval

Not applicable.

#### Conflicts of Interest

The authors declare that there is no conflict of interest regarding the publication of this paper.

#### Acknowledgement

Both authors have contributed equally to the paper. Both authors read and approved the final manuscript.

#### References

- Abbott, M. (2015). Reform and efficiency of New Zealand's airports. *Utilities Policy*, 36, 1-9.
- Asker, V. (2016). The measurement of airports operational effectiveness: an application of the major 10 airports in Turkey. *Transport & Logistics*, 16(41).
- Asker, V., & Battal, Ü. (2017). Operational efficiency measurement at selected airports. *Uluslararası Yönetim İktisat ve İşletme Dergisi*, 13(13), 351-368.
- Asker, V., & Yaşar, M. (2018). Measurement of efficiency with Data Envelopment Analysis and Malmquist Total Factor Productivity methods: An application on major airports in Turkey. *Transport & Logistics: the International Journal*, 45, 18.
- ATAG. (2020). A Global Industry, Driving Sustainable Development. [https://aviationbenefits.org/media/167517/aw-oct-final-atag\\_abb-2020-publication-digital.pdf](https://aviationbenefits.org/media/167517/aw-oct-final-atag_abb-2020-publication-digital.pdf)
- Baltazar, M. E., Jardim, J., Alves, P., & Silva, J. (2014). Air transport performance and efficiency: MCDA vs. DEA approaches. *Procedia-Social and Behavioral Sciences*, 111, 790-799.
- Banker, R. D., Charnes, A., & Cooper, W. W. (1984). Some models for estimating technical and scale inefficiencies in data envelopment analysis. *Management Science*, 30(9), 1078-1092.
- Barros, C. P., & Dieke, P. U. (2007). Performance evaluation of Italian airports: A data envelopment analysis. *Journal of Air Transport Management*, 13(4), 184-191.
- Barros, C. P. (2008). Airports in Argentina: Technical efficiency in the context of an economic crisis. *Journal of Air Transport Management*, 14(6), 315-319.
- Bazargan, M., & Vasigh, B. (2003). Size versus efficiency: a case study of US commercial airports. *Journal of Air Transport Management*, 9(3), 187-193.
- Bloomberg. (2021). Retrieved 27.12.2021 from <https://www.bloomberght.com/karaismailoglu-havalimani-sayisi-gelecek-yil-56-dan-61-e-cikacak-2295298>
- Chang, Y.-T., Park, H. K., Zou, B., & Kafle, N. (2016). Passenger facility charge vs. airport improvement program funds: A dynamic network DEA analysis for US airport financing. *Transportation Research Part E: Logistics and Transportation Review*, 88, 76-93.
- Charnes, A., Cooper, W. W., & Rhodes, E. (1978). Measuring the efficiency of decision-making units. *European journal of operational research*, 2(6), 429-444.
- Chi-Lok, A. Y., & Zhang, A. (2009). Effects of competition and policy changes on Chinese airport productivity: An empirical investigation. *Journal of Air Transport Management*, 15(4), 166-174.
- DHMI. (2015). DHMI Annual Report 2015. [https://www.dhmi.gov.tr/Lists/AnnualReports/Attachments/9/Annual\\_Report\\_2015\\_site.pdf](https://www.dhmi.gov.tr/Lists/AnnualReports/Attachments/9/Annual_Report_2015_site.pdf)
- DHMI. (2016). DHMI Annual Report 2016. [https://www.dhmi.gov.tr/Lists/AnnualReports/Attachments/10/Annual\\_Report\\_2016.pdf](https://www.dhmi.gov.tr/Lists/AnnualReports/Attachments/10/Annual_Report_2016.pdf)
- DHMI. (2017). DHMI Annual Report 2017. [https://www.dhmi.gov.tr/Lists/AnnualReports/Attachments/11/Annual\\_Report\\_2017.pdf](https://www.dhmi.gov.tr/Lists/AnnualReports/Attachments/11/Annual_Report_2017.pdf)
- DHMI. (2018). DHMI Annual Report 2018. [https://www.dhmi.gov.tr/Lists/AnnualReports/Attachments/12/DHMI\\_2018\\_Annual\\_Report.pdf](https://www.dhmi.gov.tr/Lists/AnnualReports/Attachments/12/DHMI_2018_Annual_Report.pdf)
- DHMI. (2019). DHMI Annual Report 2019. <https://www.dhmi.gov.tr/Lists/AnnualReports/Attachments/13/2019.pdf>
- DHMI. (2020). <https://www.dhmi.gov.tr/Sayfalar/EN/Statistics.aspx>
- Färe, R., & Grosskopf, S. (1996). Productivity and intermediate products: A frontier approach. *Economics Letters*, 50(1), 65-70.
- Fragoudaki, A., Giokas, D., & Glyptou, K. (2016). Efficiency and productivity changes in Greek airports during the crisis years 2010–2014. *Journal of Air Transport Management*, 57, 306-315.
- Fung, M. K. Y., Wan, K. K. H., Van Hui, Y., & Law, J. S. (2008). Productivity changes in Chinese airports 1995–2004. *Transportation Research Part E: Logistics and Transportation Review*, 44(3), 521-542.
- Gillen, D., & Lall, A. (1997). Developing airport productivity and performance measures: an application of data envelopment analysis. *Transportation Research Part E: Logistics and Transportation Review*, 33(4), 261-273.

- Graham, A. (2018). Airport economics and finance. In *The Routledge Companion to Air Transport Management* (pp. 189-205). Routledge.
- Gutiérrez, E., & Lozano, S. (2016). Efficiency assessment and output maximization possibilities of European small and medium-sized airports. *Research in Transportation Economics*, 56, 3-14.
- Güner, S., Cebeci, H. İ., Antunes, J. J. M., & Wanke, P. F. (2021). Sustainable efficiency drivers in Eurasian airports: Fuzzy NDEA approach based on Shannon's entropy. *Journal of Air Transport Management*, 92, 102039.
- Ha, H.-K., Wan, Y., Yoshida, Y., & Zhang, A. (2013). Airline market structure and airport efficiency: Evidence from major Northeast Asian airports. *Journal of Air Transport Management*, 33, 32-42.
- Hong, S.-J., & Jeon, M. (2019). The technical efficiency of French regional airports and low-cost carrier terminals. *Sustainability*, 11(18), 5107.
- Hooper, P. G., & Hensher, D. A. (1997). Measuring total factor productivity of airports—an index number approach. *Transportation Research Part E: Logistics and Transportation Review*, 33(4), 249-259.
- Kamp, V., Niemeier, H.-M., & Müller, J. (2007). What can be learned from benchmarking studies? Examining the apparent poor performance of German airports. *Journal of Airport Management*, 1(3), 294-308.
- Kao, C. (2014). Network data envelopment analysis: A review. *European journal of operational research*, 239(1), 1-16.
- Kao, C., & Hwang, S.-N. (2008). Efficiency decomposition in two-stage data envelopment analysis: An application to non-life insurance companies in Taiwan. *European journal of operational research*, 185(1), 418-429.
- Kao, C., & Hwang, S.-N. (2010). Efficiency measurement for network systems: IT impact on firm performance. *Decision Support Systems*, 48(3), 437-446.
- Keskin, B., & Köksal, C. D. (2019). A hybrid AHP/DEA-AR model for measuring and comparing the efficiency of airports. *International Journal of Productivity and Performance Management*.
- Koçak, H. (2011). Efficiency examination of Turkish airports with DEA approach. *International Business Research*, 4(2), 204.
- Lee, M. J., & Kim, C. (2018). A network DEA aeronautical and non-aeronautical production model: an application to South Korea airports. *Journal of Economic Structures*, 7(1), 1-12.
- Lin, L., & Hong, C. (2006). Operational performance evaluation of major international airports: An application of data envelopment analysis. *Journal of Air Transport Management*, 12(6), 342-351.
- Lo Storto, C. (2018). The analysis of the cost-revenue production cycle efficiency of the Italian airports: A NSBM DEA approach. *Journal of Air Transport Management*, 72, 77-85.
- Lozano, S., Gutiérrez, E., & Moreno, P. (2013). Network DEA approach to airports performance assessment considering undesirable outputs. *Applied Mathematical Modelling*, 37(4), 1665-1676.
- Lozano, S., Gutiérrez, E., & Salmerón, J. L. (2009). Network DEA models in transportation. Application to airports. German Aviation Research Society Seminar on Airport Benchmarking,
- Lu, W., Park, S. H., Huang, T., & Yeo, G. T. (2019). An analysis for Chinese airport efficiency using weighted variables and adopting CFPR. *The Asian Journal of Shipping and Logistics*, 35(4), 230-242.
- Merkert, R., & Mangia, L. (2014). The efficiency of Italian and Norwegian airports: A matter of management or the level of competition in remote regions? *Transportation Research Part A: Policy and Practice*, 62, 30-38.
- Ngo, T., & Tsui, K. W. H. (2020). A data-driven approach for estimating airport efficiency under endogeneity: An application to New Zealand airports. *Research in Transportation Business & Management*, 34, 100412.
- Olfat, L., Amiri, M., Soufi, J. B., & Pishdar, M. (2016). A dynamic network efficiency measurement of airports performance considering sustainable development concept: A fuzzy dynamic network-DEA approach. *Journal of Air Transport Management*, 57, 272-290.
- Örkcü, H. H., Balıkcı, C., Dogan, M. I., & Genç, A. (2016). An evaluation of the operational efficiency of Turkish airports using data envelopment analysis and the Malmquist productivity index: 2009–2014 case. *Transport Policy*, 48, 92-104.
- Özsoy, V. S., & Örkcü, H. H. (2021). Structural and operational management of Turkish airports: a bootstrap data envelopment analysis of efficiency. *Utilities Policy*, 69, 101180.
- Pacagnella Junior, A. C., Hollaender, P. S., Mazzanati, G. V., & Bortoletto, W. W. (2020). Infrastructure and Flight Consolidation Efficiency of Public and Private Brazilian International Airports: A Two-Stage DEA and Malmquist Index Approach. *Journal of Advanced Transportation*, 2020.
- Pathomsiri, S., Haghani, A., Dresner, M., & Windle, R. J. (2008). Impact of undesirable outputs on the productivity of US airports. *Transportation Research Part E: Logistics and Transportation Review*, 44(2), 235-259.
- Pels, E., Nijkamp, P., & Rietveld, P. (2001). Relative efficiency of European airports. *Transport Policy*, 8(3), 183-192.
- Ripoll-Zarraga, A. E., & Mar-Molinero, C. (2020). Exploring the reasons for efficiency in Spanish airports. *Transport Policy*, 99, 186-202.
- Sarkis, J. (2000). An analysis of the operational efficiency of major airports in the United States. *Journal of Operations Management*, 18(3), 335-351.
- Seiford, L. M., & Zhu, J. (1999). Profitability and marketability of the top 55 US commercial banks. *Management Science*, 45(9), 1270-1288.
- Song, K. H., Choi, S., & Han, I. H. (2020). Competitiveness Evaluation Methodology for Aviation Industry Sustainability Using Network DEA. *Sustainability*, 12(24), 10323.
- Stichhauerova, E., & Pelloneova, N. (2019). An efficiency assessment of selected German airports using the DEA model. *Journal of Competitiveness*, 11(1), 135-151.
- Tsui, W. H. K., Balli, H. O., Gilbey, A., & Gow, H. (2014). Operational efficiency of Asia-Pacific airports. *Journal of Air Transport Management*, 40, 16-24.
- TUIK.(2020). <https://data.tuik.gov.tr/Kategori/GetKategori?p=dis-ticaret-104&dil=1>
- Ülkü, T. (2015). A comparative efficiency analysis of Spanish and Turkish airports. *Journal of Air Transport Management*, 46, 56-68.

- Wanke, P., & Barros, C. (2017). Efficiency thresholds and cost structure in Senegal airports. *Journal of Air Transport Management*, 58, 100-112.
- Yoshida, Y. (2004). Endogenous-weight TFP measurement: methodology and its application to Japanese-airport benchmarking. *Transportation Research Part E: Logistics and Transportation Review*, 40(2), 151-182.
- Yu, M.-M. (2010). Assessment of airport performance using the SBM-NDEA model. *Omega*, 38(6), 440-452.

---

**Cite this article:** Eren, M., Doğan, M.A. (2023). Measurement of Process-Performances of Turkish Airports Using Network Data Envelopment Analysis. *Journal of Aviation*, 7(2), 272-283.



This is an open access article distributed under the terms of the Creative Commons Attribution 4.0 International Licence

Copyright © 2023 **Journal of Aviation** <https://javsci.com> - <http://dergipark.gov.tr/jav>



Appendix

Table 2. Summary of Literature on Airport Efficiency Measurement

Source	Method	Sample Data	Input(s)	Output(s)
Barros and Dieke (2007)	DEA	Italian Airports	Labor costs, capital invested, and operational costs (excluding labor)	Number of planes and passengers, cargo, receipts of handling-aeronautical-commercial
Koçak (2011)	DEA	40 Turkish Airports	Operational expenses, number of personnel, annual flight traffic, number of passengers	Number of passengers/areas, total flight traffic/runway, total cargo traffic, operational revenues
Baltazar et al. (2014)	DEA&MCDA	3 Iberian Airports	Number of runways, aircraft parking stands, passenger and cargo terminal areas, number of boarding gates, check-in desks, baggage carousels	Aircraft movements, processed passengers and cargo
Merkert and Mangia (2014)	2 Stage DEA and Truncated Reg.	35 Italian and 45 Norwegian Airports	Terminal area, number of runways, runway area and length, apron area, total area, employees, operating cost, staff cost, material cost	Air traffic movements, passengers, cargo
Abbott (2015)	1 <sup>st</sup> stage: Malmquist DEA 2 <sup>nd</sup> stage: Benchmark	1 <sup>st</sup> stage 3 Major New Zealand's Airports, 2 <sup>nd</sup> stage 13 Airports	Runway length, operating expense	Aircraft and passenger movements, cargo
Ülkü (2015)	DEA	Spain and Turkish Airports	Staff costs, other operating costs, and runway area	Number of passengers and air traffic movements, cargo, and commercial revenue
Asker (2016)	DEA	10 Turkish Airports	Runway number, terminal field size, and check-in counter number	Passenger number and flight number
Chang et al. (2016)	2 Stage Dynamic Network DEA	41 US Airports	Aircraft movement, labor and materials costs, net asset, promotions	Flight delay, aircraft loading, and operations
Fragoudaki et al. (2016)	DEA-Malmquist Index	Greek Airports	Runway lengths, apron size, and passenger terminal size	Total aircraft movements and passengers, cargo
Gutiérrez and Lozano (2016)	DEA	21 Small and Medium European Airports	Runway size, boarding gates, apron stands, number of airlines, number of scheduled routes	Aircraft movements, passenger throughput, cargo handled
Olfat et al. (2016)	2 Scale Dynamic Network Fuzzy DEA	59 Iranian Airports	Policy concept, budget, social responsibility (link), number of taking off and landing aircraft (link), service quality (link), corporate reputation	Pollution levels, satisfaction, non-aviation income
Örkcü et al. (2016)	DEA-Malmquist Index	21 Turkish Airports	Number of runways, dimension of runway units, passenger terminal area	The annual number of flights, yearly passenger and cargo throughputs,
Asker and Battal (2017)	DEA	20 International Airports	Numbers of runway-airplanes-gates and size of terminal area	Total numbers of passengers and flights, total load

<b>Stichhauerova and Pelloneova (2019)</b>	DEA	27 German Airports	Number of employees, terminals, runways, the airport area, capacity, distance from city center	Number of passengers, aircraft movements, amount of cargo
<b>Asker and Yaşar (2018)</b>	DEA-Malmquist Index	19 Turkish Airports	Number of runway and gate, terminal size area, number of employee, and total expense	Total number of passengers and commercial flights, Freight, and total revenue
<b>Io Storto (2018)</b>	3 Stage Network-Slack Based DEA	38 Italian Airports	Soft operating expense, labor cost, terminal size, apron size, runways, employees, movements, passengers, cargo	Aviation and non-aviation revenues
<b>Wanke and Barros (2017)</b>	1 <sup>st</sup> stage: DEA 2 <sup>nd</sup> stage: Support Vector Machine Reg.	5 Senegal's Airport	Personnel, runway length, contextual variables (cost of labor-capital-operations, cargo operation, cost asset ratio)	Passengers, cargo, aircraft
<b>Lee and Kim (2018)</b>	Network DEA	14 South Korean Airports	1 <sup>st</sup> stage: Total capacity, duty-free store size, restaurant size, parking lot capacity, total workers, runway, terminal capacity 2 <sup>nd</sup> stage: Aircraft movement	Aeronautical and non-aeronautical revenues, cargo, passengers
<b>Hong and Jeon (2019)</b>	DEA-Malmquist Index	99 Regional French Airports	Employees, labor cost, debt, subsidization, operational cost	Passenger, cargo, movement, revenue, net profit
<b>Keskin and Köksal (2019)</b>	AHP/DEA-AR Model	48 Turkish Airports	Number of gates, employees, runways area, terminal area, operational expenditure	Aircraft movements, number of passengers, amount of cargo, total revenue
<b>Lu et al. (2019)</b>	Window DEA AR Model	27 Chinese Airports	Aircraft parking spaces, capital invested, number of air routes, boarding gate, runways, terminal area	Aircraft movements, cargo throughput, number of passengers
<b>Ngo and Tsui (2020)</b>	Window Slack Based Measure DEA and Tobit Model	11 New Zealand's Airports	Employee and Operating expenses, length of runways,	Aeronautical and non-aeronautical revenues, aircraft movements
<b>Pacagnella Junior et al. (2020)</b>	2 Stage DEA-Malmquist Index	33 Brazilian Airports	1 <sup>st</sup> stage: Terminal area, number of aircraft parking spaces, number of runways 2 <sup>nd</sup> stage: Number of landings take-offs	Number of passengers, cargo throughput
<b>Ripoll-Zarraga and Mar-Molinero (2020)</b>	DEA	49 Spanish Airports	Labor costs, operating costs, depreciation of airside assets	Passengers, air traffic movements, cargo, commercial revenues, % flights on time
<b>Song et al. (2020)</b>	Network DEA	56 Countries' Airports	1 <sup>st</sup> stage: Number of routes and airports, population, GDP, tourist attraction, HHI Index 2 <sup>nd</sup> stage: RPK, CTK, HHI Index	Amount of added value
<b>Güner et al. (2021)</b>	2 Stage Fuzzy Frontier Network DEA	23 Eurasian Airports	Runway lengths, terminal area, fuel, aircraft	Passengers, freight, environmental effect
<b>Özsoy and Örkücü (2021)</b>	2 Stage DEA and CART	43 Turkish Airports	Terminal sizes, car parking capacity, number of runways, number of equipment, employees	Air traffic movements, number of passengers, the volume of cargo

**Table 3.** Summary of Airport Efficiency Measurement

Years	2015			2016			2017			2018			2019		
	Airports	1. Stage	2. Stage	General Efficiency	1. Stage	2. Stage	General Efficiency	1. Stage	2. Stage	General Efficiency	1. Stage	2. Stage	General Efficiency	1. Stage	2. Stage
IST	1.000	0.204	0.204	1.000	0.203	0.203	1.000	0.200	0.200	1.000	0.187	0.187	1.000	0.046	0.046
ESB	0.725	0.085	0.062	0.728	0.121	0.088	0.729	0.136	0.099	0.728	0.125	0.091	0.754	0.099	0.075
ADB	1.000	0.105	0.105	1.000	0.142	0.142	1.000	0.140	0.140	1.000	0.128	0.128	1.000	0.115	0.115
AYT	1.000	0.328	0.328	1.000	0.400	0.400	1.000	0.513	0.513	1.000	0.538	0.538	1.000	0.575	0.575
DLM	1.000	0.162	0.162	1.000	0.167	0.167	1.000	0.186	0.186	1.000	0.194	0.194	1.000	0.225	0.225
BJV	1.000	0.500	0.500	0.764	1.000	0.764	0.601	1.000	0.601	0.691	1.000	0.691	0.694	1.000	0.694
ADA	1.000	0.089	0.089	1.000	0.126	0.126	1.000	0.119	0.119	1.000	0.104	0.104	1.000	0.091	0.091
TZX	1.000	0.150	0.150	1.000	0.237	0.237	1.000	0.247	0.247	1.000	0.205	0.205	1.000	0.189	0.189
ERZ	0.581	0.054	0.031	0.485	0.078	0.038	0.517	0.083	0.043	0.487	0.072	0.035	0.530	0.053	0.028
GZT	1.000	0.046	0.046	1.000	0.059	0.059	1.000	0.061	0.061	0.919	0.053	0.049	1.000	0.049	0.049
ADF	0.904	0.013	0.012	0.880	0.020	0.018	0.788	0.020	0.016	0.807	0.019	0.015	0.821	0.016	0.013
AJI	1.000	0.015	0.015	0.913	0.022	0.020	0.792	0.025	0.020	0.930	0.025	0.023	0.863	0.024	0.021
BZI	1.000	0.207	0.207	0.832	1.000	0.832	0.822	1.000	0.822	0.730	1.000	0.730	0.807	1.000	0.807
BGG	1.000	0.022	0.022	0.894	0.029	0.026	0.905	0.029	0.026	0.879	0.033	0.029	0.925	0.029	0.027
YEI	0.609	0.037	0.023	0.610	0.012	0.007	0.635	0.018	0.011	0.620	0.009	0.006	0.665	0.013	0.009
CKZ	0.701	0.115	0.081	1.000	0.071	0.071	0.868	0.077	0.067	0.821	0.071	0.058	0.888	0.055	0.049
DNZ	0.874	0.051	0.045	0.874	0.034	0.030	0.829	0.071	0.059	0.822	0.031	0.025	0.909	0.031	0.028
EZS	0.719	0.063	0.045	0.714	0.088	0.063	0.713	0.083	0.059	0.656	0.072	0.047	0.715	0.062	0.044
ERC	1.000	0.053	0.053	0.840	0.076	0.064	0.777	0.089	0.069	0.814	0.087	0.071	0.791	0.072	0.057
YKO	1.000	0.114	0.114	0.857	0.007	0.006	0.853	0.028	0.024	0.798	0.032	0.026	0.824	0.036	0.030
HTY	1.000	0.030	0.030	0.876	0.038	0.033	0.852	0.038	0.032	0.841	0.034	0.029	0.794	0.030	0.024
IGD	1.000	0.042	0.042	0.872	0.056	0.049	0.834	0.060	0.050	0.934	0.060	0.056	0.905	0.053	0.048
ISE	0.789	0.500	0.395	0.681	0.286	0.195	0.682	0.328	0.224	0.651	0.272	0.177	0.683	0.268	0.183
KCM	0.874	0.014	0.012	0.874	0.012	0.010	0.870	0.014	0.012	1.000	0.012	0.012	0.791	0.010	0.008
KSY	1.000	0.056	0.056	0.908	0.091	0.083	0.896	0.094	0.084	1.000	0.082	0.082	1.000	0.074	0.074
KFS	1.000	0.014	0.014	1.000	0.014	0.014	1.000	0.014	0.014	1.000	0.015	0.015	1.000	0.010	0.010
MQM	1.000	0.028	0.028	1.000	0.040	0.040	0.959	0.039	0.037	1.000	0.035	0.035	1.000	0.027	0.027
MSR	1.000	0.033	0.033	1.000	0.046	0.046	1.000	0.051	0.051	1.000	0.046	0.046	1.000	0.038	0.038
NAV	0.827	0.079	0.065	0.569	0.134	0.076	0.585	0.058	0.034	0.553	0.194	0.107	0.588	0.248	0.146
OGU	1.000	0.008	0.008	0.844	0.033	0.028	0.720	0.047	0.034	0.659	0.037	0.024	0.663	0.036	0.024
SZF	0.651	0.076	0.049	0.661	0.084	0.056	0.661	0.051	0.034	0.601	0.054	0.032	0.663	0.062	0.041
SXZ	1.000	0.038	0.038	1.000	0.028	0.028	1.000	0.007	0.007	1.000	0.003	0.003	1.000	0.007	0.007
NOP	1.000	0.040	0.040	1.000	0.022	0.022	1.000	0.042	0.042	1.000	0.058	0.058	1.000	0.047	0.047
VAS	0.785	0.033	0.026	0.843	0.045	0.038	0.781	0.043	0.034	0.817	0.037	0.030	0.810	0.034	0.028
GNY	0.577	0.015	0.009	0.569	0.020	0.011	0.589	0.020	0.012	0.545	0.017	0.009	0.654	0.014	0.009
NKT	0.857	0.029	0.025	0.780	0.029	0.023	0.840	0.032	0.027	0.824	0.033	0.027	0.891	0.280	0.249
TEQ	0.742	0.115	0.085	0.748	0.147	0.110	0.801	0.206	0.165	0.741	0.115	0.085	0.807	0.138	0.111
USQ	1.000	0.023	0.023	1.000	0.018	0.018	1.000	0.020	0.020	1.000	0.023	0.023	1.000	0.091	0.091
VAN	0.808	0.048	0.039	0.603	0.067	0.040	0.696	0.073	0.051	0.650	0.072	0.047	0.695	0.073	0.051

# Bibliometric Analysis of Academic Publications on Artificial Intelligence and Aviation Keywords with VOSviewer

Taha Utkan Uslu<sup>1\*</sup> , Birsen Açikel<sup>2</sup> 

<sup>1</sup>Eskisehir Technical University, Department of Civil Aviation, Eskisehir, Türkiye. (tahautkanusu@ogr.eskisehir.edu.tr)

<sup>2</sup>Eskisehir Technical University, Porsuk Vocational School/Department of Electronics and Automation/Drone Technology and Operations Pr, Eskisehir, Türkiye. (birsena@eskisehir.edu.tr)

## Article Info

Received: 07 May 2023  
Revised: 19 June 2023  
Accepted: 10 July 2023  
Published Online: 14 July 2023

### Keywords:

Artificial Intelligence  
Aviation  
VOSviewer  
Bibliometric Analysis

Corresponding Author: *Taha Utkan Uslu*

## RESEARCH ARTICLE

<https://doi.org/10.30518/jav.1293740>

## Abstract

This study seeks to show the distribution of academic studies relating to the keywords “artificial intelligence” and “aviation” by years, by authors, by countries, and by organizations using bibliometric data of scientific publications indexed in the Web of Science database between 2005-2023. In this direction, a total of 215 publications were analyzed and categorized in terms of bibliometric indicators by doing an online search on the Web of Science, and VOSviewer, a bibliometric analysis technique was used. As a result of the bibliometric analysis of 215 articles published with the keywords “artificial intelligence” and “aviation” between 2005 and 2023, it has been observed that significant developments have been recorded after 2014 and that the most broadcasts were made in 2022. In order to obtain healthier results and to avoid information pollution, some limitations were introduced to the analysis, such as “minimum number of publications” and “minimum number of citations”. “People’s Republic of China” is the country with the highest number of publications, with 98 articles in compliance with at least 6 publication conditions. The organization that published at least 4 articles with the keywords “artificial intelligence” and “aviation” became “Chinese Civil Aviation University” with 12 publications. The authors who have at least 4 publications in the articles made with the keywords “artificial intelligence” and “aviation” are “Pietro Aricò, Gianluca Borghini and Gianluca Di Flumeri” who have 10 publications.

## 1. Introduction

The century we live in is characterized as the age of technology, and the rapid technological developments in this century shape people's lifestyles and business policies. While people enjoy the convenience of using technological devices, businesses turn the data they collect into opportunities for marketing purposes (Çankaya, 2020).

Studies and investments in artificial intelligence that emerged with the rapidly developing technology are increasing day by day in many sectors, such as health, education, and aviation. Artificial intelligence studies, which are the result of imitating human intelligence, can be described as the modeling of human learning by machines. Considering that human learning processes occur in the brain, it seems possible to analyze the structure of the brain and create it on machines. Based on the fact that the learning event in humans occurs through the interaction in brain cells called neurons, artificial neural networks were created on computers and the learning event was simulated (Yılmaz & Kaya, 2007). According to McCarthy, who is considered one of the pioneers of artificial intelligence studies, if human intelligence and learning phenomena are understood and defined in detail, machines will have the ability and intelligence to learn by imitating this situation (McCarthy, 2007).

Artificial intelligence systems, which have been included in the daily lives of people from all walks of life since the beginning of the twenty-first century, have become an indispensable part of life. Artificial intelligence systems are utilized in a wide range of day-to-day activities, from computerized systems used at work to vacuum cleaners used for housekeeping, from car navigation systems that plan travel routes to bank accounts that manage investment transactions, from shopping websites where orders are placed to phones used for calls (Coşkun & Gülleroğlu, 2021).

Today, small businesses, large companies, organizations and governments that want to survive for many years and aim to be permanent and successful have to develop and use artificial intelligence systems. Artificial intelligence systems are generally cognitive regulators that can help institutions and organizations make more accurate and effective decisions by processing big data. These systems can be used in every field from the planning of human resources to the development steps to be taken by the states. The use of artificial intelligence systems is mandatory in order to process, classify, control, measure, regulate and make correct decisions, which are important for states (Aydın, 2019).

The aviation industry is a pioneer in technological developments compared to other industries. Along with the increase in globalization from year to year, the aviation sector



also has a rapid growth momentum (Kalakou et al., 2015). With this growth, artificial intelligence is also increasingly adopted in the aviation industry and is now used in various aspects of airports due to its ability to process large amounts of data and streamline tasks and procedures (Seçkiner et al., 2021).

There are many tasks in an airline that have a repetitive or routine nature. These tasks cost valuable time, reduce motivation, and increase the risk of human error. Artificial intelligence applications increase an airline's efficiency, make airlines more competitive, and can reduce or even eliminate human error (Seçkiner et al., 2021).

Obtaining meaningful and useful information about publications that are increasing day by day is becoming increasingly difficult in direct proportion to the increase in the number of publications. Numerous studies that are related to the topics under investigation can be accessed collectively thanks to bibliometric analysis, which has grown in importance as a result of these challenges. For this reason, the aim of the study is to examine the distribution of academic studies on "artificial intelligence" and "aviation" in the literature by year, distribution according to author, and distribution according to country and organization. In order to achieve this goal, the "bibliometric analysis method", one of the qualitative research methods, is used.

## 2. Artificial Intelligence (AI)

When artificial intelligence is done by humans, it is the behavior that is called intelligent when it is done by the machine. The purpose of artificial intelligence is to imitate human intelligence through computers (Pirim, 2006). While doing this, it fulfills its tasks related to higher logic processes such as finding a solution, understanding, inferring a meaning, generalizing and learning from past experiences (Öztürk & Şahin, 2018). Yapay sinir ağları ve yapay zekâ'ya genel bir bakış. Takvim-i Vekayi, 6(2), 25-36.). Artificial intelligence, which facilitates people's work by doing all these, can be grouped as in Figure 1 (Pilon, 2023).

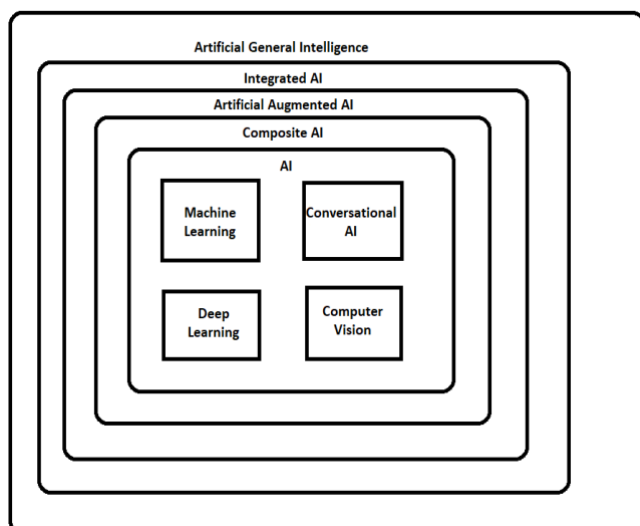


Figure 1. Categories of artificial intelligence (Pilon, 2023)

The common point of all artificial intelligence applications and categories is that they work with data and use more than one technique (Table 1) (Pilon, 2023).

Table 1. Different types of artificial intelligence (Pilon, 2023)

Type of AI Technology	Illustration
Machine learning	Email filters, predictive maintenance for jet engines
Computer vision	Retina scans, fingerprint recognition
Movement sensors	Park distance control
Voice recognition	Siri, Alexa
Search using natural language processing	Google, Yahoo, Amazon
General Narrow Intelligence	Robotics, bottling
Virtual Assistants	

AI objectives:

- Reasoning (explain something)
- Information presentation (tracking intelligence in an easy-to-interpret way)
- Better and faster planning
- Better and faster learning
- Understanding and working with natural language (Natural Language Programming)
- Detection (interpreting difficult environments)
- Ability to move and manipulate objects (robot science).

In artificial intelligence, goals are determined by people and are basically built in accordance with the process of thinking, analyzing and making decisions using people's knowledge (nervous systems). It often requires multiple models to come up with the "final pattern" in achieving goals.

AI is an emerging technology that is rapidly transforming business models in the aviation industry, as in other industries. By using data and mimicking how humans solve problems, AI helps speed up and automate processes with machine and deep learning. From smart search to autonomous vehicles, the combination of smart technologies empowers self-service applications and generates deep insights into patterns. These technologies provide many efficiencies, cost savings and new revenue potential. It is also a powerful tool to guide sustainability efforts. AI helps deliver better customer service and is estimated to generate over \$13 trillion in value each year for customers, businesses and society.

### 2.1. Artificial Intelligence Applications in Aviation

Artificial intelligence, whose foundation and first concrete steps date back to the 17th century and which was first expressed in terms by John McCarthy in 1956 at Dartmouth College, finds more and more fields of study within the disciplines day by day. Artificial intelligence, the use of which is increasing day by day in various industries, is also rapidly involved in the aviation industry. The airline industry prioritizes digitalization and artificial intelligence investments to deal with many uncertainties, such as the difficulty of keeping up with volatile consumer behavior, variable fuel rates, government regulations, declining margins, competition from low-cost flights, and weather conditions.

Artificial intelligence has found many uses in aviation in recent years due to three simultaneous factors. These are the factors

- Large data collection and storage capacity,
- Increase in computational power,
- Development of increasingly powerful algorithms and architectures.

As a result of these;

- It is used in the use of interfaces for all operators in the aviation industry.
- Collecting information about air traffic, the number of which is increasing day by day, processing this collected information and using it in air traffic control systems by making analysis.

- The materials, designs and technology used in the production processes in the aviation industry are more complex and advanced than in other industries. It requires more advanced systems to manage and verify them. At this stage, artificial intelligence comes into play.
- air navigation and flight operations.
- aircraft operations, including fuel management.
- customer contact management and customer service.
- inflight service management and cabin service operations.
- IoT connected devices and sensory applications in cabins.
- Payload Optimization
- Aircraft and Engine Maintenance
- Fuselage corrosion detection
- Pilot relief for simple operations
- Runway throughput improvement
- Meals and Beverages Provisioning
- Network and Schedule Planning,
- Aircraft Assignment
- Demand Forecasting, Pricing, Ancillary, and Revenue Management
- Loyalty Management
- Sales and Distribution
- Retailing and Digital Assistants
- Total Revenue Optimization
- Brand Management, Reputation, and Social Media
- Cargo Warehouse and Handling
- Cargo Commercial Management
- Human Resources Management

Looking at the studies in the literature, the main topics are given in Figure 2. The data are arranged according to the topics taken from Web of Science. Accordingly, the most cited and publications are related to Safety and Maintenance. Other topics are given in the chart.

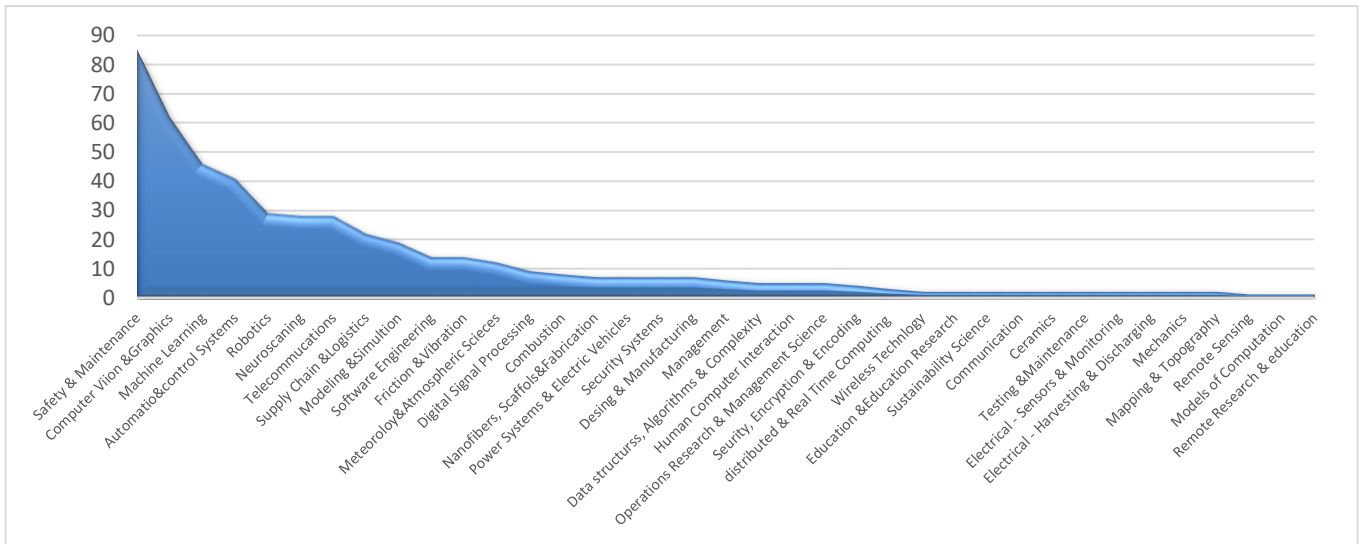


Figure 2. Distribution of main topics in articles on “artificial intelligence” and “aviation” (Reference: Web of Science)

When looking at the more detailed sub-headings in addition to the main topics, the topics related to Situation Awareness, Deep Learning, Airlines, Safety Climate and Multi Agent

Systems were studied with the highest number of publications. These are given in Figure 3.

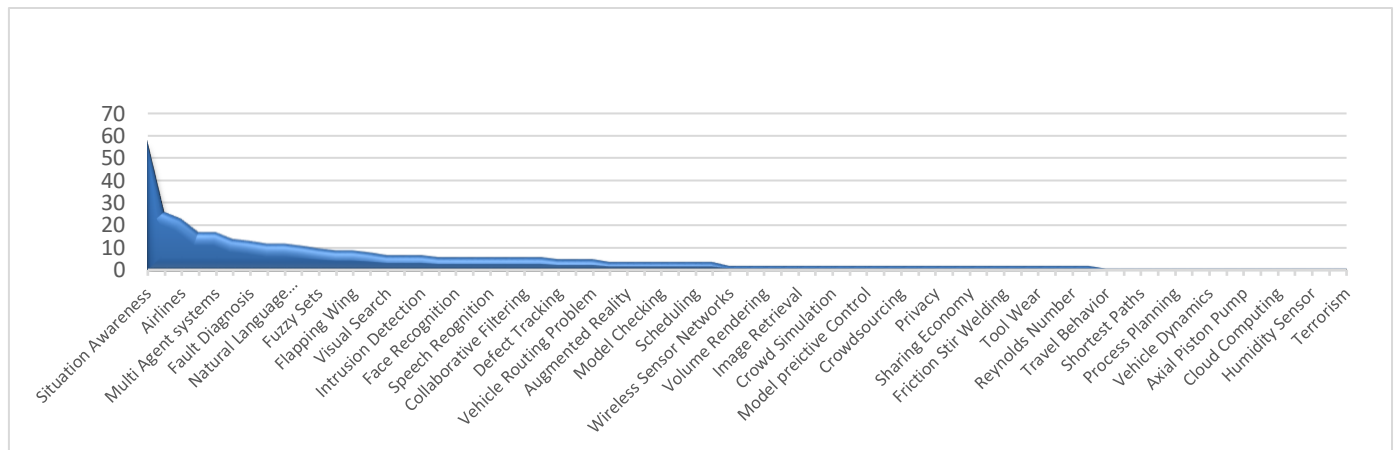


Figure 3. Distribution of detailed topics in articles on “artificial intelligence” and “aviation” (Reference: Web of Science)

### 3. Bibliometric Analysis

Bibliometric analysis, which is expressed as the application of mathematical and statistical methods to books and scientific communication tools, can be applied to scientific outputs, processes and studies (Cronin, 2001). With the bibliometric analysis technique, all the accumulations in the literature or parts covering certain periods are discussed and concrete data about the related discipline are presented (İnceoğlu, 2014). Scientific and academic publications determined within the scope of this method are brought together, the data of the publications are classified and interpreted by making research-oriented analyzes (Baker et al., 2020). Accordingly, bibliometric analysis, active journals published in the study, the total number of publications, the institutions of the authors, the language of publication, the countries where active research was conducted, the types of sources in the study can be examined as keywords, networks, citations from studies, and the bibliometric variable (Gürdin, 2020). Bibliometric analysis consists of 5 different types. These; citation analysis, co-citation analysis and bibliographic matching, co-author analysis and common word analysis (Zupic & Čater, 2015). In this study, the distribution of academic studies on the keywords “artificial intelligence” and “aviation” in the literature by years, distribution according to authors, distribution according to countries and organizations were examined.

### 4. Method

In this section, the purpose and importance of the study, the data collection process, the analysis of the data and the limitations of the study are mentioned.

#### 4.1. Purpose and Importance of the Research

The aim of this study is to be able to reach many studies together with the bibliometric analysis method, which has become more important with the increase of these difficulties, and to present healthier information and visual content to researchers by creating a visual map. In this study, the articles related to the keywords "artificial intelligence" and "aviation" were classified as years, countries, institutions and authors and analyzed. This study is important in terms of providing a broader perspective on the subject to researchers working in the field of artificial intelligence and aviation.

#### 4.2. Scope of the Research

Within the scope of this study, answers to the following research questions were sought:

- What is the number of articles about the keywords “artificial intelligence” and “aviation” in the international index between 2005-2023.
- The years in which the articles about the keywords “artificial intelligence” and “aviation” were published in the international index between 2005-2023.
- By whom the articles about the keywords “artificial intelligence” and “aviation” in the international directory between 2005-2023 were made.
- How many citations have articles on the international directory “artificial intelligence” and “aviation” keywords been cited in the international directory between 2005-2023.

- In which countries the articles about the keywords “artificial intelligence” and “aviation” were written in the international directory between 2005-2023.
- The organization that wrote the articles about the keywords “artificial intelligence” and “aviation” in the international directory between 2005-2023.
- The most cited authors and citation numbers for the keywords “artificial intelligence” and “aviation” in the international index between 2005-2023.

#### 4.3. Research Data Collection Process

During the literature review, data mining, software selection, data analysis, findings and discussions were made. Data for analysis were collected from the Web of Science website and analysis was done by evaluating 215 articles.

#### 4.4. Analysis of Research Data

Analysis and data visualization of the data collected in the study were analyzed using version 1.6.18 of the package program "VOSviewer". The selected software offers state-of-the-art visualizations, especially for the study of bibliometric networks. The VOSviewer program gives information such as how many academic studies have been carried out according to the selected keywords, years, how many researchers work in the field according to the selected keywords, how many of these studies are carried out in which countries and how. VOSviewer helps to generate findings that are visually easy to understand and to analyze the results. It is preferred because it provides information with network relations. In this study, information about articles, journals, authors, common citation network, author common citation network, countries and institutions and organizations where publications are made and keywords were analyzed and graphs were created.

#### 4.5. Limitations of the Study

The data used in the study were obtained from the Web of Science database. There is a time decrement because the articles in the Web of Science database will be used between 2005-2023. Other limitations are that the document scanning was done only in the Web of Science database and other databases were not examined, the language of the articles studied was only English, only the articles were being examined as a document type, and the data processed in the VOSViewer program used was accepted to be correct.

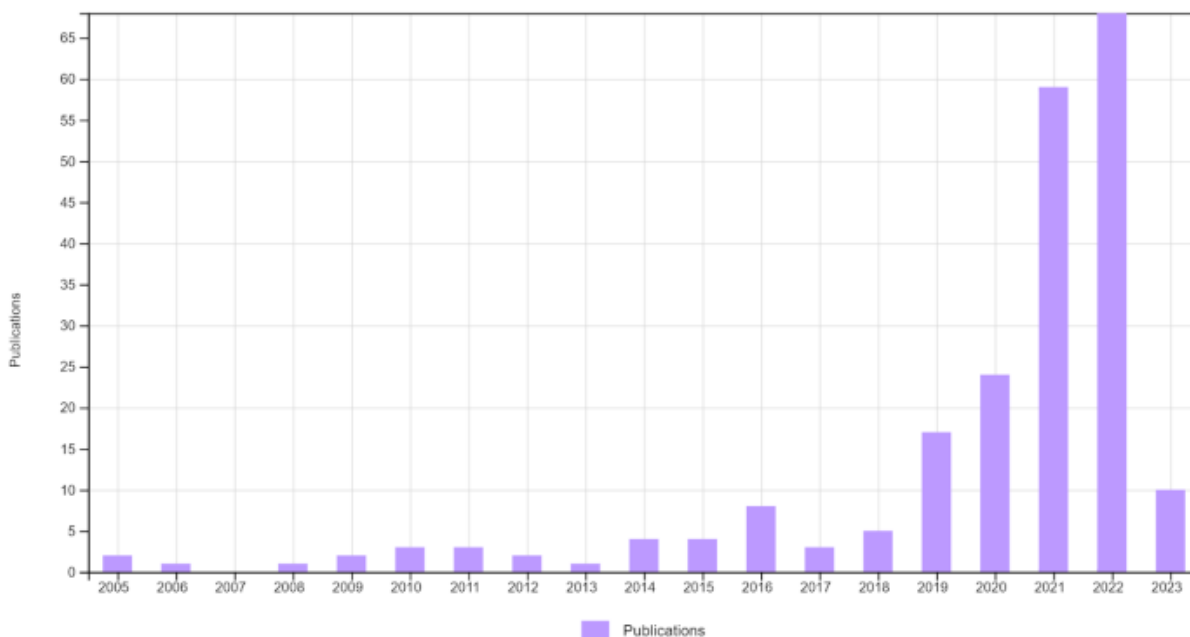
### 5. Findings

In the study, information about articles, information about journals, information about authors, journal co-citation network, author co-citation network, information about countries were analyzed and graphics were created.

#### 5.1. Distribution by Years

AI is a relatively old field of computer science that encompasses several techniques and covers a wide range of applications. AI is a broad term and its definition has evolved as technology has evolved. For this reason, the number of publications has been increasing over the years. In the study publications related to “artificial intelligence” and “aviation” were taken into account, a total of 215 articles were examined between the years 2005-2023. The distribution of publications by year is given in Graph 3. According to Graph 1, the most publications were made in 2022. When we consider the

number of articles by year, it is seen that there has been an increase in recent years.



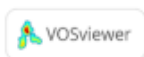
**Figure 4.** Distribution of articles on the keywords “artificial intelligence” and “aviation” by Years in the Period 2005-2023. (Reference: Web of Science)

When the distribution of articles related to the keywords "artificial intelligence" and "aviation" for the 2005-2023 period is examined, it is seen that the year 2022 was the year with the most publications, with 116 articles. Following 2022, 2021 is the second year with the most publications with 104 articles. There is fluctuation in the number of articles published between 2009 and 2014. It cannot be said that there has been a continuous increase or decrease between these years. After 2014, it is seen that there is a regular increase in the articles published about these keywords. It can be said that the increase in the number of articles published on this subject

after 2014 is a result of the importance given to artificial intelligence in aviation and the increasing research and investments in this subject. In recent years, "artificial intelligence" and "aviation" research have gained momentum. 2023 data belongs to March 2023 and is increasing day by day.

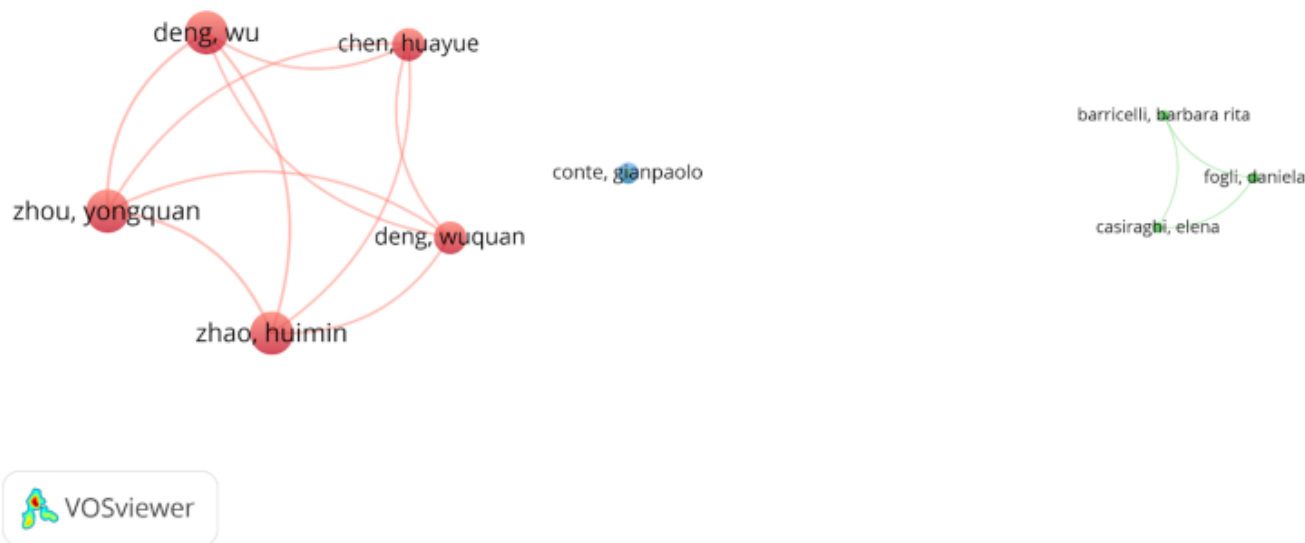
**5.2. Authors with the most publications**

The ten authors with the most publications in this section are given in Figure 5.



**Figure 5.** The authors who published the most articles between 2005-2023 and the relationship between them.





**Figure 6.** The most cited authors between 2005-2023 and the relationship between them.

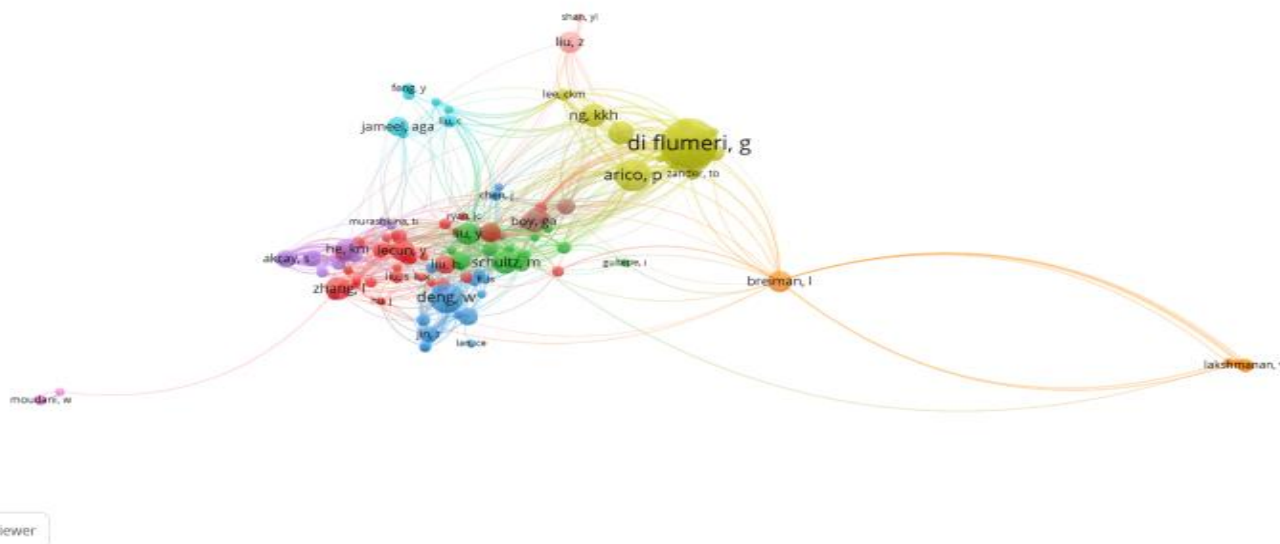
Considering the distribution of the authors who published the most articles on the keywords “artificial intelligence” and “aviation” obtained from the VOSviewer program, the authors with at least 4 publications related to these keywords were taken into account. Out of a total of 915 authors who published on the keywords “artificial intelligence” and “aviation”, 10 authors with at least 4 publications were found. Nodes grow according to the number of articles belonging to authors. In this direction, according to Figure 5, the authors who have published the most on the keywords “artificial intelligence” and “aviation” are Pietro Aricò, Gianluca Borghini and Gianluca Di Flumeri with 10 publications. These authors are followed by Nicolina Sciaraffa (9), Fabio Babiloni (8), Vincenzo Ronca (7), Andrea Giorgi (6), Alessia Vozzi (6), Wu Deng (4) and Huimin Zhou (4). The fact that the node colors are the same indicates the existence of the authors working together; the lines indicate the relationship of the authors to each other.

### 5.3. Most cited authors

The ten most cited authors in this section are given in Figure 6. In order to obtain the top 10 most cited authors out of 915 authors, the minimum number of citations for an author was determined as 208. Wu Deng, Huimin Zhou and Yongquan Zhou are the most cited authors with 391 citations. These authors are followed by Huayue Chen and Wuquan Deng with 237 citations. The citations received by other authors are as follows, respectively; Barbara Rita Barricelli (233), Elena Casiraghi (233), Daniela Fogli (233), Thomas B. Sheridan (230), Gianpaolo Conte (208).

### 5.4. Author Co-Citation Analysis

In this section, the author co-citation analysis is listed in Figure 7.



**Figure 7.** Co-Citation Network of publication authors on the keywords “artificial intelligence” and “aviation”.

It was visualized using the “citation-based analysis” technique in the VOSviewer program to identify the most cited authors in studies in this field. It can be learned through co-attribution analysis of the intellectual structure of scientific disciplines. In other words, author co-citation analysis means that the series of articles published by an author is understood as the "author". Authors whose publications are often seen as interrelated and repeatedly cited as such in their later work tend to converge on the map. On the other hand, authors who are rarely or never mentioned together are located relatively further away on the map. In other words, authors' co-citation analysis concludes that the more frequently two authors are cited together, the closer the relationship between them (White

& Griffith, 1981). Authors with at least 5 publications related to the keywords “artificial intelligence” and “aviation” were evaluated. In Figure 7, 128 out of 7588 authors meet the threshold. The authors were divided into 10 different groups. As a result of the analysis, the author who established the most common networks is Gianluca Di Flumeri with 28 common connections. Then Gianluca Borghini (27), Pietro Aricò (18), Wu Deng (17) and NG, Kam K.H. It comes from (13).

### 5.5. Distribution by Country

In this section, the ten countries with the most studies and the network of relations between them are given in Figure 8.



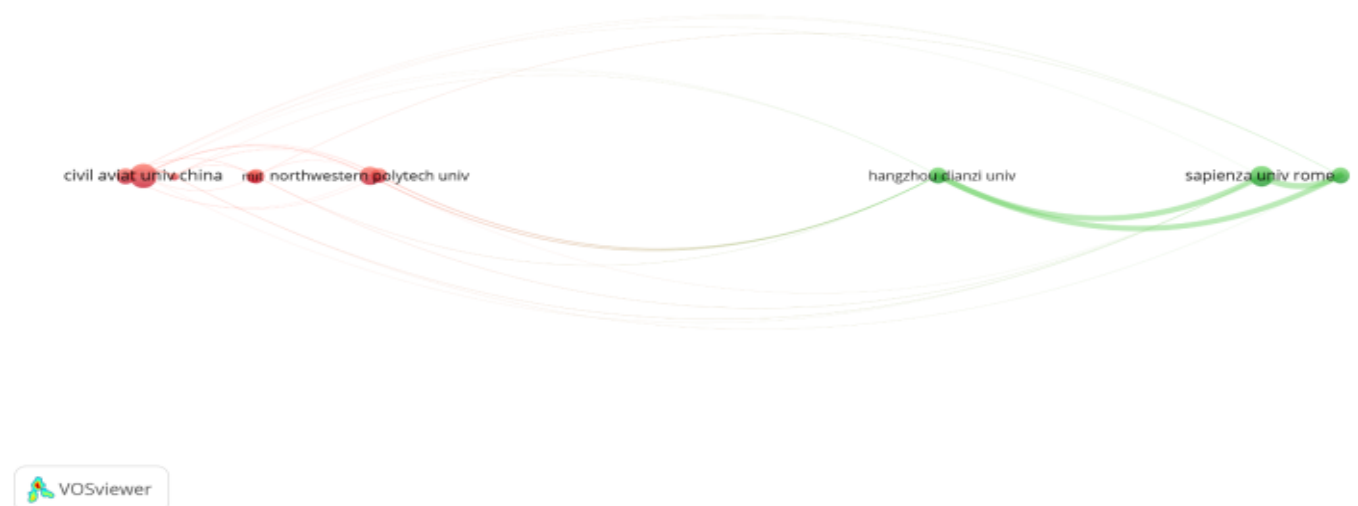
**Figure 8.** Distribution of Articles on “artificial intelligence” and “aviation” Keywords Published in 2005-2023 by Country.

When considering the distribution of the articles obtained from the VOSviewer program regarding the keywords “artificial intelligence” and “aviation” according to the countries in which they were published, countries with at least 6 publications related to these keywords were taken into account. Of the 44 countries that have studies on the keywords “artificial intelligence” and “aviation”, only 12 countries have at least 6 publications and these countries are shown in Figure 8. Circle sizes in colored visual network analysis increase as the number of publications per country increases. While the node (circle) colors in the network show whether there are cross-country citations in the studies, the lines between the

circles show the relationships between the countries. According to Figure 8, the top 10 countries with the most articles on the keywords “artificial intelligence” and “aviation” are in order; People's Republic of China (98), United States of America (34), England (14), Italy (13), France (13), Germany (9), South Korea (9), India (9), Spain (8), Turkey (7).

### 5.6. Distribution by Organizations

The ten organizations most studied in this section are given in Figure 9.



**Figure 9.** Bibliometric Network Analysis Showing the Distribution of Articles on “artificial intelligence” and “aviation” Keywords Published in 2005-2023 by Institutions.

When considering the distribution of the articles obtained from the VOSviewer program regarding the keywords “artificial intelligence” and “aviation” according to the organizations in which they were published, organizations with at least 4 publications related to these keywords were taken into account. Out of a total of 410 organizations analyzed, only 13 organizations have at least 4 publications on the keywords “artificial intelligence” and “aviation”. As mentioned before, node sizes indicate the number of publications belonging to institutions. While the node colors indicate inter-institutional collaborations, the lines between the nodes indicate the inter-institutional relationship. Accordingly, when we look at Figure, the top 10 organizations with the most articles on the keywords “artificial intelligence” and “aviation” are respectively; Civil Aviation University of China (12), Sapienza University of Rome (10), Northwestern Polytechnical University (9), Brainsigns SRL (8), Hangzhou Dianzi University (8), Nakai University (8), Shanghai Jiao Tong University (7), Beihang University (7), Massachusetts Institute of Technology-MIT (6), Chinese Academy of Sciences (7).

## 6. Conclusion

Within the scope of the research carried out for the keywords “artificial intelligence” and “aviation”, a total of 215 articles were accessed from the “Web of Science” database and included in the analysis. The visualization of the data related to the articles was realized by the “VOSviewer” scientific maps visualization program. In order to obtain healthier results and to avoid information pollution, some limitations were introduced to the analysis, such as “minimum number of publications” and “minimum number of citations”. As a result of the bibliometric analysis of 215 articles published with the keywords “artificial intelligence” and “aviation” between 2005-2023; It was observed that important developments were recorded after 2014 and the most articles were published in 2022. “People’s Republic of China” is the country with the highest number of publications, with 98 articles in accordance with at least 6 publication conditions. The organization that published at least 4 articles on the keywords “artificial intelligence” and “aviation” became the “Civil Aviation University of China” with 12 publications. In the articles on the keywords “artificial intelligence” and “aviation”, the authors with at least 4 publications are “Pietro Aricò, Gianluca Borghini and Gianluca Di Flumeri” with 10 publications. This study, which provides data on the countries, institutions, authors and the years with the most articles published on the keywords “artificial intelligence” and “aviation”, and which creates a systematic infrastructure, is important in terms of providing information in general terms. It provides researchers who will work in the field of “artificial intelligence” and “aviation” the opportunity to study the subject in depth by providing a broader perspective on this issue. The fact that the document scanning was carried out only in the Web of Science database and other databases were not examined constitutes the first limitation of the study, while the fact that the language of the articles studied is only English constitutes the second limitation, and the fact that only the articles are examined as a

document type constitutes the third limitation. In the studies to be carried out later; Scopus, etc. other databases, such as publications made in languages other than English and document types, papers, book chapters, editorial materials, etc. a more extensive research can also be carried out by including it in the analysis.

## Ethical approval

Not applicable.

## Conflicts of Interest

The authors declare that there is no conflict of interest regarding the publication of this paper.

## References

- Aydin, A. (2019). Transformation of the management paradigm of state power in the context of artificial intelligence. G. Telli. *Artificial Intelligence and the Future*, 65-87.
- Baker, H. K., Kumar, S., & Pattnaik, D. (2021). Twenty-five years of the journal of corporate finance: a scientometric analysis. *Journal of Corporate Finance*, 66, 101572.
- Cronin, B. (2001). Bibliometrics and beyond: some thoughts on web-based citation analysis. *Journal of Information Science*, 27(1), 1-7.
- Coskun, F., & Gulleroglu, H. D. (2021). The Development of Artificial Intelligence in History and Its Use in Education. *Ankara University Journal of Faculty of Educational Sciences (JFES)*, 54(3), 947-966.
- Cankaya, D. (2020). Artificial Intelligence, API and Big Data Based Solutions Spreading in Aviation. *Academic Perspective Procedia*, 3(1), 465-473.
- Gurdin, B. (2020). Bibliometric Analysis of Green Marketing By Visualizing Scientific Maps. *Econder International Academic Journal*, 4(1), 203-231.
- Inceoglu, Ç. (2014). A Bibliometric Analysis on the Cinema Studies Doctoral Theses in Turkey. *Galatasaray University Journal of Communication*, (21), 31-50.
- Kalakou, S., Psaraki-Kalouptsidi, V., & Moura, F. (2015). Future airport terminals: New technologies promise capacity gains. *Journal of Air Transport Management*, 42, 203-212.
- McCarthy, J. (2007). From here to human-level AI. *Artificial Intelligence*, 171(18), 1174-1182.
- Ozturk, K., & Sahin, M. E. (2018). A General View of Artificial Neural Networks and Artificial Intelligence. *Takvim-i Vekayi*, 6(2), 25-36.
- Pilon, R. V. (2023). *Artificial Intelligence in Commercial Aviation: Use Cases and Emerging Strategies*. Taylor & Francis.
- Pirim, A. G. H. (2006). Artificial intelligence. *Journal of Yasar University*, 1(1), 81-93.
- Seckiner, S., Metehan, A. T. A. Y., & Eroglu, Y. (2021). Pandemic Period Aviation Industry Applications and Future of Robotic Process Automations. *Journal of Aviation*, 5(2), 290-297.
- White, H. D., & Griffith, B. C. (1981). Author cocitation: A literature measure of intellectual structure. *Journal of the American Society for Information Science*, 32(3), 163-171.

- Yilmaz, A., & Kaya, U. (2021). *Deep Learning* (3rd Edition). Istanbul: Kodlab.
- Zupic, I., & Čater, T. (2015). Bibliometric methods in management and organization. *Organizational research methods*, 18(3), 429-472.

---

**Cite this article:** Uslu, T.U., Acikel, B. (2023). Bibliometric Analysis of Academic Publications on Artificial Intelligence and Aviation Keywords with VOSviewer. *Journal of Aviation*, 7(2), 284-292.



This is an open access article distributed under the terms of the Creative Commons Attribution 4.0 International Licence

Copyright © 2023 *Journal of Aviation* <https://javsci.com> - <http://dergipark.gov.tr/jav>



# Investigation of the Effect of the Instrument Landing System on Flights to Konya Airport between 2019-2022 Years

Ersin Öktemer<sup>1\*</sup>, Fatih Alpaslan Kazan<sup>2</sup>

<sup>1\*</sup>Selçuk University, Institute of Graduate Sciences, Aviation Technologies, Konya, Türkiye (oktemer.ersin@gmail.com)

<sup>2</sup>Selçuk University, Department of Aviation Electrical and Electronics, Konya, Türkiye (akazan@selcuk.edu.tr)

## Article Info

Received: 13 April 2023  
Revised: 19 June 2023  
Accepted: 15 July 2023  
Published Online: 14 July 2023

### Keywords:

Instrument landing system  
Operational categories  
Cancellation  
Divert  
Delay

Corresponding Author: Ersin Öktemer

## RESEARCH ARTICLE

<https://doi.org/10.30518/jav.1282908>

## Abstract

The Instrument Landing System (ILS) is the most widely used navigation aid system among the precision approach types, which enables the pilots to approach the runway in the appropriate direction and glide slope, especially in foggy and snowy weather when the visibility is very low. This study investigated the relationship between flight disruptions and ILS in Konya Airport. In this context, meteorological events such as snow, ice, fog, and cancellation, divert and delay events caused by humans (company policy) at Konya Airport in the period of 2019-2022 were revealed with numerical data. In light of these data, it has been revealed that ILS not only provides safe flights but also prevents possible passenger complaints and financial losses by reducing the number of divers, and therefore ILS is also of great importance in terms of customer satisfaction.

## 1. Introduction

The instrument landing system (ILS) is the most widely used navigation aid system among precision approach types, guiding the aircraft in horizontal and vertical directions to ensure the safe landing of the aircraft on the runway. It allows aircraft to land safely even in bad weather conditions where visibility is very low, such as foggy and snowy weather. The antennas and markers, which are the components of the ILS, which enable the aircraft to land despite all these adverse conditions, and their positions relative to the runway, are shown in Figure 1.

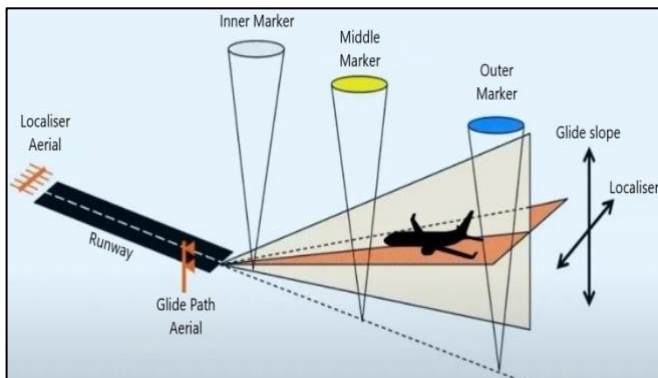


Figure 1. All components of ILS and their placement.

ILS is available at airports with good infrastructure and environmental conditions. Although the airplanes have the necessary equipment related to ILS, the fact that the airport has a very low density, the structure of the airport, and seasonal conditions can be counted as the reasons why this system is not available at some airports. Accordingly, the ILS infrastructures of airports differ in terms of operational categories.

Some of the academic studies on ILS and approach systems, which have such important benefits in terms of flight safety, are summarized below.

Elaboration of ILS and its components (Öktemer & Gültekin, 2021), the use of ILS and the additional costs arising from flight delays (Kaba & Ürgün, 2019), advanced technologies used in approach systems (Ataş et al., 2014), comparing and analyzing the operational category efficiencies of the busiest airports in Europe, Asia, and North America (Güner, Ergüzel, & Cebeci, 2019), mathematical modeling that will reduce the effect of irregular surfaces in order to prevent the negative effects such as the hangar and terminal buildings reflecting the localizer signals to the route region (Odunaiya & McFarland, 1996), airplanes in the taxiway disrupting the ILS signals and comparing this situation for various airplane types (Geise et al., 2010), suggestions for improving localizer antenna arrays (Peterson, 1976), simulating the accuracy of ILS in conditions such as fog, rain, snow, etc. (Merkisz, Galant, & Bieda, 2017), classifying the fogs that occurred at Istanbul Atatürk Airport between 2008-

2012 in the ILS category and determining the CAT categories in the foggy hours (Özdemir, Sezen, Deniz, & Menteş, 2014), inferences obtained from tests performed by performing front course and back course approaches in the ILS (Hunting, 1972), development of an electromagnetic scattering model to predict localizer and glide slope performance (Chin, Jordan, Kahn, & Morin, 1975), flight measurement and testing of the ILS by flying laboratory aircraft at the University of Žilina (Novák, Havel, & Janovec, 2017), examination of ILS interference caused by Airbus A380 and Boeing B747 aircraft, via analyzes using scaled localizers (Geise, Enders, Vahle, & Spieker, 2008), advices about possible variants of ILS control process improvement (Zuiev, 2017), airborne measurement of ILS Signals using an unmanned air vehicle (Jantz, West, Mitchell, Johnson, & Ambrose, 2019), receiving the signals reflected from the aircraft and measuring the signal deviations that occur on the glide path (Yungaitis, Zhdanov, Zotov, & Voytovich, 2020), simulating the approach track of the aircraft in Matlab and thus investigating the safe landing in bad flight conditions (Geng & Ping, 2015), analysis of electromagnetic disturbances caused by buildings and obstacles around the airport (Wang, Shen, Cheng, & Wang, 2019), improvements that can be made in the localizer and glide path designs of ILS (Metz, 1959), elaborating of the inadequacies of ILS's existing before 1973 (Sanders & Fritch, 1973), controller design and experimental evaluation for ILS (Jain, Shetty, & Shenoy, 2014), experimental based learning and teaching management for localizer (Tangthong & Aktimagool, 2020), performing flight inspections and analyses of the ILS (Novák & Pitor, 2011), analyses and differences of microwave landing system and ILS (Neville & Matolak, 2004), ILS's analysis based on adaptive beamforming technology (Li et al., 2006), presenting advanced models to solve the problems that occur in the aircraft receiver due to the obstacles around the runway disrupting the signals (Noshirvani & Rezaee, 2010), analyzing the signal quality of the ILS (Zhao, Zhao, He, & Dong, 2019).

The most striking study that can be thought of as similar to our study is the study presented in (Kaba & Ürgün, 2019). In the study conducted by Kaba and Ürgün (2019), the daily average number of flights and low visibility rates for January, February, March, and April at Odessa, Bishkek, Pristina, and Rostov airports between 2014-2019 are shared in tables. However, numerical data that would clearly reveal the effect of ILS such as annual total flight information and the number of divert at the relevant airports are not included.

In this study, first of all, information about the usage status and ILS categories of some airports in our country is given. Then, official meteorological data of Konya Airport were shared. Finally, the relationship between meteorology and company-related disruptions and ILS was researched specifically for Konya Airport, covering a period of 4 years starting from 2019, and the numerical data obtained were shared.

## 2. ILS and Operational Categories

Precision approach is a type of instrumental approach that the aircraft performs by collecting information in lateral and vertical directions within the scope of operational categories. Operational categories vary according to airport approach procedures and are actually segmented by cloud ceiling and visibility. According to their performance, there are three types of ILS categories: Category-1 (CAT-I), Category-2 (CAT-II) and Category-3 (CAT-III). These categories are expressed in terms of decision height (DH) and runway visual range (RVR). Airports are also separated into these categories.

The values of the decision heights and runway visual ranges that should be applied in the current operational categories are given in Table 1. The categories in Table 1 are used for runways with ILS and are determined according to their visual ranges. When Table 1 is examined, it will be seen that CAT-III is the most sensitive approach where landing takes place even at zero visibility. However, it should not be forgotten that the presence of the components of the ILS at airports and aircraft is not sufficient alone and that the pilots who will land with the ILS must have received training on the relevant CAT.

## 3. Use of ILS at the Airports of Our Country

There are 59 civil airports in use in our country. 37 of them operate international flights. 18 of the existing airports are used together with the Turkish Armed Forces for military purposes. The number of airports used only for military purposes in our country is 18. Information on some airports in Turkey and their ILS categories is presented in Table 2. The locations of the airports, their abbreviations according to the International Civil Aviation Organization (ICAO) and the International Air Transport Association (IATA), their names, and their usage purposes are also shared in the table.

## 4. Konya Airport, Meteorological Data, and ILS

### 4.1. Konya Airport

Konya Airport is an airport located within the borders of the Selçuklu district of Konya and used for civil and military purposes. This airport, which was previously used only for military purposes, was opened to civil air traffic in the 2000 year. Konya Airport, which is used under the joint management of the State Airports Authority and the Turkish Air Force, was established on an area of approximately 141,000 square meters.

ILS started to be used at Konya Airport in 2008 and its infrastructure was created according to CAT-I. In order to increase the operational category, technical studies were last carried out in 2018 and presented to the relevant institution. However, considering both the joint use of the airport runway with the Turkish Air Force and the obstacle criteria, operating conditions, and costs, it was evaluated that it was appropriate for the airport to remain in the CAT-I category.

Konya Airport has two runways for the landing and take-off of airplanes. These runways are named East and West. The ILS is only used on the West runway. Located at the northern beginning of the runway, ILS broadcasts towards the south. The biggest factor in the placement of the system in this direction (from north to south) is the winds. The winds blowing in Konya generally blow from the north. Considering the necessity of always taking the wind from the front during the landing and take-off of the aircraft, it will be understood that the landings made using the ILS should take place from the south to the north.

The fact that there is a one-way ILS at the airports causes air traffic during landings. The first thing that comes to mind to eliminate such situations is the back-course approach. However, the ILS systems used in our country only have front course approaches.

**Table 1.** Operational Categories (Kazan & Öktemer, 2023)

Category of Operation	Decision Height (DH)	Runway Visual Range (RVR)	Min. 800 m
CAT-I	DH > 200 ft	RVR > 550 m	800 m
CAT-II	100 ft < DH < 200 ft	RVR > 300 m	-
CAT-IIIA	DH < 100 ft or no DH	RVR > 200 m	-
CAT-IIIB	DH < 50 ft or no DH	50 m < RVR < 200 m	-
CAT-IIIC	no DH	no RVR limitation	-

#### 4.1 Meteorological Data of Konya Airport

Undoubtedly, the meteorological conditions in the airport area are of great importance in the number of landings and take-offs at airports. For this reason, sharing data on meteorological events at Konya Airport in this four-year period covering the years 2019-2022 will provide a better understanding of the impact of ILS in this process. The number of snowy days at Konya Airport during this period covering the years 2019-2022 is given in Table 3 as monthly data. The number of days when the airport is covered with snow after these precipitations are given in Table 4 and the manually measured maximum snow thicknesses in cm are given in Table 5.

**Table 2.** Information about some airports in our country

Location	ICAO	IATA	The Name of the Airport	Purpose of Usage	ILS Category
Adana	LTAF	ADA	Şakirpaşa Airport	Civil	CAT-I
Amasya	LTAB	MZH	Amasya-Merzifon Airport	Civil/Military	CAT-I
Ankara	LTAD	-	Etimesgut Airport	Military	CAT-I
Ankara	LTAE	-	Mürted Hava Üssü	Military	CAT-I
Ankara	LTAC	ESB	Ankara Esenboğa Airport	Civil	CAT-I/II/III
Antalya	LTAI	AYT	Antalya Airport	Civil/Military	CAT-I/II
Balıkesir	LTFD	EDO	Balıkesir Koca Seyit Airport	Civil	CAT-I
Erzurum	LTCE	ERZ	Erzurum Airport	Civil	CAT-II/III
Gaziantep	LTAJ	GZT	Gaziantep Airport	Civil	CAT-II
İstanbul	LTFJ	SAW	Sabiha Gökçen Airport	Civil	CAT-I
İstanbul	LTFM	IST	İstanbul Airport	Civil	CAT-I/II
İzmir	LTJB	ADB	Adnan Menderes Airport	Civil	CAT-I/II
Konya	LTAN	KYA	Konya Airport	Civil/Military	CAT-I
Kastamonu	LTAL	KFS	Kastamonu Airport	Civil	CAT-I
Kayseri	LTAU	ASR	Erkilet Airport	Civil/Military	CAT-I
Kütahya	LTBZ	KZR	Zafer Airport	Civil	CAT-II
Malatya	LTAT	MLX	Malatya Airport	Civil/Military	CAT-I
Muğla	LTBS	DLM	Dalaman Airport	Civil/Military	CAT-I/II
Muğla	LTFE	BJV	Milas-Bodrum Airport	Civil/Military	CAT-II
Sivas	LTAR	VAS	Sivas Nuri Demirağ Airport	Civil	CAT-I
Zonguldak	LTAS	ONQ	Zonguldak Airport	Civil	CAT-I

**Table 3.** Number of days with snow on a monthly basis at Konya Airport.

Year	Month											
	1	2	3	4	5	6	7	8	9	10	11	12
2019	9	4	3	2								6
2020	14	5	5									
2021	5	5	7	4								5
2022	13	4	18	1								1

**Table 4.** Number of snow-covered days at Konya Airport on a monthly basis.

Year	Month											
	1	2	3	4	5	6	7	8	9	10	11	12
2019	10		2	1								3
2020	6	3	5									
2021	3	8	4	2								15
2022	13	18	13									

**Table 5.** Maximum snow height (cm) at Konya Airport on a monthly basis.

Year	Month											
	1	2	3	4	5	6	7	8	9	10	11	12
2019	10		1									2
2020	4	4	4									
2021	2	10	3	4								23
2022	30	27	21									

**Table 6.** Number of days with monthly fog events at Konya Airport.

Year	Month											
	1	2	3	4	5	6	7	8	9	10	11	12
2019	10	1	1	2							11	8
2020	3	1	1		1							3
2021	7										2	10
2022	4	7									3	14

**Table 8.** Total monthly precipitation at Konya Airport (mm=kg/m<sup>2</sup>).

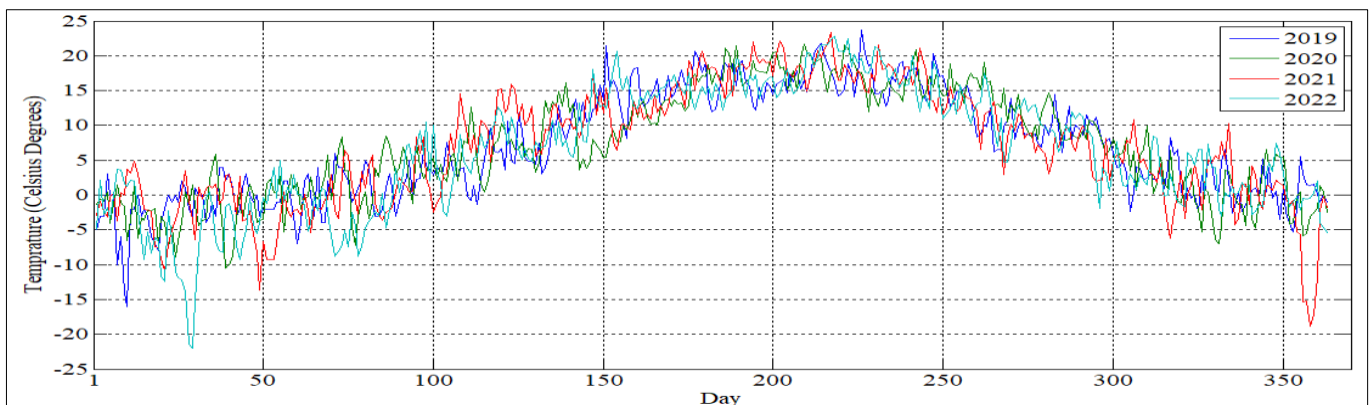
Year	Month											
	1	2	3	4	5	6	7	8	9	10	11	12
2019	47.7	20.6	21.9	44.8	6.8	62.8	19.6	8.4	6.6	4.8	35.4	81.7
2020	48.7	36.5	51.8	35.3	43.5	23.9	0.9	0.4	6.9	4.1	19.6	20.1
2021	25.2	11.9	51.1	29.1	2.0	47.1	46.3	9.8	29.1	2.7	16.0	89.4
2022	70.6	48.0	55.1	1.0	39.9	10.4	7.9	2.0	11.5	24.2	10.9	7.9

**Table 7.** Number of rainy days at Konya Airport on a monthly basis (manual measurement).

Year	Month											
	1	2	3	4	5	6	7	8	9	10	11	12
2019	19	8	6	12	8	13	3	2	3	5	7	18
2020	9	9	13	12	9	10	2	1	3	3	5	10
2021	8	5	12	7	2	12	2	1	6	5	6	12
2022	14	9	12	1	10	8	2	1	5	6	7	7

The minimum temperature values for the same period are shared in Figure 2 in graphic form. In Figure 2, the number of days when the temperature drops below zero is 72, 77, 85, and 93, respectively, by year.

As it is known, heavy fog and rain are also meteorological events that cause delays, missed approaches and flight divers. In this process, the number of foggy and rainy days at Konya Airport and the total amount of precipitation are given in Table 6-8, respectively.



**Figure 2.** Minimum air temperatures for 4 years at Konya Airport.

#### 4.2 The Impact of ILS on Konya Airport Flights

In addition to making the pilots' job easier, ILS also has benefits such as reducing the number of undesirable situations such as flight cancellations, divers, and delays. As it is known, cancellation is a situation where the flight does not take place at all. Divert is the event that the airplane makes its planned landing at another airport due to reasons that prevent it from taking place at the relevant airport. Delay is the inability to start the planned flight until all the conditions that constitute an obstacle to the flight are eliminated.

The number of planned landings and take-offs at Konya Airport in the 4 years covering the years 2019-2022 is given in Table 9. The reason for using the term "planned" here is that the numbers of unforeseen cancellations, divers and delays are also included in this total number.

**Table 9.** The number of flights planned at Konya Airport according to the years.

Year	The number of planned landings	The number of planned departures
2019	2945	2945
2020	3168	3168
2021	3411	3411
2022	3627	3627

In the same period, cancellation, divert, and delay events caused by snow, ice, and people (company policy) at Konya Airport are presented in Table 10. When Table 10 is examined, it is understood that the landings were realized safely due to the ILS, except in extreme snow and ice conditions. The

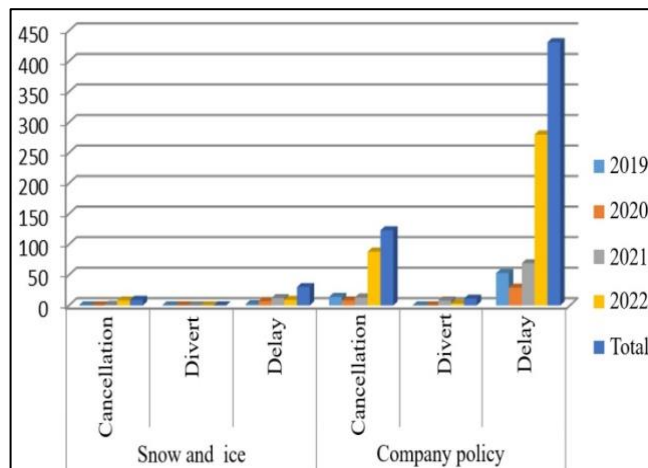


cancellation of only 9 of the descents with a total of 13151 shared in Table 3, and the absence of any divers, clearly demonstrates how important ILS is during landings. However, when the numbers of cancellations and divers originating

from the company in the same table are examined, it is seen that there were 123 cancellations and 11 divers in the same period. Figure 3, where numerical data is visualized, better reveals this difference's size.

**Table 10.** Cancellation, divert, and delay situations caused by snow, ice, and company at Konya Airport

Year	Due to snow and ice			Sourced from company policy		
	Cancellation	Divert	Delay	Cancellation	Divert	Delay
2019	0	0	2	14	0	53
2020	0	0	7	8	0	29
2021	1	0	12	13	8	69
2022	8	0	9	88	3	280
<b>Total</b>	<b>9</b>	<b>0</b>	<b>30</b>	<b>123</b>	<b>11</b>	<b>431</b>



**Figure 3.** The number of cancellations, divers, and delays at Konya Airport due to snow, ice, and company policy.

Since the category was created according to the fog factor in the visibility distances, the cancellation, divert and delay events caused by fog at Konya Airport in the 2019-2022 period were evaluated separately from the cancellation, divert, and delay situations caused by snow, ice, and the company policy. These data are shared in Table 11, Table 12, and Table 13, respectively.

These data, presented in Tables 11-13, have been graphed and shared in Figure 4 for easier comparison.

**Table 11.** Distribution of fog-related cancellations at Konya Airport by years. (VD: View distance)

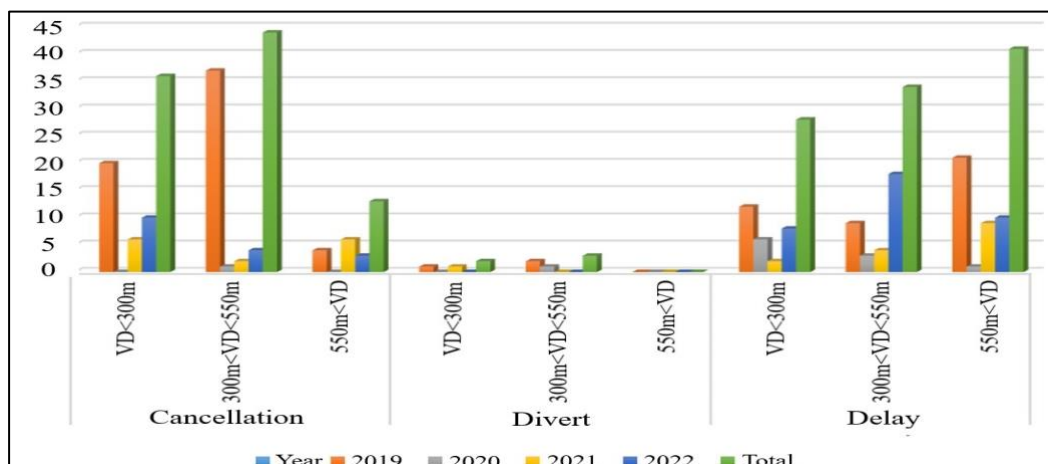
Year	VD<300m	300m<VD<550m	550m<VD
2019	20	37	4
2020	0	1	0
2021	6	2	6
2022	10	4	3

**Table 12.** Distribution of fog-related divers at Konya Airport by years. (VD: View distance)

Year	VD<300m	300m<VD<550m	550m<VD
2019	1	2	0
2020	0	1	0
2021	1	0	0
2022	0	0	0

**Table 13.** Distribution of fog-related delays at Konya Airport by years. (VD: View distance)

Year	VD<300m	300m<VD<550m	550m<VD
2019	12	9	21
2020	6	3	1
2021	2	4	9
2022	8	18	10



**Figure 4.** The number of cancellations, divers, and delays due to fog at Konya Airport.

When Tables 11-13 and Figure 4 are examined together, it will be understood that the number of cancellations in the case when the view distance is dropped between 300 m and 500 m due to fog is higher than in the other two view distance situations. The total number of cancellations experienced on 13151 flights during this period is 93. This means that only 0.707 % of the total flights are canceled. It is seen that the total number of delays due to fog in these 4 years was higher than the total number of cancellations and realized as 103.

When the fog-induced divergence numbers, which clearly demonstrate the importance of ILS, are examined, it is seen that only 5 diversions have occurred in these 4 years. This means that diversions occur in only 0.038% of the total flight. Even when this rate of only 0.038% is taken into consideration, the importance of ILS is revealed.

## 5. Conclusion

In this study, the effect of ILS on the number of disruptions in flights was investigated specifically at Konya Airport. In this context, meteorological events such as snow, ice, and fog, as well as human (company policy) sourced cancellation, diversion, and delay events in a total of 13151 flights to Konya Airport in the 2019-2022 period were revealed with numerical data. In light of the numerical data obtained, it was seen that only 0.707% of the total flight was canceled. It was observed that the diversion rate was similarly very low and remained at 0.038%. In light of these data, it has been revealed that ILS not only provides safe flights but also prevents possible passenger complaints and financial losses by reducing the number of diversions, therefore ILS is also of great importance in terms of customer satisfaction.

In this study, information was also given about the usage status and ILS structures of some airports in our country. In this context, it has been observed that CAT-I is generally used as the ILS category in our country, but there are also CAT-II and CAT-III infrastructures, which are more sensitive than CAT-I.

In fog-induced situations, the pilot factor comes to the fore. In cases where the visibility is the same, the flight may be canceled, diverted, or delayed. In these cases, the pilot's experience, training, and decision-making skills come to the forefront. The most important issue that will affect the pilot's decision-making status is the operational infrastructure of the ILS system.

It should not be forgotten that the pilot who will perform the flight should have a rested, trained, and healthy body/mind composition and should perform the flight accordingly.

## Ethical approval

Not applicable.

## Conflicts of Interest

The authors declare that there is no conflict of interest regarding the publication of this paper.

## Acknowledgement

This article was modified from Ersin ÖKTEMER's master's thesis titled "Investigation of the Use of Instrument Landing System at the Airports of Our Country".

The authors thank the Konya Airport management and the General Directorate of Meteorology for sharing the official data.

## References

- Ataş, S., Koç, O., Çiftçi, M. E., Kiliç, M., Altın, D., Özdemir, B. G., & Yeşilyurt, A. (2014). Yaklaşma iniş sistemlerinde ileri teknolojiler. *Journal of Aeronautics and Space Technologies (Havacılık ve Uzay Teknolojileri Dergisi)*, 7(2), 1-12.
- Chin, G., Jordan, L., Kahn, D., & Morin, S. (1975). Instrument landing system performance prediction. Paper presented at the 1975 IEEE-MTT-S International Microwave Symposium.
- Geise, R., Enders, A., Vahle, H., & Spieker, H. (2008). Scaled measurements of instrument-landing-system disturbances due to large taxiing aircraft. *IEEE transactions on electromagnetic compatibility*, 50(3), 485-490.
- Geise, R., Schueuer, J., Thiele, L., Notté, K., Beckers, T., & Enders, A. (2010). A slotted waveguide setup as scaled instrument-landing-system for measuring scattering of an A380 and large objects. Paper presented at the Proceedings of the Fourth European Conference on Antennas and Propagation.
- Geng, Y., & Ping, Z. (2015). Differential BD/ILS-GLIDESLOPE integrated approach system for improving the lateral navigation performance. Paper presented at the 11th International Conference on Wireless Communications, Networking and Mobile Computing (WiCOM 2015), Shanghai, China.
- Güner, S., Ergüzel, O. Ş., & Cebeci, H. İ. (2019). Uluslararası Havalimanlarının Operasyonel Etkinliğinin Değerlendirilmesi: Bölgesel Bir Karşılaştırma. *Alphanumeric Journal*, 7, 37-44.
- Hunting, A. W. (1972). Evaluation of Approach Procedures for ILS Back Course with Glide Slope. Retrieved from
- Jain, R. K., Shetty, P. K., & Shenoy, S. (2014). Experimental evaluation of PID and ESO controller for instrument landing system. Paper presented at the 2014 International Conference on Control, Instrumentation, Communication and Computational Technologies (ICCICCT).
- Jantz, J. D., West, J. C., Mitchell, T., Johnson, D., & Ambrose, G. (2019). Airborne Measurement of Instrument Landing System Signals using a UAV. Paper presented at the 2019 IEEE International Symposium on Antennas and Propagation and USNC-URSI Radio Science Meeting.
- Kaba, F., & Ürgün, S. (2019). Bir hassas yaklaşma prosedürü olarak ILS'in (Instrument Landing System) önemi ve uçuş gecikme maliyetlerine etkisi. *Avrupa Bilim ve Teknoloji Dergisi*(15), 333-342.
- Kazan, F. A., & Öktemer, E. (2023). Aletli İniş Sistemi. In L. Civecik (Ed.), *Mühendislik Alanında Uluslararası Araştırmalar IX* (1 ed., pp. 55-73). Uzun Dijital Matbaacılık: Eğitim Yayınevi.
- Li, Y., Yang, B., Yang, L., He, Z., Niu, K., & Wu, W. (2006). Adaptive instrument landing system in future air traffic control. Paper presented at the 2006 6th International Conference on ITS Telecommunications.
- Merkisz, J., Galant, M., & Bieda, M. (2017). Analysis of operating instrument landing system accuracy under

- simulated conditions. *Zeszyty Naukowe. Transport/Politechnika Śląska*.
- Metz, H. I. (1959). A survey of instrument approach systems in the United States. *IRE Transactions on Aeronautical and Navigational Electronics*(2), 78-84.
- Neville, J. T., & Matolak, D. W. (2004). Direct-sequence spread spectrum spectral overlay in the instrument landing system glideslope and microwave landing system bands. Paper presented at the The 23rd Digital Avionics Systems Conference (IEEE Cat. No. 04CH37576).
- Noshirvani, P., & Rezaee, A. (2010). Instrument Landing System: Enhanced Model. Paper presented at the 2010 International Conference on Signal Acquisition and Processing.
- Novák, A., Havel, K., & Janovec, M. (2017). Measuring and testing the instrument landing system at the airport zilina. *Transportation Research Procedia*, 28, 117-126.
- Novák, A., & Pitor, J. (2011). Flight inspection of instrument landing system. Paper presented at the 2011 IEEE Forum on Integrated and Sustainable Transportation Systems.
- Oduyaiya, S. A., & McFarland, R. H. (1996). A cosmetic method for ameliorating multipath effects on the ILS localizer. Paper presented at the Proceedings of Position, Location and Navigation Symposium-PLANS'96.
- Öktemer, E., & Gültekin, E. E. (2021). Operational usage and importance of instrument landing system (ILS). 2(1), 18-21.
- Özdemir, E. T., Sezen, İ., Deniz, A., & Menteş, Ş. S. (2014). Atatürk Havalimanı'nın Sis Analizi. Paper presented at the 3. Ulusal Havacılıkta İleri Teknolojiler Konferansı (HİTEK 2014), İstanbul.
- Peterson, C. G. (1976). Localizer Traveling Wave Antenna Development. Retrieved from
- Sanders, L., & Fritch, V. (1973). Instrument landing systems. *IEEE Transactions on Communications*, 21(5), 435-454.
- Tangthong, N., & Aktimagool, S. (2020). Experimental based Learning and Teaching Management for Localizer Transmitter of Aircraft Instrument Landing System. Paper presented at the 2020 5th International STEM Education Conference (iSTEM-Ed).
- Wang, Q., Shen, Z., Cheng, X., & Wang, H. (2019). A Fast ILS Electromagnetic Covering Analysis Method for New Obstacles Impact at Expanded Airport. Paper presented at the 2019 IEEE/AIAA 38th Digital Avionics Systems Conference (DASC).
- Yungaitis, E., Zhdanov, B., Zotov, A., & Voytovich, N. (2020). Application of Signals Reflected from an Aircraft for Monitoring an ILS Glide Path Position. Paper presented at the 2020 7th All-Russian Microwave Conference (RMC).
- Zhao, Q., Zhao, Y., He, J., & Dong, L. (2019). The Analysis of Instrument Landing System Signal Quality Based on QAR Data. Paper presented at the 2019 IEEE 1st International Conference on Civil Aviation Safety and Information Technology (ICCASIT).
- Zuiev, O. (2017). Instrument landing systems control processes investigation. Paper presented at the 2017 Signal Processing Symposium (SPSymo).

**Cite this article:** Oktemer, E., Kazan, F.A. (2023). Investigation of the Effect of the Instrument Landing System on Flights to Konya Airport between 2019-2022 Years. *Journal of Aviation*, 7(2), 293-299



This is an open access article distributed under the terms of the Creative Commons Attribution 4.0 International Licence

**Copyright © 2023 Journal of Aviation** <https://javsci.com> - <http://dergipark.gov.tr/jav>

# Effects of Meteorology Data on Crew Resource Management in Aviation

Altuğ Aykan Bayazıtöğlü<sup>1</sup> , Habibe Güngör<sup>2\*</sup> 

<sup>1</sup> Istanbul Gelisim University, Institute of Social Sciences, Aviation Management, Istanbul, Turkey. ([altugbayazitoglu@gmail.com](mailto:altugbayazitoglu@gmail.com))

<sup>2\*</sup> Istanbul Gelisim University, Faculty of Economics, Administrative and Social Sciences, Aviation Management (English), Istanbul, Turkey. ([hgungor@gelisim.edu.tr](mailto:hgungor@gelisim.edu.tr))

## Article Info

Received: 30 April 2023  
Revised: 01 June 2023  
Accepted: 05 July 2023  
Published Online: 19 July 2023

### Keywords:

Aviation  
Meteorology  
Aviation Safety  
Crew Resource Management  
Weather Data Management

Corresponding Author: *Habibe Güngör*

## RESEARCH ARTICLE

<https://doi.org/10.30518/jav.1290226>

## Abstract

Risks associated with meteorology must be continuously assessed and carefully managed by the flight crew to ensure the safety of flights. This study aims to examine meteorological events' favorable and unfavorable effects on crew resource management in recent aviation operations. The face-to-face interview technique, one of the qualitative research methods, was used, and data were collected in light of the information obtained from the pilot pool of 50 people. In the study, the opinions of the crews on what kind of flight management and data analysis application they carried out were taken, accompanied by questions directed through meteorology, flight safety, and crew resource management factors. The collected data were analyzed by content analysis method. As a result of the analysis, it was concluded that theoretical knowledge of stress management and a good analysis of meteorology is of vital importance. It has been evaluated that accidents and incidents that occur indirectly in aviation in meteorology can be prevented entirely, and by drawing attention to the importance of the crew resource management factor, it has been concluded that they can be prevented by working together with advanced meteorology systems and an up-to-the-date training.

## 1. Introduction

The adverse effects of the usual and erratic structure in the air have remained with us since the beginning of the history of air transportation. During its early years in aviation, the use of Crew Resource Management (CRM) for effective teamwork and good communication between the cabin and cockpit was limited to technical and cognitive methods. However, with the emergence of the importance of cognitive thinking, data analysis, and data management processes, its content has been expanded over time to help crews improve their situational awareness. Aircraft systems and resources providing meteorological data must be used effectively for pilots to conduct safe and efficient air operations. Strengthening communication and management skills within the flight crew positively impacts flight safety.

In aviation, the constant scrutinization of meteorology is an essential requirement, and more than any other mode of transport, weather variations need to be analyzed carefully (Anaman, Quaye, and Brown, 2017). It is evident that these changes significantly impact flight safety, and pilots should be

prepared to apply risk scenarios in adverse weather conditions under all situations (Howell, 2019).

For a high level of safety to be achieved here, it has to be ensured that updated technological systems and training procedures are implemented to support pilots' data tracking and flight management performance in unfavorable weather conditions (Stahl, 2016).

Humanity has studied weather phenomena for centuries to understand their implications for safe air transportation. During aviation experiments, humanity has attempted, with varying degrees of success, to gain insight into the complex dynamics of weather events. Meteorological changes from the past and their practical results have shown that meteorological reports must remain up-to-date every minute. The adverse effects of meteorology on aircraft in the process of meteorology until today have always produced striking results regarding flight performance (Gultepe and Feltz, 2019).

The following are cited among the main weather events:

- Wind (its effects during landing and take-off of the aircraft)
- Icing conditions (its effects on aircraft fuselage and engine)



- Thunderstorm (abnormal condition of aircraft during all phases of flight)

- Fog (its effect on visibility at all stages of flight)

The factors created by such weather events directly affect the aircraft's flight performance, fuel efficiency, and the economic income and expenses of the companies. Meteorological situations, covering all stages of ground and air operations, play a significant role in the realization of an operation. With up-to-date METAR (routine weather report) reports, pilots perform planned flight operations. The analysis of meteorological data should include the following features;

- Up-to-date weather conditions,
- The information regarding the expected weather conditions on the route and the destination,
- The adverse effects on flight safety, if any,
- The proper management of meteorological data and the goal of a safe flight.

For this reason, the concept of meteorology in aviation aims to ensure that the aircraft's performance is affected at the lowest level on the routes determined as a result of the up-to-date data obtained by the crews and to get the highest efficiency from the operation.

Being aware of the weather during the flight and accurately assessing the other phases of the flight is an important quality to have in flight crews. In particular, pilots are expected to take a correct and practical approach by considering flight safety during the decision-making process by analyzing meteorological data. In a regional study on this issue, 204 pilots' attitudes towards dangerous meteorological events and the management processes between them were examined in the simulation environment. The findings obtained included the following;

- Increase in the percentage of stress in hazardous weather events
- Lack of information on emerging weather events
- Insufficient division of labor among cockpit crews and insufficient data management

The study conducted among pilots serving in commercial aviation revealed that piloting and crew management processes need to be improved in the face of challenging meteorological conditions. (Keebler et al., 2018).

In another review of the same study, participant pilots were asked to interpret a ground-based infrared radar indicator in the test system. Although 32 percent of the pilots were unsuccessful in weather analysis, 8 percent of this rate was observed to have passed the meteorology exam in the FAA exam system. As a result of the system encouraging the rote-based question system, it was found that the pilots could not analyze the visual data. It was stated to the pilots in the study that the radar they viewed transmits data with a delay of 10 to 15 minutes. It was further noted that if a time difference is not noticed in the ground-based radar data arriving in the cockpit, they face a negative situation for flight safety in an aircraft flying 120 miles per hour (Blickensderfer et al., 2017).

From past to present, the adverse effects of meteorological conditions within the commercial and civil aviation industry have reached all phases of all air operations. The monitoring, analysis, and management of the weather reports to be made here are considered the primary safety factor by the flight crews. Flight safety in poor weather conditions and crew resource management are directly proportional. The opinions and techniques of experienced pilots should be taken into account here.

The negative returns of accidents and flight cancellations caused by meteorological conditions in commercial and general aviation are essential factors that reveal severe economic consequences for companies. In aviation, where the meteorology factor is so important, attention should always be paid to crew resource management based on communication and cooperation regarding the continuity of flight safety.

An in-depth literature review concluded that the relationship between meteorology and crew resource management in the Turkish and English literature still needs to be adequately studied and examined academically. This research will provide significant awareness of flight safety, the training models planned to be developed in aviation companies, and the studies to be carried out in this field in our country, and will support the development of the scheduled training processes.

In light of the above information, the primary purpose of this thesis is to determine the adverse effects of meteorology data on flight safety and to examine and reveal the usual and variable impacts of crew resource management practice on the crew.

## 2. Theoretical Framework

### 2.1. Meteorology

The atmosphere and the structural elements that make up the atmosphere, meteorological events that need attention in aviation, the ozone layer and their effects on flight operations, the radiation rates to which the crews are exposed and their effects on the health of the crews, create the dynamics that should be considered at every stage of air operation. In addition, the adverse effects of these radioactive factors on the systems existing on the fuselage structures of the aircraft are among these factors (Firat, 2019).

Meteorology in aviation directly affects all aviation operations covering every stage of flight, from general to commercial aviation. Correct analysis of meteorological data affects all aircraft's flight safety and efficiency, including airport and air traffic operations. The 1948 Chicago Convention's "Annex 3" appendix contains statements by the aviation industry about the practices and significance of providing meteorological data assistance. These remarks refer to the significance of the most comfortable, shortest, and safest transportation (Kucuk Yilmaz, 2007).

The General Directorate of State Meteorology Affairs is the only national organization in Türkiye that provides the information required for commercial and general aviation activities. Due to the importance of meteorological systems' impact on aviation safety, throughout Türkiye, approximately 54 meteorology stations have been established to provide 24/7 service to ground and air personnel. (MGM; Textbook, 2021).

In a region where meteorological events occur rapidly, it is crucial to examine the conditions within the framework of certain conditions (Noyan, 2007). These conditions are;

- Expected meteorological conditions on the flight route
- Instantly developing meteorological conditions on the flight route

The crews must be aware of the meteorological conditions on the flight route at the moments mentioned above. Aircraft can only be expected to perform their operations safely with meteorological information. In a region where sudden weather events occur, pilots should regularly check current weather data, prepare for potential weather events during their flight,

adjust their route to ensure safety and analyze data to decide if canceling the flight is necessary (Ozturk et al. 2021).

### 2.1.1. Meteorological Effects During Flight

Flight crews rely on obtaining accurate and up-to-date weather information, also known as “current weather,” in order to plan their flights effectively. Commercial air operations occur in the atmosphere's troposphere layer, frequently affected by meteorological influences caused by humidity, pressure, and temperature changes. In aviation, the meteorological factors that adversely affected flight safety are as follows;

- Fog: Visibility is crucial for aircraft approaching for landing or taking off from an airport. Excessive cloudiness caused by "water vapor" that reduces visibility, such as cloudiness, haze, etc., causes unsafe landing and take-off phases of the flight.

- One of the major problems affecting flight safety has been severe weather, including Cumulonimbus-Oraj clouds, abbreviated CB by pilots, which may cause thunder, lightning, gusty ground wind, turbulence, heavy precipitation, hail, and icing (Ozturk et al., 2021).

- Icing: The accumulation of snow and ice on the airplane's surface, which affects the airplane's weight, increases the frictional force on the aircraft, harms the lifting power, and causes the plane to require more engine performance (Unlu and Hilmioglu, 2017).

- The heights that come from the formation of clouds are known as cloud layers, and they are structures visible from the ground up. Clouds' visual mass of tiny water droplets, ice crystals, and other particles in the Earth's atmosphere have significantly impacted flight operations (Atasoy, 2015).

Due to their proximity to the ground, stratus (St) clouds, one of the lower layer cloud types, pose a severe risk to aircraft during takeoff and landing. Altocumulus (Ac) cloud type, one of the mid-altitude clouds, is a slow-forming cloud type whose base levels start at about 6500 feet above the ground and can reach up to 16,500 feet. Within this cloud type, there is no danger for the aircraft to fly under observation and for a short period. Among the high-altitude cloud structures, Cirrus (Ci) type clouds form similar cloud types in the form of tiny ice crystals, very thin or narrow lines above 16,500 feet (MGM: Textbook, 2021).

The occlusion rate, which occurs depending on the cloudiness levels, constitutes an essential meteorological data reporting due to its effects on the operation-oriented activities of the aircraft and flight safety. The terms of view in these data reports created a system divided into 8 equal parts by the experts to express the vertical view. This system, which includes 8 octa measurement units, informs the crews about the cloud cover rate in any region through the Aviation Routine Weather Report (METAR) and various meteorological station data (Gultepe, 2007).

**Table 1.** Cloud Capacity (octa) rates

Cloud Amount	RATIO/OCTAS	Abbreviation
Sky Clear	0	SKC
Few	1/8 – 2/8	FEW
Scattered	3/8 – 4/8	SCT
Broken	5/8 – 7/8	BKN
Overcast	8	OVC

**Source:** Meteorology Textbook, (2018).

- Wind: The most dangerous wind for airplanes was the Low-Level Windshear. In their research, ICAO and the US Federal Aviation Administration (FAA) have found that wind shear plays a vital role in most accidents, especially during the approach and landing phases, which are the most critical phases of flight and is recognized as potential hazard for aircraft (Frost and Bowles, 2012). There are 3 types of wind depending on the direction of travel of the aircraft: 1) Headwind, 2) Crosswind, and 3) Tailwind (Atasoy, 2015).

The crews performing air operations can be divided into 4 main stages. At these stages, flight crews are expected to manage meteorological data correctly and carry out safety management processes for the division of labor within the crew during the pre-flight, take-off, cruise, and landing phases.

### 2.1.2. Pre-Flight Phase

The weather has often been an influential factor in aviation accidents and air traffic. Researchers have observed that pilots play a critical role in evaluating the latest weather events and current radar data before take-off.

The research by the FAA revealed that, during the pre-flight ground briefings, pilots needed more meteorological information about recent and due-to-occur meteorological events. The research further revealed that, during adverse weather conditions occurring on route or at airports, the Automatic Flight Service Station (AFSS) canceled and changed nearly 70 percent of the plans entered into the flight planning system.

A study on planning within AFSS found that during adverse weather conditions, 78 percent of the pilots flying on that day requested briefing information from the system. The remaining percentage was unaware of the adverse weather conditions on the route and committed rule violations in the face of unanticipated complex management during the flight (FAA, Preflight, 2007).

### 2.1.3. Take-Off Phase

The weather forecast data provided to flight crews for take-off is usually delivered to the planning and flight crew 2 to 3 hours before the operation. The forecast information during the planned departure period of the aircraft provides the necessary data to the crews regarding the expected surface wind, temperature, atmospheric pressure, and weather conditions on and around the airfield. Careful crew management for the take-off phase is needed; extra information on significant events such as precipitation conditions and strong wind warnings must be analyzed in detail due to their negative impact on flight safety (WMO: Guide, 2003).

With the "Trajectory Options Program (CTOP)" system, which is planned to be implemented for the restrictions of airspaces and the cancellation of aircraft departures, it is aimed that the airline companies will provide safe options to the pilots by making a detailed analysis of the adverse weather conditions occurring on the planned departure and route by artificial intelligence. As a result, it aims to reduce pilots' workload during take-off and to make healthy data management accompanied by safe plans analyzed by artificial intelligence (Arneson et al., 2017).

### 2.1.4. Cruise Flight Phase

Flight crews must receive detailed, up-to-date data on weather events occurring at every phase of the air operation. In all aircraft fleets used by airlines and private jet crews, the change of meteorological data is carefully monitored to ensure

optimum cruise performance. Dangerous weather events on the route can adversely affect the aircraft's outer surface. An aircraft deviating from its current route may result in higher fuel consumption or safety issues. (Chu, Gorinevsky and Boyd, 2010).

During the flight's cruising phase, "storms" have been the most critical weather events that affect flight safety and aircraft performance. Regarding new route calculations, crews are recommended two methods for calculating aircraft mass and performance conditions and ensuring flight safety. These methods can also be applied to examine the distribution functions of the management process (in the case of certain weather events) and fuel consumption (in the case of a specific range) among the pilots and to alleviate the workload among the crews (Vazquez and Rivas, 2013).

### 2.1.5. Landing Phase

In aviation, the landing phase plays a significant role in the safe flight of an aircraft from point A to point B by correctly analyzing the weather data. Landing planning in lousy weather conditions is an essential problem for the air traffic system. In these conditions, various systems have been implemented to assist pilots, including ILS and Microwave Landing System (MLS), which greatly facilitate the stress management of landing. Although these systems are helpful, they are generally only available in major airports in metropolitan areas due to their high cost.

It has been observed that the landing systems, which provide great convenience to the crews in the data management process, positively affect the intensified air traffic due to weather conditions and reduce the delay times of the flights. In addition to these landing systems aiding pilots, the introduction of the Corridor Integrated Weather System (CIWS) offers up-to-date information on aircraft approach processes for traffic flow management in congested areas (Evans et al., 2016).

## 2.2. Crew Resource Management

The validity of CRM training in commercial aviation, including the switch from the cockpit to CRM, is still up for debate. There have been modifications and variations of CRM across different cultures, including a lack of cross-cultural generalization.

Crew Resource Management training in the United States, one of the pioneers of CRM, has its roots in a NASA-sponsored workshop called "Resource Management on the Flight Deck" in 1979. This conference expanded NASA's research into the causes of air transport accidents and identified the majority of accidents caused by severe weather conditions as failures in poor communication, decision-making, leadership, and inadequate data management due to human error. In order to reduce "pilot error" by better use of human resources and management on the flight deck, Cockpit Resource Management (CRM) was first applied during the crews' training process (Helmreich, Klinec and Wilhelm, 1999). New training programs are always needed to improve the interpersonal aspects of flight operations. In this sense, CRM training programs have found widespread use worldwide to train and prepare pilots under challenging conditions. The CRM training aims to achieve a permanent safety attitude by trying to solve the problems encountered in changing the attitudes and behaviors of flight crews under certain phases.

Over the years, the CRM phases have expanded to include

management techniques that can assist pilots, providing a systematic system of procedures in emergencies and integrating them into the cabin crew. In this direction, a simulated flight scenario application between two or more points on threat and data error management training, preventive measures, weather recognition, avoidance and management strategies has been included in the system as a beneficial training program for airlines today. These scenario-based learning tasks involve a combination of conducting flight operating procedures under normal, ordinary, and variable weather conditions. A modern training update for the CRM phases will increase the potential cost of air carriers and prevent possible accidents (Wagener and Ison, 2014).

CRM goals include:

- Awareness of concepts
- Discussing the different philosophies and goals of crew resource management training
- The ability of pilots to use data management correctly and safely in average weather conditions.
- Improving the crew's ability to use data sources

### 2.2.1. Factors of Crew Resource Management

The factors of CRM allowed the factors for the causes of aircraft crashes to evolve after the introduction of FDR and CVR devices to modern jet aircraft. The information obtained from these devices is not the result of many accidents due to a technical malfunction of the aircraft or systems, a failure in the ability to operate the aircraft in adverse weather conditions, or the lack of technical knowledge of the crew; instead, it appears to be due to the crew's inability to respond appropriately to the situation while they find themselves in it. CRM factors that affect the crew are as follows:

*Decision-Making:* In flight crews, distinctions between personality traits and decision-making are made. The decision-making process, especially by forming a whole with situational awareness, can only choose the best management form if the flight crews completely understand the situation. Here, the most significant factor affecting the decision-making process is various prejudices, and it can be demonstrated that people's culture and characters have a negative impact on the flight operation process and decision-making (Kearns, 2021).

*Leadership management:* The enhancement of leadership abilities and ensuring crew members collaborate to accomplish tasks safely in adverse weather conditions are two primary purposes of CRM training. It primarily aims to enable inexperienced co-pilots to learn their leadership roles in variable meteorological conditions and to lead the flight when the captain is inadequate (Sekerli, 2006).

*Crew Cooperation:* Studies examining the relationship between social culture and CRM in crew cooperation show that subordinates have limited dependency on their superiors and feel more comfortable defending different opinions in cultural environments with low power distance. In cultural environments where power distance is high, on the contrary, it is stated that subordinates are overly dependent on their superiors. In such environments, they need to be at the desired level of questioning their superiors, approaching them comfortably, and defending different ideas (Set, 2019).

*Situational Awareness:* Situational awareness refers to the process by which flight crews can follow and analyze the weather conditions in their environment. Situational awareness has several critical factors for the crew:

- Perception of ongoing environment and weather conditions throughout the flight



- Understanding the current variable weather pattern
- Forecasting the impact of meteorological data on flight safety.

When these behavioral attitudes are adopted during the flight, the desired level of contribution to flight safety and ECM practices can be achieved. Through accurate and up-to-date data sharing, crew members can always keep their situational awareness fresh. As a result, the decision-making process is supported more effectively (Set, 2019).

### 2.3. The Relationship between Meteorology Data and Crew Resource Management in Aviation

Due to its structure, aviation has been an important industry where dangers and risks have arisen intensively. This sector should have understood the concept of safety compared to other sectors and should have adopted a top-level management approach to prevent hazards. Even if all safety precautions are taken, the occurrence of human-induced errors cannot be eliminated entirely. Regarding safety, it is vital that the workload and intensity of the crews can be controlled, regardless of the type of meteorological situation (Kurnaz, 2018). Meteorology data plays a crucial role in aviation safety, particularly in the area of CRM. CRM is a set of procedures and skills that pilots and crew members use to manage and mitigate the risks of flying an aircraft. Meteorology data provides critical information to pilots and crew members, allowing them to make informed decisions regarding flight safety. This information includes current and forecast weather conditions, such as wind speed and direction, visibility, cloud cover, and precipitation. With this information, pilots can decide the best route, whether to delay or cancel a flight due to adverse weather conditions and what precautions to take in flight. Crew members can also use meteorology data to prepare the aircraft for takeoff and landing, such as ensuring that the runway is clear of debris and that the aircraft is adequately de-iced.

Effective CRM requires pilots and crew members to work together to ensure the safety of the flight. This includes effective communication, such as sharing information about weather conditions and making decisions as a crew. Using meteorology data, pilots and crew members can make informed decisions about flight safety and work together to ensure a safe and successful flight.

The crew readily recognized that resource management, flight safety, and meteorology concepts and training could improve aviation safety. CRM now includes the entire flight operations crew, including pilots, cabin crew, dispatchers, air traffic controllers, and maintenance. Specific crew resource management between meteorology and flight safety should avoid complacency in all circumstances and continually evaluate our CRM programs to ensure that the flight safety objective is met as the current data analysis and management environment changes (Kolander, 2019).

## 3. Methodology

### 3.1. Research Method

The qualitative research model was used because it allows for an objective evaluation and in-depth investigation of experienced pilots who are knowledgeable and responsive to crew resource management and meteorology issues in the face of phenomena such as how pilots balance their stress levels under adverse and abruptly changing weather conditions, which phases of the flight create more challenging conditions,

how to gain experience under these conditions and what training equipment should be used.

### 3.2. Population and Sample of the Research

The population of this study consists of pilots employed by private capital and public-based airline companies within the scope of Turkish civil aviation who have professional experience and are fleet members and teachers and those who have objective views and information about meteorology, CRM, and flight safety. The maximum diversity sampling strategy was used to reveal different perspectives, analyses, and management examples on the same subject due to the specific competencies and characteristics of the flight crews that could represent the phenomenon involving this research.

### 3.3. Data Collection Tools

The interview method, one of the qualitative research methods, was used to obtain detailed information on meteorology, crew resource management, and flight safety by asking questions that would reveal detailed, confidential information and methods from pilots with high flight hours and seniority levels related to the research subject.

The interview questions were generated from a thorough literature review since there is no example research in the literature. Below are the research questions that have been used in the interview to accomplish the study's primary goal:

1. What data do you think is one of our resources regarding crew resource management during the flight?
2. Do you think meteorological data is one of our resources in terms of crew resource management? Why?
3. What do you think about the relationship between meteorology, safety, and crew management?
4. Which phases of flight, in particular, require an effective data management process?
5. Which conditions in the METAR reports affect long-term flight safety, and do they have any effects?
6. Which meteorological conditions can become so severe during the landing phase of the flight that they often cause concern for flight crews?
7. What is the attitude of the crews towards meteorological reports that abruptly change? Are stress-induced, hasty, and erroneous data evaluations experienced in these sudden situations?
8. Is it possible to have a practical skill aspect that every pilot should have in adverse weather conditions? If possible, what skills and competencies are essential?
9. What kind of training and evaluation process should the airline companies that will serve within the scope of commercial aviation include in the training and evaluation process of the pilots in the face of meteorological conditions?
10. What is the benefit of simulating difficult meteorological conditions in simulation or training flights?
11. What countermeasures should be provided regarding flight safety to detect mistakes made by pilots and reduce their consequences?

### 3.4. Data Analysis

This research gathered data by conducting a thorough content analysis of the interview-based answers, a qualitative data-gathering technique. With the semi-structured interview technique performed here, the data acquisition and analysis processes could be explored in more detail, and all the data



values were observed. Participants in the research were asked questions within the framework of four main problems: Meteorology, CRM, flight safety, and flight phases. Based on the data obtained, with the aim of an in-depth examination, information showing similar characteristics was coded and classified within themselves, allowing the emergence of structures related to the research purpose. Tables were created and transferred by analyzing the frequent use of these structures that emerged here.

#### 4. Result and Discussion

##### 4.1. Demographic Information on Participating Pilots

Tables 2 and 3 provide information about the participating pilots, including their demographic characteristics.

**Table 2. Information on Participants**

Participants Codes	Gender	Age	Level of Education	Experience Years
P1	Male	63	Bachelor's	43
P2	Male	43	Bachelor's	5
P3	Male	40	Bachelor's	5
P4	Male	46	Bachelor's	28
P5	Female	39	Bachelor's	15
P6	Male	39	Bachelor's	12
P7	Male	39	Bachelor's	7
P8	Male	44	Master's	19
P9	Male	28	Bachelor's	6
P10	Male	47	Master's	25
P11	Female	35	Bachelor's	4
P12	Male	39	Bachelor's	12
P13	Male	45	Bachelor's	20
P14	Male	39	Bachelor's	10
P15	Male	60	Bachelor's	25
P16	Male	60	Bachelor's	20
P17	Male	59	Bachelor's	20
P18	Male	40	Bachelor's	14
P19	Male	45	Master's	10
P20	Male	45	Bachelor's	15
P21	Male	45	Bachelor's	10
P22	Male	60	Master's	25
P23	Male	56	Bachelor's	20
P24	Male	60	Bachelor's	15
P25	Male	60	Bachelor's	25
P26	Male	55	Bachelor's	15
P27	Male	38	Master's	8
P28	Male	55	Bachelor's	15
P29	Male	38	Bachelor's	10
P30	Male	40	Bachelor's	15
P31	Male	39	Bachelor's	10
P32	Male	55	Bachelor's	15
P33	Male	38	Bachelor's	10
P34	Male	50	Bachelor's	25
P35	Male	46	Bachelor's	20
P36	Male	43	Bachelor's	10
P37	Male	55	Bachelor's	25
P38	Male	40	Bachelor's	20
P39	Male	45	Bachelor's	15
P40	Male	60	Bachelor's	30
P41	Male	37	Bachelor's	8
P42	Male	45	Bachelor's	20
P43	Male	47	Bachelor's	20
P44	Male	60	Bachelor's	30
P45	Male	37	Bachelor's	10
P46	Male	42	Master's	10
P47	Male	60	Bachelor's	40
P48	Male	39	Bachelor's	10
P49	Male	39	Bachelor's	7
P50	Male	48	Bachelor's	10

Participants were coded as P1, P2, P3, P4, P5, P6,.....P50 based on the interview's order. To understand crew resource management components, it is aimed to get more efficiency from the participants.

**Table 3. Information on Participants**

Seniority	Flight Hours	Aircraft Type	Company Business Model
Cpt.	25000	A350	Full Service
F/o	3000	A320	Low Cost
F/o	3500	A320	Low Cost
Cpt.	7500	A320	Low Cost
Cpt.	12000	A320	Full Service
Cpt.	8800	B737	Low Cost
F/o	3800	B737	Low Cost
Cpt	20000	A330	Full Service
F/o	2900	A320	Full Service
Cpt	25000	B737	Regional
F/o	2000	A320	Full Service
Cpt	10000	B737	Full Service
Cpt	20000	B777	Full Service
Cpt	8000	A320	Regional
Cpt	30000	A320	Regional
Cpt	25000	A330	Full Service
Cpt	30000	B777	Full Service
Cpt	15000	A320	Low Cost
Cpt	10000	B737	Low Cost
Cpt	12000	A320	Full Service
Cpt	10000	A320	Full Service
Cpt	25000	B737	Low Cost
Cpt	25000	B737	Low Cost
Cpt	30000	B777	Full Service
Cpt	30000	B737	Regional
Cpt	20000	B737	Low Cost
Cpt	55000	B737	Full Service
Cpt	20000	A350	Full Service
Cpt	6500	G550	Business
Cpt	8000	CN235	General
Cpt	9000	G450	Business
Cpt	20000	B737	Regional
Cpt	7500	CN235	General
Cpt	10000	B737	Full Service
Cpt	12000	B737	Low Cost
Cpt	10000	B737	Low Cost
Cpt	15000	B737	Low Cost
Cpt	10000	B737	Low Cost
Cpt	12000	A320	Full Service
Cpt	20000	B737	Full Service
Cpt	7000	B737	Full Service
Cpt	15000	B737	Full Service
Cpt	15000	B737	Full Service
Cpt	25000	B737	Low Cost
Cpt	6500	A320	Low Cost
Cpt	8000	A320	Regional
Cpt	30000	A350	Full Service
Cpt	7500	G550	Business
F/o	4500	LJ45	Business
Cpt	15000	LJ45	Business

Face-to-face interviews were conducted with the above-mentioned pilots of Turkish Civil Aviation with sufficient professional experience and knowledge about the research topic and questions. The features of the 50 pilots who participated in the interviews are as follows;

- 4% female, 96% male
- 38% are 40 years old and under, 62% are over 40.

- 14% graduate, 86% undergraduate
- 60% have 15 years or less of professional experience, 40% have more than 15 years of professional experience
- 12% co-pilot, 88% captain pilot
- 66% of them have 15 thousand hours and fewer flight times, 34% have more than 15 thousand hours of flight time
- 16% fly in wide body, 84% fly in narrow body aircraft type

Pilots with different features were involved in the research.

#### 4.2. Crew Resource Management and Flight Safety Phases

Full-service airlines, which outperform many low-cost airlines in terms of flight frequency worldwide, can provide us with precise insights into the use of crew resource management factors that affect various aspects of the aviation industry. It can provide sensitive information about the flight operations of most participants across several continents and the various flight phases they have experienced under diverse meteorological conditions. In Table 4, themes will be created through coding in five main problems, and the views and frequency of use of these themes will be analyzed by grouping them according to specific characteristics.

**Table 4.** Crew Resource Management and Flight Safety Phases

Theme	CODING	Frequency of Codes
Meteorological Factors and Flight Safety Phases	Briefing phase	12
	Take off phase	17
	Cruise phase	10
	Landing phase	30
	All phases	11

Table 4 shows the participant pilots' evaluation of meteorological conditions on flight safety phenomena. According to the assessment of some participants, weather conditions affect all phases of the flight, adversely affecting flight safety. When the effect of the briefing phase on the planning is examined according to Table 3, few participants stated that the flight planning could affect the cancellation process. It was determined that the decision to cancel the flight according to the weather conditions while the flight personnel was on the ground did not have an effect in terms of stress but negatively affected the service quality.

According to some responses to the research questions, there is a risk that weather conditions will impact the aircraft up to a particular altitude during takeoff. On the other hand, it is seen that going to a different airport in a wide area can be managed more calmly and comfortably in terms of planning. According to the pilots' statements, the landing phase reduces the safety of the participant pilots under wind shear and heavy rain conditions and puts them into challenging conditions.

The participants drew attention to some facts regarding the flight phases of adverse weather conditions. Here are a few examples:

- “Especially the deterioration of adverse weather conditions is the first factor for flight cancellations during

landing and take-off. The impact of meteorological information and the pre-departure briefing is high, as an indirect factor in forcing the geographical conditions in the airport area and in the case of out-of-limits. The plan's content to be implemented is revealed by examining the topographic geography and creating the resources for safety and crew management (P1).

- “If we have enough time to analyze the threats and risks that may occur during the briefing, especially during the cruising phase, we will be ready for an effective data management process in the decision-making phase (P4).”

- “METAR reports are critical in landing and take-off. If there is a wind shear at take-off and crosswind limits are very high on approach, the possibility of diverting and holding may cause disruptions in service quality (P34).

Table 4 reveals that pilots mentioned the impact of meteorology on aviation and its detrimental effects on all aspects of flight operations. The participating pilots have firsthand knowledge of the need to understand the fundamentals of METAR data, the importance of solid communication between flight crews in the event of abrupt changes in the weather, and the need to take swift action to deal with challenging weather conditions. Since air-related problems may occur at these levels, stress and workload on the cockpit crew may adversely affect flight safety. For the flight crew to maintain their competence during the flight, conducting more thorough training on the necessary weather report data related to these situations is essential. One of the issues stressed by the pilots is the importance of simulator training planning for such extraordinary situations. The pilots' awareness of sudden speed loss and altitude changes likely to occur indirectly during the flight is another crucial point that requires practice and self-confidence. Pilots need to be aware that these sudden illusions can occur at every phase of the flight, and in such circumstances, the pilots need to know what steps they need to take toward the flight instruments. When the pilots' opinions are examined in general, it is seen that flight operations are adversely affected by the various meteorological formations created by the weather conditions. In addition, according to the participants, it turns out that this phenomenon has a negative impact on both material and passenger comfort by causing more fuel consumption economically.

#### 4.3. Accident Events and Factors

The meteorology factor is very high in aviation accidents and crashes. Against this natural structure that can change and disrupt the global flight network every minute, companies should be able to correctly integrate the primary crew management model into their systems and create an auxiliary system that can be followed with technology.

The pilots' opinions regarding the situations where specific requirements cannot be met in the accident factors are reflected in Table 5.

**Table 5.** Accident & Incident Factors

Theme	CODING	Frequency of Codes
Team Resource Management Factors	Decision making	10
	Leadership	15
	Crew Cooperation	17
	Situational awareness	10
	Performance under stress	20
	Skill and competence	19
Meteorological Data	Data tracking	14
	Data sharing	16
	Data analysis	10
	Data management	17
Safety Management	Identifying risks	10
	Analysis of risks	12
	Risk management	9
Documentation	Education	39
	Check-list usage	6
	Experience	32

In particular, the reflected results of the lack of certification and the factors affecting the economic, service, and future developments of airline companies in line with the opinions expressed by the participants were created and reflected in the table. More than half of the pilot's state that inadequacy of training and experience negatively affects the industry and that the communication and management in the cockpit are of poor quality.

- “Commercial airlines should not reduce the number of pilots with over 20 years of experience below 50 percent. The best way to pass on knowledge is to retain highly experienced pilots and officially train them in a master-apprentice relationship. (P27).

- “Meteorology education, which will start in flight schools in particular, may enable commercial airline companies to train candidates with quality information and a certain level of competence in data analysis more efficiently (P40).”

It is necessary to record data management errors of airline companies. The participants stated that it is essential to provide support to the pilots by sharing the questions about which CRM factor was used for the mistake made, how it was reacted, and what should have been done with all the pilots within the company and by analyzing with experience when the same situation is encountered in the future stages. Regarding Table 5, the participants reaffirmed that the simulation training included in the training content supported improving skills, competence, stress management, decision-making authority, and pilotage characteristics under challenging conditions. As much situational awareness as possible can be used in effective data management for the existing cockpit crew, and it is seen as a high factor in making important decisions in emergencies.

## 5. Conclusion

Crew resource management has laid the foundation for the first research since the early days of commercial aviation due to the demands for flight safety from meteorological indirect incidents and accidents and the rapid improvements in aviation technology. The failure to properly apply the decision-making mechanism and the lack of communication in the human aspect led to the events and accidents that began to happen due to meteorology. Research has shown that pilots could not perform rescue maneuvers in most aircraft crashes brought on by wind shear occurrences that pushed the aircraft's aerodynamic properties too far. This was due to their inexperience and lack of training. The crew resource management component, which has been steadily introduced and is now one of the primary factors reducing the error rate in the decision-making phase, has been added to the communication, coordination, and data management procedures in the cockpit of piloting errors. With a better grasp of resource management and the ability to analyze and handle meteorological data more successfully, the crew was able to play an essential role in improving flight safety due to these studies.

The study's use of the CRM discussions included the sub-dimensions of CRM, the consequences of bad weather, the idea of flight safety, and the connections between them. Numerous studies conducted in the past have determined the significance of meteorology in the service industry and civil aviation. In the same way, several studies have backed up the importance of the CRM concept for flight safety in aviation, as shown in this study's literature review section. But in terms of flight safety and flight operations, this study discusses the value of crew communication for better management of pilots' CRM skills in adverse weather.

Within the scope of this study, data were collected by face-to-face interview method applied to pilots working in private and public-based commercial airline companies within the range of Turkish civil aviation. The study's findings can be categorized as follows according to the research questions it generated:

- Experience and practical gain in adverse weather conditions positively affect CRM skills; positive use of communication in the cockpit is more successful in managing CRM.
- Pilot skills, especially in ensuring flight safety; It has been observed that flight crews with better self-awareness, social awareness, self-management, and relationship management skills are more likely to comply with the rules of the airline they work for and successfully maintain their composure.

The failure to properly apply the decision-making mechanism and the lack of communication in the human aspect led to the incidents and accidents that started occurring due to meteorology. In the research, it has been seen that the pilots could not perform the rescue maneuvers due to the lack of experience and training, especially due to the wind shear event pushing the aerodynamic properties of the aircraft excessively in most aircraft crashes.

The crew resource management component, which has been steadily introduced and is now one of the primary factors in reducing the error rate in the decision-making phase, has been added to the cockpit's communication, coordination, and data management procedures that reduce piloting errors. As a result of this research, the crew started to play an influential

role in flight safety with an understanding of resource management. It enabled the analysis and management of meteorological data more effectively.

Pilots are obliged to monitor flight safety in the cockpit continuously. When we examine the universe of research in this direction, it is a research that focuses on diversity and aims to collect data from a sizable sample by interviewing 50 participants who are knowledgeable in the positive and negative effects of meteorological data on crew resource management in terms of flight safety and who also have strong views and firsthand knowledge of these phenomena.

As a result, the high level of communication and awareness in the cockpit will lead to increased business data tracking. Thus, the success of airline companies consisting of individuals with sufficient theoretical knowledge and high communication skills will be sustainable. Although only a few studies have been conducted in the literature on the importance of crew resource management to prevent or minimize accidents, it has been observed that the training provided needs to be improved in management and theory and that the pilots have difficulties during sudden adverse weather conditions. For this reason, the airline company should give importance to and develop experienced captains' skills. Thus, they can achieve their goals of attaining a higher flight safety rate.

#### Limitation & Further Research

The study has some limitations. Data were collected only from pilots flying in Türkiye. The relationship between CRM skills and emotional intelligence can be examined with different measurement scales. The application can be expanded to a larger sample, including cockpit crews and other fields of activity in the aviation industry. Emotional intelligence education ought to be a part of the school curriculum since those with high emotional intelligence are successful and can maintain this success in practically every area of life.

#### Practical Implementations

To prevent accidents in aviation, meteorology, and communication-based procedures should be adapted to the Crew Resource Management Training of pilots who continue their flight activities. Experience during adverse weather conditions positively affects flight safety culture. In this sense, managers must integrate CRM workshops into pilot simulation training programs to develop teamwork, stress management, communication, meteorology data management, and decision-making skills in aviation. However, in the recruitment process of new pilots, it should be essential to measure whether they have positive attitudes toward crew resource management and crew resource management skills, and some tools should be developed to make these measurements.

Organizing stress management workshops or training sessions in the cockpit environment is necessary to teach pilots techniques for managing work-related stress. So much so that "Individual Stress Awareness" positively affects the flight safety culture. For this reason, it is essential to be aware of personal concerns like stress, risking flight safety, taking into account the human factor, experience, and exhaustion in accidents that take place in adverse weather conditions. This cognitive safety mechanism, which reveals the individual mistakes of the person, will positively affect flight safety by encouraging the transfer of corporate failures as learning opportunities and experiences rather than as a punishment method.

#### Ethical approval

Not applicable.

#### Conflicts of Interest

The authors declare that there is no conflict of interest regarding the publication of this paper.

#### References

- Anaman K. A., Quaye R. and Brown B.O. (2017). Benefits of aviation weather services: A review of international literature. *Research in World Economy*, 8(1), 45-58.
- Ameson, H., Bombelli, A. and Tse, A. (2017). Analysis of convective weather impact on pre-departure routing of flights from Fort Worth Center to New York Center. 17th AIAA Aviation Technology, Integration, and Operations Conference.
- Atasoy, E. (2015). Investigation of factors affecting the productivity of a flight training organization, Anadolu University, Institute of Science and Technology, Eskişehir.
- Blickensderfer, B., Lanicci, J., Guinn, T., Thomas, R., King, J., Ortiz, Y., and Thomas, R. (2017). Assessing general aviation pilots understanding of aviation weather products. *The International Journal of Aerospace Psychology*, 27(3-4), 79-91.
- Chu, E., Gorinevsky, D. and Boyd, S. (2012). Detecting aircraft performance anomalies from cruise flight data. Aerospace Research Central, AIAAInfotech@Aerospace, Atlanta, Georgia.
- Evans, J., Robinson, M., Crowe, B., Klinge-Wilson, D. and Allan S. (2016). Reducing severe weather delays in congested airspace with weather decision support for tactical air traffic management, 5th Eurocontrol/FAA ATM R&D Seminar, Budapest, Hungary.
- Federal Aviation administration, FAA: An analysis of preflight weather briefings: final report (2007). Office of Aerospace Medicine, Washington, DC.
- Firat, A. (2019). Human factor in aviation, crew resource management and evaluation of turkish flight crews in terms of crew resource management performance, Istanbul University, Institute of Social Sciences, Department of Transportation and Logistics Management.
- Wagener, F. and Ison, D. (2014). Crew resource management application in commercial aviation.. *Journal of Aviation Technology and Engineering*, 3(2), 2–13.
- Gultepe, I. (2007). Fog and boundary layer clouds: Introduction. In: *Fog and boundary layer clouds: Fog visibility and forecasting*. 164, 1111-1115.
- Gultepe, I. and Feltz, F. W. (2019) Aviation meteorology: Observations and models. Introduction. *Pure and Applied Geophysics*, 176(5), 1863–1867.
- Helmreich, R.L., Klinect, J.R., and Wilhelm, J.A. (1999). Models of threat, error, and CRM in flight operations. Proceedings of the Tenth International Symposium on Aviation Psychology, Columbus, OH: The Ohio State University, 677-682.
- Howell C. (2019). What Is aviation safety. SMS Pro Aviation Safety Software Article Blog Airlines & Airports.
- Keebler, J. R., Lazzara, E. H., Blickensderfer, E., and Looke, T. D. (2018). Human factors applied to perioperative process improvement. *Anesthesiology Clinics*, 36(1), 17-29.
- Kearns, S.K. (2021). Fundamentals of international aviation. Nobel Academic Publishing. 2nd Edition.
- Kolander, C. K. (2019). Flight and Cabin Crew Teamwork: Improving Safety in Aviation. In: *Crew Resource Management*. Third Edition, London Elsevier Academic Press.



- Kucuk Yilmaz, A. (2007). Enterprise Risk Management in the Airports: The Model Suggestion for the Ataturk Airports Terminal Operations Company Anadolu University Institute of Social Sciences, Department of Civil Aviation Management, Eskişehir.
- Kurnaz, S. (2018). The relationship between safety culture perception and employee performance: a research master's thesis on aircraft maintenance personnel. Inonu University, Institute of Social Sciences, Department of Business Administration, Malatya. 112.
- Meteorology Textbook, (2018). General Directorate of State Airports Authority, Department of Navigation, Air Traffic Directorate.
- Meteorology Textbook, MGM: Textbook (2021). General Directorate of Meteorology, Department of Navigation, Air Traffic Directorate.
- Noyan, T. (2007). Analysis of environmental factors in aircraft accidents and incidents. Ankara University, Institute of Health Sciences, Department of Interdisciplinary Forensic Medicine, Department of Physical Analysis and Criminalistics.
- National Global Climate Report – Annual, (2016). National Centers for Environmental Information. <https://www.ncei.noaa.gov/access/monitoring/monthly-report/global/201611>
- Ozturk, F., Fazla, H., Rukiye, A. A. and Kotil, T. (2021). Aviation and meteorology, European Journal of Science and Meteorology, 25, 131-138.
- Sekerli, E. B. (2006). Crew resource management and cultural differences: An application on Turkish pilots. Anadolu University Institute of Social Sciences, Department of Civil Aviation Management, Eskişehir.
- Set, N. (2019). The Effect of emotional intelligence on crew resource management skills of cabin attendants. Yeditepe University, Department of Business Administration.
- Stahl, S. (2016). The Evolution of Aviation Safety. Aero Crew News. <https://aerocrewnews.com/education-2/safetywx/safety-matters/the-evolution-of-aviation-safety/>
- Unlu, D. and Hilmioglu N, (2017). Icing on airplanes and methods to prevent icing. Journal of Sustainable Aviation Research, 2(2), 75-80.
- Vazquez, R. and Rivas, D. (2013). Propagation of initial mass uncertainty in aircraft cruise flight. Journal of Guidance, control and Dynamics, 36(2), 415-429.
- World Meteorological Organization-Annual Report 2003, WHO: Guide To Practices For Meteorological Offices Serving Aviation. WMO-No. 732, Second edition.

---

**Cite this article:** Gungor, H., Beyazitoglu A.A. (2023). Effects of Meteorology Data on Crew Resource Management in Aviation. Journal of Aviation, 7(2), 300-309.



This is an open access article distributed under the terms of the Creative Commons Attribution 4.0 International Licence

**Copyright © 2023 Journal of Aviation** <https://javsci.com> - <http://dergipark.gov.tr/jav>

# The Importance of Periodic Oral and Dental Health Examination of Aircrew

Gürkan Raşit Bayar<sup>1</sup> , Güneş Işık Sanal<sup>2</sup> , Şükrü Hakan Gündüz<sup>3</sup>  and Abdurrahman Engin Demir<sup>4\*</sup> 

<sup>1</sup> Gulhane Faculty of Dentistry, Department of Oral and Maxillofacial Diseases and Surgery, Ankara, Türkiye (gurkanbayar@yahoo.com)

<sup>2</sup> Gulhane Faculty of Dentistry, Department of Oral and Maxillofacial Diseases and Surgery, Ankara, Türkiye (gunessanal@gmail.com)

<sup>3</sup> University of Health Sciences, Institute of Defensive Health Sciences, Department of Aerospace Medicine, Ankara, Türkiye (sukruhakan74@gmail.com)

<sup>4\*</sup> University of Health Sciences, Institute of Defensive Health Sciences, Department of Aerospace Medicine, Ankara, Türkiye (aengindmr@hotmail.com)

## Article Info

Received: 03 April 2023

Revised: 30 April 2023

Accepted: 15 May 2023

Published Online: 16 July 2023

### Keywords:

Aircrew

Oral and dental health

Periodic examination

Flight crew

Corresponding Author: Abdurrahman Engin Demir

## REVIEW ARTICLE

<https://doi.org/10.30518/jav.1275421>

## Abstract

The importance given to aviation and space science has increased with the advanced technological breakthroughs that made the 21st century to be called the "Space Age". As the aviation industry evolved, it was found that exposure to flight conditions and atmospheric pressure alterations has a variety of adverse effects on the physiological and psychological states of aircrew. There are several disorders that might cause medical incapacitations and thus jeopardize flight safety in such conditions. Oral, dental, and maxillofacial diseases are among those that, although manifesting locally, affect all bodily systems. For this reason, the diagnosis and treatment of such disorders should be thoroughly evaluated and carried out in accordance with aeromedical concerns. The purpose of this review is to emphasize the importance of periodic aeromedical examinations for the prevention of potential oral and dental health-related diseases, as well as medical issues of aircrew that require special attention in terms of flight safety.

## 1. Introduction

High altitude, changes in air pressure levels and accelerative (G) forces caused by discrete high-speed flight maneuvers are some of the unfavorable environmental effects of aviation that may cause serious medical problems for aircrew. For this reason, they are subjected to detailed aeromedical examinations on a regular basis. The basic requirement for medical fitness to fly cannot be simply defined as the absence of disease. Besides, good health does not always mean fitness to fly, and disease of aircrew does not always imply unsuitability. A healthy person who has minor illnesses may be less fit to fly than a chronically ill person at times and in certain situations. From the viewpoint of the certifying authority, aircrew may be considered fit to fly if they are at or above the mental and physical level necessary to carry out flight duties safely under all flight conditions, and if it is safe to assume that the certificate will remain valid for the duration of its expiration (JAA, 2009).

There are several disorders that might cause medical incapacitations and thus jeopardize flight safety. Oral, dental, and maxillofacial diseases are among those that, although manifesting locally, affect all bodily systems. Even if an aircrew member is fully asymptomatic, an insidious condition such as dental caries and, eventually, acute pulpitis, which may

cause severe pain within minutes of onset, might have a negative effect on flight missions. Clinical and radiographic evaluation of oral and dental health in periodic aeromedical examinations helps in minimizing such hazardous situations and thus, increases flight safety. Early diagnosis of oral and dental health problems, which may or may not be noticed, is very important for the aircrew.

"Aerodontia", also known as "aerodontics", is a branch of dentistry that deals with the evaluation and treatment of oral, dental and jaw diseases that present in high altitude conditions (Fairpo J. & Fairpo C., 1973; Sipahi et al., 2007; Zadik, 2009). The effects of pressure changes that take place at various altitude levels are the most important concern in aerodontia. According to Boyle's Law, the volume of a gas increases as the air pressure decreases while the temperature remains constant. When air pressure is reduced with altitude, gas tends to expand to cover greater space (Stepanek & Webb, 2008). There are many parts in the human body where gas can remain or form and become trapped. Dental field is one of those body parts where trapped gas may form, such as between tooth mineral and filling material, inside a tooth decay, or as a result of an infectious process like a dental abscess (Figure 1). The presence of trapped gas may result is discomfort, pain, and even tissue damage.

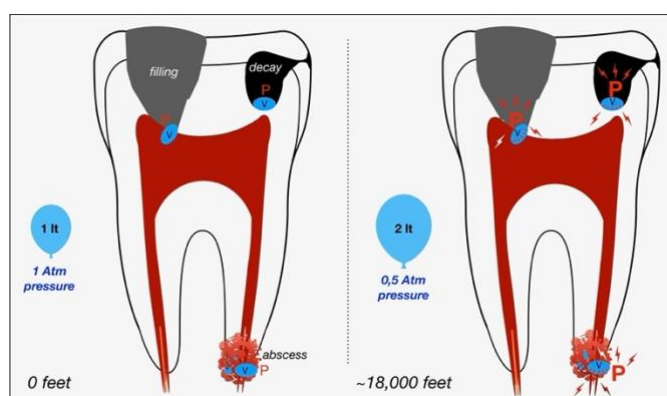
Over the last 60 years, as great developments in the aviation industry have been achieved, many aeromedical disorders related to the oral and maxillofacial region have been shown to cause severe impairments such as pain, vertigo, and other manifestations that led to medical incapacitation, resulting in flight terminations and even accidents (Nielsen, 1991; Sipahi et al., 2007; Zadik, 2009; Yüce et al., 2016). During World War II, the toothache experienced by aircrew was first referred to as "aerodontalgia". This kind of dental pain has been reported by divers as well, and the broader term "barodontalgia" has been used to describe this phenomenon (Robichaud & McNally, 2005; Zadik, 2009).

As a result of the lack of standardization in the frequency and content of periodic oral and dental examinations performed by air forces around the world, there is no general agreement about the appropriate examination periods of aircrew (Nielsen, 1991; Yüce et al., 2016). It was claimed that maintaining orodental health in aircrews is necessary to avoid in-flight medical incapacitations caused by oral and dental problems and their accompanying impairments, such as increased soreness and struggling to get adequate nourishment (Rayman, 1996). Panoramic (orthopantomograph) and periapical radiography screenings might be beneficial for the early detection of dental pathologies in individuals who are not suffering any symptoms (Nielsen, 1991; Rayman, 1996; Ellingham, 2002; Yüce et al., 2016).

The purpose of this review is to emphasize the importance of periodic examinations which aims to prevent possible oral and dental health-related diseases in aircrew. We believe that oral and dental health-related diseases require special attention in terms of flight safety.

## 2. Barodontalgia (Barodontalgia)

Barodontalgia, previously known as aerodontalgia, refers to the intense toothache that may be triggered by the increased air pressure of trapped gas in the teeth caused by ascending to higher altitudes (Figure 1). A tooth/teeth with an unknown and undiagnosed trapped gas may be asymptomatic if there is no change in air pressure in normal life; however, an increase in dental pain might lead to severe discomfort, medical incapacitation, and thus, an early flight termination.



**Figure 1.** Trapped gas pockets. At around 18,000 feet, air pressure in a balloon drops by half and air volume rises by two times. When there is no chance of gas leakage, the air pressure inside the trapped gas increases (V: Volume; P: Pressure; Atm: Atmosphere; lt: liter).

Most studies on dental barotrauma and barodontalgia have been conducted mainly within the field of military aviation. In

many published studies, dentistry in military aviation, including diagnostic criteria, surgical and pharmaceutical treatment guidelines, concepts about barotraumas, barodontalgia, the significance of periodic examinations, and flight restrictions related to dental issues, are described (Ellingham, 2002; Kamran et al., 2017; Rossi, 1995; Zadik et al., 2007). In World War II, barodontalgia was ranked fifth among the physiological disturbances reported by American pilots during flight, and it was also reported to be the third leading cause of early landings (Yüce et al., 2016). In a retrospective study conducted in U.S. Air Forces following World War II, it was found that 9.5% of the US flight crew had experienced barodontalgia at least once while in flight (Kennebeck et al., 1946). Studies have shown that 2.4% of 499 Spanish Air Force pilots, 8.2% of 331 Israeli Air Force pilots, and almost half of 135 Saudi Arabian and Kuwaiti Air Force personnel have experienced barodontalgia at least once in their careers (Gonzalez Santiago Mdel et al., 2004; Al-Hajri & Al-Madi, 2006; Zadik et al., 2007). In another research, it was reported that around 1% of Israeli Air Force pilots suffered with barodontalgia (Zadik et al., 2007). Besides these, military aircrew have a higher incidence of dental barotrauma than commercial airline passengers or aircrew (Wilson et al., 1983). This may be due to some differences between the flight characteristics of commercial aircraft and military combat aircraft. Both commercial and military aircraft can ascend to approximately 40,000 feet, where it is impossible to maintain vital functions. Therefore, aircraft cabins are artificially pressurized to reduce the risk of hypoxia, barotrauma, and decompression sickness, and thus, prevent passengers and aircrew from being medically incapacitated at such altitudes. Commercial aircraft cabins are pressurized to approximately 8,000 feet (Ahmedzai et al, 2011). Dental pain may develop at 6,000 feet (1829 m) due to changes in atmospheric pressure. Yet, the incidence of pain increases on long-haul flights at altitudes greater than 7,000 feet (2134 m) (Zadik & Einy, 2006). On the other hand, the cabin pressures of military combat aircraft gradually decrease to 22,000 feet and remain constant from that altitude (Gradwell & Macmillan, 2016). Moreover, military aircrafts are faster and more maneuverable than commercial aircrafts, enabling them to execute more complex maneuvers with significant altitude gain or loss in a shorter amount of time. These specific differences in military combat aircrafts are more likely to cause discrete and abrupt changes in air pressure, leading to significant rises in barometric fluctuations.

Barodontalgia can also be observed during hypobaric chamber trainings (Fairpo J. & Fairpo C., 1973; Sipahi et al., 2007; Zadik, 2009; Aydtug et al., 2011). During this training, the effects of hypoxia- a decrease in the partial pressure of oxygen in inhaled air and hypobaric conditions on human physiology can be demonstrated by simulating high altitudes in a stainless-steel hypobaric chamber with a vacuum system that maintains a low-pressure environment. In a hypobaric chamber training, the oxygen flow through the mask is adjusted to simulate an altitude of 25,000 feet, and thus, aircrew have chance to experience the damaging effects of hypoxia and to learn how to cope with these effects (Neuhaus & Hinkelbein, 2014). Military aircrews are required to undergo this training on a periodic basis - the time interval varies by country - and are frequently exposed to hypobaric conditions. In the 1940s, the rate of barodontalgia was found to be between 0.7% and 2% in hypobaric chamber studies undertaken by the United States (U.S.) Air Forces (Kennebeck

et al., 1946). In studies performed in hypobaric chambers in 1964 and 1965, barodontalgia rates were found to be between 0.23% and 0.3% among U.S. Air Force cadets (Hanna & Thomas-Yarlington, 1985). In 1980, the incidence of barodontalgia was found to be 0.26% in hypobaric chamber tests performed in Germany, and 0.3% in real flights in research published in Turkey in 2007 (Sipahi et al., 2007; Zadik, 2009).

Barodontalgia is more of a symptom rather than a pathological condition in itself. Barodontalgia is also an exacerbation of a pre-existing subclinical oral maxillofacial disease caused by changes in environmental barometric pressure. Many oral pathologies are considered as potential causes of barodontalgia. These are tooth decay, dental restorations with excessive substance loss, pulpitis, pulp necrosis, apical paradontitis (cyst, granuloma), periodontal pocket, impacted tooth/teeth, insufficient cement fill/insufficient restoration and mucosal retention cysts (Boggia, 1998; Kennebeck et al., 1946; Kollmann, 1993; Stoetzer et al., 2012; Zadik, 2006; Zadik et al., 2007).

Barodontalgia can also occur as a manifestation of pain caused by barosinusitis or barotitis media. While barosinusitis or barotitis media generally presents with pressure change, barodontalgia usually presents with exacerbation of pre-existing dental pathology owing to pressure change (Zadik, 2009). According to the studies conducted in America U.S. (1946), Germany (1993), Spain (2004), Israel (2007), and Turkey (2007), the following conditions and interventions were reported as the causative factors of barodontalgia: new restorations, restorations in teeth with a lot of substance loss, deep caries without pulp opening, pulp opening in vital teeth, pulpitis, periapical periodontitis (pulp necrosis), and barosinusitis (Gonzalez Santiago Mdel et al., 2004; Sipahi et al., 2007; Al-Hajri & Al-Madi, 2006; Zadik et al., 2007).

Pulpitis has been identified as the leading cause of barodontalgia since the 1940s. Table 1 depicts various theories attempted to explain barodontalgia caused by pulpitis. The theory of Orban et al (Orban & Ritchey, 1945) is based on the presence of gas bubbles in histological sections of extracted tooth after the development of barodontalgia. Bergin (Bergin, 1949) also accepted this theory. However, Lyon et al. (Lyon et al., 1999) do not subscribe to this theory, because in their research, they observed gas bubbles in just six of 75 teeth they analyzed. From another point of view, these gas bubbles are considered to be artifacts caused by fixative materials used in histological preparations (Stanley & Weaver, 1968). Today, there is still a lack of consensus regarding the mechanism of barodontalgia due to pulpitis.

**Table 1.** Theories attempted to explain barodontalgia caused by pulpitis

Author	Theory
Levy BM, 1943	Expansion of intrapulpal gas formed as a by-product of acids, bases and enzymes found in inflammatory tissue
Orban et al., 1945	The transfer of intravascular gas into tissue because of decreased solubility
Kennebeck et al., 1946	Direct ischemia due to inflammation Indirect ischemia due to increased intrapulpal pressure as a result of vasodilation and fluid transfer into the tissue
Harvey W, 1947	

When comparing the findings of direct (pulp-related) and indirect (barosinusitis and barotitis media-induced) barodontalgia, contrary to studies suggesting that the majority of cases of barodontalgia are cases of pain caused by barosinusitis (Hutchins & Reynold, 1947; Shiller, 1965; Mumford, 1982), more recent studies have that the rates of non-dental facial barotrauma ranged from 7% to 57,8% (Agackesen, 2019; Kennebeck et al., 1946; Kollmann, 1993; Zadik et al., 2007).

Previous studies have shown that it might be hard to identify the exact pathological process that results in barodontalgia (Kennebeck et al., 1946; Senia et al., 1985; Boggia, 1998). It is difficult for clinicians to identify which tooth causes pain since this tooth might be a restored and/or endodontically treated (clinically healthy) tooth, or the pain could be caused by an adjacent anatomical structure (i.e, the maxillary sinus). Furthermore, in an ordinary dental clinic, even in a hypobaric chamber environment, it is very difficult for the clinician to pinpoint the source of the pain since the factor that triggered the pain -the barometric change in pressure- cannot be re-created (Zadik, 2009).

### 3. Identification in Accidents and Crimes

An adult human has a total of 32 teeth in the right and left oral cavity, upper jaw, and lower jaw (including wisdom teeth). A significant number of people have sought treatment for their teeth as a result of the high frequency of tooth caries. This indicates that a physical history of dental treatment, including metal crowns, fillings, or adhesive teeth, etc., has been formed. In addition, many types of materials can be applied in dental treatment. The findings of these treatments are obviously present in the oral cavity and are also archived in dental clinics with treatment records (clinical, radiographic). Treatment records are required by law to be saved for at least 5 years in many countries. From this point of view, the probability of one person's dental findings matching another's tooth findings is remarkably low. Besides, it is almost impossible to match the anatomy of different people's mouths, teeth, and cheeks even in orthopantomographic (panoramic radiography) imagings (Whittaker & MacDonald, 1989; Suzuki, 1996; Utsuno, 2019). Identification based on dental findings is therefore a very useful approach in aviation accidents. There are published cases and investigations that emphasize the significance of forensic odontology combined with DNA analysis and dental identification of victims, especially when dealing with mass disaster events (Brannon & Morlang, 2003; Nambiar et al., 1997; Obafunwa et al., 2015). In some situations, a comparison between the victim's teeth and the putative teeth's morphology can be made by analyzing the photographs (Dahal et al., 2023). This technique is also successful in achieving favorable outcomes.

The most common approach for identifying disaster victims is the comparison of dental records or DNA-profile analysis in samples collected from dental pulp, because the tooth structure is generally the best-preserved anatomical structure in traumatic deaths (at temperatures exceeding 1600°C). If the victims have pre-accident dental treatment records, then the identification process can be completed in a short time using the dental arch structure that was preserved in the accident. Comparison of the dental arch with the updated radiographic images of the victim and the radiographic images taken after the accident is the preferred method since it can provide results in a very short amount of time after an accident-



crash (Zadik, 2009). Therefore, it is of great importance that aircrew are subjected to periodic oral, dental health examinations and that clinical-radiographic data be recorded on a regular basis.

#### 4. Periodic Oral and Dental Examinations and Treatments of Aircrew

Oral and dental checkups of aircrew should be scheduled to ensure that there is an adequate and acceptable amount of time between the planned examination and the flight duty following the examination (at weekends or holidays if necessary). Although routine tooth filling (restoration) treatments do not require flight restrictions, newly applied dental filling (restoration) treatment has been reported as one of the most important causes of barodentalgia (Kennebeck et al., 1946; Zadik et al., 2007). While planning the treatment, dentists should notify their patients who are aircrew - and even patients who plan to fly - regarding the potential post-treatment problems and restrictions that flight may cause.

Published studies and research reports indicate that it is mandatory to pay special attention to fractured or cracked restorations (fillings and veneers), restorations with weakened adhesion, and secondary (under-filled) carries (Zadik, 2009; Aydintug et al., 2011; Yüce et al., 2016). Prior to the filling procedure, it should be carefully determined whether pulp necrosis has developed, especially in teeth with extensive material loss, by cold tests and/or periapical films (Zadik, 2009).

Panoramic films are used to archive general oral and dental health records of aircrew so that oral and dental health issues may well be followed. In cases when panoramic filming is not possible, periapical films taken from the lower and upper incisors may also be used for keeping records of aircrew.

Aircrew members work in a unique environment that can lead to a variety of health problems and contribute to chronic stress. The researchers speculated that the high prevalence of jaw parafunctional activity in aircrew was linked to a number of adverse effects experienced during flight, such as acceleration forces, vibration, etc. (Lurie et al., 2007). Other work-related parameters, such as irregular shifts, have also been associated with bruxism (Zadik, 2009). Long-term consequences of bruxism can include tooth wear, periodontal problems, and temporomandibular joint (TMJ) dysfunction, as well as headache and facial myalgia, especially in the morning. Bruxism was shown to be significantly more prevalent among pilots than in non-pilots (69% vs. 27%, respectively) (Lurie et al., 2007; Zadik, 2009). Since there have been many studies on the prevalence of bruxism (clenching and grinding) among aircrew, dentists should also check for wear marks on opposing jaw teeth during periodic oral and dental health examinations.

Another important consideration for dentists who participate in periodic oral and dental health examinations of divers and aircrew is the durability of dental treatment procedures and materials, which have changed or improved over the recent years, against environmental and atmospheric conditions. Recent studies have shown that changes in environmental pressure can affect the functionality of dental restorations (crown retention, etc.) due to the cementation technique and type of dental material (Ata et al., 2022; Geramipanah et al., 2016; Mocquot et al., 2017; Ozkan Ata et al., 2023; Sadighpour et al., 2018). In an in-vitro study conducted by Ata et al, similar to their prior findings published

in recent literature, they reported that the luting cement-type, mixing methods of cements, and changes in environmental pressure have a significant effect on bond strengths. Besides, they proposed that dentists could use auto-mixed self-adhesive resins on patients who are likely to be exposed to hypobaric pressure (Ata et al., 2022).

Initial and periodic (renewal and revalidation) medical assessments of civil aircrew in our country are conducted in accordance with the medical requirements under regulations (Aviation Health Directive; SHT-MED) issued by The Directorate General of Civil Aviation. In SHT-MED, dental examinations are not routinely included within the periodic medical examinations (SHGM, 2022). During these examinations, a dental consultation may be requested if further evaluation is necessary. A similar procedure is carried out in periodic aeromedical examinations of military aircrew.

#### 5. Aeromedical Limitations in Terms of Oral and Dental Health

If a medical condition is harmful to aircrew health and, thus, reduces flight safety, thorough investigations should be conducted, and participation of aircrew to flight duties should be suspended until these investigations are completed. Some pharmaceutical agents which do not require unfitness to flight may be used -taking into account the medical condition requiring medication- with certain aeromedical limitations. But nonetheless, direct effects of drugs, interactions between pharmaceutical agents, or any allergic reaction may cause drowsiness, poor judgment, gastrointestinal discomfort, and vision problems, which are only some of the adverse effects that could render a pilot incapable of performing flight duties (Muntingh, 2007). For example, some pain relievers may cause dizziness, concentration impairment (Zadik, 2009), and upset stomach (Muntingh, 2007); and many antibiotics can cause some health problems such as diarrhea (Ashish et al., 2022). No matter how uncommon, doxycyclin use may trigger phototoxic reactions, macrolides can lengthen the Q-T interval, and these side effects can easily lead to medical incapacitation and loss of flight control, especially flying in adverse conditions (Hipskind, 1993; Muntingh, 2007). Nevertheless, it should be noted that unfitness for flight is directly related to the medical condition that requires the pilot to use medication itself.

In the event of a medical treatment process for a dental pathology, the flight restriction may be extended until the symptoms are alleviated, and/ or the medication is discontinued, and the blood clot is stabilized at the operation site (Zadik, 2009; Aydintug et al., 2011).

Since toothache may also often cause sleeping problems, the dentist should advise the aircrew member not to fly at least until the pain has subsided and they are able to sleep comfortably again (Aydintug et al., 2011; Yüce et al. 2016; Shah et al., 2018).

Rossi (Rossi, 1995) recommends military aircrew not to fly after determining the need for endodontic treatment until appropriate treatment has been totally completed in order to avoid experiencing barodentalgia during the flight. The recommended grounding time for regional (regional) and local anesthetic applications, which are the most common practices in dentistry, is 24 hours (Aydintug et al., 2011). Apart from that, changes in ambient pressure can trigger the blood clot to dislodge, which can lead to bleeding several hours after a tooth extraction or oral/periodontal surgery. This condition may also

hinder the ability to perform oral tasks properly, including the comprehensibility in speech functions. Moreover, in an environment with pressure changes, the risk of developing emphysema at the surgical wound site is quite high (Wilson et al., 1983).

Another reason for grounding after surgical tooth extraction is facial swelling, which can make it difficult for helicopter and jet pilots to wear flight helmets comfortably. In addition, if the oro-antral opening occurs in the maxillary posterior region after tooth extraction, atmospheric pressure changes during flight may cause problems in wound healing. Therefore, it is recommended to avoid flying until the wound site with oro-antral opening has healed completely.

The oral and dental conditions which might require grounding of aircrew, as recommended by Zadik (Zadik, 2009) are:

1. Acute intraoral infection findings presenting systemic symptoms (lymph adenopathy, high fever, weakness, etc.),
2. Insomnia due to toothache.

The treatment procedures again recommended by Zadik (Zadik, 2009) are:

1. Use of Nonsteroid Anti-inflammatory (NSAID), Opioid (codeine and paracetamol, oxycodone etc.) and Systemic Antimicrobial drugs without a definitive diagnosis of the underlying cause has been determined,
2. Local / Regional Anesthesia,
3. Tooth Extraction,
4. Oral/ Periodontal Surgery,
5. A general weakness, drowsiness related to oral and dental health.

In addition, it is highly probable that normal functions such as intelligible speech cannot be performed after dental procedures, especially tooth extraction or oral/periodontal surgery. Moreover, the risk of developing emphysema is extremely high in environments where pressure changes occur. Facial edema and/or trismus, which can prevent helicopter and jet pilots from wearing flight helmets comfortably and speaking while wearing them, are a further reason for restricting flight activities after oral/periodontal surgery (Zadik, 2009). Therefore, the return to flight duties of aircrew who have received oral and dental treatment should be contingent upon an additional oral and dental examination.

According to the Federal Aviation Administration (US FAA) guidelines, when considering the conditions and durations that require oral and dental health-related flight restrictions for pilots, 24-72 hours after tooth extraction and/or intraoral surgery, 24 hours after endodontic treatment, dental flight restriction is recommended for 10 days after implant surgery, and 7-14 days after tissue graft/membrane application. If a pilot has significant malocclusion or maxillofacial tissue disease, it is advised that they be prohibited from flying and assigned to an air-ground role (Holt & Wiseman, 2002; Yüce et al., 2016).

## 6. Conclusion

Because of the unique nature of aerospace medicine, practitioners with specialized training in aviation dentistry are required. The concerns and difficulties associated with oral and dental health treatments being planned for aircrew are substantially different from those encountered in individuals who reside and work on the ground. Both dentists and aircrew

should be aware and increase their knowledge about aviation dentistry. Oral and dental health examinations of aircrew should be performed on a regular basis to ensure flight safety. Both medical considerations and flying restriction periods should be determined by the dentist who has obtained specific training in aviation. In our opinion, it is appropriate for aircrew to undergo periodic oral and dental health examinations by a trained dentist every six months, just as is recommended for the general population.

## Ethical approval

Not applicable.

## Conflicts of Interest

The authors declare that there is no conflict of interest regarding the publication of this paper.

## References

- Agackesen S. (2019). Barotrauma prevalence in commercial airline pilots and assessment of related factors. Ondokuz Mayıs University Faculty of Medicine, Department of Aerospace Medicine, Samsun, 29.
- Ahmedzai S., Balfour-Lynn I.M., Bewick T., Buchdahl R., Coker R.K., Cummin A.R., et al. (2011). Managing passengers with stable respiratory disease planning air travel: British Thoracic Society recommendations. *Thorax*, 66(Suppl 1):i1-i30.
- Al-Hajri W. and Al-Madi E. (2006). Prevalence of barodontalgia among pilots and divers in Saudi Arabia and Kuwait. *Saudi Dent J*, 18, 134-140.
- Ashish T., Agrawal P.K., Tanaya. (2022). "The Flying Tooth"- A Detailed Review of Aviation Dentistry. *MAR Dental Scinces*, 5 (5).
- Ata S.O., Akay C., Mumcu E., Ata N. (2022). Influence of atmospheric pressure changes on dentin bond strength of conventional, bulk-fill and single-shade resin composites. *Diving Hyperb Med*. 30;52(3):175-182.
- Aydıntug Y.S., Bayar G.R., Gülses A. and Sencimen M. (2011). Uçuş Fizyolojisi ve Diş Hekimliği. *Türkiye Klinikleri Diş Hekimliği Bilimleri Dergisi*, 17(3), 286-90.
- Bergin K.G. (1949). *Aviation medicine: its theory and application*. Baltimore: Williams and Wilkins.
- Boggia R. (1998). The ups and downs of barodontalgia. *Br Dent J*, 184(5), 209.
- Brannon R.B., Morlang W.M., Smith B.C. (2003). The gander disaster: dental identification in a military tragedy. *J Forensic Sci*. 48(6):1331-5.
- Dahal S., Agrawal N.K., Chaudhary G.K., Maharjan M.R., Walung E.D., Kadel T. (2023). Analysis of smiling photograph; Operation US-Bangla Air Crash. *Med Leg J*. 5:258172231151782.
- Ellingham H.K. (2002). Dentistry in the military, *Br Dent J*, 193(8), 427-428.
- Fairpo J.E.H. and Fairpo C.G. (1973). *Heinemann Modern Dictionary for Dental Students* (2nd ed.). London: William Heinemann Medical Books Ltd.
- Geramipناه F., Sadighpour L., Assadollahi R. (2016). The effect of environmental pressure and resin cements on the push-out bond strength of a quartz fiber post to teeth root canals. *Undersea Hyperb Med*. 43(2):143-50.
- Gonzalez Santiago Mdel M., Martinez-Sahuquillo Marquez A. and Bullon-Fernandez P. (2004). Incidence of

- barodontalgias and their relation to oral/dental condition in personnel with responsibility in military flight. *Med Oral*, 9, 98-105.
- Gradwell D.P. and Macmillan A.J.F. (2016). Oxygen systems, pressure cabin and clothing. *Ernsting's Aviation and Space Medicine* (5<sup>th</sup> ed.). Editors: Gradwell D.P., Rainford D.J. Taylor & Francis Group, LLC, 79-130.
- Hanna H.H. and Thomas-Yarlington C. (1985). *Otolaryngology in aerospace medicine. Fundamentals of aerospace medicine.* Editor: DeHart, R.L. Philadelphia: Lea and Febiger.
- Harvey W. (1947). Dental pain while flying or during decompression tests. *Br Dent J*, 82, 113-118.
- Hipskind J.E. (1993). A Prophylactic Program to Prevent Traveler's Diarrhea in United States Naval Personnel Comparing Doxycycline and Trimethoprim-Sulfamethoxazole, *Military Medicine*. 158 (3), 141-144.
- Holt R. and Wiseman J.B. (2002). *Otolaryngology in aerospace medicine. Fundamentals of Aerospace Medicine* (3rd ed.). Editors: DeHart, R.L., Davis, J.R., Philadelphia: Lippincott Williams & Wilkins.
- Hutchins H.C. and Reynold O.E. (1947). Experimental investigation of the referred pain of aerodontalgia. *J Dent Res*, 26, 3-8.
- JAA (2009). *Manual of Civil Aviation Medicine.* Colorado USA, Global Engineering Documents.
- Kamran B., Nakdimon I., Zadik Y. (2017). Military aviation dentistry. *Refuat Hapeh Vehashinayim* (1993). 34(2):42-47, 88.
- Kennebeck R., Knudtzon K.F. and Goldhush A.A. (1946). Symposium on problems of aviation dentistry. *J Am Dent Assoc*, 33, 827-844.
- Kollmann W. (1993). Incidence and possible causes of dental pain during simulated high-altitude flights. *J Endod*, 19, 154-159.
- Levy B.M. (1943). Aviation dentistry. *Am J Orthodont Oral Surg*, 29, 92-95.
- Lurie O., Zadik Y., Einy S., Tarrasch R., Raviv G. and Goldstein L. (2007). Bruxism in military pilots and nonpilots: tooth wear and psychological stress. *Aviat Space Environ Med*, 78(2), 137-139.
- Lyon K.M., Hood J.A.A. and Rodda J.C. (1999). Barodontalgia: a review, and the influence of simulated diving on microleakage and on the retention of full cast crowns. *Mil Med*, 164, 222-227.
- Mocquot C., Cabrera A., Colon P, Bosco J, Grosogeat B, Pradelle-Plasse N. Effect of a hyperbaric environment (diving conditions) on adhesive restorations: an in vitro study. *Br Dent J*. 2017 Sep 8;223(5):347-351. doi: 10.1038/sj.bdj.2017.764.
- Mumford J.M. (1982). Pain from the periodontal tissues. *Orofacial pain* (3rd ed.). Edinburgh: Churchill Livingstone.
- Muntingh G.L. (2007). Drugs in Aviation - A Review. *South African Family Practice*. 49 (9), 44-49.
- Nambiar P., Jalil N., Singh B. (1997). The dental identification of victims of an aircraft accident in Malaysia. *Int Dent J*. 47(1):9-15.
- Neuhaus C. and Hinkelbein J. (2014). Cognitive responses to hypobaric hypoxia: implications for aviation training. *Psychol Res Behav Manag*. 10;7:297-302.
- Nielsen J.N. (1991). A comparison of the routine medical examination of pilots in 12 air forces. *Aviat Space Environ Med*, 62(11), 1090-5.
- Obafunwa J.O., Ogunbanjo V.O., Ogunbanjo O.B., Soyemi S.S., Faduyile F.A. (2015). Forensic odontological observations in the victims of DANA air crash. *Pan Afr Med J*. 4; 20:96.
- Orban B. and Ritchey B.T. (1945). Toothache under conditions stimulating high altitude flight. *J Am Dent Assoc*, 32, 145-180.
- Ozkan Ata S., Akay C., Mumcu E., Ata N. (2023). Adhesion of auto-mixed and manual-mixed self-adhesive resin cements to dentin on exposure to long-term high-altitude pressure. *Aircraft Engineering and Aerospace Technology*. 95(2). 323-331.
- Rayman R.B. (1996). *Aircrew health care maintenance. Fundamentals of aerospace medicine* (2nd ed.). Editor: DeHart, R.L. Philadelphia: Williams&Wilkins.
- Robichaud R. and McNally M.E. (2005). Barodontalgia as a Differential Diagnosis: Symptoms and Findings. *Journal of the Canadian Dental Association*, 71(1), 39 – 42.
- Rossi D.G. (1995). Health Policy Directive no. 411. Aviation and diving – dental considerations. Surgeon General, Australian Defence Force.
- Sadighpour L, Geramipanah F, Fazel A, Allahdadi M, Kharazifard MJ. (2018). Effect of Selected Luting Agents on the Retention of CAD/CAM Zirconia Crowns Under Cyclic Environmental Pressure. *J Dent (Tehran)*. 15(2):97-105.
- Senia E.S., Cunningham K.W. and Marx R.E. (1985). The diagnostic dilemma of barodontalgia: report of two cases. *Oral Surg Oral Med Oral Pathol*, 60(2), 212-7.
- Shah R., Dharne S., Mitra D., Talati M., Vijaykar H. and Jain C. (2018). Aviation Dentistry. *International Journal for Research in Social Science and Humanities*. 4(9),1-9.
- SHGM (2022). *Havacılık Sağlık Talimatı (SHT-MED)*. Retrieved from: SHT-MED.pdf (shgm.gov.tr) on 1st April 2023.
- Shiller W.R. (1965). Aerodontalgia under hyperbaric conditions. *Oral Surg Oral Med Oral Pathol*, 20, 694-697.
- Sipahi C., Kar M.S., Durmaz C., Dikicier E., and Bengi U. (2007). Türk Hava Kuvvetleri Uçucu Personelinde Görülen Barodontalji Prevalansı. *Gülhane Tıp Dergisi*, 49, 1-4.
- Stanley H.R. and Weaver K.A. (1968). Technique for the preparation of human pulpal tissues. *Biology of the dental pulp organ, a symposium.* Editor: Finn, S.B. Alabama: University of Alabama Press.
- Stepanek J. and Webb J.T. (2008). *Physiology of Decompressive Stress. Fundamentals of Aerospace Medicine* (4th ed.). Editors: Davis, J.R., Stepanek J., Johnson R., Fogarty J.A. Philadelphia: Wolters Kluwer & Lippincott Williams & Wilkins.
- Stoetzer M., Kuehlhorn C., Ruecker M., Ziebolz D., Gellrich N.C., von See C. (2012). Pathophysiology of Barodontalgia: A Case Report and Review of the Literature. *Case Rep Dent*. 2012: 453415.
- Suzuki K. (1996). *Forensic Odontology* (3rd ed.), Kyoto, Japan: Nagasue syoten.
- Utsuno H. (2019). Victim identification in large-scale disasters using dental findings. *IATSS Research*, 43, 90-96.
- Whittaker D.K. and MacDonald D.G. (1989). *A Color Atlas of Forensic Dentistry*, Ipswich, England: Wolfe Medical Publications Ltd.
- Wilson G.A., Galle S. and Greene C. (1983). Subcutaneous emphysema after extraction of maxillary teeth:report of a case. *J Am Dent Assoc*, 106(6), 836-837.

- Yüce E., Koçer G. and Çini T.A. (2016). Current concepts of oral and maxillofacial rehabilitation and treatment in aviation. *Gen Dent*, 64(5), 44-8.
- Zadik Y. (2006). Barodontalgia due to odontogenic inflammation in the jawbone. *Aviat Space Environ Med*, 77, 864-866.
- Zadik Y. (2009). Aviation dentistry: current concepts and practice. *Br Dent J*, 206(1), 11-6.
- Zadik Y., Chapnick L., and Goldstein L. (2007). In-flight barodontalgia: analysis of 29 cases in military aircrew. *Aviat Space Environ Med*, 78, 593-596.
- Zadik Y. and Einy S. (2006). Aviation dentistry. *Aviation Medicine*. Editor: Goldstein, L., Tel Aviv: Israeli Ministry of Defense.

---

**Cite this article:** Bayar, G.R., Sanal, G.İ., Demir A.E., Gunduz S.H. (2023). The Importance of Periodic Oral and Dental Health Examination of Aviation Personnel, *Journal of Aviation* 7(2), 310-316.



This is an open access article distributed under the terms of the Creative Commons Attribution 4.0 International Licence

Copyright © 2023 **Journal of Aviation** <https://javsci.com> - <http://dergipark.gov.tr/jav>



# Elevating Aviation Education: A Comprehensive Examination of Technology's Role in Modern Flight Training

Nazmi Dinçer<sup>1\*</sup> 

<sup>1\*</sup> National Defense University, Foreign Languages Department, 34149, Bakirkoy, Istanbul, Türkiye. (ndincer@hho.msu.edu.tr)

## Article Info

Received: 08 April 2023

Revised: 13 June 2023

Accepted: 16 June 2023

Published Online: 16 July 2023

### Keywords:

Aviation

Technology

Meta-analysis

Virtual Reality

Game-based learning

Corresponding Author: Nazmi Dinçer

## REVIEW ARTICLE

<https://doi.org/10.30518/jav.1279718>

## Abstract

As the aviation sector witnesses rapid technological progress, it opens new avenues to improve training methodologies and optimize performance results. This exhaustive analysis delves into the influence of technology incorporation on the efficacy of aviation training, learner involvement, and skills retention. It examines a wide array of research, concentrating on significant aspects like immersive technologies, artificial intelligence, game-based education, remote and cooperative training, and the enduring consequences of technology-boosted training. The outcomes demonstrate a favorable link between technology incorporation and enhanced learning results, elevated learner enthusiasm, and superior knowledge retention. The analysis further pinpoints crucial future trajectories, such as the broadening of immersive technologies, the creation of adjustable training systems, and the assessment of long-lasting training impacts. By tackling ethical and privacy issues and formulating optimal practices and guidelines, the aviation sector can effectively tap into the possibilities offered by technology, resulting in better-equipped professionals, augmented safety norms, and heightened operational competence. This analysis acts as a significant reference for researchers, practitioners, and decision-makers, offering insight into the present state of technology-augmented aviation training and underlining paths for upcoming research and innovation.

## 1. Introduction

Crucial to the aviation sector, aviation instruction ensures pilots, air traffic overseers, maintenance experts, cabin personnel, and other aviation specialists gain the essential knowledge, abilities, and competencies for secure and effective role execution (Jentsch & Curtis, 2017). Various national and global authorities, such as the FAA in the United States and ICAO internationally, regulate aviation instruction.

Aviation training programs typically encompass an array of subjects like aerodynamics, meteorology, navigation, aircraft systems, communication, regulations, and human factors. The instructional process generally consists of theoretical and hands-on elements, including classroom lessons, simulation-based instruction, and practical experience in real-world scenarios (Lee, 2017).

In recent times, rapid technological advancements in the aviation sector have led to the adoption of novel training methods and tools (Risukhin, 2016). These advancements have also spurred exploration into innovative pedagogical approaches, like game-based learning, to enrich the learning experience and enhance training results. Integrating game-based learning in aviation instruction aims to elevate learner involvement, motivation, and retention, making the training process more effective and enjoyable for aviation professionals (Ponomarenko et al., 2019).

Innovative instructional techniques hold a pivotal role in the aviation sector, as they address the industry's evolving demands and challenges. Several factors contribute to the importance of innovative training approaches in aviation:

**Technological advancements:** Rapid innovation in aviation technologies, such as advanced avionics systems, automation, and digital communication tools, necessitates updated and inventive training techniques to ensure professionals can effectively handle, maintain, and manage these systems (Risukhin, 2016).

**Safety and efficiency:** With a strong emphasis on safety and efficiency, aviation can benefit from innovative training methods that provide more effective, immersive, and realistic training experiences, leading to improved decision-making, enhanced situational awareness, and reduced human error.

**Skills retention and transfer:** Techniques like simulation-based training and game-based learning can promote better skills retention and transfer by engaging trainees and offering immediate performance feedback (Schier et al., 2016). These methods facilitate repetitive practice in controlled environments, enabling learners to develop and refine their skills without risk.

**Addressing workforce challenges:** The aviation industry faces an aging workforce, skilled professional shortages, and high attrition rates. Innovative training methods can help

recruit and retain talent by providing more engaging, adaptable, and efficient learning experiences while enabling accelerated skill development.

**Adaptability and customization:** Often leveraging digital tools and technologies, innovative training methods can be easily adapted and customized to meet specific learner or organizational needs (Biggs et al., 2018). This enables tailored and personalized training experiences, catering to unique role requirements and skill levels within the aviation industry.

In summary, innovative aviation training methods hold the potential to improve training quality and effectiveness, resulting in better-equipped professionals, heightened safety standards, and increased operational efficiency in the industry.

## 2. Technological Landscape of Aviation Training

Tracing back to the early 1900s, post the Wright brothers' powered flight accomplishment in 1903, aviation training history unfolded. As aviation advanced, the necessity for organized training programs arose, and the first flight schools were founded to teach and train aspiring pilots (Barata & Neves, 2011). Notable events in aviation training history encompass World War I's formal flight training programs. These programs were vital in training military pilots for combat, culminating in the U.S. Army Air Service's creation in 1918. Civil aviation training expanded in the interwar period, with a growing number of flight schools being established to meet increasing commercial pilot demand (Jentsch & Curtis, 2017).

In 1944, the International Civil Aviation Organization (ICAO) was formed, aiming to establish global aviation training standards and regulations (ICAO, n.d.). The organization's efforts in promoting flight training safety and uniformity have been instrumental in shaping the aviation industry (Mackenzie, 2010; Weber, 2021). Over time, training methodologies have evolved from early hands-on instruction and trial-and-error learning to more structured and technology-driven approaches (Barata & Neves, 2011).

Technology integration in aviation training has grown increasingly significant in recent years, providing numerous potential advantages for trainers and trainees alike. These benefits comprise enhanced training efficiency, improved safety, heightened learner engagement, and more effective knowledge retention (Rupasinghe et al., 2011). Technology incorporation in aviation training appears in various forms, such as flight simulators, virtual reality, computer-based training, and e-learning platforms, all aiming to improve the overall training experience (Kearns et al., 2017).

Flight simulators, for example, enable trainees to practice and refine their skills in a safe and controlled environment, without the risks linked to real-world flight situations (Nisansala et al., 2015). These simulators can replicate a wide array of flight conditions, allowing pilots to gain experience in handling various scenarios, such as emergency situations or challenging weather conditions, contributing to enhanced safety and performance (Dinçer & Demirdöken, 2023).

Virtual reality (VR) is another technological innovation that has entered aviation training, offering immersive and realistic training experiences (Biggs et al., 2018). VR-based training can help pilots develop their spatial awareness, decision-making skills, and overall situational awareness, ultimately leading to better performance and safety. Current and recent experimental training carried out by the US military personnel (USAF, 2021) has been providing valuable and pertinent insights into the realm of virtual reality training for aviation. For example, the Air Force has discovered that experimental virtual reality training for fighter pilots yields the best results

for those who aspire to fly the service's cutting-edge stealth aircraft (USAF, 2021). Alaska Airlines is among the latest major airlines globally to declare its implementation of virtual reality technology for training purposes (VRPILOT, 2022). The Managing Director of Flight Operations Training at Alaska Airlines elaborates that in the airline's recent training environments, pilots typically progress from classroom learning to partial simulations, followed by full simulations, before eventually transitioning to real aircraft (K5, 2022).

Moreover, computer-based training and e-learning platforms provide flexible and cost-effective solutions for aviation training, allowing trainees to access educational resources and courses remotely, at their own pace (Berendschot et al., 2018). This can lead to improved knowledge retention and increased learner engagement, as trainees can tailor their learning experience to their individual needs and preferences. CBT has also been found to be beneficial for training air traffic controllers, as it enables them to learn and practice essential skills in a simulated environment, without the risks associated with real-world scenarios (Hilburn, 2004). In maintenance technician training, CBT has been shown to improve knowledge retention and reduce the time required for training (Wang, 2011).

According to Moore, Lehrer, and Telfer's (2001) study, the conventional pilot ground education that professionals perform in classes is more on a superficial or mechanical stage as opposed to a deeper or intrinsic level. Most instructors adopt the approach of "teaching to the test" to prepare students for exams. Lakowske, Breese, and Callejo (1999) argue that computer-based training (CBT) falls short due to the lack of comprehensive user interaction needed for in-depth exploration of complicated tasks which demand "what-if" analysis. They propose a "closed-loop" training system, which incorporates feedback from flight operations quality assurance programs and visualization systems, as a superior alternative to the prevalent "open-loop" system characterized by infrequent feedback and insufficient objective data for evaluation in pilot education.

The FAA found that integrating CBT with emerging technologies has the potential to significantly reduce pilot error accident rates, which reached a staggering 87% that year. Consequently, the FAA allowed CBT hours to replace actual flight hours, leading to considerable cost savings for pilots and offering an official incentive for the development of such systems. In research led by John P. Dalton for Forrester, which surveyed training managers and knowledge officers from 40 of the world's 2,500 largest corporations, the general sentiment towards computer-based training indicated a strong enthusiasm for such opportunities. The business aviation sector may potentially achieve savings similar to the \$80 million in travel and lodging expenses that IBM saved in 1999, thanks to their worldwide CBT initiatives (Delio, 2000).

Computer-based training (CBT) in aviation, like any other training method, has its drawbacks that need to be considered. One disadvantage is the potential for a loss of concentration. Without the physical presence of an instructor or the structure of a classroom environment, learners may find it challenging to maintain focus and easily get distracted by external factors. This lack of concentration can hinder the absorption of information and impact the effectiveness of the training.

Another disadvantage is the absence of time criticality in CBT. Unlike real-time face-to-face training, where instructors can simulate time-sensitive scenarios and provide immediate feedback, CBT often lacks the urgency and pressure associated with time-critical decision-making. This can result in learners not fully grasping the importance of quick thinking and decision-making skills required in real aviation situations.

Additionally, one of the concerns with CBT is the possibility of another person completing the training on behalf of the intended learner. Since CBT relies heavily on self-paced learning and remote access, there is a risk that someone other than the intended learner could complete the training modules or assessments. This can lead to a lack of competence and proficiency in the actual skills and knowledge required for aviation operations.

In summary, the use of technology in aviation training offers numerous potential benefits, including enhanced training efficiency, improved safety, increased learner engagement, and more effective knowledge retention despite some hesitations such as time criticality and a loss of concentration. By leveraging these technologies, aviation training programs can better prepare pilots for the challenges they will face in the field and ultimately contribute to safer and more efficient operations.

This systematic review is a follow-up of other studies pursued by the academic community as to how and why technology is used in aviation training. Due to the insufficient number of systematic reviews in this area and with the rapid advance in technology, more research in this area is essential. Moreover, it is crucial to analyze research studies to gather the most updated synthesized collection of those studies. Since technology offers numerous potentials for enhancing aviation training, this systematic review is likely to contribute to researchers and educators by presenting recent findings of the related studies in the field. More specifically, the objective of this systematic review is to examine the integration of technology in aviation training in terms of study context, aim of technology integration, technologies integrated, strategies used, and effects on students' performance, and provide suggestions for future research directions. Based on this objective, the research questions of the study follow as:

1. In which contexts were the studies on the use of technology in aviation training conducted?
2. What are the aims, strategies, and technologies that recent studies on the use of technology in aviation training include?
3. How does the use of technology impact aviation training compared to traditional training methods?
4. What are the future directions based on the studies on the use of technology in aviation training?

### 3. Methodology

In order to perform an all-encompassing investigation of scholarly works regarding the implementation of technology within the realm of aviation instruction, a meticulous search plan was devised for the purpose of pinpointing pertinent research. This exploration was executed across several electronic repositories, encompassing Google Scholar, Web of Science, Scopus, IEEE Xplore, and ScienceDirect. These databases were picked due to their wide-ranging inclusion of research papers within the spheres of aviation, technology, and education.

The search tactic utilized a fusion of keywords and phrases connected to the research subject. The principal keywords deployed in the search encompassed "aviation instruction," "technology," "simulation," "virtual reality," "augmented reality," "serious games," and "groundbreaking training techniques." These keywords were merged using Boolean operators (AND, OR) to construct a more inclusive search inquiry. As an illustration, the search inquiry could appear as: ("aviation education" AND "technology") OR ("simulation"

AND "aviation education") OR ("virtual reality" AND "aviation education").

The search was confined to articles published between 1994 and 2023, since this period encapsulates the noteworthy advancements in aviation instruction technology. Moreover, only articles published in English were deemed suitable for incorporation in the study.

Upon obtaining the initial search results, a two-phase screening procedure was applied to guarantee the pertinence and caliber of the chosen research. Firstly, the titles and abstracts of the retrieved articles were examined to pinpoint potentially relevant research. Studies that failed to satisfy the inclusion criteria were eliminated at this juncture. Subsequently, the full text of the remaining articles was evaluated for eligibility, and studies that did not concentrate on the employment of technology in aviation instruction or did not supply adequate information were excluded.

In conclusion, the reference lists of the incorporated studies were manually inspected to recognize any further pertinent articles that might have been overlooked during the initial search. This method culminated in a comprehensive assemblage of studies that offer insights into the employment of technology in aviation instruction.

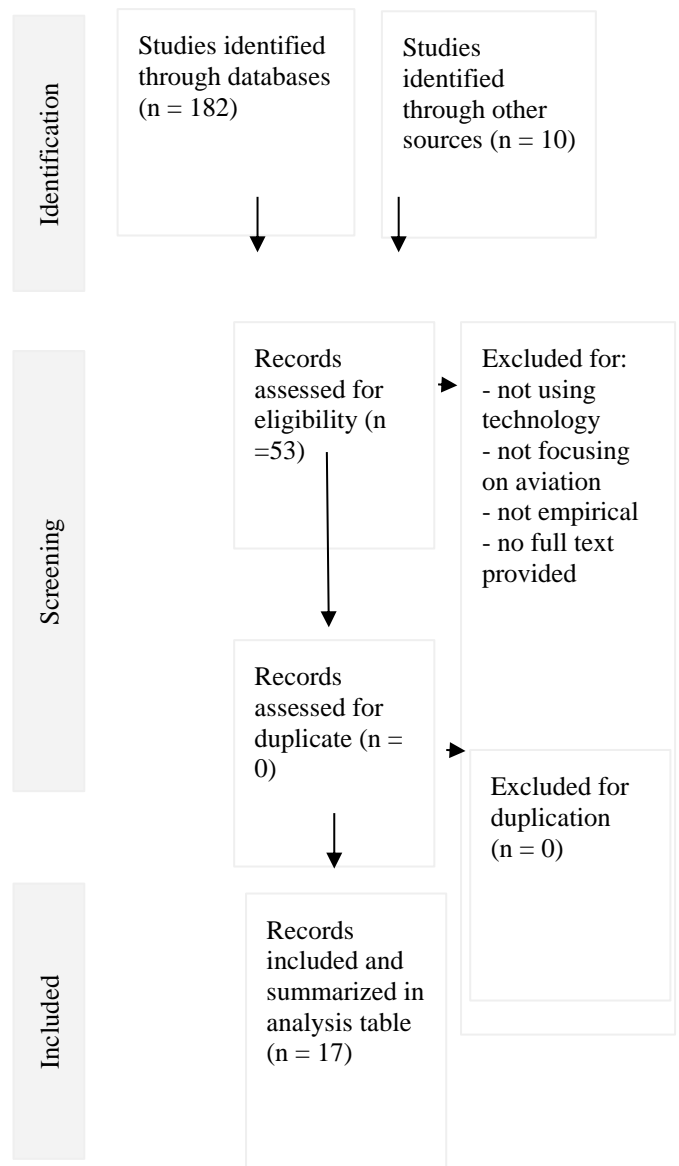


Figure 1. Diagram of the review process

4. Findings

Tables 1 and 2 offer a complete summary of the different contexts in which technology has been employed in aviation instruction, as discovered in the chosen studies (*n* = 17). The bulk of the studies emphasize flight instruction, with four studies scrutinizing fixed-wing aircraft training (Gopher et al., 1994; Reweti et al., 2017; Koglbauer & Braunstingl, 2018; Kuindersma, 2019) and three studies focusing on helicopter flight training (Johnson & Stewart, 2005; Proctor et al., 2007; Mautone et al., 2008). These studies exhibit the significance and effectiveness of technology in augmenting pilot training, particularly concerning flight simulators.

Two studies tackle aircrew training (Mautone et al., 2008; Kuindersma, 2019), indicating the potential of technology in more comprehensive aviation crew training. Aircraft maintenance training is also examined in two studies (Rupasinghe et al., 2011; Wang et al., 2016), underlining the utilization of technology for the advancement of crucial technical skills in aircraft maintenance personnel.

Aviation English and vocabulary instruction, crucial for aviation professionals, are the subjects of two studies (Dinçer & Dinçer, 2021; Fursenko et al., 2021). These studies stress the employment of technology to bolster language learning and communication skills in the aviation industry. In another study by Moskalenko & Didenko (2018), it was determined that CBT enhances pilots' listening comprehension.

One study delves into the application of eye-tracking technology in commercial aviation (Rudi et al., 2020), supplying insights into how this technology can be employed to improve training results.

The utilization of virtual reality for flight training is investigated in another study (Fussell & Truong, 2020), exhibiting the potential of immersive technologies in aviation training. Lastly, one study concentrates on the more extensive application of immersive technology in aviation training, explicitly in the context of Tunisia (Sabrine, 2022).

In summary, the chosen studies represent the diverse contexts and applications of technology in aviation training, demonstrating its potential to support and enhance various facets of aviation education and skill development.

Table 1. Reviewed articles

Study	Participants	Research Design	Aims
Gopher et al. (1994)	58	True-experimental	Evaluate the transfer of skills from computer game trainers to real-life flight
Johnson & Stewart (2005)	16	Descriptive	Assess the utility of PC-based aviation training devices for helicopter flight
Raisinghani (2005)	50	Descriptive	Investigate distance education opportunities in the business aviation industry
Proctor et al. (2007)	45	Quasi-experimental	Explore the use of serious aviation gaming for helicopter flight training
Mautone et al. (2008)	14	True-experimental	Examine the use of serious game technology for aircrew training
Rupasinghe (2011)	39	Quasi-experimental	Develop a virtual reality training-integrated curriculum for aircraft maintenance
Reweti (2014)	7	Action research	Pilot proficiency in performing VFR procedures
Wang et al. (2016)	41	Correlational	Understand aviation students' perceptions of augmented reality maintenance training
Reweti et a. (2017)	93	Quasi-experimental	Assess the efficacy of low-cost PC-based aviation training devices
Koglbauer (2018)	53	Quasi-experimental	Understand aviation students' perceptions of augmented reality maintenance training
Moslalenko & Didenko (2018)	76	Quasi-experimental	Training pilots' listening skills
Kuindersma (2019)	64	True-experimental	Evaluate game-based learning for preparing airline pilots for critical situations
Fussel & Truong (2020)	42	Descriptive	Investigate aviation students' intentions to use virtual reality for flight training
Rudi et al. (2020)	7	Quasi-experimental	Explore the use of eye tracking for commercial aviation training purposes
Dinçer & Dinçer (2021)	30	Quasi-experimental	Examine the effect of a serious game on aviation vocabulary acquisition
Fursenko et al. (2021)	57	True-experimental	Integrating Quizlet for aviation vocabulary
Sabrine (2022)	51	Descriptive	Investigate the use of immersive technology in aviation training



**Table 2.** Context of the studies

Context	Number of Studies
Flight Training (Fixed-wing aircraft)	4
Flight Training (Helicopter)	2
Aircrew Training	2
Aircraft Maintenance Training	2
Business Aviation Training	1
Aviation English Training	3
Eye-tracking for Commercial Aviation	1
Virtual Reality in Flight Training	2
Total	17

### 5. Discussion

The conclusions drawn from this systematic review underscore the increasing significance of technology in aviation instruction, as demonstrated by the wide-ranging contexts and applications discovered in the chosen studies. The incorporation of technology into aviation training has emerged as a crucial element in addressing the sector's dynamic demands and obstacles, including technological progress, safety and efficiency, skills retention and transfer, tackling workforce challenges, and personalization and adaptability.

The bulk of the studies concentrate on flight training, accentuating the effectiveness of technology, especially flight simulators, in augmenting pilot training (e.g., Gopher et al., 1994; Johnson & Stewart, 2005; Reweti, 2014; Dinçer & Dinçer, 2021). Flight simulators furnish a secure, regulated setting for pilots to refine their skills, minimizing the hazards linked with real-world flight situations (Nisansala et al., 2015). By emulating diverse flight conditions, pilots can gain experience in managing various scenarios, such as emergencies or unfavorable weather conditions, which contributes to improved safety and performance.

Virtual reality (VR) in aviation training represents another area of growing interest, with research demonstrating its capacity for immersive and authentic training experiences (Biggs et al., 2018). VR-based instruction can assist pilots in cultivating spatial awareness, decision-making abilities, and comprehensive situational awareness, eventually resulting in superior performance and safety (Fussel et al., 2022). The adoption of VR in aviation training is an expanding trend, as evidenced by major airlines like Alaska Airlines announcing the implementation of VR technology for training purposes.

Furthermore, the review discloses the importance of technology in more comprehensive aviation crew training, aircraft maintenance instruction, and aviation English and vocabulary training (Mautone et al., 2008; Fursenko et al., 2021). These discoveries emphasize the adaptability of technology in aiding various aspects of aviation education and skill enhancement.

In addition, the review brings attention to the potential of emerging technologies, such as eye-tracking and immersive technology, in improving training results (Rudi et al., 2020). These technologies present novel opportunities for aviation training providers to create inventive, efficient, and

captivating training programs that cater to the distinct needs of the industry.

It is crucial for the aviation sector to invest in continuous research and development to explore innovative applications of technology, as well as to promote collaboration between researchers, practitioners, and policymakers. This collaboration will help establish best practices and guidelines for the successful implementation of technology-enhanced training programs, ultimately leading to a better-prepared workforce and enhanced safety and operational standards in the industry. Additionally, addressing ethical and privacy concerns related to data collection, storage, and analysis is essential to ensure data protection and responsible use of technology in aviation training. By addressing these critical issues, the aviation industry can continue to harness the potential of technology to elevate the quality and effectiveness of training programs.

### 6. Future Directions

Derived from the conclusions of the chosen research and the present trends in technology and aviation, numerous prospective pathways can be discerned for the amalgamation and progression of technology in aviation instruction. These trajectories present opportunities for researchers, practitioners, and policymakers to further advance the efficacy and efficiency of aviation instruction programs.

**Immersive technologies:** Virtual reality (VR), augmented reality (AR), and mixed reality (MR) are swiftly evolving technologies with enormous potential for advancing aviation instruction. Upcoming research should probe the incorporation of these immersive technologies in diverse facets of aviation instruction, including flight emulation, air traffic supervision, maintenance, and cabin crew training. This research could investigate the impact of immersive technologies on skill advancement, knowledge retention, and overall instruction efficacy.

**Artificial intelligence and adaptable training systems:** The advancement of artificial intelligence (AI) offers opportunities for crafting personalized and adaptable instruction systems tailored to individual learners' necessities. These systems could evaluate learners' performance and deliver real-time feedback, modifying instruction content and difficulty levels accordingly. Upcoming research should delve into the potential advantages and challenges of integrating AI-driven instruction systems in aviation and discover effective strategies for their implementation.

**Incorporation of game-based education:** The employment of serious games and game-based learning is a promising tactic for enhancing learner engagement, motivation, and retention in aviation instruction. Future investigations should examine the design and development of game-based learning applications explicitly for aviation instruction and assess their effectiveness in promoting skill advancement and knowledge retention.

**Remote and cooperative instruction:** Progress in communication and networking technologies facilitates remote and cooperative training opportunities, which could aid in addressing workforce challenges and enhancing the accessibility and adaptability of aviation instruction programs. Upcoming research should probe the potential of remote instruction technologies, like telepresence, and their influence on collaboration, communication, and overall instruction efficacy.

**Tackling ethical and privacy concerns:** As technology persists in playing a larger part in aviation instruction, it is crucial to address the ethical and privacy concerns connected to data gathering, storage, and analysis. Future research should explore methods to guarantee data protection, privacy, and ethical considerations while harnessing the potential advantages of technology in aviation instruction.

**Formulating best practices and guidelines:** To ensure the effective and efficient integration of technology in aviation instruction, it is vital to establish best practices and guidelines for trainers, educators, and policymakers. Future research should concentrate on pinpointing the key factors that contribute to the successful implementation of technology-enhanced instruction programs and developing evidence-based recommendations for their design and delivery.

By investigating these prospective directions, the aviation industry can persist in leveraging the potential of technology to enhance the quality and effectiveness of instruction programs, ultimately resulting in better-prepared professionals, improved safety standards, and increased operational efficiency.

## 7. Limitations

This systematic review has some limitations that should be acknowledged. First, the search strategy may have missed relevant studies that were not indexed in the selected electronic databases or that did not use the specific keywords included in the search query. Future research could expand the search strategy to include additional databases or use alternative search terms to identify additional studies.

Second, the review focuses on studies published in English, which may have resulted in the exclusion of relevant research published in other languages. Future research could include studies published in other languages to provide a more comprehensive understanding of the use of technology in aviation training globally.

Third, the review covers a broad range of contexts and applications of technology in aviation training, which may limit the depth of analysis for specific areas or technologies. Future research could focus on specific aspects of technology integration in aviation training, such as the use of VR or augmented reality, to provide more in-depth insights into their effectiveness and potential benefits.

## Ethical approval

Not applicable.

## Conflicts of Interest

The authors declare that there is no conflict of interest regarding the publication of this paper.

## References

- Barata, J., & Neves, F. (2011). The history of aviation education and training. In 49th AIAA Aerospace Sciences Meeting Including the New Horizons Forum and Aerospace Exposition (p. 407).
- Berendschot, Q., Ortiz, Y., Blickensderfer, B., Simonson, R., & DeFilippis, N. (2018, September). How to improve general aviation weather training: Challenges and recommendations for designing computer-based simulation weather training scenarios. In Proceedings of the Human Factors and Ergonomics Society Annual Meeting (Vol. 62, No. 1, pp. 1792-1795). Sage CA: Los Angeles, CA: SAGE Publications.
- Biggs, A. T., Geyer, D. J., Schroeder, V. M., Robinson, F. E., & Bradley, J. L. (2018). Adapting virtual reality and augmented reality systems for naval aviation training.
- Clark, R. E. (1994). Media will never influence learning. *Educational technology research and development*, 21-29.
- Dinçer, N., & Dinçer, R. (2021). The effect of a serious game on aviation vocabulary acquisition. *International Journal of Serious Games*, 8(4), 49-63.
- Dinçer, N., & Demirdöken, G. (2023). Ab-Initio Pilots' perspectives on The Use of Simulation in The Aviation English Course. *Journal of Teaching English for Specific and Academic Purposes*, 011-022.
- Filazoğlu, E., & KAFALI, H. (2021). Usage of Airport Operation Simulations in Aviation Training. *Journal of Aviation*, 5(2), 101-110.
- Flores, A. D. C., Ziakkas, D., & Dillman, B. G. (2023). Artificial Cognitive Systems and Aviation training. *Intelligent Human Systems Integration (IHSI 2023): Integrating People and Intelligent Systems*, 69(69).
- Freese, M., Drees, S., & Meinecke, M. (2016). Between game and reality: using serious games to analyze complex interaction processes in air traffic management. In *Simulation and Gaming in the Network Society* (pp. 275-289). Springer Singapore.
- Fursenko, T., Bystrova, B., & Druz, Y. (2021). INTEGRATING QUIZLET INTO AVIATION ENGLISH COURSE. *Advanced Education*, 118-127.
- Fussell, S. G., & Truong, D. (2020). Preliminary results of a study investigating aviation student's intentions to use virtual reality for flight training. *International Journal of Aviation, Aeronautics, and Aerospace*, 7(3), 2.
- Gopher, D., Well, M., & Bareket, T. (1994). Transfer of skill from a computer game trainer to flight. *Human factors*, 36(3), 387-405.
- Hilburn, B. (2004). Cognitive complexity in air traffic control: A literature review. *EEC note*, 4(04), 1-80.
- Jentsch, F., & Curtis, M. (2017). *Simulation in aviation training*. Routledge.
- Johnson, D. M., & Stewart, J. E. (2005). Utility of a personal computer-based aviation training device for helicopter flight training. *International Journal of Applied Aviation Studies*, 5(2), 288-307.
- K5 (2022). Alaska Airlines VR Article. <https://www.king5.com/article/tech/alaskaairlines-use-virtual-reality-pilot-training/281-3cb512f2-6539-41af-8d17-addbdaa9d31d>
- Kamel, M., & Miller, R. (2004, January). The Evolution of Games of Innovation in Regulated Complex Industries: The Case of Aviation Training. In *ASME International Mechanical Engineering Congress and Exposition* (Vol. 47209, pp. 199-209).
- Kearns, S. K., Mavin, T. J., & Hodge, S. (2017). *Competency-based education in aviation: Exploring alternate training pathways*. Routledge.
- Koglbauer, I., & Braunstingl, R. (2018). Ab initio pilot training for traffic separation and visual airport procedures in a naturalistic flight simulation environment. *Transportation research part F: traffic psychology and behaviour*, 58, 1-10.

- Kuindersma, E. C. (2019). Cleared for take-off: Game-based learning to prepare airline pilots for critical situations (Doctoral dissertation, Leiden).
- Lee, A. T. (2017). Flight simulation: virtual environments in aviation. Routledge.
- Mackenzie, D. (2010). ICAO: A history of the international civil aviation organization. University of Toronto Press.
- Martinez-Marquez, D., Pingali, S., Panuwatwanich, K., Stewart, R. A., & Mohamed, S. (2021). Application of eye tracking technology in aviation, maritime, and construction industries: a systematic review. *Sensors*, 21(13), 4289.
- Mautone, T., Spiker, V., & Karp, D. (2008). Using serious game technology to improve aircrew training. In Proceedings of the Interservice/Industry Training, Simulation & Education Conference (IITSEC).
- Moore, P. J., Lehrer, H. R., & Telfer, R. A. (2001). Quality training and learning in aviation: Problems of alignment. *Journal of Air Transportation World Wide*, 6(1).
- Moskalenko, O. I., & Didenko, O. V. (2018). A computer tool for training pilots' listening skills in aviation english. *Information Technologies and Learning Tools*, 67(5), 187.
- Nisansala, A., Weerasinghe, M., Dias, G. K. A., Sandaruwan, D., Keppitiyagama, C., Kodikara, N., ... & Samarasinghe, P. (2015). Flight Simulator for Serious Gaming. In *Information Science and Applications* (pp. 267-277). Springer Berlin Heidelberg
- Ponomarenko, V., Tretyakov, V., & Zakharov, A. (2019). Generative games in aviation. In Proceedings of the 20th Congress of the International Ergonomics Association (IEA 2018) Volume VI: Transport Ergonomics and Human Factors (TEHF), Aerospace Human Factors and Ergonomics 20 (pp. 576-581). Springer International Publishing.
- Proctor, M. D., Bauer, M., & Lucario, T. (2007). Helicopter flight training through serious aviation gaming. *The Journal of Defense Modeling and Simulation*, 4(3), 277-294.
- Raisinghani, M., Chowdhury, M., Colquitt, C., Reyes, P. M., Bonakdar, N., Ray, J., & Robles, J. (2005). Distance education in the business aviation industry: Issues and opportunities. *International Journal of Distance Education Technologies (IJDET)*, 3(1), 20-43.
- Reweti, S. (2014). PC-based aviation training devices for pilot training in visual flight rules procedures: development, validation and effectiveness (Doctoral dissertation, Massey University).
- Reweti, S., Gilbey, A., & Lynn, J. (2017). Efficacy of low-cost PC-based aviation training devices. *Journal of Information Technology Education. Research*, 16, 127.
- Risukhin, V. N. (2016). Integration of affordable information technology products into general aviation training and research. In 16th AIAA Aviation Technology, Integration, and Operations Conference (p. 3917).
- Rudi, D., Kiefer, P., & Raubal, M. (2020). The instructor assistant system (iASSYST)-utilizing eye tracking for commercial aviation training purposes. *Ergonomics*, 63(1), 61-79.
- Rupasinghe, T. D., Kurz, M. E., Washburn, C., & Gramopadhye, A. K. (2011). Virtual reality training integrated curriculum: An aircraft maintenance technology (AMT) education perspective. *International Journal of Engineering Education*, 27(4), 778.
- Sabrine, D. (2022). The immersive technology in aviation training: Case study Tunisia (Master's thesis, International Hellenic University).
- Sadasivan, S., & Gramopadhye, A. K. (2009). Technology to support inspection training in the general aviation industry: Specification and design. *International journal of industrial ergonomics*, 39(4), 608-620.
- Schier, S., Freese, M., & Mühlhausen, T. (2016, November). Serious gaming in airport management: transformation from a validation tool to a learning environment. In *Games and Learning Alliance: 5th International Conference, GALA 2016, Utrecht, The Netherlands, December 5-7, 2016, Proceedings* (pp. 187-196). Cham: Springer International Publishing.
- USAF (2021). The Air Force's Virtual Reality Fighter Training is Working Best for 5th Generation Pilots. <https://www.military.com/daily-news/2021/03/26/airforces-virtual-reality-fighter-training-working-best-5th-gen-pilots.html>
- VRPILOT (2022). Alaska Airlines was one of the first US Airlines to use virtual reality in pilot training. <https://vrpilot.aero/alaska-airlines-to-explore-vr-training-for-pilots/>
- Wang, Y., Anne, A., & Ropp, T. (2016). Applying the technology acceptance model to understand aviation students' perceptions toward augmented reality maintenance training instruction. *International Journal of Aviation, Aeronautics, and Aerospace*, 3(4), 3.
- Weber, L. (2021). *International Civil Aviation Organization (ICAO)*. Kluwer Law International BV
- Xu, K., Yin, H., Zhang, L., & Xu, Y. (2015, November). Game theory with probabilistic prediction for conflict resolution in air traffic management. In 2015 10th International Conference on Intelligent Systems and Knowledge Engineering (ISKE) (pp. 94-98). IEEE.

**Cite this article:** Dincer, N. (2023). Elevating Aviation Education: A Comprehensive Examination of Technology's Role in Modern Flight Training, *Journal of Aviation* 7(2), 317-323.



This is an open access article distributed under the terms of the Creative Commons Attribution 4.0 International License

**Copyright © 2023 Journal of Aviation** <https://javsci.com> - <http://dergipark.gov.tr/jav>