

Scientific
Refereed
Quarterly

Sosyoekonomi

Vol. 32(59) January 2024

ISSN 1305-5577

Editor-in-Chief

Ahmet Burçin YERELİ

Editorial Board

Hale AKBULUT

Ahmet Tayfur AKCAN

Bariş ALPASLAN

Emre ATSAN

Hakan AY

Mehmet Fatih ÇAPANOĞLU

Başak DALGIÇ

Burcu FAZLIOĞLU

Ali Gökhan GÖLÇEK

Sevilay GÜMÜŞ-ÖZUYAR

Egemen İPEK

Fatih KALECİ

Mustafa KIZILTAN

Altuğ Murat KÖKTAŞ

Zuhal KURUL

Metin MERİÇ

Aslı Ceren SARAL

İşıl Şirin SELÇUK

Ayşen SİVRİKAYA

Cultural and Generational Differences in Predicting Green Consumption: A Mediated Moderation Model
Hasan Selçuk ETİ

Understanding the Psychological and Financial Correlates for Consumer Credit Use
Tuna ÇAKAR & Türkay ŞAHİN & Seyit ERTUĞRUL & Alperen SAYAR

Translation And Diffusion Process of The Shopping Mall Form: A Case Study
Fettah KAYRA & Deniz TAŞCI & Akansel YALÇINKAYA & Umut KOÇ

The Relationship Between Renewable Energy Consumption and Stock Market Capitalisation and Carbon Emissions: Insights from G20 Countries
Yücel AYRIÇAY & Meltem KILIÇ & Seren AYDINGÜLLÜ SAKALISIZ

Determination of the Factors Affecting Divorce in Türkiye According to Gender: A Research with TUIK Data
Özlem KURU SÖNMEZ & Emre YAKUT

Efficiency of Investment Incentives in Reducing Regional Development Disparities in Türkiye
Sinan DÜNDAR & Gülay DEMİR & İlkey NOYAN YALMAN & Şerife Merve KOŞAROĞLU & Selçuk Yasin YILDIZ

Household Water Consumption and Tariff Structure: The Analysis of Türkiye's Three Metropolitan Cities
Mahmut Akif GÜVEN & Alparslan Abdurrahman BAŞARAN

Intermediate Role of Rational Spending in The Effect of Responsibility Consciousness on Utility Consumption Style
Garzge ERGİN & Kahraman ÇATI & Ebru OSKALOĞLU

Effects of FX on ETF Prices: Evidence from BIST
Tayfur BAYAT & Altuğ Murat KÖKTAŞ & Selim KAYHAN & Gökhan KONAT

Orta Gelir Tuzakı ve Vergi Gelirlerinin Kompozisyonu Arasındaki İlişki: Yükselen G20 Ülkeleri Örneği
Tayfun MOĞOL & Burak PIRDAL

Küreselleşme, Hidroelektrik Enerji, Ekonomik Büyüme, CO2 Emisyonları ve Ekolojik Ayak İzi İlişkisinin ABD için Analizi: Kesirli Fourier ADL Eşbütünlük Yöntemi
Ahmet KAMACI

Avrupa Birliği Ülkelerinde Çevre Vergilerinin Çevre, Ekonomik Büyüme ve İşsizlik Üzerindeki Etkisinin Ampirik Analizi
Sema DIRGEN ÖZ & Hüseyin Güçlü ÇIÇEK

Finansal İstikrarsızlığın Kamu Bankalarının İstikrarına Etkisi: Bir PMG/ARDL Panel Yaklaşımı
Mehmet Fatih ASLANTAŞ & Tuncer YILMAZ & Mehmet Fatih ÇAPANOĞLU

Çevre Vergileri, Karbon Emisyonu ile Ekonomik Büyüme Arasındaki İlişki: OECD Ülkeleri Üzerine Bir Analiz
Fusun ÇELEBİ BOZ & Tuğba ÖRS UNUR

Dünyada Ulaştırma Sektöründe Kamu-Özel Ortaklığının Gelişimi
Duran BÜLBÜL & Zehra AKGÜNGÖR

D-8 Ülkeleri için Karbondioksit Emisyonun Yapay Sınır Ağları ile Tahmin Edilmesi: Levenberg-Marquardt Algoritması
Ayşe ÇAY ATALAY

Sosyal Koruma Harcamalarının Gelir Eşitsizliği Üzerindeki Etkisi: Türkiye Örneği
Tanik Zeki YILMAZ & Cemil RAKICI

Türkiye için Ekonomik Yapısal Reform Ölçüm Yöntemlerinin Geliştirilmesi ve Büyüme Üzerindeki Etkilerinin İncelenmesi
Ömer YALÇINKAYA & Vedat KAYA & Gökhan ERİKAL

Türk Sivil Havacılığı Endüstrisinin Etkinliği ile Endüstri Yoğunlaşması Arasındaki İlişkinin İncelenmesi
Murat Ahmet DOĞAN & Cankut AYDIN

Kulüp Yakınsama Analizi Temelinde OECD Ülkelerinin Vergi Gayreti Performansı
Bilgen TAŞDOĞAN

OECD Ülkesinde Vergi İdaresinin Etkinliği: VZA Yöntemi
Sevilay Ece GÜMÜŞ ÖZUYAR & Ayça ÖZEKİN

DÜZELTME: BIST Perakende Ticaret Sektöründe LOPCOW-RSMVC Modeli ile Performans Ölçümü
Nazlı ERSOY
[Sosyoekonomi, 31(57), 419-436; DOI: 10.17233/sosyoekonomi.2023.03.20]





SOSYOEKONOMİ

Peer-Reviewed, Scientific, Quarterly Hakemli, Bilimsel, Süreli
Sosyoekonomi Society Sosyoekonomi Derneği

January 2024, Vol. 32(59) ISSN 1305-5577

www.sosyoekonomijournal.org

Publisher / Derginin Sahibi Editor-in-Chief / Yayın Kurulu Başkanı (Sorumlu Yazı İşleri Müdürü)	:	On Behalf of Sosyoekonomi Society / Sosyoekonomi Derneği Adına Ahmet Burçin YERELİ editor@sosyoekonomijournal.org
Co-Editors-in-Chief / Yayın Kurulu Bşk. Yrd. (Sorumlu Yazı İşleri Müdür Yrd.)	:	Emre ATSAN Mehmet Fatih ÇAPANOĞLU Ali Gökhan GÖLÇEK info@sosyoekonomijournal.org
Title of Journal / Yayının Adı	:	Sosyoekonomi Journal Sosyoekonomi Dergisi
Type of Journal / Yayının Türü	:	Periodical Yaygın, Süreli Yayın
Frequency and Language / Yayının Şekli ve Dili	:	Quarterly, English & Turkish 3 Aylık, İngilizce & Türkçe
Directorial Address / Yayının İdare Adresi	:	Sosyoekonomi Derneği, Cihan Sokak, 27/7 06430 Sıhhiye / ANKARA Tel: +90 312 229 49 11 Fax: +90 312 230 76 23
Printing House / Basım Yeri	:	Sonçağ Yayıncılık Matbaacılık Reklam San. Tic. Ltd. Şti. İstanbul Caddesi, İstanbul Çarşısı, 48/48, İskitler / ANKARA Tel: +90 312 341 36 67
Place and Date of Print / Basım Yeri ve Tarihi	:	Ankara, 31.01.2024
Abstracting-Ranking-Indexing / Dizin	:	<i>Emerging Sources Citation Index (ESCI), Tübitak - ULAKBİM TR Dizin, EconLit, EBSCO, SOBIAD, ProQuest, RePEc (Research Papers in Economics), IDEAS, EconPapers.</i>

Bu derginin her türlü yayım ve telif hakkı Sosyoekonomi Dergisi'ne aittir. 5846 sayılı Fikir ve Sanat Eserleri Kanunu hükümlerine göre, fotokopi, dijital ve benzeri yöntemlerle herhangi bir bölümü veya tamamı Dergi Sahibinin veya Yayın Kurulu Başkanının izni olmadan basılamaz ve çoğaltılamaz. Bilimsel etik kurallarına uygun olmayan alıntı yapılamaz. Dergide yayımlanan makalelerin fikri sorumluluğu yazarlara aittir.

Editorial Board / Yayın Kurulu

Ahmet Burçin	YERELİ	Hacettepe University, Türkiye
Emre	ATSAN	Niğde Ömer Halisdemir University, Türkiye
Mehmet Fatih	ÇAPANOĞLU	Hakkari University, Türkiye
Ali Gökhan	GÖLÇEK	Niğde Ömer Halisdemir University, Türkiye
Hale	AKBULUT	Hacettepe University, Türkiye
Ahmet Tayfur	AKCAN	Necmettin Erbakan University, Türkiye
Bariş	ALPASLAN	Social Sciences University of Ankara, Türkiye
Hakan	AY	Dokuz Eylül University, Türkiye
Basak	DALGIÇ	Hacettepe University, Türkiye
Burcu	FAZLIOĞLU	TOBB University of Economics and Technology, Türkiye
Sevilay Ece	GÜMÜŞ-ÖZUYAR	Necmettin Erbakan University, Türkiye
Egemen	İPEK	Tarsus University, Türkiye
Fatih	KALECİ	Necmettin Erbakan University, Türkiye
Mustafa	KIZILTAN	Hacettepe University, Türkiye
Altuğ Murat	KÖKTAŞ	Necmettin Erbakan University, Türkiye
Zuhal	KURUL	Hacettepe University, Türkiye
Metin	MERİÇ	Ankara Hacı Bayram Veli University, Türkiye
Aslı Ceren	SARAL	Ankara University, Türkiye
Işıl Şirin	SELÇUK	Bolu Abant İzzet Baysal University, Türkiye
Ayşen	SİVRİKAYA	Hacettepe University, Türkiye

Editorial Advisory Board / Uluslararası Danışma Kurulu

Tekin	AKDEMİR	Ankara Yıldırım Beyazıt University, Türkiye
Abdilahi	ALI	University of Salford, United Kingdom
Nunzio	ANGIOLA	University of Foggia, Italy
Ahmet Yılmaz	ATA	Kahramanmaraş Sütçü İmam University, Türkiye
Shafiul	AZAM	Aberystwyth University, United Kingdom
Necmaddin	BAGDADIOĞLU	Hacettepe University, Türkiye
Elshan	BAGIRZADEH	Azerbaijan State University of Economics, Azerbaijan
Serdal	BAHÇE	Ankara University, Türkiye
Alparslan Abdurrahman	BAŞARAN	Hacettepe University, Türkiye
Duran	BÜLBÜL	Atılım University, Türkiye
Caterina	DE LUCIA	University of Foggia, Italy
Matthias	FINGER	Ecole Polytechnique Fédérale de Lausanne, Switzerland
Ömer	GÖKÇEKUŞ	Seton Hall University, U.S.A.
Aleksandra	GÓRECKA	Warsaw University of Life Sciences, Poland
Katsushi	IMAI	University of Manchester, United Kingdom
Kamalbek	KARYMSHAKOV	Kyrgyz-Turkish MANAS University, Kyrgyzstan
Ayşegül	KAYAOĞLU-YILMAZ	İstanbul Technical University, Türkiye
King Yoong	LIM	Xi'an Jiaotong-Liverpool University, P.R. China
Mehmed	MURİC	University for Peace, Serbia
Joaquín	NAVAL	University of Girona, Spain
Maria Paola	RANA	University of Salford, United Kingdom
Uğur	SADIOĞLU	Hacettepe University, Türkiye
Antonio	SAVOIA	University of Manchester, United Kingdom
M. Mahruf C.	SHOHEL	Aberystwyth University, United Kingdom
Biagio	SIMONETTI	Università degli Studi del Sannio, Italy
Joseph	SZYLIOWICZ	University of Denver, U.S.A.
Bican	ŞAHİN	Hacettepe University, Türkiye
Nevzat	ŞİMŞEK	Dokuz Eylül University, Türkiye
Mustafa Erdinç	TELATAR	Okan University, Türkiye
Ayşe Yasemin	YALTA	Hacettepe University, Türkiye

Referees of This Issue / Bu Sayının Hakemleri

Hayri	ABAR	Gaziantep University
Yunus	AÇCI	İskenderun Technical University
Hale	AKBULUT	Hacettepe University
Tolga	AKSOY	Yıldız Technical University
Çağdaş Erkan	AKYÜREK	Ankara University
Şükrü	APAYDIN	Nevşehir Hacı Bektaş Veli University
Ahmet Yılmaz	ATA	Kahramanmaraş Sütçü İmam University
Hakan	AY	Dokuz Eylül University
Mücahit	AYDIN	Sakarya University
Deniz	AYTAÇ	Hitit University
Yaşar	AYYILDIZ	Bolu Abant İzzet Baysal University
Mehmet	BAŞ	Ankara Hacı Bayram Veli University
Eсна Betül	BUĞDAY	Hacettepe University
Eren	ÇAŞKURLU	Ankara Hacı Bayram Veli University
Zeynep	ÇOPUR	Hacettepe University
Mehmet Akif	DESTEK	Gaziantep University
Niranjana	DEVKOTA	Tribhuvan University
Billur	ENGİN-BALIN	İstanbul University
Mehmet	GÖZLÜ	Gaziantep University
Beyza	GÜLTEKİN	Hacettepe University
Miraç Fatih	İLGÜN	Erciyes University
Egemen	İPEK	Tarsus University
İbrahim	KARAASLAN	Gümüşhane University
Kasım	KIRACI	İskenderun Technical University
Müslüme	NARİN	Ankara Hacı Bayram Veli University
Mustafa Kemal	ÖKTEM	Hacettepe University
Reyhan	ÖZEŞ-ÖZGÜR	İstanbul Gelişim University
Önder	ÖZGÜR	Ankara Yıldırım Beyazıt University
Uğur Korkut	PATA	Osmaniye Korkut Ata University
Metin	SAĞLAM	Ondokuz Mayıs University
Ramasamy	SATHISHKUMAR	Periyar Maniammai Institute of Science and Technology
Avik	SINHA	Lebanese American University
Ayşen	SIVRİKAYA	Hacettepe University
Cuma	SUNGUR	Kahramanmaraş Sütçü İmam University
Onur	SUNGUR	Süleyman Demirel University
İzzet	TAŞAR	Fırat University
Özgür	TEÖMAN	Hacettepe University
İbrahim	TOKATLIOĞLU	Ankara Hacı Bayram Veli University
Zehra	TÜRK	Muğla Sıtkı Koçman University
Harun	YAKIŞIK	Çankırı Karatekin University
Ebru	YALÇIN	Kütahya Dumlupınar University
Mehmet	YAŞAR	Kastamonu University
Onur	YENİ	Hacettepe University
Harun	YENİÇERİ	Bandırma Onyeddi Eylül University
Veli	YILANCI	Çanakkale Onsekiz Mart University
Bülent	YILDIZ	Aydın Adnan Menderes University
Seyfi	YILDIZ	Kırıkkale University
Volkan	YURDADOĞ	Çukurova University

Content

Author(s)	Title	pp.
	Executive Summary	6
	Editörün Notu	8
<i>Research Article</i>	Cultural and Generational Differences in Predicting Green Consumption: A Mediated Moderation Model Yeşil Tüketimin Tahmin Edilmesindeki Kültürel ve Kuşaksal Farklılıklar: Aracı Düzenleyici Modeli	11
<i>Research Article</i>	Tuna ÇAKAR Türkay ŞAHİN Seyit ERTUĞRUL Alperen SAYAR Understanding the Psychological and Financial Correlates for Consumer Credit Use Tüketici Kredisi Kullanımının Altında Yatan Psikolojik ve Finansal Değişkenleri Anlamak	31
<i>Research Article</i>	Fettah KAYRA Deniz TAŞCI Akansel YALÇINKAYA Umut KOÇ Translation And Diffusion Process of The Shopping Mall Form: A Case Study Alışveriş Merkezi Formunun Çeviri ve Yayılım Süreci: Bir Vaka Analizi	49
<i>Research Article</i>	Yücel AYRIÇAY Meltem KILIÇ Seren AYDINGÜLÜ-SAKALSIZ The Relationship Between Renewable Energy Consumption and Stock Market Capitalisation and Carbon Emissions: Insights from G20 Countries Yenilenebilir Enerji Tüketimi ve Piyasa Kapitalizasyonu ile Karbon Emisyonu Arasındaki İlişki: G20 Ülkeleri Örneği	91
<i>Research Article</i>	Özlem KURU-SÖNMEZ Emre YAKUT Determination of the Factors Affecting Divorce in Türkiye According to Gender: A Research with TUIK Data Türkiye’de Boşanmayı Etkileyen Faktörlerin Cinsiyete Göre Belirlenmesi: TUIK Verileri Üzerinde Bir Araştırma	105
<i>Research Article</i>	Sinan DÜNDAR Gülay DEMİR İlkay NOYAN-YALMAN Şerife Merve KOŞAROĞLU Selçuk Yasin YILDIZ Efficiency of Investment Incentives in Reducing Regional Development Disparities in Türkiye Türkiye’de Yatırım Teşviklerinin Bölgesel Gelişmişlik Farklarını Azaltma Konusunda Etkinliği	129
<i>Research Article</i>	Mahmut Akif GÜVEN Alparslan Abdurrahman BAŞARAN Household Water Consumption and Tariff Structure: The Analysis of Türkiye’s Three Metropolitan Cities Hanehalkı Su Tüketimi ve Tarife Yapısı: Türkiye’de Üç Büyükşehir Üzerine Bir Analizi	151
<i>Research Article</i>	Gamze ERGİN Kahraman ÇATI Ebru OSKAOĞLU Intermediate Role of Rational Spending in The Effect of Responsibility Consciousness on Utility Consumption Style Sorumluluk Bilincinin Faydacı Tüketim Tarzına Etkisinde Rasyonel Harcamanın Aracılık Rolü	173
<i>Research Article</i>	Tayfur BAYAT Altuğ Murat KÖKTAŞ Selim KAYHAN Gökhan KONAT Effects of FX on ETF Prices: Evidence from BIST Döviz Kurunun BYF’ler Üzerindeki Etkileri: BİST’ten Kanıtlar	207
<i>Research Article</i>	Tayfun MOĞOL Burak PİRDAL Orta Gelir Tuzağı ve Vergi Gelirlerinin Kompozisyonu Arasındaki İlişki: Yükselen G20 Ülkeleri Örneği Relationship Between the Middle-Income Trap and the Composition of Tax Revenues: Evidence from Emerging G20	223
<i>Research Article</i>	Ahmet KAMACI Küreselleşme, Hidroelektrik Enerji, Ekonomik Büyüme, CO₂ Emisyonları ve Ekolojik Ayak İzi İlişkisinin ABD İçin Analizi: Kesirli Fourier ADL Eşbütünleşme Yöntemi The Analysis of Globalization, Hydroelectric Energy, Economic Growth, CO ₂ Emissions and Ecological Footprint Relationships for the USA: Fractional Fourier ADL Cointegration Method	249

		Avrupa Birliđi Ülkelerinde Çevre Vergilerinin Çevre, Ekonomik Büyüme ve İşsizlik Üzerindeki Etkisinin Ampirik Analizi	
<i>Research Article</i>	Sema DİRGEN-ÖZ Hüseyin Güçlü ÇİÇEK	Empirical Analysis of the Effects of Environmental Taxes on Environment, Economic Growth and Unemployment in European Union Countries	269
<i>Research Article</i>	Mehmet Fatih ASLANTAŞ Tuncer YILMAZ Mehmet Fatih ÇAPANOĞLU	Finansal İstikrarsızlıđın Kamu Bankalarının İstikrarına Etkisi: Bir PMG/ARDL Panel Yaklaşımı The Effect of Financial Instability on the Stability of Public Banks: A PMG/ARDL Panel Approach	297
<i>Research Article</i>	Füsun ÇELEBİ-BOZ Tuđba ÖRS-ONUR	Çevre Vergileri, Karbon Emisyonu ile Ekonomik Büyüme Arasındaki İlişki: OECD Ülkeleri Üzerine Bir Analiz The Relationship Between Environmental Taxes, Carbon Emissions and Economic Growth: An Analysis of OECD Countries	325
<i>Research Article</i>	Duran BÜLBÜL Zehra AKGÜNGÖR	Dünyada Ulaştırma Sektöründe Kamu-Özel Ortaklıđının Gelişimi Development of Public-Private Partnerships in the Transportation Sector in The World	343
<i>Research Article</i>	Ayşe ÇAY-ATALAY	D-8 Ülkeleri İçin Karbondioksit Emisyonun Yapay Sinir Ağları ile Tahmin Edilmesi: Levenberg-Marquardt Algoritması Forecasting Carbon Dioxide Emissions for D-8 Countries by Artificial Neural Networks: Levenberg-Marquardt Algorithm	363
<i>Research Article</i>	Tarık Zeki YILMAZ Cemil RAKICI	Sosyal Koruma Harcamalarının Gelir Eşitsizliđi Üzerindeki Etkisi: Türkiye Örneđi The Effect of Social Protection Expenditures on Income Inequality: The Case of Türkiye	383
<i>Research Article</i>	Ömer YALÇINKAYA Vedat KAYA Gökhan ERKAL	Türkiye İçin Ekonomik Yapısal Reform Ölçüm Yöntemlerinin Geliştirilmesi ve Büyüme Üzerindeki Etkilerinin İncelenmesi Development of Economic Structural Reform Measurement Methods for Türkiye and Examining the Effects on Growth	405
<i>Research Article</i>	Murat Ahmet DOĞAN Cankut AYDIN	Türk Sivil Havacılıđı Endüstrisinin Etkinliđi ile Endüstri Yođunlaşması Arasındaki İlişkinin İncelenmesi Analysing The Relationship Between the Efficiency of the Turkish Civil Aviation Industry and Industry Concentration	433
<i>Research Article</i>	Bilgen TAŞDOĞAN	Kulüp Yakınsama Analizi Temelinde OECD Ülkelerinin Vergi Gayreti Performansı Tax Effort Performance of OECD Countries Based on Club Convergence Analysis	453
<i>Research Article</i>	Sevilay Ece GÜMÜŞ-ÖZUYAR Ayça ÖZEKİN	35 OECD Ülkesinde Vergi İdaresinin Etkinliđi: VZA Yöntemi Tax Administration Efficiency in 35 OECD Countries: DEA Method	475
<i>Erratum</i>	Nazlı ERSOY	DÜZELTME: BIST Perakende Ticaret Sektöründe LOPCOW-RSMVC Modeli ile Performans Ölçümü [Sosyoekonomi, 31(57), 419-436; DOI: 10.17233/sosyoekonomi.2023.03.20] ERRATUM: Performance Measurement in the BIST Retail and Trade Sector with the LOPCOW-RSMVC Model [Sosyoekonomi, 31(57), 419-436; DOI: 10.17233/sosyoekonomi.2023.03.20]	501
	Notes for Contributors		506
	Yazarlara Duyuru		507

Executive Summary

This year, we entered the 20th publication year of *Sosyoekonomi Journal*, which started its publication in 2004 and published its first issue in 2005. We are happy to reach these days together with our colleagues who have worked with great devotion for 20 years. We will continue to work with effort to make *Sosyoekonomi* an internationally recognised and more respected journal with better quality content in the following years.

In issue 32(59), the first issue of the twentieth year, we bring you twenty-one articles containing socioeconomic-based research and findings. The first study examines the concept of green consumption, which has gained importance with the increase in global environmental awareness, in the context of the relationship between cultures and generations. The second study is about loans and explores the behavioural and cognitive factors influencing consumer credit use. The third article examines the transition processes and changes in shopping malls, which have created an established and taken-for-granted shopping culture in Turkey in the last twenty years, and the factors affecting this process. In the following research, a topic related to climate change was chosen. The relationship between renewable energy consumption, capitalisation and carbon emissions was investigated in the 20 most developed countries.

The following three consecutive studies of the issue are also related to Turkey. The fifth study examines factors affecting divorce; the sixth examines the role of investment incentives in reducing regional development differences; the seventh examines the water consumption of households in three metropolitan cities in the days when local elections are approaching. On the other hand, the eighth and ninth studies are behaviourally focused-economic studies. While the first of these studies is related to the widely studied consumption and responsibility awareness behaviour pattern, coincidentally throughout the issue, The other paper, the ninth study, deals with the impact of exchange rate on investor behaviour in exchange-traded funds.

Considering that poverty, income and middle ground are frequently mentioned today, it would not be wrong to say that the tenth study also deals with a trendy subject. This study is a unique study investigating the middle-income trap and tax revenues based on the twenty emerging economies that are increasingly dominant in the world rather than the G20 countries. Economies that have increased their weight in the market, we should not ignore the USA, one of the largest global players in the worldwide economy. The eleventh article explores the impact of globalisation, economic growth, and hydroelectric power on the United States' carbon emissions and ecological footprint. At this point, the European Union, an actor that can affect global and environmental degradation, is the subject of analysis in the twelfth article. The study investigating the impact of environmental taxes on the environment, economic growth, and unemployment in the European Union Countries determined that environmental tax practices did not reduce emissions.

The thirteenth, fourteenth and fifteenth works are quite remarkable. The thirteenth article examines the impact of financial instability on the stability of public banks between 2017 and 2022; the fourteenth study examines the relationship between environmental tax, carbon emissions and economic growth between 1995 and 2020; the fifteenth study discussed public-private partnerships in the transportation sector on a global scale. Another study that is among the articles that should be scrutinised is the sixteenth article that examines the environment and carbon emissions with artificial neural networks, which is widely published in this issue. In addition to the originality that the use of artificial intelligence, which is a newly developing age but will technologically lead the coming centuries, adds to the study, significant findings have been revealed in terms of showing why the lifestyles adopted in different parts of the world are not sustainable.

Supporting the details of Turkey's financial and economic structure with applied studies, especially in the last twenty years, sheds light on theoretical studies and practitioners. The seventeenth study contributes to the literature by investigating the effect of social protection expenditures on income inequality in 1987-2018 using the ARDL method. In this context, the eighteenth study has a similar content. Data from the 1990-2021 Presidency of Turkey Official Gazette archive and examining the effects on economic growth with the BF-ARDL model have revealed a different and detailed perspective. The following article discusses the development of civil aviation, a critical and sensitive sector for Turkey's private and public sectors. It analyses the absolute and relative market concentrations between 2012 and 2022 with the data envelopment technique.

The high scientific contribution power of econometric models has also spread to tax studies, which worked only theoretically and qualitatively for a while. The twentieth article, which discusses the tax effort of OECD countries, concluded through club convergence analysis that although there is no statistically significant relationship between tax effort and the underground economy, the informal economy variable affects the tax effort for Club 4 countries, including Turkey. The twenty-first study, the issue's last article, evaluated OECD countries

and analysed the effectiveness of tax administrations in these countries with the data envelopment technique, and contributed to the literature by estimating the relative efficiency scores of tax administrations among countries and creating an efficiency score set.

I am grateful to all the authors and editorial board members who have devotedly contributed to the Sosyoekonomi Journal for 20 years. Believing that the studies in this issue will contribute to the world of science, I would like to express my respect to all the followers of Sosyoekonomi for their continued interest for 20 years.

Prof.Dr. Ahmet Burçin YERELİ

Editor

Editörün Notu

2004 yılında yayın hayatına başlayan ve ilk sayısını 2005 yılında çıkaran Sosyoekonomi Dergisinin bu yıl 20. yayın hayatına girmiş bulunmaktadır. 20 yıl boyunca büyük bir özveriyle çalışan takım arkadaşlarımız ile birlikte bugünlere ulaşmanın mutluluğunu yaşıyoruz. Sosyoekonomi Dergisini izleyen yıllarda daha kaliteli bir içerikle uluslararası arenada daha tanınan ve daha saygın bir dergi haline getirebilme azmi ve gayretiyle çalışmaya devam edeceğiz.

Yirminci yılın ilk sayısı olan 32(59) sayısında sosyoekonomik temelli araştırma ve bulguları içeren yirmi bir çalışmayı sizlerle buluşturuyoruz. Dergimizin açılış çalışması, küresel anlamda çevre duyarlılığının artışı ile önem kazanan yeşil tüketim anlayışını kültürler ve kuşaklar arasındaki ilişki bağlamında incelemektedir. İkinci çalışma kredilerle ilgilidir ve tüketici kredisi kullanımını etkileyen davranışsal ve bilişsel faktörleri araştırmaktadır. Üçüncü makale, Türkiye’de son yirmi yılda yerleşik ve kanıksanan bir alışveriş kültürü oluşturan AVM’lerin geçiş süreçlerini, değişimlerini ve bu süreçte etkili olan faktörleri inceleme konusu yapmaktadır. Takip eden araştırmada da iklim değişikliği ile ilintili bir konu seçilmiştir. En gelişmiş 20 ülkede yenilenebilir enerji tüketimi, kapitalizasyon ve karbon emisyonu arasındaki ilişki araştırılmıştır.

Sayının takip eden ardışık üç çalışması da Türkiye ile ilgilidir. Beşinci çalışma boşanmayı etkileyen faktörleri; altıncısı yatırım teşviklerinin bölgesel gelişmişlik farklarını azaltmadaki rolünü; yedincisi ise yerel seçimlerin yaklaştığı şu günlerde üç büyükşehirde hanehalkının su tüketimini incelemiştir. Öte yandan sekizinci ve dokuzuncu çalışmalar davranışsal odaklı iktisadi çalışmalardır. Bu çalışmalardan ilki sayının genelinde bir tesadüf eseri çokça çalışılan tüketim ve sorumluluk bilinci davranış kalıbıyla ilişkilirken; diğer makale olan dokuzuncu çalışma döviz kurunun borsa yatırım fonları üzerindeki yatırımcı davranışlarını ele almaktadır.

Yine günümüzde yoksulluk, gelir ve orta direk kavramlarının sıkça dile getirildiği düşünüldüğünde onuncu çalışmanın da oldukça popüler bir konuyu ele aldığı söylemek yanlış olmayacaktır. Bu çalışma, G20 ülkelerinden ziyade dünya üzerinde ağırlığı artan yükselen yirmi ekonomiden yola çıkarak orta gelir tuzağı ve vergi gelirlerini artırarak özellikli bir çalışmadır. Piyasada ağırlığını artıran ekonomiler demişken, küresel ekonominin en büyük küresel oyuncularından ABD’yi de atlama gerekir. On birinci makale ABD’de küreselleşmenin, ekonomik büyümenin ve hidroelektrik enerjinin karbon emisyonu ve ekolojik ayak izi üzerindeki etkisini araştırmaktadır. Tam da bu noktada küresel ve çevresel bozulmayı etkileyebilecek bir aktör olan Avrupa Birliği on ikinci makalede inceleme konusu yapılmıştır. Avrupa Birliği Ülkeleri’nde çevre vergilerinin çevre, iktisadi büyüme ve işsizlik üzerindeki etkisini araştıran çalışmada, maalesef çevre vergisi uygulamalarının emisyonları azaltmadığı saptanmıştır.

On üç, on dört ve on beşinci çalışmalar oldukça dikkat çekicidir. On üçüncü makale 2017-2022 yılları arasında finansal istikrarsızlığın kamu bankalarının istikrarına etkisini; on dördüncü çalışma 1995-2020 yılları arasında çevre vergisi ile karbon emisyonu ve ekonomik büyüme arasındaki ilişkiyi; on beşinci çalışma ise küresel ölçekte ulaştırma sektöründeki kamu özel ortaklıklarını ele almıştır. Dikkatle incelenmesi gereken makaleler arasında yer alan bir diğer çalışma da bu sayıda oldukça çokça yer bulan çevre ve karbon emisyonunu yapay sinir ağları ile inceleyen on altıncı makaledir. Çağın yeni gelişen ancak gelecek yüzyıllara teknolojik olarak liderlik edecek yapay zekâ kullanımının çalışmaya kattığı özgünlüğün yanı sıra dünyanın farklı bölgelerinde benimsenen yaşam tarzlarının neden sürdürülebilir olmadığını göstermesi açısından da oldukça önemli bulgular ortaya konulmuştur.

Türkiye’deki mali ve iktisadi yapının detaylarının özellikle son yirmi yılda uygulamalı çalışmaları desteklenmesi hem teorik çalışmalara hem de uygulamacılara ışık tutmaktadır. On yedinci çalışma 1987-2018 dönemindeki sosyal koruma harcamalarının gelir eşitsizliğine etkisini ARDL yöntemi ile araştırarak literatüre katkı sağlamaktadır. Bu bağlamda on sekizinci çalışma da benzer bir içeriktedir. 1990-2021 Türkiye Cumhuriyeti Cumhurbaşkanlığı Resmî Gazete arşivinden ölçülmesi ve ekonomik büyüme üzerindeki etkilerinin BF-ARDL modeliyle incelenmesi farklı ve detaylı bir bakış açısı ortaya koymuştur. İzleyen makale gerek özel gerekse kamu açısından oldukça önemli ve hassas bir sektör olan sivil havacılığın Türkiye’de gelişimini ele alarak 2012-2022 yılları arasında mutlak piyasa yoğunlaşması ve göreceli piyasa yoğunlaşmasını veri zarflama tekniği ile analiz etmektedir.

Ekonometrik uygulamaların bilimsel katkı gücünün yüksekliği bir dönem sadece teorik ve nitel olarak çalışan vergi çalışmalarına da sirayet etmiştir. OECD ülkelerinin vergi gayretinin ele alındığı yirminci makale, kulüp yakınsama analizi ile vergi gayreti ve kayıt dışı ekonomi arasında istatistiksel olarak anlamlı ilişki olmamasına rağmen, Türkiye’nin yer aldığı Kulüp 4 ülkeleri için kayıt dışı ekonomi değişkeninin vergi gayretini etkilediği sonucuna ulaşılmıştır. Sayının sonuncu makalesi olan yirmibirinci çalışma ise yine OECD ülkelerini

değerlendirmeye alarak bu ülkelerdeki vergi idarelerinin etkinliğini veri zarflama tekniđi ile analiz etmiş ve ülkeler arasında vergi idarelerinin görelî etkinlik puanlarını tahmin edip etkinlik puan seti oluşturarak literatüre katkı sağlamıştır.

20 yıl boyunca büyük bir özveriyle Sosyoekonomi Dergisine katkı sunan tüm yazarlara ve yayın kurulu üyelerine müteşekkirim. Bu sayımızda yer alan çalışmaların bilim dünyasına katkı sağlayacağına olan inançla Sosyoekonomi Dergisinin tüm takipçilerine 20 yıldır süregelen ilgilerinden dolayı saygılarımı sunuyorum.

Prof.Dr. Ahmet Burçin YERELİ

Editör

Cultural and Generational Differences in Predicting Green Consumption: A Mediated Moderation Model

Hasan Selçuk ETİ (<https://orcid.org/0000-0002-3792-697X>), *Tekirdağ Namık Kemal University, Türkiye;*
hseti@nku.edu.tr

Yeşil Tüketimin Tahmin Edilmesindeki Kültürel ve Kuşaksal Farklılıklar: Aracı Düzenleyici Modeli

Abstract

This study aimed to examine the effects of the antecedents of the theory of planned behaviour and environmental concern on green purchase intention. It also examines the mediating role of attitude and the moderating roles of generation and culture in these relationships. Using an online survey, the study collected primary data from 446 international students at Tekirdağ Namık Kemal University. As a result of structural equation modelling, it was determined that attitude, subjective norms, perceived behavioural control and environmental concern increased green purchase intention. In addition, it was determined that attitude partially mediated the relationship between environmental concern and green purchase intention and that this relationship was stronger in Western culture.

Keywords : Green Consumption, Environmental Problems, Theory of Planned Behaviour, Mediated Moderation Model.

JEL Classification Codes : D11, Q5, C1.

Öz

Bu çalışmada öncelikle planlı davranış teorisinin öncüllerinin ve çevresel kaygının yeşil satın alma niyeti üzerindeki etkilerinin incelenmesi amaçlanmıştır. Ayrıca söz konusu ilişkilerde tutumun aracılık rolü ile kuşak ve kültürün düzenleyici rolünün incelenmesi de hedeflenmiştir. Araştırmada çevrimiçi bir anket kullanılarak Tekirdağ Namık Kemal Üniversitesindeki 446 uluslararası öğrenciden birincil veri toplanmıştır. Yapısal eşitlik modellemesi sonucunda; tutum, öznel normlar, algılanan davranışsal kontrol ve çevresel kaygının, yeşil satın alma niyetini artırdığı tespit edilmiştir. Bunun yanında, çevresel kaygı ile yeşil satın alma niyeti arasındaki ilişkiye tutumun kısmi aracılık ettiği ve söz konusu ilişkinin batı kültüründe daha güçlü olduğu belirlenmiştir.

Anahtar Sözcükler : Yeşil Tüketim, Çevresel Problemler, Planlı Davranış Teorisi, Aracı Düzenleyici Model.

1. Introduction

The gradual decrease of natural resources essential for life, the increase in environmental pollution, the disappearance of biological diversity, and global warming are among the environmental problems currently experienced worldwide. On the other hand, with the development of environmental awareness, people now pay greater attention to environmental issues (Bartels & Onwezen, 2014; Moslehpour et al., 2023). Their increased understanding of environmental problems also makes them worried about future generations and the world's future, leading to green movements in societies (Akehurst et al., 2012; Paul et al., 2016). Seeing the problems that threaten environmental sustainability, people have also changed their consumption habits with greater consumer attention to environmentally friendly products and altered purchasing behaviours. Now, people prefer products that do not harm the environment while benefiting themselves and the future rather than providing instant gain (Kaufmann et al., 2012; Samarasinghe et al., 2013). These developments have resulted in a new trend of green consumption in which consumers are sensitive to the environment, have environmental concerns, and therefore look for green products (Paul et al., 2016).

Environmentally sensitive and recyclable products that do not harm nature or consume natural resources are considered "green" (Canoz, 2022; Paul et al., 2016). This concept includes the steps in almost all processes, such as raw material supply, production, storage, packaging, transportation, and distribution. Green products have been developed to prevent or reduce environmental impacts due to the development, production, use, and disposal of products and services. Thus, a green product can perform the same functions as the equivalent conventional product while less harmful to the environment throughout its life cycle (Junior et al., 2015). Green consumers are socially responsible consumers concerned about the public consequences of their private consumption and seek to influence social change through their purchasing power (Joshi & Rahman, 2015; Nova-Reyes et al., 2020). To reduce the environmental impact of their consumption patterns, green consumers consider the environmental impacts of their consumption patterns and modify their behaviours accordingly. Furthermore, green consumers tend to engage in green purchasing behaviour, i.e., they purchase products that do not harm the environment and are labelled as "green" to minimise the environmental impact of their consumption (Ritter et al., 2015).

Green purchasing behaviour refers to consuming environmentally friendly, recyclable, environmentally sensitive products while avoiding products that harm society (Jaiswal & Kant, 2018; Zeynalova & Namazova, 2022). Green purchasing behaviour, which differs from purchasing behaviour, has a special place in consumer behaviour. Purchasing behaviour only relates to the consumer's perception of the product's benefits and costs, whereas green purchasing behaviour is more future-oriented and produces social benefits rather than short-term gain or satisfaction. In green purchasing behaviour, social use is generally weighted more than the individual benefit when determining personal benefit preferences (Kim & Choi, 2005; Kaufmann et al., 2012).

The growing tendency of consumers to buy green products has attracted researchers' attention, while unsustainable environmental problems have increased the importance of their studies (Shao & Unal, 2019). Drawing on the theory of planned behaviour (TPB), which tries to explain the individual's intention to perform a particular behaviour (Ajzen, 1991), many studies have examined the determinants of green purchasing behaviour, especially in recent years (Leary et al., 2014; Karatu & Mat, 2015; Yadav & Pathak, 2016; Hsu et al., 2017; Joshi & Rahman, 2017; Maichum et al., 2017; Hasan & Suciarto, 2020; Bui et al., 2021; Patwary et al., 2022; Aseri & Ansari, 2023). Environmental concern is frequently discussed as an attitude towards environmental degradation that increases green purchasing intention (Chekima et al., 2016), while other studies show that environmental crises increase green purchase intention (Manaktola & Jauhari, 2007; Dagher & Itani, 2012; Joshi & Rahman, 2017).

Within this framework, a need has emerged to examine the predictors of green purchase intention, TPB antecedents, and environmental concerns. There is also a gap in the literature concerning whether attitude influences the relationship between environmental concern and green purchase intentions (Mamun et al., 2018). On the other hand, green consumption behaviours are not determined by individual, consumer-centred factors alone because external factors also significantly determine the formation of individuals' consumption behaviours (Stern, 2005). The moderating effects of these factors on the relationships between attitudes and behaviours have been investigated in the green consumption literature (Dagher et al., 2015). A critical demographic determinant of green consumption behaviours is generation, as each has characteristics such as value judgments, attitudes, strengths, and weaknesses. Therefore, generation-based differences in consumer behaviour can be expected (Lower, 2008). There is also a reciprocal interaction between generations and society in that each generation is affected by the community while changing the community's attitudes and behaviours to a certain extent (Aktas & Cicek, 2019). Thus, the factors that motivate consumers to consume green are affected by the common intellectual processes of their society (Kotler, 2011). Hence, green consumption may differ according to a person's culture (Sreen et al., 2018). However, there appears to be a lack of studies examining these intergenerational and intercultural effects in predicting green purchase intention.

In this context, this study has three purposes. It first examines the influence of antecedents of TPB (such as attitude, subjective norms, and perception of behavioural control) on purchasing intention in green consumption. The second aspect of the study examines the mediating effect of attitude on the relationship between environmental respect and the intention to make green purchases. Finally, it looks at the moderating role of generation and culture in the abovementioned relationships.

2. Methodology

2.1. Conceptual Framework

This research utilised Ajzen's (1991) TPB to understand consumer behaviour regarding green products. Human behaviour can be explained using TPB in many different fields, including environmental psychology (Stern, 2005). According to TPB, behaviour is a direct function of behavioural intention. Generally, the stronger an individual's intention to perform a behaviour, the likelihood they will perform it. Three factors contribute to behavioural intention: attitudes toward the behaviour, subjective norms, and perceived control of the behaviour (Ajzen, 1991).

Purchase intention represents consumers' willingness or plan to purchase a particular product in the future, while green purchase intention is the consumer's determination to act environmentally, which is a motivating factor for green purchasing (Akehurst et al., 2012). Green purchase intention is related to an individual's tendency to purchase and use products with environmentally friendly features. Consumers are concerned not only about the quality of the product but also about the environmental impact of their purchases (Jaiswal & Kant, 2018). Although most consumers intend to buy green products, this fact conflicts with restrictive factors, such as price and lifestyle, during the decision-making process to purchase green products. Consequently, their behaviour may not reflect their intentions (Bramiah et al., 2011).

An illustration of the research model can be found in Figure 1. The independent variables of environmental concern, attitude, subjective norms, and perceived behavioural control influence green purchase intention. Furthermore, the model examines how attitude mediates the relationship between the independent and dependent variables, while generation and culture are moderator variables.

Figure: 1
Proposed Research Framework

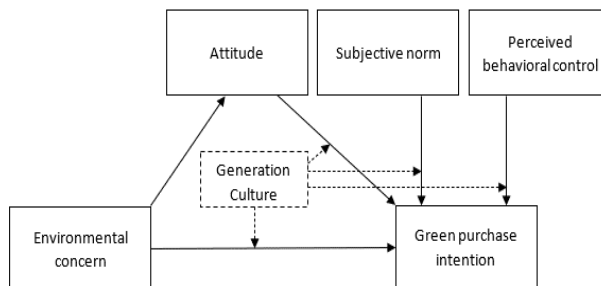

2.1.1. Attitude

Attitude plays a substantial role in influencing behaviour (Chekima et al., 2016) and is an essential variable in understanding green consumers' behaviour (Trivedi et al., 2018). Attitude refers to a person's positive or negative evaluations of behaviours. Suppose the individual has a positive attitude towards a specific behaviour. In that case, the intention to enact the behaviour and the rate of enacting the behaviour is higher than for another person with a negative attitude (Ajzen, 1991).

Regarding purchase intentions, attitude is one of the most important factors to consider (Tang et al., 2014). Attitudes significantly and positively influence the intention to purchase green products in numerous previous studies (Vazifehdoust et al., 2013; Tang et al., 2014; Paul et al., 2016; Yadav & Pathak, 2016; Hsu et al., 2017; Maichum et al., 2017; Trivedi et al., 2018). This suggests the following hypothesis:

H₁: Attitude towards green purchasing positively and significantly affects green purchase intention.

2.1.2. Subjective Norms

According to Ajzen (1991), subjective norms refer to social pressure to perform a particular behaviour. In other words, subjective norms represent the approval or disapproval of an individual's behaviour by others significant to the individual (Ajzen, 1991). Subjective norms are other people's opinions that are important to a person and affect the individual's decision-making processes. If a person believes that a particular behaviour will be approved or rejected by influential people, they intend to exhibit that behaviour more or less, respectively (Maichum et al., 2016). Regarding green consumption, if the person or group that the individual takes as a reference believes that protecting the environment and environmental practices are important, then the individual's behaviours may reflect these beliefs of others (Hsu et al., 2017).

Subjective norms, considered an important determinant of green consumption (Paul et al., 2016), can affect consumers' behaviour due to the influence of other individuals' opinions, significantly impacting their green purchases (Maichum et al., 2016). Many studies confirm that subjective norms increase green purchase intention (Han et al., 2010; Hu et al., 2010; Wu & Chen, 2014; Hsu et al., 2017). This suggests the following hypothesis:

H₂: Subjective norms positively and significantly affect green purchase intention.

2.1.3. Perceived Behavioural Control

An individual's perception of their ability to perform a given behaviour is called their perceived behavioural control (PBC). Depending on the individual's perception, PBC indicates whether a particular behaviour is easy or difficult to perform (Ajzen, 1991).

It is thought that a low level of PBC can inhibit behaviour, whereas a high PBC can increase behaviour and behavioural intention. Thus, PBC positively relates to behavioural intention (Tsai, 2010). Various studies have demonstrated the positive effect of PBC on green purchase intention (Chan & Lau, 2002; Tsai, 2010; Karatu & Mat, 2015; Hsu et al., 2017; Hasan & Suciarto, 2020; Bui et al., 2021). Consequently, it is predicted that:

H₃: Perceived behavioural control positively and significantly affects green purchase intention.

2.1.4. Environmental Concern

Environmental concern is another key variable besides TPB antecedents in predicting green product purchasing behaviour (Paul et al., 2016; Yadav & Pathak, 2016; Jaiswal & Kant, 2018). This general attitude reflects the extent of the consumer's concern about environmental threats (Ishaswini & Datta, 2011).

Concerns caused by environmental problems affect environmental responsibility and consciously or unconsciously affect consumption behaviours. Environmental concern encourages consumers to be "greener" in their purchases and increases green purchase intention (Leary et al., 2014; Chekima et al., 2016). Many studies indicate that environmental concern increases green purchase intention (Kim & Choi, 2005; Manaktola & Jauhari, 2007; Ishaswini & Datta, 2011; Dagher & Itani, 2012; Dagher et al., 2015; Joshi et al. Rahman, 2017). In this regard, it is predicted that:

H₄: Green purchase intentions are positively and significantly influenced by environmental concerns.

2.1.5. Attitude as Mediator

Environmental concern is accepted as an attitude towards protecting the environment and an important factor for understanding green purchase intention. In other words, environmental concern can determine the attitude reflecting positive or negative evaluations regarding green consumption and the intention to purchase green products (Maichum et al., 2016). A positive attitude towards green purchasing strongly determines green product purchasing behaviour (Trivedi et al., 2018).

Many studies show that environmental concern directly affects attitudes towards green purchasing (Leary et al., 2014; Tang et al., 2014; Jaiswal & Kant, 2018). Environmental concern also significantly affects purchase intention as well as attitude (Maichum et al., 2016). Environmental concern positively affects attitudes towards green purchasing, increasing green purchase intention (Vazifehdoust et al., 2013). In conclusion, attitude can mediate between environmental concerns and green purchasing intentions (Mamun et al., 2018). Consequently, it is predicted that:

H₅: Environmental concern and green purchase intention are mediated by the attitude towards green purchasing.

2.1.6. Generation and Culture as Moderators

Green consumption behaviour goes beyond consumers alone in that, in addition to individual factors, external factors also determine the formation of individuals' consumption behaviours (Stern, 2005). The moderating effects of these factors on the relationship between attitudes and behaviours have been investigated in the green consumption literature (Dagher et al., 2015). One of the important demographic characteristics affecting green consumption behaviours is generation. Each generation has its characteristics, value judgments, attitudes, strengths, and weaknesses, so consumer behaviour will likely differ according to generation (Lower, 2008). There is also a reciprocal interaction between generations and society as each generation is affected by society while also changing society somewhat through its attitudes and behaviours (Aktas & Cicek, 2019). Thus, the factors that motivate consumers to make green purchases are affected by their society's shared intellectual processes (Kotler, 2011), which implies that green consumption may vary according to a person's culture (Sreen et al., 2018).

Similar studies examining the relationship between environmental factors, generation (age), and culture have produced different findings. In 2008, for example, green products were preferred more by consumers over 55 years of age in the USA (Nastu, 2008), whereas they were selected more by consumers aged 25-34 in Portugal in 2009 (do Paço et al., 2009). PBC strongly affects green purchase intention in Chinese customers, whereas attitude and subjective norms are more effective in American consumers (Chan & Lau, 2002). However, there appears to be a need for studies in the literature examining intergenerational and intercultural predictors of green purchase intention. This suggests the following two hypotheses:

H₆: Generation moderates the relationships between environmental concern, attitude, subjective norms, perceived behavioural control, and green purchase intention.

H₇: Culture moderates the relationships between environmental concern, attitude, subjective norms, perceived behavioural control, and green purchase intention.

2.2. Procedure and Sample

The study population was 1,719 international students at Tekirdağ Namık Kemal University in Tekirdağ, Turkey. Cluster sampling was used to sample the proportion of students from each country equally, specifically by including a quarter of the students from each country. Simple random sampling was adopted to select these students from each country to draw the desired sample. The study sample thus consisted of 446 university students uniformly chosen from 20 different countries. The minimum sample size for the study was calculated as 314 with a 95% confidence interval and a 5% margin of error. Hair et al. (2010) suggest that the minimum number of participants should not be less than ten

times the number of items in the questionnaire. Accordingly, a minimum sample size of 240 is required in this study, which has a 24-item questionnaire. On this basis, the study's sample size (N=446) was sufficient for both approaches.

Primary data were collected from the participants using an online questionnaire. An explanation of the study's purpose was provided to the participants before the questionnaire was administered, and they were assured that their information would remain anonymous, confidential, and secure. After reading this information, the participants gave their voluntary participation consent. The survey was carried out in July 2022.

3. Results

3.1. Socio-demographic Profile of the Respondents

Table 1 presents the participants' demographic statistics.

Table: 1
Sample Characteristics

Demographic variables	n	%	Country	n	%
Gender			Syria	58	13.0
Female	157	35.2	Azerbaijan	53	11.9
Male	289	64.8	Greece	44	9.9
Date of birth			Bulgaria	37	8.3
1981-1999	131	29.4	Turkmenistan	31	7.0
After 2000	315	70.6	Ukraine	28	6.3
Marital status			Afghanistan	27	6.1
Single	347	77.8	Uzbekistan	26	5.8
Married	99	22.2	Macedonia	26	5.8
Education			Iran	23	5.2
Senior high school	309	69.3	Albania	16	3.6
College/university	96	21.5	Bosnia and Herzegovina	13	2.9
Master's degree or Ph.D.	41	9.2	Iraq	11	2.5
Perceived economic status			Yemen	9	2.0
Low	141	31.6	Egypt	9	2.0
Moderate	139	31.2	Germany	9	2.0
High	166	37.2	Jordan	8	1.8
			China	7	1.6
			The Netherlands	6	1.3
			France	5	1.1

3.2. Measures

The questionnaire used in the research had two parts. A total of 24 items were included in the first part of the study, which measured attitudes, subjective norms, perceived behavioural control, environmental concern, and purchasing intentions about green consumption. Each item was rated on a five-point Likert-type scale: "1" means strongly disagree, and "5" means strongly agree. The items used in this section were obtained from a previous study (Paul et al., 2016) in which the scales were validated. Secondly, the questionnaire asked participants about their demographic background, including their country of origin, gender, date of birth, marital status, educational level, and income. Table 2 provides descriptive statistics for the research variables.

Table: 2
Descriptive Statistics

Variables	Number of Items	Mean	sd
Attitude	3	4.58	0.50
Subjective norms	4	3.86	0.85
Perceived behavioural control	7	3.39	1.11
Environmental concern	5	4.36	0.60
Purchase intention	5	4.39	0.55

3.3. Common Method Variance

A common method variance depends on the measurement method rather than the constructs being measured by the scales (Podsakoff et al., 2003), which may occur in studies where all variables are measured with a single questionnaire and a similar methodology. The self-report method is used, and the same respondent evaluates different variables within the same period (Malhotra et al., 2006). This is particularly the case when both dependent and independent variables are obtained from the same respondents using perception-based scales. This, in turn, may cause systematic measurement errors, both Type I and Type II, which increase or decrease the strength of the observed relationships between variables more than the actual situation (Chang et al., 2010). Since the self-report method was used in the present study and the variables were evaluated with the same scale, at the same time, and by the same respondent, there was a risk of common method variance. Harman's single-factor test (Podsakoff et al., 2003) is the most common method of evaluating this item, which looks for the single unrotated factor solution across all items in the scale. If this single factor explains less than 50% of the variance, it is assumed that there is no common method problem (Harman, 1960; Podsakoff et al., 2003). In the present study, the single factor explained 37.55% of the variance, indicating no common method variance problem.

3.4. Reliability and Validity

Regarding the scale's reliability, both internal reliability and composite reliability were evaluated. In terms of validity, construct validity, convergent validity, and discriminant validity were evaluated. Table 3 presents the reliability and validity findings.

Table: 3
Reliability and Validity Results

Variables	Scale Items	Regression Weights	α	CR	AVE
Attitude	at1	0.981**	0.923	0.943	0.847
	at2	0.985**			
	at3	0.781**			
Subjective Norms	sn1	0.700**	0.808	0.818	0.532
	sn2	0.745**			
	sn3	0.808**			
	sn4	0.654**			

Perceived Behavioural Control	pbcl	0.778**	0.892	0.893	0.548
	pbcl2	0.801**			
	pbcl3	0.851**			
	pbcl4	0.696**			
	pbcl5	0.657**			
	pbcl6	0.626**			
	pbcl7	0.744**			
Environmental Concern	ec1	0.698**	0.813	0.814	0.467
	ec2	0.615**			
	ec3	0.725**			
	ec4	0.648**			
	ec5	0.725**			
Purchase Intention	pi1	0.940**	0.964	0.962	0.837
	pi2	0.966**			
	pi3	0.876**			
	pi4	0.886**			
	pi5	0.903**			

** $p < 0.01$; α =Cronbach's Alpha; CR=Composite reliability; AVE=Average variance extracted.

As seen in Table 3, the internal reliability criterion was met as the α coefficients were greater than 0.70 (Hair et al., 2010), while the composite reliability criterion was met as the CR values were greater than 0.70 (Fornell & Larcker, 1981). Regarding construct validity, the confirmatory factor analysis results showed that all items had a factor weight above 0.60. In addition, all goodness of fit values (CMIN/df=2,188; GFI=0,910; CFI=0,965; NFI=0,938; RMR=0,052 and RMSEA=0,052) of the measurement model fell within acceptable ranges (Cangur & Ercan, 2015). In other words, the data fits well with the model. Regarding convergent validity, the AVE values were examined. Fornell and Larcker (1981) recommend that these values be higher than 0.50. In addition, if the AVE value is less than 0.50, the convergent validity of the scale can be accepted, provided that the CR is higher than 0.6 since the AVE is a conservative measure (Fornell & Larcker, 1981; Malhotra et al., 2010). Table 3 shows that only environmental concern was slightly below 0.50, although its CR value was considerably above 0.60. Thus, the necessary criteria for convergent validity (Fornell & Larcker, 1981; Malhotra et al., 2010) were met. For discriminant validity, the square roots of the AVE values, which are diagonally presented in Table 4, were examined. Their values should be greater than the correlations between factors (Malhotra et al., 2010; Hair et al., 2010). As the results in Table 4 show, these meet the discriminant validity criterion.

Table: 4
Correlations and Discriminant Validity

Variables	AT	SN	PBC	EC	PI
Attitude (AT)	0.920 ^a				
Subjective norms (SN)	0.323	0.729 ^a			
Perceived behavioural control (PBC)	0.324	0.249	0.740 ^a		
Environmental concern (EC)	0.550	0.208	0.257	0.683 ^a	
Purchase intention (PI)	0.555	0.321	0.436	0.622	0.915 ^a

^a Square root of AVE.

3.5. Path Analysis

Structural equation modelling (SEM) was conducted using AMOS to test the hypotheses. According to the model in Figure 2, environmental concern, social norms, and perception of behavioural control are independent variables, attitude is the mediating

variable, and purchase intention is the dependent variable. As seen in Figure 2, all the model's goodness of fit values (CMIN/df=2.252; GFI=0.906; CFI=0.963; RMR=0.058 and RMSEA=0.053) are in the acceptable range (Cangur & Ercan, 2015).

Figure: 2
Structural Model

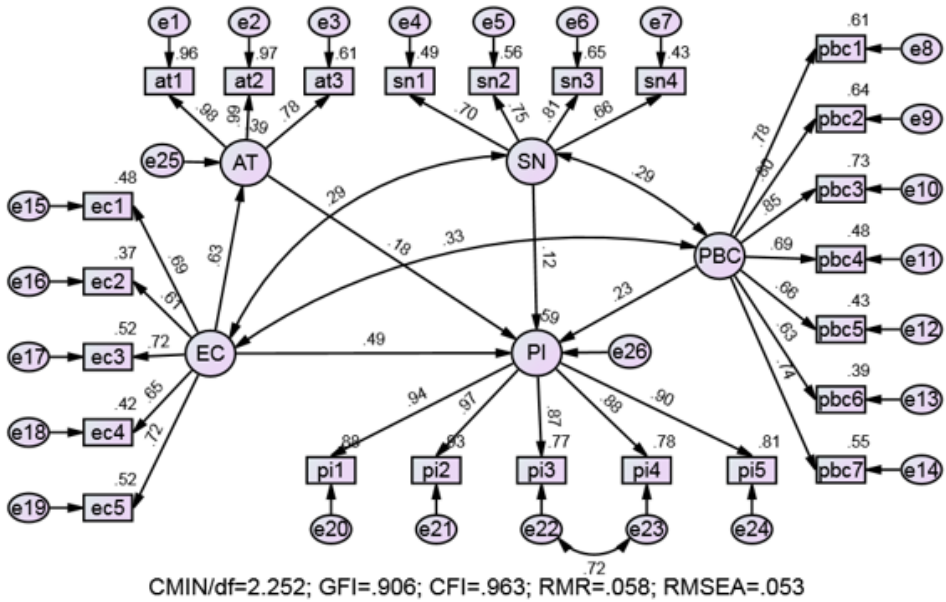

Tests of the hypothesis were conducted based on the standard regression estimates, critical ratios, and significance levels shown in Table 5. The first four hypotheses were all supported. A regression estimate of 0.182 and a critical ratio of 3.830 on the path from attitude to purchase intention are supported by a significance level 0.01 for H₁. The path from subjective norms to purchase intent has a regression estimate of 0.116 and a critical ratio of 2.846 at a significance level of 0.01, thus supporting H₂. The path from perceived behavioural control to purchase intention has a regression estimate of 0.226 and a critical ratio of 5.608 at a significance level of 0.01, thus supporting H₃. Finally, the path from environmental concern to purchase intention has a regression estimate of 0.485 and a critical ratio of 7.963 at a significance level of 0.01, thus supporting H₄. The R² value in Table 5 shows that these variables explain 58.8% of purchase intention, while the remaining 41.2% is determined by other variables not included in the model.

Table: 5
SEM Results

Paths	Std. estimates	Critical ratio	R ²
Purchase intention ← Attitude	0.182	3.830**	0.588
Purchase intention ← Subjective norms	0.116	2.846**	
Purchase intention ← Perceived behavioural control	0.226	5.608**	
Purchase intention ← Environmental concern	0.485	7.963**	

** $p < 0.01$.

Furthermore, the role of attitude in the mediating effect of environmental concern on purchase intention was examined in H₅. The mediation results in Table 6 show that both the direct impact of environmental concern on purchase intention ($p < 0.01$) and its indirect effect via attitude ($p < 0.01$) are significant. In cases where both effects are significant, a ratio of indirect effect to direct impact of more than 0.50 indicates complete mediation, while less indicates partial mediation (Hair et al., 2010; Kline, 2011). As the ratio was below 0.50 ($0.114/0.485=0.23$), it was determined that the attitude partially mediates the effect of environmental concern on purchase intention; thus, H₅ was supported.

Table: 6
Mediation Results

Path	Direct effect	Indirect effect	Total effect
EC → AT → PI	0.485**	0.114**	0.600**

** $p < 0.01$; EC=Environmental concern; AT=Attitude; PI=Purchase intention.

A multigroup analysis was conducted to examine the moderation effect of generation by estimating the standardised coefficients of the paths in the model separately for each generation. Critical ratios in the form of Z-scores were calculated to identify any significant differences between the causal parameters. A significant difference in the standardised regression weights between the two groups indicates moderation (Hair et al., 2012). As Table 7 shows, however, the Z-scores in the present study were insignificant, implying no significant difference between the groups in any path; in other words, generation does not have a moderating effect, so H₆ was rejected.

Table: 7
Moderation Results for Generation

Paths	Generation Y	Generation Z	Z-scores
PI ← AT	0.211**	208**	0.383
PI ← SN	0.109**	106**	0.330
PI ← PBC	0.186**	251**	0.476
PI ← EC	0.430**	430**	0.495

** $p < 0.05$.

An identical multigroup analysis was carried out to examine the moderating effect of culture. The results in Table 8 show a significant difference between the groups only for the impact of environmental concern on purchase intention. Specifically, environmental concern has a stronger effect on purchase intention among participants from Western countries than those from Eastern countries. This result supports H₇.

Table: 8
Moderation Results for Culture

Paths	Eastern	Western	Z-scores
PI ← AT	0.245**	0.107**	0.583
PI ← SN	0.159**	0.010**	1.498
PI ← PBC	0.282**	0.131**	1.189
PI ← EC	0.273**	0.672**	6.812**

** $p < 0.05$.

4. Discussion

There were three main objectives for this study. To begin with, it investigated the effects of antecedents of TPB on purchasing intention in the context of green consumption (namely attitude, subjective norms, and perceived behavioural control). The study's second aim was to examine the mediating role of attitude in the relationship between environmental concern and green purchase intention. As a final step, it examined the moderating effect of generation and culture on these relationships.

The predicted results regarding the effects of TPB antecedents on green purchase intention were obtained. First, the attitude had a significant positive impact on green purchase intention (H1), which shows that if consumers believe green products will cause less harm to the environment, their intention to buy green products increases. In other words, consumers with pro-environmental attitudes plan to buy green products in the future. Numerous previous studies support this finding (Han et al., 2010; Teng et al., 2015; Vazifehdoust et al., 2013; Paul et al., 2016; Yadav & Pathak, 2016; Hsu et al., 2017; Maichum et al., 2017; Trivedi et al., 2018). Second, subjective norms had a significant positive effect on green purchase intention (H2), which shows that if the people or groups taken as reference by the individual perceive that green purchasing is necessary, the individual's green purchase intention will increase. This result is also supported by many previous studies (Han et al., 2010; Hu et al., 2010; Wu & Chen, 2014; Maichum et al., 2016; Hsu et al., 2017). Third, perceived behavioural control had a significant positive effect on green purchase intention (H3), which shows that as consumers' beliefs about their green product purchasing abilities increase, their green purchase intention also increases. This result is also supported by many studies in the literature (Chan & Lau, 2002; Karatu & Mat, 2015; Hsu et al., 2017; Hasan & Suciarto, 2020; Bui et al., 2021).

Regarding the effect size of the three TPB antecedents on green purchase intention, perceived behavioural control affected green purchase intention the most, whereas subjective norms affected it the least, while attitude was in the middle. In the literature, the findings vary. Some studies conclude that the essential TPB antecedent in green purchase intention is attitude (Han et al., 2010), while others suggest subjective norms (Teng et al., 2015) or perceived behavioural control (Tsai, 2010). The findings in the present study indicate that belief in green purchase ability is the most important factor in green purchase intention. This highlights the importance of restrictive factors, such as price and lifestyle (Braumah et al., 2011), in purchasing green products.

This study also determined that environmental concern and TPB antecedents increase green purchase intention (H4). Consumers' concerns about environmental threats encourage them to be "greener" in purchasing. Many studies support this finding (Kim & Choi, 2005; Manaktola & Jauhari, 2007; Ishaswini & Datta, 2011; Dagher & Itani, 2012; Dagher et al., 2015; Junior et al., 2015; Joshi & Rahman, 2017). In addition, environmental concern had a stronger effect on green purchase intention than the TPB antecedents. That is, it was the most important variable in the research model. Yadav and Pathak (2016) also reported that environmental concern has the most critical effect on green purchase intention among other predictors, namely attitude, subjective norms, behavioural control, environmental respect, and environmental knowledge.

Regarding mediation effects, it was determined that attitude partially mediated the relationship between environmental concern and green purchase intention (H5). In other words, environmental concerns strengthen consumers' attitudes that green products will cause less harm to the environment, and this attitude increases consumers' green purchase intention. This finding confirms the attitude-mediated concern-intention relationship reported by previous researchers (Vazifehdoust et al., 2013; Maichum et al., 2016; Mamun et al., 2018).

Regarding moderating effects, there was no significant difference between the Y and Z generations regarding the impact of environmental concern and TPB antecedents on green purchase intention (H6). On the other hand, western culture increased the effect of environmental concern on green purchase intention (H7). In other words, the impact of environmental concern on green purchase intention is significantly higher in European consumers than in Asian consumers. Thus, while the results did not support the predictions about the moderating effects of generation (Lower, 2008; Dagher et al., 2015), they partially supported predictions about culture (Kotler, 2011; Sreen et al., 2018). These mediating and moderating findings can contribute to the literature, which has limited studies.

5. Conclusion

Environmental problems in recent years have increased individuals' concerns and led to a green consumption trend. In addition to environmental concerns, TPB has been frequently used in predicting consumers' green purchasing behaviour. The study results showed that attitude, subjective norms, perceived behavioural control, and environmental concern increase green purchase intention. Environmental concern is the most decisive factor affecting green purchase intention, while attitude mediates this relationship. The strongest TPB antecedent affecting green purchase intention was perceived behavioural control. The results highlight the importance of developing environmental awareness and price regulation for producing and consuming green products to leave a more liveable world in the future.

5.1. Practical Implications

Environmental concern emerged in this study as the most important variable for increasing green purchase intention. Therefore, it is recommended that governments and businesses organise environmental activities and education, especially in schools and workplaces, to create environmental awareness. Increasing environmental awareness in these ways could make environmental concerns and shape people's perceptions of green consumption.

Among the TPB antecedents, perceived behavioural control was the strongest predictor of green purchase intention. However, relatively high prices of green products may weaken consumers' belief in their ability to engage in green purchasing behaviour. Governments could repair this intention-behaviour bridge by reducing costs through practices like financial incentives and tax reductions for green producers and consumers.

Consumers with environmental concerns are more inclined towards green consumption. Therefore, in addition to protecting the environment, businesses must develop strategies (such as green marketing mix strategies) to address consumers' environmental concerns. Businesses that adopt green production processes can earn opportunities to enter new markets, ensure the sustainability of profits, and gain a competitive advantage over businesses that do not have environmental concerns.

5.2. Limitations and Further Research

This study was limited to examining the determinants of green purchase intention. Therefore, the effect of green purchase intention on green purchasing behaviour was not investigated. However, green purchasing intention may not always translate into green purchasing behaviour, mainly due to price. Thus, future studies could usefully examine the intention-behaviour relationship in the context of green consumption.

Other limitations include the study's cross-sectional and self-report-based collection of data and the study sample formed by university students. Conducting a similar but longitudinal study with different samples and using more objective measurements is recommended. In addition, the moderator variable culture was classified as Asian and European countries for this study. However, future studies could rank countries differently in terms of culture.

The findings showed that environmental concern has the most significant effect on green purchase intention. Further research can focus on how this environmental concern is shaped, for example, by examining the effects of reference groups (family, friends, relatives, etc.) and other non-personal factors (media channels, etc.).

References

- Ajzen, I. (1991), "The Theory of Planned Behavior", *Organizational Behavior and Human Decision Processes*, 50(2), 179-211.

- Akehurst, G. et al. (2012), "Re-Examining Green Purchase Behaviour and the Green Consumer Profile: New Evidences", *Management Decision*, 50(5), 972-988.
- Aktas, S.C. & B. Cicek (2019), "Examination of the Sustainable Consumption Behaviours of Women and Men from Different Generations", *Third Sector Social Economic Review*, 54(4), 1957-1978.
- Aseri, M. & Z.A. Ansari (2023), "Purchase Behaviour of Green Footwear in Saudi Arabia Using Theory of Planned Behaviour", *Sustainability*, 15(6), 5045.
- Bartels, J. & M.C. Onwezen (2014), "Consumers' Willingness to Buy Products with Environmental and Ethical Claims: The Roles of Social Representations and Social Identity", *International Journal of Consumer Studies*, 38(1), 82-89.
- Braimah, M. et al. (2011), "An Exploratory Study of the Impact of Green Brand Awareness on Consumer Purchase Decisions in Ghana", *Journal of Marketing Development and Competitiveness*, 5(7), 11-18.
- Bui, T.Q. et al. (2021), "Antecedents Affecting Purchase Intention of Green Skincare Products: A Case Study in Vietnam", *The Journal of Asian Finance, Economics and Business*, 8(3), 1295-1302.
- Cangur, S. & I. Ercan (2015), "Comparison of Model Fit Indices Used in Structural Equation Modeling under Multivariate Normality", *Journal of Modern Applied Statistical Methods*, 14(1), 152-167.
- Canoz, F. (2022), "Tourists' Attitudes toward Green Product Buying Behaviors: The Role of Demographic Variables", *Tourism & Management Studies*, 18(4), 7-16.
- Chan, R.Y. & L.B. Lau (2002), "Explaining Green Purchasing Behavior: A Cross-Cultural Study on American and Chinese Consumers", *Journal of International Consumer Marketing*, 14(2-3), 9-40.
- Chang, S.J. et al. (2010), "From the Editors: Common Method Variance in International Business Research", *Journal of International Business Studies*, 41(2), 178-184.
- Chekima, B. et al. (2016), "Examining Green Consumerism Motivational Drivers: Does Premium Price and Demographics Matter to Green Purchasing?", *Journal of Cleaner Production*, 112, 3436-3450.
- Dagher, G.K. & O. Itani (2012), "The Influence of Environmental Attitude, Environmental Concern and Social Influence on Green Purchasing Behavior", *Review of Business Research*, 12(2), 104-111.
- Dagher, G.K. et al. (2015), "The Impact of Environment Concern and Attitude on Green Purchasing Behavior: Gender as the Moderator", *Contemporary Management Research*, 11(2), 179-206.
- do Paço, A.M.F. et al. (2009), "Identifying the Green Consumer: A Segmentation Study", *Journal of Targeting, Measurement and Analysis for Marketing*, 17(1), 17-25.
- Fornell, C. & D.F. Larcker (1981), "Evaluating Structural Equation Models with Unobservable Variables and Measurement Error", *Journal of Marketing Research*, 18(1), 39-50.
- Hair, J.F. et al. (2010), *Multivariate Data Analysis: A Global Perspective*, NJ: Pearson Education Inc.

- Hair, J.F. et al. (2012), "An Assessment of the Use of Partial Least Squares Structural Equation Modeling in Marketing Research", *Journal of the Academy of Marketing Science*, 40(3), 414-433.
- Han, H. et al. (2010), "Application of the Theory of Planned Behavior to Green Hotel Choice: Testing the Effect of Environmental Friendly Activities", *Tourism Management*, 31(3), 325-334.
- Harman, H.H. (1960), *Modern Factor Analysis*, Chicago, IL: The University of Chicago Press.
- Hasan, H.N. & S. Suciarto (2020), "The Influence of Attitude, Subjective Norm and Perceived Behavioral Control towards Organic Food Purchase Intention", *Journal of Management and Business Environment*, 1(2), 132-153.
- Hsu, C.L. et al. (2017), "Exploring Purchase Intention of Green Skincare Products Using the Theory of Planned Behavior: Testing the Moderating Effects of Country of Origin and Price Sensitivity", *Journal of Retailing and Consumer Services*, 34, 145-152.
- Hu, H.H. et al. (2010), "The Dynamics of Green Restaurant Patronage", *Cornell Hospitality Quarterly*, 51(3), 344-362.
- Ishaswini, N. & S.K. Datta (2011), "Pro-Environmental Concern Influencing Green Buying: A Study on Indian Consumers", *International Journal of Business and Management*, 6(6), 124-133.
- Jaiswal, D. & R. Kant (2018), "Green Purchasing Behaviour: A Conceptual Framework and Empirical Investigation of Indian Consumers", *Journal of Retailing and Consumer Services*, 41, 60-69.
- Joshi, Y. & Z. Rahman (2015), "Factors Affecting Green Purchase Behaviour and Future Research Directions", *International Strategic Management Review*, 3(1-2), 128-143.
- Joshi, Y. & Z. Rahman (2017), "Investigating the Determinants of Consumers' Sustainable Purchase Behaviour", *Sustainable Production and Consumption*, 10, 110-120.
- Junior, S.S.B. et al. (2015), "The Effects of Environmental Concern on Purchase of Green Products in Retail", *Procedia-Social and Behavioral Sciences*, 170, 99-108.
- Karatu, V.M.H. & N.K.N. Mat (2015), "The Mediating Effects of Green Trust and Perceived Behavioral Control on the Direct Determinants of Intention to Purchase Green Products in Nigeria", *Mediterranean Journal of Social Sciences*, 6(4), 256-265.
- Kaufmann, H.R. et al. (2012), "Factors Affecting Consumers' Green Purchasing Behavior: An Integrated Conceptual Framework", *Amfiteatru Economic Journal*, 14(31), 50-69.
- Kim, Y. & S.M. Choi (2005), "Antecedents of Green Purchase Behavior: An Examination of Collectivism, Environmental Concern, and PCE", *Advances in Consumer Research*, 32, 592-599.
- Kline, R.B. (2011), *Principles and Practice of Structural Equation Modeling* (3rd ed.), New York: The Guilford Press.
- Kotler, P. (2011), "Reinventing Marketing to Manage the Environmental Imperative", *Journal of Marketing*, 75(4), 132-135.
- Leary, R.B. et al. (2014), "Changing the Marketplace One Behavior at a Time: Perceived Marketplace Influence and Sustainable Consumption", *Journal of Business Research*, 67(9), 1953-1958.
- Lower, J. (2008), "Brace Yourself. Here Comes Generation Y", *Critical Care Nurse*, 28(5), 80-85.

- Maichum, K. et al. (2016), "Application of the Extended Theory of Planned Behavior Model to Investigate Purchase Intention of Green Products Among Thai Consumers", *Sustainability*, 8(10), 1-20.
- Maichum, K. et al. (2017), "The Influence of Environmental Concern and Environmental Attitude on Purchase Intention towards Green Products: A Case Study of Young Consumers in Thailand", *International Journal of Business Marketing and Management*, 2(3), 1-8.
- Malhotra, N.K. et al. (2006), "Common Method Variance in IS Research: A Comparison of Alternative Approaches and a Reanalysis of Past Research", *Management Science*, 52(12), 1865-1883.
- Malhotra, N.K. et al. (2010), *Marketing Research: An Applied Orientation* (6th ed.), England: Pearson Education Limited.
- Mamun, A. et al. (2018), "Intention and Behavior towards Green Consumption among Low-Income Households", *Journal of Environmental Management*, 227, 73-86.
- Manaktola, K. & V. Jauhari (2007), "Exploring Consumer Attitude and Behaviour towards Green Practices in the Lodging Industry in India", *International Journal of Contemporary Hospitality Management*, 19(5), 364-377.
- Moslehpour, M. et al. (2023), "Predictors of Green Purchase Intention toward Eco-Innovation and Green Products: Evidence from Taiwan", *Economic Research*, 36(2), 2121934.
- Nastu, P. (2008), *Older Demographics Biggest Users of Green Products*, <<https://www.environmentalleader.com/2008/09/older-demographics-biggest-users-of-green-products>>, 31.08.2022.
- Nova-Reyes, A. et al. (2020), "The Tipping Point in the Status of Socially Responsible Consumer Behavior Research? A Bibliometric Analysis", *Sustainability*, 12(8), 3141.
- Patwary, A.K. et al. (2022), "Green Purchasing Behaviour of International Tourists in Malaysia Using Green Marketing Tools: Theory of Planned Behaviour Perspective", *Nankai Business Review International*, 13(2), 246-265.
- Paul, J. et al. (2016), "Predicting Green Product Consumption Using Theory of Planned Behavior and Reasoned Action", *Journal of Retailing and Consumer Services*, 29, 123-134.
- Podsakoff, P.M. et al. (2003), "Common Method Biases in Behavioral Research: A Critical Review of the Literature and Recommended Remedies", *Journal of Applied Psychology*, 88(5), 879-903.
- Ritter, Á.M. et al. (2015), "Motivations for Promoting the Consumption of Green Products in an Emerging Country: Exploring Attitudes of Brazilian Consumers", *Journal of Cleaner Production*, 106, 507-520.
- Samarasinghe, G.D. et al. (2013), "Green Decisions: Consumers' Environmental Beliefs and Green Purchasing Behaviour in Sri Lankan Context", *International Journal of Innovation and Sustainable Development*, 7(2), 172-184.
- Shao, J. & E. Ünal (2019), "What Do Consumers Value More in Green Purchasing? Assessing the Sustainability Practices from Demand Side of Business", *Journal of Cleaner Production*, 209, 1473-1483.
- Sreen, N. et al. (2018), "Impact of Culture, Behavior and Gender on Green Purchase Intention", *Journal of Retailing and Consumer Services*, 41, 177-189.

- Stern, P.C. (2005), "Understanding Individuals' Environmentally Significant Behavior", *ELR News & Analysis*, 35, 10785-10790.
- Tang, Y. et al. (2014), "Chinese Consumer Attitude and Purchase Intent towards Green Products", *Asia-Pacific Journal of Business Administration*, 6(2), 84-96.
- Teng, Y.M. et al. (2015), "Integrating Altruism and the Theory of Planned Behavior to Predict Patronage Intention of a Green Hotel", *Journal of Hospitality & Tourism Research*, 39(3), 299-315.
- Trivedi, R.H. et al. (2018), "Causality Analysis of Media Influence on Environmental Attitude, Intention and Behaviors Leading to Green Purchasing", *Journal of Cleaner Production*, 196, 11-22.
- Tsai, C.Y. (2010), "Applying the Theory of Planned Behavior to Explore the Independent Travelers' Behavior", *African Journal of Business Management*, 4(2), 221-234.
- Vazifehdoust, H. et al. (2013), "Purchasing Green to Become Greener: Factors Influence Consumers' Green Purchasing Behavior", *Management Science Letters*, 3(9), 2489-2500.
- Wu, S.I. & J.Y. Chen (2014), "A Model of Green Consumption Behavior Constructed by the Theory of Planned Behavior", *International Journal of Marketing Studies*, 6(5), 119-132.
- Yadav, R. & G.S. Pathak (2016), "Young Consumers' Intention towards Buying Green Products in A Developing Nation: Extending the Theory of Planned Behavior", *Journal of Cleaner Production*, 135, 732-739.
- Zeynalova, Z. & N. Namazova (2022), "Revealing Consumer Behavior toward Green Consumption", *Sustainability*, 14(10), 5806.

Appendix

Demographic Information Form	
Please indicate your country of citizenship	
Gender	<input type="checkbox"/> Female <input type="checkbox"/> Male
Date of birth	<input type="checkbox"/> Before 1943 <input type="checkbox"/> 1981-1999 <input type="checkbox"/> 1944-1964 <input type="checkbox"/> After 2000 <input type="checkbox"/> 1965-1980
Marital status	<input type="checkbox"/> Single <input type="checkbox"/> Married
Education	<input type="checkbox"/> Senior high school <input type="checkbox"/> College/university <input type="checkbox"/> Master's degree or Ph.D.
What level do you think your monthly income is?	<input type="checkbox"/> Low <input type="checkbox"/> Moderate <input type="checkbox"/> High

Questionnaire Form		1=Strongly disagree	2=Disagree	3=Neither agree nor disagree	4=Agree	5=Strongly agree
Attitude towards purchasing green products						
1.	I like the idea of purchasing green.	1	2	3	4	5
2.	Purchasing green is a good idea.	1	2	3	4	5
3.	I have a favourable attitude toward purchasing a green version of a product.	1	2	3	4	5
Subjective norm						
1.	Most people who are important to me think I should purchase green products when purchasing.	1	2	3	4	5
2.	Most people who are important to me would want me to purchase green products when purchasing.	1	2	3	4	5
3.	People whose opinions I value would prefer that I purchase green products.	1	2	3	4	5
4.	My friend's positive opinion influences me to purchase green products.	1	2	3	4	5
Perceived behavioural control						
1.	I believe I have the ability to purchase green products	1	2	3	4	5
2.	I am confident I would purchase green products if it were entirely up to me.	1	2	3	4	5
3.	I see myself as capable of purchasing green products in future.	1	2	3	4	5
4.	I have the resources, time and willingness to purchase green products.	1	2	3	4	5
5.	Green products are generally available in the shops where I usually do my shopping.	1	2	3	4	5
6.	There are likely to be plenty of opportunities for me to purchase green products.	1	2	3	4	5
7.	I feel that purchasing green products is not totally within my control.	1	2	3	4	5
Environmental concern						
1.	I am very concerned about the environment	1	2	3	4	5
2.	I would be willing to reduce my consumption to help protect the environment.	1	2	3	4	5
3.	Major political change is necessary to protect the natural environment.	1	2	3	4	5
4.	Major social changes are necessary to protect the natural environment.	1	2	3	4	5
5.	Anti-pollution laws should be enforced more strongly.	1	2	3	4	5
Purchase intention for green products						
1.	I will consider buying products because they are less polluting in the coming times.	1	2	3	4	5
2.	I will consider switching to environmentally friendly brands for ecological reasons.	1	2	3	4	5
3.	I plan to spend more on environmentally friendly products than conventional ones.	1	2	3	4	5
4.	I expect to purchase the product in the future because of its positive environmental contribution.	1	2	3	4	5
5.	I definitely want to purchase green products in the near future.	1	2	3	4	5

Understanding the Psychological and Financial Correlates for Consumer Credit Use¹

Tuna ÇAKAR (<https://orcid.org/0000-0001-8594-7399>), MEF University, Türkiye; cakart@mef.edu.tr
Türkay ŞAHİN (<https://orcid.org/0000-0002-7722-7233>), MEF University, Türkiye; sahintur@mef.edu.tr
Seyit ERTUĞRUL (<https://orcid.org/0000-0003-0828-7336>), MEF University, Türkiye; ertugruls@mef.edu.tr
Alperen SAYAR (<https://orcid.org/0000-0001-6089-2547>), MEF University, Türkiye; AlperenSayar@tamfinans.com.tr

Tüketici Kredisi Kullanımının Altında Yatan Psikolojik ve Finansal Değişkenleri Anlamak²

Abstract

This study investigated the behavioural and cognitive predictors of consumer credit usage to develop a behavioural credit risk assessment procedure for a factoring company. Participants completed surveys measuring personality traits, self-esteem, material and monetary values, compulsive and impulsive buying tendencies, self-control, and impulsiveness. Financial surveys also assessed financial literacy and knowledge of financial concepts. The results indicated that extraversion, conscientiousness, emotional stability, and experiential self-control were significant predictors of consumer credit usage. These findings suggest that a finance company can use these personality traits and financial characteristics to develop a more accurate and effective credit risk assessment procedure, such as psychometric tests.

Keywords : Consumer Credit, Behavioural Economics, Financial Literacy, Consumer Behaviour, Factoring.

JEL Classification Codes : D12, D91, G41.

Öz

Bu çalışma, tüketici kredisi kullanımını etkileyen davranışsal ve bilişsel faktörleri araştıran ilk çalışmalardan biridir. Araştırmanın sonuçları, bir faktöring şirketi için daha doğru ve etkili bir kredi risk değerlendirme prosedürü geliştirmek için kullanılacak önemli bilgiler sağlamaktadır. Bu tür bir prosedür, finansal kurumların risklerini azaltmasına ve tüketicilerin finansal refahını artırmasına yardımcı olabilir. Çalışmanın sonuçları ayrıca, tüketici kredisi kullanımını etkileyen faktörler hakkında daha fazla anlayış sağlamaktadır. Bu bilgiler, tüketicilerin daha sorumlu kredi kullanımı yapmalarına yardımcı olacak müdahalelerin geliştirilmesinde kullanılabilir. Sonuç olarak, bu çalışma, tüketici

¹ We appreciate all our participants who participated in these surveys voluntarily. Moreover, we would like to thank the general manager of this factoring company, Hakan Karamanlı, for the idea and his effort in the different stages of this project. The updated version of ethics approval was obtained from the MEF University Ethics Committee (Decision Number: E-47749665-050.01.04-893).

² Bu anketlere gönüllü olarak katılan tüm katılımcılara müteşekkirimiz. Ayrıca, bu proje fikri ve farklı aşamalardaki çabaları için TAM Finans Faktöring A.Ş.'nin Genel Müdürü Hakan Karamanlı'ya teşekkürlerimizi sunarız. Anket uygulaması için MEF Üniversitesi Etik Kurulu'ndan güncellenmiş etik onayı alınmıştır (Karar Numarası: E-47749665-050.01.04-893).

kredisi kullanımı konusunda önemli bir katkı sağlamaktadır. Araştırmanın sonuçları hem finans kurumları hem de tüketiciler için faydalı olabilir.

Anahtar Sözcükler : Tüketici Kredisi, Finansal Okuryazarlık, Tüketici Davranışı, Faktoring.

1. Introduction

Consumer credit usage is a ubiquitous phenomenon in modern societies. It enables individuals to access goods and services immediately without paying the total price upfront. While consumer credit can be helpful in financing purchases, it can also lead to financial hardship if not used responsibly. For example, over 40% of adults in the United States have outstanding consumer debt, totalling over \$16 trillion. Therefore, understanding the factors influencing consumer credit usage is essential for developing effective interventions to promote financial well-being. A growing body of research suggests that behavioural and cognitive patterns play a significant role in consumer credit usage. For example, individuals who are more impulsive or materialistic are more likely to use consumer credit, even after controlling for other factors such as income and education. This study aims to contribute to the literature on consumer credit usage by investigating the relationship between consumer credit usage and a range of behavioural and cognitive features, including compulsive and impulsive buying, personality traits, self-esteem, materialism, self-control, impulsivity, money attitudes, and financial literacy.

2. Behavioural and Cognitive Predictors of Consumer Credit Usage

The implications of behavioural and cognitive patterns on the financial decision-making processes have drawn significant attention due to their capability to predict future financial behaviours. Research by Kahneman and Tversky (1979) had important implications on economic models based on human rationality and an immediate need for theoretical backgrounds explaining how humans make financial decisions afterwards. Since then, behavioural and cognitive sciences have started to fill this gap and provide insights into consumer behaviours. Specifically, we wanted to contribute to the literature from the point of consumer credit usage: Which behavioural and cognitive features contribute to the use of consumer credits?

Consumer credit enables individuals to take on debt with delayed repayment; thus, individuals do not have to pay in cash for goods during purchasing transactions immediately (Braswell & Chernow, n.d.). Brown and Taylor (2014) have researched to investigate the relationship between personality traits and specific aspects of economic decision-making processes using data from the British Household Panel Survey focusing on single individuals and couples separately. Among all participants, the conscientiousness trait had a negative relationship with the amount of unsecured debt, whereas the other personality traits had a positive relationship. The extraversion trait had the highest positive relationship with the amount of unsecured debt among single individuals, whereas the agreeableness trait

exhibited the same pattern among couples, in contrast with other personality traits included in the Big Five personality taxonomy. On the other hand, individuals differed in terms of what kind of debt to hold based on their personality. Among all participants, openness to new experiences had the highest positive relationship with having credit card debt, while conscientiousness trait had a negative relationship with having credit card debt and overdrafts, as in line with previous findings. Neuroticism and extraversion were positively related to debts such as overdrafts among single individuals, which were considered a comparatively simple way to get credit. Additionally, neuroticism was the only personality trait positively related to having hire purchase agreements among couples.

According to Rosenberg (1965), self-esteem is how individuals evaluate themselves in certain aspects, whether they have a positive or negative opinion about the self and the amount of worthiness the individual attributes to it. Individuals differ in spending habits depending upon their level of self-esteem; Individuals with comparably lower self-esteem were prone to have credit card debt originating from too much and unaccountable usage of credit cards (Omar et al., 2014). Individuals may associate self-worth and wealth; thus, attempts to increase self-worth may result in spending patterns characterised by buying luxury goods (Pettit & Sivanathan, 2011), which might be a plausible explanation for the tendency of low self-esteem individuals to overuse their credit cards.

3. Impulsivity, Materialism, and Self-Control as Predictors of Consumer Credit Usage

Impulsivity is a personality trait characterised by a tendency to act quickly without considering the consequences (Moeller et al., 2001). It has been linked to several adverse outcomes, including risky financial behaviours such as excessive gambling and credit use. Research has shown that impulsive individuals are more likely to use consumer credit than mortgage credit (Ottaviani & Vandone, 2011) and are more likely to be in debt, even after controlling for socioeconomic factors (Ottaviani & Vandone, 2017). This is likely because impulsive individuals tend to discount future rewards and focus on immediate gratification (Wittmann & Paulus, 2008). As a result, they may be more likely to use credit to purchase goods and services without fully considering the long-term financial implications.

Materialism is another personality trait that has been linked to consumer credit usage. Materialistic individuals value material possessions highly and believe acquiring material goods will lead to happiness and success (Richins & Dawson, 1992). Materialistic individuals are more likely to have multiple credit cards and to use them to purchase luxury goods (Watson, 2003). This is likely because materialistic individuals are more likely to be influenced by social media and other forms of advertising that promote materialism. Additionally, materialistic individuals may be more likely to use credit to purchase goods and services they cannot afford to maintain a certain social status.

Self-control is the ability to resist temptation and delay gratification. It is a critical factor in financial well-being. Individuals with low self-control are more likely to use high-

cost credit and experience financial shocks (Gathergood, 2012). They are also more likely to have a lower household net worth (Biljanovska & Palligkinis, 2018). Individuals with high self-control, on the other hand, tend to have better financial management behaviours and less financial anxiety (Strömbäck et al., 2017). This is likely because individuals with high self-control are better able to resist the temptation to spend money impulsively and are more likely to make sound financial decisions.

4. Money Attitudes, Compulsive Buying, and Financial Literacy as Predictors of Consumer Credit Usage

The Money Attitudes Scale (MAS), developed by Yamauchi and Templer (1982), is widely used to measure individuals' attitudes towards money. The MAS has four dimensions:

- **Power-prestige:** The belief that money is a sign of achievement and success and a tool to impress others.
- **Time-retention:** The belief that saving money for the future is important.
- **Security:** The belief that money is important for financial security and peace of mind.
- **Freedom:** The belief that money provides financial freedom and independence.

Research has shown that money attitudes can significantly predict consumer credit usage. For example, individuals high on the power-prestige dimension are more likely to misuse their credit cards, engage in compulsive buying practices, and use revolving credits (Palan et al., 2011; Wang et al., 2011). This is likely because individuals with high power-prestige attitudes are more motivated to acquire material possessions and impress others, even if it means incurring debt. On the contrary, individuals high on the time-retention dimension are less likely to use revolving credits (Wang et al., 2011). This is likely because individuals with high time-retention attitudes focus more on saving money for the future and are less likely to be impulsive spenders.

Compulsive buying is a behavioural disorder characterised by excessive and uncontrollable spending. Compulsive buyers often experience negative emotional consequences due to their spending, such as guilt, shame, and financial hardship. Research has shown that compulsive buying is associated with several factors, including impulsivity, low self-control, and financial literacy. For example, Achtziger et al. (2015) found that compulsive buyers with low self-control tend to have more debt than compulsive buyers with high self-control. However, this relationship was not observed among individuals who were not compulsive buyers.

Impulsive buying is a related construct that refers to the tendency to make spontaneous and unplanned purchases. Impulsive buying has also been linked to consumer credit usage. For example, Wang and Xiao (2009) found that impulsive buying scores were

significantly higher among debtors than among non-debtors. However, in a further analysis, this relationship did not reach significance.

Financial literacy is the knowledge and skills necessary to make sound financial decisions. Research has shown that financial literacy has important implications for consumer credit usage. For example, Disney and Gathergood (2011) found that low financial literacy is associated with lower household net worth, higher consumer credit usage compared to revenue, and use of higher-cost credits.

Building on the existing literature on behavioural and financial characteristics about specific financial outcomes, this study aimed to investigate whether compulsive and impulsive buying, personality traits, self-esteem, material values, self-control, impulsiveness, and money attitudes could predict participants' self-reported consumer credit usage, beyond the known relationship between financial literacy and consumer credit usage.

H₁: Compulsive and impulsive buying is positively associated with consumer credit usage.

H₂: Personality traits, such as extraversion, agreeableness, neuroticism, and openness to experience, are positively associated with consumer credit usage, while conscientiousness is negatively associated with consumer credit usage.

H₃: Self-esteem is positively associated with consumer credit usage.

H₄: Materialism is positively associated with consumer credit usage.

H₅: All aspects of self-control are negatively associated with consumer credit usage.

H₆: Impulsivity is positively associated with consumer credit usage.

H₇: Power-prestige attitudes are positively associated with consumer credit usage, while time-retention attitudes are negatively associated with consumer credit usage.

H₈: Financial literacy is negatively associated with consumer credit usage.

5. Methodology

5.1. Participants

This study recruited participants who were 18 years of age or older, as this is the minimum age for consumer credit usage in Turkey. A total of 424 participants began the surveys, but 184 did not complete the psychological surveys, and two were under 18 years of age, so they were excluded from the dataset. This resulted in a final sample size of 238 participants (108 females, 113 males, two individuals who did not specify, and the rest missing data). The mean age of participants was 37.04 years (SD = 11.13, range = 19-59 years). 30% of participants were 40 years of age or older. There were 125 (52.5%) married

and 98 (41.2%) single participants in the dataset. Of the participants, two had no educational background (0.8%), 26 had a high school degree (10.9%), 157 had a college degree (66.0%), 36 had a master's degree (15.1%), and two had a PhD degree (0.8%). The average number of working years was 14.67 (SD = 10.73), ranging from 0-44 years. At the time of the experiment, 124 (52.1%) participants were actively paying off their credits, while 98 (41.2%) were not. Seventy (29.4%) participants reported having a focused credit repayment style (paying off only one credit per month), while 52 (21.8%) participants reported having a dispersed manner.

5.2. Materials

5.2.1. Big Five Personality Traits

The Big Five Personality Traits (BFP) is a widely used personality inventory that measures five core traits: openness to experience, conscientiousness, extraversion, agreeableness, and neuroticism. The BFP was developed by Goldberg (1992) and consists of 50 items, ten items per subscale. Items are scored on a 5-point Likert scale (1 = Very inaccurate, 5 = Very accurate). The Turkish version of the BFP was translated and validated by Tatar (2017). The Cronbach's alpha values for all subscales except openness to experience were adequate ($\alpha \geq 0.70$).

5.2.2. Buying Impulsiveness Scale

The Buying Impulsiveness Scale (BIS) is a unidimensional scale that measures the tendency to make impulsive purchases. The BIS was developed by Rook and Fisher (1995) and consists of 9 items. Items are scored on a 5-point Likert scale (1 = Strongly disagree, 5 = Strongly agree). Okutan et al. (2013) translated and validated the Turkish version of the BIS. The Cronbach's alpha value for the Turkish BIS was adequate ($\alpha = 0.86$).

5.2.3. Compulsive Buying Scale

The Compulsive Buying Scale (CBS) is a unidimensional scale that measures the tendency to engage in compulsive buying behaviour. The CBS was developed by Faber and O'Guinn (1992) and consists of 7 items. Items are scored on a 5-point Likert scale (1 = Never, 5 = Very often). Okutan et al. (2013) translated and validated the Turkish version of the CBS. The Cronbach's alpha value for the Turkish CBS was adequate ($\alpha = 0.83$).

5.2.4. Self-Control Schedule

The Self-Control Schedule (SCS) is a 36-item scale that measures three aspects of self-control: redressive self-control, reformative self-control, and experiential self-control. The SCS was developed by Rosenbaum (1980). Items are scored on a 6-point Likert scale (-3 = Very uncharacteristic of me, extremely nondescriptive, +3 = Very characteristic of me, extremely descriptive). The Turkish version of the SCS was translated and validated by

Duyan et al. (2012). The Cronbach's alpha values for all three subscales were adequate ($\alpha \geq 0.70$).

5.2.5. Barratt Impulsiveness Scale (BIS-11)

Patton et al. (1995) developed the Barratt Impulsiveness Scale-11 (BIS-11), a 30-item scale that measures impulsiveness on six dimensions: attention, motor, self-control, cognitive complexity, perseverance, and cognitive instability. Items are scored on a 4-point Likert scale (1 = Rarely/Never, 4 = Almost Always/Always). Güleç et al. (2008) translated the BIS-11 into Turkish, and the overall Cronbach's alpha value was adequate ($\alpha \geq 0.70$). However, Cronbach's alpha values for all subscales except the first second-order factor were inadequate.

5.2.6. Money Attitude Scale (MAS)

Yamauchi and Templer (1982) developed the MAS, a 29-item scale that measures individuals' attitudes towards money. The MAS has four dimensions: power prestige, distrust, anxiety, and time-retention. Items are scored on a 5-point Likert scale (1 = Strongly disagree, 5 = Strongly agree). Süer et al. (2017) translated the MAS into Turkish.

5.2.7. Rosenberg Self-Esteem Scale (RSE)

Rosenberg (1965) developed the RSE, a 10-item scale that measures global self-esteem. Items are scored on a 4-point Likert scale (1 = Strongly disagree, 4 = Strongly agree). Çuhadaroğlu (1986, as cited in Özgüngör & Paksu, 2017) adapted the RSE into Turkish.

5.2.8. Material Values Scale (MVS)

Richins and Dawson (1992) developed the MVS, an 18-item scale that measures materialism. The MVS has three dimensions: success, centrality, and happiness. Items are scored on a 5-point Likert scale (1 = Strongly disagree, 5 = Strongly agree). Ünal et al. (2013) translated the MVS into Turkish and found that the scale had two factors. The overall Cronbach's alpha value for the Turkish MVS was adequate ($\alpha \geq 0.70$).

6. Procedure

Data was collected using Qualtrics XM (<https://www.qualtrics.com/>), a popular online survey platform. Snowball sampling techniques were used to reach a wider pool of participants. Additionally, Tam Factoring employees were informed of the study through text messages to increase participation.

Participants first read the informed consent form, and those who agreed to participate proceeded to answer a series of questions. 11 surveys, including 218 questions with demographic variables, were presented to the participants. Forced answer options were used for all questions, meaning that participants had to answer each question before proceeding

to the next. This was done to ensure a complete data set, as participants in online experiments may arbitrarily choose not to answer questions, affecting the data quality.

Statistical analyses were conducted using IBM SPSS (Statistical Package for the Social Sciences) version 24.

Participants completed the following scales:

- Big Five Personality Traits (BFP; Goldberg, 1992)
- Material Values Scale (MVS; Richins & Dawson, 1992)
- Impulsive Buying Scale (IBS; Rook & Fisher, 1995)
- Compulsive Buying Scale (CBS; Faber & O'Guinn, 1992)
- Rosenberg Self-Esteem Scale (RSE; Rosenberg, 1965)
- Self-Control Schedule (SCS; Rosenbaum, 1980)
- Barratt Impulsiveness Scale-11 (BIS-11; Patton et al., 1995)
- Money Attitudes Scale (MAS; Yamauchi & Templer, 1982)
- Financial Literacy Scale (FLS; Van Rooij et al., 2012)
- Certain items from the Financial Literacy Diagnostic Survey conducted in Russia (World Bank, 2013)
- A series of questions was developed by Güler and Tunahan (2017) to assess some of the participants' financial characteristics.

Participants were also asked to indicate whether they had a focused or dispersed payment style for credit-related payments. Additionally, demographic information such as age, marital status, sex, educational background, and number of active working years was collected. The dependent variable, "Have you ever used a consumer loan?" was answered with a yes or no response.

7. Results

7.1. Internal Consistency Analyses

Cronbach's alpha was used to assess the internal consistency of the scales. The Big Five Personality Traits scale showed good overall internal consistency, except for the Openness to New Experiences subscale ($\alpha = .865$ for Extraversion, $\alpha = .876$ for Emotional Stability, $\alpha = .851$ for Conscientiousness, $\alpha = .724$ for Agreeableness, and $\alpha = .633$ for Openness to New Experiences). In the Turkish adaptation of the Material Values Scale, two factors were extracted differently than in the original version, and one of the factors did not reach adequate levels; therefore, scores were calculated overall. The Material Values Scale, Impulsive Buying Scale, Compulsive Buying Scale, and Rosenberg Self-Esteem Scale all showed high internal consistencies ($\alpha = .869$, $\alpha = .851$, $\alpha = .846$, and $\alpha = .882$, respectively). The Self-Control Schedule includes Redressive Self-Control, Reformative Self-Control, and Experiential Self-Control, and all the subscales showed adequate internal consistency levels ($\alpha = .809$, $\alpha = .839$, $\alpha = .755$, respectively). In the Turkish adaptation study of the Barratt

Impulsiveness Scale-11, Cronbach's alpha values of the subscales did not reach adequate levels, but the overall internal consistency was high ($\alpha = .838$). Finally, the Money Attitudes Scale showed adequate levels of internal consistency ($\alpha = .881$ for Power-Prestige, $\alpha = .919$ for Time-Retention, $\alpha = .703$ for Anxiety, and $\alpha = .782$ for Distrust). The mean values and standard deviations for the psychological scales are presented in Table 1.

Table: 1
Means and Standard Deviations for Psychological Scales

	Mean	Standard Deviation
Impulsive Buying	3.75	.73
Compulsive Buying	4.43	.60
Self-Esteem	1.65	.52
Power-Prestige ^a	4.16	.72
Time-Retention ^a	2.14	.83
Distrust ^a	3.45	.73
Anxiety ^a	3.55	.73
Impulsivity ^b	3.15	.33
Extraversion ^c	2.43	.72
Agreeableness ^c	1.87	.47
Conscientiousness ^c	1.77	.62
Emotional Stability ^c	2.65	.80
Openness to New Experiences ^c	2.05	.43
Material Values ^d	3.21	.61
Experiential Self-Control ^e	3.08	.82
Reformative Self-Control ^e	2.27	.65
Redressive Self-Control ^e	2.63	.75

^a Power-Prestige, Time-Retention, Distrust, and Anxiety subscales belong to the Money Attitude Scale.

^b Overall mean score was calculated for the Barratt Impulsiveness Scale (BIS-11) since most of the internal consistency of most of the subscales did not reach adequate levels.

^c Extraversion, Agreeableness, Conscientiousness, Emotional Stability, and Openness to New Experiences subscales belong to the Big 5 Personality Traits.

^d Overall mean score was calculated for the Material Values Scale since the internal consistency of the original subscales did not reach adequate levels.

^e Experiential Self-Control, Reformative Self-Control, and Redressive Self-Control subscales belong to the Self-Control Schedule.

Table: 2
AVE, Square Root of AVE, and Composite Reliability Scores for Psychological Scales

	AVE	Square Root of AVE	Composite Reliability
Impulsive Buying	.52	.72	.99
Compulsive Buying	.53	.73	.98
Self-Esteem	.52	.72	.99
Power-Prestige ^a	.53	.73	.98
Time-Retention ^a	.68	.83	.99
Distrust ^a	.45	.67	.97
Anxiety ^a	.43	.65	.94
Impulsivity ^b	.23	.48	.99
Extraversion ^c	.45	.67	.99
Agreeableness ^c	.33	.58	.97
Conscientiousness ^c	.21	.46	.96
Emotional Stability ^c	.51	.71	.99
Openness to New Experiences ^c	.26	.51	.97
Material Values ^d	.32	.57	.99
Experiential Self-Control ^e	.31	.56	.98
Reformative Self-Control ^e	.34	.58	.99
Redressive Self-Control ^e	.37	.60	.98

^a Power-Prestige, Time-Retention, Distrust, and Anxiety subscales belong to the Money Attitude Scale.

^b Overall mean score was calculated for the Barratt Impulsiveness Scale (BIS-11) since most of the internal consistency of most of the subscales did not reach adequate levels.

^c Extraversion, Agreeableness, Conscientiousness, Emotional Stability, and Openness to New Experiences subscales belong to the Big 5 Personality Traits.

^d Overall mean score was calculated for the Material Values Scale since the internal consistency of the original subscales did not reach adequate levels.

^e Experiential Self-Control, Reformative Self-Control, and Redressive Self-Control subscales belong to the Self-Control Schedule.

7.2. Financial Characteristics

Given the experiment's aim, it was crucial to understand the general financial tendencies of the participants to have a better insight into how far the findings can be generalised. We asked the participants seven questions regarding financial literacy, as presented in Table 3. People with low financial literacy, classified as having answered three questions or less correctly, occupied 33.2% of the sample, whereas 66.8% had high financial literacy. Most people could correctly answer five questions, whereas only six participants could not correctly answer any of those questions about financial literacy.

Table: 3
Frequency and Percentage Distribution of Financial Literacy Questions

Total True Answers	Frequency	Percentage
0	6	2.5%
1	13	5.5%
2	22	9.2%
3	38	16.0%
4	44	18.5%
5	51	21.4%
6	43	18.1%
7	21	8.8%
Total	238	100%

Note: The table style was obtained from Güler and Tunahan (2017).

The content of the questions is presented in Table 4. There were a variety of questions which measured different aspects of financial literacy. For each content, there was only one question. Although participants thought that they knew the answer to the mathematical ability question, it was apparent that they mostly struggled with it. On the other hand, the most correctly answered question was about the time value of money, correctly answered by more than 2/3 of all samples.

Table 4
Content and Correctness Distributions of the Financial Literacy Questions

Content of the Question	True		False		I don't know	
	Frequency	Percentage	Frequency	Percentage	Frequency	Percentage
Mathematical Ability	106	44.5%	117	49.1%	15	6.3%
Interest Account	144	60.5%	75	31.5%	19	8.0%
Inflation Effect	166	69.7%	28	11.7%	44	18.5%
Time Value of Money	169	71.0%	45	18.9%	24	10.1%
Money Error	121	50.8%	92	38.6%	25	10.5%
Stock Knowledge	155	65.1%	54	22.7%	29	12.2%
Investment Diversification	146	61.3%	60	25.2%	32	13.4%

Note: The table style was obtained from Güler and Tunahan (2017).

Participants answered how well they knew about seven different financial concepts and indicated their knowledge level ranging from one to three, with a no-answer option presented in Table 5. In general, participants were more knowledgeable about the delay interest rate and minimum payment amount; in contrast, they were less familiar with default interest and interest rate cut fees.

Table: 5
Knowledge Levels of Financial Concepts

	I know well	I know, but not in detail	I don't know at all	No answer
Monthly Statements	154 (64.7%)	47 (19.7%)	25 (10.5%)	12 (5%)
Default Interest	124 (52.1%)	57 (23.9%)	45 (18.9%)	12 (5%)
Trade Interest Rate	173 (72.7%)	35 (14.7%)	18 (7.6%)	12 (5%)
Delay Interest Rate	199 (83.6%)	22 (9.2%)	5 (2.1%)	12 (5%)
Minimum Payment Amount	207 (87.0%)	14 (5.9%)	5 (2.1%)	12 (5%)
Repayment Schedule	190 (79.8%)	31 (13.0%)	5 (2.1%)	12 (5%)
Interest Rate Cut Fee	151 (63.4%)	53 (22.3%)	22 (9.2%)	12 (5%)

Note: The table style was obtained from Güler and Tunahan (2017).

Participants were also asked to indicate the most critical elements they considered while choosing a personal loan. Results showed that most participants rely on interest, commission, and other expenses simultaneously compared to the alternatives. In contrast, insurance was the least chosen option, as selected by just one participant, as presented in Table 6.

Table: 6
The Most Important Factors for Personal Loans

	Frequency	Percentage
Interest Rate	67	28.2%
Filing Fee	6	2.5%
Insurance	1	0.4%
Interest + Commission + Other Expenses	154	64.7%
No Answer	10	4.2%

Note: The table style was obtained from Güler and Tunahan (2017).

7.3. Principal Findings

Since the dependent variable was categorical, we calculated the mean scores for each scale and subscale instead of using cut-off points for the analyses. We used Bonferroni adjustment to control for family-wise error rate, which reduced the alpha level from 0.05 to 0.003 for the 15 planned t-tests.

7.3.1. Differences Between Consumer Credit Users and Non-Users

Consumer credit users had significantly lower self-esteem ($M=1.55$, $SD=.46$ vs. $M=1.89$, $SD=.52$), conscientiousness ($M=1.63$, $SD=.57$ vs. $M=2.08$, $SD=.64$), emotional stability ($M=2.46$, $SD=.71$ vs. $M=3.10$, $SD=.80$), and experiential self-control ($M=2.90$, $SD=.73$ vs. $M=3.50$, $SD=.81$) scores than non-users. There were no statistically significant differences in reformative self-control, redressive self-control, impulsivity, buying impulsiveness, materialism, compulsive buying, agreeableness, openness to new experiences, or extraversion.

To assess the relationship between financial literacy and consumer credit usage, a chi-square test of independence showed no statistically significant relationship between financial literacy and consumer credit usage [$X^2(1, N = 228) = .244$, ns]. Then, a binomial logistic regression was conducted to investigate whether personality traits, impulsive buying, compulsive buying, self-control, impulsivity, money attitudes, self-esteem, material

values, and financial literacy could successfully distinguish consumer credit users and non-users. The results are presented in Table 7.

Table: 7
Binomial Logistic Regression Predicting the Consumer Credit Usage

Variable	B	SE	OR	95% CI		p
				Lower	Upper	
Constant						.000
Impulsive Buying	.204	.346	1.226	.622	2.416	.555
Compulsive Buying	-.178	.401	.837	.381	1.838	.658
Self-Esteem	.892	.502	2.441	.912	6.532	.076
Power-Prestige ^a	-.096	.366	.908	.443	1.862	.792
Time-Retention ^a	-.463	.253	.629	.384	1.033	.067
Distrust ^a	.589	.375	1.801	.864	3.757	.117
Anxiety ^a	.284	.350	1.328	.669	2.634	.417
Impulsivity ^b	1.644	.847	5.174	.985	27.187	.052
Extraversion ^c	-.766	.342	.465	.238	.909	.025
Agreeableness ^c	.126	.467	1.134	.454	2.835	.788
Conscientiousness ^c	1.254	.402	3.504	1.594	7.701	.002
Emotional Stability ^c	.883	.327	2.419	1.273	4.596	.007
Openness to New Experiences ^c	-.222	.501	.801	.300	2.137	.658
Material Values ^d	.440	.452	1.553	.640	3.768	.330
Experiential Self-Control ^e	.905	.324	2.471	1.309	4.663	.005
Reformative Self-Control ^e	.479	.431	1.615	.694	3.760	.266
Redressive Self-Control ^e	-.323	.358	.724	.359	1.462	.368
Financial Literacy	-.355	.400	.701	.320	1.537	.375

^a Power-Prestige, Time-Retention, Distrust, and Anxiety subscales belong to the Money Attitude Scale.

^b Overall mean score was calculated for the Barratt Impulsiveness Scale (BIS-11) since most of the internal consistency of most of the subscales did not reach adequate levels.

^c Extraversion, Agreeableness, Conscientiousness, Emotional Stability, and Openness to New Experiences subscales belong to the Big 5 Personality Traits.

^d Overall mean score was calculated for the Material Values Scale since the internal consistency of the original subscales did not reach adequate levels.

^e Experiential Self-Control, Reformative Self-Control, and Redressive Self-Control subscales belong to the Self-Control Schedule.

7.3.2. Model Fit and Evaluation

Model fit was assessed using the Hosmer-Lemeshow test, which showed that the model fit the data well [$\chi^2(8, N=228) = 10.747, p=.216$]. The binomial logistic regression model was also statistically significant [$\chi^2(18, N=228) = 71.237, p<.001$], indicating that the personality traits and self-control variables significantly predicted consumer credit usage.

The overall model explained 38.0% (Nagelkerke R²) of the variance in consumer credit usage. The model was also able to correctly classify 82.0% of all cases, with a sensitivity of 94.3% for consumer credit users and a specificity of 53.6% for non-users.

7.3.3. Significant Predictors of Consumer Credit Usage

Extraversion (B=-.766, SE=.342, Wald=5.021, p=.025), conscientiousness (B=1.254, SE=.402, Wald=9.738, p=.002), emotional stability (B=.883, SE=.327, Wald=7.281, p=.007), and experiential self-control (B=.905, SE=.324, Wald=7.790, p=.005) were significant predictors of consumer credit usage.

Expressly, the odds ratio indicated that for every one-unit increase on:

- Conscientiousness: the odds of not using consumer credits increased by nearly 3.5.
- Emotional stability: the odds of not using consumer credits increased by nearly 2.42.
- Experiential self-control, the odds of not using consumer credits increased by nearly 2.47.
- Extraversion, the odds of not using consumer credits decreased by nearly 0.47.

7.3.4. Other Measures

Impulsive buying, compulsive buying, self-esteem, money attitudes, agreeableness, openness to new experiences, material values, reformative self-control, redressive self-control, and financial literacy were not significant predictors of consumer credit usage.

8. Discussion

In the present study, we investigated the behavioural and cognitive differences between individuals who used consumer credit (CC) and those who did not. The results showed that extraversion was a significant positive predictor of CC usage, while conscientiousness, emotional stability, and experiential self-control were significant negative predictors. Therefore, hypotheses 2 and 5 were partially confirmed, while the rest were rejected. The independent samples t-test results also indicated that CC users have lower self-esteem than non-users. Previous research has shown that conscientious households are less likely to have high unsecured debts, credit card debts, and overdrafts, while emotionally unstable households are more likely to have overdrafts and hire purchase agreements (Brown & Taylor, 2014). Additionally, single extroverts are more likely to use overdrafts and have higher levels of unsecured debt. Low conscientiousness, emotional stability, and high extraversion are associated with more frequent usage of certain credits (Brown & Taylor, 2014). Our findings corroborate these findings and suggest that these personality traits are good indicators of credit usage. Individuals may engage in certain luxury consumption habits to feel more valuable (Pettit & Sivanathan, 2011), which can lead to unfavourable financial outcomes (Omar et al., 2014). Consistent with this, our study found that CC users had significantly lower self-esteem.

The self-control measure included three subscales: experiential, reformative, and redressive self-control. Experiential self-control was a significant predictor of CC usage. Experiential self-control optimises behaviours and cognitions to experience enjoyable activities (Rosenbaum, 1993). Previous research has shown that low-self-controlled individuals are more likely to use high-cost credits and be over-indebted (Gathergood, 2012). Consistent with this literature, our research found that CC users had lower experiential self-control. This study provides novel insights into the behavioural and cognitive differences between CC users and non-users. The findings suggest that extraversion, conscientiousness, emotional stability, and experiential self-control are important personality traits to consider when assessing an individual's risk of CC usage.

Additionally, the findings suggest that CC users may have lower self-esteem and engage in luxury consumption habits to feel more valuable.

The present study found that consumer credit users were more likely to be extroverted and have lower conscientiousness, emotional stability, and experiential self-control than non-users. These findings are consistent with previous research that has shown that these personality traits are associated with risky financial behaviours, such as gambling and overspending (Achtziger et al., 2015; Baumeister, 2002; Biljanovska & Palligkinis, 2018; Brown & Taylor, 2014; Donnelly et al., 2012; Gathergood, 2012; Ottaviani & Vandone, 2011; Strömbäck et al., 2017). One possible explanation for this relationship is that people with these personality traits are more likely to engage in impulsive behaviours. Impulsivity is characterised by a lack of planning and forethought, leading people to make decisions without fully considering the consequences (Wittmann & Paulus, 2008). As a result, more impulsive people may be more likely to use consumer credit without carefully considering their ability to repay it. Another possible explanation for the relationship between personality traits and consumer credit usage is that people with certain personality traits may be more likely to be exposed to marketing messages encouraging consumer spending. For example, extroverts may be more likely to be drawn to social media and other forms of advertising that promote consumerism. Additionally, people with lower conscientiousness may be more attracted to products and services marketed as exciting and glamorous (Richins, 2011). Finally, it is also possible that the relationship between personality traits and consumer credit usage is due to financial stress. Financial stress can lead to several negative consequences, including impaired decision-making and increased impulsivity (Gathergood, 2012). As a result, people experiencing financial stress may be more likely to use consumer credit to cope with their problems, even though this may worsen their financial situation in the long run.

The present study's findings have several implications for policymakers and financial institutions. For example, policymakers could develop programs to help people build their conscientiousness, emotional stability, and experiential self-control. These programs could teach people how to make more informed financial decisions and resist the temptation to spend money impulsively. Financial institutions could also develop products and services specifically designed for people with different personality traits and impulsivity levels. For example, financial institutions could offer financial planning services to help people develop a budget and create a savings plan. Additionally, financial institutions could offer products such as secured credit cards to help people with poor credit histories build their credit scores. Overall, the present study's findings suggest that personality traits play an important role in consumer credit usage. By understanding the relationship between personality traits and consumer credit usage, policymakers and financial institutions can develop interventions to help people make better financial decisions and avoid the negative consequences of excessive debt.

9. Conclusion (Remarks and Future Directions)

The present study contributes to the literature on consumer credit usage and personality traits in several ways. First, it is one of the first studies to examine the relationship between the Big Five personality traits and consumer credit usage in a large and diverse sample of adults. Second, the study used various methods to measure consumer credit usage, including self-reported credit card debt, utilisation rates, and the number of credit inquiries. Third, the study controlled for several factors that could influence the relationship between personality traits and consumer credit usage, such as age, gender, income, and education.

The present study's findings have several implications for professionals who work with consumers. For example, financial planners and counsellors can use the results of this study to help consumers develop financial plans and strategies tailored to their personality traits and risk tolerance. Additionally, lenders can use the findings of this study to produce more accurate credit scoring models that take into account personality traits.

Future research on consumer credit usage and personality traits should focus on several areas. First, future research should examine the mediating and moderating factors that underlie the relationship between personality traits and consumer credit usage. For example, future research could examine whether financial literacy and financial stress mediate the relationship between personality traits and consumer credit usage. Second, future research should examine the relationship between personality traits and different types of consumer credit, such as credit cards, instalment loans, and mortgages. Third, future research should examine the relationship between personality traits and consumer credit usage in different cultural contexts.

The present study provides valuable insights into the relationship between personality traits and consumer credit usage. The findings of this study have the potential to help policymakers, financial institutions, and professionals who work with consumers develop interventions to help consumers make better financial decisions and avoid the negative consequences of excessive debt.

References

- Achtziger, A. et al. (2015), "Debt out of control: The links between self-control, compulsive buying, and real debts", *Journal of Economic Psychology*, 49, 141-149.
- Baumeister, R.F. (2002), "Yielding to temptation: Self-control failure, impulsive purchasing, and consumer behavior", *Journal of Consumer Research*, 28(4), 670-676.
- Biljanovska, N. & S. Palligkinis (2018), "Control thyself: Self-control failure and household wealth", *Journal of Banking & Finance*, 92, 280-294.
- Braswell, M.G. & E. Chernow (N.A.), *Consumer credit law & practice in the U.S.*, United States of America Federal Trade Commission.
- Brown, S. & K. Taylor (2014), "Household finances and the 'Big Five' personality traits", *Journal of Economic Psychology*, 45, 197-212.

- Disney, R.F. & J. Gathergood (2011), "Financial literacy and indebtedness: New evidence for U.K. consumers", *SSRN Electronic Journal*, <http://dx.doi.org/10.2139/ssrn.1851343>
- Donnelly, G. et al. (2012), "The Big Five personality traits, materialism values, and financial well-being of self-described money managers", *Journal of Economic Psychology*, 33(6), 1129-1142.
- Duyan, V. et al. (2012), "Self-control scale - SCS: Reliability and validity study", *Toplum ve Sosyal Hizmet*, 23(1), 19-30.
- Faber, R.J. & T.C. O'Guinn (1989), "Classifying compulsive consumers: Advances in the development of a diagnostic tool", *Advances in Consumer Research*, 16(1), 738-744.
- Faber, R.J. & T.C. O'Guinn (1992), "A clinical screener for compulsive buying", *Journal of Consumer Research*, 19(3), 459-469.
- Gathergood, J. (2012), "Self-control, financial literacy, and consumer over-indebtedness", *Journal of Economic Psychology*, 33(3), 590-602.
- Goldberg, L.R. (1992), "The development of markers for the Big-Five factor structure", *Psychological Assessment*, 4(1), 26-42.
- Güleç, H. et al. (2008), "Psychometric properties of the Turkish version of the Barratt Impulsiveness Scale-11", *Bulletin of Clinical Psychopharmacology*, 18(4), 251-258.
- Güler, E. & H. Tunahan (2017), "Finansal okuryazarlık: Hane halkı üzerine bir araştırma", *İşletme Bilimi Dergisi*, 5(3), 79-104.
- Howitt, D. & D. Cramer (2017), *Understanding statistics in psychology with SPSS*, Pearson.
- Kahneman, D. & A. Tversky (1979), "Prospect theory: An analysis of decision under risk", *Econometrica*, 47(2), 263-291.
- Moeller, F.G. et al. (2001), "Psychiatric aspects of impulsivity", *American Journal of Psychiatry*, 158(11), 1783-1793.
- Okutan, S. et al. (2013), "Keşifsel satın alma eğilimleri ve bu eğilimlerin plansız, kompulsif ve hedonik satın alma tarzlarıyla olan ilişkisinin incelenmesi", *Eskişehir Osmangazi Üniversitesi İktisadi ve İdari Bilimler Dergisi*, 8(3), 117-136.
- Omar, N.A. et al. (2014), "Compulsive buying and credit card misuse among credit card holders: The roles of self-esteem, materialism, impulsive buying, and budget constraint", *Intangible Capital*, 10(1), 52-74.
- Otero-López, J.M. & E. Villardefrancos (2013), "Five-factor model personality traits, materialism, and excessive buying: A mediational analysis", *Personality and Individual Differences*, 54(6), 767-772.
- Ottaviani, C. & D. Vandone (2011), "Impulsivity and household indebtedness: Evidence from real life", *Journal of Economic Psychology*, 32(5), 754-761.
- Ottaviani, C. & D. Vandone (2017), "Financial literacy, debt burden and impulsivity: A mediation analysis", *Economic Notes*, 47(2-3), 439-454.
- Özgüngör, S. & A.D. Paksu (2017), "Üniversite öğrencilerinde benlik saygısı düzeyine göre akademik başarıyı yordayan değişkenler", *Türk Psikolojik Danışma ve Rehberlik Dergisi*, 7(48), 111-125.
- Palan, K.M. et al. (2011), "Compulsive buying behavior in college students: The mediating role of credit card misuse", *Journal of Marketing Theory and Practice*, 19(1), 81-96.

- Patton, J.H. et al. (1995), "Factor structure of the Barratt Impulsiveness Scale", *Journal of Clinical Psychology*, 51(6), 768-774.
- Pettit, N.C. & N. Sivanathan (2011), "The plastic trap: Self-threat drives credit usage and status consumption", *Social Psychological and Personality Science*, 2(2), 146-153.
- Richins, M.L. & S. Dawson (1992), "A consumer values orientation for materialism and its measurement: Scale development and validation", *Journal of Consumer Research*, 19(3), 303-316.
- Richins, M.L. (2011), "Materialism, transformation expectations, and spending: Implications for credit use", *Journal of Public Policy & Marketing*, 30(2), 141-156.
- Rook, D.W. & R.J. Fisher (1995), "Normative influences on impulsive buying behavior", *Journal of Consumer Research*, 22(3), 305-313.
- Rosenbaum, M. (1980), "A schedule for assessing self-control behaviors: Preliminary findings", *Behavior Therapy*, 11(1), 109-121.
- Rosenbaum, M. (1993), "The three functions of self-control behaviour: regressive, reformative and experiential", *Work & Stress*, 7(1), 33-46.
- Rosenberg, M. (1965), *Society and the adolescent self-image*, Princeton University Press.
- Strömbäck, C. et al. (2017), "Does self-control predict financial behavior and financial well-being?", *Journal of Behavioral and Experimental Finance*, 14, 30-38.
- Süer, Ö. et al. (2017), "Impact of money attitude on career goals: A survey on undergraduate students", *Ege Academic Review*, 17(4), 527-537.
- Tatar, A. (2017), "Büyük Beş-50 Kişilik Testinin Türkçeye çevirisi ve Beş Faktör Kişilik Envanteri Kısa Formu ile karşılaştırılması", *Anadolu Psikiyatri Dergisi*, 18(1), 51-61.
- Tukuş, L. (2010), *The self-esteem rating scale short form*, [Medical Specialization, Kocaeli University], Kocaeli University Academic Data Management System.
- Ünal, S. et al. (2013), "Materyalizmin statü tüketimini üzerindeki etkisini belirlemeye yönelik bir araştırma", *Atatürk Üniversitesi İktisadi ve İdari Bilimler Dergisi*, 27(2), 43-62.
- Van Rooij, M.C.J. et al. (2012), "Financial literacy, retirement planning and household wealth", *The Economic Journal*, 122(560), 449-478.
- Wang, J. & J.J. Xiao (2009), "Buying behavior, social support and credit card indebtedness of college students", *International Journal of Consumer Studies*, 33(1), 2-10.
- Wang, L. et al. (2011), "The impact of attitude variables on the credit card debt behavior", *Nankai Business Review International*, 2(2), 120-139.
- Watson, J.J. (2003), "The relationship of materialism to spending tendencies, saving, and debt", *Journal of Economic Psychology*, 24(6), 723-739.
- Wittmann, M. & M.P. Paulus (2008), "Decision making, impulsivity and time perception", *Trends in Cognitive Sciences*, 12(1), 7-12.
- World Bank (2013), *Financial Literacy Diagnostic Surveys 2008 and 2009 (Panel)*, <<https://microdata.worldbank.org/index.php/catalog/1028>>, 23.08.2021.
- Yamauchi, K.T. & D.J. Templer (1982), "The development of a Money Attitude Scale", *Journal of Personality Assessment*, 46(5), 522-528.

Appendix A

Results of the Correlation Analysis Among the Psychological Measures

<i>Correlations of the Study Variables</i>																	
Variable	1	2	3	4	5	6	7	8	9	10	11	12	13	14	15	16	17
1. Impulsive Buying Scale	-																
2. Compulsive Buying Scale	.641**	-															
3. Rosenberg Self-Esteem Scale	-.130*	-.248**	-														
4. Power-Prestige Subscale	.260**	.314**	-.179**	-													
5. Time-Retention Subscale	-.241**	-.242**	.109	.060	-												
6. Distrust Subscale	.023	.185**	-.254**	.437**	.239**	-											
7. Anxiety Subscale	.227**	.277**	-.225**	.515**	.164*	.647**	-										
8. Barratt Impulsivity Scale-11	.338**	.344**	-.438**	.393**	-.245**	.275**	.325**	-									
9. Extraversion Subscale	-.024	-.021	.436**	.057	.209**	-.042	.002	-.205**	-								
10. Agreeableness Subscale	-.057	-.052	.368**	-.144*	.140*	-.043	-.069	-.278**	.433**	-							
11. Conscientiousness Subscale	-.138*	-.182**	.452**	-.246**	.140*	-.232**	-.164*	-.642**	.209**	.240**	-						
12. Emotional Stability Subscale	-.164*	-.262**	.569**	-.155*	.038	-.223**	-.275**	-.401**	.402**	.232**	.385**	-					
13. Openness to New Experiences Subscale	-.136*	-.133*	.275**	-.030	.196**	-.027	-.018	-.301**	.387**	.354**	.256**	.184**	-				
14. Material Values Scale	.397**	.387**	-.171**	.658**	.006	.228**	.433**	.321**	.084	-.181**	-.188**	-.215**	.009	-			
15. Experiential Self-Control Subscale	-.227**	-.252**	.489**	-.309**	.018	-.389**	-.384**	-.508**	.278**	.157	-.422**	.637**	.177**	-.289**	-		
16. Reformative Self-Control Subscale	-.098	-.162*	.401**	-.166*	.305**	-.057	-.048	-.487**	.306**	.281**	.501**	.269**	.363**	-.191**	.262**	-	
17. Redressive Self-Control Subscale	-.020	-.091	.458**	-.157*	.134*	-.053	-.153*	-.300**	.245**	.335**	.373**	.355**	.274**	-.191**	.330**	.674**	-

Note. * Indicates $p < .05$; ** indicates $p < .01$.

Translation And Diffusion Process of The Shopping Mall Form: A Case Study¹

Fettah KAYRA (<https://orcid.org/0000-0002-6954-9910>), Siirt University, Türkiye; fettah.kayra@siirt.edu.tr

Deniz TAŞCI (<https://orcid.org/0000-0001-5386-6279>), Anadolu University, Türkiye; dtasci@anadolu.edu.tr

Akansel YALÇINKAYA (<https://orcid.org/0000-0002-7843-0612>), İstanbul Medeniyet University, Türkiye; akansel.yalcinkaya@medeniyet.edu.tr

Umut KOÇ (<https://orcid.org/0000-0002-9669-0290>), Eskişehir Osmangazi University, Türkiye; umutkoc@ogu.edu.tr

Alişveriş Merkezi Formunun Çeviri ve Yayılım Süreci: Bir Vaka Analizi²

Abstract

This study aims to reveal how the shopping mall form, a management idea, changed during its transfer to Türkiye and to analyse the effective factors in this process. For the research part, interviews were held with 23 people, including the general managers of 21 shopping malls operating in Türkiye and two leading sector executives. The findings point out that during the initial embedding of the shopping mall idea in Türkiye, the idea was preserved mainly in terms of managerial and structural aspects. Factors such as flexibility of the idea, environment, management, level of knowledge and rivalry among existing competitors are effective in the prominence of diffusion or translation. Finally, by expanding the scope of translation, the study puts forward the concepts of individual and social translation as well as interpersonal translation.

Keywords : Institutional Theory, Scandinavian Institutionalism, Diffusion, Translation, Shopping-Mall.

JEL Classification Codes : L2, L81, M1, M3.

Öz

Bu çalışmanın amacı, bir yönetim fikri olan AVM formunun Türkiye'ye geçiş sürecindeki değişimini ve bu süreçte etkili olan faktörleri açığa çıkarmaktır. Araştırma kısmı için, Türkiye'de faaliyet gösteren 21 AVM genel müdürü ve sektörün önde gelen 2 üst düzey yöneticisi olmak üzere toplamda 23 kişi ile görüşmeler gerçekleştirilmiştir. Elde edilen bulgular, Türkiye'de AVM fikrinin ilk yerleşimi sırasında, fikrin yönetsel ve yapısal açıdan büyük ölçüde korunduğuna işaret etmektedir. Fikrin esnekliği, çevre, yönetim, bilgi düzeyi ve mevcut rakipler arasındaki rekabet gibi faktörlerin yayılım veya çevirinin öne çıkmasında etkili olduğu görülmüştür. Son olarak; çalışma, çeviri kavramının kapsamını genişleterek bireyler arası çevirinin yanında bireysel çeviri ve toplumsal çeviri kavramlarını öne sürmüştür.

Anahtar Sözcükler : Kurumsal Kuram, İskandinav Kurumsalcılığı, Yayılım, Çeviri, AVM.

¹ This study was produced from Fettah Kayra's Ph.D. Dissertation titled "Translation and Import Process of the Shopping Center (Mall) Form: The Case of Turkey" supervised by Prof. Deniz Taşcı and Assoc.Prof. Akansel Yalçinkaya.

² Bu çalışma, Fettah Kayra'nın; Prof.Dr. Deniz Taşcı ve Doç.Dr. Akansel Yalçinkaya danışmanlığında yürüttüğü "Alishveriş Merkezi (AVM) Formunun Çeviri ve İthal Süreci: Türkiye Örneği" adlı doktora tezinden üretilmiştir.

1. Introduction

Researchers usually differ in their interpretations of the same event or phenomenon. These differences in perspective also emerge in management and organisation, as in every field. For example, there are different explanations about how much management ideas change during their transition from one place to another. Institutional theorists describe the transition process of ideas more concretely as the transition of an object to another place and emphasise the similarities between the source of the idea and the place it reaches (Meyer & Rowan, 1977; DiMaggio & Powell, 1983; Tolbert & Zucker, 1983; Deephouse, 1996). Scandinavian institutionalism, which is rooted in institutional theory and creates a separate school, argues that ideas are in a constant flux of change and will change wherever they reach, so this will cause differences between the source and the target (Czarniawska & Joerges, 1996; Sahlin-Andersson, 1996; Sahlin & Wedlin, 2008). Institutional theory refers to the similarity with the concept of "diffusion" (DiMaggio & Powell, 1983; Meyer & Rowan, 1977), while Scandinavian institutionalism refers to differentiation with the concept of "translation" (Czarniawska & Joerges, 1996; Sahlin-Andersson, 1996; Sahlin & Wedlin, 2008; Sevón, 1996).

This study focuses on shopping malls (SMs³), which occupy an important social sphere and have a significant economic and social impact on society. With an organisational structure first emerging in the United States (USA) (Coleman, 2006: 42), this management idea spread rapidly to the world as a successful model. It consolidated its place in the retail sector. Therefore, as a management idea, the process of introducing SMs in Türkiye, the factors affecting it, and their changes over time since their introduction are subjects worth studying and researching. The study will also provide an opportunity to test the predictions of institutional theory and Scandinavian institutionalism, which explain the transition of ideas to different spaces from two different perspectives. The study examines whether the SM idea differs from the models that the SM idea was taken as an example of during its establishment in Türkiye, whether the SMs operating in Türkiye differ intellectually and structurally, and if they do, the extent to which this difference occurs.

Current studies in translation generally focus on the applications of management ideas in different organisations and translation processes. However, in this study, the translation process of the SM, which is both a management idea and an organisational structure, was examined. However, it has a unique place in that it deals with institutional theory and Scandinavian institutionalism approaches and tries to analyse them comparatively. Therefore, this research will contribute to the translation studies that have been developing recently. In addition, in terms of its scope, it addresses both theorists and practitioners, that is, managers in the sector. Finally, by expanding the scope of translation,

³ In this study, the term shopping mall (SMs) only represents today's organised and modern shopping centres, and the term shopping place will be used for all other traditional buildings.

the study puts forward the concepts of individual and social translation as well as interpersonal translation.

The outline of the study is as follows:

First, the historical development and main arguments of the institutional theory, which is the basis of the study, and the Scandinavian institutionalism, a school of institutional theory, are discussed. Then, the historical development and general characteristics of SMs are briefly explained. In the next section, the data and research findings of the research conducted on SMs are presented. The final section presents a discussion and conclusion, limitations, recommendations, and suggestions for future research.

2. From Institutional Theory to Scandinavian Institutionalism

Scott (2014: 2) states that early institutional discussions emerged during the discussions of scientific methods in the social sciences in Germany and Austria in the late 19th century. During this period, some innovative economists opposed the idea that the economy could be reduced to a set of universal laws and argued that economic processes develop within a social setting shaped by culture and historical events.

Institutional theory studies in the field of organisation are based on Selznik's study titled "TVA and the Grassroots (1949)", in which he examines the activities of the Tennessee Valley Authority (TVA), established for the development of the Tennessee Valley in the USA in the 1930s (Scott, 2014: 23).

Institutional theory assumes that individuals, groups or organisations should not be considered in isolation from society and other environmental factors and that the actors exposed to these factors cannot act freely because they are restricted. Actors whose behaviour is restricted are rejected by the environment if they do not comply with the order and are forced to comply with the system by various mechanisms (DiMaggio & Powell, 1983). This suggests that actors will act similarly to gain legitimacy and become homogeneous after a while (Hawley, 1981: 424; DiMaggio & Powell, 1983: 150-154; Powell & DiMaggio, 1991; Deephouse, 1996). According to Schuman (1995), the sources of this motivation are based on utility, morality, or some cognitive reasons. As such, institutional theory tries to explain the similar processes among organisations (Greenwood & Hinings, 1996).

Diffusion theory is generally associated with Rogers' (1983) book "Diffusion of Innovations" (Mica, 2013: 4). Rogers defines *diffusion* as the process of communicating an innovation, a new idea, product, or service, among members of a social system through specific channels over time (Rogers, 1983: 5). The author defines the factors affecting the diffusion process as the characteristics of the innovation, the social system (community of potential adopters), communication channels and time (Rogers, 1983: 10). According to Latour (1986), there are three important elements of the diffusion process, which are the

energy that triggers movement for diffusion, the means that provides continuity, and diffusion. Wejnert (2002: 298-299) argues that three factors are decisive in the process of diffusion, namely, the characteristics of the disseminated idea, the characteristics of the actor involved in the process, and the environmental conditions.

The concept of diffusion is considered to be valid for organisations that are in search of more legitimacy because organisations adopt certain routines to gain approval from their institutional environment, and this results in a process with only minor changes in the original idea (Boons & Strannegård, 2000: 15). Proponents of the institutional theory generally argue that management ideas spread with slight variation among organisations. As a result, organisations become homogenised.

Most diffusion research emphasises inter-organizational situations, analyses at the population level, and generally focuses on accepting or rejecting disseminated ideas (Ansari et al., 2010: 67).

Although various studies have been conducted on the diffusion of management ideas for many years, these studies have generally been based on the concept of diffusion, and the focus has been on travel routes and means rather than the content and transformation of ideas (Sahlin & Wedlin, 2008). However, something unexpected happened during the 1980s-1990s. Many organisational practices such as total quality management (TQM), management by objectives (MBO), and new public management (NPM) spread rapidly among organisations (Abrahamson, 1996a; Abrahamson, 1996b; Sahlin & Wedlin, 2008: 220), and became fashionable, especially in the public sector, but these practices did not always go as planned. Although institutions often implement these practices as predicted by institutional theory (Meyer & Rowan, 1977), disseminated management ideas triggered organisational change in some institutions during this period (Sahlin & Wedlin, 2008), which could not be adequately explained and was considered as an exception by the institutional theory (Czarniawska, 2008: 771).

Scandinavian institutionalists emerged in this period and put forward the concept of *translation* by offering an important perspective in explaining why the same idea or practice differed while spreading among organisations. Accordingly,

- Management ideas do not spread identically among organisations and are transformed by actors during the deployment process, during which ideas cannot remain unchanged, and in a sense, they are subject to translation. Therefore, although imitation may seem like just copying, it is a process of change and reconstruction.
- Institutional theory suggests that organisations imitate each other due to institutional pressures in the institutional environment, and as a result, similar organisations emerge in the same organisational area (homogenisation). On the other hand, Scandinavian institutionalism claims that even if organisations imitate each other at the micro level, they will apply the same idea in different ways.

Scandinavian scientists were previously inspired by the work, ideas and theories of Richard W. Scott, James G. March, and John W. Meyer. Still, they later combined them with other research traditions that were influential in Scandinavia or emerged in Europe and formed a different school (Czarniawska, 2008; Sahlin & Wedlin, 2008: 219).

Translation studies are generally carried out at two levels (Røvik, 2016: 292): inter-organizational translation processes (creation and dissemination of the idea, adaptation of the idea to different places, etc.) and intra-organizational translation processes (resistance, power relations, intra-organizational practices, etc.).

Scandinavian institutionalism focuses on organisational diversity rather than uniformity and standardisation, on which institutional theory is more focused (Boxenbaum & Pedersen, 2009: 179). According to Scandinavian institutionalists, institutional theory focused too much on stability and standardisation issues and fell short of explaining change processes (Van Grinsven et al., 2016: 272).

The differences between the concept of diffusion studied by institutional theorists and the concept of translation reviewed by Scandinavian institutionalists are summarised in Table 1 (Kayra et al., 2022: 70).

Table: 1
Comparison of Diffusion and Translation Concepts

	DIFFUSION	TRANSLATION
The theoretical idea on which it is based	Scientism	Social constructivism
Perspective	Macro	Micro
Description of Organisational Communities	Homogeneous	Homogeneous in the macro dimension; heterogeneous in the micro dimension
Individual actors	Active	Passive
Spreading concept	Innovation	Idea
Change in the spreading concept	None or very little	More than the diffusion
Result	Predictable	Unpredictable

3. Shopping Malls (SMs)

With the emergence of modern lifestyles, the retail industry has evolved from small and independent stores to large and often combined outlets (Cheng et al., 2007: 885). Perhaps one of the most important of these is SMs.

SMs are planned and architecturally integrated retail outlets where various retail businesses operating as tenants are located and managed, have parking lots and are generally established in residential areas around the city (Baron et al., 1991: 175). Harris (2006: 883) defines SMs as "large structures planned around a large and central courtyard, usually with two or three floors, housing movie theatres, fast-food restaurants and entertainment venues as well as many shops".

SMs, which previously attracted consumers with the promise of a wide range of stores and products, have gradually become places where people spend their time and have fun (Bloch et al., 1994: 24).

The change in consumption culture played a key role in the emergence of SMs (Ritzer & Stepnisky, 2012: 211-212), and written and visual media advertisements also encourage consumption (Malec, 2010: 15).

Of course, SMs have not simply come out of nowhere. Historical shopping venues such as the Greek agora, the Roman forum, the temple in the East, markets and bazaars, medieval market fairs and the glass-enclosed passages of 19th-century Europe paved the way for the emergence of SMs (Cohen, 2002: 9; Singh & Srinivasan, 2012: 5).

The emergence and development of the first SMs in the modern sense of the world took place in the USA. Population growth, limited space for expansion in urban centres, universal increase in car ownership, traffic congestion in city centres, an abundance of available and accessible lands, and technological developments in ventilation-air conditioning-lighting accelerated this process and enabled the spread of SMs throughout the country (Coleman, 2006: 42). In addition, developments in cast iron engineering have made new multi-storey architectural structures that allow many goods to be displayed together possible (Shields, 2005: 3).

Completed in 1954 and designed by Victor Gruen (an Austrian immigrant), Northland Mall is located 20 miles from the city centre of Detroit, USA, an early example of these structures (Jewell, 2015: 16). Figure 1 shows a photo of Northland SM from 1954.

Figure: 1
Northland SM, 1954, Detroit



Source: <<https://esotericsurvey.blogspot.com/2015/08/northland-detroit.html>>, 27.02.2020.

Victor Gruen's next project, Southdale Mall in Edina, Minneapolis, is a significant milestone that has truly revolutionised the concept of shopping. Opened in 1956, Southdale was the first fully enclosed mall. This two-storey building was the largest mall ever built at the time (Coleman, 2006: 42-43).

The most crucial development in the process of transferring SMs to Türkiye is Türkiye's transition to a free market economy in the 1980s, which accelerated the inflow of

foreign capital into Türkiye and contributed remarkably to large projects such as SMs (Kolsuz & Yeldan, 2014: 49-50).

The first SM opened in Türkiye is Galleria, which was opened in 1988 in İstanbul Ataköy with the partnership of the state, inspired by The Galleria Mall in Houston (Altuna, 2012: 38). Figure 2 shows a photo of Galleria SM from 2015.

Figure: 2
Galleria SM, A Photo from 2015, İstanbul



Source: <<https://onedio.com/haber/turkiye-nin-ilk-avm-si-yikiliyor-566086>>, 09.03.2020.

After Galleria SM, such SMs started to spread rapidly. Currently, most SMs in Türkiye are in İstanbul, and one-third of the shopping centre investments are financed by foreign investors (Istanbul Valuation Consultancy Research [IGD], 2019: 30). The cities with the most SMs are İstanbul (147 units), Ankara (39 units) and İzmir (28 units). As of the end of November 2019, there are 454 SMs throughout Türkiye (Association of Real Estate and Real Estate Investment Companies [GYODER], 2019: 45). The total investment made for SMs opened by the end of 2018 is 58 billion USD (IGD, 2019: 30). However, due to economic fluctuations in recent years, high costs, low profitability and fierce competition, the time needed for investment return has become much longer, leading to a substantial reduction in new investments (IGD, 2019: 30).

In the ICSC classification of shopping centres, malls are included in regional and super regional shopping centres and refer to indoor spaces (Singh & Srinivasan, 2012: 25). In addition, our research subject is modern shopping centres, that is, SMs. Since there is no universally agreed standard definition of SMs, our research is based on SMs defined according to the laws currently in force in Türkiye.

For a commercial building to be called a SM in Türkiye, it must be composed of

- A building or a group of buildings within a particular area,
- At least 5000 m² sales area,

- At least ten workplaces where some or all the nutritional, dressing, entertainment, resting and cultural needs are met, provided that at least one has the quality of a big store. In case of lacking such a big store, it must consist of at least thirty workplaces where part or all these needs are met.
- Common use areas and areas specified in this regulation and
- It should have centralised management.

4. Methodology

In this section, information will be given about the purpose of the study, the research questions, the method used in the research, and the research procedures.

4.1. Research Problem and Research Question

From the perspective of managers operating in the SM sector, this case study aims to describe:

- How SMs were built together with the translation process during their establishment in Türkiye and how they were constructed by which actors,
- Similar and different aspects of SMs in Türkiye and other countries,
- The evolution of SMs in Türkiye and
- Which factors play a role in the differentiation of SMs?

The main research question is as follows: "What was the translation of SMs in the process of being placed in Türkiye, and how were they constructed?"

The study assumes that *the mall*, which emerged due to modernisation with a new management style and commercial structure, has been translated into many forms during and after its import to Türkiye and has been differentiated intellectually and structurally.

4.2. Research and Procedures

In this section, information is given on the research method and research process. The research design, study group, data collection process, data analysis, and ethical issues were discussed in this context.

4.2.1. Study Design

Designed as a case study, this research is based on the qualitative research method. Case studies are based on an in-depth and comprehensive analysis of a case. A group, individual, organisation, process or all social relations can be considered "cases" and, therefore, can be the subject of research (Strumińska-Kutra & Kołodkiewicz, 2018: 2). Merriam (1998: 27) defines a case study as "an intense and holistic description and analysis of a single event, phenomenon or social unit".

The semi-structured interview is the primary data collection tool in this study. The dataset was further strengthened and diversified by adding other data sources (regulations, biography, interviews, and other academic studies).

4.2.2. Study Group and Data Collection

Purposeful sampling was used for this research, with 21 SM managers (P1-P21) from seven geographical regions of Türkiye and two company general managers (P22 and P23) who witnessed the establishment of many of the first SMs in Türkiye. The interviews were conducted with 23 people, one of whom (P23) was a World ICSS (International Council of Shopping Centres) Jury Committee Member. Particular care was taken to select the participants representing many companies operating in the sector. The interviews, all of which were previously planned to be carried out face to face, were carried out through phone and Zoom due to pandemic restrictions. One interview was conducted face-to-face, 12 interviews were conducted by phone, eight interviews were carried out through Zoom, and two interviews were carried out both over the phone and through Zoom. The total duration of the interviews is 28 hours and 8 minutes. The interviews began on November 11, 2020, and continued until March 14, 2021, covering four months.

4.2.3. Data Transcription and Ethical Issues

After completing the interviews, the interview records of 28+ hours were manually transferred to the electronic environment and the data pages were read repeatedly. The *MAXQDA Analytics Pro 2020* program was used to organise the data. In addition:

- The interview questions, which were created as a result of a long research, reading and intensive analysis process, were also examined by different academics and their confirmation of their appropriateness was obtained.
- An application was submitted to Anadolu University, Social and Human Sciences, Scientific Research and Publication Ethics Committee for the ethical approval of the interview questions, which responded with a positive decision. The decision date is 03.11.2020, and the protocol no is 61075.
- The coding, categorisation and thematisation of the data was carried out in a coordinated manner. An agreement was reached on the coding process, and the hierarchical theme-category-code-subcode model was created.

5. Results

The research consists of 3 themes, as can be seen below.

- SMs in Türkiye from Past to Present
- How the SM Idea Came to be Adopted in Türkiye
- Factors Impacting the Diffusion or Translation of the Malls

Now, let us examine the themes and sub-titles.

5.1. SMs in Türkiye from Past to Present

The different aspects of SMs compared to traditional shopping places, the change and development of SMs over time, their institutionalisation, and the potential changes in the future are discussed in this section.

5.1.1. Comparison with Traditional Shopping Places

The participants generally stated that SMs differ significantly from traditional shopping venues. Modern SMs are managed from a single source and with a professional perspective, include large-scale stores (anchors) and generally house corporate organisations. In addition, these more comfortable and modern buildings differ from traditional shopping places regarding additional functions (cinema, playgrounds, beauty centre, etc.) and other services (infirmary, baby care room, etc.).

Emphasising real estate ownership and thus single-handed management as a distinguishing point, P23 explained this issue as follows:

Is the Grand Bazaar an SM? Unfortunately, no. (...). Even though there is a tradesman's association in the Grand Bazaar, the ownership there is fragmented, and each store can turn into any business it wants, whenever it wants (...)

Therefore, although the commercial operation and structure of the Grand Bazaar are similar to the logic underlying the mall concept, the Grand Bazaar does not have the status of an SM. However, some participants stated that the idea of SMs emerged as an improved version of the shopping venues in the past. They also noted that SMs sometimes contain traces of the past and often play the role of traditional shopping places.

5.1.2. Change Over Time

All the participants stated that SMs were affected by many factors over time, such as changing and developing social characteristics, technology, and some legal regulations. For example, P5 explained this change with sociological variables such as "the increase in the transition from rural life to urban life". Accordingly, with the transition to urban life, needs have increased and diversified, production has grown due to free market conditions, and the places where goods/services are supplied have remained inadequate. Therefore, these developments provided a driving force for the importation of SMs and the rapid increase in their number.

In addition, according to some participants, so far, there have been four generations of SMs in Türkiye, explained by P23 as follows:

In Türkiye, we can observe four generations of SMs. While the first-generation SMs have an introverted structure that does not receive daylight from the

outside, the lights of the shop windows overflow into the corridors. In contrast, the second-generation SMs, which later became multi-storey due to the expense of the land, included entertainment factors such as food and beverage and cinema on the upper floors. Then, after the smoking ban in Türkiye, we have seen examples of SMs that moved food and beverage units to their balconies, terraces, or doorways in the 3rd generation, which were more open to the outside, letting in the daylight. In the 4th generation, we see different centres with more open spaces, with SMs that are becoming more and more avenues, which allow shopping in open spaces, eating and drinking, and where cars can enter if necessary.

In the interviews, many ideas were expressed about the development of SMs over time. The critical developments pointed out by the participants are summarised below under ten headings:

- **Structural Development:** Over time, SMs have been built more extensively, functionally more diversified, and look aesthetically more pleasing.
- **Technology:** Establishing technical infrastructures that cost less, consume less energy and provide more comfort, zero-waste projects, benefiting from alternative energy sources such as solar energy, SM advertisements shifting to digital venues such as social media by replacing classical venues (newspapers, magazines, radio), and the use of advanced security technologies (X-rays and detectors at the entrances, cameras, etc.).
- **Shareholding Structure:** A multiple partnership structure was observed in the early periods, which caused difficulties in making quick decisions. However, recently, such a numerous partnership structure is not preferred.
- **Socialization:** While shopping was given the primary focus in SMs in the first period, later, the need for socialisation increased. Various events such as concerts, exhibitions, theatre plays, autograph sessions and entertainment organisations began to be organised. With the implementation of the smoking ban in indoor areas, SMs are designed to have large terrace areas.
- **Knowledge accumulation:** Over time, experience has been gained about SMs, and knowledge has increased in the sector, which has also played an important role in the differentiation of SMs.
- **Additional needs:** Recently, various needs such as baby care rooms, accessible toilets and parking lots, infirmaries, and medical help call buttons have been integrated into malls.
- **Payback Period of Investment:** The payback period of SM investments has become longer.
- **Power:** Power has generally shifted from SMs to retailers over time. The low number of SMs in the early periods and the strong desire of retailers to operate within the mall gave mall management a strong position. However, the increasing number of malls competing has led to losing this superiority over time.

- Promotions: The number of promotions/sales to attract consumers to malls has increased, and they have become more diversified. In addition, although individual stores initially organised promotions, they began to be managed by mall management in the following periods.
- Institutionalization: According to the participants, SMs have been firmly institutionalised over time and have become an important societal actor. Therefore, malls should not be considered as a fad.

5.1.3. Change in the Future

The participants voiced many opinions about the possible future changes that SMs will undergo. Six sub-headings were created according to the answers: location, architecture, specialisation, transformation, e-commerce, and technological developments. However, most participants mainly focused on location, store mix and management issues and emphasised that these factors will play an important role in determining the future of SMs.

- Location: Due to the increase in land prices in the city centres in the future, the growth of cities and the formation of new residential areas, the idea that new SMs to be established will generally be built outside the city centres has emerged.
- Architecture: In the interviews, it was highlighted that the SMs in the future might become smaller, mainly due to the competitive factor, and that with the effect of the pandemic, open or semi-open SMs could become widespread by modelling street retailing in the past. For example, P9 stated that they had to change their current projects under construction due to the pandemic, and they increased the open spaces in SMs.
- Specialization: Many participants expressed a common opinion that malls could develop in the field of entertainment in the future and that the number of themed SMs, that is, specialising in a particular subject, could increase.
- Transformation: In the interviews, the idea that SM investments may decrease over time, and some may be closed due to intense competition or economic difficulties, was dominant. In addition, these buildings can be transformed into different buildings (hotels, hospitals, etc.) by considering the customer needs, or they can be used as shared offices, congress centres, dormitories, marriage offices, dental health centres, cargo delivery centres, or e-commerce companies.
- E-Commerce: According to the participants, the issue of e-commerce will continue to be an important agenda item in the future as it is now. For example, P2 stated that "e-commerce, which has gained momentum in recent years, has adversely affected SMs, but some companies have balanced this by selling their merchandise both online and through their physical stores."
- Technological Developments: Developing technology (for example, navigating in different places with 3D applications) forces trade channels such as SMs to keep up with developments.

5.2. How the SM Idea Came to be Adopted in Türkiye

In this section, the factors affecting the importation and popularisation of the SM idea, the transfer process of the idea, how the SMs in Türkiye differ, how they are defined and classified by the participants, as well as the change efforts in SM practices and the factors affecting these efforts are discussed.

5.2.1. The Actors Leading the Foundation and Popularization of SMs

According to the data obtained from the participants, many actors, such as consumers, retailers, management-leasing and consultancy companies and investors, government institutions, construction companies, financial institutions, and NGOs in the sector, played an active role in establishing and expanding SMs. Most participants stated that although SMs have been transferred to Türkiye, this has emerged in response to a social need.

Regarding the customers, who are vital actors, P3 stated that:

(...) The first and most important factor in Türkiye is population. The second important factor is needs. The third important factor is trendiness. In other words, the most important thing in the spread of SMs is that we want to see the global brands in our cities. Everyone wanted to own them. So, there was already a demand. Seeing world brands in magazines and newspapers, people used to say they had these brands there but not here. That was in the 60s-70s. We wanted to see the things that were available abroad in Türkiye. It is an adventure that started there. (...)

As can be seen, the demands and expectations of consumers in this regard have played a vital role in the import and expansion process of SMs. Some participants stated that the developments in Türkiye have accelerated this process. For example, according to P20, SM investments have increased rapidly with the rise of the construction sector in Türkiye. According to P17, the differentiation and diversification of human needs and improvements in income levels paved the way for this as well. In addition (P3), the inability to produce enough places for street retailing because of the increased production of goods and services has also increased the interest in SMs.

P3 drew attention to investors and retailers:

Investors were also influential in this regard. (...) Based on their experiences abroad, when they returned to the country, they said, "Oh, why don't we do this? We can do it." (...) Brands also encourage this. Our textile manufacturers encouraged investors who could build these malls. They said, "We produce the merch; why don't you build an SM? There are such examples from around the world. Build the malls, and we will be in them." These are mostly the things that have come out of these conversations.

P22 highlighted investors' role in the popularisation and spread of the malls:

(...) If you have a land, research is done about it. What is this? They call it the "best use study". "How is this land best used?" When we look at that type of research, the sector in which the money you invested returned the fastest was the SM sector for a while. (...) The first 20-30 SMs that opened for the first time and made huge profits made good money, arousing everyone's appetite, especially the investors. And this was how SMs began to increase. (...)

Another remarkable point is the participants' statements on branding. Most of the participants stated that many businesses have been able to increase their number of stores by operating within an SM, and over time, they have become a brand and gained a corporate identity.

Emphasising the influence of many other actors and explaining SMs with the metaphor of a "chimneyless factory", P16 expressed his views on the issue as follows:

The state also enjoyed regular tax collection thanks to SMs and organised retail. In other words, SMs prevented irregular tax collection and off-the-record businesses. Because the stores and stands in the SM must go to the municipalities and get a business license, it helped both our state and local administrators (...). This is such a giant money-making machine that investors and retailers make money. Those who work in it make money. The city council make money. Our government collects taxes and makes money. In other words, SMs are factories without smokestacks (...)

5.2.2. The Transfer Process of the SM Idea

The first SMs in the modern sense, built in the USA in the 1950s, appeared in Türkiye towards the end of the 1980s. With the transition to a free market economy in Türkiye in the 1980s, investments increased, and obstacles to trade began to be removed. The findings indicate that, in this process, the experiences of many Turkish investors during their visits abroad played an important role in establishing the first SMs and that examples from abroad inspired the first SMs in Türkiye. P22 makes the following comment on this subject:

The first SMs built-in Türkiye started with examples from abroad. (...)

P2 made a comment supporting P22's statement:

Our architects, who generally do construction work... Let me put it this way: our contractors or the people who attempt to build an SM generally take more examples from abroad than from the domestic market; I can say this. (...)

Now let us look at the establishment story of Galleria Mall, the first mall opened in Türkiye:

In his autobiography titled "I Did Not Have Time to Seek Luck" (Bayraktar, 2004: 141-142), Hüseyin BAYRAKTAR, one of the founding partners of Galleria Mall, Türkiye's first mall, states that he began to look for new investment opportunities due to the favourable investment environment at the time and says that he made long-term plans on the empty land on the Ataköy coast, where Galleria Mall was to be built years later.

The ANAP (Anavatan Partisi / Motherland Party) government, headed by Prime Minister Özal, prioritised economic issues for the country's development. The economic indicators, which had been at a standstill for years, started to improve suddenly. Employment, production, and exports reached a promising level. Encouraged by this environment, I began searching for new investment options. (...)

Hüseyin BAYRAKTAR reports the process leading to the establishment of Galleria Mall as follows (Bayraktar, 2004: 144-150):

During my travels to America in 1975, I saw the big SMs in this country and wondered whether I could transport them to my country. While visiting Summit Mall in Akron-Ohio in 1975, the idea of Galleria began to take shape firmly in my mind. I wanted to implement similar projects in Türkiye because those big SMs were civilisation projects. We could use that, too. It was not a copy, either. It transferred a universal project, technology, and architecture to our country. (...) After finding the architect and forming the team, we went to the USA, examined the projects implemented there (...) and returned to Istanbul excitedly. (...)

To the question, "Was there any inspiration from examples in other countries in the architectural design or operational activities of the first SMs opened in Türkiye?" P23 responded as follows:

(...) They always inspired us. I can give this example: Although the architect of the Galleria was a Turkish man named Hayati Tabanlıoğlu, its investor was Hüseyin Bayraktar. At that time, they founded Lassa together with Sakıp Sabancı. Before establishing Lassa, they researched the chemical industry in the USA. When they go there, they want to bring the mall here because Dallas Galleria inspires them. Akmerkez's architects were American, however. But we also had a local Turkish architect. Fatin URAN. However, they were inspired by an American architect working at the Development Design Group (DDG) in Baltimore. (...)

Mehmet BAYRAKTAR states in an interview that he was inspired by many places and received consultancy in the establishment of Galleria Mall. (AYD, 2019: 184);

On the day the Galleria project was opened, there were no supply opportunities in Türkiye, especially human resources, to make it work with all

its parts. Inspired by the security guards wearing cowboy hats and sheriff's outfits at the malls in Texas, we dressed our specially trained security staff the same way. Since we had to solve all the business problems ourselves, we received "know-how" from abroad (on many issues). (...)

As can be seen, Turkish investors and state officials played an active role in opening SMs in Türkiye.

In his memoir (Bayraktar, 2004: 179), Hüseyin BAYRAKTAR states that sometime after the opening of Galleria, other partners started a disagreement with an excuse, and he was forced to sell his shares. That is why he founded the Carousel Mall, one of the very first malls in Türkiye.

He stated his idea of establishing the first outlet-style SM in Türkiye as follows (Bayraktar, 2004: 174-175):

(...) I wanted this investment to be "original", like my other investments. In other words, a new one would be added to Türkiye's firsts. I had an "outlet" in my portfolio. (...) We brought an "outlet" project from the USA. (...)

According to some participants, SMs have evolved after they were established in Türkiye, and most SMs have taken the form of activity centres and shopping places. The following is the comment made by P21 on this subject:

(...) Now, as Türkiye, we brought SMs from the world. We brought its basics. After we brought its basics, we shaped it according to the Turkish style. How did we shape it? We have shaped them as Life and Entertainment Centres.

After the establishment of the first SMs in Türkiye by domestic investors, international management/consulting companies also played an important role. These companies brought important information about SMs from abroad to the country and profoundly contributed to the sector's development. For example, P14 drew attention to foreign investment/consulting companies and stated that they transferred important knowledge from Europe to Türkiye.

Another critical issue is how the definition of the *mall* is created. The statements of some of the leading names of the sector in this regard are as follows:

We contributed to the clarification of the mall in the legal definition in the most recent law during the work carried out within the Ministry of Commerce (...) (P23)

We gave the legal definition to the state. We had an association called AMPD (Shopping Centres and Retailers Association). (...) The International Council of Shopping Centres, called ICSC in America, has certain criteria regarding the definition of SMs. We, as AMPD, translated these criteria completely into

Turkish from there and considered the standards in Türkiye. When this law was first enacted, they asked our association. We shared our internal work with the Ministry of Commerce, which was approved in a certain way. (...) (P22)

When asked whether the ICSC definition of the *mall* was taken directly, P22 responded:

There were no significant changes in the translation. But of course, if you do a one-on-one Google translate, it sounds ridiculous. Let us say it was translated according to the retail language in Türkiye.

It should be emphasised that although examples are taken on many subjects, this does not mean exact copying in every aspect.

5.2.3. How Türkiye Differs

Although some interview participants stated that SMs in Türkiye differ in various aspects, such as sociability, gastronomy, and security, most participants noted that the SMs operating in Türkiye maintain the global SM structure and standards. Below are some comments from the participants:

(...) We have more indoor parking garages. Of course, this is all about land costs. There is a lot of land in America, but our country's land plots are small. Therefore, building an indoor parking lot is necessary for big projects on those small plots. There are places of worship in our SMs. (...) You know, the prayer rooms are one of the things we have added. (thinking) Frankly, I do not think we have added much. Tastes related to gastronomy differ in Türkiye. There are doner (shawarma) shops and lokma makers inside. But have we changed anything structurally? No, they are all the same. (P1)
(...) I am someone who cares about differentiation (...). But (...) we offer similar experiences at the mall in Malaysia. (For example) Our working hours may change due to our cultural texture. It is just that the applications are changing, but I do not think the content has changed much. (For example) We make movies, and producers in Germany also make movies. We are both filmmakers. We both use movie theatres. In my movie, the landlord is mentioned. His movie is about a chemist's new experiment with the girl in the lab. But he is making a movie, and I am making a movie. (P20)

P10 stated that SMs in Türkiye, unlike the examples in other countries, are located more in city centres and have become an important part of life.

Stating that SMs in Türkiye have stricter security (X-ray devices at the entrance, detectors, etc.), P7 attributed this to the geopolitical position of Türkiye.

The points made by P3 on differentiation are also remarkable. According to P3, SMs established in European city centres are generally built on traditional shopping spaces where people gather. The aim is to "manage the existing crowd, that is, to benefit from the existing crowd". However, "These crowds, which are not common in Europe, are formed more and more easily in Türkiye." Also, "Türkiye stands out among the other nations in crisis management due to the many crises it has experienced."

Some other differences of Türkiye pointed at by the participants are as follows:

While there are generally no food markets, supermarkets, or hypermarkets in the American type of SMs, we built SMs where food and catering are strongly emphasised. (...) Also, we can observe that places with coffee shops and tea houses are adapted to our SMs because past inns, like the courtyard in the inns, influenced them. (...) (P23)

(...) They have their separate movie theatres abroad and do not have to be in a mall; there are cinemas in almost every SM in Türkiye. (P3)

For example, there is an obligation to give 1% of the SM (gross leasable area) to handicrafts on the verge of disappearing professionally. (...) It also exists as a law. (...) (P12)

Even though there is a shopping centre culture in the SMs in our country, I can say that we still maintain an artisan culture. I can say that this artisan culture in Europe is a little different. (P19)

5.2.4. SM Definition and Classification from Managers' Perspective

This section discusses how SMs are defined and classified according to the participants' perspectives.

5.2.4.1. Definitions of the Mall

In the interviews, the participants made different definitions of SMs. Let us have a look at some of these definitions:

SMs are multiple building systems under a certain roof and a certain management. (...) (P5)

SMs are the peak of the retail industry. (...) (P7)

(They are the places) where supply and demand are brought together. (...) (P13)

P23 defines the SM system as "municipalism by the private sector". SMs are also defined with the metaphors of "town" or "trade ship" (P2, P3).

All 23 participants defined SMs from different perspectives. However, 3 of the 23 participants stated that although they made a specific definition of SMs, it would not be

possible to have a standard definition that could represent all SMs in the World, considering the great diversity.

Table 2 shows the mall characteristics of the participants' attention when defining SMs.

Table: 2
Contents in SM Definitions

	Shopping Area (Product/service variety, "brand mix", etc.)	Socialising Area	Area with Certain Architectural Features (Structural integrity, m ² , etc.)	Management Area (Rules, not selling stores, etc.)	Retail Area / Trade Centre	Comfortable Space (Security, cleaning, air conditioning, etc.)
P1	√		√	√		√
P2		√	√			
P3	√	√	√	√	√	
P4	√	√	√		√	
P5	√		√	√		
P6	√	√	√			√
P7	√				√	√
P8	√	√				
P9	√	√	√	√		√
P10	√		√			
P11			√			
P12	√	√				
P13	√	√	√	√	√	
P14	√	√		√		
P15	√	√				
P16	√	√				
P17	√	√				
P18	√	√				
P19	√			√	√	
P20	√		√	√	√	√
P21	√	√	√			
P22	√	√	√	√		√
P23	√	√	√	√	√	
Total	21	16	14	10	7	6

As can be seen in the table, the most prominent subject in the definitions is *shopping*. Sociality, architectural features, management style and features, retailing, and comfortable space elements follow Shopping.

5.2.4.2. Classification

The classifications reported by the participants show parallelism with the global mall types and characteristics. However, while shopping places with a gross leasable area of less than 5000 m² in Türkiye are not considered SMs, P2, unlike other participants, says that shopping spaces with a gross leasable area of 1000-4000 m² are not considered SM. Still, these are classified as small shopping centres.

After the SMs were opened in Türkiye, different constructs emerged. In an interview, Avi ALKAŞ stated the following on this subject (AYD, 2019: 198):

Olivium, the first urban "outlet", emerged as a new concept as a mix of SM-outlet, which we can call a Turkish model hybrid. The concept of "outlet",

which includes many SM services, has emerged. I think it also significantly impacted the urban transformation of Zeytinburnu. Afterwards, it formed the starting point of the municipality's square movement. Later, we continued this model with the Optimiums (malls) of the Renaissance.

Another important finding is that the concepts of small, medium, and large-scale SMs vary from person to person based on m². For example, while P2 defines a shopping centre with a gross leasable area of 30 thousand m² or more as a large-scale shopping centre, according to P6, shopping centres with a gross leasable area of up to 50 thousand m² are small-scale shopping centres. Since SMs in Türkiye are not yet legally classified according to their size, there is no consensus among the participants. The statements of P22 indicate that a legal arrangement regarding this point may be made shortly:

(...) Now, our problem is this: standardising SMs. Just as there is a star system for hotels, we also intend to establish one for SMs. To get a certain star, a mall must raise its standards accordingly. (...)

5.2.5. Change Efforts, Factors Limiting Freedom and Differences

20 of the 21 SM managers declared that they are trying to differentiate the SM they work with from other SMs and carry out their activities in line with this purpose. The participants stated that they try to make a difference compared to other SMs with their innovations in service quality, advertising, and promotions. The findings show that many factors prevent managers from changing, which can be listed as follows:

- Expectations of Investors/Shareholders or Management/Consulting Firm Undertaking SM Management
- Retailers' (Tenants') Expectations
- Consumers' Expectations
- Stakeholders' Expectations
- Laws and Regulations
- Job Description and Authorizations
- Economic Conditions (Budget)
- Customs
- Difficulty of Architectural Changes

According to the answers given by the participants, the distinguishing features of the mall where they work from other malls are as follows:

Table: 3
Distinctive Features of SMs

P1	<ul style="list-style-type: none"> ▪ Large and comprehensive theme park ▪ Manager's academic knowledge
P2	<ul style="list-style-type: none"> ▪ Large theme park ▪ The mall has two main entrances ▪ Valeting Service
P3	<ul style="list-style-type: none"> ▪ Large theme park ▪ Comfort ▪ Size
P4	<ul style="list-style-type: none"> ▪ There is no obvious difference
P5	<ul style="list-style-type: none"> ▪ Comfort ▪ Generally, appeal to families
P6	<ul style="list-style-type: none"> ▪ Size ▪ Aesthetic
P7	<ul style="list-style-type: none"> ▪ Large theme park ▪ Comfort ▪ Location (By the sea)
P8	<ul style="list-style-type: none"> ▪ Size (Although it's an outlet) ▪ High power of attraction
P9	<ul style="list-style-type: none"> ▪ Use of alternative energy sources (Solar energy, generating electricity from natural gas)
P10	<ul style="list-style-type: none"> ▪ It is covered with glass (In this way, electricity can be saved)
P11	<ul style="list-style-type: none"> ▪ Having a retractable roof
P12	<ul style="list-style-type: none"> ▪ Investors from that region
P13	<ul style="list-style-type: none"> ▪ Bitcoin ATM (<i>Automatic teller machine</i>)
P14	<ul style="list-style-type: none"> ▪ Consisting of streets ▪ Spaciousness ▪ Having a nostalgic tram inside
P15	<ul style="list-style-type: none"> ▪ Being a student dormitory on one side
P16	<ul style="list-style-type: none"> ▪ Presence of restaurants that are independent of the main mass of the SM but adjacent to the SM ▪ The mall has a tower
P17	<ul style="list-style-type: none"> ▪ Spaciousness ▪ Having indoor and outdoor parking
P18	<ul style="list-style-type: none"> ▪ Good location ▪ The inside of the SM receives enough daylight (In this way, electricity can be saved)
P19	<ul style="list-style-type: none"> ▪ Management concept (Being sincere to customers like a tradesman)
P20	<ul style="list-style-type: none"> ▪ The mall has stores in both indoor and outdoor areas ▪ Originality of architecture ▪ Large area of activity
P21	<ul style="list-style-type: none"> ▪ Flexibility in some rules ▪ Strong communication with store managers

Some significant data were also obtained on translating the SM concept at the micro level in the eyes of SM managers. The results show that the participants' philosophy, beliefs, and moral values directly impact many decisions and activities.

P5's statements on this issue are noteworthy:

For example, a girl and a boy cannot kiss in my SM. I will get them out of the mall right away. Someone else may overlook it. Children come to our mall but cannot run around in the halls because security prevents them. Why? Let us say an older person is coming from the opposite side. In front of them, the child comes running around. What will he do? (...)

Another participant (P17) highlighted public health and social projects:

(...) I always attach importance to public health. People can also learn something when they come here. I try to show that it is not just a place for shopping. My management approach has always been this way. (...) I do not

know... Measures to be taken against cigarettes, cancer, violence against women... I care about social responsibility projects. (...)

P18, on the other hand, explained his sensitivity to women's rights through the activities she held on 8 March Women's Day.

You know, on March 8, on International Women's Day, pictures of women who have been subjected to violence are displayed, and pictures of helpless women are exhibited. (...) For example, we exhibit the paintings of women who add value to the economy instead of women subjected to violence. (...)

5.3. Factors Impact the Diffusion or Translation of the Malls

The participants were asked about standardisation and differentiation to determine which diffusion or translation processes dominate SMs in Türkiye. 18 of 23 participants stated that imitation and standardisation among SMs predominate, and five noted that change, that is, differentiation, is dominant in the malls. Another finding is that imitation and standardisation among SMs occur similarly. According to the participants, SMs are inspired by each other in many subjects, from architecture to interior decoration, from event organisations to campaigns, and sometimes they even try to copy them. Here are a few examples from the data related to this subject:

(...) In real terms, looking at a model, they say: "Oh, that model is gorgeous; let's make the same model." This model is where I work now. They tried to copy Forum Bornova directly for the place where I work. They tried to copy Forum Bornova SM in Izmir (when building my workplace). (P1)

(...) Of course, different places are also looked at in SM architecture. For example, ours was likened to Kayseri Park SM. In terms of management, other SMs were examined, and some examples were taken. (...) So, it would be best if you considered these examples. (P12)

(...) The SM I am at is an outlet made by taking an example from another SM. (...) (P13)

Some participants (P10, P16, P20, P22) discussed the topic of imitation/inspiration by saying, "You do not need to rediscover America."

Again, most of the participants stated that SMs are similar to each other in terms of management. For example, P11 said:

(...) Malls are administratively similar. All malls are managed the same way, all of them. The architecture may be different, the brand concept may be different, but the management job is the same. In other words, you are the same driver if you get into a Volkswagen today. If you get into a Peugeot, you are the same driver. In other words, there is no difference in driving or managing. (...)

In this section, the issues of imitation/standardisation and change/differentiation among SMs have been examined, and standardisation has been shown to predominate. It is time to focus on the factors that emphasise standardisation or differentiation and, thus, the diffusion or translation process, respectively.

5.3.1. Management Being the Same

SMs can be managed by the holding/group they are affiliated with or by management/consulting firms for a certain fee. However, there are also SMs owned and operated by some management/consulting firms. The results show that SMs affiliated with the same group, same company, or duplicate/management consultancy firm have relatively similar structures and management styles. This indicates that the concept of diffusion is stronger among these SMs. Because a particular concept is created from the same source, it is also applied in other SMs connected to them. Let us take a look at some examples given by the participants:

(...) Here is a group called Fashion Design Outlet. They have SMs in different countries; they are all the same in Europe. (...) (P20)

(...) SMs built and managed by the same group are similar in design. (...) (P5)

(...) All of Rönesans Holding's SMs are almost similar to each other. (...) The SMs operating under the name of Optimum are especially similar to each other. Where? First Ankara Optimum... When you go to Ankara Optimum, you will see an ice rink. You will see an ice rink at Adana Optimum and Istanbul Optimum. (...) (P16)

According to some participants (P13, P22), one of the reasons why SMs affiliated with the same management/consulting firm are similar is that these companies generally follow policies to include the same brands. Of course, this policy is because these companies want to market the places they have difficulty renting together with the places they can easily rent out. In this regard, the examples given by P13 are remarkable:

(...) (For example) There are 5 SMs that you provide management consultancy. 3 of the 5 SMs you provide management consultancy are in good condition. They are good places, well located, and have a good shop mix, but the two are bad. (When a company wants to rent the stores in your SM) You say, "You have to open them in 5 of the 5 SMs." "No, I want to open on only 3 of them," they say. "You cannot open only in 3 of them, sorry, if you get in all of the 5, you can," you say. (...)

P1 explained their administrative similarity as follows:

(...) In terms of marketing and management, there is a centralised structure. For example, today, when the Minister of Interior comes out and orders something, all the governors do that, and we do the same thing.

Another critical issue is the architectural designs of SMs. According to the findings, significant companies operating in SM architecture in Türkiye whose designs are similar. For example, P17 said:

(...) If you will build a professional, corporate, medium-sized SM, 3-5 architectural firms in Türkiye already do this job. Big-name companies. For example, A Tasarım. This architectural office drew perhaps one-third of the SMs in Türkiye. Of course, these drawings are similar to each other.

5.3.2. Brands Being the Same (Uniformity of the Brands)

According to the findings, another issue that highlights the similarity between SMs, and therefore the concept of diffusion, is the brands operating within the SMs. Accordingly, SMs with the same brands exhibit more similar features than other SMs. In addition, the low number of brands operating in Türkiye makes SMs more similar in content. For example, according to P3, brands are very similar in every SM due to the low number of brands in Türkiye.

(...) In other words, there are a maximum of 200 brands in Türkiye. So, there are no 1000 brands, so 200 would be in one mall and 150 in another. The same brands go everywhere. What happens then? They have no attraction. Then, they try to attract customers with marketing, and they try different things. (...)

P8, on the other hand, stated that some domestic investors who had recent financial difficulties went bankrupt. Therefore, the similarity between SMs was more evident with the decrease in the number of brands operating in SMs.

According to P19, brands owned by SMs of similar scale have a stronger resemblance.

According to some participants, retailers often make a joint decision to operate in a new SM. This is an important factor in the similarity and differentiation of SMs. For example, let us look at P13's comment:

(...) Do you know the most important rule here? The bush telegraph. Advertise as much as you want and say things like "The mall is doing great; the mall is the best." no one will believe it. But one or two companies that do a good job go to the other company and say: "Come on, let's get in there; look, it is nice there." they all get in. This is what I understand... In Türkiye, these actors are just a handful. When one of these actors gets in, all ten get in simultaneously, and these are the big players. Feasibility studies and such, they do not mean anything. (...)

According to another participant (P2), some brands can take positions relative to each other.

(...) Kişili says, "I would not go anywhere but next door to LCW. That's my principle." Whichever LCW you go to in Türkiye, Kişili is either next to it or it is not in that mall. (...)

P5, from a macro perspective, stated that the presence of global brands in most SMs in the world creates similar structures.

(...) Carrefour is a French company. It is the same model all over the world. It varies according to their size. There are medium-large scale Carrefours. But when you go to the store blindfolded, for example, if you go to a nut aisle there, the chocolate aisle, or the meat aisle, and if you know Carrefour in Türkiye, you will find whatever you want there as if you put them there yourself. (...)

Some participants say most global brands prefer SMs that meet their standards. For example, P3 states the following:

(...) All the malls that bring national/big brands are more or less similar... You look a little alike since national brands seek those standards in you. So, a trademark - for example, a Spanish or US company or a chain brand abroad - goes to places where it can see its standards. Well, that clears up some differences. It means that the SMs where they are located are similar to each other in some standards.

5.3.3. The Flexibility of the Idea in terms of Change

Another critical issue highlighting the spread and, thus, the similarity among SMs is that SMs are established by similar structures and activities in technical and strategic issues. In other words, SMs are built according to some forms with predetermined boundaries and features. They also carry out similar practices in many fields of activity, such as marketing and leasing policies. Most participants think the most critical factor that reveals these similarities is the experience gained over time. For example, according to P13;

(...) You cannot change the structure very much in SMs. (...) So, you cannot break that bone; it has become ossified now.

However, P20 stated that open-concept SMs offer more opportunities for differentiation.

Some participants, making a general observation, pointed out some standard features of SMs and said that SMs have similar characteristics worldwide. For example (P19);

(...) The rules for SMs in many parts of the world are almost the same; I can say there is a certain standard. There are many different types of SMs, but the general standards of SMs are almost always the same.

P21 made similar statements:

(...) Looking at the world, yes, shopping is a basic form. So, what is it? Classic stores... Women's, men's, children's, sportswear, food markets, electronic markets, optics, diamonds, gold, cosmetics... These are the stores that form the basis of shopping. These are indispensable and exist in SMs all over the world. (...) Places such as cinema, children's entertainment centre, bowling... These are also some basic features. Now, what would be the next level of that? They built an SM in Dubai and a ski resort on its roof. Now, that takes it to the level of entertainment. Dubai's weather is scorching, but you can ski on the roof. (...)

Some similar structures and practices in SMs are summarised according to the data obtained from the participants.

- There should be no intermediate corridors in SMs.
- Since goods are received in SMs from the car park or the ground floor, these floors generally have higher ceilings than the middle floors. Another aim is to deliver products purchased from DIY stores to the parking lot quickly. In addition, the food court floor is built close to the roof (to be close to the chimney due to smoke) and has higher ceilings (to reduce the smell of food, noise, etc.) compared to the mezzanine floors.
- Column spaces, corridor spaces and areas reserved for stores in SMs are generally designed according to specific standards. For example, P22 stated the following: *(...) In such an architecture, a column is placed approximately every 8 meters, with a maximum spacing of 16 meters. In such an architecture, you have to go square by square or rectangular by rectangle. If you do not do this, the view can be beautiful architecturally, but you lose a lot of space. (...)*
- Legal obligations can also shape SMs. For example, shopping places with a sales area of less than 5000 m² do not qualify as SMs. In addition, SMs must have areas such as a baby care room, prayer room, and emergency medical intervention unit.
- There are also sections for management room, security room, cleaning room, boiler room or heating/cooling systems in SMs.
- Floor layout in SMs is created similarly in line with marketing strategies and needs. For example, important brands are placed on the top and bottom floors of the SM, and foot mobility is created for the stores on the mezzanine floors.

According to P2, this order is also related to "correct management", and the system is generally set up in this way in every SM:

What can you do to revitalise the lower floor of the SM? It would be best to put a store where people must go. What should I put there? I put Migros there; what else can I put there? Every mall is the same; many malls are 90% the same. This is not imitation. This is "correct management", that is, what it should be. "I want to be different." Do you know what will happen if I put Migros upstairs or put another store downstairs? You cannot do business. You cannot work at all. People do not go upstairs for Migros. How will those shopping carts go down? Have you ever seen a fast-food restaurant downstairs in SM and Migros upstairs? You cannot see that. This is the system. (...) This is what should happen.

- SMs are generally built with a small number of floors. Since multi-storey buildings will tire the customers, creating more than four floors is generally not preferred.
- Important "anchor stores" are located on the corners of SMs.
- Sectoral positioning is practiced in SMs. In other words, stores and areas that will support each other and create synergy are positioned to be adjacent.
- By using marketing activities, SMs generally hold events on important days such as official and religious holidays.

In addition, most participants emphasised the cultural and physical similarities of the SMs. They stated that SMs directly impact the culture of the places where they are established, significantly change social institutions, and spread the global SM culture to the local communities. For example, P17 said the following:

(...) The SM changes neither physically nor administratively. On the contrary, it makes the local people keep up with it. Take Starbucks, for example. Until Starbucks came to Türkiye, people would not go and get their coffee by getting in line. But right now, people get in line to get their coffee. Also, Starbucks is jam-packed with people. People sit, take pictures, take selfies, and post them on social media. This, for example, has changed our understanding of the cafeteria. (...) In other words, SMs make the people of the region they go to adapt to them.

And highlighted the effect of malls:

(...) Malls have influenced our culture. For example, before SMs were opened, New Year's Eve was unimportant in our Turkish culture. Whichever SM you visit today, you will see pine trees, decorations, and Santa Claus. (...)

P3 shared his observations as follows:

(...) In the past, Syrian boys were dressed badly when we first opened the malls. Well, now, ladies and girls, come here, you know. I mean, even those boys are dressing more stylishly now. They also used to have loud conversations among themselves. Now I see that they want to talk to the girls

at the mall and try to have a dialogue with them (So) they pay more attention (to how they talk). (...)

P4 made another interesting comment:

(...) No matter where this system (Mall) goes, no culture can prevent it. (...) (This is) because SMs are structures that spread their own culture. This is the same in Türkiye and in the world.

5.3.4. Status of Competition

According to most participants, one primary reason SMs resemble or differ from each other is competition. Accordingly, while the effects of diffusion are seen in market conditions where competition is weak, the concept of translation gains prominence due to the need for differentiation in the opposite case, when there is intense competition. First, let us turn our attention to the relationship some participants established on competition and differentiation:

Where there is competition, there must be differentiation. (...) (P7)
The early SMs were very similar, but because those built in recent years are more competitive, they must differentiate. (P11)
(...) Where there is no competition, the service may remain poor. But if there are two SMs in the same area, they can differentiate to attract more customers and offer more services. (...) (P9)

As can be seen, the concepts of competition and diffusion develop inversely. According to the findings, similarity and diffusion were more obvious due to the gap in the sector, especially in the first years. For example, P5 said;

Initially, the pattern is "copy-paste" or "follow the leader". So, here you copy-paste without overthinking. But after a while, you see that "copy-paste" does not work anymore due to competition. (...) You start to differentiate things. (...)

5.3.5. The Effect of the Environment

The findings show that environmental factors are some of the critical factors determining the differentiation or similarity of SMs, and therefore, which of the concepts of translation and diffusion will be emphasised. Accordingly, geographical position, climate, culture, and demographic structure play a vital role in shaping SMs, and similar types of SMs emerge among similar regions. Most participants stated that although there are remarkable similarities in general, a different typology is observed in each country. Therefore, the translation effect between countries is more pronounced and stronger due to different environments.

The participants also stated that while planning an SM, another mall can be taken as a model. However, this is only possible if they are of a similar scale and environment.

Now, let us examine the critical environmental factors in the diffusion and translation of SMs, respectively.

5.3.5.1. Demographics

The most crucial issue mentioned by many participants is that SMs are affected by the demographic structures of their region. Accordingly, SMs are designed and operate according to many different variables, such as the interests and demands of potential consumers, the region's population, and the region's income and development status. P12 pointed out that the current demand determines whether an SM will be opened in an area. In addition, P14 also stated that the products and services to be offered by SMs should be determined according to the targeted consumer group. P1 reported that they conducted extensive feasibility analyses before opening the malls. Some participants stated that despite all these feasibility analyses, they still had to make changes to address different needs and demands even after opening the mall. The most important factor at this point was consumer demand. For example, P10 stated:

(...) There may be some demands and changes after opening a SM. If you ask me why... Let me give a severe example. Since we opened the mall, we have added two new escalators and two elevators. Customer behaviour has driven us to do just that. Before the opening, everything seemed great, but after the opening, we noticed our shortcomings. After the opening, customer demands are different. (...)

Another critical factor is the population of the region where the SM is planned to be opened (P13). Of course, population is not the only key factor in this matter. For example, P2 stated that SMs are to be established in regions with different levels of development, even if they are located in areas with similar populations.

5.3.5.2. Location

Some participants emphasised factors such as climate, geographical features, and social development depending on the location in planning and building SMs. For example, P2 stated:

(...) In 2012, Movapark Mall between Kızıltepe and Mardin was opened, an open-top SM... It is located midway from these towns, 10 km from Kızıltepe and 10 km from Mardin. A SM, open to all sides, next to the airport. It was always exposed to wind, dust, smoke, and storms. Cleaning was done during the day, but 5 minutes later, it got dirtier again. Then, the whole place was covered in layers of dust. Cleaning was done in the evening, but everyone could count your steps because of the dust outside when you walked into the

mall the next morning. That is how much dust and dirt there was... If it rained, the mall would flood. Within a year, they had to cover the mall. A was based on a wrong model, and some wrong choices were made. So, now it is fixed. (...)

P10 stated that SMs operating in the same region and during the same period would be like each other because they are affected by legal or technological developments. Therefore, various mall structures have emerged in Türkiye depending on the developments in different periods. This makes diffusion prominent among the SMs operating in the same period. For example, P11's comment on this issue is as follows:

(...) Think of it like a generation. (For example) My father's generation, my generation, my son's generation, my grandson's generation and so on. Malls of the same generation are also similar to each other. (...) In other words, those who are close to each other in age. (...)

Another example in this regard is the legal standardisation of the definition of the SM in Türkiye. For example, most buildings defined as SM before the legal regulation on this subject were excluded from this status because they did not meet the specified conditions. Thus, this legal development has made SM structures in the same geography more homogeneous.

The findings also indicate that since there is a strong organisational bond between SM managers operating in the same geography, managers support each other in most of the activities they carry out. This brings similar practices in many areas, especially in operational activities. Therefore, from a macro point of view, SMs in Türkiye bear a stronger resemblance than those operating in other countries; that is, the diffusion process within Türkiye is more straightforward. A statement made by P14 on this subject is as follows:

(...) Our 450 SM managers have a WhatsApp group. In other words, when something happens in an SM in Ağrı⁴, I learn about it within five minutes and take immediate action.

5.3.5.3. Culture

Another critical factor in the similarities or differences between SMs is culture. The findings show that the culture in which SMs operate affects many issues, such as determining the external architectural structures, working methods, and the products and services they offer.

P5 explained the effects of the organisational environment on the mall as follows:

⁴ It is one of the most eastern cities in Türkiye.

(...) For example, SMs in Istanbul only close for half a day during the holidays. But I am in Konya⁵. Eid is an important factor here. Therefore, I completely closed on the first day of Eid. I close for 1.5 days on Eid-al-Adha. If the stores in SMs open at 10:00 in the morning and close at 10:00 in the evening almost all over Türkiye, they must be open during this period and continue their activities. Well, now this is Konya. Men attend the Friday mass prayers here. What are we supposed to do? The shop owner closes his shop and goes to the mosque. Whether you like it or not, he will go there. What do you do then? You get flexible. Know what I mean? So, we closed the shop on Friday and went to the mosque. (...)

P11, on the other hand, shares a memory as follows:

(...) I worked in an SM in Iskenderun. Its owners were among the city's wealthiest and best-known businesspeople. And these guys loved sushi. They said, "There will be sushi in my mall, too". So, we opened a sushi restaurant. But of course, it failed because the locals in Iskenderun did not care about such a taste. They had never eaten anything like that. (Sushi) is served in Istanbul and Ankara; it is available in metropolitan cities. (...)

5.3.6. Having the Know-How

The findings show that the actors' knowledge level is important in the SM dissemination or translation processes. It was observed that translation processes were dominant in cases where the level of knowledge was high, and in cases where it was low, the diffusion processes were dominant. For example, most participants said that the SMs established in the first years were more similar because they did not have profound know-how, and they quickly put ready-made SMs into practice. P20 stated that;

The early SMs were more similar. (...) Because it had not been tried before and was not widely known, it had to be done in the most practical and fastest way. Things started to change after that; now we have the data. (...) We did not know about them before. In other words, we were trying to build 50 thousand square meters of SMs everywhere. Or we were trying to build 20 thousand square meters of SMs everywhere because we did not know any better. We thought that the mall should be like this.

According to some participants, many SMs were opened quickly from the beginning of the 2000s until 2015 due to the favourable investment environment. The haste and insufficient knowledge of most investors to spread an SM quickly created diffusion during this period and in the early periods. For example, P14 stated the following:

⁵ It is one of the most conservative cities in Türkiye.

In the early years, imitation was more common. In the decade between 2005 and 2015, there was a lot of imitation because there was no time to waste. So, we looked at them, we tried to be different, we did something different to differ from them... No. Everyone looked at each other and did so quickly. Because they had to do it quickly, they quickly built their SMs. Later, they began to try to separate.

P16 added the following:

Between 2000 and 2010, this was a trendy investment. So many SMs were built during this period but can no longer sustain their popularity. (...)

P17 emphasised the manager's experience in copying other SMs:

In other words, this is a bit about the manager, the manager's self-disclosure... For example, I used to do it in my youth, in the first years of my management. I would visit the SMs in Istanbul, take pictures, copy-paste them, and apply them to my SM. But these are not enough. After a point, you feel the need to do different things. (...)

However, some participants stated that although SMs take each other as an example, differentiation can be seen in the details. For example, P2's statement on this issue is as follows:

(...) We differentiate the standard in SMs with minor retouches. People like diversity anyway. In other words, similarities in basic issues and differentiation in details are important.

6. Discussion and Conclusion

Drawing on the translation concept of Scandinavian institutionalism, this study analyses how the idea of SMs was reconstructed during the introduction of the SM in Türkiye, the influential actors and their role in this introduction, and how SMs have developed and evolved. In addition, the other primary foci of the study are how SMs differ from each other over time and which factors affected this differentiation.

The findings show that SMs have similar functions to traditional shopping places but differ significantly in many respects. However, some participants stated that traditional shopping venues are a source of inspiration for SMs and that the idea of SMs emerged as an improved version of the shopping venues in the past because of modernisation.

According to the answers, many actors played an active role in the importation and rapid increase of SMs in Türkiye. However, SMs were introduced to Türkiye in response to a social need, with population growth, consumer behaviour and needs changes, and social developments triggering. Therefore, consumers can be seen as one of the most influential factors in the import of SMs. Translation studies pay special attention to idea carriers such

as management consultants, publishers, gurus, and business schools in transferring ideas from one place to another and focusing on the actions of these actors. However, the findings indicate that the consumers provide a large part of the energy and motivation required by the idea carriers during the translation process of the SMs. Therefore, in the early periods, Turkish consumers acted as "idea bearers" in importing the idea of SMs.

The findings further indicate that four generations of SMs have been formed in Türkiye. In the early days, wholly closed SMs with rows of shops and low-rise SMs were built and opened, and then multi-storey SMs offering food, beverage, and cinema on the upper floors were introduced. Later, with the smoking ban in indoor areas, SMs with more open areas such as balconies and terraces, and finally, SMs integrated with the street, allowing shopping in open areas and offering more sophisticated entertainment options, have become widespread. SMs have changed and developed in many aspects over time. The participants also stated that SMs will alter many aspects.

Counter-intuitively, the findings point out that during the initial placement of the SM idea in Türkiye, the idea was primarily limited to management and structure, and there were no significant differences in the fundamentals. This can be explained through the diffusion of institutional theory or the concept of duplication put forward by the translation perspective of Scandinavian institutionalism. Thus, "If an application's components are technical and articulated, copying is foreseeable because the application is less transformable (Wæraas & Sataøen, 2014: 245)." "Diffusion can be considered as a more appropriate form of interpretation in cases where a certain policy is dominant, and the disseminated ideas are technological innovations with relatively well-defined uses (Johnson & Hagström, 2005: 384)." As a result of these ideas, examples from abroad were taken as a model in the early periods, and the structure was implemented without changing it. It can be said that this resulted from many factors, such as the lack of know-how in Türkiye in the early periods and the lack of trained staff in this field, as many of the participants mentioned. In addition, the strong similarity, that is, the isomorphism, that emerged between the organisations, especially in the early periods, occurred due to a tendency and will to preserve an existing successful structure or maintain legitimacy (Boons & Strannegård, 2000: 15). The results do not fully support the notion that every translation is a unique and reconstructive process (Czarniawska & Joerges, 1996). The idea of reconstructing and recreating every idea in the transmission process will occur in every idea without exception, which may be seen as an overly assertive statement. If such recreation were the case, many different SM structures or management styles would have emerged in Türkiye. However, it is remarkable that SMs in Türkiye have not undergone a significant change in ideas and structure in more than 30 years. Indeed, this does not mean that the idea of an SM has not been translated in any way. For example, while there are almost no food markets, places of worship or security points at the entrance the SMs in the USA, which is taken as a model, the fact that these elements are present in most shopping centres in Türkiye, including the first SMs, is an indicator of this. In addition, while the effect of diffusion was great early on, some differentiations were observed in the following years due to the organisational environment. For example, since SMs are located in city centres, and some are built with buildings such as residences, hotels,

and entertainment centres, they have been transformed and become widespread as socialisation and activity centres besides shopping. The concepts of diffusion process and isomorphism fall short of explaining the hybrid mall concept of the Turkish model, which is designed as a different SM version as a combination of SM and outlet. The differences among the managers' perspectives are also striking. For example, while some participants think that SMs should have a mission in the educational growth of society, some managers perceive the SM as a non-governmental organisation that takes the initiative in many areas, such as women's rights, in addition to being a shopping and socialising place. It was also observed that some managers act in line with their own beliefs, values and philosophical stances in the decision-making processes regarding the SM rules. Another differentiation, for instance, is related to the definition and classifications of SMs expressed by the managers. Despite many similar statements, viewed at the micro level, 23 different definitions and classifications were made. Despite all these, it is possible to say that there has not been a significant change in the idea and structure of SMs in Türkiye, based on the findings. For example, most of the participants mention many standard practices and a ready-made SM format among the SMs in the world. In addition, the existence of a common global SM culture and the direct impact of this on the local cultures and social organisations of various countries was often mentioned. Of course, SMs are affected by the elements of the organisational environment in many respects.

Although almost all the participants expressed their interest in change, this does not seem possible due to the predominance of standardisation. The participants generally stated that they try to make a difference compared to other SMs with their innovations in service quality, advertising, and campaigns.

SM classifications and definitions are similar in most countries in the world. For example, in Türkiye, during the creation of the legal definition of the mall, the ICSS definition of an SM was taken as an example. Of course, it is worth remembering that a richer and more developed SM structure is formed in some economically developed countries such as Dubai or Singapore.

One of the important findings is related to the evolution of SMs over time. The concept of translation generally focuses on the interpersonal transfer of ideas and neglects the concept of time and social structure. For instance, the change in the concept of SM, which has shifted from simply shopping to socialising and entertainment, was not abrupt, that is, with a momentary transfer between people. The development and changes of shopping places over time can be an example. Another example is the perception and purpose of using the "phone" object between the current society and the society 30-40 years ago, although the basic functions remain similar. As seen in these examples, a cumulative and collective translation process rather than one-to-one is also possible. In other words, besides being an event that takes place between people in the short term, translation can also be a phenomenon between societies living in the same region but in different historical periods and spreads over time. In this process, which we can call "Collective Translation", ideas can be transferred not only from person to person but also from one group to another

or from one generation to another over time. Intergenerational differences, such as perception, purpose, and value, can also be mentioned because society's perception, goals, and ideas naturally change over time. Therefore, a social translation process between two social consciousnesses is also possible. In addition, ideas can be perceived differently at different times, not only in passing from person to person but also in one's inner world. What a person understands from the SM today and what s/he perceives tomorrow or 20-30 years later may be different. When the person's perceptions, mindset and ideas change, the person can go through other translation processes. Here, we can think of someone who, in his/her youth, had ideologies close to socialism, but over the years, s/he became more sympathetic to capitalist ideas. The SM perception of this individual in his/her youth will not be the same as the SM perception formed in another period of his/her life. Further, any business manager's ideas about a management practice (total quality management [TQM], management by objectives [MBO], etc.) may change over time. Therefore, it is possible to logically infer that individuals can go through a mental translation process in the said process. Considering all these, the translation process is not only interpersonal, but the scope of the "translation" concept should be expanded to include

- Individual Translation,
- Interpersonal Translation, and
- Social Translation (Collective Translation)

and the concept of "translation" needs to be expanded to include these three dimensions.

Another important finding is that ideas are not exposed to the effects of mere diffusion or translation during their journey. It was also found that SM diffusion or translation has occasionally emerged in Türkiye. In the first years and the period from the beginning of the 2000s to 2015, the effects of the spread can be observed more strongly. The years when SMs were first built - from the late 1980s to the early 1990s - was when Türkiye opened up internationally with the transition to the free market economy, the economic dynamism was powerful, and the migration from the village to the city was intense. Likewise, from the first half of the 2000s to 2015, the economy increased, a very convenient investment environment was created, and there were years when the migration from the village to the city continued, although not as much as in the first periods. The rapid increase in SMs in these periods and the strong diffusion mechanisms can be explained by such reasons. Apart from these periods, the concept of translation is more prominent with differentiation. For example, the implementation of the smoking ban in indoor areas enabled the creation of terrace areas in SMs, and the expansion of these areas over time and their opening to different uses contributed to the translation process, which resulted in SMs' perception as a socialising place as well as a shopping place. However, it can be concluded that, theoretically, there is a translation in every diffusion process and a diffusion in every translation process. Of course, one of the processes of translation and dissemination may predominate.

The only difference between institutional theory and Scandinavian institutionalists is their distance from the facts, that is, their point of view. Scandinavian institutionalists can be described as institutional theorists with a magnifying glass in their hands. According to an institutional theorist, for example, a standard mall and an outlet-style mall -or any other type - can be viewed as the same structures from a structural and managerial perspective. While a Scandinavian institutionalist finds many micro-level differences between the two structures, s/he can view the outlet model as a translated form of the SM. Thus, the problem is the rate of change in transferring ideas. In other words, it is unclear how much a change in an established idea can qualify as diffusion or translation. When it would be almost impossible to make a precise judgment and measure the change, talking about relativity may not be too trivial because the concepts of diffusion and translation cannot be separated with clear boundaries. Therefore, "There cannot be only one truth in the social sciences." These two phenomena should not be considered independent. They should be seen as complementary concepts because such differences of opinion are directly related to how the world is viewed and how events or phenomena are perceived. When we look at the literature in the field, we observe that the diffusion and translation studies are generally carried out separately. Commenting on an issue based only on one point of view may result in an incomplete assessment because, although both a micro and a macro perspective have strengths, both have some weak and ambiguous aspects. For example, the translation approach is a perspective that makes it difficult to analyse. It can push the person into a relative process where answers can never be given by drowning them in detail and taking them out of the context of the researched subject. On the other hand, the concept of diffusion cannot fully explain the changes during the transfer of abstract or embodied ideas from one place to another. It usually focuses on the big picture and often misses the details. Therefore, approaching the events only from a macro perspective often renders the analysis inadequate.

According to most participants, SMs are inspired by each other in many aspects, from architecture to interior decoration, from event organisations to campaigns, and sometimes they even try to copy each other. Therefore, the findings show that diffusion, rather than translation, plays a strong role in SMs in Türkiye. It was also observed that multiple variables shape the prominence of the dissemination or translation processes in SMs. In other words, which similarities and differences will be more dominant may vary depending on these variables. The findings indicate that the standardisation of many administrative and technical features of the SM structure causes similarity between SMs, especially among homogeneous ones. In addition, the fact that certain groups and companies are influential in the shopping centre sector, the number of brands operating within the shopping centre is not enough, and the fact that SMs operate in a similar environment makes diffusion more powerful. Indeed, the legal and social developments in the organisational environment motivate differentiation and, thus, translation after a while. Finally, it was observed that diffusion was dominant in periods when there was not enough knowledge about SMs. Considering the reasons that

push malls towards similarity or difference, the diffusion-translation relationship is explained in Figure 3⁶.

Figure: 3
Diffusion and Translation Matrix

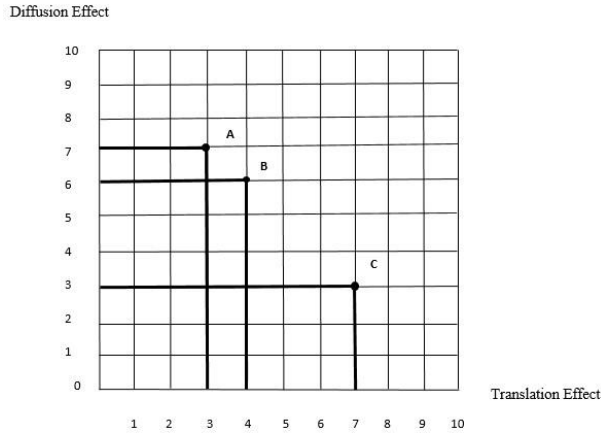

To create and interpret the matrix, we must use the “Ceteris Paribus”, a Latin-based expression used in many disciplines, especially economics. Accordingly, while analysing the change in a subject, all other mentioned subjects are accepted as fixed, that is, unchangeable, and an independent evaluation is made for each subject, albeit in theory. Let us consider the letters A, B and C as different SMs. The matrix shows that diffusion up to the 7th degree and translation up to the 3rd degree are effective at point A. At point B, diffusion up to the 6th degree and translation up to the 4th degree are effective. Lastly, diffusion up to the 3rd degree and translation up to the 7th degree is effective at point C. Therefore, considering the Ceteris Paribus assumption, compared to the SMs at point C, the SMs at points A and B;

- operate in a similar environment (geographical situation, climate, culture, demographic structure, etc.), including the competitive environment,
- homogeneous structures and have approximately similar scales,
- contain similar brands,
- are affiliated with the same company or management/consulting firm or

⁶ As mentioned, it is not easy to explain numerically the diffusion and translation rate that takes place during the journey of any idea. This situation varies from person to person and contains uncertainties about what measurement technique should be used. The matrix was created to describe the relationship between diffusion and translation and the positions of the structures affected by this process against each other.

- have a strong organisational area, thus a strong communication and similar level of knowledge.

Therefore, the opposite of these situations is valid between A and C or B and C malls.

In addition, if the diffusion or translation degrees for any of the A, B or C malls in the matrix are zero, that is, at $(x, 0)$ or $(0, y)$ points, or if any of these malls $(0, 0)$ or $(10, 10)$ points are theoretically possible, but in practice it is almost impossible.

7. Limitations

The first limitation of the study is the language. The resources about the study that were accessed are in Turkish and English. Unfortunately, studies on this subject in languages other than Turkish and English could not be accessed.

The second limitation concerns the statements of the participants. Although most of the issues raised have been confirmed by research, all of the things reported by the participants must be accepted as true by the researcher.

Another limitation is the emergence of the pandemic at the time of the research. For example, travel restrictions prevented visiting SM management and conducting more detailed investigations on-site.

The final limitation is about the interviewees. Interviews were held with senior managers. Other stakeholders, such as consumers, employees operating at lower levels, and NGO members, could not be included.

8. Suggestions for Further Research

Postgraduate and academic studies in Scandinavian Institutionalism are relatively limited. Further research can be conducted on this subject in the future. For example, the translation processes of different managerial ideas or organisational forms can be examined. The concept of translation can be tested in different ways by running national or international comparative analyses. Or, as was carried out in this study, studies in which translation and diffusion issues on a management idea or an organisational form can be conducted. In addition, regional translation or dissemination studies can be carried out by making spatial limitations. Finally, more in-depth studies can be performed by including other stakeholders operating in the sector.

References

- Abrahamson, E. (1996a), "Management fashion", *Academy of Management Review*, 21(1), 254-285.
- Abrahamson, E. (1996b), "Technical and aesthetic fashion", in: B. Czarniawska & G. Sevón (eds.), *Translating Organizational Change* (117-137), Walter de Gruyter & Co., Berlin.
- Altuna, O.K. (2012), *Alışveriş Merkezleri: AVM'ler Nasıl Farklı Konumlandırılır?*, Beta Yayıncılık, İstanbul.

- Ansari, S.M. et al. (2010), "How practices vary as they diffuse", *Academy of Management*, 35(1), 67-92.
- AYD Alışveriş Merkezleri ve Yatırımcıları Derneği, (2019), *Takastan Paraya, Agoradan Çarşıya, Bedestenden AVM'ye Alışveriş*, Printcenter, İstanbul.
- Baron, S. et al. (1991), *Macmillan Dictionary of Retailing*, The Macmillan Press Ltd., London.
- Bayraktar, H. (2004), *Şansız Arayacak Vaktim Olmadı*, Bayraktar Kültür Yayınları, İstanbul.
- Bloch, P.H. et al. (1994), "The shopping mall as consumer habitat", *Journal of Retailing*, 70(1), 23-42.
- Boons, F. & L. Strannegård (2000), "Organizations coping with their natural environment: a laboratory for institutionalization?", *International Studies of Management & Organization*, 30(3), 7-17.
- Boxenbaum, E. & J.S. Pedersen (2009), "Scandinavian institutionalism - a case of institutional work", in: T.B. Lawrence et al. (eds.), *Institutional Work: Actors and Agency in Institutional Studies of Organizations* (178-204), Cambridge University Press, New York.
- Cheng, E.W. et al. (2007), "A GIS approach to shopping mall location selection", *Building and Environment*, 42(2), 884-892.
- Cohen, N.E. (2002), *America's Marketplace: The History of Shopping Centers*, Greenwich Publishing Group, Inc., Lyme, Connecticut.
- Coleman, P. (2006), *Shopping Environments: Evolution, Planning and Design*, Architectural Press, Oxford.
- Czarniawska, B. & B. Joerges (1996), "Travels of Ideas", in: B. Czarniawska & G. Sevón (eds.), *Translating Organizational Change* (13-48), Walter de Gruyter & Co., Berlin.
- Czarniawska, B. (2008), "How to misuse institutions and get away with it: some reflections on institutional theory(ies)", in: R. Greenwood et al. (eds.), *The SAGE Handbook of Organizational Institutionalism* (769-782), SAGE Publications, London.
- Deephouse, D.L. (1996), "Does isomorphism legitimate?", *Academy of Management Journal*, 39(4), 1024-1039.
- Dimaggio, P. & W. Powell (1983), "The iron cage revisited: institutional isomorphism and collective rationality in organizational fields", *American Sociological Review*, 48(2), 147-160.
- Greenwood, R. & C. Hinings (1996), "Understanding radical organizational change: bringing together the old and the new institutionalism", *Academy of Management Review*, 21(4), 1022-1054.
- GYODER (2019), *GYODER Gösterge*, <<https://www.gyoder.org.tr/yayinlar/gyoder-gosterge>>, 04.03.2020.
- Harris, C.M. (2006), *Dictionary of Architecture and Construction*, McGraw-Hill, New York.
- Hawley, A.H. (1981), "Human ecology: persistence and change", *American Behavioral Scientist*, 24(3), 423-444.
- İGD (2019), *2019 Gayrimenkul Piyasası Raporu*, <<https://www.igd.com.tr/yayinlar/arastirmalar/2019-gayrimenkul-piyasasi-raporu/>>, 04.03.2020.

- Jewell, N. (2015), *Shopping Malls and Public Space in Modern China*, Ashgate Publishing Limited, London.
- Johnson, B. & B. Hagström (2005), "The translation perspective as an alternative to the policy diffusion paradigm: the case of the Swedish methadone maintenance treatment", *Journal of Social Policy*, 34(3), 365-388.
- Kayra, F. et al. (2022), "İskandinav Kurumsalcılığında Çeviri Araştırmaları", *Akdeniz İİBF Dergisi*, 22(1), 69-83.
- Kolsuz, G. & A.E. Yeldan (2014), "1980 sonrası Türkiye ekonomisinde büyümenin kaynaklarının ayrıştırılması", *Çalışma ve Toplum*, 40(1), 49-66.
- Latour, B. (1986), "The powers of association", in: J. Law (ed.), *Power, Action and Belief* (264-280), Routledge and Kegan Paul, London.
- Malec, T.E. (2010), "Modern shopping malls in the USA and Europe - outline", *Architecture Civil Engineering Environment*, 3(3), 15-24.
- Merriam, S.B. (1998), *Qualitative Research and Case Study Applications in Education: Revised and Expanded from Case Study Research in Education*, Jossey-Bass Publishers, San Francisco.
- Meyer, J.W. & B. Rowan (1977), "Institutionalized organizations: formal structure as myth and ceremony", *American Journal of Sociology*, 83(2), 340-363.
- Mica, A. (2013), "From Diffusion to Translation and Back. 'Disembedding-Re-embedding' and 'Re-invention' in Sociological Studies of Diffusion", *Polskie Towarzystwo Socjologiczne (Polish Sociological Association)*, 181(1), 3-19.
- Powell, W.W. & P.J. DiMaggio (1991), "Introduction", in: W.W. Powell & P.J. DiMaggio (eds.), *The New Institutionalism in Organizational Analysis* (1-38), The University of Chicago Press, Chicago.
- Ritzer, G. & J. Stepnisky (2012), *Çağdaş Sosyoloji Kuramları ve Klasik Kökleri*, (Çev. I.E. Howison) De Ki Basım Yayım Ltd., Ankara.
- Rogers, E.M. (1983), *Diffusion of Innovations*, The Free Press, New York.
- Røvik, K.A. (2016), "Knowledge transfer as translation: review and elements of an instrumental theory", *International Journal of Management Reviews*, 18(3), 290-310.
- Sahlin, K. & L. Wedlin (2008), "Circulating Ideas: Imitation, Translation and Editing", in: R. Greenwood et al. (eds.), *The SAGE Handbook of Organizational Institutionalism* (218-242), SAGE Publications London.
- Sahlin-Andersson, K. (1996), "Imitating by Editing Success: The Construction of Organizational Fields", in: B. Czarniawska & G. Sevón (eds.), *Translating Organizational Change* (69-92), Walter de Gruyter & Co., Berlin.
- Scott, W.R. (2014), *Institutions and Organizations: Ideas, Interests, and Identities*, Sage Publications, California.
- Selznik, P. (1949), *TVA and the Grass Roots: A Study of Politics and Organization*, University of California Press, California.
- Sevón, G. (1996), "Organizational imitation in identity transformation", in: B. Czarniawska & G. Sevón (eds.), *Translating Organizational Change* (49-67), Walter de Gruyter & Co., Berlin.

- Shields, R. (2005), "Spaces for the subject of consumption", in: R. Shields (ed.), *Lifestyle Shopping* (1-20), Routledge, London.
- Singh, H. & S.R. Srinivasan (2012), *Mall Management*, Tata McGraw-Hill, New Delhi.
- Strumińska-Kutra, M. & I. Kołodkiewicz (2018), "Case Study", in: M. Ciesielska & D. Jemielniak (eds.), *Qualitative Methodologies in Organization Studies* Vol. 2 (1-32), Springer, Cham.
- Suchman, M. (1995), "Managing legitimacy: strategic and institutional approaches", *Academy of Management Review*, 20(3), 571-610.
- Tolbert, P. & L. Zucker (1983), "Institutional sources of change in the formal structure of organizations: the diffusion of civil service reform, 1880-1935", *Administrative Science Quarterly*, 28, 22-39.
- Van Grinsven, M. et al. (2016), "Translating management concepts: towards a typology of alternative approaches", *International Journal of Management Reviews*, 18(3), 271-289.
- Wæraas, A. & H.L. Sataøen (2014), "Trapped in conformity? Translating reputation management into practice", *Scandinavian Journal of Management*, 30(2), 242-253.
- Wejnert, B. (2002), "Integrating models of diffusion of innovations: a conceptual framework", *Annual Review of Sociology*, 28(1), 297-326.

Kayra, F. & D. Taşcı & A. Yalçınkaya & U. Koç (2024), "Translation And Diffusion Process of The Shopping Mall Form: A Case Study", *Sosyoekonomi*, 32(59), 49-89.

The Relationship Between Renewable Energy Consumption and Stock Market Capitalisation and Carbon Emissions: Insights from G20 Countries¹

Yücel AYRIÇAY (<https://orcid.org/0000-0001-5148-391X>), Kahramanmaraş Sütçü İmam University, Türkiye; yucelayricay@hotmail.com

Meltem KILIÇ (<https://orcid.org/0000-0001-8978-9076>), Kahramanmaraş Sütçü İmam University, Türkiye; meltem.kilic@hotmail.com

Seren AYDINGÜLÜ-SAKALSIZ (<https://orcid.org/0000-0001-7452-311X>), Kahramanmaraş Sütçü İmam University, Türkiye; saydingulu@ksu.edu.tr

Yenilenebilir Enerji Tüketimi ve Piyasa Kapitalizasyonu ile Karbon Emisyonu Arasındaki İlişki: G20 Ülkeleri Örneği²

Abstract

The research question of whether carbon emissions affect the economic growth and financial development of countries is discussed in the literature. Based on this, this study examines the relationship between carbon emissions (CO₂) market capitalisation and renewable energy consumption, which are financial development indicators. The model established with the carbon emissions, renewable energy consumption, market value, fixed capital investments and gross domestic product indicators of the G20 countries between 1992 and 2018 was tested with panel data cointegration analysis and panel causality analysis. As a result of the empirical analysis, it has been found that there is a statistically significant and negative relationship between renewable energy consumption, market capitalisation and carbon emissions, and there is a bidirectional causality relationship between market capitalisation and carbon emissions. The results are that the effective use of energy and the developments in the financial system will contribute to sustainable development policies.

Keywords : Carbon Emissions, Renewable Energy, Stock Market Capitalisation, Panel Data Analysis.

JEL Classification Codes : Q56, Q2, O16, C23.

Öz

Karbon emisyonlarının, ülkelerin ekonomik büyümelerini ve finansal gelişimlerini etkileyip etkilemediği araştırma sorusu literatürde tartışılmaktadır. Buna dayanarak bu çalışmanın amacı, finansal gelişmişlik göstergelerinden olan piyasa kapitalizasyonları ve yenilenebilir enerji tüketimi ile karbon emisyonu (CO₂) ilişkisini incelemektir. G20 ülkelerinin 1992-2018 dönemleri arasındaki karbon emisyonu, yenilenebilir enerji tüketimi, piyasa kapitalizasyonu, sabit sermaye yatırımları ve gayrisafi yurtiçi hâsıla göstergeleri ile kurulan model panel veri eşbütünlüşme analizi ve panel nedensellik analizi ile test edilmiştir. Ampirik analizler sonucunda yenilenebilir enerji tüketimi, piyasa kapitalizasyonu ile karbon emisyonu arasında istatistiksel olarak anlamlı ve negatif yönde bir ilişkinin olduğu, ayrıca piyasa kapitalizasyonu ile karbon emisyonu arasında çift yönlü nedensellik ilişkisi

¹ This is improved and revised version of the study that presented at the 21st International Business Congress.

² Bu çalışma, 21. Uluslararası İşletme Kongresi'nde sunulan çalışmanın geliştirilmiş ve gözden geçirilmiş halidir.

olduğuna ulaşılmıştır. Sonuçlar, enerjinin etkin kullanılması ile finansal sistemde yaşanacak olan gelişmelerin sürdürülebilir kalkınma politikalarına katkı sağlayacağı yönündedir.

Anahtar Sözcükler : Karbon Emisyonu, Yenilenebilir Enerji, Piyasa Kapitalizasyonu, Panel Veri Analizi.

1. Introduction

Environmental problems such as global warming, unexpected increases in sea levels, significant melting of glaciers, and extinction of living species that have emerged in the last century have started to pose a global threat. Carbon emissions are considered the leading cause of these problems. Among the carbon emissions, carbon dioxide (CO₂), known to be the most damaging to the environment and living things, constitutes 76.7% of carbon emissions (Alam et al., 2021; Paramati et al., 2017). Most carbon emissions are due to fossil fuel consumption such as coal, natural gas and oil (Roberts et al., 2019). As a result of the development of the economy and industry and the increasing energy demand, a significant amount of CO₂ was released into the environment. The disadvantage of traditional energy consumption being non-renewable is that it significantly harms the environment and nature. As a result of these disadvantages, it has become attractive to offer a clean and sustainable world if low-carbon renewable energy sources are used with increasing concerns (Bhattacharya et al., 2016). Since renewable energy sources do not produce carbon emissions at a minimum and/or at all, they cause minimal damage to the environment (Apergis & Lau, 2015; Bhattacharya et al., 2016). Sustainability in energy use refers to the use of clean and inexhaustible energy. There is a positive relationship between the economic development of developed and developing countries and the amount of carbon emissions (Li et al., 2020). G20 countries, which are the most developed in the world in industry and technology, are the countries that consume the most energy and produce the most carbon emissions in parallel. Therefore, reducing CO₂ emissions depends on the activities of the G20 countries whose economies are most developed to reduce carbon emissions and efficiently use energy. Carbon emissions hinder economic growth, so research on reducing carbon emissions has gained momentum among economists (Zafar et al., 2019). According to the research conducted by New Energy Finance (2021), sectors have allocated emission budgets to zero their carbon emissions in 2050. It is desirable to reduce emissions by 30% by 2030 compared to 2019 and by 75% by 2040. Investment in renewable energy sources increased by 27% compared to 2020 to reach \$755 billion (BloombergNEF, 2021). Therefore, one possible solution is investing in renewable energy projects to prevent increased CO₂ emissions. Stock market capitalisation is among the most important sources of financing for renewable energy investments (Alam et al., 2015; Bhattacharya et al., 2016; Paramati et al., 2017). The development of stock markets provides investors with additional sources of financing so that investors can invest in renewable energy sources with higher investment capital (Bhattacharya et al., 2016; Minier, 2009). Carbon emissions also hinder the economic growth and financial development of countries. In line with the activities carried out to reduce carbon emissions, the increasing financial need arising from the

increase in investments made in renewable energy sources and the reduction of carbon emissions to encourage financial development and economic growth (Apergis & Danuletiu, 2014) is extremely important for policymakers, firm owners and investors.

The motivation of the study is to establish the relationship between renewable energy consumption, stock market capitalisation, gross domestic product and fixed capital investments with carbon emissions based on all these reasons. The study investigates the relationship between financial development and economic growth indicators, stock market capitalisation, renewable energy consumption, gross domestic product (GDP) and CO₂ emissions of fixed capital investments. Unlike other studies, the study examines the relationship between CO₂ emissions, stock market capitalisation and renewable energy consumption, not based on a region or a country, but within the framework of G20 countries, which include developed and developing countries and play a vital role in the global economy. It also differs from other studies, especially by examining the relationship between the stock market capitalisation of G20 countries and carbon dioxide emissions. If we look at the rest of the study, in the second part, similar studies that have been done before are mentioned, and in the third part, the dataset and methodology of the research are discussed. Empirical findings are included in the 4th part of the research, and finally, the results and recommendations are presented in the 5th part.

2. Literature Review

Recent studies have characterised countries' energy use from natural resources as successful environmental performance. Consumption of these renewable energy sources is one of the activities that reduces carbon emissions. Studies conducted in recent years have also sought to answer the question of how there is a relationship between carbon emissions and renewable energy consumption and financial development indicators (Alam et al., 2015; De Haas & Popov, 2019; Grileiro, 2019; Sadorsky, 2010a; Yuping et al., 2021; Zafar et al., 2019; Zeqiraj et al., 2020; Zeren & Koc, 2014). Richmond and Kaufmann (2006) investigated the relationship between income, energy mix and carbon emissions between 1973 and 1997 for 36 countries that accounted for 95% of the world's energy demand, including 20 developed (Organisation for Economic Cooperation and Development (OECD) countries) and 16 developing (non-OECD) countries. The study found that policymakers did not take measures to reduce carbon emissions and that there was a negative correlation between renewable energy sources and carbon emissions. Apergis et al. (2010) sought answers to whether there is a causality relationship between CO₂ emissions, nuclear energy consumption, renewable energy consumption and economic growth. According to the findings of the study conducted between 1984 and 2007 in 19 different countries, there is a long-term relationship between carbon emissions, nuclear energy, renewable energy, and economic growth. In the long term, nuclear energy consumption reduces emissions. In addition, nuclear energy plays an important role in reducing CO₂ emissions. In addition, a bidirectional causality relationship between renewable energy consumption and economic growth has been revealed. It has also shown that it will reduce the risks of foreign-dependent countries in energy. Alam et al. (2015) investigated the relationship between energy demand

and growth between 1975 and 2011 through indicators of financial development for South Asian Regional Cooperation Organization (SAARC) countries (Bangladesh, Bhutan, Afghanistan, India, Maldives, Nepal, Pakistan, and Sri Lanka). According to the study's findings, there is a significant relationship between energy consumption, economic growth, and financial development. At the same time, financial development indicators have been found to impact energy demand significantly. Paramati et al. (2017), in their study with data from G20 countries between 1991 and 2002, examined the magnitude of stock market capitalisation, fixed capital investments, foreign direct investments, and the impact of renewable energy consumption on CO₂ emissions. According to the empirical findings, a strong long-term relationship exists between CO₂ emissions, foreign direct investments and renewable energy consumption. The consumption of renewable energy sources has been shown to reduce CO₂ emissions compared to conventional energy sources. On the other hand, the development of stock markets minimises CO₂ emissions. Therefore, it has been stated that policymakers should pay attention to developing policies that encourage firms to use energy efficiency and green energy technologies. Zafar et al. (2019) analysed the data of G-7 and N-11 countries for 1990-2016. They examined the impact of the development of stock market capitalisation and the development of the banking sector on carbon emissions. N-11 countries have a strong positive relationship between the development of stock market capitalisation and carbon emissions due to inefficient, traditional energy use, while in G-7 countries, there has been a strong negative relationship due to firms' use of green technology. On the other hand, a strong negative relationship was found between banking development level and carbon emissions for both country groups. Zeqiraj et al. (2020) sought answers to the question of how there is a relationship between the stock market and low carbon emissions in European Union countries. It has identified two different channels that affect this relationship: renewable energy and the use of new technology. From 1980-2016, a long-term relationship existed between equity markets and low carbon emissions in European Union member states and the use of renewable energy and new technology-supported low carbon emissions. In another study examining the relationship between carbon emissions and the development of financial systems, Haas and Popov (2021) found that as equity markets in 48 countries developed and deepened, the sectors that caused intense carbon emissions focused more on green technologies. Alam et al. (2021) examined the relationship between R&D studies and stock market capitalisation, green energy consumption, and CO₂ emissions in their study conducted in 30 OECD countries. The findings of the research revealed that there is a long-term and positive relationship between R&D activities, stock market capitalisation, and green energy consumption, while they have a negative effect on the growth of CO₂ emissions. If we look at the studies in the literature, while equity markets in developed countries are the largest market among financial markets, financial markets in developing countries are mostly based on the banking sector. Increasing the level of development of financial markets increases economic growth, and more energy consumption is needed with economic growth (Tamazian et al., 2009). As financial development increases, consumers' desire to receive high energy-consuming requests and needs such as cars, homes, and dishwashers will increase. On the other hand, the increase in financial development makes it easier for firms to obtain the financial capital they need. It causes

them to use less costly capital. The development of the stock market is also significant for firms. In addition to the source of financing with debt, firms also need equity financing. The development of stock markets allows firms to diversify their financial portfolios. Stock market capitalisation is an economic indicator of countries and indicates economic growth and prosperity. In addition, as the size of stock market capitalisation increases, the capital cost will decrease, and the optimum capital structure will be approached to increase efficiency by ensuring the efficient use of resources (Bekaert et al., 2001; Dasgupta et al., 2001; Gurley & Shaw, 1955; Sadorsky, 2010b; Solomon et al., 2009; Xu, 2000). However, for the studies carried out within the framework of the G20 countries, apart from the consumption of renewable energy sources, carbon emissions, and economic growth, the stock market capitalisation is also included in the model, unlike other studies.

It aims to examine the relationship between the use of renewable energy resources, which leads to the efficient use of resources, and market capitalisation, which is one of the financial development indicators, and carbon emissions, and also to explain whether the 19 largest economies of the world support the EKC hypothesis. In this study, the data of the G20 countries for 1992-2018 are included in the analysis. The relationship of stock market capitalisations, renewable energy consumption, fixed capital investments and GDP with carbon emissions is investigated. The variables of the model are introduced first, and the identifier statistics are given. After horizontal cross-sectional dependency tests, unit root tests, correlation tests, homogeneity tests, appropriate cointegration analysis and causality analysis were performed, the results were interpreted.

3. Data and Methodology

This study aims to examine the relationship between carbon emissions and renewable energy consumption and stock market capitalisation of G20 countries (Argentina, Australia, Brazil, Canada, China, France, Germany, India, Indonesia, Italy, Japan, Mexico, Russia, Saudi Arabia, South Africa, South Korea, Türkiye, the United Kingdom, and the United States) from 1992 to 2018 due to restrictions on the availability of data. G20 countries emit the most CO₂ emissions, so we included them in the analysis (Kong et al., 2022). Also, we use control variables, which are the gross domestic product and fixed capital investments (Paramati et al., 2017; Zafar et al., 2019). The study was taken from 1992 to 2018 due to restrictions on data availability. In this study, the variables used definitions and sources given in Table 1 below.

Table: 1
Variables

Variables	Calculation Method	Data Source
Dependent Variable		
LnCO ₂	CO ₂ Emission (kt)	World Bank Database
Independent Variables		
LnREN	Renewable Energy Consumption	International Energy Agency (IEA) Database
SMC	The Ration of Stock Market Capitalization to GDP	World Bank Database
LnGDP	Gross Domestic Product (Constant 2015 US\$)	World Bank Database
GFC	The Ration of Fixed Capital Investments to GDP	World Bank Database

The following model has been developed to examine the relationship between stock market capitalisation, renewable energy consumption and CO₂ emissions. Following the methodologies of Shahbaz et al. (2013) and Rahman and Alam (2022), the underlying model has been employed for our empirical inspection. The logarithms of the variables were taken to avoid the variable variance problem and to produce efficient and systematic results (Ashwin Kumar et al., 2016; Bhat et al., 2022; Wang & Dong, 2021).

$$\text{LnCO}_2 = f\{\text{LnREN}, \text{SMC}, \text{LnGDP}, \text{LnGFC}\} \quad (1)$$

The function in Eq. (1) can be transformed into an econometric model by including an error term and a constant term given in Eq. (2):

$$\text{LnCO}_{2it} = \beta_0 + \beta_1 \text{LnREN}_{it} + \beta_2 \text{LnGDP}_{it} + \beta_3 \text{SMC}_{it} + \beta_4 \text{GFC}_{it} + \varepsilon_{it} \quad (2)$$

$$i=1, \dots, N; t=1, \dots, T$$

Where CO₂ denotes the carbon emissions used as a proxy of environmental pollution, renewable energy consumption (REN) refers to the consumption of renewable resources such as biomass, hydro, geothermal, wind and southern energy. SMC is financial development used as a proxy of the market capitalisation of listed domestic firms (% of GDP). β_0 is constant, ε_{it} is error term, t denotes the number of periods and i indicates the number of countries. $\beta_1, \beta_2, \beta_3$ and β_4 show the long-term coefficients of the variables.

4. Preliminary Statistics

Table 2 presents the average renewable energy consumption, carbon emissions and stock market capitalisation of individual G20 between 1992 and 2018. G20 countries are responsible for 80% of total greenhouse gas emissions worldwide. At the same time, as a country and international organisation, it carries out many activities and makes regulations to prevent the climate crisis.

It was determined that China emitted the most greenhouse gas emissions in the G20 countries between 1992 and 2018 (6108837.40). It is followed by the United States (5328955.18) and Russia (1577250.37). However, in recent years, environmental regulations and developments have reduced carbon emissions, especially in developed countries. According to the 2002 Climate Transparency Report, per capita emissions decreased between 2015 and 2019 in G20 countries except India, Türkiye, China, Russia, and South Korea. Although efforts have been made to reduce greenhouse gas emissions, thousands of people died in many countries, especially China, India, Germany and the USA, due to climate impacts worldwide between 1999 and 2018. Japan, China, and South Korea are the G20 countries that spend the most from public resources on fossil records to prevent the climate crisis and reduce greenhouse gas emissions.

This study examined G20 countries, one of the world's leading economic groups with high greenhouse gas emissions but working to prevent the climate crisis. In this context, the

impact of G20 countries' renewable energy consumption and stock market activities on greenhouse gas emissions is being investigated. The study findings will add value to knowledge and provide important policy implications for G20 countries.

Table: 2
Average Greenhouse Gas Emissions, Renewable Energy and Stock Market Capitalization of Individual G20 Countries Between 1992 and 2018

Countries	CO ₂	REN	SMC
Argentina	148827.80	9.80	14.15
Australia	351280	8.25	92.94
Brazil	348301.90	45.32	37.68
Canada	519184.10	21.93	117.67
China	6108837	20.77	37.18
France	6108837	11.00	67.98
Germany	808026.70	8.01	40.92
India	1341736	46.00	53.90
Indonesia	357983.30	39.92	30.35
Italy	406136.70	9.33	32.75
Japan	1178187	4.65	75.22
Mexico	412867.40	10.72	28.38
Russian Federation	1577250	3.53	33.90
Saudi Arabia	350134.10	0.01	59.02
South Africa	357706.70	13.50	193.94
South Korea	490473	2.82	60.64
Türkiye	258421.10	16.57	21.40
United Kingdom	493087.40	3.24	115.98
United States	5328955	6.56	118.26

5. Findings

The panel data analysis method is used in the study because it has both unit and time dimensions. Cross-section dependency and heterogeneity tests affect the selection of estimation techniques used in panel data models. According to the results of cross-sectional dependence tests and heterogeneity tests, it is decided which tests will be used: unit root analysis, cointegration relationship, cointegration estimator and causality analysis.

Cross-sectional dependence tests

Cross-section dependency determines whether a shock in one country affects other countries. Because if the panel consists of groups of countries with similar characteristics, cross-sectional dependence is important for countries (Nazlioglu et al., 2011). Before proceeding to the panel data analysis tests, the cross-sectional dependence of the series is first tested. The cross-sectional dependence of the variables is tested with the Pesaran (2004) CD test. The cross-section dependency test is used, so the null hypothesis is "no cross-section dependence" (Breusch & Pagan, 1980; Pesaran, 2004; Pesaran et al., 2008).

Table 3 summarises the results of the cross-sectional dependence of the series. Suppose the null hypothesis is rejected due to the Pesaran CD test. In that case, second-generation panel unit root tests are used, which allow correlation between the series belonging to the units (Yerdelen-Tatoğlu, 2018).

Breush-Pagan Lagrange Multiplier (LM), Pesaran CD and LM_{adj} tests are used to test the cross-sectional dependence of the $LnCO_2 = f(LnREN, LnGDP, GFC, LnSMC)$ model. Breush-Pagan LM tests $Cov = (u_{it}, u_{jt}) = 0$, for all $t, i \neq j$ under the null hypothesis of "no cross-section dependence" (Breuer et al., 2001). The result of the cross-section dependency statistics of the model is presented in Table 4.

Table: 3
Pesaran's (2004) Cross-Section Dependency

CD (Pesaran, 2004)	CD - Statistics
LnCO ₂	14.26***
LnREN	2.50***
LnGDP	63.32***
SMC	31.40***
GFC	3.82***

Notes: *** $p < 0.01$, ** $p < 0.05$, * $p < 0.10$.

Table: 4
Breush Pagan's (1980) LM Test, Pesaran's (2004) CD_{LM} Test and Pesaran Ullah and Yamagata's (2008) NLM (LM_{adj}) Cross-Sectional Dependency

	Statistics
CD LM (Breusch - Pagan, 1980)	275***
CD LM (Pesaran, 2004, CD LM)	11.18***
LM_{adj} (Pesaran et al., 2008)	6.52***

Notes: *** $p < 0.01$, ** $p < 0.05$, * $p < 0.10$.

According to the result of the cross-sectional dependence test, the null hypothesis was rejected, and it was concluded that there was a cross-section dependency in the variables. This result reveals that the second-generation panel unit root analysis should be used to test the stationarity of the series. According to Breush Pagan's (1980) LM test, Pesaran's (2004) CD LM test and Pesaran, Ullah and Yamagata's (2008) LM_{adj} test results, the null hypothesis is rejected at 99% confidence interval. It was concluded that there is a correlation between units in the model.

Panel unit root test

Since there is a cross-section dependency in all the variables, in other words, there is a correlation between the units, the second-generation panel unit root analysis of the series, the cross-section extended Im, Pesaran and Shin (CIPS) test is used. Pesaran (2007) proposed a new technique, cross-sectional extended Im, Pesaran and Shin (CIPS), which is robust to cross-sectional dependence and produces more consistent and reliable results than conventional unit root tests. The CIPS test is considered the horizontal section extended version of the IPS test, and the flat section represents the average of the extended Dickey-Fuller (CADF) test (Pesaran, 2007). The unit root hypothesis tested with the CIPS test is $H_0: \beta_i = 0$ for all cross sections. The result of the CIPS test statistics is presented in Table 5.

Table: 5
Panel Unit Root Test

I(0)		I(1)	
Variables	Statistics	Variables	Statistics
LnCO ₂	-1.94	Δ LnCO ₂	-3.10***
LnREN	-1.46	Δ LnREN	-3.68***
LnGDP	-2.01	Δ LnGDP	-2.71***
GFC	-1.89	Δ GFC	-3.20***
LnSMC	-1.89	Δ LnSMC	-3.11***

Notes: *** $p < 0.01$, ** $p < 0.05$, * $p < 0.10$.

According to the results of the table, it is concluded that all variables are non-stationary at level but become stationary when the first differences are taken. In other words, the series is determined to be I(1). This result reveals that the first difference of the variables should be taken.

Slope homogeneity tests

After the cross-section dependence of the model, whether the slope coefficient is heterogeneous is tested. The heterogeneity of the slope coefficients is analysed by the Delta test developed by Pesaran and Yamagata (2008). It is analysed by delta test. The delta test, which tests homogeneity, is determined in two dimensions, $\tilde{\Delta}$ and $\tilde{\Delta}_{adj}$. Delta test null hypothesis is established as $H_0: \beta_i = \beta$ "slope parameters are homogeneous" (Pesaran & Yamagata, 2008). The result of the Homogeneity test statistics is presented in Table 6. According to the probability value results of the delta homogeneity test Δ and Δ_{adj} statistics, the null hypothesis was rejected, and it was concluded that the slope parameters were heterogeneous.

Table: 6
Slope Homogeneity Tests

	Delta Statistics
Δ	22.97***
Δ_{adj}	26.05***

Notes: *** $p < 0.01$, ** $p < 0.05$, * $p < 0.10$.

Panel cointegration test

Due to the heterogeneity and cross-section dependency of the model, the existence of a long-term relationship was tested with the Gengenbach, Urbain and Westerlund (2016) panel cointegration test. Gengenbach, Urbani and Westerlund's (2016) panel cointegration test was used to test the long-term cointegration relationship. Gengenbach, Urbani and Westerlund's (2016) panel cointegration test developed a cointegration test based on the importance of the error correction term in a panel error correction model with non-stationary common factors (Gengenbach et al., 2016). This equation tests the hypothesis $H_0: \alpha_{y1} = \dots = \alpha_{yN} = 0$ (Gengenbach et al., 2016). It is established as the null hypothesis is that there is "no cointegration relationship in the panel". The results of the panel cointegration test statistics are presented in Table 7.

Table: 7
Panel Cointegration Test

d y	Coef.	t-bar	Prob.
y(t-1)	-1.30	-3.76	<=0.05

According to Gengenbach, Urbain and Westerlund (2016), the model has a cointegration relationship. Accordingly, firms' renewable energy consumption and market capitalisation affect carbon emissions in the long run. After finding that CO₂, REN, SMC, GDP and GFC are cointegrated, we estimate the long-run coefficient for the impact of renewable energy and stock market capitalisation on carbon emissions for G20 countries.

Long-term panel cointegration estimation

The Dynamic Ordinary Least Squares Mean Group (DOLSMG) estimated the cointegration estimator in the model, which was found to have a long-term cointegration relationship. DOLSMG is an estimator considering cross-section dependence and homogeneity (Pedroni, 2001). In the long-term relationship estimation, the variables are transformed by taking the difference from the cross-sectional averages, and the analysis is made with the DOLS estimator for the model units and the DOLSMG estimator for the whole panel (Yerdelen-Tatoğlu, 2018). The results of the long-term panel cointegration estimation statistics are presented in Table 8.

Table: 8
Long-Term Panel Cointegration Estimation

	Δ LnREN	Δ LnGDP	Δ SMC	Δ GFC
Model	-0.13*** [-8.33]	0.91*** [5.86]	-0.08*** [-8.37]	0.00*** [2.60]

Notes: ***p<0.01, **p<0.05, *p<0.10.

For the full panel of G20 countries, renewable energy negatively and significantly affects carbon emissions. The increase in renewable energy in G20 countries reduces carbon emissions. For the full panel of G20 countries, stock market capitalisation negatively and significantly affects carbon emissions. An increase in market capitalisation, an indicator of financial development, reduces carbon emissions. For the entire panel, GDP and GFC positively and statistically significantly affect carbon emissions. The increase in growth causes an increase in carbon emissions as it increases consumption and production.

Panel causality test

This study aims to analyse the causal relationship between renewable energy and stock market capitalisation with carbon emissions from 1992 to 2018. As a testing methodology, the causality Dumitrescu-Hurlin, allowing for heterogeneity and cross-sectional dependency, is utilised. The panel causality test hypothesis is established as "H₀: X is not the cause of Y" (Dumitrescu & Hurlin, 2012). For the Dumitrescu-Hurlin panel causality test, lag lengths were selected according to the Akaike information criterion. The

AIC information criterion was set to be two optimal lag lengths for all tests. Dumitrescu-Hurlin panel causality test results are reported in Table 9.

Table: 9
Dumitrescu-Hurlin Panel Causality

			Whnc	Zhnc (Asymptotic)	Ztild (Semi-Asymptotic)
ΔLnREN	→	ΔLnCO_2	3.25***	6.94***	5.58***
ΔLnCO_2	→	ΔLnREN	0.47	-1.61	-1.61
ΔSMC	→	ΔLnCO_2	1.90*	2.80***	2.09**
ΔLnCO_2	→	ΔSMC	2.59**	4.91***	3.87***
ΔLnGDP	→	ΔLnCO_2	0.78	-0.66	-0.81
ΔLnCO_2	→	ΔLnGDP	1.29	0.92	0.51
ΔGFC	→	ΔLnCO_2	0.96	-0.10	-0.34
ΔLnCO_2	→	ΔGFC	0.88	-0.35	-0.55

Notes: *** $p < 0.01$, ** $p < 0.05$, * $p < 0.10$.

Table 9 shows a unidirectional causality relationship between renewable energy consumption and carbon emissions. It has been determined that there is a bidirectional causality relationship between stock market capitalisation and carbon emissions. A causality relationship between GDP and CO₂ could not be reached. In addition, a causal relationship between GFC and CO₂ could not be determined. Accordingly, it is found that using renewable energy sources affects carbon emissions. On the other hand, the amount of carbon emissions does not affect the consumption of renewable energy sources. According to the bidirectional causality relationship between stock market capitalisation and carbon emissions, an increase or decrease in stock market capitalisation, an indicator of financial development, affects carbon emissions. On the other hand, an increase or reduction in carbon emissions causes a change in stock market capitalisation.

6. Conclusions and Policy Recommendations

6.1. Conclusions

The study analyses the relationship between renewable energy consumption, stock market capitalisation and carbon emissions of G20 countries between 1992-2018. In addition, the control of GDP and fixed capital investments were also used as variables in the study. G20 countries are included in the analysis since they have the highest CO₂ emissions (Kong et al., 2022). The variables were tested with panel data analysis. According to the cointegration test results of Gengenbach, Urbain, and Westerlund (2016), there is a long-running negative panel cointegration relationship between renewable energy consumption, stock market capitalisation, and carbon emissions in G20 countries. Stock market capitalisation is an important part of global financial development. Accordingly, countries must reduce carbon emissions to adapt to international financial development. On the other hand, a positive long-run panel cointegration relationship is found between GDP fixed

capital investments and carbon emissions. Our results support the EKC hypothesis, and carbon emissions and economic growth are related in the long run (Mahmoodi & Dahmardeh, 2022). Our results show that reducing countries' carbon emissions can increase their economic growth in the long run. Moreover, Dumitrescu and Hurlin's panel causality analysis finds a bidirectional relationship between the market capitalisation of G20 countries and carbon emissions; a unidirectional relationship is established from renewable energy consumption to carbon emissions. Accordingly, increases or decreases in carbon emissions affect market capitalisation and, thus, the level of financial development. Similarly, increases and decreases in market capitalisation affect carbon emissions. This is likely due to the high cost of investments required to reduce carbon emissions and the need for additional funds. On the other hand, no causality relationship was found between the control variables and carbon emissions.

6.2. Policy Recommendations

Activities to reduce carbon emissions in developed and developing countries continue without compromising financial and economic development. However, fossil fuels are still consumed in developing countries. Therefore, policymakers need to take action to encourage the consumption of renewable energy sources. Only some studies in the academic literature examine the relationship between market capitalisation and carbon emissions, one of the indicators of financial development. The motivation of this study is to increase the use of renewable energy resources by the decision-making mechanisms of countries, to provide incentives for sustainable economic development and to raise awareness of the increasing global problems and climate crises in recent years.

On the other hand, since renewable energy consumption and stock market capitalisation are related to carbon emissions in the long run, it is expected that the micro and macro-financial markets of countries will expand, and the stock market capitalisation of firms will increase if policymakers support activities to reduce carbon emissions. As long as countries use technologies to use their resources efficiently, there is an increase in firms' financial and market capitalisation in the long run, thus creating similar expectations in countries. Our study provides significant findings for policymakers and firms. Here, our findings show that the development of market capitalisation supports low carbon emissions. Our findings are in line with those of Apergis et al. (2010), Alam et al. (2015), Paramati et al. (2017), Zeqiraj et al. (2020), Alam et al. (2021), and in the opposite direction to those of Zafar et al. (2019). Therefore, policymakers should incentivise firms to use technologies that increase renewable energy consumption. As a result of these incentives, firms are expected to increase their stock market value and obtain additional financing to invest in technologies suitable for renewable energy consumption. In parallel, efficient energy use and improvements in the financial system are expected to contribute to sustainable development policies. Therefore, policymakers need to realise the potential of stock exchanges to minimise CO₂ emissions. In this context, it is necessary to develop effective and sustainable policies to ensure that all listed firms adopt energy efficiency and green technologies in their production activities.

References

- Alam, A. et al. (2015), "Does financial development contribute to SAARC's energy demand? From energy crisis to energy reforms", *Renewable and Sustainable Energy Reviews*, 41, 818-829.
- Alam, M.S. et al. (2021), "The impacts of R&D investment and stock markets on clean-energy consumption and CO2 emissions in OECD economies", *International Journal of Finance and Economics*, 26(4), 4979-4992.
- Apergis, N. & M.C.K. Lau (2015), "Structural breaks and electricity prices: Further evidence on the role of climate policy uncertainties in the Australian electricity market", *Energy Economics*, 52, 176-182.
- Ashwin Kumar, N.C. et al. (2016), "ESG factors and risk-adjusted performance: a new quantitative model", *Journal of Sustainable Finance and Investment*, 6(4), 292-300.
- Bekaert, G. et al. (2001), "Emerging equity markets and economic development", *Journal of Development Economics*, 66(2), 465-504.
- Bhat, M.Y. et al. (2022), "Domino-effect of energy consumption and economic growth on environmental quality: role of green energy in G20 countries", *Management of Environmental Quality: An International Journal*, 33(3), 756-775.
- Bhattacharya, M. et al. (2016), "The effect of renewable energy consumption on economic growth: Evidence from top 38 countries", *Applied Energy*, 162, 733-741.
- BloombergNEF, (2021), New Energy Outlook 2022, <<https://about.bnef.com/new-energy-outlook/>>, 09.02.2021.
- Breuer, J.B. et al. (2001), "Misleading inferences from panel unit-root tests with an illustration from purchasing power parity", *Review of International Economics*, 9(3), 482-493.
- Breusch, T.S. & A.R. Pagan (1980), "The Lagrange Multiplier Test and its Applications to Model Specification in Econometrics", *The Review of Economic Studies*, 47(1), 239-253.
- Dasgupta, S. et al. (2001), "Pollution and capital markets in developing countries", *Journal of Environmental Economics and Management*, 42(3), 310-335.
- De Haas, R. & A.A. Popov (2019), "Finance and Carbon Emissions", *SSRN Electronic Journal*, 2318.
- Dumitrescu, E.I. & C. Hurlin (2012), "Testing for Granger non-causality in heterogeneous panels", *Economic Modelling*, 29(4), 1450-1460.
- Gengenbach, C. et al. (2016), "Error Correction Testing in Panels with Common Stochastic Trends", *Journal of Applied Econometrics*, 31, 982-1004.
- Grileiro, J. (2019), *Exploiting an Investment Opportunity Based on ESG Score*, Católica-Lisbon School of Business & Economics.
- Gurley, J.G. & E.S. Shaw (1955), "Financial Aspects of Economic Development", *The American Economic Review*, 45(4), 515-538.
- Kong, Y. et al. (2022), "Peaking Global and G20 Countries' CO2 Emissions under the Shared Socio-Economic Pathways", *International Journal of Environmental Research and Public Health*, 19(17), 11076.
- Li, Z. et al. (2020), "Analysis of Stock Market Development and CO2 Emissions on OECD Countries via an Empirical Model", *Clean - Soil, Air, Water*, 48(4), 1-12.

- Mahmoodi, M. & N. Dahmardeh (2022), "Environmental Kuznets Curve Hypothesis With Considering Ecological Footprint and Governance Quality: Evidence From Emerging Countries", *Frontiers in Environmental Science*, 10(March), 1-11.
- Minier, J. (2009), "Opening a stock exchange", *Journal of Development Economics*, 90(1), 135-143.
- Nazlioglu, S. et al. (2011), "Nuclear energy consumption and economic growth in OECD countries: Cross-sectionally dependent heterogeneous panel causality analysis", *Energy Policy*, 39(10), 6615-6621.
- Paramati, S.R. et al. (2017), "The effects of stock market growth and renewable energy use on CO2 emissions: Evidence from G20 countries", *Energy Economics*, 66, 360-371.
- Pedroni, P. (2001), "Purchasing power parity tests in cointegrated panels", *Review of Economics and Statistics*, 83(4), 727-731.
- Pesaran, M.H. & T. Yamagata (2008), "Testing slope homogeneity in large panels", *Journal of Econometrics*, 142(1), 50-93.
- Pesaran, M.H. (2004), "General Diagnostic Tests for Cross Section Dependence in Panels", *SSRN Electronic Journal*, 1240.
- Pesaran, M.H. (2007), "A Simple Panel Unit Root Test in the Presence of Cross-Section Dependence", *Journal of Applied Econometrics*, 22(2), 265-312.
- Pesaran, M.H. et al. (2008), "A bias-adjusted LM test of error cross-section independence", *Econometrics Journal*, 11(1), 105-127.
- Roberts, D. et al. (2019), *IPCC, 2018: Global Warming of 1.5°C*.
- Sadorsky, P. (2010a), "The impact of financial development on energy consumption in emerging economies", *Energy Policy*, 38(5), 2528-2535.
- Sadorsky, P. (2010b), "The impact of financial development on energy consumption in emerging economies", *Energy Policy*, 38(5), 2528-2535.
- Solomon, S. et al. (2009), "Irreversible climate change due to carbon dioxide emissions", *Proceedings of the National Academy of Sciences of the United States of America*, 106(6), 1704-1709.
- Wang, Q. & Z. Dong (2021), "Does financial development promote renewable energy? Evidence of G20 economies", *Environmental Science and Pollution Research*, 28(45), 64461-64474.
- Xu, Z. (2000), "Financial development, investment, and economic growth", *Economic Inquiry*, 38(2), 331-344.
- Yerdelen-Tatoğlu, F. (2018), *Panel Time Series Analysis*, Beta Publishing.
- Yuping, L. et al. (2021), "Determinants of carbon emissions in Argentina: The roles of renewable energy consumption and globalization", *Energy Reports*, 7, 4747-4760.
- Zafar, M.W. et al. (2019), "The role of stock market and banking sector development, and renewable energy consumption in carbon emissions: Insights from G-7 and N-11 countries", *Resources Policy*, 62, 427-436.
- Zeqiraj, V. et al. (2020), "Stock market development and low-carbon economy: The role of innovation and renewable energy", *Energy Economics*, 91, 104908.
- Zeren, F. & M. Koc (2014), "The nexus between energy consumption and financial development with asymmetric causality test: New evidence from newly industrialized countries", *International Journal of Energy Economics and Policy*, 4(1), 83-91.

Determination of the Factors Affecting Divorce in Türkiye According to Gender: A Research with TUIK Data

Özlem KURU-SÖNMEZ (<https://orcid.org/0000-0003-0208-4781>), *Osmaniye Korkut Ata University, Türkiye;*
ozlemkuru@osmaniye.edu.tr

Emre YAKUT (<https://orcid.org/0000-0002-1978-0217>), *Osmaniye Korkut Ata University, Türkiye;*
emreyakut@osmaniye.edu.tr

Türkiye’de Boşanmayı Etkileyen Faktörlerin Cinsiyete Göre Belirlenmesi: TUIK Verileri Üzerinde Bir Araştırma

Abstract

This study aims to determine the factors affecting the divorces of men and women in Türkiye and the effects of these factors on the probability of divorce. For this purpose, the survey data of 24200 people, 55% women and 45% men, were used in the Family Structure Research carried out by TUIK in 2016. In the research, Pearson’s chi-square analysis was performed first to determine the factors affecting the divorces of individuals. Then, logit and probit regression analyses were applied to the variables found to be significant. As a result of the analysis, it was determined that some of the sociodemographic and socioeconomic variables significantly affect individuals' divorce status.

Keywords : Divorce Reasons, Divorce Probability, Logistic Regression Model, Probit Regression Model.

JEL Classification Codes : J12, J19, C19, C25.

Öz

Bu çalışmanın amacı Türkiye’deki kadın ve erkeklerin boşanmalarını etkileyen faktörleri ve bu faktörlerin boşanma olasılığı üzerindeki etkilerini belirlemektir. Bu amaç doğrultusunda TUIK’in 2016 yılında gerçekleştirdiği Aile Yapısı Araştırmasında %55’ni kadınların ve %45’ini erkeklerin oluşturduğu, 24200 kişinin anket verileri kullanılmıştır. Araştırmada ilk olarak bireylerin boşanmaları üzerinde etkili olan faktörleri belirlemek için Pearson ki-kare analizi gerçekleştirilmiş, sonrasında anlamlı bulunan değişkenlere logit ve probit regresyon analizleri uygulanmıştır. Analizler sonucunda sosyodemografik ve sosyoekonomik değişkenlerin bazılarının bireylerin boşanma durumları üzerinde anlamlı bir etkiye sahip olduğu belirlenmiştir.

Anahtar Sözcükler : Boşanma Sebepleri, Boşanma Olasılıkları, Lojistik Regresyon Modeli, Probit Regresyon Modeli.

1. Introduction

In our century, technological developments have led to radical socioeconomic changes in social and business life. As evidence of these changes, people from different nations have similar experiences on a global scale (Sütçü & Duyan, 2021). Thus, cultures come closer, and nations quickly and easily get news from others, changing family structures and social relations and revealing different family roles for women, men and children. In addition to technological developments, legal developments favouring gender equality also create differences in individuals' perceptions of divorce. Divorce has become more achievable in many societies compared to the past. However, this is not enough to eliminate the negative effects of divorce on family structure and spouses. In Türkiye, women have difficulties starting immediately with their decision to divorce. They are often exposed to negative reactions from many parts of society, especially their families. They also have severe social and legal challenges when their husbands are not willing to divorce. After the divorce, women often face economic difficulties and social pressure (Kucur & Kelebek, 2021). Aktaş (2018) reported that all divorced men were disappointed in their spouses, did not receive their wife's support and attention in material and moral senses, and had communication problems with their wives. However, psychological problems, social alienation, performance and motivation problems at work, economic problems and social pressure occur in men after divorce. Divorce also affects children. Divorce is not just about a couple ending their married life but a process leading to lifestyle changes of other family members (Aktaş & Uray, 2021). Therefore, the psychological development of children is negatively affected both during and after divorce, causing child attachment issues. In addition, psychological issues such as anger control problems, feelings of guilt, sleep and nutrition problems, introversion, academic failure, separation anxiety and restlessness are seen in children of different ages during and/or after divorce (Sütçü & Duyan, 2021: 35-38). As divorces in which children are affected negatively cause social problems, it has become more of an issue to understand and prevent the causes of the increased number of divorces for the future of children.

Divorce is a situation that affects all family members and causes psychological and sociological problems that lead to social dimensions. However, although it is stated that various factors are effective in divorce for men and women, it is noted that the most critical factor is the differentiation of expectations about life with the breaking of ties between spouses (Crowley, 2019; Güven & Koroğlu, 2023: 3). When divorce is evaluated psychologically, it is seen as a phenomenon that causes serious problems that profoundly affect all members of the family by disrupting family integrity (Arpacı & Tokyürek, 2012: 2).

Since divorce has been increasing in recent years and individuals' attitudes towards it differ, it has become a situation that needs to be emphasised since it causes a severe problem in social life (Uğur, 2014: 294). It is stated that the changing responsibilities of women in family and business life, economic factors, and the rise of the individual instead of the family coming to the forefront are effective in the increase in divorce rates (Elmas &

Adak, 2023: 86). In addition, another reason for the rise in divorces is that women are exposed to domestic violence, and women who have economic freedom can decide to divorce more easily by arousing the thought that they can live alone (Kutlar et al., 2012). In addition, many reasons, such as technological developments, the health status of spouses, having children, and consumption-oriented individualisation, affect domestic divorces (Kaya & Eren, 2020: 710).

While the increase in divorce rates in Türkiye has been examined in a problem-oriented manner, the detailed analysis of the studies on the differentiation of the reasons for divorce by gender has not been sufficiently addressed. In this context, examining the divorce issue in more detail is important. Today's increasing divorce problem can be solved if the reasons for divorce by gender are known. In this context, as pointed out above, to analyse the divorce phenomenon, which causes the end of families and marriages and causes the emergence of social and psychological situations, it is important to examine the factors that affect the divorce of women and men according to gender. Thus, it is thought that the findings obtained from the research results can play a decisive role in preventing divorces by determining the reasons for divorce of women and men.

The study consists of four chapters: the first chapter is the introduction, the second chapter is the literature review of the study, the third chapter is the purpose of the study under the title of material and method study, the fourth chapter is the analysis application, and the last chapter is the discussion and conclusion.

2. Literature Review

In this part of the study, a literature review of the studies on divorce research is given.

Savaya and Cohen (2003), in their study on the social image of 312 divorced Muslim women and men in Israel, tried to examine the adaptation of divorced individuals after divorce and how they evaluate themselves in terms of social image. As a result of the study, they revealed that women were exposed to social stigmatisation more than men.

Bulut (2008) conducted a study on 40 women who received treatment after divorce in the Ankara University Faculty of Medicine Psychiatry Department and tried to explain that although the majority of divorced women were educated and working individuals, they faced domestic violence and the difficulties they faced after divorce.

Arapacı & Tokyürek (2012) tried to examine the views of divorced individuals on remarriage in a study conducted on 106 divorced individuals in Ankara. In the process of the study, they determined that divorced individuals' differences of opinion, intervention of relatives such as parents, economic reasons, incompatibility due to differences in social environment, and physical and psychological violence were among the reasons for divorce.

Uğur (2014) conducted a study on divorced academic women at Akdeniz University and tried to determine the factors affecting women's divorce decisions. As a result of the

study, she emphasised that miscommunication between spouses, failure to meet the expectations of women from marriage, financial problems, unemployment of the spouse and inability to fulfil family responsibilities were influential in the decision to divorce.

Can & Aksu (2016), in a study with ten women between the ages of 33-67 conducted with the interview technique, stated that women who decide to divorce are educated, have income, are self-confident women and women who receive support from their families choose to divorce more quickly. However, they also stated that women were worried about children, social pressure and family-environment reactions before deciding to divorce.

Kaya (2016), in a study conducted on divorced women and men in Istanbul, tried to determine the problems affecting divorce by examining their divorce experiences. As a result of the study, while the common issues among the reasons for divorce of women and men were economic, family-related and sexual problems, it was revealed that at the point where the reasons for divorce differed, deception and irresponsibility were prominent for women. In contrast, jealousy and the end of the feeling of excitement were important for men.

Sevim et al. (2016) conducted a sociological study on men's perspective on divorce, the divorce process and the problems they experience during and after the divorce in a study in which they analysed 300 divorce cases in Elazığ Courthouse between 2008-2010. As a result of the study, they revealed that the reasons for divorce among men include factors such as severe incompatibility, infidelity, disagreement, cultural differences and abandonment.

Aktaş (2018) conducted a study on divorced men and investigated the impact of divorce on men. In the study, he stated that divorce affects men. He emphasised that urbanisation, social mobility, understanding, women's participation in the labour force and happiness concepts affect men's divorce preferences.

Leopold (2018) examined whether the reasons for divorce of individuals differ according to gender by using the panel regression model in a study conducted on 18,030 individuals, 1220 of whom were divorced in Germany. As a result of the study, it was revealed that there is a general similarity rather than a differentiation between the reasons for divorce of men and women. In this context, they concluded that economic factors, home ownership, satisfaction with housework, mental health, physical health and psychological well-being are influential in the divorce phenomenon.

Gökmen et al. (2019) tried to determine the factors affecting divorce using the Cox regression method with data from TurkStat's 2016 Family Structure Survey. As a result of the study, they decided that income, education, place of residence, having children, internet, gambling, and betting games have a negative impact on marital life.

Altun et al. (2020) tried to evaluate the reasons for divorce in terms of communication in a study applied to 208 divorced individuals. As a result of the study, they revealed that the reasons for divorce included change in expectations, infidelity, the inability of the spouse

to fulfil duties and responsibilities, communication problems with the spouse's family and child-rearing problems.

Kaya & Eren (2020) tried to examine the factors that cause the increase in divorce in the family through TUIK's divorce data for 2019-2020. As a result of the study, they emphasised that the first five years of marriage are critical. They stated that sociocultural and socio-economic reasons, as well as religious beliefs, health status, technology, spouses' perspective on marriage, spousal violence and psychological reasons, are effective among the reasons for divorce.

Gavcar et al. (2020) applied regression analysis and t-test analysis to the survey data to determine the factors affecting divorce and the factors affecting the duration of marriage in a study used on 250 divorced individuals in the Fethiye district of Muğla. As a result of the survey, they emphasised that the most influential factor in divorce is the severe incompatibility between spouses and that the most affected family members after divorce are children.

Aktaş & Uray (2021), in a sociological study conducted on divorced men, tried to investigate men's perspective on marriage, how the process before and after divorce is experienced, and the impact of divorce on their social lives. The study stated that the most critical factor affecting the decision to divorce was the failure to meet economic and emotional expectations. As a result of the study, it was revealed that men experienced psychological problems, withdrawal from the social environment, issues of performance and motivation at work, economic problems and social pressure after divorce.

Khan and Hamid (2021) conducted a study on 20 divorced women residing in the Kashmir region of India. He found that the reasons for divorce were domestic violence, infidelity, second marriage of the spouse, lack of children and incompatibility. In addition, they tried to explain how the social relations of divorced women are restricted in many ways and how the negative perspective of society towards them affects their lives as a result.

Kucur & Kelebek (2021) conducted sociological research to determine the divorce process and the problems experienced by 14 divorced women who received help from the Social Service Centre Unit in Istanbul. As a result of the study, they tried to determine that the spouse's substance abuse, violence and miscommunication were influential in the divorce process, that this situation damaged the marriage process, and the problems faced by women after divorce.

Kelebek-Küçükarslan & Cankurtaran (2022) conducted a study on 13 divorced women in Ankara and tried to investigate the problems experienced by women during and after the divorce process. As a result of the study, they mentioned spousal violence as one of the reasons for divorce and mentioned coping strategies and practices to raise awareness.

Elmas & Adak (2023) tried to use multiple reciprocity analyses to determine whether the factors affecting the divorce of men and women differ by gender using the Family

Structure Survey of TurkStat data for 2021. As a result of the study, they emphasised that the reasons for divorce in Türkiye differed for men and women and determined that the irresponsible and indifferent behaviour of the spouse, the inability to provide for the household economically and the participation of family elders in the family relations are among the most important reasons affecting divorce.

3. Data and Methodology

In statistical modelling, binary logit and probit regression methods are applied in categorical structures where the dependent variable has two categories. These two methods are preferred in cases such as yes-no and successful-failure in two-choice data, which is the most common use of categorical data.

3.1. Logit Regression Model

The logit regression model is the model preferred by users because the dependent variable has two categories, there is no normality assumption condition, and it is based on the cause-and-effect relationship between dependent and independent variables (Alkan, 2017: 37). While the odds ratio determines the basis of the logit regression model, the model is established by taking the natural logarithm of the ratio of the probability of an event occurring to the probability of not happening, and the likelihood method is used when estimating the parameters of the model (Hosmer et al., 2013). The two-category binary logit regression model is as follows (O'Connell, 2006: 13):

$$L_i = \ln \left(\frac{P_i}{1 - P_i} \right) = \beta_0 + \beta_1 X$$

In the logit regression model, marginal effects should be calculated and interpreted to estimate the impact of independent variable coefficients on the probability of the dependent variable. In this context, while keeping other variables constant in the logit model, the marginal effect of each variable is calculated as follows (Özer et al., 2006; Alkan & Demir, 2019: 1231):

$$\frac{dP_i}{dx_1} = P_i(1 - P_i)\beta_1$$

3.2. Probit Regression Model

The Probit regression model, used as an alternative to the logistic regression model, is a non-linear modelling analysis applied to categorical data analysis. This method calculates the probability of categorical data falling into one of the binary states (Çicek & Arlı, 2021: 656). In the probit regression model, the classification process is carried out by applying the cumulative normal distribution using the standard normal distribution (Gujarati & Porter, 2009). The calculation formulation of the probability of selection in the probit regression model is given below (Kalaycı, 2010: 301; Altıntaş, 2021: 445):

$Y_i = 1$ and if $\alpha + \beta X_i > 0$; $Y_i = 0$ and if $\alpha + \beta X_i \leq 0$ where the dependent variable category takes the value 1 when $Y_i^* > 0$ and 0 when $Y_i^* \leq 0$. If $\Phi(z)$ is expressed as a cumulative normal distribution function for the normal standard variable z , the equation is obtained as follows.

$$\Phi(z) = P(Z \leq z)$$

$$P(Y_i = 1) = 1 - \Phi\left(\frac{-\alpha - \beta X_i}{\sigma}\right) \text{ and } P(Y_i = 0) = 1 - \Phi\left(\frac{-\alpha - \beta X_i}{\sigma}\right)$$

When more than one independent variable is used, the probit regression model is defined as $P\left(Y = \frac{1}{X}\right) = \Phi(X\beta)$.

3.3. Subject, Purpose, Importance and Contribution to the Literature

Divorce is the legal termination of marriage, which causes social problems by deeply affecting all members of the family. Considering the divorce situation in today's social life, it is possible to say that divorce negatively affects women, men and children who are members of the family. For this reason, understanding the reasons for divorce is important in terms of preventing divorce. The fact that the reasons for divorce and the post-divorce situations of women and men may differ has been tried to be explained in some of the above studies in the literature. Since divorce causes severe changes in psychological, social and economic terms, it is understood how important it is to take precautions before divorce causes challenging individual and social problems. In this context, this study aims to determine the factors affecting the divorce of women and men in Türkiye according to gender differences and the effects of these factors on the probability of divorce.

The gains that the study can contribute to the literature are summarised as follows:

To contribute to social cohesion by determining the causes of this process, which has negative psychological and social effects on individuals and children. When the research on divorce is examined, the research on the differentiation of the reasons for divorce according to gender has not been sufficiently studied except for a few studies (Elmas & Adak, 2023; Leopold, 2018; Kaya, 2016). At this point, it is important to analyse in depth by determining that the phenomenon of divorce is not so simple and how the reasons for divorce differ according to gender. This research is thought to contribute to this gap in the literature to identify the factors that affect the reasons for divorce of men and women and to determine the effect of these factors on the likelihood of divorce. In this way, it is thought that understanding the reasons for divorce can help to create healthier family relationships and reduce social problems by preventing divorce. In addition, it may provide suggestions to organisations and policymakers who offer support services for families.

3.4. Data and Variable Definitions Used in the Study

The dataset of this study is obtained the data from the Family Structure Survey: 2016 (Türkiye İstatistik Kurumu [TUIK], 2017) published by the Turkish Statistical Institute (TUIK); the data is not available to the public and is used subject to the specific permission of the institution.

Dependent variable: The study's dependent variable is the divorce status variable according to gender differences. In this study, the dependent variable is the divorce status variable, and the dependent variable category takes the value 1 for those who have been married and divorced before and 0 for those who have not been divorced. The family structure survey eliminated single "never married" participants from the data set.

Independent variables: The independent variables of the study consist of the variables available in TUIK's Family Structure Survey and the variables highlighted by the literature review. The independent variables of the study are age (16-25, 26-35, 36-45, 46-55, 55+), place of residence (city centre, district centre, village and rural area), employment status (private sector, public sector, not working), average monthly income level (0-1300 TL, 1301-2600 TL, 2601-3900 TL and 3901 TL and above), age at first marriage (12-17, 18-23, 24-29, 30+), age of the spouse in marriage (12-17, 18-23, 24-29, 30+), age difference with the spouse in marriage (0-5, 6-10, 11-15, 16+), duration of marriage (0-12, 13-25, 26-38, 39+), marriage decision variable (arranged marriage by asking, without asking, own decision without family permission, own decision with family permission, other (abduction, etc.)), having children (yes, no), do you find it appropriate for women to work (yes, no), individual happiness (happy, moderate, unhappy), family happiness (happy, moderate, low), smoking status (yes, no), alcohol use status (yes, no), region (TR1, TR2, TR3, TR4, TR5, TR6, TR7, TR8, TR9, TRA, TRB, TRC). In addition to demographic and socioeconomic variables, 22 questions could cause divorce.

3.5. Research Analyses

The frequency and percentage values were calculated for the survey data. Pearson's chi-square analysis was performed in the SPSS 18 package program to determine the relationship between the dependent (divorce status) and independent variables. Then, independent variables that had a statistically significant relationship with the divorce status were included in logit and probit regression analyses using the Stata 14 package program, and the marginal effects of the variables affecting the probability of divorce were calculated and interpreted.

In the two-state logit and probit regression models, there is no need to perform any operation if the independent variables are numerical independent variables. Still, when two-category independent variables are included in the model, one of the desired categories can be selected as the reference category. The change in the logit and probit on the dependent variable can be calculated accordingly. For example, when the dependent variable is the

cancer status of the individual, and the independent variable is smoking status, the risk of smokers getting cancer compared to non-smokers can be explained by giving the code 0 to non-smokers and 1 to smokers. However, suppose the independent variable is an independent variable with more than two categories. In that case, a dummy variable is created as one less than the number of categories, and the change in the logit and probit on the dependent variable according to the reference category is interpreted. The reference category usually has the lowest or highest risk among the independent variable categories. For example, when examining the effect of a family history of cancer, which is a three-category independent variable, on the dependent variable, the individual's risk of developing cancer, the code 0 is given for no history of cancer, 1 for second-degree relatives with a history of cancer, 0 for other categories, 1 for first-degree relatives with a history of cancer and 0 for different categories. Thus, an independent variable with three categories is created. From this point, to determine a reference category for one of the categories, the category with the lowest or highest risk is selected, and the change of the dependent variable in logit and probit is interpreted according to the reference category of the other categories. In other words, when those without a history of cancer are selected as the reference category among the categories of cancer history, the risk or marginal effects are calculated, and the probabilities obtained are interpreted (O'Connell, 2006; Alpar, 2011: 654, 655; Çokluk et al., 2012; Hosmer et al., 2013).

A multicollinearity test was performed to determine the multicollinearity between the independent variables included in the logit and probit regression models. As a result, variables with a variance inflation factor (VIF) of 10 or higher were excluded from the models, assuming they caused multicollinearity (Alkan & Abar, 2020).

The IRB review of the study was approved by the Social Sciences Research and Publication Ethics Committees of Osmaniye Korkut Ata University with document number 12369 dated October 7, 2022, and the decision numbered 2022/16/7.

4. Findings

4.1. Descriptive Statistics

In the research, 13995 participants who participated in the Family Structure Survey conducted by TURKSTAT in 2016 were female and 10805 were male. As seen in Table 1, 8.46% of the female and 7.58% of the male respondents were divorced.

Descriptive statistics in Table 1 are summarised as follows: It was determined that 29.4% of the women and 33.4% of the men were 55 years of age or older, 42.5% of the women and 44.1% of the men resided in the village, 75.8% of the women were not employed, and 55.4% of the men were private sector employees. When the monthly net income variable was analysed, it was determined that 85.4% of women and 42.7% of men had a monthly net income between 0-1300 TL and 1301-2600 TL, respectively. When the age of the participants' first marriage was analysed, it was determined that 53.3% of the women were between 18 and 23, and 43.4% of the men were between the ages of 24 and 29.

When the duration of marriage of the respondents was analysed, 29.1% of women and 28.6% of men were in the 13-25 year range, and 47.6% of women and 49.2% of men explained that they decided to marry without an arranged marriage according to the marriage decision variable. Regarding the type of marriage, 97.3% of the women and 97.4% of the men stated that they had both civil and religious marriages, while 49.8% of the women and 47.1% of the men indicated that they met their spouses through family relatives. 93% of the women and 93% of the men who participated in the survey indicated they had children. 91.2% of women and 76.6% of men agreed with "Do you find it appropriate for women to work?". When the individual happiness of the participants was analysed, 73% of women and 76.6% of men stated that they were happy, while 74.4% of women and 77.2% of men indicated that they were happy when family happiness was analysed. When the smoking status of the individuals was analysed, it was understood that 18.5% of women and 45.1% of men smoked cigarettes, and 11.2% of women and 23.4% of men used alcohol. When the statistical regions of the respondents were analysed, it was determined that 15.4% were located in the TR3 region.

Table 1 presents the frequencies and percentages of the participants' demographic and socioeconomic characteristics and the p values of the chi-square test performed for the relevant variables. The chi-square test results showed that all demographic and socioeconomic variables were significant.

Table: 1
Frequencies and Percentages of Some Demographic and Socioeconomic Characteristics of the Participants

Variable	Male (n=10805)			χ^2	Female (n=13995)			χ^2
	Divorced (n=819)	Not divorced (n=9986)	All Male (N=10805)		Divorced (n=1184)	Not divorced (n=12811)	All Female (N=13995)	
Age				0.000*				0.000*
16-25 years	5 (0.6%)	159 (1.6%)	164 (1.5%)		49 (4.1%)	759 (5.9%)	808 (5.8%)	
26-35 years	102 (12.5%)	1802 (18.0%)	1904 (17.6%)		226 (19.1%)	2707 (21.1%)	2933 (21%)	
36-45 years	219 (26.7%)	2469 (24.7%)	2688 (24.9%)		368 (31.1%)	2998 (23.4%)	3366 (24.1%)	
46-55 years	212 (25.9%)	2232 (22.4%)	2444 (22.6%)		255 (21.5%)	2521 (19.7%)	2776 (19.8%)	
55 years or above	281 (34.3%)	3324 (33.3%)	3605 (33.4%)		286 (24.2%)	3826 (29.9%)	4112 (29.4%)	
Residential type				0.000*				0.000*
City centre	318 (38.8%)	2934 (29.4%)	3252 (30.1%)		487 (41.1%)	3832 (29.9%)	4319 (30.9%)	
Town centre	225 (27.5%)	2421 (24.2%)	2646 (24.5%)		330 (27.9%)	3148 (24.6%)	3478 (24.9%)	
Village	262 (32%)	4499 (45.1%)	4761 (44.1%)		333 (28.1%)	5608 (43.8%)	5941 (42.5%)	
Abroad	14 (1.7%)	132 (1.3%)	146 (1.4%)		34 (2.9%)	223 (1.7%)	257 (1.8%)	
Employment Status				0.000*				0.000*
In private sector	434 (53%)	5550 (55.6%)	5984 (55.4%)		332 (28%)	2362 (18.4%)	2694 (19.2%)	
In public sector	60 (7.3%)	1261 (12.6%)	1321 (12.2%)		77 (6.5%)	611 (4.8%)	688 (4.9%)	
Not working	325 (39.7%)	3175 (31.8%)	3500 (32.4%)		775 (65.5%)	9838 (76.8%)	10613 (75.8%)	
Average monthly net income				0.005*				0.000*
0-1300 TL	318 (38.8%)	3311 (33.2%)	3629 (33.6%)		861 (72.7%)	11085 (86.5%)	11946 (85.4%)	
1301-2600 TL	316 (38.6%)	4301 (43.1%)	4617 (42.7%)		195 (16.5%)	1106 (8.6%)	1301 (9.3%)	
2601-3900 TL	101 (12.3%)	1408 (14.1%)	1509 (14%)		66 (5.6%)	432 (3.4%)	498 (3.6%)	
3901 TL or above	84 (10.3%)	966 (9.7%)	1050 (9.7%)		62 (5.2%)	188 (1.5%)	250 (1.8%)	
Age at first marriage				0.000*				0.000*
12-17	53 (6.5%)	543 (5.4%)	596 (5.5%)		383 (32.3%)	3438 (26.8%)	3821 (27.3%)	
18-23	348 (42.5%)	4118 (41.2%)	4466 (41.3%)		582 (49.2%)	6879 (53.7%)	7461 (53.3%)	
24-29	308 (37.6%)	4380 (43.9%)	4688 (43.4%)		172 (14.5%)	2091 (16.3%)	2263 (16.2%)	
30 or above	110 (13.4%)	945 (9.5%)	1055 (9.8%)		47 (4%)	403 (3.1%)	450 (3.2%)	
Age of spouse in first marriage				0.000*				0.000*
12-17	131 (16%)	2255 (22.6%)	2386 (22.1%)		58 (4.9%)	698 (5.4%)	756 (5.4%)	
18-23	466 (56.9%)	5518 (55.3%)	5984 (55.4%)		476 (40.2%)	5207 (40.6%)	5683 (40.6%)	
24-29	173 (21.1%)	1877 (18.8%)	2050 (19%)		467 (39.4%)	5485 (42.8%)	5952 (42.5%)	
30 or above	49 (6%)	336 (3.4%)	385 (3.6%)		183 (15.5%)	1421 (11.1%)	1604 (11.5%)	

Age difference with spouse in first marriage				0.003 ^a				0.000 ^a
0-5	637 (77.8%)	7252 (72.6%)	7889 (73%)		739 (62.4%)	8727 (68.1%)	9466 (67.6%)	
6-10	154 (18.8%)	2398 (24%)	2552 (23.6%)		331 (28%)	3329 (26%)	3660 (26.2%)	
11-15	22 (2.7%)	299 (3%)	321 (3%)		75 (6.3%)	575 (4.5%)	650 (4.6%)	
16 or above	6 (0.7%)	37 (0.4%)	43 (0.4%)		39 (3.3%)	180 (1.4%)	219 (1.6%)	
Year of last (or longest) marriage				0.000 ^a				0.000 ^a
0-12	459 (56.1%)	2620 (26.2%)	3079 (28.5%)		690 (58.3%)	3298 (25.7%)	3988 (28.5%)	
13-25	209 (25.5%)	2876 (28.8%)	3085 (28.6%)		337 (28.5%)	3740 (29.2%)	4077 (29.1%)	
26-38	88 (10.7%)	2365 (23.7%)	2453 (22.7%)		106 (9%)	3001 (23.4%)	3107 (22.2%)	
39 or above	63 (7.7%)	2125 (21.3%)	2188 (20.2%)		51 (4.3%)	2772 (21.6%)	2823 (20.2%)	
Marriage decision method				0.002 ^b				0.000 ^a
Arranged by asking	63 (7.7%)	864 (8.7%)	927 (8.6%)		182 (15.4%)	1853 (14.5%)	2035 (14.5%)	
Arranged, without being asked	357 (43.6%)	4960 (49.7%)	5317 (49.2%)		439 (37.1%)	6226 (48.6%)	6665 (47.6%)	
Own decision without family permission	28 (3.4%)	228 (2.3%)	256 (2.4%)		65 (5.5%)	301 (2.3%)	366 (2.6%)	
Own decision, with family permission	303 (37%)	3253 (32.6%)	3556 (32.9%)		388 (32.8%)	3468 (27.1%)	3856 (27.6%)	
Other (abduction, bride exchange, etc.)	68 (8.3%)	681 (6.8%)	749 (6.9%)		110 (9.3%)	963 (7.5%)	1073 (7.7%)	
Type of wedding				0.000 ^a				0.000 ^a
Both civil and religious marriage	731 (89.3%)	9788 (98%)	10519 (97.4%)		1055 (89.1%)	12562 (98.1%)	13617 (97.3%)	
Only civil marriage	52 (6.3%)	145 (1.5%)	197 (1.8%)		49 (4.1%)	153 (1.2%)	202 (1.4%)	
Only religious marriage	36 (4.4%)	53 (0.5%)	89 (0.8%)		80 (6.8%)	96 (0.7%)	176 (1.3%)	
Way to meet your spouse				0.000 ^a				0.000 ^a
Family-relative	272 (33.2%)	4817 (48.2%)	5089 (47.1%)		412 (34.8%)	6563 (51.2%)	6975 (49.8%)	
Neighbourhood	214 (26.1%)	3041 (30.5%)	3255 (30.1%)		327 (27.6%)	3684 (28.8%)	4011 (28.7%)	
School-course	20 (2.4%)	413 (4.1%)	433 (4%)		41 (3.5%)	486 (3.8%)	527 (3.8%)	
Business environment	134 (16.4%)	706 (7.1%)	840 (7.8%)		156 (13.2%)	792 (6.2%)	948 (6.8%)	
Circle of friends	161 (19.7%)	952 (9.5%)	1113 (10.3%)		231 (19.5%)	1214 (9.5%)	1445 (10.3%)	
Other (internet, etc.)	18 (2.2%)	57 (0.6%)	75 (0.7%)		17 (1.4%)	72 (0.6%)	89 (0.6%)	
Having children				0.000 ^a				0.000 ^a
Yes	701 (85.6%)	9352 (93.7%)	10053 (93%)		1009 (85.2%)	12014 (93.8%)	13023 (93.1%)	
No	118 (14.4%)	634 (6.3%)	752 (7%)		175 (14.8%)	797 (6.2%)	972 (6.9%)	
Do you find it appropriate for women to work?				0.001 ^b				0.000 ^a
Yes	666 (81.3%)	7615 (76.3%)	8281 (76.6%)		1115 (94.2%)	11642 (90.9%)	12757 (91.2%)	
No	153 (18.7%)	2371 (23.7%)	2524 (23.4%)		69 (5.8%)	1169 (9.1%)	1238 (8.8%)	
Individual happiness				0.000 ^a				0.000 ^a
Happy	506 (61.8%)	7771 (77.8%)	8277 (76.6%)		686 (57.9%)	9533 (74.4%)	10219 (73%)	
Medium	231 (28.2%)	1940 (19.4%)	2171 (20.1%)		363 (30.7%)	2807 (21.9%)	3170 (22.7%)	
Unhappy	82 (10%)	275 (2.8%)	357 (3.3%)		135 (11.4%)	471 (3.7%)	606 (4.3%)	
Family happiness				0.000 ^a				0.000 ^a
Happy	532 (65%)	7807 (78.2%)	8339 (77.2%)		736 (62.2%)	9680 (75.6%)	10416 (74.4%)	
Medium	214 (26.1%)	1711 (17.1%)	1925 (17.8%)		329 (27.8%)	2452 (19.1%)	2781 (19.9%)	
Unhappy	73 (8.9%)	468 (4.7%)	541 (5%)		119 (10.1%)	679 (5.3%)	798 (5.7%)	
Smoking				0.000 ^a				0.000 ^a
Yes	454 (55.4%)	4419 (44.3%)	4873 (45.1%)		469 (39.6%)	2121 (16.6%)	2590 (18.5%)	
No	365 (44.6%)	5567 (55.7%)	5932 (54.9%)		715 (60.4%)	10690 (83.4%)	11405 (81.5%)	
Alcohol				0.000 ^a				0.000 ^a
Yes	310 (37.9%)	2214 (22.2%)	2524 (23.4%)		208 (17.6%)	1364 (10.6%)	1572 (11.2%)	
No	509 (62.1%)	7772 (77.8%)	8281 (76.6%)		976 (82.4%)	11446 (89.3%)	12422 (88.8%)	
Statistical regional units' class				0.000 ^a				0.000 ^a
TR1	129 (15.8%)	1295 (13%)	1424 (13.2%)		179 (15.1%)	1561 (12.2%)	1740 (12.4%)	
TR2	63 (7.7%)	710 (7.1%)	773 (7.2%)		67 (5.7%)	811 (6.3%)	878 (6.3%)	
TR3	177 (21.6%)	1485 (14.9%)	1662 (15.4%)		243 (20.5%)	1852 (14.5%)	2095 (15%)	
TR4	73 (8.9%)	985 (9.9%)	1058 (9.8%)		121 (10.2%)	1210 (9.4%)	1331 (9.5%)	
TR5	118 (14.4%)	1334 (13.4%)	1452 (13.4%)		182 (15.4%)	1696 (13.2%)	1878 (13.4%)	
TR6	108 (13.2%)	1032 (10.3%)	1140 (10.6%)		147 (12.4%)	1333 (10.4%)	1480 (10.6%)	
TR7	33 (4%)	625 (6.3%)	658 (6.1%)		73 (6.2%)	854 (6.7%)	927 (6.7%)	
TR8	34 (4.2%)	633 (6.3%)	667 (6.2%)		53 (4.5%)	790 (6.2%)	843 (6%)	
TR9	20 (2.4%)	399 (4%)	419 (3.9%)		23 (1.9%)	540 (4.2%)	563 (4%)	
TRA	10 (0.01%)	322 (0.03%)	332 (0.03%)		15 (1.3%)	511 (4%)	526 (3.8%)	
TRB	20 (0.02%)	468 (0.04%)	488 (0.04%)		33 (2.8%)	688 (5.4%)	721 (5.2%)	
TRC	34 (0.04%)	698 (0.06%)	732 (0.06%)		48 (4.1%)	964 (7.5%)	1012 (7.2%)	

Note: Values in parentheses in the table show percentiles. ^ap<.001; ^bp<.05

The independent variables used in the study and the frequency, percentage values and chi-square test results related to the divorce status of individuals by gender are shown in Table 1. According to the results of the chi-square independence test, there is a significant relationship between the divorce status of individuals by gender and socio-economic and demographic variables. Table 2 presents the participants' demographic and socioeconomic variables and the frequency and percentage values of the factors that could affect the probability of divorce alone.

Table: 2
Frequency and Percentage of Variables That Alone Can Cause Divorce

Variable	Male (N=10805)			χ ²	Female (N=13995)			χ ²
	Divorced (n= 819)	Not divorced (n=9986)	All Male (N=10805)		Divorced (n=1184)	Not divorced (n=12811)	All Female (N=13995)	
DR_1 Is a woman's failure to do housework properly a definite reason for divorce?				0.000 ^a				0.404 ^a
Yes	186 (22.7%)	1536 (15.4%)	1722 (15.9%)		186 (15.7%)	1897 (14.8%)	2083 (14.9%)	
No	633 (77.3%)	8450 (84.6%)	9083 (84.1%)		998 (84.3%)	10914 (85.2%)	11912 (85.1%)	
DR_2 Is the man's failure to do his housework properly a definite reason for divorce?				0.000 ^a				0.005 ^b
Yes	67 (8.2%)	476 (4.8%)	543 (5%)		63 (5.3%)	474 (3.7%)	537 (3.8%)	
No	752 (91.8%)	9510 (95.2%)	10262 (95%)		1121 (94.7%)	12337 (96.3%)	13458 (96.2%)	
DR_3 Is the woman's inability to provide for the household economically a definite reason for divorce?				0.006 ^a				0.000 ^a
Yes	50 (6.1%)	408 (4.1%)	458 (4.2%)		96 (8.1%)	660 (5.2%)	756 (5.4%)	
No	769 (93.9%)	9578 (95.9%)	10347 (95.8%)		1088 (91.9%)	12151 (94.8%)	13239 (94.6%)	
DR_4 Is the man's inability to provide for the house economically a definite reason for divorce?				0.000 ^a				0.000 ^a
Yes	401 (49%)	4057 (40.6%)	4458 (41.3%)		692 (58.4%)	5404 (42.2%)	6096 (43.6%)	
No	418 (51%)	5929 (59.4%)	6347 (58.7%)		492 (41.6%)	7407 (57.8%)	7899 (56.4%)	
DR_5 Is a woman's catching a disease that is difficult to treat a definite reason for divorce?				0.000 ^a				0.001 ^b
Yes	26 (3.2%)	131 (1.3%)	157 (1.5%)		40 (3.4%)	253 (2%)	293 (2.1%)	
No	793 (96.8%)	9855 (98.7%)	10648 (98.5%)		1144 (96.6%)	12558 (98%)	13702 (97.9%)	
DR_6 Is a man's catching a disease that is difficult to treat a definite reason for divorce?				0.001 ^b				0.000 ^a
Yes	23 (2.8%)	138 (1.4%)	161 (1.5%)		42 (3.5%)	221 (1.7%)	263 (1.9%)	
No	796 (97.2%)	9848 (98.6%)	10644 (98.5%)		1142 (96.5%)	12590 (98.3%)	13732 (98.1%)	
DR_7 Women's theft, fraud, extortion, harassment, etc. Is committing a crime on its own a sure reason for divorce?				0.219 ^a				0.593 ^a
Yes	752 (91.8%)	9039 (90.5%)	9791 (90.6%)		1085 (91.6%)	11681 (91.2%)	12766 (91.2%)	
No	67 (8.2%)	947 (9.5%)	1014 (9.4%)		99 (8.4%)	1130 (8.8%)	1229 (8.8%)	
DR_8: Theft, fraud, extortion, harassment, etc. Is committing a crime on its own a sure reason for divorce?				0.251 ^a				0.743 ^a
Yes	754 (92.1%)	9074 (90.9%)	9828 (91%)		1088 (91.9%)	11737 (91.6%)	12825 (91.6%)	
No	65 (7.9%)	912 (9.1%)	977 (9%)		96 (8.1%)	1074 (8.4%)	1170 (8.4%)	
DR_9 Is a woman's inability to get along with her husband's family a definite reason for divorce?				0.000 ^a				0.000 ^a
Yes	200 (24.4%)	1244 (12.5%)	1444 (13.4%)		306 (25.8%)	1920 (15%)	2226 (15.9%)	
No	619 (75.6%)	8742 (87.5%)	9361 (86.6%)		878 (74.2%)	10891 (85%)	11769 (84.1%)	
DR_10 Is a man's inability to get along with his wife's family a definite reason for divorce?				0.000 ^a				0.000 ^a
Yes	193 (23.6%)	1174 (11.8%)	1367 (12.7%)		305 (25.8%)	1850 (14.4%)	2155 (15.4%)	
No	626 (76.4%)	8812 (88.2%)	9438 (87.3%)		879 (74.2%)	10961 (85.6%)	11840 (84.6%)	
DR_11 Is a woman's irresponsible and uninterested treatment of home, spouse and children a definite reason for divorce?				0.000 ^a				0.000 ^a
Yes	601 (73.4%)	6057 (60.7%)	6658 (61.6%)		883 (74.6%)	7892 (61.6%)	8775 (62.7%)	
No	218 (26.6%)	3929 (39.3%)	4147 (38.4%)		301 (25.4%)	4919 (38.4%)	5220 (37.3%)	
DR_12 Is a man's irresponsible and uninterested treatment of his home, spouse and children a definite reason for divorce?				0.000 ^a				0.000 ^a
Yes	596 (72.8%)	6076 (60.8%)	6672 (61.7%)		900 (76%)	8039 (62.8%)	8939 (63.9%)	
No	223 (27.2%)	3910 (39.2%)	4133 (38.3%)		284 (24%)	4772 (37.2%)	5056 (36.1%)	
DR_13 Is the woman's ill-treatment of her husband (beating, insulting, etc.) a definite reason for divorce on its own?				0.001 ^b				0.000 ^a
Yes	713 (87.1%)	8216 (82.3%)	8929 (82.6%)		1083 (91.5%)	10999 (85.9%)	12082 (86.3%)	
No	106 (12.9%)	1770 (17.7%)	1876 (17.4%)		101 (8.5%)	1812 (14.1%)	1913 (13.7%)	
DR_14 Is the man's maltreatment of his wife (beating, insulting, etc.) a definite reason for divorce on its own?				0.003 ^b				0.000 ^a
Yes	711 (86.8%)	8263 (82.7%)	8974 (83.1%)		1098 (92.7%)	11115 (86.8%)	12213 (87.3%)	
No	108 (13.2%)	1723 (17.3%)	1831 (16.9%)		86 (7.3%)	1696 (13.2%)	1782 (12.7%)	
DR_15 Is the woman's family getting too involved in family relations a definite reason for divorce?				0.000 ^a				0.000 ^a
Yes	326 (39.8%)	2454 (24.6%)	2780 (25.7%)		482 (40.7%)	3669 (28.6%)	4151 (29.7%)	
No	493 (60.2%)	7532 (75.4%)	8025 (74.3%)		702 (59.3%)	9142 (71.4%)	9844 (70.3%)	
DR_16 Is the man's family getting too involved in family relations a definite reason for divorce?				0.000 ^a				0.000 ^a
Yes	309 (37.7%)	2315 (23.2%)	2624 (24.3%)		476 (40.2%)	3599 (28.1%)	4075 (29.1%)	
No	510 (62.3%)	7671 (76.8%)	8181 (75.7%)		708 (59.8%)	9212 (71.9%)	9920 (70.9%)	
DR_17 Is the woman's absence of children a definite reason for divorce?				0.000 ^a				0.039 ^b
Yes	70 (8.5%)	532 (5.3%)	602 (5.6%)		115 (9.7%)	1025 (8%)	1140 (8.1%)	
No	749 (91.5%)	9454 (94.7%)	10203 (94.4%)		1069 (90.3%)	11786 (92%)	12855 (91.9%)	
DR_18 Is the man's absence of children a definite reason for divorce?				0.001 ^b				0.005 ^b
Yes	64 (7.8%)	509 (5.1%)	573 (5.3%)		113 (9.5%)	934 (7.3%)	1047 (7.5%)	
No	755 (92.2%)	9477 (94.9%)	10232 (94.7%)		1071 (90.5%)	11877 (92.7%)	12948 (92.5%)	
DR_19 Is the woman's bad habits, such as drinking and gambling, a definite reason for divorce?				0.917 ^a				0.135 ^a
Yes	710 (86.7%)	8644 (86.6%)	9354 (86.6%)		1059 (89.4%)	11270 (88%)	12329 (88.1%)	
No	109 (13.3%)	1342 (13.4%)	1451 (13.4%)		125 (10.6%)	1541 (12%)	1666 (11.9%)	
DR_20 Is the man's bad habits, such as drinking and gambling, a definite reason for divorce?				0.980 ^a				0.014 ^b
Yes	704 (86%)	8587 (86%)	9291 (86%)		1064 (89.9%)	11197 (87.4%)	12261 (87.6%)	
No	115 (14%)	1399 (14%)	1514 (14%)		120 (10.1%)	1614 (12.6%)	1734 (12.4%)	
DR_21 Is a woman cheating on her husband (even once) a definite reason for divorce?				0.632 ^a				0.453 ^a
Yes	781 (95.4%)	9558 (95.7%)	10339 (95.7%)		1094 (92.4%)	11912 (93%)	13006 (92.9%)	
No	38 (4.6%)	428 (4.3%)	466 (4.3%)		90 (7.6%)	899 (7%)	989 (7.1%)	
DR_22 Is a man cheating on his wife (even once) a definite reason for divorce on its own?				0.170 ^a				0.415 ^a
Yes	766 (93.5%)	9207 (92.2%)	9973 (92.3%)		1064 (89.9%)	11414 (89.1%)	12478 (89.2%)	
No	53 (6.5%)	779 (7.8%)	832 (7.7%)		120 (10.1%)	1397 (10.9%)	1517 (10.8%)	

Note: Values in parentheses in the table show percentiles. DR stands for the reason for divorce. ^ap<.001; ^bp<.05; ^c>.05

Table 2 also includes the chi-square test results of the divorce reason (DR) variables. Accordingly, the chi-square test results for the variables 7, 8, 19, 20, 21 and 22 in the DR variable group were found to be insignificant for men, whereby these variables were excluded from all subsequent analyses for men. In addition, the chi-square test results for the variables 1, 7, 8, 19, 21 and 22 in the DR variable group were found to be insignificant for women, whereby these variables were excluded from all subsequent analyses for women.

As stated in the literature and understood from Table 2, some of the variables that had insignificant chi-square test results and, therefore, were not included in the model (crimes such as theft, fraud, extortion and harassment, and unpleasant habits such as alcohol use, gambling, and cheating) affect the probability of divorce. However, as both groups included in the divorced and nondivorced dependent variable categories had similar responses, these variables were not included in the logit and probit models. Therefore, whether the variables to be used were independent of the divorce status was considered while evaluating the results.

4.2. Model Estimation

By using the data of the Family Structure Survey conducted by TUIK in 2016, this study aimed to examine the gender factors of divorce and the effect of these factors on the probability of divorce. For this, logit and probit regression analyses were performed in the study. Tables 3 and 4 present the marginal effect values obtained from the analyses. The logit and probit models were statistically significant ($p < 0.000$). McKelvey and Zavoina's R^2 values of the logit and probit models for men were 0.330 and 0.290, respectively, while the values for women were 0.414 and 0.377.

In the light of the explanations in the analysis section of the research, in Binary Logit and probit regression analysis, when the independent variable has two categories, the category that is not risky on the divorce status is selected as the reference category, and a dummy variable is created by giving the code 0. The other category is given the code 1. If an independent variable has more than two categories, a dummy variable is created as one less than the number of categories. In selecting the reference category, the category with the lowest or highest risk of divorce is chosen as the reference category. In this case, the reference category is given a code of 0; the related category is given a code of 1, and the dummy process is performed. In addition, the marginal effects of categorical variables with VIF values above ten on the probability of divorce are excluded from the analysis (Alkan & Demir, 2019; Alkan & Abar, 2020).

Table: 3
Marginal Effects of Participants' Demographic and Socioeconomic Characteristics on Divorce

Variable	Male			Female		
	Logit regression	Probit regression	VIF	Logit regression	Probit regression	VIF
Age (Reference: 16-25 years)						
26-35 years:1, others:0	Excluded	Excluded	>10	0.0102* (0.0069)	0.0100* (0.0067)	2.31
36-45 years:1, others:0	Excluded	Excluded	>10	0.0400* (0.0061)	0.0401* (0.0061)	2.47
46-55 years:1, others:0	Excluded	Excluded	>10	0.0251* (0.0067)	0.0247* (0.0066)	1.99
55 years or above:1, others:0	Excluded	Excluded	>10	Excluded	Excluded	>10
Residential type (Reference: City centre)						
Town center:1, others:0	-0.0107* (0.0063)	-0.0109* (0.0065)	1.42	-0.0147* (0.0057)	-0.0151* (0.0059)	1.40
Village:1, others:0	-0.0432* (0.0061)	-0.0429* (0.0060)	1.64	-0.0584* (0.0057)	-0.0576* (0.0056)	1.70
Abroad:1, others:0	-0.0015* (0.0200)	-0.0015* (0.0206)	1.06	0.0139* (0.0146)	0.0147* (0.0155)	1.07
Employment Status (Reference: In private sector)						
In public sector:1, others:0	-0.0346* (0.0099)	-0.0331* (0.0092)	1.40	-0.0084* (0.0103)	-0.0088* (0.0108)	1.83
Not working:1, others:0	0.0188* (0.0053)	0.0189* (0.0054)	1.65	-0.0445* (0.0054)	-0.0453* (0.0055)	1.40
Average monthly net income (Reference: 0-1300 TL)						
1301-2600 TL:1, others:0	-0.0187* (0.0058)	-0.0187* (0.0058)	1.45	0.0625* (0.0065)	0.0644* (0.0070)	1.23
2601-3900 TL:1, others:0	-0.0204* (0.0083)	-0.0204* (0.0082)	1.66	0.0516* (0.0104)	0.0526* (0.0111)	1.69
3901 TL or above:1, others:0	-0.0069* (0.0089)	-0.0070* (0.0090)	1.52	0.1104* (0.0115)	0.1186* (0.0134)	1.22
Age at first marriage (Reference: 12-17 years)						
18-23 years:1, others:0	-0.0100* (0.0107)	-0.0102* (0.0110)	5.44	-0.0212* (0.0053)	-0.0214* (0.0054)	1.86
24-29 years:1, others:0	-0.0229* (0.0108)	-0.0229* (0.0110)	6.79	-0.0234* (0.0074)	-0.0235* (0.0073)	2.53
30 years or above:1, others:0	0.0123* (0.0124)	0.0012* (0.0126)	4.10	0.0035* (0.0126)	0.0036* (0.0130)	1.65
Age of spouse in first marriage (Reference: 12-17 years)						
18-23 years:1, others:0	0.0261* (0.0071)	0.0254* (0.0068)	1.99	0.0073* (0.0111)	0.0073* (0.0110)	5.51
24-29 years:1, others:0	0.0322* (0.0084)	0.0316* (0.0082)	2.65	0.0018* (0.0112)	0.0018* (0.0110)	6.98
30 years or above:1, others:0	0.0642* (0.0124)	0.0652* (0.0130)	1.61	0.0388* (0.0122)	0.0386* (0.0121)	5.02
Age difference with spouse in first marriage (Reference: 0-5 years)						
6-10 years:1, others:0	-0.0219* (0.0065)	-0.0216* (0.0063)	1.47	0.0124* (0.0053)	0.0123* (0.0053)	1.60
11-15 years:1, others:0	-0.0123* (0.0157)	-0.0123* (0.0154)	1.27	0.0333* (0.0099)	0.0339* (0.0103)	1.52
16 years or above:1, others:0	0.0428* (0.0309)	0.0452* (0.0340)	1.07	0.0725* (0.0140)	0.0765* (0.0156)	1.35
Year of last (or longest) marriage (Reference: 0-12 years)						
13-25 years:1, others:0	-0.0595a (0.0060)	-0.0609a (0.0060)	1.68	-0.0621a (0.0052)	-0.0636a (0.0052)	2.18
26-38 years:1, others:0	-0.1048a (0.0084)	-0.1024a (0.0075)	1.98	-0.1312a (0.0081)	-0.1260a (0.0071)	2.77
Marriage decision method (Reference: Arranged without being asked)						
Arranged by asking	-0.0009* (0.0098)	-0.0008* (0.0097)	3.58	-0.0255* (0.0070)	-0.0250* (0.0070)	2.44
Own decision without family permission:1, others:0	0.0364* (0.0167)	0.0371* (0.0173)	1.31	0.0606* (0.0121)	0.0644* (0.0132)	1.22
Own decision with family permission:1, others:0	0.0171* (0.0100)	0.0171* (0.0099)	3.99	0.0100* (0.0072)	0.0101* (0.0073)	2.85
Other (abduction, bride exchange etc.):1, others:0	0.0219* (0.0127)	0.0220* (0.0128)	1.82	0.0116* (0.0097)	0.0118* (0.0099)	1.55
Type of wedding (Reference: Both civil and religious marriage)						
Only civil marriage:1, others:0	0.1074* (0.0115)	0.1180* (0.0136)	1.06	0.1008* (0.0126)	0.1091* (0.0147)	1.05
Only religious marriage:1, others:0	0.1511* (0.0151)	0.1722* (0.0189)	1.05	0.1728* (0.0116)	0.1970* (0.0144)	1.06
Way to meet your spouse (Reference: Family-relative)						
Neighbourhood	0.0150* (0.0064)	0.0143* (0.0061)	1.22	0.0263* (0.0058)	0.0253* (0.0056)	1.19
School-course:1, others:0	-0.0105* (0.0162)	-0.0097* (0.0149)	1.24	0.0224* (0.0129)	0.0215* (0.0126)	1.25
Business environment :1, others:0	0.0830* (0.0079)	0.0850* (0.0083)	1.33	0.0869* (0.0078)	0.0885* (0.0082)	1.33
Circle of friends:1, others:0	0.0751* (0.0074)	0.0763* (0.0076)	1.34	0.0843* (0.0068)	0.0856* (0.0070)	1.35
Other (internet, etc.):1, others:0	0.1179* (0.0191)	0.1251* (0.0223)	1.05	0.1007* (0.0209)	0.1039* (0.0234)	1.04
Having children (Reference: Yes)						
No:1	0.0632* (0.0076)	0.0664* (0.0083)	1.15	0.0737* (0.0069)	0.0777* (0.0076)	1.15
No:1	-0.0212* (0.0065)	-0.0209* (0.0063)	1.09	-0.0374* (0.0099)	-0.0363* (0.0093)	1.06
Individual happiness (Reference: Happy)						
Medium:1, others:0	0.0415* (0.0058)	0.0417* (0.0059)	1.62	0.0446* (0.0052)	0.0446* (0.0053)	1.67
Unhappy:1, others:0	0.1048* (0.0094)	0.1123* (0.0107)	1.30	0.1053* (0.0081)	0.1114* (0.0091)	1.46
Family happiness (Reference: Happy)						
Medium:1, others:0	0.0422* (0.0060)	0.0427* (0.0061)	1.63	0.0436* (0.0054)	0.0440* (0.0055)	1.68
Unhappy:1, others:0	0.0575* (0.0093)	0.0592* (0.0100)	1.28	0.0641* (0.0082)	0.0660* (0.0088)	1.42
Smoking (Reference: No)						
Yes:1	0.0313* (0.0051)	0.0312* (0.0051)	1.12	0.0900* (0.0050)	0.0927* (0.0051)	1.16
Alcohol (Reference: No)						
Yes:1	0.0527* (0.0054)	0.0536* (0.0055)	1.18	0.0448* (0.0063)	0.0461* (0.0066)	1.10
Statistical regional units' class (Reference: TR1)						
TR2:1, others:0	-0.0080* (0.0111)	-0.0081* (0.0112)	1.51	-0.0251* (0.0114)	-0.0252* (0.0113)	1.49
TR3:1, others:0	0.0124* (0.0084)	0.0129* (0.0087)	1.92	0.0103* (0.0080)	0.0107* (0.0082)	1.96
TR4:1, others:0	-0.0205* (0.1061)	-0.0205* (0.0105)	1.62	-0.0105* (0.0095)	-0.0106* (0.0096)	1.64
TR5:1, others:0	-0.0082* (0.0092)	-0.0083* (0.0093)	1.82	-0.0050* (0.0085)	-0.0051* (0.0086)	1.88
TR6:1, others:0	0.0034* (0.0095)	0.0035* (0.0097)	1.67	-0.0029* (0.0090)	-0.0030* (0.0092)	1.72
TR7:1, others:0	-0.0441* (0.0140)	-0.0431* (0.0133)	1.44	-0.0225* (0.0111)	-0.0226* (0.0111)	1.50
TR8:1, others:0	-0.0429* (0.0138)	-0.0420* (0.0132)	1.45	-0.0411* (0.0124)	-0.0406* (0.0120)	1.47
TR9:1, others:0	-0.0477* (0.0172)	-0.0464* (0.0161)	1.30	-0.0760* (0.0175)	-0.0726* (0.0188)	1.32
TRA:1, others:0	-0.0810* (0.0233)	-0.0763* (0.0204)	1.25	-0.1046* (0.0211)	-0.0974* (0.0151)	1.31
TRB:1, others:0	-0.0588* (0.0171)	-0.0566* (0.0158)	1.38	-0.0669* (0.0150)	-0.0644* (0.0138)	1.41
TRC:1, others:0	-0.0497* (0.0138)	-0.0483* (0.0130)	1.54	-0.0641* (0.0129)	-0.0619* (0.0120)	1.60

Notes: The values in parentheses are the standard errors, and the others are dy/dx values in marginal effect analysis. Categories with a VIF coefficient greater than ten were excluded from the analysis and labelled as Excluded. *p<.001; **p<.05; >.05

As seen in Table 3, The probability of divorce was 4% higher for women in the 36-45 age group than those in the 16-25 age group. Women in the 46-55 age group also had a higher probability of divorce than those in the 16-25 age group. Men living in the district centre and those living in the village had a lower probability of divorce than those living in the city centre. Similarly, women living in the district centre and those living in the town had a lower probability of divorce than those living in the city centre. There was no significant effect on the probability of divorce for men and women living abroad compared to those living in the city centre. In addition, men working in the public sector had a lower probability of divorce than those working in the private sector. Unemployed men had a 1.8% higher probability of divorce than those working in the private sector. On the contrary, unemployed women were 4.5% less likely to divorce than women working in the private sector.

Men with an income of 1301-2600 TL and those with an income of 2601-3900 TL had 1.8% and 2% lower divorce probability than those with an income of 0-1300 TL, respectively. There was no significant effect of the monthly income on the probability of divorce in those with an income of 3900 TL and above compared to those with an income of 0-1300 TL. On the other hand, when the variable of average monthly income of women is analysed, it is determined that those with an income of 1301-2600 TL, 2601-3900 TL and 3901 TL and above have higher probabilities of divorce calculated by logit and probit analysis than those with an income of 0-1300 TL.

Men who had their first marriage in the 24-29 age group were 2.2% less likely to divorce than those in the 12-17 age group, and the effect of other age groups on the likelihood of divorce was not found to be significant. Women who were first married between the ages of 18-23 years and those who were first married between the ages of 24-29 years were 2.1% and 2.3% less likely to divorce compared to those who were first married at 12-17 years, respectively. Men with a wife aged 30 years and older at first marriage had the highest probability of divorce, followed by those aged between 24-29 years, those aged between 18-23 years and those aged between 12-17 years. Women with a husband aged between 30 years and older at first marriage had a higher probability of divorce than those with a husband aged 12-17 years. When the age difference between spouses is analysed, men 6-10 years older than their wives are 2.1% less likely to divorce than men 0-5 years older. On the other hand, the effect of the age difference between 11-15 and 16+ on the probability of divorce is not significant.

Women whose age difference with their husband was 16 years and above at first marriage had the highest probability of divorce, followed by those whose age difference with their husbands was 11-15 years, those whose age difference with their husbands was 6-10 years, and those whose age difference with their husband were 0-5 years, respectively.

When the probability of divorce is compared according to the most extended marriage duration of 0-12 years for women and men, it is found that divorce decreases for

those whose marriages lasted 13-25 years and 26-38 years. In other words, as the marriage duration increased, the divorce probability decreased for women and men.

Men who got married in an arranged manner (without being asked) had the lowest probability of divorce, followed by those who married by their own decision with family permission, those who married by other methods (bride exchange, etc.), and those who married by their own decision without family permission, respectively. On the other hand, women who married by their own decision without family permission had the highest probability of divorce, followed by those who got married in an arranged manner (without being asked) and those who got married in an organised manner (by being asked), respectively.

Men who had both religious and civil marriages had the lowest probability of divorce, followed by those who had only civil marriage and those who had only religious marriage, respectively. Similarly, women who had both religious and civil marriages had the lowest probability of divorce, followed by those who had only civil marriages and those who had only religious marriages, respectively.

Men who were married from their family-relative circle had the lowest possibility of divorce, followed by those who were married from their neighbourhood, those who were married from their work environment, those who were married from their friend circle, and those who were married from other platforms (internet, dating agency etc.), respectively. Similarly, women who were married from their family-relative circle had the lowest possibility of divorce, followed by those who were married from their neighbourhood, those who were married from their school environment, those who were married from their work environment, and those who were married from their friend circle, and those who were married from other platforms (internet, dating agency etc.), respectively. In addition, it was found that those who met at school curricula were less likely to divorce than those who met in the neighbourhood, and those who met in the circle of friends were less likely to divorce than those who met in the work circle.

Men without children had a higher probability of divorce than those with children. Similarly, women without children had a higher probability of divorce than those with children. Men who approved women's employment had a higher probability of divorce than those who did not. Similarly, women who agreed to women's jobs had a higher probability of divorce than those who did not.

Happy men had the lowest probability of divorce, followed by moderately happy men and unhappy men, respectively. Similarly, happy women had the lowest probability of divorce, followed by moderately happy and unhappy women, respectively. Men with happy family lives had the lowest probability of divorce, followed by those with moderately happy family lives and those with unhappy family lives. Similarly, women with happy family lives had the lowest probability of divorce, followed by those with moderately happy family lives and those with unhappy family lives.

Smoking women were 9% more likely to divorce than non-smokers, while smoking men were 3% more likely to divorce than non-smokers. Women who used alcohol had a higher probability of divorce than those who did not. Similarly, men who used alcohol had a higher probability of divorce than those who did not.

Table 3 presents the results regarding the statistical regional classification. Accordingly, men and women living in the TRA region were less likely to divorce than those in the TR1 region. TR1 region included Istanbul, one of the most populated and developed provinces of Türkiye, located between the continents of Europe and Asia, while the TRA region consisted of seven provinces located in the Northeast Anatolia of Türkiye. Table 4 shows the marginal effects of the variables that can cause divorce alone.

Table: 4
Marginal Effects of Variables That Alone Can Cause Divorce

Variable	Male			Female		
	Logit regression	Probit regression	VIF	Logit regression	Probit regression	VIF
DR_1 Is a woman's failure to do housework properly a definite reason for divorce? (Reference: No)						
Yes:1	0.0335 ^a (0.0061)	0.0342 ^a (0.0064)	1.47	0.0054 ^a (0.0064)	0.0054 ^a (0.0065)	1.37
DR_2 Is the man's failure to do his housework properly a definite reason for divorce? (Reference: No)						
Yes:1	0.0403 ^a (0.0095)	0.0417 ^a (0.0102)	1.36	0.0294 ^a (0.0106)	0.0301 ^b (0.0111)	1.32
DR_3 Is the woman's inability to provide for the household economically a definite reason for divorce? (Reference: No)						
Yes:1	0.0296 ^a (0.0108)	0.0304 ^a (0.0114)	1.14	0.0375 ^a (0.0088)	0.0386 ^a (0.0093)	1.17
DR_4 Is the man's inability to provide for the house economically a definite reason for divorce? (Reference: No)						
Yes:1	0.0236 ^a (0.0051)	0.0236 ^a (0.0051)	1.25	0.0504 ^a (0.0048)	0.0501 ^a (0.0047)	1.31
DR_5 Is a woman's catching a disease that is difficult to treat a definite reason for divorce? (Reference: No)						
Yes:1	0.0631 ^a (0.0152)	0.0671 ^a (0.0171)	3.45	0.0426 ^a (0.0134)	0.0442 ^b (0.0144)	3.19
DR_6 Is a man's catching a disease that is difficult to treat a definite reason for divorce? (Reference: No)						
Yes:1	0.0506 ^a (0.0160)	0.0532 ^a (0.0172)	3.44	0.0572 ^a (0.0132)	0.0601 ^a (0.0145)	3.19
DR_9 Is a woman's inability to get along with her husband's family a definite reason for divorce? (Reference: No)						
Yes:1	0.0569 ^a (0.0061)	0.0589 ^a (0.0065)	6.05	0.0524 ^a (0.0055)	0.0538 ^a (0.0057)	6.58
DR_10 Is a man's inability to get along with his wife's family a definite reason for divorce? (Reference: No)						
Yes:1	0.0582 ^a (0.0062)	0.0603 ^a (0.0066)	6.03	0.0553 ^a (0.0055)	0.0569 ^a (0.0058)	6.62
DR_11 Is a woman's irresponsible and uninterested treatment of her home, spouse and children a definite reason for divorce? (Reference: No)						
Yes:1	Excluded	Excluded	>10	0.0464 ^a (0.0054)	0.0455 ^a (0.0051)	8.26
DR_12 Is a man's irresponsible and uninterested treatment of his home, spouse and children a definite reason for divorce? (Reference: No)						
Yes:1	Excluded	Excluded	>10	0.0486 ^a (0.0055)	0.0476 ^a (0.0052)	8.30
DR_13 Is the woman's ill-treatment of her husband (beating, insulting, etc.) a definite reason for divorce on its own? (Reference: No)						
Yes:1	0.0259 ^a (0.0075)	0.0254 ^a (0.0072)	5.23	0.0439 ^a (0.0083)	0.0425 ^a (0.0077)	4.24
DR_14 Is the man's maltreatment of his wife (beating, insulting, etc.) a definite reason for divorce on its own? (Reference: No)						
Yes:1	0.0221 ^b (0.0074)	0.0218 ^a (0.0072)	5.27	0.0515 ^a (0.0089)	0.0494 ^a (0.0082)	4.32
DR_17 Is the woman's absence of children a definite reason for divorce? (Reference: No)						
Yes:1	0.0354 ^a (0.0093)	0.0366 ^a (0.0098)	5.64	0.0164 ^a (0.0080)	0.0166 ^a (0.0082)	5.76
DR_18 Is the man's absence of children a definite reason for divorce? (Reference: No)						
Yes:1	0.0319 ^a (0.0096)	0.0328 ^a (0.0102)	5.63	0.0227 ^a (0.0081)	0.0231 ^b (0.0083)	5.74
DR_20 Is the man's bad habits, such as drinking and gambling, a definite reason for divorce? (Reference: No)						
Yes:1	Excluded*	Excluded*	Chi-square p>0.05	0.0189 ^a (0.0077)	0.0187 ^b (0.0075)	1.22
McKelvey and Zavoina's R ²	0.330	0.290		0.414	0.377	

Notes: The values in parentheses are the standard errors, and the others are dy/dx values in marginal effect analysis. Categories with a VIF coefficient greater than ten were excluded from the analysis and labelled Excluded. As a result of the chi-square test, the DR_20 variable was found to be insignificant for males, so it was excluded from the analysis and labelled as Excluded*. DR stands for the reason for divorce. *p<.001; ^ap<.05; ^bp>.05

As seen in Table 4, men who agree with the statement "a woman's failure to do housework properly is a definite reason for divorce" are more likely to get divorced than those who disagree. This statement did not have a significant effect on the probability of divorce for women. Both men and women agree with the statement, "Is the man's failure to do housework properly a definite reason for divorce?", "Is the woman's inability to provide for the household economically a definite reason for divorce?", "Is the man's inability to provide for the household economically a definite reason for divorce?" are more likely to divorce than those who disagree. I agreed with the statement, "Is a woman's catching a disease that is difficult to treat a definite reason for divorce?", "Is a man's inability to get

along with his wife's family a definite reason for divorce?" and "Is a woman's inability to get along with her husband's family a definite reason for divorce?" had the highest effects on the probability of divorce for men, respectively, while being agreed with the statement of "Is the man's maltreatment of his wife (beating, insulting etc.) a definite reason for divorce on its own?" had the most negligible impact on the probability of divorce for men. In other words, agreeing with the statement "Is a woman's catching a disease that is difficult to treat a definite reason for divorce?" increased the probability of divorce in men compared to other statements. Similarly, I agree with the statement, "Is a man's catching a disease that is difficult to treat a definite reason for divorce?", "Is a man's inability to get along with his wife's family a definite reason for divorce?" and "Is the man's maltreatment of his wife (beating, insulting, etc.) a definite reason for divorce on their own?" had the highest effects on the probability of divorce for women, respectively, while being agreed with the statement of "Is the woman's absence of children a definite reason for divorce?" had the most negligible impact on the probability of divorce for women. Accordingly, agreeing with the statement, "Is a man's catching a disease that is difficult to treat a definite reason for divorce?" increased the probability of divorce in women compared to other statements.

5. Conclusion and Discussion

Divorce affects the spouses' psychology, daily life, social life, and socioeconomic status. Although it was harder to divorce, especially for women in the past in Türkiye, it has become normalised and more accessible due to several factors such as technological developments, legal developments, active participation of women in business life, increased individualisation, and urbanisation. Preventing divorce, which has heavy psychological effects on spouses and their children, as much as possible can contribute to solving the problem of social disintegration.

Divorce is a problem that closely concerns all members of the family, reaches social dimensions and causes severe psychological, sociological and economic damage. Along with social and economic changes, gender differences are the main factors that increase divorce rates. The distinguishing feature of this study from other studies is to determine the reasons for divorce according to gender differences. In this context, the study aims to determine the factors that are effective on divorce according to gender differences and the effects of these factors on the probability of divorce.

This study used the data of 24,800 individuals who participated in the 2016 Family Structure Survey conducted by TurkStat. Among the respondents, 8.46% of women and 7.58% of men were divorced. The study used binary logit and probit regression analysis methods to determine the socio-demographic and economic factors that affect divorce according to the gender differences of the individuals surveyed.

Both men and women living in the village and those living in the district centre had a lower probability of divorce than those living in the city centre. This result is supported by different studies on many cultures (Gautier et al., 2009; Swenson, 1996; Zhang et al., 2014).

This may be because economic opportunities are more accessible in cities, whereby individuals are more active in working life.

Employment status affects the probability of divorce differently in men and women. Unemployed men were more likely to get divorced than others, whereas unemployed women had a lower probability of divorce. Economic explanations for divorce are closely related to the cultural values of the study sample (Kalmijn et al., 2004). Therefore, this result may be because men are responsible for earning a living for their families in the Turkish family structure. The participation rate of women in active working life is even less than half that of men (TÜİK, 2018). Unemployed women depend more on their husbands due to their poor economic status. Notably, the probability of divorce decreases in men as their income increases, while it increases in women as their income rises. Thus, this result supports our previous results, suggesting that women with economic freedom are more likely to divorce. Some studies have equivalent results (Killewald, 2016; Mansour et al., 2020).

Our study found that early marriage increased the probability of divorce for both men and women. However, a first marriage age of 18 years and over also increased the likelihood of divorce in women. There are studies with equivalent results regarding the effect of early marriage on divorce in women (Lowenstein, 2005; Widyastari, 2020). Gentleman and Park (1994) examined the age difference between spouses and found that the probability of divorce decreased when the husband was older and increased when the wife was older. Our study considered the age difference in absolute value. However, our result suggests that the probability of divorce increased as the age difference increased for women, which is consistent with those introduced by Gentleman and Park (1994).

The divorce probability decreased for both women and men as the marriage duration increased. According to the TUIK (TÜİK, 2020; 2021; 2022), more than half of the divorces in Türkiye in 2019, 2020 and 2021 were realised within the first ten years of marriage. The United States Census Bureau reported a similar result for the USA (Kreider, 2005).

Alcohol use increased the probability of divorce in both men and women. Studies in the literature support this result (Caces et al., 1999; Can & Aksu, 2016; Salvatore et al., 2017). Excessive use of alcohol harms not only oneself but also one's family structure and members. Erdim (2019) has argued that an alcoholic spouse causes psychiatric problems in family members, leading to divorce and several negative effects on children. Therefore, controlling alcohol use can be an important effort to prevent divorce.

As a result of the analysis, it was concluded that the variable of women's inability to do housework has a significant effect on the probability of divorce for men, but it does not have a substantial effect on women. On the other hand, men's not doing housework has a significant impact on the probability of divorce for both men and women. Some studies report that housework is distributed more equally between spouses in cultures where access to divorce is easier (Cooke, 2006; Ruppner, 2012; Yodanis, 2005). Therefore, Turkish

women expect their husbands to fulfil their housework duties, even if they cannot be impartial about their share of housework.

According to the research results, the probability of divorce was higher in men who had only religious marriages, met their spouses through the Internet or dating agencies, and had the longest marriage between 0-12 years. In addition, the fact that the spouse suffered from a severe illness and that the husband could not establish good relations with his own family in terms of communication were among the factors that had the highest impact on the probability of divorce for men. On the other hand, it was determined that women who had only religious marriages, whose marriage duration was between 0-12 years and who were unhappy individually were more likely to divorce. In addition, the fact that the husband suffered from a severe illness, that he could not establish good relations with his own family in terms of communication and that the husband mistreated his wife (beating, insult) were found to be the most critical determinants of the probability of divorce for women.

As a result of the research, it has been revealed that the statement of not being able to provide for the household has a significant effect on the probability of divorce for both women and men. However, it was determined that men had a slightly higher effect on the likelihood of divorce than women.

Another finding obtained as a result of the research is that the spouse's having a difficult-to-treat illness is a factor that has the most significant effect on the probability of divorce for both men and women. Glantz et al. (2009) and Karraker & Latham (2015) explained that the risk of having a severe illness of the spouse has a significant effect on the probability of divorce, which is in line with this finding of the study.

All variables that increased the probability of divorce for women were related to men. However, some variables that increased this probability for men were related to both men and women. In other words, while women hold their husbands responsible for the most influential factors leading to divorce, men stated that they were also responsible for these factors related to divorce.

According to the findings of the study, it was understood that the factors affecting the probability of divorce of men and women differed according to gender. In this context, individuals need to get to know each other and their families before marriage to prevent divorces that increase the social structure of society. In addition, it is evaluated that directing and supporting individuals to practices that provide family counselling and family therapy services to solve problems occurring in the family can play a decisive role in reducing divorces. Another suggestion to prevent divorces is that civil marriage can be an important deterrent factor in divorces as it protects the rights of spouses before the law.

The results of this study will allow policy developers to improve and maintain the family structure. Our study contributed to the literature by determining the variables that increase divorce through statistical methods. For future studies, examining the subject in

samples from different countries and comparing the cultural reasons for divorce is recommended.

References

- Aktaş, Ç. (2018), "Boşanmanın erkekler üzerindeki etkisi: İstanbul örneği", *İmgelem*, 2(2), 29-57.
- Aktaş, G. & D. Uray (2021), "Erkeklerin Boşanma Sürecine İlişkin Deneyimleri: Denizli'de Nitel Bir Çalışma", *Cumhuriyet Üniversitesi Fen-Edebiyat Fakültesi Sosyal Bilimler Dergisi*, 45(2), 1-28.
- Alkan, Ö. & A. Demir (2019), "Tütün kullanımını bırakma başarısını etkileyen faktörlerin lojistik regresyon ile analizi", *Atatürk Üniversitesi İktisadi ve İdari Bilimler Dergisi*, 33(4), 1227-1244.
- Alkan, Ö. & H. Abar (2020), "Determination of factors influencing tobacco consumption in Turkey using categorical data analyses", *Archives of Environmental & Occupational Health*, 75(1), 27-35.
- Alkan, Ö. (2017), "Türkiye'de gençlerin tütün kullanımında cinsiyet farklılıklarının araştırılması", *Bağımlılık Dergisi*, 18(2), 35-45.
- Alpar, R. (2011), *Uygulamalı Çok Değişkenli İstatistiksel Yöntemler*, Detay Yayıncılık, Ankara.
- Altıntaş, F.F. (2021), "Müşteri Memnuniyeti ve Beklentisi İlişkisi: Probit Regresyon Analizi ile Bir Uygulama", *Journal of Academic Social Science Studies*, 14(84), 439-455.
- Altun, B.N.İ. et al. (2020), "Boşanma Nedenlerinin İletişim Bağlamında Değerlendirilmesi Üzerine Ampirik Bir Çalışma", *Kocaeli Üniversitesi İletişim Fakültesi Araştırma Dergisi*, (15), 116-139.
- Arpacı, F. & Ş. Tokyürek (2012), "Boşanmış Bireylerin Yeniden Evlilik Konusundaki Görüşlerinin İncelenmesi", *Akademik Bakış Dergisi*, 31, 1-15.
- Caces, M.F. et al. (1999), "Alcohol consumption and divorce rates in the United States", *Journal of Studies on Alcohol*, 60(5), 647-652.
- Can, Y. & N.B. Aksu (2016), "Woman during the divorce process and after", *Electronic Journal of Social Sciences*, 15(58), 888-902.
- Çavlin, A. (2014), "Türkiye'de Boşanma", in: M. Turğut & S. Feyzioğlu (eds.), *Türk Aile Yapısı Araştırması Tespitler Öneriler* (196-207), T.C. Aile ve Sosyal Politikalar Bakanlığı Aile ve Toplum Hizmetleri Genel Müdürlüğü.
- Çiçek, Z. & N.B. Arlı (2021), "Probit Model Yaklaşımı ile Kayıt Dışı İstihdamı Etkileyen Faktörlerin Belirlenmesi", *Çankırı Karatekin Üniversitesi İktisadi ve İdari Bilimler Fakültesi Dergisi*, 11(2), 649-671.
- Çokluk, Ö. et al. (2012), *Sosyal Bilimler İçin Çok Değişkenli İstatistik: SPSS ve LISREL Uygulamaları*, (Vol. 2), Ankara: Pegem Akademi.
- Cooke, L. (2006), "'Doing' gender in context: Household bargaining and risk of divorce in Germany and the United States", *American Journal of Sociology*, 112(2), 442-472.
- Crowley, J.E. (2019), "Once bitten, twice shy? Gender differences in the remarriage decision after a gray divorce", *Sociological Inquiry*, 89(1), 150-176.
- Elmas, Ç. & N. Adak (2023), "Türkiye'de Boşanma Nedenlerinin Toplumsal Kökenleri ve Boşanma Sonrası Deneyimler", *İstanbul University Journal of Sociology*, 43(1), 84-97.

- Erdim, L. (2019), "The impact of alcoholism on family and children", *Journal of Health Sciences and Professions*, 6(1), 193-200.
- Gautier, P.A. et al. (2009), "Sin City? Why is the divorce rate higher in urban areas?", *Scandinavian Journal of Economics*, 111(3), 439-456.
- Gavcar, E. et al. (2020), "Boşanmayı Etkileyen Faktörlerin Belirlenmesine Yönelik Bir Araştırma (Muğla İli Fethiye İlçesi Örneği)", *Nevşehir Hacı Bektaş Veli Üniversitesi SBE Dergisi*, 10(2), 730-745.
- Gentleman, J.F. & E. Park (1994), "Age differences of married and divorcing couples", *Health Reports*, 6(2), 225-240.
- Glantz, M.J. et al. (2009), "Gender disparity in the rate of partner abandonment in patients with serious medical illness", *Cancer*, 115(22), 5237-5242.
- Gökmen, Ş. et al. (2019), "İlk evlilik süresini etkileyen faktörlerin yaşam analizi: Türkiye Örneği", *Optimum Ekonomi ve Yönetim Bilimleri Dergisi*, 6(1), 63-76.
- Gujarati, N.D. & D.C. Porter (2009), *Temel Ekonometri*, (Çev. Ü. Şenesen & G. Günlük-Şenesen), İstanbul: Literatür Yayıncılık.
- Güven, N. & A. Köroğlu (2023), "Boşanma Nedenleri ve Boşanma Sonrası Psikososyal Uyum: Trabzon İli Örneği", *Ordu Üniversitesi Sosyal Bilimler Enstitüsü Sosyal Bilimler Araştırmaları Dergisi*, 13(Sosyal Bilimler Lisansüstü Öğrenci Sempozyumu Özel Sayısı), 1-24.
- Hosmer, D.W. Jr. et al. (2013), *Applied Logistic Regression*, Vol 398, Wiley, New York.
- Kalaycı, Ş. (2010), *SPSS Uygulamalı Çok Değişkenli İstatistik Teknikleri*, Ankara, Türkiye: Asil Yayın Dağıtım.
- Kalmijn, M. et al. (2004), "Interactions between cultural and economic determinants of divorce in the Netherlands", *Journal of Marriage and Family*, 66(1), 75-89.
- Karraker, A. & K. Latham (2015), "In sickness and in health? Physical illness as a risk factor for marital dissolution in later life", *Journal of Health and Social Behavior*, 56(3), 420-435.
- Kaya, K. & G.T. Eren (2020), "Boşanma ve Erken Boşanmaların Artış Nedenleri", *Sosyal, Beşeri ve İdari Bilimler Dergisi*, 3(9), 708-728.
- Killewald, A. (2016), "Money, work, and marital stability: Assessing change in the gendered determinants of divorce", *American Sociological Review*, 81(4), 696-719.
- Kreider, R.M. (2005), *Number, Timing, and Duration of Marriages and Divorces: 2001*, Household Economic Studies, U.S. Census Bureau.
- Kucur, F. & Ö. Kelebek (2021), "The stages of divorce and difficulties experienced by divorced women: an Esenler SHM example", *Journal of Social Policy Conferences*, 80, 231-266.
- Kutlar, A. et al. (2012), "Kadınların İşgücüne Katılması ile Doğurganlık, Boşanma ve Ücret Haddi Arasındaki İlişki: Türkiye Üzerine Bir Araştırma", *Bilgi Ekonomisi ve Yönetimi Dergisi*, 7(1), 149-168.
- Lowenstein, L.F. (2005), "Causes and associated features of divorce as seen by recent research", *Journal of Divorce & Remarriage*, 42(3-4), 153-171.
- Mansour, S. et al. (2020), "The effects of sociodemographic characteristics on divorce rates in Oman: Spatial modeling of marital separations", *The Professional Geographer*, 72(3), 332-347.

- O'Connell, A.A. (2006), *Logistic Regression Models for Ordinal Response Variables*, Sage Publications: Thousand Oaks, CA, USA.
- Özer, H. et al. (2006), "Üniversite Öğrencilerinin Cep Telefonu Hat Tercih Olasılığının Belirlenmesi: Atatürk Üniversitesi Örneği", *Gazi Üniversitesi İİBF Dergisi*, 7(2), 39-52.
- Ruppanner, L. (2012), "Housework conflict and divorce: A multi-level analysis", *Work, Employment and Society*, 26(4), 638-656.
- Salvatore, J.E. et al. (2017), "Alcohol use disorder and divorce: evidence for a genetic correlation in a population-based Swedish sample", *Addiction*, 112(4), 586-593.
- Sevim, Y. et al. (2016), "Boşanan Erkeklerin Sorunları Üzerine Sosyolojik Bir Araştırma (Elazığ İli Örneği)", *Fırat Üniversitesi Sosyal Bilimler Dergisi*, 26(2), 293-312.
- Sütçü, S. & V. Duyan (2021), *Aile İçi Şiddet ve Boşanma Davalarının Görünmeyen Mağdurları: Çocuk Tanıklar*, İstanbul; Türkiye: Efeakademi.
- Swenson, D. (1996), "A logit model of the probability of divorce", *Journal of Divorce & Remarriage*, 25(1-2), 173-194.
- Türkiye İstatistik Kurumu (2017), *Aile Yapısı Araştırması: 2016*, <<https://data.tuik.gov.tr/Bulten/Index?p=aile-yapisi-arastirmasi-2016-21869&dil=1>>, 29.12.2022.
- Türkiye İstatistik Kurumu (2018), *İstatistiklerle Kadın: 2017*, <<https://data.tuik.gov.tr/>>, 29.12.2022.
- Türkiye İstatistik Kurumu (2020), *Evlenme ve Boşanma İstatistikleri: 2019*, <<https://data.tuik.gov.tr/Bulten/Index?p=Evlenme-ve-Bosanma-Istatistikleri-2019-33708>>, 29.12.2022.
- Türkiye İstatistik Kurumu (2021), *Evlenme ve Boşanma İstatistikleri: 2020*, <<https://data.tuik.gov.tr/Bulten/Index?p=Evlenme-ve-Bosanma-Istatistikleri-2020-37211>>, 29.12.2022.
- Türkiye İstatistik Kurumu (2022), *Evlenme ve Boşanma İstatistikleri: 2021*, <<https://data.tuik.gov.tr/Bulten/Index?p=Evlenme-ve-Bosanma-Istatistikleri-2021-45568>>, 29.12.2022.
- Uğur, S.B. (2014), "Günümüzde kadının boşanma deneyimleri: akademisyen kadınlar üzerine bir araştırma", *Mediterranean Journal of Humanities*, 4(2), 293-326.
- Widyastari, D.A. et al. (2020), "Marital Dissolution in Postmodern Java, Indonesia: Does Early Marriage Increase the Likelihood to Divorce?", *Journal of Divorce & Remarriage*, 61(8), 556-573.
- Yodanis, C. (2005), "Divorce culture and marital gender equality: A cross-national study", *Gender & Society*, 19(5), 644-659.
- Zhang, C. et al. (2014), "Urbanization, unemployment rate and China's rising divorce rate", *Chinese Journal of Population Resources and Environment*, 12(2), 157-164.

Kuru-Sönmez, Ö. & E. Yakut (2024), "Determination of the Factors Affecting Divorce in Türkiye According to Gender: A Research with TUIK Data", *Sosyoekonomi*, 32(59), 105-127.

Efficiency of Investment Incentives in Reducing Regional Development Disparities in Türkiye¹

Sinan DÜNDAR (<https://orcid.org/0000-0001-8061-3322>), Sivas Cumhuriyet University, Türkiye;
sinandundar@cumhuriyet.edu.tr

Gülay DEMİR (<https://orcid.org/0000-0002-3916-7639>), Sivas Cumhuriyet University, Türkiye;
gulaydemir@cumhuriyet.edu.tr

İlkay NOYAN-YALMAN (<https://orcid.org/0000-0003-2999-5374>), Sivas Cumhuriyet University, Türkiye;
iyalman@cumhuriyet.edu.tr

Şerife Merve KOŞAROĞLU (<https://orcid.org/0000-0002-2563-5753>), Sivas Cumhuriyet University, Türkiye;
mkosaroglu@cumhuriyet.edu.tr

Selçuk Yasin YILDIZ (<https://orcid.org/0000-0002-1594-8799>), Sivas Cumhuriyet University, Türkiye;
selcukyasinyl@cumhuriyet.edu.tr

Türkiye’de Yatırım Teşviklerinin Bölgesel Gelişmişlik Farklarını Azaltma Konusunda Etkinliği²

Abstract

This study aims to determine to what extent the investment incentive system implemented in Türkiye effectively reduces regional development disparities. For this purpose, more than 100,000 investment incentive certificates issued between 2001-2022 are examined. The Logarithm Methodology of Additive Weights (LMAW) determines the criteria's importance and ranks the provinces' investment performances. The results obtained indicate that investment incentive applications cannot provide sufficient effectiveness in reducing regional development disparities. In this respect, there is a severe need for revision in the incentive policies currently implemented.

Keywords : Incentive, Development, Investment, MCDM, LMAW.

JEL Classification Codes : A14, B16, C44, D81.

Öz

Bu çalışmada, Türkiye’de uygulanan yatırım teşvik sisteminin bölgesel gelişmişlik farklarını azaltmada ne ölçüde etkili olduğunun tespit edilmesi amaçlanmaktadır. Bu doğrultuda, 2001-2022 yılları arasında verilen 100.000’den fazla yatırım teşvik belgesi incelenmiştir. Kriterlerin önem düzeyinin belirlenmesi ve illerin yatırım performanslarının sıralanması amacıyla Logarithm Methodology of Additive Weights (LMAW) yönteminden yararlanılmıştır. Elde edilen sonuçlar, yatırım teşvik uygulamalarının bölgesel gelişmişlik farklarını azaltma noktasında yeterli etkinlik sağlayamadığını göstermektedir. Bu açıdan, halihazırda uygulanan teşvik politikalarında ciddi bir revizyon gereksinimi olduğu görülmektedir.

Anahtar Sözcükler : Yatırım, Kalkınma, Teşvik, ÇKKV, LMAW.

¹ This study is carried out within the scope of the project "Current Situation Analysis and Policy Recommendations for Investment Incentive System" with number 222K168, supported by The Scientific and Technological Research Council of Türkiye (TÜBİTAK).

² Bu çalışma TÜBİTAK tarafından desteklenen 222168 Numaralı projeden üretilmiştir.

1. Introduction

Regarding linguistic meaning, "incentive" means encouragement, emboldening, etc. On the other hand, from an economic point of view, it corresponds to the meaning of "state support for strategically important sectors". As for "investment incentive," it is expressed as the facilitation provided by using policy instruments to attract domestic and foreign capital to invest in predetermined regions or sectors. From this point of view, the investment incentive system can be defined as a set of tools that encourage investors to support.

Incentive applications in developed and developing countries aim to eliminate current socio-economic problems. In pursuit of this intention, reassigning existing financial resources toward more lucrative areas can eventually be recognised as one of the incentive techniques. Therefore, it is imperative to eschew any short-term expectations stemming from a newly developed incentive program. However, it is important to remember that the design of an incentive proposition should be executed under the parameters of a thorough cost-benefit assessment.

Incentive practices may have different contributions at the stage of an investment decision. The first contribution is reducing investment costs using supports such as taxation exemptions, cash supports, employment supports and allocation of investment location. The second contribution is facilitating the financial requirement of the investment by providing interest support through low-interest domestic and foreign credit channels. Finally, the state's undertaking infrastructure investments, providing energy support, personnel support, purchase guarantees, permits and licenses, etc., contribute to increased profitability of enterprises (Şahin & Kaplan, 2021: 18-19).

When the investment incentive system in Türkiye is examined, the Decree on State Aids for Investments (Yatırımlarda Devlet Yardımları Hakkında Karar, 2012), which was legislated in 2012 with the latest updates, is in force. In line with the targets proposed in the development plans and annual programs, it is intended to channel savings to investments that offer substantial added value, to enhance production and employment, to encourage regional investments and strategic investments with high research and development content that will increase international competitiveness, to increase international foreign direct investments, to reduce regional development disparities, to support investments relevant with clustering and environmental protection and research and development activities.

The amount, duration and rates of incentive items that provinces can benefit from are determined according to predetermined provisions. Depending on the decree above about the incentive applications, each province's socio-economic development index range determines the amount, duration and support rates these provinces can benefit from. Several criteria are used in the socio-economic development index determination studies. For the regulation published in 2012, eight leading indicators were taken as reference: employment, competitive and innovative capacity, financial, demographic, educational, health, accessibility, and quality of life indicators. A total of sixty-one sub-criteria of these main

criteria are considered for calculation, and the provinces are sorted according to these results. The socioeconomic development index represents that the most developed provinces are classified in the first region, while the least developed provinces are classified in the sixth region (Dündar, 2019: 351-352).

Any change in the value of the socio-economic development index for the provinces over the years may inherently cause a change in the regional classification of the provinces. Therefore, a change in the index value of any province benefiting from support in a particular region may cause changes in the amount, duration and rates of support previously benefited by the province. Following the amendments made in the relevant legislation in 2020, the provinces in Türkiye are classified according to the socio-economic development index, as shown in Table 1.

Table: 1
Regional Classification of Provinces

Region 1	Region 2	Region 3	Region 4	Region 5	Region 6
Ankara	Aydın	Adana	Afyonkarahisar	Bayburt	Adıyaman
Antalya	Balıkesir	Burdur	Aksaray	Çankırı	Ağrı
Bursa	Bilecik	Düzce	Amasya	Erzurum	Ardahan
Eskişehir	Bolu	Gaziantep	Artvin	Giresun	Batman
İstanbul	Çanakkale	Karaman	Bartın	Gümüşhane	Bingöl
İzmir	Denizli	Kırıkkale	Çorum	Kahramanmaraş	Bitlis
Kocaeli	Edirne	Kütahya	Elâzığ	Kilis	Diyarbakır
Muğla	Isparta	Mersin	Erzincan	Niğde	Hakkâri
Tekirdağ	Karabük	Samsun	Hatay	Ordu	Iğdir
	Kayseri	Trabzon	Kastamonu	Osmaniye	Kars
	Kırklareli	Rize	Kırşehir	Sinop	Mardin
	Konya	Uşak	Malatya	Tokat	Muş
	Manisa	Zonguldak	Neşehir	Tunceli	Siirt
	Sakarya		Sivas	Yozgat	Şanlıurfa
	Yalova				Şırnak
					Van

The investment incentive system implemented in Türkiye includes three main applications: General Investment Incentive, Regional Investment Incentive and Strategic Investment Incentive, as indicated in Figure 1.

Figure: 1
Investment Incentive System

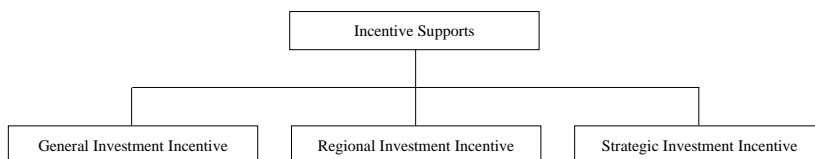

Some types of investments refused to be supported by the law, or those subject to predefined minimum conditions to be supported can benefit from the General Investment Incentive provided that they meet the minimum investment amount in the region. Supported items that can be used in this context are Customs Duty Exemption and VAT Exemption.

On the other hand, considering the region's socio-economic development differences, the Regional Investment Incentive system stipulates different minimum conditions based on each sector. Supported items are Customs Duty Exemption, VAT Exemption, Corporate Tax Reduction, Social Insurance Premium Support (Employer's Share), Land Allocation and Interest or Profit Share Support. In addition to these supports, Social Insurance Premium Support (Employee's Share) and Income Tax Withholding Support are also implemented in the sixth region where the least developed provinces are located.

Investments for manufacturing products specified in the relevant law, with high investment capital and import dependency, are evaluated under the Strategic Investment Incentive system. Supported items are Customs Duty Exemption, VAT Exemption, Corporate Tax Reduction, Social Insurance Premium Support (Employer's Share), Land Allocation, Interest or Profit Share and VAT Refund.

Investment incentives are sometimes confused with grant programs. While the beneficiary receives support over monetary values in grant programs, it is aimed to facilitate investment thanks to the exemptions provided in incentive applications. By the way, it seeks to alleviate the investor's burden both in the investment and operation phases.

VAT Exemption means the investor is exempted from VAT payment for purchasing machinery, equipment, software, and intangibles. Similarly, Customs Duty Exemption means that the investor is exempted from paying customs duty for the same items to be imported. Building construction expenditures to be made within strategic investments with a fixed investment of more than five hundred billion Turkish Liras can benefit from VAT Refund.

If the investor requests interest or profit share support, it can be applied for investments that benefit from support within the scope of regional and strategic investment incentives. Interest or profit share support is applied at different rates for different regions. Similarly, social insurance premium supports are used according to the province's socioeconomic development index.

As clearly stated in the law guiding investment incentive practices in Türkiye, one of the most important purposes of this application is to reduce the development disparities among regions. To contribute to this goal, the state relinquishes some resources such as value-added tax and customs duty, and when necessary, it provides additional financial resources with instruments such as insurance premium support and interest support. Moreover, in socio-economically underdeveloped regions, investment land is allocated free of charge.

When the approach incentive system is analysed holistically, less developed regions seem more advantageous regarding the support supplied during the investment period and, later on, during the operating period. In this case, investors are expected to invest more in less developed provinces to benefit from these financial supports and increase their

profitability. So, is this the case? When the investment incentive certificates issued for different sectors for each province are examined, are the underdeveloped regions able to use this advantage sufficiently? Do investors refrain from investing in developed regions and prefer less developed regions to benefit from investment incentives?

For this purpose, this study aimed to find answers to these questions by examining whether the investment incentive law is by its target. Within the scope of this study, more than 100,000 investment incentive certificates issued between 2001 and 2022, obtained from the Ministry of Industry and Technology of the Turkish Republic, are examined. This list of the obtained certificates includes data such as the date of issuance of the incentive certificate, the province and district where the investment will be executed, the sector of the investment, the budget of the investment, the employment to be procured by the investment, and the exemptions and exceptions to be provided within the scope of the incentive certificate.

2. Literature Review

Studies have been conducted to evaluate investment incentive practices for Türkiye up until today with different aspects. These studies have often been statistically evaluated and aimed to obtain economic inferences. Some of the mentioned studies are as follows.

Sungur (2019) analysed whether the investment applications contributed to the underdeveloped regions using the incentive certificates issued between 2001 and 2016. The data obtained during this period revealed that the number of incentive certificates and investment amounts positively contributed to the underdeveloped regions.

Hazman and Kaya (2018) conducted a study in Afyonkarahisar province to examine the effect of regional incentive certificates issued between 2003 and 2017 on the province's export performance. According to the data obtained from the regression analysis, it has been revealed that the variables of the number of investments with incentive certificates, customs duty exemption and fixed investment amount have a statistically significant effect on export value.

Yanikkaya and Karaboğa (2017) applied the Generalized Method of Moments technique to a panel data set containing six five-year periods between 1981 and 2009. In this way, they aimed to reveal the effect of investment incentives on capital intensity, employment, sectoral labour productivity and total factor productivity for sixteen manufacturing industry sectors in Türkiye. The study shows no evidence that investment incentive practices positively affect any macroeconomic variables examined.

Candan and Yurdadoğ (2017) have analysed the purpose, types, justifications and effective functioning of incentive policies in a theoretical framework and have made a general evaluation of incentive policies by giving information about the forms of incentive policies implemented before and after the planned period in Türkiye.

Using the panel regression model, Selim et al. (2014) aimed to examine the effect of investment incentive certificates and fixed investments on employment in 81 provinces between 2001-2012 in Türkiye. According to the findings, the impact of both the number of incentive certificates and fixed investments on employment is statistically significant, and the effect on employment is positive.

Erdoğan and Ataklı (2012) examined the effect of the incentive program, which was put into effect within the scope of economic measures by Türkiye after the 2008 global crisis, on foreign direct investment. According to the study's results, there has been an increase in the incentive certificates issued in the examined years, which contributed to employment.

LMAW, one of the multi-criteria decision-making methods and a reasonably new approach, is implemented within the scope of the studies described below.

Dündar (2023) has used both LMAW and DNMA methods together to analyse the performance of the Regional Development Agencies in Türkiye in terms of financial support programs since the foundation date of these institutions.

Demir (2022) used LMAW and DNMA methods to measure the quarterly performance of the deposit banking sector during the COVID-19 pandemic, which has affected the whole world in recent years.

Görçün and Küçükönder (2022) made use of the LMAW method to examine the potential of production systems of the heavy industry branches using cyber-physical systems.

Puska et al. (2022) determined the criterion weights using the fuzzy version of the LMAW method to contribute to the producers operating in the agricultural sector while selecting the best green supplier.

Using triangular fuzzy numbers, Bozanic et al. (2022) improved the LMAW method, which is relatively new and defined for exact values. As a result of this modification, the uncertainty in the decision processes of the LMAW method has been largely eliminated.

Pamucar et al. (2021) developed and implemented the LMAW method for the first time to evaluate the operational efficiency of India's six prominent logistics service providers.

Other studies that used the LMAW method can be summarised as follows.

Asadi et al., 2023	The Appropriation of Block Chain Implementation in the Supply Chain of SMES Based on Fuzzy LMAW
Steakytüz, 2023	Analysing Healthcare and Wellness Products' Quality Embedded in Online Customer Reviews
Lukic, 2023	Measurement and Analysis of The Information Performance of Companies in The European Union and Serbia Based on The Fuzzy LMAW and MARCOS Methods
Tešić et al., 2023	Development of the MCDM Fuzzy LMAW - Grey MARCOS Model for the Selection of a Dump Truck
Božanić et al., 2021	Modelling of Neuro-Fuzzy System as a Support in Decision-Making Processes
Subotić et al., 2021	Development of a New Risk Assessment Methodology for Light Goods Vehicles on Two-Lane Road Sections

3. Research Methodology

This study is carried out to examine the investment incentive performance of 81 provinces within the borders of Türkiye. The source data of the study is obtained from the Ministry of Industry and Technology of the Republic of Türkiye. The LMAW method is implemented to determine the criteria weights and order the alternatives.

There are some determinative reasons for selecting this method in our study. Initially, the LMAW method enables the incorporation of several decision-makers from diverse disciplines and is available to reflect their opinions qualitatively. Its stability against rank reversal sensitivity analysis is relatively steady. This method upholds a constant mathematical framework, regardless of the number of alternatives or criteria considered. In addition, it is a very suitable approach for using quantitative and qualitative criteria simultaneously.

To prove the resistance of the LMAW method, a sensitivity analysis is performed by applying the rank reversal method and comparing it with seven diverse multi-criteria decision-making methods.

A flowchart of the applied methods is given in Figure 2.

Figure: 2
Flowchart of the Study

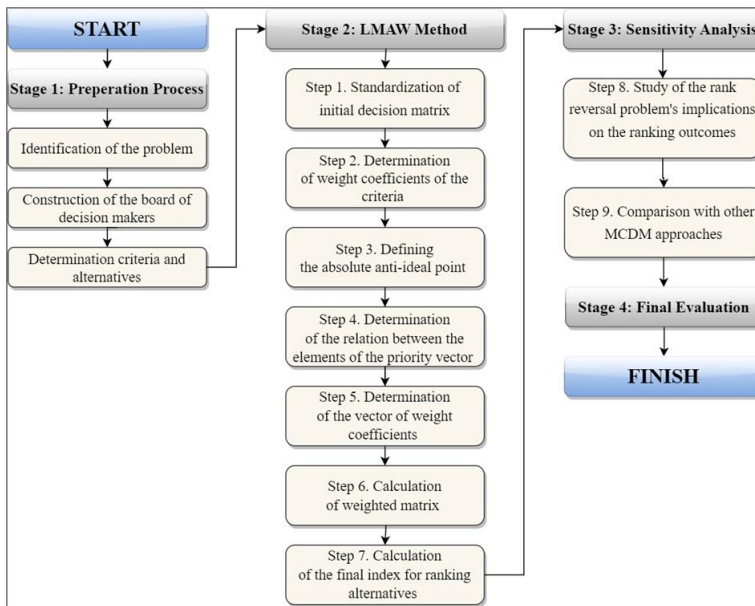

3.1. Calculation Procedure of the LMAW Method

Since the LMAW method was introduced to the literature by Pamucar et al. in 2021, it can be considered one of the more up-to-date methods. Weighting the criteria and ordering the alternatives are executed in the same approach. After generation of the initial decision matrix, the method includes the steps as follows (Pamucar et al., 2021: 365-367);

Step 1: Standardization of elements in the initial decision matrix.

Standardized matrix $Y = [\vartheta_{11}]_{m \times n}$ is obtained by applying Equation (1).

$$\vartheta_{ij} = \frac{\eta_{ij} + \eta_j^+}{\eta_j^+} \text{ for benefit criteria} \tag{1}$$

$$\vartheta_{ij} = \frac{\eta_{ij} + \eta_j^-}{\eta_j^-} \text{ for cost criteria}$$

where η_j^+ is the maximum and η_j^- is the minimum value of the relevant criteria, and ϑ_{ij} corresponds to the standardised values of the initial decision matrix.

Step 2: Determining the weight coefficients of the criteria.

In accordance with the predefined linguistic scale, all experts in the $E = \{E_1, E_2, \dots, E_k\}$ cluster prioritize the $C = \{C_1, C_2, \dots, C_n\}$ criteria. The predefined linguistic scale values are ordered as; 1 - Absolutely Low (AL), 1.5 - Very Low (VL), 2 - Low (L), 2.5 - Medium (M), 3 - Equal (E), 3.5 - Medium High (MH), 4 - High (H), 4.5 - Very High (VH) and 5 - Absolutely High (AH). At the first stage of the prioritization phase, a relatively high value is assigned to important criteria while a relatively low value is assigned to low important criteria. Eventually, the priority vector $P^e = (\gamma_{C_1}^e, \gamma_{C_2}^e, \dots, \gamma_{C_n}^e)$ is obtained. The expression of $\gamma_{C_n}^e$ indicates the linguistic scale value determined by expert e ($1 \leq e \leq k$) to criterion C_t ($1 \leq t \leq n$).

Step 2.1: Defining the absolute anti-ideal point (γ_{AIP}).

The minimum values of the priority vector are taken into consideration for determination of absolute anti-ideal point (γ_{AIP}) and it should be lower than the smallest value from the priority vector. The equation calculates the absolute anti-ideal point value;

$$\gamma_{AIP} = \frac{\gamma_{min}^e}{s}$$

where γ_{min}^e indicates the minimum value of the priority vector. The value of s should be greater than the base of logarithmic function. Considering the logarithmic function as the Ln function, the s value can be reckoned with 3.

Step 2.2: Determination of the relation between the elements of the priority vector and absolute anti-ideal point.

Using Equation (2) below, the relation between the elements of the priority vector and the absolute anti-ideal point is calculated.

$$\eta_{Cn}^e = \frac{Y_{Cn}^e}{Y_{AIP}} \quad (2)$$

Thus and so, relation vector $R^e = (\eta_{C1}^e, \eta_{C2}^e, \dots, \eta_{Cn}^e)$ is acquired where η_{Cn}^e represents the value from the relation vector derived from Equation (1) and R^e represents the relation vector of e ($1 \leq e \leq k$).

Step 2.3: Determination of the vector of weight coefficients $w_j = (w_1, w_2, \dots, w_n)^T$.

The weight coefficients for each criterion are calculated for each expert e ($1 \leq e \leq k$) by implementing Equation (3),

$$w_j^e = \frac{\log_A(\eta_{Cn}^e)}{\log_A(\prod_{j=1}^n \eta_{Cn}^e)}, A > 1 \quad (3)$$

η_{Cn}^e expression in the equation represents the elements of relation vector R and w_j^e indicates the weight coefficients obtained according to the evaluations of the e^{th} expert. All weight coefficients determined should satisfy the condition of $\sum_{j=1}^n w_j^e = 1$.

After that, the aggregated vector of weight coefficients $w_j = (w_1, w_2, \dots, w_n)^T$ is obtained by performing the Bonferroni aggregator as indicated as Equation (4).

$$w_j = \left(\frac{1}{k \cdot (k-1)} \cdot \sum_{x=1}^k (w_j^{(x)})^p \cdot \sum_{\substack{y=1 \\ y \neq x}}^k (w_j^{(y)})^q \right)^{\frac{1}{p+q}} \quad (4)$$

Step 3: Calculation of weighted matrix (N). The elements in weighted matrix $N = [\xi_{ij}]_{m \times n}$ are calculated by Equation (5).

$$\xi_{ij} = \frac{2\varphi_{ij}^{w_j}}{(2-\varphi_{ij})^{w_j} + \varphi_{ij}^{w_j}} \quad (5)$$

where

$$\varphi_{ij} = \frac{\ln(\vartheta_{ij})}{\ln(\prod_{i=1}^m \vartheta_{ij})} \quad (6)$$

ϑ_{ij} presents the elements in standardized matrix $Y = [\vartheta_{11}]_{m \times n}$ while w_j presents the weight coefficients for each criterion.

Step 4: Calculation of the final index for ranking alternatives (Q_i).

Final index for ranking alternatives is calculated by Equation (7).

$$Q_i = \sum_{j=1}^n \xi_{ij} \quad (7)$$

where ξ_{ij} presents the elements in weighted matrix $N = [\xi_{ij}]_{m \times n}$.

3.2. Rank Reversal Analysis

Obtaining consistent results in multi-criteria decision-making problems is important to prove the method's reliability (Pamucar et al., 2021: 373). During the analysis, adding new alternatives or sequentially removing the lowest-performing criteria can be a method that can be used to verify its reliability. The main expectation is that the resulting sequence does not change significantly after these steps are performed (Žižović et al., 2020: 10-11).

3.3. Comparison with Other MCDM Methods

There is a wide array of Multi-Criteria Decision Making (MCDM) methodologies within the literature, and the evaluation approaches of each may differ more or less from each other. Obtaining similar results through multiple methods will contribute to the reliability of the strategy implemented. In addition to the LMAW approach used as the primary method in the study; ARAS (Zavadskas & Turskis, 2010: 163-165), CoCoSo (Yazdani et al., 2018: 2507-2508), CRADIS (Puška et al., 2022b: 11204-11205), EDAS (Ghorabae et al., 2015: 439-441), MABAC (Pamucar & Čirović, 2015: 3019-3021), MAIRCA (Gigović et al., 2016: 11-13) and MAUT (Keeney et al., 1979: 403) are also implemented to enable making comparison among them.

The Spearman Rank Correlation Coefficient (SRCC) is employed to establish the statistical correlation between the LMAW approach and alternative MCDM methods, using the orders they disclosed (Liao & Wu, 2020: 13; Hafezalkotob & Hafezalkotob, 2015: 952).

4. Performances Evaluation of Provinces in Terms of Investment Incentives

4.1. Problem Description

The primary purpose of this evaluation is to determine whether the investment incentive system contributes to reducing regional development disparities, which is one of its main objectives. For this reason, the performance of the provinces within the scope of investments with investment incentive certificates is examined in this study. Investment incentive certificates obtained for each province indicated in Table 2 are discussed in line with the criteria listed in Table 3.

Table: 2
List of the Provinces

Adana	Artvin	Bolu	Edirne	Hatay	Kastamonu	Malatya	Osmaniye	Tekirdağ
Adıyaman	Aydın	Burdur	Elazığ	İğdır	Kayseri	Manisa	Rize	Tokat
Afyonkarahisar	Balıkesir	Bursa	Erzincan	Isparta	Kırkkale	Mardin	Sakarya	Trabzon
Ağrı	Bartın	Çanakkale	Erzurum	Istanbul	Kırklareli	Mersin	Samsun	Tunceli
Aksaray	Batman	Çankırı	Eskişehir	İzmir	Kırşehir	Muğla	Siirt	Uşak
Amasya	Bayburt	Çorum	Gaziantep	Kahramanmaraş	Kilis	Muş	Sinop	Van
Ankara	Bilecik	Denizli	Giresun	Karabük	Kocaeli	Nevşehir	Sivas	Yalova
Antalya	Bingöl	Diyarbakır	Gümüşhane	Karaman	Konya	Niğde	Şanlıurfa	Yozgat
Ardahan	Bitlis	Düzce	Hakkâri	Kars	Kütahya	Ordu	Şırnak	Zonguldak

Table: 3
List of Criteria

C1:	Number of foreign investment incentive certificates
C2:	Fixed investment amount of foreign investments (M ₺)
C3:	Employment forecast procured by foreign Investment
C4:	Number of domestic investment incentive certificates
C5:	Fixed investment amount of domestic investments (M ₺)
C6:	Employment forecast procured by domestic Investment

Criterion C1 indicates the number of incentive certificates issued within the scope of foreign investment. C2 is the fixed investment amount of foreign investments, while C3 is the employment forecast created by these foreign investments. On the other hand, C4 indicates the number of incentive certificates issued as domestic investment. C5 corresponds to the fixed investment amount of domestic investments, while C6 points to the employment forecast that emerged from domestic investments.

4.2. LMAW Method Application

The provinces whose performances will be evaluated and the data regarding the evaluation criteria are listed in Appendix 1A as the initial decision matrix.

The initial decision matrix is standardised using Equation (1). However, due to the large number of provinces, the first and last three data are shown and summarised in Table 4.

Table: 4
Standardised Decision Matrix

	C1	C2	C3	C4	C5	C6
Adana	1.1530	1.2639	1.4085	1.1646	1.1645	1.1249
Adıyaman	1.0063	1.0002	1.0203	1.0808	1.0342	1.1443
Afyonkarahisar	1.0392	1.0049	1.0137	1.0955	1.0488	1.0514
⋮	⋮	⋮	⋮	⋮	⋮	⋮
Yalova	1.0329	1.0366	1.0270	1.0388	1.0945	1.0913
Yozgat	1.0063	1.0295	1.0050	1.0293	1.0159	1.0199
Zonguldak	1.0152	1.0073	1.0066	1.0358	1.0581	1.0415

Since all the criteria are benefit-oriented, the relevant equation is applied as follows;

$$\vartheta_{11} = \frac{121 + 791}{791} = 1,1530$$

where η_1^+ value is 791, which corresponds to the total number of foreign investment incentive certificates for İstanbul province.

Eight Decision Makers (DM), consisting of representatives from the Chamber of Commerce and Industry, Organized Industry Zone Directorate, Chamber of Financial Advisors, energy sector, service sector, manufacturing industry sector, mining sector and agriculture sector, contributed to determining the criteria weights.

Priority vectors derived from the linguistic scale, obtained from eight experts' opinions, are given in Table 5. The implementation steps are also explained.

Table: 5
Priority Vectors

	C1	C2	C3	C4	C5	C6
DM1	5	4	1.5	5	4	1.5
DM2	4	3.5	1	5	4	1
DM3	5	3.5	1	5	3.5	1
DM4	5	4	1	5	4	1.5
DM5	4.5	4	1	4.5	4	1.5
DM6	5	3.5	1	5	3.5	1
DM7	5	3.5	1.5	5	4	1.5
DM8	4.5	3.5	1	4.5	3.5	1

The relationship between the elements of the priority vector and the absolute anti-ideal point (Y_{AIP}) is determined based on the data obtained from the expert priority vectors and arbitrarily defined absolute anti-ideal point $Y_{AIP} = 0.5$.

The elements of the vector R^1 are obtained by applying Equation (2) as follows.

$$\eta_{c_1}^1 = \frac{5}{0,5} = 10, \eta_{c_2}^1 = \frac{4}{0,5} = 8, \eta_{c_3}^1 = \frac{1,5}{0,5} = 3, \eta_{c_4}^1 = \frac{5}{0,5} = 10, \eta_{c_5}^1 = \frac{4}{0,5} = 8, \eta_{c_6}^1 = \frac{1,5}{0,5} = 3$$

The remaining elements of vectors $R^2, R^3, R^4, R^5, R^6, R^7$ and R^8 are calculated in similar manner as resulted in as follows;

$$R^1 = (10, 8, 3, 10, 8, 3) \quad R^2 = (8, 7, 2, 10, 8, 2) \quad R^3 = (10, 7, 2, 10, 7, 2) \quad R^4 = (10, 8, 2, 10, 8, 3) \\ R^5 = (9, 8, 2, 9, 8, 3) \quad R^6 = (10, 7, 2, 10, 7, 2) \quad R^7 = (10, 7, 3, 10, 8, 3) \quad R^8 = (9, 7, 2, 9, 7, 2)$$

The elements of the first expert's vector w_j^1 are calculated individually to create the weight coefficients vector by applying Equation (3) as follows.

$$w_1^1 = \frac{\ln(10)}{\ln(10.8.3.10.8.3)} = 0.210 \quad w_2^1 = \frac{\ln(8)}{\ln(10.8.3.10.8.3)} = 0.190 \\ w_3^1 = \frac{\ln(3)}{\ln(10.8.3.10.8.3)} = 0.100 \quad w_4^1 = \frac{\ln(10)}{\ln(10.8.3.10.8.3)} = 0.210 \\ w_5^1 = \frac{\ln(8)}{\ln(10.8.3.10.8.3)} = 0.190 \quad w_6^1 = \frac{\ln(3)}{\ln(10.8.3.10.8.3)} = 0.100$$

The values of weight coefficients obtained meet the condition of $\sum_{j=1}^9 w_j^1 = 1$. The remaining elements of vectors $w_j^2, w_j^3, w_j^4, w_j^5, w_j^6, w_j^7$ and w_j^8 are calculated in similar manner as follows;

$$w_j^1 = (0.210; 0.190; 0.100; 0.210; 0.190; 0.100)$$

$$w_j^2 = (0.212; 0.199; 0.071; 0.235; 0.212; 0.071)$$

$$w_j^3 = (0.233; 0.197; 0.070; 0.233; 0.197; 0.070)$$

$$w_j^4 = (0.218; 0.197; 0.066; 0.218; 0.197; 0.104)$$

$$w_j^5 = (0.212; 0.201; 0.067; 0.212; 0.201; 0.106)$$

$$w_j^6 = (0.233; 0.197; 0.070; 0.233; 0.197; 0.070)$$

$$w_j^7 = (0.213; 0.180; 0.101; 0.213; 0.192; 0.101)$$

$$w_j^8 = (0.227; 0.201; 0.072; 0.227; 0.201; 0.072)$$

The aggregate vector of the weighting coefficients is obtained by applying the Equation (4).

For instance, the value of w_1 is calculated by average values of w_j^e ($1 \leq e \leq 8$) for each expert where $w_1^1 = 0.210$, $w_1^2 = 0.212$, $w_1^3 = 0.233$, $w_1^4 = 0.218$, $w_1^5 = 0.212$, $w_1^6 = 0.233$, $w_1^7 = 0.213$ and $w_1^8 = 0.227$ as follows.

$$w_1 = \left[\frac{0.210^1 \cdot 0.212^1 + 0.210^1 \cdot 0.233^1 + 0.210^1 \cdot 0.218^1 + \dots + 0.227^1 \cdot 0.212^1 + 0.227^1 \cdot 0.233^1 + 0.227^1 \cdot 0.213^1}{8(8-1)} \right]^{\left(\frac{1}{8}\right)} = 0.2198$$

The remaining values of the vectors of the weight coefficients are obtained correspondingly.

$$w_j = (0.2198, 0.1951, 0.0770, 0.2227, 0.1984, 0.0866)^T$$

The evaluation of criterion weights indicates that the Number of Domestic Investment Incentive Certificates (C4) emerged as the most crucial criterion, while the Employment Forecast Procured by Foreign Investment (C3) is the least important one. The final significance of the criteria can be ordered as $C4 > C1 > C5 > C2 > C6 > C3$.

The elements of weighted matrix $N = [\xi_{ij}]_{m \times n}$ are calculated according to Equation (5) and Equation (6) and the results are summarized in Table 6.

Table: 6
Elements of Weighted Matrix

	C1	C2	C3	C4	C5	C6
Adana	0.5568	0.6614	0.8700	0.5436	0.5914	0.7999
Adiyaman	0.3248	0.2176	0.7636	0.4859	0.4739	0.8056
Afyonkarahisar	0.4481	0.3755	0.7493	0.4992	0.4995	0.7645
⋮	⋮	⋮	⋮	⋮	⋮	⋮
Yalova	0.4350	0.5088	0.7739	0.4297	0.5487	0.7874
Yozgat	0.3248	0.4934	0.7136	0.4091	0.4217	0.7264
Zonguldak	0.3804	0.3998	0.7232	0.4236	0.5123	0.7559

As an example;

$$\varphi_{11} = \frac{\ln(1.1530)}{\ln(1.1530 * \dots * 1.0152)} = 0.0259$$

$$\xi_{11} = \frac{2 * 0.0259^{0.2198}}{(2 - 0.0259)^{0.2198} + 0.0259^{0.2198}} = 0.5568$$

The final indices (Q_i) of alternatives are calculated based on Equation (7). Final indices and the order of the provinces are listed in Table 7.

Table: 7
Final Indices and Orders of Provinces

Province	Q_i	Order	Province	Q_i	Order	Province	Q_i	Order
Adana	4.0231	10	Edirne	3.0569	56	Malatya	3.3024	37
Adiyaman	3.0714	54	Elazığ	3.3395	32	Manisa	4.0606	9
Afyonkarahisar	3.3361	33	Erzincan	3.1736	47	Mardin	3.2051	41
Ağrı	2.7308	71	Erzurum	2.7457	70	Mersin	4.0834	8
Aksaray	3.5541	23	Eskişehir	3.7293	14	Muğla	3.6131	18
Amasya	3.1347	48	Gaziantep	3.8830	11	Muş	1.5055	76
Ankara	4.2078	5	Giresun	3.0235	59	Neşehir	2.8647	67
Antalya	4.1502	6	Gümüşhane	1.4057	78	Niğde	3.3123	35
Ardahan	1.2418	81	Hakkâri	1.3296	79	Ordu	3.1792	45
Artvin	2.9305	62	Hatay	3.6175	17	Osmaniye	3.1901	44
Aydın	3.5053	26	İğdir	2.5297	74	Rize	2.8118	68
Balıkesir	3.7162	15	Isparta	3.1769	46	Sakarya	3.8476	12
Bartın	2.9355	61	Istanbul	4.6261	1	Samsun	3.4541	29
Batman	3.1240	49	İzmir	4.3412	3	Siirt	2.6131	73
Bayburt	2.4198	75	Kahramanmaraş	3.5263	24	Sinop	2.7971	69
Bilecik	3.5595	22	Karabük	1.4925	77	Sivas	3.2359	39
Bingöl	3.0381	58	Karaman	3.3048	36	Şanlıurfa	3.5973	19
Bitlis	2.6610	72	Kars	2.8778	64	Şırnak	2.8729	65
Bolu	3.2143	40	Kastamonu	3.0858	52	Tekirdağ	4.1248	7
Burdur	3.0607	55	Kayseri	3.6708	16	Tokat	3.0401	57
Bursa	4.3666	2	Kırkkale	2.8709	66	Trabzon	3.0985	50
Çanakkale	3.4826	28	Kırklareli	3.5234	25	Tunceli	1.2968	80
Çankırı	3.2887	38	Kırşehir	2.9270	63	Uşak	3.3276	34
Çorum	3.0806	53	Kilis	2.9474	60	Van	3.1917	43
Denizli	3.5795	21	Kocaeli	4.3137	4	Yalova	3.4834	27
Diyarbakır	3.3944	30	Konya	3.8415	13	Yozgat	3.0890	51
Düzce	3.5908	20	Kütahya	3.3616	31	Zonguldak	3.1951	42

The final index of Adana province is calculated as;

$$Q_1 = 0.5568 + 0.6614 + 0.8700 + 0.5436 + 0.5914 + 0.7999 = 4.0231$$

According to the absolute indices of provinces, İstanbul, Bursa, İzmir, Kocaeli, Ankara, Antalya, Tekirdağ, Mersin, Manisa and Adana are ordered sequentially in the first ten order. However, Bitlis, Siirt, Iğdır, Bayburt, Muş, Karabük, Gümüşhane, Hakkari, Tunceli and Ardahan showed minor performance in terms of the same evaluation.

4.3. Sensitivity Analysis with Rank Reversal Method

In line with the principles revealed by the method, the alternative with the lowest performance is removed sequentially from the list, and new orders are obtained. The shifts in the order of the options according to the Rank Reversal Analysis result are visualised in Figure 3.

Figure: 3
Effect of Rank Reversal Analysis

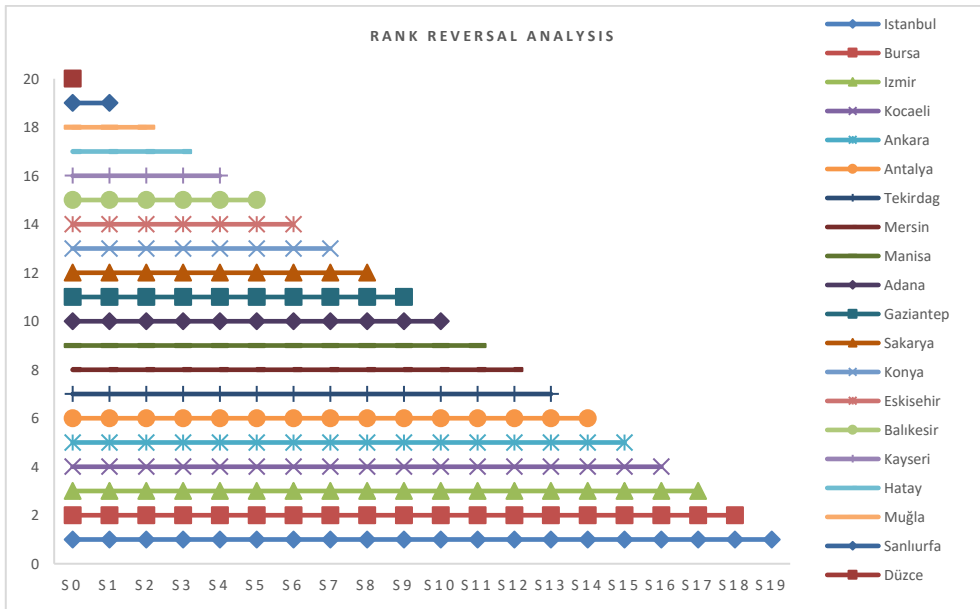

It is evident from Figure 3 that the LMAW model is effective in generating valid outputs in a dynamic environment and has a robust resistance against rank reversal problems. The advantages of the top-ranked option are preserved across all situations.

4.4. Comparison with Other MCDM Methods

In addition to the LMAW approach used as the primary method in the study, evaluation is also made with ARAS, CoCoSo, CRADIS, EDAS, MABAC, MAIRCA and MAUT methods, and the ranking results obtained are indicated in Appendix 1B. Due to the

vast number of alternatives, the provinces in the top twenty order according to the results of the LMAW method are bar-charted in Figure 4.

Figure: 4
Comparison with other MCDM Methods

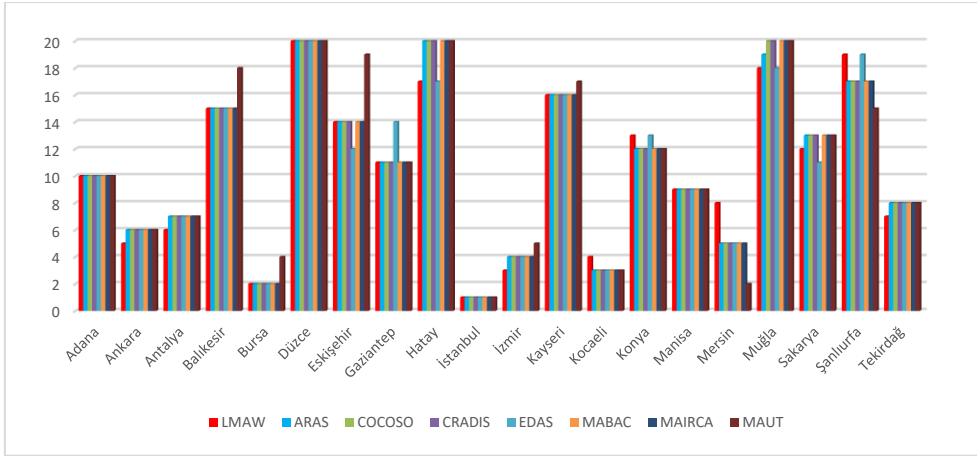

The ordering results performed by other methods also result in consistency compared with LMAW method results. This is a significant indicator to prove the validity of the obtained orders.

Based on their rankings, the Spearman Rank Correlation Coefficient establishes the statistical correlation between the LMAW method and other techniques. Table 8 presents the outcomes obtained through using SRCC to compare the orders. Based on the data in Table 8, one can conclude that the LMAW approach exhibits a significant correlation (over 0.932) with the remaining seven MCDM techniques. To summarise, it can be inferred from the suggested method that the sequencing is verified and dependable.

Table: 8
Rank Correlations of the Models Tested

	ARAS	CoCoSo	CRADIS	EDAS	MABAC	MAIRCA	MAUT
LMAW	0.982	0.982	0.982	0.979	0.982	0.982	0.932

When all the results are evaluated together, contrary to the argument put forward by the investment incentive legislation, capital owners prioritise the already developed provinces regarding investment location preferences. The evaluation performed with the LMAW method regarding the investment performance of the provinces has revealed results which refute this suggestion. Sensitivity analysis with rank reversal revealed that the MCDM method has a consistent structure. Obtaining similar results in the order performed with other

MCDM methods and high correlation among them increased the reliability of the applied method.

5. Results and Discussion

In this study, the investment incentive system, implemented as an instrument to trigger investments in Türkiye, has been examined on a provincial and sectoral basis. The weights of the criteria used for the evaluation are determined by eight decision-makers who are experts in their fields. As a result of the evaluation, it is determined that the most important criterion was "Number of Domestic Investment Incentive Certificates" (C4), and the least important criterion was "Employment Forecast Procured by Foreign Investment" (C3). After that, the success indicators of all provinces in terms of investment performance within the scope of the incentive certificates are ordered. The Additive Weights method's Logarithm Methodology carries out both evaluations.

Considering the investments that obtained incentive certificates, it is observed that İstanbul has a superior position compared to other provinces. Within the scope of the same evaluation, Bursa, İzmir, Kocaeli, Ankara, Antalya, Tekirdağ, Mersin, Manisa, Adana, Gaziantep, Sakarya, Konya, Eskişehir, Balıkesir, Kayseri, Hatay, Muğla, Şanlıurfa and Düzce are ordered sequentially in the first twenty order after İstanbul province.

A vital point emerged in this order is that İstanbul, Bursa, İzmir, Kocaeli, Ankara, Antalya, Tekirdağ, Eskişehir and Muğla provinces are classified in the first region. Manisa, Sakarya, Konya, Balıkesir and Kayseri are in the second, and Mersin, Adana and Gaziantep are in the third region. In addition, the least order value of the provinces in the first region is 18, which points to the province of Muğla.

According to the performance evaluation, 11 of the 15 provinces in the second region are in the top 28 regarding investment performance. Meanwhile, 10 of the 13 provinces in the third region are in the top 50 in terms of the same evaluation. The last ten provinces are ordered as Bitlis, Siirt, Iğdır, Bayburt, Muş, Karabük, Gümüşhane, Hakkari, Tunceli and Ardahan. In this order, Bitlis, Siirt, Iğdır, Muş, Hakkari and Ardahan are classified in the sixth region, whereas Karabük is in the second and Gümüşhane and Tunceli are in the fifth region.

Mersin and Adana provinces are classified in the third region. However, especially in recent years, high energy and agricultural investments have been made in these provinces, significantly contributing to their performance. Investments in the manufacturing industry made in provinces such as Manisa, Gaziantep, Sakarya, Konya, Balıkesir, Kayseri, Şanlıurfa and Düzce in recent years have been an important factor for these provinces being ordered in the top twenty.

The provinces in the first region have many advantages, such as robust industrial infrastructure, access to ports, access to raw materials and markets, hosting the most qualified universities, and potential in terms of skilled labour supply.

Considering that all the provinces in the first twenty are relatively developed, the tendency of investors in terms of investment location does not show an alteration despite the advantages of the incentive system. Namely, despite the excellent support items such as Customs Duty Exemption, VAT Exemption, Corporate Tax Reduction, Social Insurance Premium Support (Employer's Share), Land Allocation, Interest Rate Support, Social Insurance Premium Support (Employee's Share) and Income Tax Withholding Support, the underdeveloped regions do not tempt the investors sufficiently.

Indeed, when the provinces in the regions determined according to the socio-economic development index and the investment incentive data are analysed together, it is seen that the first region has the highest share, with 42.55% in terms of the number of incentive certificates. On the other hand, the remaining regions have a share of 18.04%, 13.87%, 8.63%, 6.49% and 10.42%, respectively. Regarding the fixed investment amount, the first region dominates almost half of the investment expenditures in Türkiye, with a share of 47.54%. The remaining total fixed investment amounts are shared as 20.00%, 16.74%, 6.48%, 5.10% and 4.14%, respectively, according to the region's number.

In this case, it is an issue that needs to be questioned whether the investment incentive system in Türkiye is implemented for its purpose. This situation points out that factors investors consider on the sidelines of making investment decisions are issues that must be studied comprehensively. Apart from the support already provided, introducing new incentives that encourage investors to invest in underdeveloped regions should be the most critical agenda for policymakers dealing with this issue.

Visits to some of the Chambers of Commerce and Industry, which are the direct interlocutors of the investment incentive system, have also given rise to important ideas. The most important point emphasised by the chamber representatives is that the socio-economic development index used in the regional classification of provinces is far from being a fair approach. Concerns about political interference while making the socio-economic categorisation of provinces have been particularly articulated. While regional classification processes are already perceived as inequitable, deploying a new concept such as the "Centre of Attraction" triggers a sense of discrimination between regions. In this respect, it may be helpful to transform investment incentives into an optional and flexible structure rather than standard applications so that they would be practical, efficient and easily implementable.

Investors usually avoid obtaining incentive certificates because incentive implementation processes have a challenging bureaucracy. They often outsource this service to intermediary consulting companies to avoid this intensive bureaucracy. Intermediary institutions' quantitative and qualitative inadequacy, especially in relatively less developed regions, constitutes a second disadvantage for these regions in benefiting from incentives. This situation is also frequently experienced in the revision processes of incentive certificates. Even though the E-TUYS application aims to facilitate these processes, this system is not considered user-friendly.

In almost every sector, the problem of employing intermediate staff is expressed, and it seems pretty essential to put high-level incentive supports in force, especially for the employment of vocational high school and/or vocational college graduates. In addition, implementing incremental insurance premiums for minimum wage in areas where the unemployment problem is intense could also alleviate the issue of migration in these regions.

References

- Asadi, M. et al. (2023), "The appropriation of blockchain implementation in the supply chain of SMEs based on fuzzy LMAW", *Engineering Applications of Artificial Intelligence*, 123, 106169.
- Božanić, D. et al. (2021), "Modeling of Neuro-Fuzzy System as a Support in Decision-Making Processes", *Reports in Mechanical Engineering*, 2(1), 222-234.
- Božanić, D. et al. (2022), "Modification of the Logarithm Methodology of Additive Weights (LMAW) by a Triangular Fuzzy Number and Its Application in Multi-Criteria Decision Making", *Axioms*, 11(3), 89.
- Candan, G.T. & V. Yurdadoğ (2017), "Incentive Policies as Fiscal Policy Instruments in Turkey", *Pamukkale University Journal of Social Sciences Institute*, 27, 154-177.
- Demir, G. (2022), "Analysis of the Financial Performance of the Deposit Banking Sector in The COVID-19 Period with LMAW-DNMA Methods", *International Journal of Insurance and Finance*, 2(2), 17-36.
- Dündar, S. (2019), "Yatırımlarda Devlet Yardımları ve Sivas Yansımaları", in: İ. Noyan-Yalman (ed.), *Sivas Ekonomisi-Geçmişi, Bugünü, Geleceği* (349-368), Sivas Vilayet Kitaplığı.
- Dündar, S. (2023), "Performance Analysis of Regional Development Agencies by LMAW-DNMA Methods", *Eskişehir Osmangazi Üniversitesi İİBF Dergisi*, 18(2), 354-380.
- Erdoğan, E. & R. Ataklı (2012), "Investment Incentives and FDI in Turkey: The Incentives Package after the 2008 Global Crisis", *Procedia - Social and Behavioral Sciences*, 58, 1183-1192.
- Ghorabae, M.K. et al. (2015), "Multi-Criteria Inventory Classification Using a New Method of Evaluation Based on Distance from Average Solution (EDAS)", *Informatica*, 26(3), 435-451.
- Gigović, L. et al. (2016), "The Combination of Expert Judgment and GIS-MAIRCA Analysis for the Selection of Sites for Ammunition Depots", *Sustainability*, 8(4), 372.
- Görçün, Ö.F. & H. Küçükönder (2022), "Evaluation of The Transitions Potential to Cyber-Physical Production System of Heavy Industries in Turkey with A Novel Decision-Making Approach Based On Bonferroni Function", *Verimlilik Dergisi*, (Dijital Dönüşüm ve Verimlilik Özel Sayısı), 1-16.
- Hafezalkotob, A. & A. Hafezalkotob (2015), "Comprehensive MULTIMOORA method with target-based attributes and integrated significant coefficients for materials selection in biomedical applications", *Materials & Design*, 87, 949-959.
- Hazman, G.G. & P.B. Kaya (2018), "Bölgesel Teşvik Uygulamaları ile İhracat İlişkisinin Afyonkarahisar İli Örneğinde Regresyon Analizi ile Değerlendirilmesi", *Avrasya Sosyal ve Ekonomi Araştırmaları Dergisi*, 5(5), 42-57.
- Keeney, R.L. et al. (1979), "Decisions with Multiple Objectives: Preferences and Value Trade-Offs", *IEEE Transactions on Systems, Man, and Cybernetics*, 9(7), 403.

- Liao, H. & X. Wu (2020), "DNMA: A Double Normalization-Based Multiple Aggregation Method for Multi-Expert Multi-Criteria Decision Making", *Omega*, 94(3), 102058.
- Lukic, R. (2023), "Measurement and Analysis of The Information Performance of Companies in The European Union and Serbia Based on The Fuzzy LMAW and MARCOS Methods", *Informatica Economică*, 27(1), 17-31.
- Pamucar, D. & G. Ćirović (2015), "The selection of transport and handling resources in logistics centers using Multi-Attributive Border Approximation area Comparison (MABAC)", *Expert Systems with Applications*, 42(6), 3016-3028.
- Pamucar, D. et al. (2021), "A New Logarithm Methodology of Additive Weights (LMAW) for Multi-Criteria Decision-Making: Application in Logistics", *Facta Universitatis Series Mechanical Engineering*, 19(3), 361-380.
- Puška, A. et al. (2022a), "Green Supplier Selection in an Uncertain Environment in Agriculture Using a Hybrid MCDM Model: Z-Numbers-Fuzzy LMAW-Fuzzy CRADIS Model", *Axioms*, 11(9), 427.
- Puška, A. et al. (2022b), "Evaluation and Selection of Healthcare Waste Incinerators Using Extended Sustainability Criteria and Multi-Criteria Analysis Methods", *Environment, Development and Sustainability*, 24(9), 11195-11225.
- Şahin, M.Y. & H. Kaplan (2021), *Dönüşüm Sürecinde Yatırım Teşviklerinin Dünü ve Bugünü*, Ankara, Türkiye: TOBB Yayınları.
- Selim, S. et al. (2014), "Effect on Employment of the Investment Incentives and Fixed Investments in Turkey: Panel Data Analysis", *Ege Academic Review*, 14(4), 661-674.
- Sıcakyüz, Ç. (2023), "Analyzing Healthcare and Wellness Products' Quality Embedded in Online Customer Reviews: Assessment with a Hybrid Fuzzy LMAW and Fermatean Fuzzy WASPAS Method", *Sustainability*, 15(4), 3428.
- Subotić, M. et al. (2021), "Development of a New Risk Assessment Methodology for Light Goods Vehicles on Two-Lane Road Sections", *Symmetry*, 13(7), 1271.
- Sungur, O. (2019), "Spatial Distribution of Investment Incentives and the Impact of New Incentive System for Less Developed Regions in Turkey", *Review of Economic Perspectives*, 19, 25-48.
- Tešić, D. et al. (2023), "Development of the MCDM Fuzzy LMAW - Grey MARCOS Model for Selection of a Dump Truck", *Reports in Mechanical Engineering*, 4(1), 1-17.
- Yanikkaya, H. & H. Karaboga (2017), "The Effectiveness of Investment Incentives in the Turkish Manufacturing Industry", *Prague Economic Papers*, 26(6), 744-760.
- Yazdani, M. et al. (2018), "A Combined Compromise Solution (CoCoSo) Method for Multi-Criteria Decision-Making Problems", *Management Decision*, 57(9), 2501-2519.
- Zavadskas, E.K. & Z. Turskis (2010), "A New Additive Ratio Assessment (ARAS) Method in Multicriteria Decision-Making", *Technological and Economic Development of Economy*, 16(2), 159-172.
- Žižović, M. et al. (2020), "Eliminating Rank Reversal Problem Using a New Multi-Attribute Model - The RAFSI Method", *Mathematics*, 8(6), 1015.

Appendix: 1A Initial Decision Matrix

	C1	C2	C3	C4	C5	C6
Adana	121	21,688.81	24,553	2,259	56,947.86	57,153
Aydın	5	15.29	1,222	1,109	11,835.49	66,046
Afyonkarahisar	31	403.48	822	1,311	16,893.55	23,538
Ağrı	2	9.18	573	242	4,667.88	11,732
Aksaray	34	7,095.96	7,471	701	14,041.57	21,256
Amasya	22	995.32	710	391	3,626.62	10,923
Ankara	240	17,682.04	10,351	5,196	129,921.86	158,901
Antalya	158	23,288.62	15,715	3,938	78,655.40	173,279
Ardahan	-	-	-	56	649.14	1,606
Artvin	9	815.00	207	159	5,539.78	2,862
Aydın	37	933.87	1,234	1,120	48,741.89	40,294
Balıkesir	70	6,856.61	2,678	1,337	38,991.24	33,610
Bartın	5	164.93	1,281	145	10,118.64	7,088
Batman	7	25.60	1,865	1,330	7,230.44	99,832
Bayburt	3	49.03	3	95	1,154.77	1,466
Bilecik	77	2,251.56	5,065	524	32,622.67	21,145
Bingöl	3	4,133.96	350	287	2,542.06	10,616
Bitlis	1	1.01	102	431	6,270.34	25,075
Bolu	18	585.87	578	476	13,537.91	24,596
Burdur	16	152.20	1,413	481	5,695.90	8,706
Bursa	454	41,126.37	51,282	5,443	112,317.82	134,742
Canakkale	40	4,948.31	1,624	527	21,978.23	15,485
Cankırı	11	3,118.79	3,177	379	9,412.55	13,323
Çorum	10	556.17	138	645	6,939.14	16,435
Denizli	43	1,965.05	1,262	3,031	29,241.93	42,616
Diyarbakır	17	173.78	2,511	2,057	20,190.60	106,192
Düzce	69	3,321.17	5,987	715	21,673.33	29,552
Edirne	15	548.76	328	304	6,422.29	9,738
Elazığ	20	1,131.04	1,476	734	15,396.70	24,631
Erzincan	10	4,742.50	604	329	4,011.66	9,463
Erzurum	4	30.52	1	619	10,116.64	20,193
Eskişehir	86	6,559.74	5,951	1,140	29,889.86	37,105
Gaziantep	148	1,861.86	2,778	3,622	98,445.70	107,851
Giresun	11	259.64	794	378	4,637.96	11,426
Gümüşhane	-	-	-	150	2,952.73	2,832
Hakkâri	-	-	-	105	1,270.39	2,477
Hatay	58	4,656.38	2,682	1,048	28,072.90	26,319
İğdir	2	16.19	70	161	999.95	5,364
İsparta	24	433.57	612	621	8,750.27	11,355
İstanbul	791	46,248.41	60,108	13,723	346,095.86	457,658
İzmir	422	23,876.50	28,497	5,132	196,005.13	149,948
Kahramanmaraş	31	930.77	929	1,759	47,877.57	51,613
Karabük	22	2,635.39	1,834	486	4,801.38	6,790
Karaman	7	1,131.22	72	184	1,692.35	8,289
Kastamonu	9	436.69	325	457	10,361.74	14,440
Kayseri	42	3,978.54	2,560	1,966	35,124.09	48,512
Kırkkale	5	87.05	211	303	8,045.57	6,978
Kırklareli	59	2,572.65	1,606	538	38,587.44	22,485
Kırşehir	6	552.23	84	269	6,409.67	6,741
Kilis	11	280.96	418	197	5,840.40	5,604
Kocaeli	612	40,175.36	43,843	2,926	110,068.77	86,291
Konya	75	2,570.56	3,068	4,318	82,149.82	78,300
Kütahya	22	639.26	811	761	36,290.14	29,287
Malatya	16	202.82	722	1,140	23,639.35	71,976
Manisa	229	17,212.89	12,494	3,176	70,506.87	76,811
Mardin	15	59.22	2,088	1,281	7,255.35	83,528
Mersin	145	82,183.11	7,735	2,123	57,916.66	41,229
Muğla	56	1,787.73	2,874	1,304	39,073.91	46,788
Muş	-	-	-	276	2,798.08	14,008
Nevesehir	8	31.81	97	601	5,670.46	9,347
Niğde	22	822.15	1,656	611	19,737.24	14,381
Ordu	14	437.95	997	579	7,961.78	26,693
Osmaniye	21	819.56	418	310	8,885.15	13,779
Rize	7	107.57	355	226	2,548.61	4,799
Sakarya	127	8,162.56	10,765	1,235	46,698.52	44,740
Samsun	26	2,542.51	700	1,066	22,030.77	32,277
Siirt	1	0.56	400	237	5,512.52	11,238
Sinop	2	255.24	95	242	4,033.91	8,826
Sivas	19	403.70	1,083	803	10,656.85	22,025
Şanlıurfa	44	879.72	6,751	1,945	25,355.93	78,614
Sırnak	4	38.01	420	419	4,497.95	21,361
Tekirdağ	269	18,367.80	18,789	2,459	86,216.87	88,822
Tokat	9	75.97	905	589	6,015.06	30,786
Trabzon	9	489.29	309	576	7,186.24	13,329
Tunceli	-	-	-	88	933.62	2,133
Uşak	17	2,157.27	1,391	726	11,738.28	14,069
Van	12	169.98	5,671	623	7,918.27	33,179
Yalova	26	3,004.51	1,625	533	32,697.80	41,762
Yozgat	5	2,428.17	301	402	5,502.89	9,085
Zonguldak	12	601.48	395	491	20,116.09	18,992

Appendix: 1B

Orders Obtained by Different MCDM Methods

	LMAW	ARAS	COCOSO	CRADIS	EDAS	MABAC	MAIRCA	MAUT
Adana	10	10	10	10	10	10	10	10
Aydınman	54	36	36	37	36	36	36	31
Afyonkarahisar	33	35	35	35	32	35	35	34
Ağrı	71	70	70	70	70	70	70	70
Aksaray	23	26	27	27	26	27	27	30
Amasya	48	54	55	55	54	55	55	59
Ankara	5	6	6	6	6	6	6	6
Antalya	6	7	7	7	7	7	7	7
Ardahan	81	81	81	81	81	81	81	81
Artvin	62	68	68	68	68	68	68	71
Avdın	26	23	23	23	24	23	23	22
Balıkesir	15	15	15	15	15	15	15	18
Bartın	61	64	64	64	64	64	64	64
Batman	49	32	31	32	35	31	31	23
Bayburt	75	78	78	78	78	78	78	78
Bilecik	22	25	24	24	22	24	24	24
Bingöl	58	52	57	57	51	57	57	53
Bitlis	72	62	61	61	62	61	61	56
Bolu	40	45	45	45	46	45	45	44
Burdur	55	58	56	56	58	56	56	58
Bursa	2	2	2	2	2	2	2	4
Çanakkale	28	29	32	31	27	32	32	36
Çankırı	38	43	43	43	41	43	43	43
Çorum	53	51	51	51	52	51	51	52
Denizli	21	20	19	19	20	19	19	20
Diyarbakır	30	21	21	21	30	21	21	14
Düzce	20	24	25	25	21	25	25	28
Edirne	56	60	60	60	60	60	60	63
Elazığ	32	37	37	37	36	37	37	38
Erzincan	47	46	49	49	45	49	49	45
Erzurum	70	55	53	53	56	53	53	50
Eskişehir	14	14	14	14	14	14	14	19
Gaziantep	11	11	11	11	14	11	11	11
Giresun	59	61	62	62	61	62	62	62
Gümüşhane	78	77	77	77	77	77	77	77
Hakkâri	79	79	79	79	79	79	79	79
Hatay	17	22	22	22	17	22	22	26
Iğdır	74	76	76	76	76	76	76	76
Isparta	46	47	46	46	47	46	46	49
İstanbul	1	1	1	1	1	1	1	1
İzmir	3	4	4	4	4	4	4	5
Kağırmanmaras	24	18	18	18	23	18	18	16
Karabük	77	75	75	75	75	75	75	74
Karaman	36	41	42	42	40	42	42	46
Kars	64	69	69	69	69	69	69	72
Kastamonu	52	57	54	54	57	54	54	55
Kayseri	16	16	16	16	16	16	16	17
Kırkkale	66	66	65	65	66	65	65	65
Kırklareli	25	27	26	26	25	26	26	29
Kırşehir	63	65	66	66	65	66	66	66
Kilis	60	67	67	67	67	67	67	68
Kocaeli	4	3	3	3	3	3	3	3
Konya	13	12	12	12	13	12	12	12
Kütahya	31	33	34	34	33	34	34	32
Malatya	37	31	29	29	31	29	29	27
Manisa	9	9	9	9	9	9	9	9
Mardin	41	34	33	33	34	33	33	25
Mersin	8	5	5	5	5	5	5	2
Muğla	18	19	20	20	18	20	20	21
Muş	76	74	74	73	74	73	73	67
Nevşehir	67	59	59	59	59	59	59	57
Niğde	35	38	38	38	38	38	38	39
Odu	45	48	47	47	48	47	47	48
Osmaniye	44	49	48	48	49	48	48	51
Rize	68	73	73	74	73	74	74	75
Sakarya	12	13	13	13	11	13	13	13
Samsun	29	30	30	30	29	30	30	35
Siirt	73	71	71	71	71	71	71	69
Sinop	69	72	72	72	72	72	72	73
Sivas	39	42	41	41	43	41	41	40
Sanlıurfa	19	17	17	17	19	17	17	15
Sirnak	65	63	63	63	63	63	63	61
Tekirdağ	7	8	8	8	8	8	8	8
Tokat	57	50	50	50	50	50	50	47
Trabzon	50	53	52	52	53	52	52	54
Tunceli	80	80	80	80	80	80	80	80
Uşak	34	39	39	39	39	39	39	41
Van	43	40	40	40	42	40	40	37
Yalova	27	28	28	28	28	28	28	33
Yozgat	51	56	58	58	55	58	58	60
Zonguldak	42	44	44	44	44	44	44	42

Household Water Consumption and Tariff Structure: The Analysis of Türkiye's Three Metropolitan Cities

Mahmut Akif GÜVEN (<https://orcid.org/0009-0009-2010-9736>), Hacettepe University, Türkiye;
mahmutakif.guven@hacettepe.edu.tr

Alparslan Abdurrahman BAŞARAN (<https://orcid.org/0000-0003-1027-8375>), Hacettepe University, Türkiye;
aab@hacettepe.edu.tr

Hanehalkı Su Tüketimi ve Tarife Yapısı: Türkiye'de Üç Büyükşehir Üzerine Bir Analizi

Abstract

Analysis of urban water management has been researched in several countries. However, the attention given to this subject in Türkiye remains limited. This study addresses this research gap by focusing on the analysis of water tariffs, a critical tool for urban water management policies of local governments in Türkiye. The research aim is to investigate issues related to the attributes widely studied globally when the Türkiye case is considered. The study utilises a dataset from the Household Budget Survey of the Turkish Statistical Institute (TÜİK) between 2015 and 2018. The research has two folds. First, household water tariffs, average water prices, water consumption levels, and household characteristics are comprehensively examined in three metropolitan cities of Türkiye, namely, İstanbul, Ankara, and İzmir. Secondly, water consumption data is compiled from diverse geographical regions worldwide and compared with the ones in Türkiye. The findings reveal that the accessibility to clean water and the financial burden of clean water on household budgets, particularly for low-income households in Türkiye, are notably disadvantaged compared to many developed countries.

Keywords : Household, Water Utilities, Water Tariff, Local Government Policy.

JEL Classification Codes : H31, L95, L98.

Öz

Kentsel su yönetimi analizleri birçok ülkede araştırma konusu olmuştur. Ancak Türkiye'de bu konuya olan ilgi sınırlı düzeydedir. Bu çalışma, Türkiye'deki yerel yönetimlerin kentsel su yönetimi politikaları açısından kritik bir araç olan su tarifelerinin analizine odaklanarak ilgili araştırma açığını ele almaktadır. Araştırmanın amacı, dünya genelinde yaygın olarak konu ile ilgili incelenen sorunları, Türkiye örneği çerçevesinde incelemektir. Çalışma, Türkiye İstatistik Kurumu (TÜİK) Hanehalkı Bütçe Araştırması 2015-2018 veri setini kullanmaktadır. Araştırma iki aşamadan oluşmaktadır. İlk olarak, hanehalkı su tarifeleri, ortalama su fiyatları, su tüketim düzeyleri ve hanehalkı özellikleri Türkiye'nin üç büyükşehri olan İstanbul, Ankara ve İzmir için ayrıntılı bir şekilde incelenmiştir. Ardından, dünya genelinde farklı coğrafi bölgelerden derlenen su tüketim verileri ile Türkiye bulguları kıyaslanmaktadır. Bulgular, Türkiye'de özellikle düşük gelirli haneler için temiz suya erişimin ve temiz suyun hanehalkı bütçesi üzerindeki mali yükünün birçok gelişmiş ülkeye kıyasla oldukça dezavantajlı olduğunu göstermektedir.

Anahtar Sözcükler : Hanehalkı, Su Hizmetleri, Su Tarifeleri, Yerel Yönetim Politikaları.

1. Introduction

Due to socio-economic changes experienced in the past 30-40 years, globally intensifying wide-spread droughts, and increasing environmental concerns, issues such as the sustainability of water resources and enhancing the service capacities of water institutions have gained increasing interest in the economic literature (Sebri, 2013; Parker & Wilby, 2013). Population growth, industrial development, and urbanisation have led to a substantial increase in water demand. Consequently, ensuring water supply, improving efficiency, and managing water demand have become increasingly important not only for governments and policymakers but also for all stakeholders in Türkiye, as is the case worldwide.

The water industry has distinct characteristics that set it apart from others. Due to municipalities' general establishment and operation of water networks as a public service monopoly, the water industry appears as a collection of 'local monopolies' (Armstrong et al., 1994). Furthermore, the involvement of elected local governments and key actors in water management distinguishes the water industry from other network industries. With these exceptional attributes, water management represents a comprehensive and inherently multi-stakeholder structure that encompasses the development of clean water sources, regulations governing water allocation, pricing arrangements, and the conservation of water resources. In other words, delivering water to the end consumer involves a complex decision-making process encompassing all political, financial, economic, social, and technical aspects.

In the context of water management, the tariff structure, which is the focus of the research, is seen as an important policy tool. Indeed, the local governing body decides on the form of these tariffs (increasing block rates, flat fees, or decreasing block rates), assuming that the decisions are based on prioritised policies. The prioritised policies generally encompass environmental and financial sustainability, economic efficiency, and policies that consider the equitable distribution of water and social justice in access to water (Pinto et al., 2015).

Although the issue of water management is gaining popularity worldwide, water supply security remains a fundamental concern in many developing and underdeveloped countries. Water supply security is the capacity to provide a standard flow of drinking water at a specific quality and pressure, at an acceptable price, under certain conditions, and at any given time (GWP, 2000). However, the water supply provided by local governments must also meet drinking water quality standards to protect public health and prevent water-related diseases (İçme Suyu Kalitesi Yönetmeliği, 2019).

This research examines monthly household water consumption levels, real changes in water prices, and the share of household budgets allocated to water consumption for the three largest metropolitan municipalities in Türkiye, namely, İstanbul, Ankara, and İzmir. The analysis considers the respective municipalities' household income levels,

characteristics, and residential water tariff structures between 2015 and 2018. This research also compares the findings of similar studies in the literature. To achieve this, the literature on water demand and management is first reviewed, highlighting the factors that affect water consumption. The following section provides detailed findings on the components of household-level water consumption based on practices in different countries worldwide. Using data obtained from household budget surveys conducted by the Turkish Statistical Institute (TURKSTAT) for 2015-2018, the water consumption of households in the three metropolitan areas of Türkiye was analysed by income group and compared with findings from other countries. The final section presents comparative findings on household water consumption and offers policy recommendations for water management.

2. Literature Review

In particular, since the second half of the 20th century, population growth, declining freshwater supply, and increasing infrastructure costs have compelled suppliers to redesign demand management through pricing structures and other strategies such as public awareness and consumption restrictions. Worthington and Hoffman (2008) emphasise the lack of consensus among studies on demand management outcomes. Nevertheless, there has been a significant increase in academic research on household water consumption and tariff structures over the past two decades. The growing population and expanding cities are the primary drivers of this trend. Within this context, price and non-price factors emerge as the most important variables in studies examining water consumption and management in the relevant literature.

2.1. Pricing

The main determinants of household water consumption are price, income, and household characteristics (Arbués et al., 2003). Water tariffs serve as the fundamental instrument of demand-oriented policy design. Urban water tariffs consist of separate prices for households, the industrial and service sectors, public sector subscribers, and disadvantaged segments. Considering water scarcity and value as limited resources, pricing considers demand management as well as the sustainability of the service. Over time, different approaches have emerged and been implemented to create water tariffs.

The World Bank (2003) discussed two primary justifications for supplying water at a specific price: restricting water consumption and generating income for operational and infrastructure investments. Consequently, water can be regarded as an economic good, and excessive consumption can be prevented (The Dublin Statement and Report of the Conference, 1992). Price policies are expected to serve the objectives of water organisations. Price policies aim to ensure access to clean water resources through affordable tariffs for all income groups.

If the water price is utilised as a policy tool, it can enable more efficient use of water resources, promote sustainability, and ensure a fairer distribution of water supply costs

(Barberán et al., 2022). Additionally, the price must serve as an effective instrument for generating revenue capacity, economic efficiency, environmental sustainability, and affordability principles to sustain the services of water organisations (Gam & Rejeb, 2021; Meran et al., 2021). However, developing a price policy aligning with these trade-off objectives is quite complex. Because efficiency often conflicts with accessibility and affordability, and income generation often conflicts with the equitable and fair distribution of water (Meran et al., 2021), implementing a rational decision-making process to achieve these goals can be quite challenging.

Policymakers aiming for equitable and fair water distribution tend to sell essential goods such as water below the cost (Depoorter, 1999). However, this situation contradicts full-cost pricing, which entails allocating all water service costs to those who consume and pollute water to ensure the continuity of maintenance, repairs, operations, and investment expenses of water organisations (Massarutto, 2007; Zetland & Gasson, 2013). Implementation of the full-cost rule is more feasible in developed countries. For instance, while Germany applies full-cost pricing to 99% and Austria to 93% of their water services (Reynaud et al., 2015), a similar practice in developing countries, such as Jordan, could further complicate the issue for low-income groups facing difficulties in accessing clean water (Klassert et al., 2018). In developing countries, the full-cost rule can be adopted through cross-subsidy practices that involve financing the difference between the price applied to low-income consumers and the cost of the water supply by higher-income individuals (Depoorter, 1999). Full-cost pricing can become an applicable method for developing countries when water tariffs are designed to encompass cross-subsidies.

In the urban water supply industry, high fixed costs result in average costs exceeding marginal costs, leading to the consideration of the urban water sector as a natural monopoly (Massarutto, 2007; Meran et al., 2021). While achieving economic efficiency is possible through marginal cost pricing in perfect competition (Viscusi et al., 2018), implementing marginal cost pricing in the urban water industry would lead to revenue loss for service-providing institutions. The assumption that consumers have complete information about the structure of water tariffs suggests using marginal pricing (Borenstein, 2009). However, Binet et al. (2014) and Barberán et al. (2022) argue that consumers have incomplete information about water tariffs; however, with increased awareness levels, marginal pricing can be effectively utilised in water pricing. Gaudin (2006) demonstrates through his study in the United States that informing consumers about the structure of water tariffs can increase the price elasticity of demand by 30-40%. On the other hand, due to incomplete information, there is a consensus that consumers are more sensitive to average prices than marginal prices (Gaudin, 2006; Grafton et al., 2011; Wichman, 2014; Clarke et al., 2017; Marzano et al., 2018; Tortajada et al., 2019; Puri & Maas, 2020). Therefore, considering Armstrong's (1994) characterisation of local monopolies in urban water supply, average cost pricing is the optimal method in terms of the effectiveness of price policy.

Furthermore, there is a consensus in the literature that price, which serves as a deterrent to promote water conservation, should be utilised as an important tool to achieve

one of the fundamental objectives of water utilities (Dalhusien et al., 2003; Nauges & Thomas, 2003; Arbues et al., 2004). Indeed, Timmins (2003), investigating the combined effect of pricing and non-price strategies in discouraging water consumption, found that a regulation increasing water prices resulted in a more significant reduction in water consumption compared to a policy that mandates the use of low-flow meters. Aubuchon and Roberson (2012) also analysed the United States' water consumption reduction through price and non-price variables. They concluded that non-price variables have a limited impact on water demand management. In summary, this approach considers price and tariff structure as fundamental instruments in managing water demand while predicting that the influence of non-price factors will be limited.

However, Martínez-Espiñeira (2003) found that the impact of increasing block tariffs or changing the price within tariff blocks on water conservation was lower than expected. Generally, households in higher-income groups, particularly those residing in houses with swimming pools or gardens, are less responsive to price increases when promoting water conservation. In other words, relying solely on increasing the progressive nature of water tariffs to encourage water savings without resorting to extraordinary price hikes is not an effective policy approach to incentivise water conservation among middle-to-upper-income households (Tortajada et al., 2019). These findings lead to a discussion of whether non-price factors in water management can serve as useful policy options.

2.2. Non-Price Strategies

Although increasing household water prices is considered a means to reduce demand, some views suggest that the price elasticity of water demand is insignificant, particularly among high-income households, thus asserting that price is an ineffective tool for regulating demand and consumption (Wichman et al., 2014). From this perspective, non-price strategies aimed at reducing water consumption are considered important factors for policymakers when developing policies related to water consumption (Wichman et al., 2016). Indeed, studies supporting this viewpoint suggest that awareness campaigns targeting the public, as well as programs that restrict water usage and incorporate more efficient technological innovations, can yield more successful results in reducing water consumption (Kenney et al., 2008; Grafton et al., 2011; Tortajada et al., 2019).

The main theme of urban water conservation programs is based on directing demand-oriented tendencies by raising public awareness and providing discounts and incentives to certain disadvantaged groups (Diamond et al., 2000). Grafton et al. (2011) argue that while water-saving devices and household characteristics statistically do not have a significant impact on reducing water consumption, behavioural tendencies and environmental concerns can be used as alternatives to price policies. However, Mayer et al. (1999) and Deoreo et al. (2016) emphasise in their studies conducted in the United States that environmental concerns and water-saving devices effectively reduce water consumption. Deoreo et al. (2016) also stated that a decrease in household size reduces water consumption. Tortajada et al. (2019) demonstrate that behavioural effects, education, awareness campaigns, and increased use of

household water-saving devices are more effective in reducing water consumption in Spain's five major regions.

Restricting outdoor water consumption has a stronger impact on reducing water demand in high-income households, which usually own larger plots of land (Renwick & Green, 2000). However, Kenney et al. (2008) state that when considering the consumer profiles of different income groups before and after drought periods, price-based policies that restrict water consumption and policies that increase prices interact with each other, and the total water savings are not simply the sum of each policy working independently. In other words, it has been found that pricing policies are effective in the long term for households that consume a large amount of water, while restrictions are effective in coping with problems such as drought in the short term (Kenney et al., 2008). Policymakers aim to achieve overlapping goals, such as efficiency and conservation measures, within the framework of these programs. Further research is needed to determine the interactions of simultaneous policies and programs implemented to reduce water demand during peak and drought periods to understand how they affect the overall reduction of water demand (Renwick & Green, 2000).

3. Water Consumption in the World

Explaining the issue of water consumption and pricing, which is the focus of this study, with examples from around the world and comparing it with the current situations in Türkiye (based on three metropolitan cities) is important for understanding how the subject has been shaped. The findings compiled from academic studies on residential water consumption based on different geographical locations are summarised in Table 1. Table 1 provides information on the daily per capita water consumption of households, the average price of water in cubic meters, the size of residential area in square meters, the average number of people in households, and the ratio of water expenditure to household income in different countries, states, and cities.

Countries such as Canada, Australia, South Korea, and Italy have significantly higher per capita daily water consumption than others. These countries' per capita daily water consumption levels were 535, 411, 379 and 356 litres, respectively. On the other hand, Belgium, Jordan, Germany, Norway, and France are countries with the lowest per capita water consumption. Per capita water consumption in Canada was approximately six times higher than that in Belgium. Various explanations have been proposed for such significant variations in water consumption levels worldwide (Domene & Sauri, 2006; Grafton et al., 2011; Reynaud et al., 2015). Factors such as water prices, tariff structures, climate, behavioural effects, education and income levels, and household characteristics are the main drivers in this context (Mayer et al., 1999; Domene & Sauri, 2006; Grafton et al., 2011; Reynaud et al., 2015; Tortajada et al., 2019; Rondiel & Sarmiento, 2020).

Reynaud et al. (2015), in their analysis of 28 EU countries (not all included in this study), found that predominantly southern European countries such as Greece, Cyprus, Italy,

Portugal, and Sweden had an average daily per capita water consumption of more than 164 litres. In contrast, Eastern European countries such as Bulgaria, the Czech Republic, Estonia, Norway, Lithuania, Poland, and Slovakia had an average daily per capita water consumption of fewer than 110 litres. Among the countries with the highest water consumption, the price of a unit cubic meter of water was 0.72€ in Cyprus, while in Belgium and Germany, countries with the lowest water consumption, the price of a unit cubic meter of water was 3.7€ and 3.9€ respectively. This study suggests that the variation in water prices among EU countries can be attributed to differences in water supply costs in each country. However, other significant factors include the implementation of cross-price subsidies among consumers, the failure of every country to adopt full-cost pricing, and the lack of a competitive structure in the water industry (Reynaud et al., 2015).

Grafton et al. (2011) analysed the 10 OECD countries, considering explanatory variables such as average price, household characteristics, water-saving devices, behavioural tendencies, and environmental concerns to explain the variations in residential water consumption. They found that the average price was the most influential variable in regulating water consumption. According to Tortajada et al. (2019), based on their studies conducted for Barcelona, Seville, Zaragoza, Malaga, and Madrid covering 2002 and 2016, water prices have increased over time, resulting in significant reductions in water consumption.

The assumptions regarding household characteristics as a determining factor for water consumption align with the findings presented in Table 1. Indeed, it was observed that less water is consumed in smaller houses measured in square meters where low-income households reside, while larger households with higher housing areas tend to consume more water. Studies conducted for Barcelona, Kentucky/Louisville, and Lima have demonstrated a positive correlation between housing size and water consumption (Domene & Sauri, 2006; Rockaway et al., 2011; Rondiel & Sarmiento, 2020).

Mayer et al. (1999) and (2016) analysed data from North America and found a 15% decrease in water consumption during the studied period. They attributed this decline to an increase in the usage of water-saving devices and a reduction in the average household size. Rockaway et al. (2011) conducted a regression analysis based on data from the U.S. The Census Bureau covering 1990-2007 found that household size positively affected daily water consumption, with an average increase of 20.4 litres per day (Rockaway et al., 2011).

Domene and Sauri's (2006) analysis of Barcelona, which examined the relationship between household characteristics, housing area, and water consumption, yielded similar results regarding these variables. In small-sized apartment units (measured in square meters), per capita water consumption was 120 litres, whereas, in relatively larger housing complexes with shared gardens or pools, it was 156 litres. In detached houses with the most significant housing areas and private gardens or pools, the per capita water consumption reached 203 litres. Domene and Sauri (2006) concluded that water consumption in high-income households, particularly those residing in detached houses, increased during summer due to

seasonal effects. Furthermore, they found a direct relationship between indoor water use in households, housing size, and the number of occupants, independent of income level.

Similar findings indicating an increase in water consumption associated with the type of dwelling occupied based on household income can also be observed in Canada, Australia, and the United States. Conversely, the average daily per capita water consumption in water-stressed Jordan is estimated to be 92 litres (Klassert et al., 2018). These figures demonstrate that an average Jordanian consumes only about 1/6 of the daily water consumption of an average Canadian. Moreover, it can be inferred that Jordan falls below the threshold of water poverty, as defined by the World Health Organization (2003), which states that a minimum of 100 litres per capita daily water consumption is necessary to meet basic human needs.

In the analysis conducted by Rondiel and Sarmiento (2020) for the capital city of Peru, Lima, it was observed that water consumption increases along with housing areas in regions ranked from low to high income. In this study conducted for three different local units of Lima, the daily per capita water consumption was determined as 112 litres in Villa El Salvador, which has a high concentration of low-income households; 158 litres in Brena, a region with moderate income levels, and 207 litres in San Isidro, a high-income area (Rondiel & Sarmiento, 2020). Gardens and pools in these residences contribute to increasing water consumption. As is evident from studies conducted in different regions of the world, an increase in income leads to a rise in housing areas and the number of occupants, resulting in higher water consumption.

Temperature and climate are important factors influencing water consumption. Mayer et al. (1999), Rockaway et al. (2011), and Deoreo et al. (2016) found a positive causal relationship between temperature and water consumption. Rockaway et al. (2011) concluded that the highest household water consumption occurs in California, where a hot climate prevails, while the lowest water consumption is observed in Alaska, which has a cold climate.

Finally, based on the findings in Table 1, it can be reported that the affordability criterion proposed by the UNDP (2006) states that water bills should not exceed 3% of household income, which is generally adhered to worldwide. However, when looking at the results obtained by Klassert et al. (2018), it is evident that households in Jordan grappling with water poverty issues have to bear a significantly higher water consumption cost than other countries. For the ten OECD countries, this ratio was calculated to be 0.875. Among these countries, households in the Czech Republic and Mexico bear a relatively high burden in terms of water expenses.

Table: 1
Water Consumption in the World

The Articles		Water Consumption (Person, Daily, Liter)	Average Unit Water Price	Residential Area (m ²)	Number of Occupants (Average)	Water Expenditure (Bill/Total Revenue) (%)
Reynaud et al. (2015)	England	147	1,9€			
	Germany	119	3,9€			
	Italy	183	1,4€			
	South Cyprus	246	0,72€			
	Belgium	87	3,7€			
Grafton et al. (10 OECD Countries) (2011)	Australia	411	1,170€	113	2,9	0,6
	Canada	535	1,391€	138	2,7	0,66
	Czech Republic	178	1,727€	97	3	1,74
	France	133	3,0€	109	2,6	0,9
	Italy	356	1,127€	112	3,1	0,78
	South Korea	379	0,522€	91	3,7	0,45
	Mexico	276	0,563€	114	3,7	1,4
	Holland	208	2,089€	96	2,2	0,71
	Norway	132	2,369€	152	2,8	0,51
	Sweden	236	2,588€	144	2,5	1
	OECD (10)	269	1,703€	110	2,9	0,875
Mayer et al. (1999)	Colorado, Oregon, Washington, California, Florida, Arizona, Ontario	262,3			2,77	
Klassert et al. (2018)	Jordan	92	0,32JOD ^a 0,37JOD ^b		5,6	2,99 ^a 2,01 ^b
Deoreo et al. (2016)	Washington, Colorado, Oregon, California, Florida, Arizona, Ontario, Alberta, Nevada, New Mexico, Texas, Georgia, North Carolina, Illinois, Pennsylvania, Connecticut	221,8			2,65	
Rockaway et al. (2011)	Louisville, Kentucky (1990-2007)	312-297		200-212	2,52-2,38	
Tortajada et al. (2019)	Barcelona (2002-2016)	355-283	1€ - 2,14€			1,49*
	Zaragoza (2002-2016)	362-266	0,75€ - 1,18€			0,76*
	Malaga (2002-2016)	358-308	0,78€ - 1,22€			0,92*
	Madrid (2002-2016)	478-357	0,95€ - 1,44€			0,76*
	Sevilla (2002-2016)	386-313	1€ - 1,77€			1,11*
Rondiel & Sarmiento (Lima) (2020)	Villa El Salvador	112	2,78PEN	m ² >100	4,7	
	Breña	158	2,78PEN	50< m ² m ² <100	4,3	
	San Isidro	207	4,08PEN	m ² >100	3,7	
Domene & Sauri (2006)	Barcelona (Apartment Home)	120,1	1,187€	85,6	2,7	0,64
	Barcelona (Site Home)	156,7	1,029€	109,6	3,2	0,55
	Barcelona (Detached Home)	203,3	1,085€	173,0	3,3	0,87
Ramulongo et al. (2017)	Makhado Newtown	225,13				

* We calculated it based on the data in the relevant study. (a) High-income households. (b) Low-income households.

4. Data and Methodology

The water administrations (İSKİ (İstanbul), ASKİ (Ankara), İZSU (İzmir)) in the three selected metropolitan cities are responsible for providing water services to 27.1% of the Turkish population. The data used in this study for İstanbul (TR10), Ankara (TR51), and İzmir (TR31), which are among the 26 sub-statistical regions (Level 2) according to the Statistical Regions Classification of Türkiye, were obtained from the Household Budget Survey conducted annually by the Turkish Statistical Institute (TURKSTAT) between 2015 and 2018. These surveys enable cross-sectional monitoring of changes in household consumption patterns over time. (TURKSTAT, 2020).

The findings of the conducted analysis using the Household Budget Survey data from TURKSTAT, specifically related to residential water consumption in İstanbul, Ankara, and İzmir, are summarised in the following section by presenting separate tables for each city. These tables include the monthly water consumption quantities of households in terms of income groups ' $Q(m^3)$ ', water prices ' $WP(\text{₺})$ ', the ratio of water bills to household income ' $B/I(\%)$ ', the percentage change in real water prices ' $RWP(\%)$ ', number of occupants in the household ' NO ', and size of residential areas in square meters ' $RA(m^2)$ '.

A detailed analysis of household water consumption by income groups in Türkiye's top three largest metropolitan areas by population is the main focal point of this study. The aim is to examine how water prices differ regarding budgetary burdens for households in low- and high-income groups. In this regard, the real increase in water prices and changes in water tariff structures in the respective years were considered. Additionally, the causal relationship between the size of the occupied dwelling (m^2) and the number of individuals in the household and household water consumption, as discussed in the literature, will be examined to assess its validity in Türkiye.

In this context, using data obtained from the TURKSTAT Household Budget Surveys conducted for each year between 2015 and 2018 in İstanbul, Ankara, and İzmir, the sample was divided into income ranges (N/5), and the average water prices and monthly water consumption of households in each income range, the ratio of water bills to household income ' (B/I) ', real price changes ' (RPC) ', the number of household member ' $NoHM$ ', and the size of the residential areas ' (RA) ' were analysed. Thus, the financial burden households bear on access to clean water, the level of water consumption by households, and the factors influencing water consumption, which are essential for meeting basic human needs, can be examined. Finally, the daily average per capita water consumption in the three largest metropolitan areas of Türkiye is compared, considering the findings for other countries provided in Table 1.

5. Findings

One of the most significant factors influencing household water consumption is the tariff structure determined and implemented by local governments. Within the scope of the research, it was observed that the water tariff structures differ significantly from each other for the three major cities examined in the respective years. In İstanbul and İzmir, a progressive tariff structure is applied, in which the price increases gradually based on prespecified consumption levels. By contrast, Ankara applies a single-scale fixed tariff, where the same price is used for all consumption levels.

5.1. The Case of İstanbul

In İstanbul, a residential water tariff is applied in an increasing block-rate structure consisting of three scales in the respective years. Table 2 presents the water tariffs applied to the dwellings in İstanbul between 2015 and 2018. The first scale corresponds to

consumption ranging from 0 to 10 m³, the second encompasses consumption between 10 and 20 m³, and the third represents consumption exceeding 21 m³. Water prices determined by the İstanbul Water and Sewerage Administration (İSKİ) for each tariff range are applied (adjusted at the beginning of each month throughout the year due to inflationary conditions), and the rate of price increase between ranges is kept constant for all examined years.

Table: 2
İstanbul Dwelling Water Tariff (₺*)

İSKİ	2015	2016	2017	2018
1) 0-10m ³	4.21	4.36	4.79	5.13
2) 11-20m ³	6.12	6.37	7.01	7.51
3) 21-∞m ³	8.94	9.27	10.20	10.93

Source: İSKİ. * Unit m³ prices (Turkish Lira). * Wastewater cost is included in the prices.

However, based on data from TURKSTAT, the position of households in İstanbul within the increasing block rate structure, as shown in Table 2, according to their monthly water consumption, can be observed in Table 3. According to Table 3, households on the first scale with monthly water consumption of up to 10 m³ account for 34.75% of all households, representing 19% of the total water consumption and covering 16.5% of the total water bill. More than half of the households (54.6%) were billed within the first two scales for their monthly water consumption, accounting for 59% of the total water consumption and covering 56.9% of the total water bill. Finally, 10.6% of households had a monthly water consumption exceeding 20 m³, including the third scale. In this scale, households accounted for 21.9% of the total water consumption and covered 26.5% of the total water bill. Considering the tariff scale, households' average monthly water consumption levels are 6.63 m³, 13.07 m³, and 25 m³, respectively.

Table: 3
İstanbul Water Tariff Structure (2015-2018)

Tariff Scales	Average Consumption(m ³)	Total Consumption (%)	Total Water Payment (%)	Total Observation (%)
1) 0-10m ³	6.63	19.05	16.57	34.75
2) 11-20m ³	13.07	59.05	56.9	54.66
3) 21-∞m ³	25	21.9	26.53	10.59

* Prepared by TURKSTAT Household Budget Surveys data and İSKİ residential water tariffs.

The detailed findings regarding household water consumption in İstanbul are presented in Table 4. It is evident that, as income levels increase, households tend to have higher monthly water consumption, which conforms to the findings in the literature. In İstanbul, where an increasing block rate tariff is implemented, water prices (*P*) are expected to increase as consumption levels increase. However, despite high-income households having approximately 50% higher monthly water consumption than low-income households in 2015, the average water bill they pay is only 7% higher than that of low-income households.

On the other hand, over the years, there has been no significant change in the water consumption levels of low-income households, while a decreasing trend in the water consumption levels of high-income households can be observed. Based on the sample

averages, it can be stated that there is a decreasing trend in household water consumption (Q) in İstanbul over time. In 2015, an average of 12.54 m³ of water was consumed per household monthly, which decreased to 11.9 m³ per month in 2018, indicating a reduction in household water consumption by approximately 5.3%.

The "Bill/Income(B/I)" findings show a similar causality between income and water consumption increases. The proportion of high-income households' budget allocated to water bills was significantly lower than that of low-income households. In fact, in 2015, the share of water bills in the income of low-income households was about 3.6 times higher than that of the higher-income groups. Moreover, this ratio has increased, reaching approximately four times in 2018.

Additionally, Table 4 depicts that the ratio of water bills to household income in the lowest income group, indicated in the first row, remains above 3% in 2015, 2016, and 2017 but falls below the threshold of 3% set by the UNDP in 2018. The main reason for this positive downward trend can be found in the "Real Price Change (RPC)" column in the fourth column. Indeed, these findings show that water prices in İstanbul have decreased in real terms for all income groups. Considering the 2015 baseline, water prices in İstanbul decreased by 5.53%, 5.62%, and 8.54%, respectively. This explains the continued decline in the "Bill/Income" data.

The water bill shares of the household budget was an average of 1.82% in 2015, which decreased to 1.49% in 2018. However, this situation presents another problem. According to "Real Price Change" findings, this declining trend does not occur equally in every income group. Moreover, as income levels increase, the price decrease also increases. In other words, a decline in prices favours higher-income groups.

Furthermore, the size of the residential areas ($RA(m^2)$) and household size ($NoHM$) increased in parallel with the household water consumption. In fact, in the analysed years in İstanbul, with a few exceptions, it was observed that the number of household members and the size of the occupied dwelling increased along with household income level, and household water consumption levels positively correlated with these findings. These theoretical assumptions suggest that changes in household characteristics increase water consumption and can be considered applicable to İstanbul.

Table: 4
İstanbul Household Water Consumption Data (2015-2018)

İSTANBUL						
2015						
N/5	Q(m ³)	P(₺)	B/I(%)	RPC(%)	NoHM	RA(m ²)
1.	10.30	4.11	3.08	0	3.08	89.56
2.	11.31	4.15	2.04	0	3.54	96.95
3.	12.58	4.24	1.78	0	3.54	97.81
4.	13.33	4.30	1.37	0	3.99	105.88
5.	15.21	4.43	0.85	0	3.32	135.63
\bar{x}	12.54	4.24	1.82	0	3.49	105.14

2016						
N/5	Q(m ³)	P(₺)	B/I(%)	RPC(%)	NoHM	RA(m ²)
1.	10.55	4.31	3.28	-4.23	3.21	89.56
2.	10.94	4.30	2.00	-5.51	3.43	96.71
3.	12.64	4.42	1.79	-4.87	3.75	99.95
4.	12.00	4.39	1.19	-6.95	3.41	103.06
5.	14.12	4.56	0.86	-6.10	3.78	119.96
\bar{x}	12.05	4.39	1.82	-5.53	3.51	101.84
2017						
N/5	Q(m ³)	P(₺)	B/I(%)	RPC(%)	NoHM	RA(m ²)
1.	10.14	4.67	3.02	-5.08	3.07	87.00
2.	11.83	4.79	2.17	-3.59	3.44	93.90
3.	12.17	4.81	1.62	-5.38	3.64	97.66
4.	12.52	4.83	1.21	-6.22	3.55	104.02
5.	12.98	4.89	0.76	-7.85	3.56	119.40
\bar{x}	11.92	4.79	1.75	-5.62	3.45	100.38
2018						
N/5	Q(m ³)	P(₺)	B/I(%)	RPC(%)	NoHM	RA(m ²)
1.	10.18	4.99	2.54	-8.02	3.04	90.92
2.	11.28	5.07	1.79	-7.55	3.34	94.08
3.	11.50	5.08	1.36	-9.35	3.45	96.67
4.	13.03	5.23	1.14	-8.03	3.60	104.71
5.	13.54	5.28	0.62	-9.72	3.45	128.18
\bar{x}	11.90	5.13	1.49	-8.54	3.37	102.89

* Data used in this study were obtained from the Household Budget Survey conducted by the Turkish Statistical Institute (TURKSTAT). * Real price change was calculated using the Consumer Price Index (CPI). The base year for the calculations was 2015. * The notation "N/5" represents income groups, with "1" indicating the lowest income group and "5" indicating the highest income group. * The number of observations for each year is 1.318 - 1.402 - 1.436 - 1.444.

5.2. The Case of Ankara

In Ankara, during the years considered in this study, the residential water tariff was implemented using a single-block flat-rate structure, in which the same price was applied for all consumption levels. Table 5 provides information on the water tariff applied to residential properties by ASKİ (Ankara Water and Sewerage Administration) between 2015 and 2018. In a tariff structure similar to that in Ankara, where water prices are determined independently of consumption and are billed at the same rate for all consumption levels, water tariffs cannot be used as a policy tool to encourage households to save water.

Table: 5
Ankara Dwelling Water Tariff (₺*)

ASKİ	2015	2016	2017	2018
0- ∞ m ³	4.45	5.57	6.44	7.52

Source: ASKİ. * Unit m³ prices (Turkish Lira). * Wastewater cost is included in the prices.

The detailed findings regarding household water consumption (Q) in Ankara are presented in Table 6. As income levels increased in Ankara, per capita water consumption also increased. However, households in the upper-income group showed a decreasing trend in monthly water consumption during the observation period. In 2015, high-income households had an average monthly water consumption of 13.05 m³, which decreased to 11.51 m³ in 2018, indicating a 13% decline. Similarly, low-income households in the first group experienced an 11% decrease in the average monthly water consumption during the same period. Additionally, the sample means demonstrate a similar decline of approximately 8.7% in average monthly water consumption.

According to Table 6, another important aspect is that low-income households in Ankara fail to meet the affordability criterion set by the United Nations Development Programme (UNDP, 2006), suggesting that the share of water bills in household income should not exceed 3%. Findings from the "Bill/Income(B/I)" ratio, which indicates the burden of water bills on household budgets, reveal that in 2015, low-income households in Ankara allocated approximately four times more to monthly water consumption than high-income households. By 2018, this ratio had decreased to 3.2, reaching relatively lower levels.

When examining the findings of the "Price Change" variable, which indicates the real change in prices, it can be observed that water prices in Ankara have significantly increased over the years. These data are critical because the water prices in the other two major cities under study generally show a downward trend. According to ASKİ, compared to the base year of 2015, there has been a real increase in water prices of 5%, 11%, and 18% in 2016, 2017, and 2018, respectively. In contrast, it has been found the monthly average household water consumption (m³) decreased by 11% for low-income households and 13% for high-income households. This indicates that tariff structures and prices are significant policy tools for household water consumption, consistent with the literature.

Finally, in Ankara, household size (*NoHM*) and residential area (*RA(m2)*) increased in parallel with monthly average water consumption. Similar to İstanbul, it can be stated that there is a positive correlation between household characteristics and monthly average water consumption for different income groups.

Table: 6
Ankara Household Water Consumption Data (2015-2018)

ANKARA						
2015						
N/5	Q(m ³)	P(₺)	B/I(%)	RPC(%)	NoHM	RA(m ²)
1.	9.45	4.45	3.93	0	2.75	87.68
2.	9.39	4.45	2.16	0	3.13	99.79
3.	10.65	4.45	1.77	0	3.53	105.05
4.	11.07	4.45	1.37	0	3.37	105.83
5.	13.05	4.45	0.96	0	3.62	121.70
\bar{x}	10.71	4.45	2.03	0	3.27	103.98
2016						
N/5	Q(m ³)	P(₺)	B/I(%)	RPC(%)	NoHM	RA(m ²)
1.	8.99	5.16	3.65	5.82	2.78	93.42
2.	9.65	5.16	2.10	5.82	3.19	99.32
3.	10.28	5.16	1.62	5.82	3.43	101.23
4.	11.67	5.16	1.35	5.82	3.55	109.07
5.	13.35	5.16	0.93	5.82	3.40	131.62
\bar{x}	10.78	5.16	1.93	5.82	3.27	106.9

2017						
N/5	Q(m ³)	P(₺)	B/I(%)	RPC(%)	NoHM	RA(m ²)
1.	8.58	5.96	3.33	11.91	2.61	97.70
2.	9.08	5.96	2.12	11.91	3.13	104.08
3.	10.57	5.96	1.87	11.91	3.42	106.09
4.	11.37	5.96	1.51	11.91	3.59	109.41
5.	12.61	5.96	1.03	11.91	3.71	121.17
\bar{x}	10.44	5.96	1.97	11.91	3.29	107.67
2018						
N/5	Q(m ³)	P(₺)	B/I(%)	RPC(%)	NoHM	RA(m ²)
1.	8.46	6.96	2.95	18.43	3.04	102.35
2.	9.56	6.96	2.15	18.43	3.14	106.05
3.	9.44	6.96	1.59	18.43	3.37	109.23
4.	10.30	6.96	1.30	18.43	3.41	114.87
5.	11.51	6.96	0.91	18.43	3.35	126.32
\bar{x}	9.85	6.96	1.78	18.43	3.26	111.75

* Data used in this study were obtained from the Household Budget Survey conducted by the Turkish Statistical Institute (TURKSTAT). * Real price change was calculated using the Consumer Price Index (CPI). The base year for the calculations was 2015. * The notation "N/5" represents income groups, with "1" indicating the lowest income group and "5" indicating the highest income group. * The number of observations for each year is 798 - 784 - 822 - 772.

5.3. The Case of İzmir

In İzmir, the residential water tariff was applied in an increasing rate structure consisting of two blocks during the analysed years. The first block includes consumption up to 20 m³, whereas the second block consists of consumption exceeding 21 m³. At the beginning of each year (often multiple times due to inflationary conditions), the water prices determined by İZSU are applied for each tariff block.

Table: 7
İzmir Dwelling Water Tariff (₺*)

İZSU	2015	2016	2017	2018
1) 0-20m ³	3.7	3.89	4.38	5.07
2) 21-∞m ³	8.67	9.12	10.02	11.30

Source: İZSU. * Unit m³ prices (Turkish Lira). * Wastewater cost is included in the prices.

Based on the data from TURKSTAT, the combined data for 2015, 2016, 2017, and 2018 were used to determine the placement of households in İzmir within the increasing rate structure of the water tariff based on their monthly water consumption. This information is presented in Table 8. According to Table 8, in İzmir, households in the first block, with monthly water consumption of up to 20 m³, accounted for 84% of all households. These households contribute 71% of the total water consumption and cover 67% of the total water bill. On the other hand, 16% of households exceeded the 20 m³ threshold and were billed under the second block. These households represent 29% of the total water consumption and cover 32% of the total water bills. The average monthly water consumption levels for households in each tariff block are 10.79 m³ and 23.11 m³, respectively.

Table: 8
İzmir Water Tariff Structure (2015-2018)

Tariff Scales	Average Consumption(m ³)	Total Consumption (%)	Total Water Payment (%)	Total Observation (%)
1) 0-10m ³	10.79	70.95	67.35	83.94
2) 21-∞m ³	23.11	29.05	32.65	16.06

* Prepared by TURKSTAT Household Budget Surveys data and İZSU residential water tariffs.

Table 8 indicates that the water tariff for residential properties in İzmir during the analysed period had a wide range within the blocks, suggesting the existence of an increasing rate tariff structure. However, a closer examination reveals that most households (84%) are subject to the same price, similar to the tariff structure in Ankara. An increasing tariff rate is apparent due to adopting a wide consumption range (0-20 m³) for the first block. As a result, only 16% of households are subject to an increasing tariff rate, undermining the effectiveness of the water tariff as a policy tool.

Table 8 indicates that, with a few exceptions, there were no significant changes in households' average monthly water consumption during the analysed years, similar to the patterns observed in İstanbul and Ankara. Furthermore, owing to the structure of the applied water tariff in İzmir during the relevant years, there is little variation in water prices among income groups, with low-income and high-income households subjected to nearly the same prices. However, in 2015, it was estimated that high-income households consumed approximately 30% more water on average than low-income households. By 2018, this gap was reduced to 16%, suggesting that additional consumption did not create an additional financial burden due to the adopted tariff structure, as indicated in the "Price (P)" column. According to the sample averages, there has not been a significant change in households' average monthly water consumption (Q) over the years.

Considering the UNDP's affordability criterion, the findings in Table 9 indicate that households in the low-income group, as presented in the first row, face the most disadvantageous budget burden (*B/I*) in terms of water consumption compared to İstanbul and Ankara. Additionally, when analysing the "Real Price Change (*RPC*)" data based on the year 2015, it is observed that water prices in İzmir show a downward trend in real terms. However, this trend appears to be unfavourable for low-income households. The price change for low-income households in 2016 was calculated to be -3.6%, while for high-income households, it was -5.94%. In 2018, water prices increased by 4.06% for low-income households and 0.68 for high-income households. These findings indicate that the current structure of the applied water tariff has a biased trend toward low-income households.

On the other hand, household size (*NoHM*) and residential area (*RA*) tended to increase with income level, indirectly explaining the increase in water consumption. These factors contribute to the rise in water consumption, which aligns with assumptions in the theoretical literature (Domene & Sauri, 2006; Grafton et al., 2011; Rondiel & Sarmiento, 2020). These observations hold for the three metropolitan cities analysed.

Table: 9
İzmir Household Water Consumption Data (2015-2018)

İZMİR						
2015						
N/5	Q(m ³)	P(t)	B/I(%)	RPC(%)	NoHM	RA(m ²)
1.	10.69	3.48	3.58	0	2.41	91.68
2.	12.32	3.49	2.28	0	2.95	101.11
3.	12.86	3.50	1.74	0	2.97	107.04
4.	13.29	3.53	1.34	0	3.17	114.20
5.	13.88	3.54	0.81	0	3.11	127.39
\bar{x}	12.6	3.51	1.95	0	2.92	108.26
2016						
N/5	Q(m ³)	P(t)	B/I(%)	RPC(%)	NoHM	RA(m ²)
1.	12.49	3.68	4.23	-3.60	2.41	84.71
2.	12.33	3.65	2.33	-4.61	3.00	92.64
3.	12.55	3.67	1.74	-4.33	3.01	99.00
4.	13.01	3.67	1.32	-5.12	3.23	106.55
5.	13.60	3.65	0.82	-5.94	3.13	115.90
\bar{x}	12.79	3.66	2.09	-4.72	2.95	99.74
2017						
N/5	Q(m ³)	P(t)	B/I(%)	RPC(%)	NoHM	RA(m ²)
1.	11.21	4.13	3.55	-0.88	2.20	84.25
2.	12.64	4.17	2.40	-0.30	2.94	98.37
3.	13.21	4.15	1.77	-1.01	3.00	101.62
4.	13.95	4.21	1.42	-0.41	3.15	105.45
5.	13.55	4.17	0.88	-1.76	3.33	113.69
\bar{x}	12.91	4.16	2	-0.87	2.92	100.65
2018						
N/5	Q(m ³)	P(t)	B/I(%)	RPC(%)	NoHM	RA(m ²)
1.	11.34	4.78	4.29	4.06	2.64	77.85
2.	12.81	4.77	2.50	3.32	3.00	93.42
3.	12.01	4.70	1.59	1.53	3.03	96.92
4.	14.55	4.86	1.48	4.24	3.37	108.42
5.	13.17	4.71	0.73	0.68	3.20	126.01
\bar{x}	12.77	4.76	2.12	2.77	3.04	100.5

* Data used in this study were obtained from the Household Budget Survey conducted by the Turkish Statistical Institute (TURKSTAT). * Real price change was calculated using the Consumer Price Index (CPI). The base year for the calculations was 2015. * The notation "N/5" represents income groups, with "1" indicating the lowest income group and "5" indicating the highest income group. * The number of observations for each year is 752 - 776 - 819 - 767.

5.4. Comparison of Water Consumption in Türkiye and the World

The comparative results of the average per capita daily water consumption quantities for İstanbul, Ankara, and İzmir were analysed within the scope of the study, along with the summarised findings of global studies presented in Table 1, shown in Figure 1. During the relevant period, the daily per capita average water consumption in İstanbul was 134.67 litres; in Ankara, it was 119.43 litres; and in İzmir, it was 167.32 litres.

Regarding water consumption levels, İstanbul, Ankara, and İzmir are similar to countries such as the United Kingdom, Germany, France, Italy, Norway, and Peru. Jordan and Belgium had the lowest water consumption, while Canada, Australia, South Korea, Spain (Madrid), the United States (Kentucky), Mexico, and Northern Cyprus had the highest daily water consumption. Factors such as water price, water supply capacity, household characteristics, housing type, behavioural effects, climate, and temperature can be considered the most significant factors explaining the differences in water consumption. In

Turkey, specifically for the three metropolitan cities, it can be stated that the average per capita daily water consumption is close to the average water consumption of European countries, with certain exceptions.

Figure: 1
Comparison of Water Consumption in Türkiye and the World

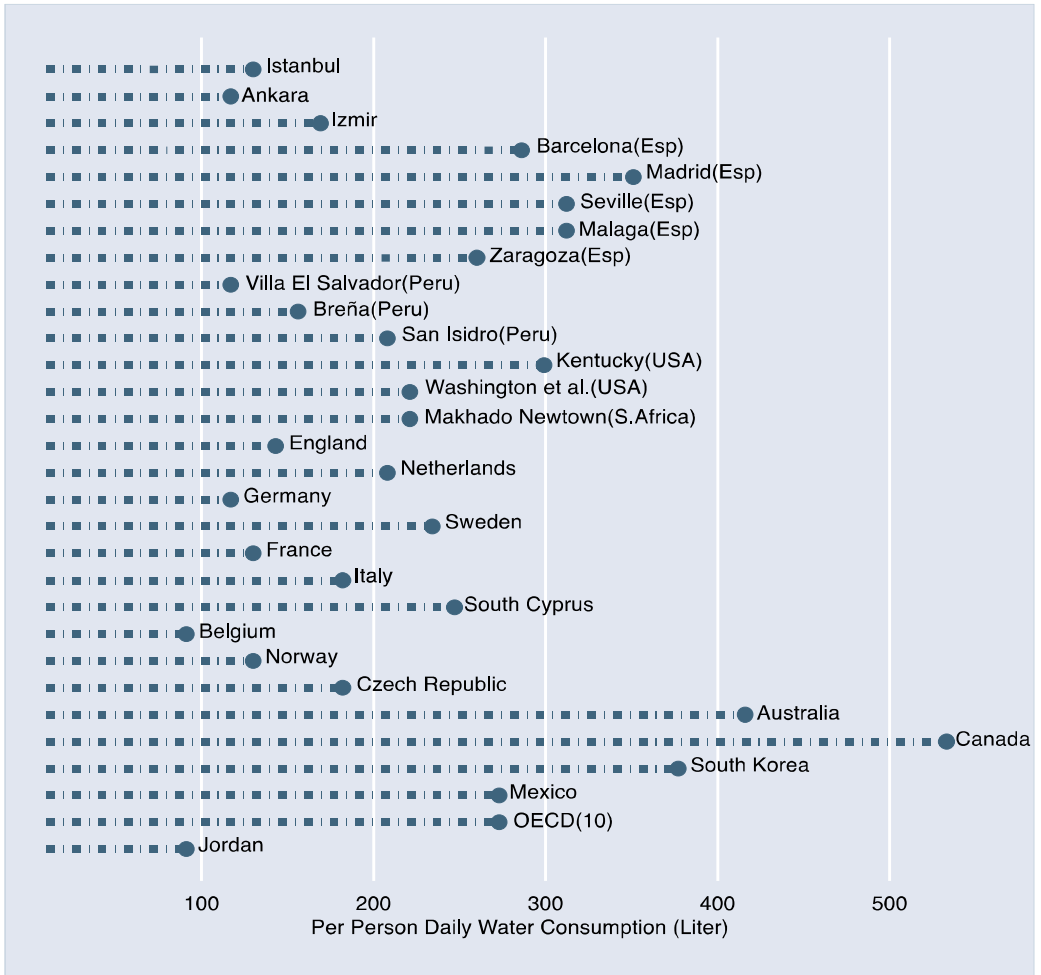

* Reynaud et al. (2015) was chosen as a reference for Italy because of its more recent publication date.

6. Conclusion and Assessment

Within the scope of the research, household water tariffs in the three largest cities in Türkiye between 2015 and 2018 were implemented with different structures. İstanbul

applies a progressive tariff consisting of three blocks, Ankara employs a single flat-rate tariff without blocks, and İzmir utilises a relatively progressive tariff with two blocks. Ankara is the city where water is the most expensive for households and where the least water consumption occurs, whereas İzmir is the city where water is the cheapest and where the highest residential water consumption takes place. When considering the burden of water consumption on household budgets and the real changes in water prices, the tariff structure implemented in İstanbul results in a more equitable and fair distribution compared with Ankara and İzmir.

Indeed, during the examined period in İstanbul, while water prices decreased in real terms, households' average monthly water consumption decreased. In Ankara, water prices have increased in real terms over the years, leading to a significant reduction in average monthly water consumption by households. In İzmir, no significant change was observed in either water price or households' average monthly water consumption during the relevant period. Based on this, it can be stated that the tariff structure in İstanbul and prices in Ankara are used as policy instruments to promote water conservation.

As expected, household-level monthly water consumption (m^3) in all three major cities increased with household income throughout the study period. However, the size of the residential area (m^2) in which higher-income households reside also increases, which is considered another factor explaining the increase in household water consumption. Similar trends were observed in the number of household members. Studies in the global context presented in Table 1 also support this assertion.

Additionally, within the scope of the research, water price changes have been adjusted for inflation, and it has been observed that these changes vary across cities. It is evident that realised water prices decreased for all income groups in İstanbul, remained constant for all consumers in Ankara during this period, and showed a continuous increase, disadvantageous for low-income households in İzmir. It should be emphasised that metropolitan municipalities affect water distribution when determining water prices. Furthermore, disclosure of the cost recovery ratio of these prices to the public is another important finding.

The per capita daily water consumption data indicate that water consumption in İstanbul (134 litres) and Ankara (119 litres) is similar to that of England (147 litres), Germany (119 litres), and France (133 litres), while İzmir's (167 litres) water consumption is close to that of the Mediterranean country, Italy (183 litres). Based on 2015 data, the price per cubic meter of water is 1.4€ in İstanbul, 1.47€ in Ankara, and 1.16€ in İzmir. Water prices for England, Germany, France, and Italy are 1.9 - 3.9 - 3 and 1.4, respectively (Grafton et al., 2011; Reynaud et al., 2015). According to these figures, the water prices in Türkiye's three major cities are similar to Italy's nominal value without considering purchasing power parity. The average water price per cubic meter in the OECD countries is 1.7€ (Grafton et al., 2011).

Based on the research findings, another critical aspect that needs to be emphasised is ensuring the basic human right to access clean water. It is evident that in Ankara and İzmir, the water consumption of low-income households exceeds the affordability principle envisaged by the UNDP, whereas in İstanbul, there has been some progress due to the decrease in real water prices. Developing policies that align with the "right to water" concept to which the United Nations attaches great importance, particularly for low-income households in the three major cities, is another noteworthy recommendation.

In the literature, expanding a set of policy priorities that aim to provide advantageous water tariffs to specific segments of society, commonly called "social tariffs", is crucial to making access to clean water affordable for low-income individuals and removing it from being considered a luxury. The fact that low-income households allocate more than 3% of their budgets to water consumption according to the affordability criteria of the UNDP indicates that the currently implemented discounted tariffs (for martyrs' families, veterans, people experiencing poverty, students, etc.) may not be sufficient.

In light of these findings, it is important to reevaluate the tariff structures and pricing and the regulatory policies to be implemented by central governments within the framework of water supply security and water management. Consistent with the literature, the implementation of practices (Bağdadioğlu et al., 2009) that address the high operational and investment costs through cross-subsidization from higher-income household consumption, thereby relieving low-income groups from an additional financial burden on their bills should be prioritised and extensively supported with impact analyses.

It is now an undeniable fact that concerns about the effective use and sustainability of water resources are increasing. Despite not having a high per capita water consumption level (133 litres), France, which experiences water scarcity, carries out intensive awareness campaigns on water conservation and imposes certain restrictions on water consumption (Valo, 2023). From this perspective, it becomes evident that the issue of water management cannot be solely considered from the perspective of consumption (demand) but requires a comprehensive approach that encompasses water supply, necessitating the development of national-level policies. Therefore, the importance of water management at both local and national levels has increased.

References

- Arbués, F. & R. Barberán (2004), "Price impact on urban residential water demand: A dynamic panel data approach", *Water Resources Research*, 40, 1-9.
- Arbués, F. et al. (2003), "Estimation of residential water demand: A state-of-the-art review", *Journal of Socio-Economics*, 32(1), 81-102.
- Armstrong, M. et al. (1994), *Regulatory Reform: Economic Analysis and British Experience*, Cambridge, The MIT Press.
- Aubuchon, C.P. & J.A. Roberson (2012), "Price perception and nonprice controls under conservation rate structures", *Journal of American Water Works Association*, 104(8), 446-456.

- Bağdadioğlu, N. vd. (2009), *Kamu Kolaylıkları Yönetişiminde Yoksulluğun Dikkate Alınması*, Ankara: UNDP.
- Barberán, R. et al. (2022), "The Perception of Residential Water Tariff, Consumption, and Cost: Evidence of its Determinants Using Survey Data", *Water Resources Management*, 36(9), 2933-2952.
- Borenstein, S. (2009), *To what electricity price do consumers respond? Residential demand elasticity under increasing-block pricing*, Center for the Study of Energy Markets.
- Clarke, A.J. et al. (2017), "Household Water Demand Seasonal Elasticities: A Stone-Geary Model under an Increasing Block Rate Structure", *Land Economics*, 93(4), 608-630.
- Dalhuisen, J. et al. (2003), "Price and Income Elasticities of Residential Water Demand: A Meta-Analysis", *Land Economics*, 79(2), 292-308.
- Deoreo, W.B. et al. (2016), *Residential End Uses of Water*, Version 2, Water Research Foundation.
- Depoorter, B. (1999), "Regulation of Natural Monopoly", in: *Encyclopedia of Law and Economics*, Part V.
- Diamond, R. & M. Moezzi (2000), "Changing trends: A brief history of the US household consumption of energy, water, food, beverages, and tobacco", in: *Proceedings of the ACEEE 2004* (10-12), Washington, D.C.
- Domene, E. & D. Saurí (2006), "Urbanisation and water consumption: Influencing factors in the metropolitan region of Barcelona", *Urban Studies*, 43(9), 1605-1623.
- Gam, I. & J. Ben Rejeb (2021), "Micro-economic analysis of domestic water demand: application of the pseudo-panel approach", *Environmental Challenges*, 4(March), 100118.
- Gaudin, S. (2006), "Effect of price information on residential water demand", *Applied Economics*, 38(4), 383-393.
- Grafton, R.Q. et al. (2011), "Determinants of residential water consumption: Evidence and analysis from a 10-country household survey", *Water Resources Research*, 47(8), 1-14.
- GWP (2000), "Integrated Water Resources Management", in: *Environmental Science and Engineering*, No. 4, Technical Advisory Committee, Issue 4.
- Kenney, D.S. et al. (2008), "Residential water demand management: Lessons from Aurora, Colorado", *Journal of the American Water Resources Association*, 44(1), 192-207.
- Klassert, C. et al. (2018), "Increasing block tariffs in an arid developing country: A discrete / continuous choice model of residential water demand in Jordan", *Water*, 10(3), 248.
- Martínez-Espiñeira, R. (2003), "Estimating Water Demand under Increasing-Block Tariffs Using Aggregate Data and Proportions of Users per Block", *Environmental and Resource Economics*, 26(1), 5-23.
- Marzano, R. et al. (2018), "Determinants of the price response to residential water tariffs: Meta-analysis and beyond", *Environmental Modelling and Software*, 101, 236-248.
- Massarutto, A. (2007), "Water pricing and full cost recovery of water services: Economic incentive or instrument of public finance?", *Water Policy*, 9(6), 591-613.
- Mayer, P.W. et al. (1999), *Residential End Uses of Water*, American Water Works Association.
- Meran, G. et al. (2021), "The Economics of War", in: *New Perspectives Quarterly* (Vol. 18, Issue 4), Springer.

- Nauges, C. & A. Thomas (2003), "Long-run Study of Residential Water Consumption", *Environmental and Resource Economics*, 26, 25-43.
- Parker, J.M. & R.L. Wilby (2013), "Quantifying household water demand: a review of theory and practice in the UK", *Water Resources Management*, 27(4), 981-1011.
- Pinto, F.S. & R.C. Marques (2015), "Tariff structures for water and sanitation urban households: A primer", *Water Policy*, 17(6), 1108-1126.
- Puri, R. & A. Maas (2020), "Evaluating the Sensitivity of Residential Water Demand Estimation to Model Specification and Instrument Choices", *Water Resources Research*, 56(1), 1-14.
- Ramulongo, L. et al. (2017), "The Nature of Urban Household Water Demand and Consumption in Makhado Local Municipality: A Case Study of Makhado Newtown", *Procedia Environmental Sciences*, 37, 182-194.
- Renwick, M.E. & R.D. Green (2000), "Do residential water demand side management policies measure up? An analysis of eight California water agencies", *Journal of Environmental Economics and Management*, 40, 37-55.
- Reynaud, A. (2015), *Modelling Household Water Demand in Europe*, European Commission Joint Research Centre Institute for Environment and Sustainability.
- Rockaway, T.D. et al. (2011), "Residential water use trends in North America", *American Water Works Association*, 103(2), 76-89.
- Rondinel-Oviedo, D.R. & J.M. Sarmiento-Pastor (2020), "Water: consumption, usage patterns, and residential infrastructure. A comparative analysis of three regions in the Lima metropolitan area", *Water International*, 45(7-8), 824-846.
- Sebri, M. (2013), "Residential water industry in Tunisia a descriptive analysis", *The Journal of North African Studies*, 18(2), 305-323.
- Timmins, C. (2003), "Demand-side technology standards under inefficient pricing regimes", *Environmental and Resource Economics*, 26, 107-124.
- Tortajada, C. et al. (2019), "Water demand management strategies for water-scarce cities: The case of Spain", *Sustainable Cities and Society*, 45(April 2018), 649-656.
- UHCHR & WHO (2010), "The Right to Water", *Fact Sheet No. 35*. Office of the United Nations High Commissioner for Human Rights, World Health Organization, 56.
- UNDP (2006), *Human Development Report 2006: Beyond scarcity: Power, poverty and the global water crisis*, New York.
- Valo, M. (2023), "Macron's water plan bets on innovation and restraint", *Le Monde*, 31 March.
- Viscusi, W.K. et al. (2018), *Economics of Regulation and Antitrust* (Math 1151), MIT Press.
- Wichman, C.J. (2014), "Perceived price in residential water demand: Evidence from a natural experiment", *Journal of Economic Behavior and Organization*, 107(PA), 308-323.
- World Bank (2003), *The Water Resources Sector Strategy: An Overview*, Washington, DC.
- World Meteorological Organization (1992), *International Conference on Water and the Environment - the Dublin Conference*, Geneva.
- Worthington, A.C. & M. Hoffman (2008), "An Empirical Survey of residential Water Demand Modelling", *Journal of Economic Surveys*, 22(5), 842-871.
- Zetland, D. & C. Gasson (2013), "A global survey of urban water tariffs: are they sustainable, efficient and fair?", *Int. Journal of Water Resources Development*, 29(3), 327-342.

Intermediate Role of Rational Spending in The Effect of Responsibility Consciousness on Utility Consumption Style¹

Gamze ERGİN (<https://orcid.org/0000-0002-0911-2178>), Malatya Turgut Özal University, Türkiye;
gamze.ergin@ozal.edu.tr

Kahraman ÇATI (<https://orcid.org/0000-0002-7440-5436>), İnönü University, Türkiye;
kahraman.cati@inonu.edu.tr

Ebru OSKALOĞLU (<https://orcid.org/0000-0001-9125-5110>), İnönü University, Türkiye;
ebruoskaloglu@gmail.com

Sorumluluk Bilincinin Faydacı Tüketim Tarzına Etkisinde Rasyonel Harcamanın Aracılık Rolü²

Abstract

Within the scope of this research, it was revealed whether rational spending (with and without credit cards) has a mediating role in the effect of responsibility consciousness on utilitarian consumption style. In addition, it was determined whether the level of responsibility consciousness affects utilitarian consumption style and rational spending and whether rational spending affects utilitarian consumption. Research data were collected using the questionnaire technique. Data were collected from 479 students, 129 academics and 71 administrative staff. The collected data were analysed using SPSS 26 and PROCESS v4.2 plugin. In the research, first of all, the dimensions of responsibility consciousness, utilitarian consumption style and rational spending scales were determined with the help of explanatory factor analysis. As a consequence of the factor analysis, responsibility awareness and utilitarian consumption are one dimension; the rational spending scale was determined to have two dimensions: rational spending habit without credit cards and rational use of credit cards. As a consequence of the intermediation analysis, it was concluded that the consciousness of responsibility affects rational spending without credit cards, rational use of credit cards and utilitarian consumption. In addition, it was supposed that rational spending without credit cards and rational use of credit cards affect utilitarian consumption, and rational spending without credit cards affects rational use of credit cards. The serial mediation analysis using Model 6 determined that the consciousness of responsibility affects utilitarian consumption serially (one after the other) through rational spending (rational use of credit cards and rational spending habits without credit cards).

Keywords : Consciousness of Responsibility, Utilitarian Consumption, Rational Spending, Rational Spending Habit Without Credit Card, Rational Use of Credit Card, Segmentation Approach, Serial Mediation Analysis.

¹ This article is an expanded and translated into English version of the paper presented and published as a full text at the Aegean 9th International Social Sciences Congress held in İzmir/Turkey on 22-24 September 2023, under the title "Examination of Responsibility Consciousness and Utilitarian Consumption in the Context of Demographic Factors".

² Bu makale 22-24 Eylül 2023 tarihlerinde İzmir/Türkiye'de düzenlenen Ege 9. Uluslararası Sosyal Bilimler Kongresi'nde "Sorumluluk Bilinci ve Faydacı Tüketimin Demografik Faktörler Bağlamında İrdelenmesi" başlığıyla sunulup tam metin olarak yayınlanan bildirinin genişletilmiş ve İngilizceye çevrilmiş halidir.

JEL Classification Codes : C10, C11, C19, E20, E29, G41, M30.

Öz

Bu araştırma kapsamında, sorumluluk bilincinin faydacı tüketim tarzına etkisinde rasyonel harcamanın (kredi kartlı ve kredi kartsız) aracılık rolünün olup olmadığı ortaya konuldu. Ayrıca, sorumluluk bilinç düzeyinin faydacı tüketim tarzını ve rasyonel harcamayı, rasyonel harcamanın da faydacı tüketimi etkileyip etkilemediği belirlendi. Araştırma verileri anket tekniğinden faydalanılarak toplandı. Veriler 479 öğrenci, 129 akademik personel ve 71 idari personelden toplandı. Toplanan veriler SPSS 26 ve PROCESS v4.2 eklentisinden faydalanılarak analiz edildi. Araştırmada öncelikle sorumluluk bilinci, faydacı tüketim tarzı ve rasyonel harcama ölçeklerinin boyutları açıklayıcı faktör analizi yardımı ile belirlendi. Yapılan faktör analizi neticesinde sorumluluk bilinci ve faydacı tüketim tek boyut olarak; rasyonel harcama ölçeği ise kredi kartsız rasyonel harcama alışkanlığı ve kredi kartını rasyonel kullanma olarak iki boyut şeklinde belirlendi. Yapılan aracılık analizi neticesinde sorumluluk bilincinin kredi kartsız rasyonel harcamayı, kredi kartını rasyonel kullanmayı ve faydacı tüketimi etkilediği sonucuna ulaşıldı. Ayrıca kredi kartsız rasyonel harcamanın ve kredi kartını rasyonel kullanmanın faydacı tüketimi etkilediği ve kredi kartsız rasyonel harcamanın kredi kartını rasyonel kullanmayı etkilediği sonucuna ulaşıldı. Model 6 kullanılarak yapılan serisel aracılık analizi sonucunda sorumluluk bilincinin faydacı tüketimi rasyonel harcama (kredi kartını rasyonel kullanma ve kredi kartsız rasyonel harcama alışkanlıkları) üzerinden serisel (yani peş peşe) olarak etkilediği tespit edildi.

Anahtar Sözcükler : Sorumluluk Bilinci, Faydacı Tüketim, Rasyonel Harcama, Kredi Kartsız Rasyonel Harcama Alışkanlığı, Kredi Kartını Rasyonel Kullanma, Bölümleme Yaklaşım, Serisel Aracılık Analizi.

1. Introduction

The idea of paying by card instead of cash, which seems impossible for people, was first mentioned in Edward Bellamy's novel "Looking Backward: 2000-1887/Looking Back 2000-1887", published in 1888. This idea, which seemed impossible then, is the first sign of the birth of cards, which have become an indispensable part of daily life today (Korur & Kimzan, 2006). Hotel Credit Letter Company launched the world's first hotel payment card in 1894 (Yücel & Çiftçi, 2019). In this way, humankind met an alternative payment method other than cash payment for the first time. In 1914, Western Union Bank launched the world's first credit card with the motto "buy now, pay later" (Korur & Kimzan, 2006). On the other hand, in Turkey, the first card was limited to a few thousand people and transactions, and Setur A.Ş., a subsidiary of Koç Group, issued it. It was published by Diners Club in 1968 with authorisation (Yıldırım, 2019; Yücel & Çiftçi, 2019; Pilatin, 2021). Today, according to the data of the Interbank Card Centre (BKM), August 2022, the total number of credit cards in Turkey is 93.832.954, the total number of debit cards is 161.841.623, the total number of POS is 1.848.462, and the total number of ATMs is 52,158. According to BKM's data, in the first six months of 2022, domestic bank card transactions increased by 57.10%, and the transaction amount (TL) increased by 59.55% compared to 2021. The use of domestic credit cards, on the other hand, increased by 33.23% based on the

number of transactions and by 93.54% based on the transaction amount (TL) (<<https://bkm.com.tr/>>).

Bank cards, which are also referred to as debit cards and ATM cards, are payment instruments that allow account holders to make transactions, send money and pay their bills, with the ownership of the bank, as an alternative to the use of credit cards (Koç, 2011; Dülger, 2013; Lim et al., 2014; Parlar, 2015; Altuğ, 2019). The cardholder can also perform these transactions via the Internet, POS machine or ATM (Taşdemir, 2009). On the other hand, a credit card is a payment tool that is open to the cardholder and allows them to purchase a particular good or service without using cash (Akipek, 2003). The main difference between debit and credit cards is where the cards draw the money. While the debit card withdraws the payments for the expenditures from your account balance, the credit card draws it from the credit limit (<<https://www.bakiyem.com/>>). Since debit cards offer similar advantages to their users, they have been proposed as an alternative to credit cards. Debit cards are a good substitute for credit cards and will limit overspending as the debit card limit is defined as how much money the owner has in their bank account. People will avoid spending more than they can afford, as their spending will be based on their bank balance (Lim et al., 2014).

Homo Economicus (rational, selfish and emotionless), which means the rational person (rational individual) is utilitarian and tries to make consumption that will maximise his benefit even if he cannot do it all the time (Buğday et al., 2020; Polat, 2022). Social and technological developments have led consumers to satisfy their desires and needs. Consumers have begun to see shopping as an element of pleasure and entertainment and providing tangible benefits (Bayır, 2021). In this case, he transformed the concept of "homo economicus" (wise man and man who knows) into the idea of "homo consumaterus" (consuming man) (<<https://tuketici.ticaret.gov.tr/>>). On the other hand, purchasing activity has been transformed from rationally satisfying the need to shopping to satisfy emotions and desires. Based on consumption, these decisions are driven by hedonic and utilitarian motivations. Studies in the literature point to two basic instincts in consumer behaviour: hedonistic satisfaction from sensory attributes, emotional (hedonic) satisfaction, and instrumental (utilitarian) satisfaction from functional attributes (Çopuroğlu & Çayırağası, 2022). In the utilitarian consumption style, purchasing starts as a task, and the benefit gained depends on whether the task is completed or not or whether the task is fulfilled efficiently in the purchasing process (Tokgöz, 2019). Utilitarian consumption, which is task-oriented and means the satisfaction of needs, defines utilitarianism as a necessity (Köroğlu & Yıldız, 2019). Considering elements such as quality, price and value are the main determinants of rational consumer behaviour (Tokgöz, 2019; Köroğlu & Yıldız, 2019). Lim et al. (2014) emphasised that society should be aware of the causes and consequences of consumption decisions (Lim et al., 2014). In terms of the sustainability of life, the needs must be met. For this, the values that guide consumption should include compliance with the primary purpose of consumption, adequacy, not waste, and rational and responsible behaviour (<<https://tuketici.ticaret.gov.tr/>>).

Needs must be met for the sustainability of life. For this, the values that guide consumption must consist of values such as suitability for needs, sufficiency, avoidance of waste, and rational and responsible behaviour, which are the primary purposes of consumption. (<<https://tuketici.ticaret.gov.tr/>>).

Because utilitarian consumers tend to be more rational, they process incoming product or service information analytically and considerably, evaluating facts about the product or service to make a rational decision based on their consumption goals. Based on this, it is reasonable to expect that a best-selling product/service that highlights clear facts about the benefits of environmental sustainability may attract these consumers' interest and attention to such attributes and, as a result, increase their adoption intentions (Liu et al., 2019: 4609). The relationship between sustainability and utilitarian consumption (Niinimäki, 2010; Overby & Lee, 2006; Razzaq et al., 2018; Wei et al., 2023) is significant because consumers who do not have a clear understanding of sustainability are never informed about the consequences of their consumption behaviour (Razzaq et al., 2018: 3).

Consumers have responsibilities towards society, the environment and other living things while engaging in consumption activities (Karaca, 2019: 151). Responsible consumers are aware of their personal and social responsibilities while meeting their individual consumption needs (Çelebi & Bayrakdaroğlu, 2018: 113; Bayazıt-Hayta, 2009: 147; Karaca, 2019: 148; Karaca & Yemez, 2020: 772). This awareness is an indispensable need for the individual and the growing and developing economy (Bayazıt-Hayta, 2009: 147). Consumers should be directed to act rationally and sensitively, considering the impact of their behaviour on other members of society (Bayazıt-Hayta, 2009: 148). For consumption to be evaluated rationally, goods or services must be adequate in quality, reduce resource use, and be environmentally friendly when meeting needs (Çelebi & Bayrakdaroğlu, 2018: 113; Karaca, 2019: 150). People should be responsible not only for their purchasing choices but also for the impact their daily actions and decisions will have on the economic, social and environmental spheres of life (Karaca, 2019: 148). Otherwise, the extent of destruction caused by aimless and unconscious consumption, including environmental problems such as global warming, depletion of the ozone layer, water and air pollution, acid rain, increase in threatened species, desertification, and erosion in agricultural lands, will increase day by day (Çelebi & Bayrakdaroğlu, 2018: 112; <<https://www.researchgate.net/>>; Türkmen & Erten, 2020: 657). Consumption deprives the world of renewable and non-renewable resources and emits hazardous substances into the air, water and soil, resulting in unmanageable amounts of solid waste (Karaca, 2018: 255). Considering all this, it is clear that this rapid increase in production and consumption will only increase the destruction, so both consumers and producers have no choice but to take responsibility and slow down and downsize (<<https://www.researchgate.net/>>). While it is seen that it is difficult for consumers with predominantly hedonic tendencies to participate in pro-environmental behaviour or sustainability (Türkdemir, 2019: 21), it is much easier for consumers with utilitarian values to contribute to sustainability (Türkdemir, 2019: 22; Niinimäki, 2010; Overby & Lee, 2006; Razzaq et al., 2018; Wei et al., 2023; Karaca & Yemez, 2020: 773).

Individuals who put their expectations aside and take into account the impact of consumption behaviour on society or use their purchasing power for social change can direct social change (Karaca, 2019: 150; Şengün, 2016: 67). Responsible individuals who have the power to change the world with the choices they make, also consider the impact and consequences of their consumption on society and consider it their duty (Karaca & Yemez, 2020: 772). The utilitarian consumer is more rational, saves money, and often exhibits sustainable and environmentally friendly purchasing behaviour (Türkmen & Erten, 2020: 658; Karaca & Yemez, 2020: 774; Karaca, 2018: 256).

It is said that the process of printing the necessary money to spend the cash is harmful to the environment / pollutes the world more than the card systems (<<https://media4democracy.org/>>; Yuan et al., 2023); also, it is said that the card systems cause more significant damage to the environment by increasing consumption (Ünal et al., 2015; Ulucan-Özkul & Tapşın, 2010; Karamustafa & Biçkes, 2003; Altan & Göktürk, 2007; Şentürk, 2008; Sancak & Demirci, 2012; Özdemir, 2020; <<https://www.tbb.org.tr/>>; Yuan et al., 2023; Yıldırım & Demir, 2021; Kölgeliler, 2022; Merdan & Okuruoğlu, 2016; <<https://www.ekoik.com/>>; Uslu & Gündoğdu, 2011; Durmuş, 2022). The sustainability of the environment also depends on the consumption behaviour of society. Consumers are generally guided by comfort, habit, personal health concerns, hedonism, and social and institutional norms, which often contribute to waste (Lim et al., 2014). One significant factor contributing to wastage is the lack of knowledge regarding the rational and efficient utilisation of resources to fulfil requirements and desires and the methods to enhance their quality and quantity. Credit cards threaten human health, well-being and all other things valued with unplanned consumption, enabling consumers to use the income they will earn in the future (Buğday et al., 2020; Sheth et al., 2011). Since credit cards provide the consumer with the opportunity to use future income, they threaten human health, welfare, labour, time and many other valuable things with unplanned and excessive consumption (Buğday et al., 2020; Sheth et al., 2011; <<https://tuketici.ticaret.gov.tr/>>).

Personality, one of the primary sources of consumer decisions, is one of the psychological factors that permanently and distinctively affect the person's behaviour (Buchanan & Huczynski, 2003; Gohary & Hanaee, 2014). Identifying the personality traits of individuals also allows us to understand their behaviour patterns. The five-factor personality theory developed by McCrae Robert R. and Costa Paul T. in 1985 does not place personality traits by considering the groups in people's personalities (Öztürk, 2019: 9-10). The theory consists of 5 dimensions: "extraversion", "openness to experience", "responsibility", "adaptation", and "emotional stability" (Peabody & Goldberg, 1989). Responsible individuals, which is one of the dimensions of the five-factor personality theory, are planned, organised, careful, determined, caring about social rules and values, self-sacrificing, reliable, success-oriented, disciplined, have a high level of job satisfaction, motivation and coping with problems, and are hardworking people who finish the job they started (Goldberg, 1992; McCrae & John, 1992; Somer, 1998; Perry, 2003). Responsible individuals evaluate the compatibility between the price and quality of the goods and whether there is a real need for the goods before deciding to purchase something. Gohary

and Hanzae (2014) stated that conscientious individuals do research before deciding which products to buy, so they act according to utilitarian value principles (Alhad, 2021). Responsible individuals do not make instant purchases as they can control their impulsive emotions and delay gratification (Gohary & Hanzae, 2014). The process these individuals carry out in shopping is related to product quality and durability. Responsible individuals tend to choose products with good durability, so it is not unusual for them to be very loyal to a product of a particular brand because they already feel the quality of the product (Alhad, 2021).

Consumption is when people buy the necessary utility to meet their needs. A consumer may purchase aspirin to quench pain, water to quench their thirst, a car for transportation, a new television for better sound and picture quality, etc. While this approach helps explain many examples of purchasing and consumption, it does not seem sufficient to explain why consumers with an adequate standard of living give up their spare time to buy more and take on debt burdens that endanger their financial and emotional security (Richins, 2011). Consumers need to abandon hedonistic consumption and adopt utilitarian consumption for their economies, national economies and sustainable production and consumption (Hatipler & Köksalan, 2020; Kırıcı, 2014; Çoşkun, 2019; Durmuş, 2022). If consumers behave rationally in their spending, the world will be a more liveable and sustainable place. Otherwise, our consumption desires will destroy the social and ecological order (Kırıcı, 2014). In this context, the study aims to measure the mediating effect of rational spending on individuals who make utilitarian consumption expenditures with the consciousness of responsibility.

This research examines the effect of responsibility awareness on rational spending habits without a credit card and rational use and the contribution of rational spending habits without a credit card and rational use of a credit card to utilitarian consumption. This situation, which emerged in the study depending on the consumption experience, schematises rational spending due to awareness of responsibility (rational spending habits without a credit card and rational use of the credit card) and the emergence of the benefit resulting from spending. It aims to test the effect of responsibility awareness on utilitarian consumption with a model that also includes the rational spending instrument variable. In the literature, the effect of responsibility awareness and rational consumption on utilitarian consumption has been examined. However, studies have yet to be found in the literature concerning the mediating role of rational consumption in the effect of responsibility awareness on utilitarian consumption. An important originality of the study is how this issue will affect both credit card and non-credit card spending. In addition, since no study directly reflects this model in current theories and previous studies, this study will be important in filling the gap in the literature.

If the model in question is verified, it will be revealed that more than the responsibility awareness of consumers alone will be required to prevent waste, environmental pollution, wasted labour, unplanned expenses and destruction of resources. It will be emphasised that to increase utilitarian consumption, rational spending and

responsibility awareness should be revived in the world of consumers. In addition, it will be revealed how spending with a credit card and without a credit card affects utilitarian consumption.

2. Conceptual Framework and Hypothesis Development

The connection between the antecedents (i.e., shopping motives) of consumption intention and its consequences (i.e., shopping values) revealed two contradictory situations. The first case that emerged is hedonic consumption (i.e., ridiculous, aesthetic and pleasure-loving), which contains personality features such as "Openness to Experience", "compatibility", and "extraversion"; the second case is utilitarian consumption (functional, rational and about duty/responsibility), which contains personality features such as "Emotional Stability" and "Responsibility", is related to shopping value (Guido, 2006). In today's world, where nothing is free (Madhoun & Bertin, 2017), changing attitudes towards money is also a significant driving force behind the spread of consumer culture (Roberts & Jones, 2001). There is a need to examine the cards used in payments, the penetration of digital technologies into consumer behaviour, and the desire to know how consumer behaviour and preferences will shape the future (Proskurnova et al., 2020). In this context, the framework of the research is also based on these theories, and the conceptual framework related to the concepts of responsibility consciousness, utilitarian consumption and rational spending within the framework of previous research and the hypothesis and model developed in this direction are presented in this section.

2.1. Relationship Between Responsibility Consciousness and Rational Expenditure

Responsibility, which is a sign of maturity, expresses the individual's acceptance of the situations that occur as a result of one's behaviour and the consequences of the events surrounding an individual (Taştumur, 2018: 43). Responsible individuals are those who are logical, patient, in harmony with others, act in a regular and planned manner, follow the rules, make reliable, rational decisions, act prudently and believe that the product they buy will perform as expected (Costa & McCrae, 2008; Deniz & Erciş, 2011). Because of these features they have, they expect rational benefits from the products they buy (Deniz & Erciş, 2011). For consumption to be qualified as rational, the goods and services must be purchased because they are needed, the price must be appropriate for the income level, the product must be of good quality, and it must be environmentally friendly. Otherwise, consumption will be irrational consumption (Kuşcuoğlu-Yılmaz, 2018).

One of the main problems with card use is that users do not understand the difference between debit and credit cards. It is necessary to explain to almost every segment of society the benefits that debit cards and credit cards provide to users and their differences from each other. Both credit cards and debit cards have many unique advantages and disadvantages. The issue of an advantage and a disadvantage may vary depending on your needs and habits. The payment method positively affects card spending and debts (Lin et al., 2019). Therefore,

awareness appears to be an attribute that should be promoted to encourage both more responsible consumption and attitudes and behaviours towards money and credit (Pereira & Coelho, 2019: 22). Because cards make our lives easier by providing benefits when used correctly and appropriately. For example, credit cards are payment tool that provides the opportunity for conscious individuals with low economic power to meet their needs in the short term and postpone payments and pay in instalments (Gül, 2021: 99; Terzi & Bayrakdaroğlu, 2022: 539). This way, maximum benefit will be provided from the purchased product/service, and the economy will be revitalised. However, if credit cards are not used consciously, they will create unbearable debt burdens in the long run.

To prevent the adverse effects of credit cards, measures are taken such as reducing instalments, increasing credit card interest rates, giving individuals card limits commensurate with their income, spending limits and restrictions on the number of cards (Gül, 2021: 98). Additionally, responsible credit card use can be increased by offering better opportunities for cash payment to protect consumers from the adverse effects of credit cards (Palan et al., 2011: 92). It is thought that such practices will have a positive impact on individuals acting responsibly and adopting a utilitarian consumption style. While it is undoubtedly important to learn responsible card habits, the findings of this study are also important as they reveal the impact of individual differences on individuals' rational spending and consumption styles.

Cards can cause individuals to spend more than their budgets, resulting in a social tragedy, including excessive debt, living in debt, executions, and even suicides and murders. The rational use of the card is to act with the awareness of one's responsibilities by not exceeding one's payment power, taking into account the ability to pay and avoiding undesired costs (Gül et al., 2021; Ünal et al., 2015). Individuals can eliminate a possible social tragedy by being aware of their responsibilities, planning their expenditures by considering their ability to pay, using debit cards, credit cards and other financial instruments rationally, and combating the financial crisis (Başaran et al., 2012: 68; Ünal et al., 2015). Rational use of the card can only be possible if the holder knows its use and cost (Ünal et al., 2015). Irrational consumers use credit cards in a way that is not proportional to their current and future incomes and avoid saving by excessive borrowing. The reasons for this situation are credit card holders have a short time to think while shopping, their tendency to borrow more than cash users, their propensity to make unplanned purchases, the additional purchasing power created by the cards, their low sensitivity to price, and the lack of financial information. Moreover, rational consumers can balance their income and credit use, pay their debts on time, and take on the responsibilities of using credit (Kuşcuoğlu-Yılmaz, 2018). One of the most effective ways to reduce these adverse effects mentioned above is to use the card rationally by the holder. Rational and conscious use can be increased with economic literacy (Ünal et al., 2015).

When the studies in the literature are examined, it is seen that there is a positive relationship between a sense of responsibility and rational behaviour (Uslu Divanoğlu & Uslu, 2019); rational spending habits without credit cards affect rational credit card use

(Ünal et al., 2015), rational spending habits without credit cards and rational credit card use. There is a positive correlation between rational spending habits without a credit card and rational credit card use relationship (Başaran et al., 2012), responsibility awareness does not affect financial literacy (Apan & Ercan, 2017), there is no significant relationship between financial decision making focusing on unsecured debt and financial assets and responsibility (Brown & Taylor, 2014). Studies have found that awareness of responsibility affects money management (Donnelly et al., 2012) and that responsibility negatively affects the probability of having credit card debt (Choi & Laschever, 2018). In line with the information in the literature, the following hypotheses are suggested:

H1: Consciousness of responsibility (X) affects rational spending habits (M1) without a credit card. (way a1)

H2: Consciousness of responsibility (X) affects rational credit card use (M2). (way a2)

H3: Rational spending habits without credit cards (M1) affect the rational use of credit cards (M2). (d21 way)

2.2. The Relationship between Responsibility Consciousness and Utilitarian Consumption Style

The preferences and decisions of the consumer are determined by many demographic, cultural, and psychological factors, as well as their physical and psychological needs (Kuşçuoğlu-Yılmaz, 2018). Personality is a psychological factor that closely affects consumer behaviour, the purchasing decision process, and consumption styles (Ünal & Erçiş, 2006: 361). Personality is the innate features and character of a person that distinguish them from other people (İbrahimoğlu et al., 2013: 94). When evaluated in terms of consumption style, it is important to determine the personality traits of consumers and reveal their purchasing behaviours and consumption habits (Solunoğlu & Nalçacı-İkiz, 2020: 3). Many opinions have been put forward regarding the concept of personality. The Five Factor Theory of Personality collects these views in one place (Ekber & Gurbanova, 2021). These five factors in the consumption field are related to the rational and task-oriented motives behind cognitive processes (utilitarian consumption). It is interpreted as the precursor of shopping behaviours related to emotional motives (hedonic consumption) in the field of emotions and personal goals (Guido, 2006; Aydın, 2019). "Emotional stability" and "responsibility" are associated with utilitarian consumption; "openness to experience", "adaptation", and "extraversion" are associated with related hedonic consumption. Responsible people are those who are compatible with others, honest, patient, trust people, think thoroughly and meticulously, act in a planned manner, analyse the benefit-harm relationship, act prudently, and believe that the product they buy will show the expected performance (Camgöz, 2009; Deniz & Erçiş, 2011). Due to these features, they focus on the functional and concrete features of products and services in consumption and purchasing processes (Köker & Maden, 2012). In other words, they consider the product's features, such as price, quality, performance and packaging, and give importance to price-quality-value in product selection (Deniz & Erçiş, 2011). In the utilitarian dimension, the consumer perceives

the consumption activity as a duty. The consumer considers the purchase job the "completion of the task" and exhibits rational behaviour (Türk, 2018).

When the studies in the literature are examined, the consciousness of responsibility affects utilitarian consumption (Guido, 2006; Guido et al., 2007; Guido et al. 2008; Ekber & Gurbanova, 2021; Karl et al., 2007; Chen & Lee, 2008; Gohary & Hanzaee, 2014; Alhad, 2021), responsibility consciousness does not affect utilitarian consumption (Tsao & Chang, 2010), responsibility consciousness and utilitarian consumption are positively related (Guido et al., 2015), responsibility consciousness is negatively associated with compulsive buying (Mowen & Spears, 1999), In line with the information in the literature, the following hypothesis is suggested:

H7: Consciousness of responsibility (X) affects utilitarian consumption (Y). (c: total effect)

2.3. The Relationship between Rational Spending and Utilitarian Consumption Style

According to classical economic theory, humans are economic and rational beings, and the most important factor affecting consumer behaviour is this structure of humans. In other words, consumers try to allocate their budget to the goods and services they need in a way that will provide them with the highest satisfaction (Başaran et al., 2012). But the consumption culture has shifted from focusing on saving first and then spending to encouraging spending now and thinking later. Although current research often attributes overspending to credit availability, a dark point exists in understanding why consumers overspend, particularly through credit cards (Lim et al., 2014).

Rational use of cards can be expressed as paying the debt on time and in full without exceeding one's ability to pay, acting as a responsible individual and not encountering undesirable costs (Başaran et al., 2012: 69-70). Today, making credit card applications more accessible and simplifying credit card applications provides convenience for consumers but indirectly attracts consumers who are less rational about spending more (Lim et al., 2014).

Economic decisions that affect both the current situation and the future of individuals, such as how much they will save their income, where and how they will borrow, how much they will spend their income and borrowed capital, how they will use their budget in the context of tastes, wishes and needs, how and how much investment for their future can be listed as things to do. While making these economic decisions throughout their lives, individuals exhibit purchasing behaviour according to their hedonic and utilitarian consumption tendencies (Polat, 2022). Utilitarian consumption is rational and planned shop transactions, providing monetary convenience and savings, and choosing the most suitable and efficient product by considering the research process, time and labour costs (Tanrikulu & Bakır, 2021). In utilitarian consumption, which means the satisfaction of task-oriented needs, concepts such as quality, usefulness, diversity, good goods, reasonable prices and value are accepted as the main determinants of rational consumer behaviour (Rajan, 2020;

Köroğlu & Yıldız, 2019). Consumers act with economic and utilitarian thinking in line with these factors (Köroğlu & Yıldız, 2019).

Utilitarian consumption negatively and significantly affects compulsive buying (Faber & O'Guinn, 1992; Chang, 2002; Steenkamp & Baumgartner, 1995; Roehm & Roehm, 2005; Tokgöz, 2019; Lee et al., 2009); utilitarian consumption does not affect compulsive buying (Babin et al., 1994; Bayır, 2021), utilitarian consumption affects impulsive buying behaviour significantly and negatively (Tokgöz, 2019), utilitarian consumption affects impulsive buying (Türk, 2018), utilitarian consumption affects uncontrolled credit card use (Bayır, 2021), causes financial problems (Bevill & Dale, 2006; Awanis & Cui, 2013), low-income groups act more rationally (Açıklım & Yasar, 2017); those with high income levels have low utilitarian value perceptions (Külter-Demirgüneş, 2016), there is a significant difference between income level and utilitarian consumption (Şahin & Fırat, 2018; Polat, 2022), there is a positive and meaningful relationship between financial anxiety and rational use of credit cards (Ahmetoğulları & Parmaksız, 2017) studies were found. Khandelwal et al. (2022), misuse of credit cards also plays a role (moderate variable) among consumers' psychological characteristics such as power-prestige, self-esteem, risk-taking and compulsive buying (Khandelwal et al., 2022). In line with the information in the literature, the following hypotheses are suggested:

H4: Consciousness of responsibility (X) affects utilitarian consumption (Y) together with the habit of rational spending without a credit card (M1) and rational use of a credit card (M2). (c' way)

H5: Rational spending habits without credit cards (M1) affect utilitarian consumption (Y). (b1 way)

H6: Rational use of credit cards (M2) affects utilitarian consumption (Y). (b2 way)

H8: Rational spending habits without credit cards (M1) have a mediating role between consciousness of responsibility (X) and utilitarian consumption (Y). (Indirect effect 1)

H9: Rational use of credit cards (M2) has a mediating role between consciousness of responsibility (X) and utilitarian consumption (Y). (Indirect effect 2)

H10: Consciousness of responsibility (X) influences utilitarian consumption (Y) serially through rational spending habits without credit cards (M1) and rational use of credit cards (M2). (Indirect effect 3)

H11: The indirect effect of responsibility consciousness on utilitarian consumption through the rational use of credit cards is statistically different from that of responsibility consciousness on utilitarian consumption through rational spending habits without credit cards. (Indirect effect 1- Indirect effect 2)

H12: The indirect effect of responsibility consciousness on utilitarian consumption through the rational use of credit cards is statistically different from the serial indirect effect of responsibility consciousness on utilitarian consumption (rational spending habits without credit cards → rational use of credit cards). (Indirect effect 1- Indirect effect 3)

H13: The indirect effect of responsibility consciousness on utilitarian consumption through rational spending habits without credit cards is statistically different from the serial indirect effect of responsibility consciousness on utilitarian consumption (rational spending habits without credit cards → rational use of credit cards). (Indirect effect 2- Indirect effect 3).

3. Research Methodology

Within the scope of the research, the survey method, one of the quantitative research methods, was preferred. The survey method is accepted as one of the most important tools that allow the description of the current situation and is widely used. Studies that aim to determine people's attitudes, beliefs, opinions, behaviours, expectations and characteristics on specific issues with the help of questionnaires are called survey research (Gürbüz & Şahin, 2017). In the survey method, the event, individual or object chosen as the research subject is described in its conditions and as it is (Karasar, 2005).

3.1. Purpose and Model of the Research

The study aims to determine the mediator role of rational spending in the effect of responsibility consciousness on utilitarian consumption style. It will be significant to reveal whether rational spending (mediating variable) has a mediating effect on the effect of students, administrative and academic staff's responsibility of consciousness (X independent variable) on utilitarian consumption style (Y dependent variable). Therefore, the model of the research is constructed as the mediating role of rational spending (M1, M2) in the effect of the independent variable responsibility consciousness (X) on the dependent variable utilitarian consumption style (Y) (Figure 1).

Figure: 1
Research Model

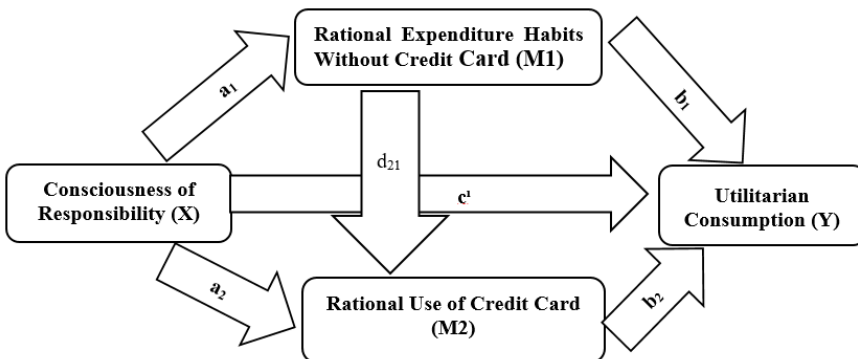

Rungtusanatham et al. (2014) examined the issue of how research hypotheses are developed and expressed in models in which the mediator variable is included and suggested two basic approaches, namely segmentation and transmittal approach (Çelik, 2022). If we explain the hypotheses developed while adopting the segmentation approach according to Figure 1: (i) the effects of X on M1 and M2, (ii) the effect of M1 on Y in the presence of X and holding M2 constant, (iii) the effect of M2 on Y in the presence of X and holding M1 constant, (iv) M1 and M2 while holding constant the effect of X on Y, (v) determining the statistical significance of a_1 , a_2 , b_1 , b_2 and c' , (vi) determining whether $a_1.b_1$ or $a_2.b_2$ is significant. For this scenario, the theory-building task is primarily a_1 (path $X \rightarrow M1$), a_2 (path $X \rightarrow M2$), b_1 (path $M1 \rightarrow Y$), b_2 (path $M2 \rightarrow Y$), and finally, it should focus on assuming c' (direct effect of X on Y). In short, the approach to hypothesising individual pathways for theorising mediation effects is called the "Segmentation Approach" (Rungtusanatham et al., 2014: 106-107). The segmentation approach is recommended for testing the indirect effect if there is no direct support from existing theories or previous studies (Çelik, 2022).

In the transmittal approach, researchers focus only on the indirect effect. In the transmittal approach, researchers should develop the hypothesis that M mediates the effect of X on Y without expressing H1 and H2 in the segmentation approach (Çelik, 2022). The choice of approach depends on the availability of established theories and previous empirical studies supporting the indirect effect. For example, some variables representing the middle tier (e.g., attitude, desire, or organism) may mediate if applied with a hierarchy of effects such as value-attitude-behaviour, belief-desire-behaviour, or stimulus-organism-response theories. These theories influence indirect effect (i.e., sequential effect) and can directly support the mediator (Rasoolimanesh et al., 2021: 396). The "Segmentation Approach" is more appropriate for this research model (Figure 1), as there is no logical and theoretical support from the literature and a validated transmittal approach for direct effect.

Two approaches are accepted in the literature to test whether there is a mediating effect. The first is Baron & Kenny's causality approach, and the second is the modern approach based on Andrew Hayes' bootstrap test. In the causality approach, the presence of the mediating effect is determined by the Sobel test, while in the modern approach, it is determined by the bootstrap test in the PROCESS Macro plugin. The generally accepted opinion in the literature is the low reliability and accuracy of the Sobel test results when compared with the bootstrap confidence interval results. In addition, since the Sobel test connects the mediation effect analyses to preconditions, it also causes the rejection of indirect effects that may be statistically significant (Bozkurt, 2021).

According to the modern approach (Gürbüz & Bayık, 2021);

- The overall effect (c) does not need to be statistically significant. Although the total effect (c) is not statistically significant, there might be mediation models with a statistically significant effect.
- The effect of the independent variable (X) on the mediating variable (M) (a) need not be statistically significant by itself.

- While the effect (c') of the independent variable (X) is kept under control, the effect (b) of the mediating variable (M) on the dependent variable (Y) need not be statistically significant on its own.
- It is not appropriate to describe only qualitative judgments and mediation models in the form of partial mediation and full mediation statements. It is more appropriate for the scientific approach to report the findings related to the mediation model numerically by calculating the direct effect (c'), indirect effect (a.b) and total effect ($c = c'+a.b$) values instead of partial mediation and full mediation expressions.
- The direct effect (c') and the total effect ($c = c'+a.b$) may not be statistically significant; the insignificance of the direct effect and the total effect does not eliminate the existence of the indirect effect (a.b) and does not invalidate the mediation model.
- In analysing and interpreting mediation models, quantified expressions should be used instead of qualitative descriptions of mediation or no mediation. In this context, fully standardised direct (cc's), indirect (a.bcs) and total (ccs) impact values should be calculated, and the magnitudes of the impact values and relative size comparisons with each other should be made.
- Decisions about whether the indirect effect, direct effect and total effect values are statistically significant should be tested and interpreted with the bootstrap confidence interval (if this is not possible, the Monte Carlo confidence interval). Findings from bootstrap confidence interval calculations should be used instead of the Sobel Test to determine the significance of the indirect effect (Gürbüz & Bayık, 2021). Suppose there is no 0 value between Boot LLCI and Boot ULCI values. In that case, it is stated that there is a mediating effect in the relationship between the dependent variable and the independent variable (Sever & Çatı, 2021).

For all these reasons, Hayes' PROCESS v4.2. The bootstrap test in the plugin was used. While reporting the results, the results of Boot LLCI and Boot ULCI values were interpreted.

3.2. Population and Sample of the Research

Within the scope of the research, data were collected from Malatya Turgut Özal University students, academic staff and administrative staff between 09.12.2022 and 03.01.2023 through an online questionnaire. Since it is difficult in terms of cost and time to examine the entire universe in collecting the data, the sampling method was preferred. Malatya Turgut Özal University has 6.174 active students, 402 academicians and 394 administrative staff for 2022-2023 (<<https://obs.ozal.edu.tr/>>). 6.970 people were determined to be the universe of the research. Two research questionnaires were sent to the entire universe through the automation system. In addition, the research questionnaire was

sent to the administrative staff and academic staff twice. The number of participants who provided feedback is 679.

3.3. Data Collection Tools

Survey or survey-type research designs are generally used in Social Sciences research (Gürbüz & Şahin, 2016). In this study, data were collected by using the questionnaire technique.

The questionnaire form prepared for the research consists of two parts. The first part consists of 9 questions about the demographic characteristics of the participants. In the scales in the second part, there are six questions about responsibility consciousness (Öztürk, 2019), nine questions about utilitarian consumption style (Çoşkun & Marangoz, 2019) and eleven questions about rational spending (Başaran et al., 2012). A 5-point Likert scale was used in all previously tested scales for validity and reliability. Values in the scale: (1) Strongly disagree, (2) Disagree, (3) Undecided, (4) Agree, and (5) Strongly agree.

3.4. Analysis of Data and Findings

Within the scope of the research, face-to-face data were collected from 33 participants (30 students and three academic staff), and the intelligibility of the questions was tested. According to the data obtained from the pre-test, the questions were finalised and made ready for the study. In this context, data were collected from 679 participants through an online survey between 09.12.2022 and 03.01.2023. Frequency analysis, factor analysis, and mediation tests were performed on the data transferred to the SPSS 26 package program. PROCESS v4.2 plugin was used when performing mediation testing.

The findings related to the frequency analysis results, in which the demographic characteristics of the participants are described, are given in Table 1.

As seen in Table 1, 54.5% of the participants are women and 45.5% are men. 64.8% of the participants were between the ages of 18-26, 23.6% were between the ages of 27-42, 11% were between the ages of 43-57, and 0.6% were 57 years and older. 2.4% have received or are continuing education at the secondary/high school level, 40.4% have associate degrees, 36.7% are undergraduate, 6.3% are graduates and 14.3% doctorate level 70.5% of the participants are students, 10.5% are administrative staff, and 19% are academic staff. 51.8% of them have an income less than 2,800, 9.1% is between 2,801-5,000, 5.6% is between 5,001-7,500, 6.0% is between 7,501-10,000, 6.6%, 10,001-15,000, 12.8% of them have income between 15,001-20,000 and 8.0% of them have income of 20,001 and above. 49.3% of the participants stated that they have taken an economics or finance course at least once during their education or while taking it, and 50.7% have not. Fifty-one people from the Faculty of Engineering and Natural Sciences, 50 people from the Faculty of Health Sciences, 37 people from the Faculty of Art- Design and Architecture, 74 people from the Faculty of Social and Human Sciences, 25 people from the Faculty of Medicine, 42 people from the Faculty of Agriculture, 32 people from the Akçadağ Vocational School, 143 people

from Arapgir Vocational School, 40 people from Battalgazi Vocational School, ten people from Darende Bekir Ilıcak Vocational School, 13 people from Doğanşehir Vahap Küçük Vocational School, 45 people from Hekimhan Mehmet Emin Sungur Vocational School, 34 people from Kale Tourism and Hotel Management Vocational School, 15 people from Health Services Vocational School, 18 people from Yeşilyurt Vocational School, four people from the School of Civil Aviation, three people from the School of Foreign Languages and 43 people from other units (Rectorate, Library, etc.). 5% of the participants use credit cards, 50.5% use debit cards and 44.5% use both cards. When evaluating the correct use of debit/credit cards, 5.3% of the participants gave themselves 1 point, 7.2% 2 points, 28.1% 3 points, 27.8% 4 points and 31.5% 5 points.

Table: 1
Findings Regarding the Demographic Characteristics of the Participants

Demographic Features		Frequency	Percentage	Demographic Features		Frequency	Percentage
<i>Gender</i>	Female	370	54,5	<i>Your Unit/Faculty/Vocational School</i>	Faculty of Engineering and Natural Sciences	51	7,5
	Male	309	45,5		Faculty of Health Sciences	50	7,4
	Total	679	100,0		Faculty of Art, Design and Architecture	37	5,4
<i>Age</i>	18-26	440	64,8		Faculty of Social Sciences and Humanities	74	10,9
	27-42	160	23,6		Medical School	25	3,7
	43-57	75	11,0		Faculty of Agriculture	42	6,2
	57 and over	4	0,6		Akçadağ Vocational School	32	4,7
	Total	679	100,0		Arapkir Vocational School	143	21,1
<i>Your education status</i>	Secondary/ high school	16	2,4		Battalgazi Vocational School	40	5,9
	Associate Degree	274	40,4		Darende Bekir Ilıcak Vocational School	10	1,5
	Undergraduate	249	36,7		Doğanşehir Vahap Küçük Vocational School	13	1,9
	Degree	43	6,3		Hekimhan Mehmet Emin Sungur Vocational School	45	6,6
	Is it graduate?				Kale Turizm ve Otel İşletmeciliği Vocational School	34	5,0
	Doctorate	97	14,3		Sağlık Hizmetleri Vocational School	15	2,2
<i>Job</i>	Total	679	100,0		Yeşilyurt Vocational School	18	2,7
	Student	479	70,5		School of Civil Aviation	4	,6
	Administrative Staff	71	10,5		School of Foreign Languages	3	,4
	Academical Staff	129	19,0		Others (Rectorate, Library, etc.)	43	6,3
<i>Your income level (TL) (based on your monthly individual income) (Minimum wage was 5,500 TL at the time of data collection.)</i>	Total	679	100,0		Total	679	100,0
	Less than 2800	352	51,8	Credit card	34	5,0	
	2801-5000	62	9,1	ATM card/Debit card	343	50,5	
	5001- 7500	38	5,6	Both of them	302	44,5	
	7501-10.000	41	6,0	Total	679	100,0	
	10.001-15.000	45	6,6	1	36	5,3	
	15.001-20.000	87	12,8	2	49	7,2	
	20.001 and over	54	8,0	3	191	28,1	
Total	679	100,0	4	189	27,8		
<i>Have you taken or are taking an economics or finance course at least once during your education life?</i>	Yes	335	49,3	5	214	31,5	
	No	344	50,7	Total	679	100,0	
	Total	679	100,0				
				<i>The card you use</i>			
				<i>When you evaluate your correct use of debit/credit cards, what score would you give yourself a minimum of 1 and a maximum of 5?</i>			

3.5. Factor Analysis

Factor analysis is a multivariate analysis technique that can reduce a large number of variables to a small number based on the relationships between the variables (Güven et al., 2022). Factor analysis is used to determine the structure and dimensions of latent, which is variable in measurements by using a wide variety of variables (İslamoğlu & Alınacı, 2016). KMO and Bartlett's tests are applied to test the suitability of the variables for factor analysis. If the KMO coefficient is greater than 0.5, factor analysis is applied. Bartlett's test of sphericity tests whether there is a general relationship between the variables included in the analysis using the correlation matrix for the data. If the test result is less than 0.05, it is interpreted that there are relations between the variables suitable for factor analysis.

As a result of the KMO and Bartlett's tests performed on the responsibility consciousness scale, the KMO value was 0.916, and Bartlett's value was 0.000. These results show that the sample value of the study is suitable for factor analysis. The Cronbach alpha value of the scale is 0.920. The factor loads, eigenvalues, explained variances and mean values of the participants' expressions of responsibility consciousness are given in Table 2.

Table: 2
Consciousness of Responsibility Factor Analysis

CONSCIOUSNESS OF RESPONSIBILITY	Factor Load	Eigenvalue	Explained Variance	Average
"I am always cautious."	0,829	4,293	71,552	3,8834
"I pay attention to details."	0,855			
"I like to take responsibility."	0,849			
"I like to be organised."	0,872			
"I work programmatically."	0,786			
"I am meticulous in my work."	0,881			
KMO and Bartlett's Test				
Kaiser-Meyer-Olkin Measure of Sampling Adequacy.			0,916	
Bartlett's Test of Sphericity			Approx. Chi-Square	2753,929
			df	15
			Sig.	0,000
SCALE RELIABILITY			Cronbach's Alpha	0,920
Variables with loading rates of less than 40% were excluded from the evaluation.				

As a result of factor analysis, factors with an eigenvalue greater than one according to Kaiser Normalization were considered. As a consequence of the analysis, it was determined that the scale related to the consciousness of responsibility consisted of a single factor. The total percentage of variance of the study is 71,552. Since this ratio is greater than 0.50, the analysis is statistically valid.

As a result of the KMO and Bartlett's tests performed on the utilitarian consumption scale, the KMO value was 0.896, and Bartlett's value was 0.000. These results show that the sample value of the study is suitable for factor analysis. The Cronbach alpha value of the scale is 0.912. The factor loads, eigenvalues, explained variances and mean values of the participants' expressions for utilitarian consumption are given in Table 3.

Table: 3
Utilitarian Consumption Factor Analysis

UTILITARIAN CONSUMPTION	Factor Load	Eigenvalue	Explained Variance	Average
"While shopping, I am only interested in the product(s) I went out to buy."	,741	5,008	62,596	3,7263
"I complete what I need/need?? to buy as soon as possible and finish my shopping."	,800			
"In my online shopping, I am only interested in the product/s I will buy."	,725			
"I go shopping knowing what I need."	,839			
"I take care to buy what I have planned in my shopping."	,854			
"I act in a controlled manner in my shopping preferences."	,859			
"Even if my financial situation is sufficient in my shopping preferences, I try to make sensible choices."	,790			
"It makes me feel good to make sensible choices in my shopping."	,706			
KMO and Bartlett's Test				
Kaiser-Meyer-Olkin Measure of Sampling Adequacy.				0,896
Bartlett's Test of Sphericity	Approx. Chi-Square		3522,315	
	df		28	
	Sig.		0,000	
SCALE RELIABILITY			Cronbach's Alpha	0,912
Variables with loading rates of less than 40% were excluded from the evaluation. "Even if a product I have does the job well enough, I can buy a new one." The question is reverse-coded. It was excluded from the analysis as there could not be a question under one dimension.				

As a consequence of factor analysis, factors with an eigenvalue greater than one according to Kaiser Normalization were considered. As a result of the analysis, it was determined that the scale related to utilitarian consumption consisted of 2 factors, but there was only one question under one dimension. Since there cannot be a single question in a dimension, the question "Even if a product I have works well enough, I can buy a new one." The analysis was renewed by deleting the question. It was determined that the scale consisted of only one factor. The total percentage of the variance of the study is 62,596. Since this ratio is greater than 0.50, the analysis is statistically valid. The dimension that emerged from the factor analysis was named "Utilitarian Consumption", in parallel with the study of Çoşkun & Marangoz (2019).

As a result of the KMO and Bartlett's tests performed on the rational expenditure scale, the KMO value was 0.948, and Bartlett's value was 0.000. These results show that the sample value of the study is suitable for factor analysis. The Cronbach alpha value of the scale is 0.901 in the dimension of rational spending habits without a credit card, and 0.940 in the rational use of credit cards. The factor loads, eigenvalues, explained variances and mean values of the participants' expressions for rational spending are given in Table 4.

As a consequence of factor analysis, factors with an eigenvalue greater than one according to Kaiser Normalization were considered. As a result of the analysis, it was determined that the scale related to rational spending consisted of two factors. The total percentage of variance of the study is 75,384. Since this ratio is greater than 0.50, the analysis is statistically valid. Two dimensions emerged as a result of factor analysis: Başaran et al. (2012) "Rational Spending Habits Without Credit Cards" and "Rational Use of Credit Cards".

Table: 4
Rational Expenditure Factor Analysis

RATIONAL SPENDING (Is it Expenditure or spending? The same expression should be used throughout the text for semantic integrity.)	Factor Load	Eigenvalue	Explained Variance	Average
Rational Spending Habits Without Credit Cards				
"I adjust my spending without a credit card (with a debit card) according to my budget."	0,787	4,569	41,535	4,0454
"When I spend without a credit card (with a debit card), I pay attention to the price of the products I buy."	0,824			
"I try not to spend insignificant types without a credit card (with a debit card)."	0,828			
"I try not to get into excessive debt on my credit card (debit card) expenses."	0,792			
"I plan my spending without a credit card (with a debit card) in advance."	0,582			
Using the Credit Card Rationally				
"I calculate how much my credit card debt will come."	0,805	3,723	33,849	3,9126
"I consider my credit card limit when shopping with a credit card."	0,730			
"I use my credit card after comparing it to other payment methods."	0,813			
"If I use cash with my credit card, I calculate the cost in advance."	0,830			
"I check the interest rate for my credit card debt."	0,835			
"When I shop with my credit card, I consider my previous instalments."	0,804			
KMO and Bartlett's Test				
Kaiser-Meyer-Olkin Measure of Sampling Adequacy.		0,948		
Bartlett's Test of Sphericity	Approx. Chi-Square	6181,535		
	df	55		
	Sig.	0,000		
SCALE RELIABILITY		Cronbach's Alpha	Rational Spending Habits Without Credit Cards	0,901
			Using the Credit Card Rationally	0,940
Variables with loading rates of less than 40% were excluded from the evaluation.				

3.6. Serial Mediation Effect Analysis

With mediation analysis, researchers ask "How?" and try to find the answer. The mediating effect variable, which is the M variable, helps to explain the effect of the independent variable (X) on the dependent variable (Y) (Bozkurt, 2021). Although the research model with a single mediating variable is the simplest mediation model, models with mediating variables are not the only ones. There are also multiple mediator models in which more complex relationships are examined. These models contain two or more M (M1, M2,...) connecting X and Y. It can be developed differently. The first ones are models that are causally independent of each other and work in parallel (parallel multiple mediation model). The second models create a causal chain from X to Y and work in series. A parallel multiple mediator variable means two or more parallel mediating variables between one or more independent variables (X) and the dependent variable (Y). A relationship between these mediating variables is expected, although not very strong, as they share a common cause. On the other hand, the serial multiple mediation model refers to a linked chain model consisting of at least two mediating variables (such as X→M1→M2→Y) between X and Y, containing three or more paths. In the serial multiple mediation model type, if the mediating variables are causally arranged in an order, M1 must causally precede M2 (Çelik, 2022).

A regression analysis based on the Bootstrap method was conducted to test whether the participants' consciousness of responsibility (X) has a mediating role in the effect of utilitarian consumption (Y), rational spending habits without credit cards (M1) and rational use of credit cards (M2). It is claimed that this method gives more reliable results than the traditional method of Baron & Kenny (1986) and the Sobel test. Analyses were performed

using the Process Macro developed by Hayes. The Bootstrap technique with 5000 resampling and 95% confidence interval options, PROCESS Model 6 (serial mediation), was used in the analysis. In mediation effect analyses were performed using the bootstrap technique, the values in the 95% confidence interval obtained as a result of the study should not contain the zero value to support the research hypothesis (Gürbüz, 2021).

Table: 5
Serial Mediation Analysis of Rational Spending in the Effect of Consciousness of Responsibility on Utilitarian Consumption

Model: 6							
Y: Utilitarian Consumption							
X: Responsibility Consciousness							
M1: Rational Spending Habits Without Credit Cards							
M2: Using the Credit Card Rationally							
Sample: 679							
	coeff	se	t	p	LLCI	ULCI	Hypothesis Accepted/Rejected
a1 way	.5492	.0326	16.8562	.0000	.4853	.6132	H1 Accepted
a2 way	.1608	.0338	4.7553	.0000	.0944	.2273	H2 Accepted
d21 way	.7386	.0335	22.0607	.0000	.6729	.8044	H3 Accepted
c' way	.1823	.0332	5.4898	.0000	.1171	.2475	H4 Accepted
b1 way	.3855	.0424	9.0904	.0000	.3022	.4687	H5 Accepted
b2 way	.1794	.0371	4.8293	.0000	.1064	.2523	H6 Accepted
	Effect	se	t	p	LLCI	ULCI	
c: total effect	.4956	.0326	15.2231	.0000	.4317	.5596	H7 Accepted
Indirect effect(s) of X on Y:			Effect	BootSE	BootLLCI	BootULCI	
Indirect effect 1: a ₁ b ₁			.2117	.0363	.1421	.2833	H8 Accepted
Indirect effect 2: a ₂ b ₂			.0289	.0104	.0119	.0520	H9 Accepted
Indirect effect 3 (serial mediation effect): a ₁ d ₂₁ b ₂			.0728	.0192	.0365	.1132	H10 Accepted
Indirect effect1- Indirect effect 2: a ₁ b ₁ - a ₂ b ₂			.1829	.0409	.1028	.2637	H11 Accepted
Indirect effect 1- Indirect effect 3: a ₁ b ₁ - a ₁ d ₂₁ b ₂			.1389	.0454	.0510	.2276	H12 Accepted
Indirect effect 2- Indirect effect 3: a ₂ b ₂ - a ₁ d ₂₁ b ₂			-.0439	.0151	-.0772	-.0177	H13 Accepted *

* To support the research hypotheses, the values in the confidence interval should not contain the zero value. Since both confidence intervals are negative, it has no zero value.

According to the results obtained as a result of the analysis made with PROCESS Model 6 in Table 5, path a₁ (Confidence Interval = 0.4853; 0.6132), path a₂ (Confidence Interval = 0.0944; 0.2273) path, d₂₁ path (Confidence Interval = 0.0944; 0.2273) Interval = 0.6729; 0.8044), path c' (Confidence Interval = 0.1171; 0.2475), path b₁ (Confidence Interval = 0.3022; 0.4687), path b₂ (Confidence Interval = 0.1064; 0.2523) and c path (Confidence Interval = 0.4317; 0.5596), since the confidence intervals did not contain zero values, hypotheses **H1**, **H2**, **H3**, **H4**, **H5**, **H6** and **H7** were accepted.

Rational spending habits without credit cards (M1) (Confidence Interval = 0.1421; 0.2833) and rational use of credit cards (M2) (Confidence Interval = 0.0119; 0.0520) have a mediating role between responsibility consciousness and utilitarian consumption. Because the confidence intervals of both mediating variables do not contain zero values. Therefore, hypotheses **H8** and **H9** were accepted. According to the results, the consciousness of responsibility affects utilitarian consumption serially (one after the other) through the rational use of credit cards and rational spending habits without credit cards. Therefore, the **H10** hypothesis was accepted. The indirect effect of responsibility consciousness on utilitarian consumption through the rational use of credit cards is statistically different from that of responsibility consciousness on utilitarian consumption through rational spending

habits without credit cards. Because confidence intervals (Confidence Interval = 0.1028; 0.2637) do not contain zero value. Therefore, the **H11** hypothesis was accepted. The indirect effect of responsibility consciousness on utilitarian consumption through the rational use of credit cards is statistically different from the serial (rational spending habits without credit card → rational use of credit card) indirect effect of responsibility consciousness on utilitarian consumption. Because confidence intervals (Confidence Interval = 0.0510; 0.2276) do not contain zero value. Therefore, the **H12** hypothesis was accepted. The indirect effect of responsibility consciousness on utilitarian consumption through rational spending habits without credit cards is statistically different from the serial (rational spending habits without credit card → rational use of credit card) indirect effect of responsibility consciousness on utilitarian consumption. Because confidence intervals (Confidence Interval = -0.0772; -0.0117) do not contain zero value. Therefore, the **H13** hypothesis was accepted.

4. Conclusion

Individuals have to consume to survive. As a result of the change and transformation of the social structure, some changes have occurred in the lifestyles and behaviours of consumers over time (Buğday et al., 2020; <<https://bkm.com.tr/>>). These changes are affected by demographic, social, political, economic and psychological factors and temporal or ideological variables (Akdoğan, 2018). As a result of these changes, which are affected by many factors, the use of debit and credit cards to finance changing expenditures has also increased (<<https://bkm.com.tr/>>).

While meeting the basic needs in traditional society is a leading goal, demands have evolved into needs in modern society. As a result, consumption expenditures have increased (Buğday et al., 2020). According to Ajzen and Fishbein (1975), individuals analyse the content of their actions before performing a specific behaviour, generally act rationally and use information systematically through a logical filter (Buğday & Babaoğlu, 2016). Individuals with a limited income level need to spend their income responsibly. Economic and financial decisions have positive and negative long-term effects on individuals and society (Tetik & Albulut, 2022). In healthy, liveable societies and communities of the world, responsible, ethical, customer and environmental behaviour owners have important duties as well as businesses (Buğday & Babaoğlu, 2016).

Developing conscious, rational and benefit-oriented consumption behaviour will be possible with small changes that will take place in concrete behaviour and by changing the mindset about consumption in the abstract (Buğday & Babaoğlu, 2016). For this change, educational institutions, universities, research centres, non-governmental organisations, media, government and relevant public institutions have an important role in raising awareness of the society (Lim et al., 2014; Buğday & Babaoğlu, 2016). The future of the world and all living things on earth depends on all individuals questioning their consumption behaviours and displaying their behaviours based on reason and logic in their consciousness (Buğday & Babaoğlu, 2016).

Financial literacy, with its shortest definition, is the ability of individuals to use money rationally (Tetik & Albulut, 2022). Financial information is key for making sound financial decisions and is essential for financial well-being. The dire consequences of the cost of financial illiteracy are likely to be reflected not only in individuals with low financial literacy but also in society. In the behavioural economics paradigm, individuals are generally rational and intelligent; mistakes or mistakes that can be called rational errors can be made while entering the decision-making process. Financially literate individuals, investment, savings, borrowing, etc., can make conscious financial choices on issues (Albulut, 2020). Similarly, demographic and situational factors may predispose individuals to debt (Norvitis et al., 2006). Norvitis et al. (2006), the increase in the probability of individuals who want to have many material things and have certain personality traits to buy without thinking causes an increase in their credit card debts (Norvitis et al., 2006).

While the "piggy bank", which was distributed by banks in the past, was seen as a savings symbol reminding a child not to spend all of his pocket money, today, the credit cards that replace the piggy bank have become a consumption symbol that encourages individuals to spend without earning (Ersoy & Nazik, 2006). Today's people cannot act rationally under the influence of many factors; they consume excessively beyond their needs, and as a result, they become overly indebted (Buğday et al., 2020). Consumption is seen as a symbol of social status. People must borrow money or work long hours to gain social status by consuming a lot. People who want to eliminate this pressure of social life need to redefine their consumption styles and move towards responsible consumption (Jain et al., 2022).

Rungtusanatham (2001) and Sarkis et al. (2010) attempted to theorise mediation models using the communicative approach, while Zhou et al. (2011) and Wu et al. (2010) segmentation approach was used. Within the scope of this research, a new model was constructed, and a segmentation approach was used to determine the mediating effect of Rational Spending on the Effect of Responsibility Consciousness on Utilitarian Consumption. In this context, 13 hypotheses were selected for this study due to the literature review based on the model constructed by the researchers. According to some studies in the literature, the consciousness of responsibility affects utilitarian consumption (Guido, 2006; Guido et al., 2007; Guido et al., 2008; Ekber & Gurbanova, 2021; Karl et al., 2007; Chen & Lee, 2008; Gohary & Hanzae, 2014; Alhad, 2021). Similar to these studies, it was concluded that the consciousness of responsibility affects utilitarian consumption. In the literature, it is supposed that there is a positive relationship between responsibility consciousness and rational behaviour (Uslu-Divanoğlu & Uslu, 2019), responsibility consciousness affects money management (Donnelly et al., 2012), and responsibility has a negative effect on the probability of having credit card debt (Choi & Laschever, 2018). While some studies have reached the end of the year, it has been determined in this study that the consciousness of responsibility affects rational spending without credit cards and the rational use of credit cards. Kuruppuge et al. (2017) supported the view that credit card use depends not only on economic factors but also on socioeconomic, individual financial willingness, and behavioural and psychological characteristics of individuals and groups (Kuruppuge et al., 2017). Ünal et al. (2015) concluded that rational spending habits without

credit cards affect rational credit card use and that rational spending habits without credit cards affect the rational use of credit cards. Lim et al. (2014), debit cards reduce overspending as they are limited to how much money the owner has in their bank account. Thus, the individual will use his credit card rationally, avoiding spending more than he can afford based on his bank balance (Lim et al., 2014). In addition, Lim et al. (2014) suggest that consumers should think well before using their cards, and if they have a budget, they should apply for a debit card instead of a credit card to avoid overspending (Lim et al., 2014). Bayır (2021) found in his study that utilitarian consumption affects uncontrolled credit card use. This study concluded that rational spending habits without credit cards and rational use of credit cards affect utilitarian consumption.

Mediator variable (M) helps to understand how and why the relationship between independent and dependent variables occurs (Gürbüz, 2021: 49). According to the findings of the study, it can be said that responsible consumers consume with a utilitarian understanding of duty (Türk 2018), and rational and rational attitude (Raian, 2020; Köroğlu & Yıldız, 2019) increases the effect of responsible personality on utilitarian consumption. In other words, it is insufficient for individuals to have only responsible personalities for utilitarian consumption behaviour. In addition to responsible personality, it can be said that individuals supported by economic and financial literacy awareness will consume by considering more benefits for themselves, society and the world.

To save individuals, societies and the dangers from the world that wait as a result of unconscious and irresponsible consumption, it is necessary to provide individuals with responsible personalities (Ekber & Şahin, 2021; Uslu-Divanoğlu & Uslu, 2019; Solunoğlu & Naçacı-İkiz, 2020). Responsibility is a human value as well as a personality trait. To bring this value to individuals, families, educational institutions, and non-governmental organisations should work. In addition to responsible personality, it is necessary to increase the financial, economic and environmental literacy levels to enable individuals to gain conscious consumption (Albulut, 2020; Guido, 2006).

Consumers' different personality traits lead to other purchasing behaviours (Yıldız & Kırmızıbiber, 2020: 503). There is less likelihood of excessive and wasteful consumption as there is financial success, savings and planning for responsible people (Dayı & Çetin, 2021: 1248; Terzi & Bayrakdaroğlu, 2022: 538; Özhan & Akkaya, 2018: 113). In individuals with irresponsible personality traits, the rate of excessive and wasteful consumption is high, and as a result of this situation, the rate of unpaid debt is also high (Terzi & Bayrakdaroğlu, 2022: 525; Köktürk & Çağlar-Çetinkaya, 2020: 57). Therefore, all institutions that may take part in the card payment system, such as businesses, consumer associations, government institutions, non-governmental organisations, banks and member businesses, must show the necessary sensitivity to prevent increasing uncontrolled consumption trends (Terzi & Bayrakdaroğlu, 2022: 539; Başaran et al., 2012: 89). Public institutions should support all individuals to improve their financial literacy levels (Apan & Ercan, 2017: 192). This situation can be combated with training and awareness programs (Aliçavuşoğlu & Poyraz, 2019: 1811; Gül, 2021). Since it is relatively more common in young individuals, people in

this age group can be given training on conscious consumption and effective use of their financial resources (Terzi & Bayrakdaroğlu, 2022: 539).

In a world where the social marketing approach dominates, businesses' activities that encourage consumers to buy more will not be welcomed by society (Terzi & Bayrakdaroğlu, 2022: 539-540). Marketing ethics, public service announcements, expert support, brochures, and state-supported therapies and treatments will be important in eliminating the negative consequences of purchasing. Instead of turning this negative situation into an opportunity, it is recommended to develop strategies based on healthy consumption, long-term relationships and constantly happy customers rather than momentary ones (Aliçavuşoğlu & Poyraz, 2019: 1811). Advertisers and marketing managers can use the findings from this study to develop advertisements that encourage the responsible use of credit cards. Socially responsible companies will benefit by emphasising the importance of rational and responsible use of credit cards in their advertisements, especially to young consumers who have just started using credit cards (Palan et al., 2011: 92). Although the ultimate responsibility for this task falls on the individual, it is clear that individual needs help in understanding the nature of the problem, its consequences, and ways to overcome, if not eliminate (Pirog & Roberts, 2007: 72-73). The spending habits of people without a credit card directly affect the rational use of credit cards. This shows that rationality in card use is closely related to how a person behaves in economic decisions (Başaran et al., 2012: 86-89).

In general, awareness of responsibility among academicians, students, and administrative staff affects rational spending without a credit card, rational use of credit cards and utilitarian consumption. Rational spending and utilitarian consumption with or without a credit card with a sense of responsibility will undoubtedly reduce the environmental damage caused by all kinds of production and consumption activities. Because people with a high awareness of responsibility purchase products that will benefit both the individual and society. Therefore, it can be said that although individuals' budgets are suitable for all kinds of consumption activities, their rational attitudes and awareness of responsibility direct them to utilitarian consumption. In other words, "Will the green of nature or the green of the dollar win?" The answer to the question will be answered by individuals' level of responsibility awareness (<https://www.dunya.com/>) - sustainability guarantees not only current and near-future development but also continuous development in the long term. The Native American proverb "We did not inherit this world from our ancestors; we borrowed it from our children" reveals the responsibility regarding sustainability.

Although the research reveals the role of rational spending in the effect of responsibility awareness on utilitarian consumption, it has some limitations. However, these limitations provide a basis for future research. Firstly, due to time and cost constraints, the fact that the research only included students and academic and administrative staff working at Malatya Turgut Özal University limits the generalizability of the results. In addition, the fact that the study covers consumers in Turkey, a developing country, not only contributes to the literature but also offers opportunities for comparison with other countries. In the

future, studies can be conducted with data obtained from different provinces and countries to compare the results of this study. Additionally, this study focuses on the effect of responsibility awareness, one of the dimensions of the five-factor personality model, on utilitarian consumption. In future studies, it will be important to address other personality factors and awareness of responsibility.

References

- Abrantes-Braga, F.D.M. & T. Veludo-de-Oliveira (2020), "Help me, I can't afford it! Antecedents and consequence of risky indebtedness behaviour", *European Journal of Marketing*, 54(9), 2223-2244.
- Açıklım. S. & M. Yaşar (2017), "Hedonik ve faydacı tüketim bağlamında tüketici davranışlarının incelenmesi: gençlerin hedonik tüketim eğilimlerini belirlemeye yönelik bir araştırma", *Uluslararası Sosyal Araştırmalar Dergisi*, 48(10), 570-585.
- Ahmetoğulları, K. & H. Parmaksız (2017), "Finansal iyilik halinin finansal okuryazarlık ve kredi kartı tutumuyla ilişkisi", *Akademik Sosyal Araştırmalar Dergisi*, 5(48), 317-330.
- Akdoğan, Ç. (2018), "Sorumlu tüketim ve üretim hedefleri kapsamında sürdürülebilir pazarlamanın değerlendirilmesi", *IBANESS Konferans Serisi - Tekirdağ / Türkiye*, 217-228.
- Akıpek, Ş. (2003), "Tüketicinin korunması hakkında kanun çerçevesinde kredi kartları", *AÜHF Dergisi*, 52(3), 103-119.
- Alan, A.K. et al. (2017), "Why do consumers make online shopping the effect of big five personality traits, narcissism and self-esteem", *Journal of Global Strategic Management*, 11(2), 5-20.
- Albulut, İ.İ. (2020), "Üniversite Öğrencileri İçin Ortak Finansal Okuryazarlık Ölçeği Geliştirme Çalışması: İnönü Üniversitesi Örneği", *Yüksek Lisans Tezi*, İnönü Üniversitesi Sosyal Bilimleri Enstitüsü, Malatya.
- Alhad, M.A. (2021), "Apakah kepribadian anda mempengaruhi anda dalam berbelanja? mengkaji hedonic dan utilitarian shopping value dari sudut pandang big-five personality", *Jurnal Talenta*, 10(1), 36-46.
- Aliçavuşoğlu, Ç. & E. Boyraz (2019), "Takıntılı Tüketim: Tek Ürüne Yönelik Kompulsif Satın Alma Davranışı", *Manas Sosyal Araştırmalar Dergisi*, 8(2), 1800-1814.
- Altan, M. & İ.E. Göktürk (2007), "Türkiye'de kredi kartlarının toplam özel nihai tüketim harcamalarına etkisi: bir çoklu regresyon analizi", *Selçuk Üniversitesi Sosyal Bilimler Enstitüsü Dergisi*, (18), 25-47.
- Altuğ, Y. (2019), "Türk Ceza Hukukunda Banka veya Kredi Kartlarının Kötüye Kullanılması Suçu", *Yüksek Lisans Tezi*, Marmara Üniversitesi Sosyal Bilimler Enstitüsü, İstanbul.
- Apan. M. & S. Ercan (2017), "Beş Faktör Kişilik Özelliklerinin Finansal Okuryazarlık Üzerine Etkisinin Yol Analizi İle Belirlenmesi: Lisans Düzeyindeki İşletme Öğrencileri Üzerine Bir Araştırma", *Bartın Üniversitesi İktisadi ve İdari Bilimler Fakültesi Dergisi*, 8(16), 177-202.
- Awanis, S. & C.C. Cui (2013), "Consumer susceptibility to credit card misuse and indebtedness", *Asia Pacific Journal of Marketing and Logistics*, 26, 408-429.

- Aydın, S. (2019), "Otomobil Tercihlerinde Marka İmajı ve Sosyal Medyanın Hedonik Tüketim Davranışlarına Etkileri", *Yüksek Lisans Tezi*, İstanbul Üniversitesi Sosyal Bilimler Enstitüsü, İstanbul.
- Babin, B.J. et al. (1994), "Work and/or fun: measuring hedonic and utilitarian shopping value", *Journal of Consumer Research*, 20(4), 644-656.
- Bahtiyar, M. (2014), "Banka Kartları Ve Kredi Kartları Kanunu'na Göre Kartın Haksız Kullanımından Dolayı Hukuki Sorumluluk", *Journal of Istanbul University Law Faculty*, 71(2), 71-89.
- Bakiyem (2022), *Banka kartı ile kredi kartı arasındaki fark*, <<https://www.bakiyem.com/blog/banka-karti-ile-kredi-karti-arasindaki-fark>>, 20.12.2022.
- Bamforth, J. et al. (2017), "Undergraduates' Responses To Factors Affecting Their Money Management Behaviour: Some New Insights From A Qualitative Study", *Young Consumers*, 18(3), 290-311.
- Barbić, D. et al. (2019), "Measuring Responsible Financial Consumption Behaviour", *International Journal of Consumer Studies*, 43(1), 102-112.
- Başaran, B. et al. (2012), "Kredi kartlarının rasyonel kullanımını etkileyen bireysel faktörler", *Eskişehir Osmangazi Üniversitesi İİBF Dergisi*, 7(2), 68-69-70.
- Bayır, T. (2021), "Hedonik ve faydacı tüketim ile kompulsif satın alma ilişkisinde kredi kartı kullanımı ve pişmanlık: Online pazar yerleri üzerine bir araştırma", *Mehmet Akif Ersoy Üniversitesi İktisadi ve İdari Bilimler Fakültesi Dergisi*, 8(1), 420-441.
- Bevill, S. & L.R. Dale (2006), "Students and misuse of credit", *Proceeding of the Academy of Educational Leadership*, 11, 33-36.
- BKM Bankalararası Kart Merkezi (2022), <<http://www.bkm.com.tr/raporlar-ve-yayinlar/donemsel-bilgiler/>>, 20.11.2022.
- Bozkurt, S. (2021), *Pazarlama alanında en sık kullanılan Process makro modellerinin veri setleriyle incelenmesi*, Ekin Yayınevi.
- Brito, D.L. & P.R. Hartley (1995), "Consumer Rationality and Credit Cards", *Journal of Political Economy*, 103(2), 400-433.
- Buchanan, D.A. & A. Huczynski (2003), *Organizational Behaviour: An Introductory Text*, Fifth Edition, Financial Times Management.
- Buğday, E.B. & M. Babaoğlu (2016), "Bilinçli tüketim kavramının boyutları: bilinçli tüketim davranışının yeniden tanımlanması", *Sosyoekonomi*, 24(30), 187-206.
- Buğday, E.B. et al. (2020), "Tüketicilerin bireysel kredi kullanım davranışlarının analizi", *İşletme Araştırmaları Dergisi*, 12(2), 1130-1148.
- Camgöz, S.M. (2009), "Kişilik özellikleri ile finansal performans arasındaki ilişkiler: a tipi yatırım fonu yöneticileri üzerinde bir değerlendirme", *Doktora Tezi*, Hacettepe Üniversitesi Sosyal Bilimler Enstitüsü, Ankara.
- Çelebi, Ş.O. & F. Bayrakdaroğlu (2018), "Y Kuşağı Tüketicilerinin Bilinçli Tüketim Davranışları Üzerine Bir Araştırma", *Girişimcilik İnovasyon ve Pazarlama Araştırmaları Dergisi*, 2(4), 111-124.
- Çelik, F. (2022), "Davranışsal iletişim araştırmalarında aracılık testine genel bir bakış", *Selçuk Üniversitesi Sosyal Bilimler Enstitüsü Dergisi*, (49), 392-410.

- Chang, E. (2002), "The mediating role of shopping value in apparel shopping satisfaction", *PhD Dissertation*, Oregon State University.
- Chen, S.H. & K.P. Lee (2008), "The role of personality traits and perceived values in persuasion: an elaboration likelihood model perspective on online shopping", *Social Behavior and Personality: An International Journal*, 36(10), 1379-1399.
- Choi, H.S. & R.A. Laschever (2018), "The credit card debt puzzle and noncognitive ability", *Review of Finance*, 22(6), 2109-2137.
- Çopuroğlu, F. & F. Çayırağası (2022), "Tüketicilerin karara varma ihtiyacının hedonik ve faydacı tüketime etkisi", *JOEEP: Journal of Emerging Economies and Policy*, 7(1), 198-210.
- Coşkun, T. & M. Marangoz (2019), "Hedonik ve faydacı tüketim davranışları ölçeğinin geliştirilmesi: güvenilirlik ve geçerlik çalışması", *Business and Economics Research Journal*, 10(2), 517-540.
- Coşkun, T. (2019), "Hedonik ve faydacı tüketim davranışları ile tüketici etnosentrizmi arasındaki ilişki: kuşaklara yönelik bir araştırma", *Doktora Tezi*, Muğla Sıtkı Koçman Üniversitesi Sosyal Bilimler Enstitüsü.
- Dayı, F. & Z.N. Çetin (2021), "Kişilik Özelliklerinin Bireylerin Finansal Tutumları Üzerindeki Rolü", *Gümüşhane Üniversitesi Sosyal Bilimler Dergisi*, 12(3), 1234-1251.
- Deniz, A. & A. Erciş (2011), "Kişilik özellikleri, hedonik ve rasyonel fayda, marka duygusu ve marka bağlılığı arasındaki ilişkilerin belirlenmesine yönelik bir araştırma", *Atatürk Üniversitesi İktisadi ve İdari Bilimler Dergisi*, 24(2), 141-165.
- Doğan, M. et al. (2019), "Tüketicilerin Kişilik Özellikleri ile Finansal İyilik Hâli ve Risk Alma Tutumu Arasındaki İlişki", *Selçuk Üniversitesi Sosyal Bilimler Meslek Yüksekokulu Dergisi*, 22(2), 903-913.
- Donnelly, G. et al. (2012), "The big five personality traits, material values, and financial well-being of self-described money managers", *Journal of Economic Psychology*, 33(6), 1129-1142.
- Dülger, M.V. (2013), *Bilişim Suçları ve İnternet İletişim Hukuku*, Ankara: Seçkin Yayınevi.
- Dünya (2023), *Doğanın Yeşili mi, Doların Yeşili mi?*, <<https://www.dunya.com/kose-yazisi/doganin-yesili-mi-dolarin-yesili-mi/8489>>, 11.10.2023.
- Durmuş, H. (2022), "Aşırı tüketim ve israf; çözüm olarak orta yollu tüketim", *International Journal of Islamic Economics and Finance Studies*, 8(3), 272-298.
- Ekber, Ş. & Z. Gurbanova (2021), "Kişilik özelliklerinin faydacı ve hedonik tüketim davranışı üzerindeki etkisi", *Anadolu Üniversitesi İktisadi ve İdari Bilimler Fakültesi Dergisi*, 22(2), 1-14.
- EkoIQ (2023), *İklim Krizinde Dönüşü Olmayan Bir Aşamaya Yaklaştık*, <<https://www.ekoIQ.com/iklim-krizinde-donusu-olmayan-bir-asamaya-yaklastik/>>, 27.06.2023.
- Ersoy, S. & M.H. Nazik (2006), "Ergenlerde tüketicilik bilinç düzeyi üzerine bir inceleme", *Selçuk Üniversitesi Sosyal Bilimler Enstitüsü Dergisi*, (16), 313-328.
- Faber, R.J. & T.C. O'Guinn (1992), "A clinical screener for compulsive buying", *Journal of Consumer Research*, 19(3), 459-469.
- Gohary, A. & K.H. Hanzaae (2014), "Personality traits as predictors of shopping motivations and behaviors: a canonical correlation analysis", *Arab Economic and Business Journal*, 9(2), 166-174.

- Goldberg, L.R. (1992), "The development of markers for the big-five factor structure", *Psychological Assessment*, 4(1), 26-42.
- Guido, G. (2006), "Shopping motives, big five factors, and the hedonic/utilitarian shopping value: an integration and factorial study", *Innovative Marketing*, 2(2), 57-67.
- Guido, G. et al. (2007), "Experimental shopping analysis of consumer stimulation and motivational states in shopping experiences", *International Journal of Market Research*, 49(3), 365-386.
- Guido, G. et al. (2008), "Livello di stimolazione e stato motivazionale nell'esperienza di shopping in due centri commerciali", *Giornale italiano di psicologia*, 35(1), 125-148.
- Guido, G. et al. (2015), "An Italian version of the 10-item Big Five Inventory: An application to hedonic and utilitarian shopping values", *Personality and Individual Differences*, 76, 135-140.
- Gül, Z. (2021), "Bireysel Banka Müşterilerinin Kişilik Özellikleri, Kredi Kartına Yönelik Tutumları, Kredi Kartı Tercihini Etkileyen Faktörler ve Aylık Kredi Kartı Kullanım Sıklıkları Arasındaki İlişkilerin İncelenmesi: Ankara İlindeki Katılım Banka Şubelerine Yönelik Bir Çalışma", *Doktora Tezi*, İstanbul Gelişim Üniversitesi, İşletme Anabilim Dalı.
- Gümüş, N. & E. Onurlubaş (2021), "Kişilik Özelliklerinin Süpermarketlerdeki Plansız Alışveriş Davranışlarına Etkisi: Bolu Örneği", *Düzce Üniversitesi Sosyal Bilimler Dergisi*, 11(1), 22-35.
- Gürbüz, S. & F. Şahin (2016), *Sosyal Bilimlerde Araştırma Yöntemleri*, Ankara: Seçkin Yayıncılık.
- Gürbüz, S. & F. Şahin (2017), *Sosyal Bilimlerde Araştırma Yöntemleri, Felsefe-Yöntem-Analiz*, Ankara: Seçkin Yayınları.
- Gürbüz, S. & M.E. Bayık (2021), "Aracılık Modellerinin Analizinde Yeni Yaklaşım: Baron ve Kenny'nin Yöntemi Hâlâ Geçerli Mi?", *Türk Psikoloji Dergisi*, 37(88), 1-14.
- Gürbüz, S. (2021), *Sosyal Bilimlerde Aracı, Düzenleyici ve Durumsal Etki Analizleri*, Ankara: Seçkin Yayıncılık.
- Güven, M.E. et al. (2022), "Akıllı telefon sektöründe ülke menşe ve öz saygının marka sadakatine etkisinde marka imajının aracılık rolü", *Güncel Pazarlama Yaklaşımları ve Araştırmaları Dergisi*, 3(1), 1-17.
- Hatipler, M. & N. Köksalan (2020) "Tüketim farkındalığı ve sürdürülebilir kalkınma", 4. *Asia Pacific International Congress on Contemporary Studies*.
- Hayta, A. (2009), "Sürdürülebilir Tüketim Davranışının Kazanılmasında Tüketici Eğitiminin Rolü", *Ahi Evran Üniversitesi Kırşehir Eğitim Fakültesi Dergisi*, 10(3), 143-151.
- İbrahimoglu, N. et al. (2013), "The relationship between personality traits and learning styles: a cluster analysis", *Asian Journal of Management Sciences and Education*, 2(3), 93-108.
- İslamoğlu, A.H. & Ü. Almaçık (2016), *Sosyal Bilimlerde Araştırma Yöntemleri*, İstanbul: Beta Yayınevi.
- Jain, V.K. et al. (2022), "Responsible consumption, consumer well-being, and environment", *International Journal of Social Ecology and Sustainable Development (IJSESD)*, 13(1), 1-18.
- Jorgensen, B.L. et al. (2017), "Financial Attitudes And Responsible Spending Behavior of Emerging Adults: Does Geographic Location Matter?", *Journal of Family and Economic Issues*, 38, 70-83.

- Karaca, Ş. & İ. Yemez (2020), "Tüketicileri Sosyal Sorumlu Tüketime Yönlendiren Faydacı ve Hedonik Güdülerin İncelenmesi", *Afyon Kocatepe Üniversitesi Sosyal Bilimler Dergisi*, 22(3), 771-785.
- Karaca, Ş. (2018), "Duyusal ve Bilişsel Güdülerin Sürdürülebilir Giysi Tüketim Davranışı Üzerindeki Etkisini İncelemeye Yönelik Bir Çalışma", *Selçuk Üniversitesi Sosyal Bilimler Enstitüsü Dergisi*, (40), 254-268.
- Karaca, Ş. (2019), "Bireysel Sosyal Sorumluluğun Bilinçli Tüketim Davranışı Üzerindeki Etkisini İncelemeye Yönelik Bir Çalışma", *Dokuz Eylül Üniversitesi Sosyal Bilimler Enstitüsü Dergisi*, 21(1), 147-172.
- Karamustafa, K. & D.M. Biçkes (2003), "Kredi kartı sahip ve kullanıcılarının kredi kartı kullanımlarını değerlendirmeye yönelik bir araştırma: Nevşehir örneği", *Sosyal Bilimler Enstitüsü Dergisi*, 15(2), 91-113.
- Karasar N. (2005), *Bilimsel Araştırma Yöntemi*, Ankara: Nobel Akademik Yayıncılık.
- Karl, K.A. et al. (2007), "Is fun for everyone? Personality differences in healthcare providers' attitudes toward fun", *Journal of Health and Human Services Administration*, 29(4), 409-447.
- Kaya, E. (2021), *Hızın Krizinden Yavaşlamaya: Hızlı Moda*, <https://www.researchgate.net/profile/ElifKaya4/publication/355700460_HIZIN_KRIZINDEN_YAVASLAMAYA_HIZLI_MODA_FROM_CRISIS_OF_THE_SPEED_TO_SLOWING_FASTFASHION/links/617a5594eef53e51e1f73ba4/HIZIN-KRIZINDEN-YAVASLAMAYA-HIZLI-MODA-FROM-CRISIS-OF-THE-SPEED-TO-SLOWING-FAST-FASHION.pdf>, 03.10.2023.
- Kennedy, B.P. (2013), "The Theory of Planned Behavior and Financial Literacy: A Predictive Model for Credit Card Debt?", *Dissertation*, Graduate College of Marshall University.
- Khandelwal, R. et al. (2022), "Compulsive buying behaviour of credit card users and affecting factors such as financial knowledge, prestige and retention time: a cross-sectional research", *Vision*, 26(2), 172-180.
- Kırcı, D.Ö.H. (2014), "Hedonik tüketim davranışları ve toplumsal etkileri", *Paradoks Ekonomi Sosyoloji ve Politika Dergisi*, 10(1), 80-100.
- Koç, Z. (2011), *TCK'nun 245. Maddesinde Düzenlenen Banka veya Kredi Kartlarının Kötüye Kullanılması*, İstanbul: On İki Levha Yayıncılık.
- Köker, N.E. & D. Maden (2012), "Hazcı ve faydacı tüketim bağlamında tüketicinin ürün temelli yenilikçiliği algılaması: Amprik bir araştırma", *İşletme Araştırmaları Dergisi*, 4(2), 94-121.
- Köktürk, O. & N.Ç. Çetinkaya (2020), "Kredi Kartı Sahipliğinde Tüketicilerin Tercihlerini Etkileyen Faktörler", *Selçuk Zirvesi 2. Uluslararası Sosyal Bilimler Kongresi*.
- Kölgeliler, Y.Ö. (2022), "1. Çevrimiçi ikinci el giysi alım-satım sitelerinin ekolojik sorunların çözümüne katkılarının sürdürülebilir tüketim bağlamında değerlendirilmesi: Hepci.com örneği", *International Journal of Economic and Administrative Academic Research*, 2(2), 1-22.
- Köroğlu, A. & S. Yıldız (2019), "Hedonik ve faydacı tüketimin elektronik pazarlama ve satın alma davranışı üzerine etkisi", *Gümüşhane Üniversitesi Sosyal Bilimler Dergisi*, 10(EkSayı), 351-365.

- Korur, M.G. & H.S. Kimzan (2016), "Kompulsif satın alma eğilimi ve alışveriş sonrası pişmanlık ilişkisinde kontrolsüz kredi kartı kullanımının rolü: Avm müşterileri üzerine bir araştırma", *Tüketici ve Tüketim Araştırmaları Dergisi*, 8(1), 43-71.
- Külter-Demirgüneş, B. (2016), "İnternet alışverişlerinde hedonik ve faydacı değer algılarının davranışsal sonuçları: e-sadakat ve ağızdan ağıza iletişim", *Kastamonu Üniversitesi İktisadi ve İdari Bilimler Fakültesi Dergisi*, (13), 246-269.
- Kurupuge, R.H. et al. (2017), "Credit cards as a determinant of social capital: A study of rational behaviour of urbanised consumers", *Ecoforum Journal*, 6(1), 1-7.
- Kuşçuoğlu-Yılmaz, Ş. (2018), "Kompulsif Satın Alma, Beş Faktör Kişilik Özellikleri, Kredi Kartı Kullanımı ve Kredi Kartına Yönelik Tutum Arasındaki İlişki: Dumlupınar Üniversitesi Örneği", *Yüksek Lisans Tezi*, Kütahya Dumlupınar Üniversitesi, Kütahya.
- Lee, M. et al. (2009), "Shopping value in online auctions: their antecedents and outcomes", *Journal of Retailing and Consumer Services*, 16(1), 75-82.
- Li, D. et al. (2009), "The Influence of Money Attitudes on Young Chinese Consumers' Compulsive Buying", *Young Consumers*, 10(2), 98-109.
- Lim, W.M. et al. (2014), "Understanding young consumer perceptions on credit card usage: Implications for responsible consumption", *Contemporary Management Research*, 10(4), 287-302.
- Lin, L. et al. (2019), "Determinants of Credit Card Spending and Debt of Chinese Consumers", *International Journal of Bank Marketing*, 37(2), 545-564.
- Liu, Y.-L. et al. (2019), "An Experimental Study of Consumption Orientations, Environmental Sustainability Advertising and Home-Sharing Adoption Intentions", *International Journal of Contemporary Hospitality Management*, 31(12), 4605-4627.
- Madhoun, N.E. & E. Bertin (2017), "Magic always comes with a price: Utility versus security for bank cards", *1st Cyber Security in Networking Conference (CSNet)*.
- Malatya Turgut Özal Üniversitesi (2023), *Kurumsal İstatistikler*, <https://obs.ozal.edu.tr/oibs/public_stats/index.aspx#>, 03.01.2023.
- McCrae, R.R. & O.P. John (1992), "An introduction to the five-factor model and its applications", *Journal of Personality*, 60(2), 175-215.
- Media4democracy (2023), *Kâğıtsız Sürdürülebilir Bir Gelecek*, <<https://media4democracy.org/news/kgitsiz-srdrllebilir-bir-gelecek>>, 21.06.2023).
- Merdan, K. & S. Okuroğlu (2016), "Kredi kartlarına getirilen taksit sınırlandırmasının tüketicinin harcama düzeyi üzerindeki etkisini ölçmeye yönelik bir uygulama (Trabzon-Gümüşhane-Bayburt örneği)", *Akademik Bakış Uluslararası Hakemli Sosyal Bilimler Dergisi*, (58), 342-366.
- Mowen, J.C. & N. Spears (1999), "Understanding compulsive buying among college students: a hierarchical approach", *Journal of Consumer Psychol.*, 8(4), 407-430.
- Niinimäki, K. (2010), "Eco-Clothing, Consumer Identity and Ideology", *Sustainable Development*, 18(3), 150-162.
- Norvitis J.M. et al. (2006), "Personality factors, money attitudes, financial knowledge and credit-card debt in college students", *Journal of Applied Social Psychology*, 36(6), 1395-1413.
- Overby, J.W. & E.J. Lee (2006), "The Effects of Utilitarian and Hedonic Online Shopping Value on Consumer Preference and Intentions", *Journal of Business Research*, 59(10), 1160-1166.

- Öz, S. & E. Tatlı (2021), "Kişilik özellikleri ile hedonik tüketim değerleri arasındaki ilişki üzerine bir inceleme", *İzlek Akademik Dergi*, 4(1), 16-44.
- Özdemir, Ş. (2020), "Tüketim karşıtı yeni yaşam biçimi köye dönüşün medyada sunumu: Yeni köylüler örneği", *Erciyes İletişim Dergisi*, 7(2), 833-852.
- Özhan, Ş. & D.T. Akkaya (2018), "Kişilik Özelliklerinin Kompulsif Satın Alma Eğilimi Üzerindeki Etkisi", *Anadolu Üniversitesi Sosyal Bilimler Dergisi*, 18(4), 101-116.
- Öztürk, E. (2019), *Kişilik Özelliklerinin Spor Markası Tercih Nedenleri Üzerine Etkisinin Araştırılması, Yüksek Lisans Tezi*, Muğla Sıtkı Koçman Üniversitesi, Muğla.
- Palan, K.M. et al. (2011), "Compulsive Buying Behavior in College Students: The Mediating Role of Credit Card Misuse", *Journal of Marketing Theory and Practice*, 19(1), 81-96.
- Parlar, A. (2015), *Türk Ceza Hukukunda Bilişim Suçları*, Ankara: Bilge Yayınevi.
- Peabody, D. & L.R. Goldberg (1989), "Some determinants of factor structures from personality-trait descriptors", *Journal of Personality and Social Psychology*, 57(3), 552-567.
- Pereira, M.C. & F. Coelho (2019), "Mindfulness, Money Attitudes, And Credit", *Journal of Consumer Affairs*, 53(2), 424-454.
- Perry, S.R. (2003), "Big Five personality traits and work drive as predictors of adolescent academic performance", *Doctorate Dissertation*, The University of Tennessee, Knoxville.
- Pilatin, A. (2021), "Tüketicilerin kredi kartı kullanımını etkileyen faktörler: Ordu ili örneği", *Kahramanmaraş Sütçü İmam Üniversitesi Sosyal Bilimler Dergisi*, 18(2), 1400-1426.
- Pirog, S.F. & J.A. Roberts (2007), "Personality and Credit Card Misuse Among College Students: The Mediating Role of Impulsiveness", *Journal of Marketing Theory and Practice*, 15(1), 65-77.
- Polat, M. (2022), "Bireylerin hedonik ve faydacı tüketim eğilimlerinin ekonomik kazanım düzeyleri üzerindeki etkisi: kamu personeli üzerine ampirik bir uygulama", *Bingöl Üniversitesi İktisadi ve İdari Bilimler Fakültesi Dergisi*, 6(2), 381-412.
- Proskurnova, K.Y. et al. (2020), "The problem of unauthorized transactions of using bank cards as a payment instrument", *Advances in Social Science, Education and Humanities Research, Proceedings of the International Conference Digital Age: Traditions, Modernity and Innovations (ICDATMI 2020)* (489).
- Qnbfinansbank (2023), *Banka Kartı Nedir?, Kredi Kartı Nedir?*, <<https://www.qnbfinansbank.enpara.com/bilgi-bankasi/banka-karti-nedir-kredi-karti-nedir#:~:text=Kredi%20kartlar%C4%B1%2C%20al%C4%B1%2C%20al%C5%9Fveri%C5%9Fleri%20taksit%20kolayl%C4%B1%2C%20harcama%2C%20do%C4%9Frudan%20hesap%20bakiyenizden%20%C3%A7ekilir>>, 11.10.2023.
- Rajan, K.A. (2020), "Influence of hedonic and utilitarian motivation on impulse and rational buying behavior in online shopping", *Journal of Statistics and Management Systems*, 23(2), 419-430.
- Rasoolimanesh, S.M. et al. (2021), "Are we in right path for mediation analysis? Reviewing the literature and proposing robust guidelines", *Journal of Hospitality and Tourism Management*, 48, 395-405.
- Razzaq, Z. et al. (2018), "The Impact of Utilitarian and Hedonistic Shopping Values on Sustainable Fashion Consumption: The Moderating Role of Religiosity", *Global Business Review*, 097215091877794.

- Richins, M.L. (2011), "Materialism, transformation expectations, and spending: Implications for credit use", *Journal of Public Policy & Marketing*, 30(2), 141-156.
- Roberts, J.A. & E. Jones (2001), "Money attitudes, credit card use and compulsive buying among American college students", *The Journal of Consumer Affairs*, 35(21), 213-240.
- Roehm, H. & M. Roehm (2005), "Revisiting the effect of positive mood on variety-seeking", *Journal of Retailing and Consumer Services*, 32(2), 330-336.
- Rungtusanatham, M. (2001), "Beyond improved quality: the motivational effects of statistical process control", *Journal of Operations Management*, 19(6), 653-673.
- Rungtusanatham, M. et al. (2014), "Theorizing, testing, and concluding for mediation in SCM research: Tutorial and procedural recommendations", *Journal of Operations Management*, 32(3), 99-113.
- Şahin, A. & A. Fırat (2018), "Bireylerin hedonik tüketim davranışlarına sosyal medyanın etkisi", *Turkish Journal of Marketing*, 3(2), 127-142.
- Sancak, E. & N. Demirci (2012), "Ulusal tasarruflar ve Türkiye’de sürdürülebilir büyüme için tasarrufların önemi", *Ekonomik ve Sosyal Araştırmalar Dergisi*, 8(2), 159-198.
- Saraç, Ö. (2022), "Kültür Turistlerinin Sürdürülebilir Tüketim Davranışlarının Cinsiyete Göre Farklılıklar: Safranbolu Üzerinde Bir Araştırma", *Journal of Humanities and Tourism Research*, 12(2), 265-283.
- Sarkis, J. et al. (2010), "Stakeholder pressure and the adoption of environmental practices: The mediating effect of training", *Journal of Operations Management*, 28(2), 163-176.
- Şengün, H.İ. (2016), "Tüketicilerin Yeşil Ürünleri Tercih Etme Eğilimlerinin Değerlendirilmesi: Diyarbakır Örneği", *Doktora Tezi*, İnönü Üniversitesi Sosyal Bilimler Enstitüsü.
- Şentürk, Ü. (2008), "Modern Kontrol: Tüketim", *Sosyal Bilimler Dergisi/Journal of Social Sciences*, 32(2), 221-239.
- Sever S. & K. Çatı (2021), "The mediating role of attitude towards distance education in the effect of digital literacy level on satisfaction with distance education", *Journal of Higher Education and Science/Yükseköğretim ve Bilim Dergisi*, 11(3), 559-574.
- Sheth, J.N. et al. (2011), "Mindful consumption: A customer-centric approach to sustainability", *Journal of the Academy of Marketing Science*, 39, 21-39.
- Solunoğlu, A. & A. Nalçacı-İkiz (2020), "Beş faktör kişilik özelliklerinin hedonik tüketim üzerine etkisinin incelenmesi", *İşletme Araştırmaları Dergisi*, 12(3), 2344-2361.
- Somer, O. (1998), "Türkçe’de kişilik özelliği tanımlayan sıfatların yapısı ve bes faktör modeli", *Türk Psikoloji Dergisi*, 13(42), 17-32.
- Steenkamp, J.E.M. & H. Baumgartner (1995), "Development and cross-cultural validation of a short form of CSI as a measure of optimum stimulation level", *International Journal of Research in Marketing*, 12(2), 97-104.
- T.C. Ticaret Bakanlığı Tüketicinin Korunması ve Piyasa Gözetimi Genel Müdürlüğü (2023), *Türkiye İsrâf Raporu*, <https://tuketicici.ticaret.gov.tr/data/5e6b33e913b876e4200a0101/Turkiye_Israf_Raporu_2018.pdf>, 23.04.2023.
- Tanrıkkulu, E. & N.O. Bakır (2021), "Tüketicilerin çevrimiçi alışverişteki faydacı ve hedonik alışveriş değerinin algılanan fayda ve risk üzerindeki etkisi: Trendyol ve zara tüketicileri üzerine bir araştırma", *Öneri Dergisi*, 16(56), 634-667.

- Taşdemir, K. (2009) *Bilişim, Banka Veya Kredi Kartlarının Kötüye Kullanılması ve Dolandırıcılık Suçları*, Ankara: Ütopyağrafik Yayınevi.
- Terzi, O. & F. Bayrakdaroğlu (2022), "Kişiliğin, Gösterişçi Tüketimin ve İnternet Bağımlılığının Kompulsif Satın Alma Üzerindeki Etkisi", *Business and Economics Research Journal*, 13(3), 523-544.
- Tetik, N. & I.I. Albulut (2022), "The study of developing a financial literacy scale for university students in the digital era: Evidence from Inonu University", in: *Handbook of Research on Digital Violence and Discrimination Studies* (652-684).
- Tokgöz, E. (2019), "Hedonik ve faydacı tüketimin dürtüsel ve kompulsif satın alma üzerinde etkisi", *Pamukkale Üniversitesi Sosyal Bilimler Enstitüsü Dergisi*, 35, 93-108.
- Tsao, W.C. & H.R. Chang (2010), "Exploring the impact of personality traits on online shopping behavior", *African Journal of Business Management*, 4(9), 1800.
- Türk, Z. (2018), "Hedonik ve faydacı tüketim eğiliminin plansız satın alma davranışı üzerindeki etkisi: bir araştırma", *OPUS International Journal of Society Researches*, 9(16), 853-878.
- Türkdemir, P. (2019), "Faydacılıktan Hazcılığa: Sürdürülebilir Giysi Tüketim Davranışı", *Beykoz Akademi Dergisi*, 7(2), 17-30.
- Türkiye Bankalar Birliği (2023), *Kayıtlı Ekonominin Geliştirilmesi Sürecinde Kartlı Ödeme Sistemleri ile Yeni Yöntem ve Teknolojiler Kayıtlı Ekonominin Geliştirilmesi Sürecinde Kartlı Ödeme Sistemleri ile Yeni Yöntem ve Teknolojiler*, <<https://www.tbb.org.tr/Content/Upload/Dokuman/799/TBBVergiKonseyi.pdf>>, 22.06.2023.
- Türkmen, İ. & Ş. Erten (2020), "Gönüllü Sade Yaşam Tarzının Faydacı ve Hedonik Tüketim Üzerine Etkisi", *XIV. IBANESS İktisat, İşletme ve Yönetim Bilimleri Kongreler Serisi*, 656-662.
- Ullah, N. & M. İrfanoğlu (2021), "Effect of big five traits on online impulse purchase in the moderation effect of hedonic and utilitarian shopping motives", *Proceedings of The 5th International Conference on Research in Humanities and Social Sciences*, 372-38.
- Ulucan-Özkul, F. & G. Tapşın (2010), "Kredi kartı kullanımı ile kullanılabilir gelirin tüketim üzerindeki etkisi ve türkiye ekonomisi üzerine bir ampirik çalışma", *Muhasebe ve Finansman Dergisi*, (47), 138-153.
- Ünal, S. & A. Erciş (2006), "Pazarın satın alma tarzlarına ve kişisel değerlere göre bölümlendirilmesi", *Marmara Üniversitesi İ.İ.B. F. Dergisi*, 21(1), 359-383.
- Ünal, S. et al. (2015), "Ekonomi okuryazarlığı ve kredi kartı tutumunun rasyonel kredi kartı kullanımına etkisi: Dumlupınar Üniversitesi Tavşanlı MYO örneği", *Eskişehir Osmangazi Üniversitesi İİBF Dergisi*, 10(1), 31-52
- Uslu, K. & A. Gündoğdu (2011), "Küresel finansallaşmanın Türkiye'deki bankaların finansal faaliyetlerine ve bireyler üzerine etkileri", *Marmara Üniversitesi İktisadi ve İdari Bilimler Dergisi*, 31(2), 145-164.
- Uslu-Divanoğlu, S. & T. Uslu (2019), "Kişilik özelliklerinin içgüdüsel satın alma davranışlarına yansımaları", *Bingöl Üniversitesi Sosyal Bilimler Enstitüsü Dergisi*, 9(17), 215-234.
- Wang, L. et al. (2011), "Demographics, Attitude, Personality and Credit Card Features Correlate With Credit Card Debt: A View From China", *Journal of Economic Psychology*, 32(1), 179-193.

- Wei, Q. et al. (2023), "Influence of Utilitarian and Hedonic Attributes on Willingness To Pay Green Product Premiums and Neural Mechanisms in China: an ERP Study", *Sustainability*, 15, 2403.
- Wu, Z. et al. (2010), "Supplier-supplier relationships in buyer- supplier-supplier triads: Implications for supplier performance", *Journal of Operations Management*, 28(2), 115-123.
- Xiao, J.J. et al. (2011), "Antecedents and Consequences of Risky Credit Behavior Among College Students: Application and Extension of The Theory of Planned Behavior", *Journal of Public Policy & Marketing*, 30(2), 239-245.
- Yaşın, T. (2022), "Kişilik Özellikleri ve Psikolojik Sermayenin, Psikolojik İyi Oluşa Etkisi", *Doktora Tezi*, Başkent Üniversitesi Sosyal Bilimler Enstitüsü.
- Yıldırım, B.F. (2019), "Kredi kartı platformlarının sezgisel bulanık TOPSIS yöntemi kullanılarak değerlendirilmesi", *BDDK Bankacılık ve Finansal Piyasalar Dergisi*, 13(1), 37-58.
- Yıldırım, M. & H.U. Demir (2021), "Kredi kartı harcamalarını etkileyen makroekonomik faktörler ve COVID-19 pandemi dönemi üzerine bir inceleme", *Ekonomi Politika ve Finans Araştırmaları Dergisi*, 6(1), 159-180.
- Yuan, J. et al. (2023), "Toward the digital economy: Mobile payment affecting sustainable consumption behavior", *Innovative Marketing*, 19(1), 220-232.
- Yücel, S. & N. Çiftçi (2019), "Üniversite Öğrencilerinin Kredi Kartı Kullanım Durumlarının Bazı Demografik Değişkenler Açısından İncelenmesi", *Bilecik Şeyh Edebalı Üniversitesi Sosyal Bilimler Dergisi*, 4(1), 385-402.
- Zhou, H. et al. (2011), "Supply Chain Integration and the SCOR Model", *Journal of Business Logistics*, 32(4), 332-344.

Effects of FX on ETF Prices: Evidence from BIST

Tayfur BAYAT (<https://orcid.org/0000-0002-4427-0999>), İnönü University, Türkiye; tayfur.bayat@inonu.edu.tr

Altuğ Murat KÖKTAŞ (<https://orcid.org/0000-0002-0911-2143>), Necmettin Erbakan University, Türkiye; altugmkoktas@gmail.com

Selim KAYHAN (<https://orcid.org/0000-0002-4838-6892>), Necmettin Erbakan University, Türkiye; skayhan@erbakan.edu.tr

Gökhan KONAT (<https://orcid.org/0000-0002-0964-7893>), Bolu Abant İzzet Baysal University, Türkiye; gokhan.konat@inonu.edu.tr

Döviz Kurunun BYF'ler Üzerindeki Etkileri: BİST'ten Kanıtlar

Abstract

This study better investigates the possible relationship between exchange rates and ETF prices in the BIST to understand ETF investors' behaviour in the Turkish economy. Conventional and Fourier-based co-integration and causality analysis methods were employed to test models. According to findings, although the exchange rate has no direct effect on ETF prices in Türkiye, it is effective on ETF prices indirectly via the risk and share of foreign investors. The originality of the study lies in models built with additional control variables. In doing so, we measure the direct and indirect effects of the exchange rate on the Turkish economy.

Keywords : ETF, MSCI Türkiye, Fourier Toda-Yamamoto Causality Test.

JEL Classification Codes : F31, G12, G23.

Öz

Bu çalışma, Türkiye ekonomisinde BYF (Borsa Yatırım Fonu) yatırımcılarının davranışlarını daha iyi anlamak için döviz kurları ile BİST'teki BYF fiyatları arasındaki olası ilişkiyi araştırmaktadır. Modelleri test etmek için geleneksel ve Fourier tabanlı eş-bütünleşme ve nedensellik analizi yöntemleri kullanılmıştır. Elde edilen bulgulara göre, döviz kurunun Türkiye'deki BYF fiyatları üzerinde doğrudan bir döviz kuru bulunmamakla birlikte, yabancı yatırımcıların riski ve payı aracılığıyla BYF fiyatı üzerinde dolaylı bir etkisi bulunmaktadır. Bu çalışmanın özgünlüğü ek kontrol değişkenleri ile oluşturulan modellerde yatmaktadır. Kurulan model sayesinde döviz kurunun Türkiye ekonomisindeki doğrudan ve dolaylı etkilerini ölçme şansı oluşmuştur.

Anahtar Sözcükler : BYF, MSCI Türkiye, Fourier Toda-Yamamoto Nedensellik Testi.

1. Introduction

ETF is a basket containing securities traded on an exchange like a single stock (Geetha et al., 2020: 356). ETFs aim to replicate the performance of their underlying indices (Williams, 2014: 392). Ramaswamy (2011) expresses the structure of ETFs in two steps. First of all, the market maker buys shares of securities from the stock market. They build a basket of securities through an ETF sponsor who creates shares for the ETF. In the following step, ETFs are supplied to investors in the secondary market. From a different perspective, ETFs are open-end funds comprising securities assembled according to an investment objective and strategy.

When the ETFs are examined historically, the first examples can be seen in the early 1990s. Although Williams (2014) argues that the first launch was in 1996, according to Geetha et al. (2020) and Shin and Soydemir (2010), the first ETF launched in 1993 was the S&P Depository Receipts (SPDR). It tracks S&P500 stock indices. As of 2020, the global volume of ETFs is around \$7 trillion, and they are invested in equity, bonds, commodities, and currencies (Todorov, 2021: 41). Increasing ETFs has made ETFs an important financial tool. In this regard, it becomes important to investigate possible determinants of the price and demand of ETFs in an economy.

The exchange rate is also an important indicator for countries with high current account deficits where a fluctuating exchange rate regime is implemented. According to Yıldız (2014), economic theory argues that changes in exchange rates affect the cash flows, investments, and profitability of firms by making their inputs and outputs cheaper or more expensive and have a significant effect on the stocks of the firms (Yıldız, 2014: 77). In this regard, it is rational to think that exchange rate is effective on ETFs either.

Economists examine the relationship between stock prices and exchange rates to understand better how they interact. Because the definition of relationship is crucial for decision-makers responsible for monetary and fiscal policies, firms taking exchange rate risks in their businesses, and investors in stock markets. However, the findings in the literature need to be more conclusive. While results for stock prices are inconclusive, another stock market tool, exchange-traded funds, needs to be investigated better in the context of exchange rate relations.

Increasing volume and price efficiencies of ETFs bring a question into mind: "Is the possible relationship between stock prices and exchange rates valid for ETFs, or does price efficiency and increasing volume of ETFs due to the advantages of ETFs differentiate the strength and direction of the relationship?". These questions will also help to understand the behaviour of ETF investors and whether they employ ETFs in the same way as single stock shares. To answer these questions, we investigate the MSCI Türkiye ETF and Turkish lira against the U.S. dollar between 2008 and 2022. In this study, we employ the fractional frequency Engle-Granger co-integration test and fractional frequency Fourier Toda-

Yamamoto causality test in addition to conventional co-integration and causality tests to better understand the relation in the case of Türkiye.

A theoretical framework is drawn in the next section, and a possible relation between the exchange rate and stock and/or ETF price is summarised. In the third section, a literature review is presented. In the fourth section, the model is built, and data belonging to the model variables are presented. In the fifth section, empirical findings are summarised and interpreted. At the end of the study, political and theoretical implications are made.

2. Theoretical Background

When a literature survey was made, it was seen that many researchers had investigated the relationship between stock price and exchange rate volatility. Although there has yet to be a consensus about the direction and strength of the relation, alternative theoretical explanations are made in different ways. According to Zhao (2010), the linkage between exchange rates and stock prices has taken two forms. One is the "flow-oriented" model, which Dornbusch and Fischer (1980) suggested. According to them, changes in exchange rates affect international competitiveness and trade balances. Another is the "stock-oriented" model, which was indicated by Branson (1983) and Frankel (1983). This model views the exchange rate as equating the supply and demand for assets such as stocks. This approach determines exchange rate dynamics by giving the capital account a vital role (Zhao, 2010: 104).

Yıldız (2014) classifies the possible relationship between exchange rates and stock prices into four groups in the light of models suggested by Dornbusch and Fischer (1980), Branson (1983) and Frankel (1983). These are conventional, portfolio balance, stock, and asset market approaches.

Positive uni-directional causality running from exchange rate to stock prices can occur, according to Naeem and Rashed (2004). A depreciation in local currency leads to an increase in the competitiveness of local firms. Increasing competition would raise firms' export volume. In the end, the value of firms will increase, and stock prices will rise. Of course, this is valid only for firms with export capability (Naeem & Rasheed, 2004: 536). In the case of importing firms which have been listed on the stock exchange, causation linkage would be the opposite. The positive relation is called the "Conventional approach". According to this approach, volatility in the exchange rate would also affect firms' future payments in terms of foreign currency and business risk, even if it exports or imports (Yıldız, 2014: 79).

According to Naeem and Rashed (2004), the portfolio balance approach implies a negative relationship between stock indices and exchange rates, and uni-directional causality runs from stock price indices to exchange rates. Namely, individuals hold both domestic and foreign assets in their portfolios. It includes stock indices, equities, bonds, and currencies. With an increase in domestic stock prices, demand for it would rise. The investors would

exchange foreign and domestic assets to buy more stock indices. In the end, the local currency would be appreciated. Moreover, increasing local asset prices induce an increase in money demand. Increasing money demand would bring interest rate raises together. Again, high interest rates would attract foreign capital, and capital inflows would appreciate local currency due to the rising foreign currency supply. These two approaches are related to "flow-oriented" models, as Zhao (2010) indicated.

The stock approach implies bi-directional causality between the exchange rate and stock price. The exchange rate is a factor that balances the supply and demand of financial assets. Since the values of capital assets are evaluated over the present value of future cash flows, expectations regarding exchange rates play an important role in their price fluctuations. Therefore, stock prices can affect or be affected by exchange rate dynamics (Yıldız, 2014: 79). Moreover, any change in interest rate which affects binary simultaneously, there might be a bi-directional causality.

The last approach, "Asset Market," claims weak or no relationship between variables. A depreciation in local currency might make exporting firms more competitive, but if they import raw materials, that will increase costs and prices. That would induce a loss of competitiveness advantage for firms, and there will be neutrality between variables.

Another explanation of neutrality was made by Naeem and Rasheed (2002). According to them, the exchange rate is the price of an asset. Therefore, like prices of other assets, the exchange rates are determined by expected future exchange rates. Any news/factors that cause changes in the exchange rate will affect today's exchange rate. These factors may differ from those that cause stock price changes (Naeem & Rasheed, 2002: 536). So, there would be no linkage between variables.

The theoretical explanations are valid for exchange rate - stock price relation, but it needs to be clarified if one of them is valid for ETFs or not. Although ETFs are baskets of stock indices, the behaviour of investors in ETFs can be different from that of stockholders. That is why the situation for the ETFs needs to be investigated. In the conclusion section, we compare results with the approaches summarised above.

3. Literature Review

The literature examining ETFs in the context of factors affecting ETF prices is limited. Studies investigating ETFs are generally focused on the relationship between ETF and its underlying assets, such as tracking errors, etc. (please see Shin & Soydemir, 2010; Dedi & Yavas, 2016; Da & Shive, 2018; Tsalikis & Papadopoulos, 2019; Joshi et al., 2021). When we summarise them, it is possible to conclude that they focus on the price efficiency of ETFs in different financial systems.

A few researchers investigate the interaction between ETF and foreign exchange rate volatility. One of them belongs to Shank and Vianna (2016). In their study, one of the ETF types of behaviour of currency-hedged ETFs in U.S. financial markets is investigated. The

study's empirical results indicate an interaction between exchange rate shocks and investor behaviours. Although this implication is an initial result for ETF - FX relation, due to the type of ETF, results cannot be generated for all ETFs.

Geetha et al. (2020) investigate the sensitivity of ETFs to an exchange rate fluctuation. They employ exchange rate and ETF in NASDAQ from 2013 to 2018, using GARCH models, and find no direct relation between variables. The authors emphasise that the relationship between ETF and exchange rate might change according to underlying assets.

In another study, Sakarya and Ekinci (2020) analyse the relationship between ETF and exchange rate in the context of uncertainty. They employ MSCI Türkiye ETF data and the EGARCH method. Results suggest an asymmetric behaviour as outflows of ETFs are followed by an exchange rate depreciation with less exchange rate uncertainty, while significantly large inflows of ETFs lead to higher exchange rate uncertainty.

As can be seen, studies investigating ETFs focus on something other than ETF - FX relation. To our knowledge, this is the first study including risk and share of foreign investors in the stock market into the model to investigate the relation between ETF and FX. Also, unlike existing studies, we employ Fourier-based co-integration and causality analysis methods to get more robust results.

4. Data and Methodology

In this study, we investigate the possible interaction between stock price and exchange rate differently. While we measure the direct effects of the exchange rate, we put additional variables to capture indirect effects arising from risk. To do this, we employ credit default swap premium (CDS, hereafter) as a measure of risk and share of foreign capital in the stock market.

Theoretically, risk is an important factor affecting investment decisions. In this regard, risk will reduce capital investments even if they belong to domestic or foreign investors. In light of empirical evidence in the literature, it is possible to empirically mention the bi-directional causation linkage between exchange rate and CDS premium (Lu et al., 2009; Yang et al., 2010). So, an increase in a country's CDS premium would accelerate exchange rate volatility, and increasing volatility in the exchange rate will affect stock market investments.

CDS premiums would also directly affect stock prices. An increase in CDS premium would reduce stock prices due to increasing risks in the related economy, and investors prefer to stay more liquid. So, the relation between variables runs from CDS premium to stock price. An increase in CDS premium will reduce ETF demand and price (Please see Ngene & Hassan, 2012; Mateev, 2019).

Another variable is the share of foreign capital in the stock market. An increase in the share of portfolio investments of foreign investors in a stock market would increase the performance of the stock market (Singh & Weisse, 1998; Gümüş & Güngör, 2013; Ali & Hussain, 2013). Also, stock market performance might affect foreign capital (Haider et al., 2017). In this regard, a positive relation exists between share of foreign capital and stock price. On the other hand, the exchange rate might affect the share of foreign capital in the stock market. According to Ogundipe et al. (2019), Fidora et al. (2007), and Aydoğan and Vardar (2020), exchange rate volatility is one of the driving factors of foreign portfolio investments. So, an increase in exchange rate volatility would lower foreign portfolio investments in the stock market and reducing investments will reduce stock prices.

In the light of all theoretical explanations, direct and indirect interaction between exchange rate and ETF price can be predicted as follows.

Figure: 1
Relation Between Variables

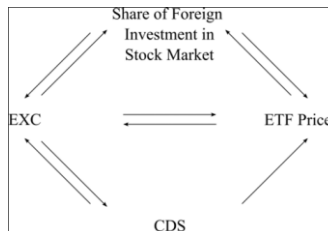

In the Turkish economy, the behaviour of stock market investors is affected by exchange rate volatility and behaviour of them affects exchange rate volatility (Çiçek & Öztürk, 2007: 98-102). The primary source of this relation is the net reserve position of the economy. In this regard, a change in the investment amount of foreign investors to ETF may also change the exchange rate.

After the 1980s, financial liberalisation started, financial markets improved, and new financial instruments were used. In 2008, Morgan Stanley established an ETF including stock shares from the Borsa İstanbul. We use data belonging to MSCI Türkiye ETF from March 2008 to June 2022. The sources of data are listed in the following Table.

Table: 1
The Source of Data

Variable	Acronym	Source
Exchange Traded Fund price	ETF	MSCI Türkiye
Exchange Rate (U.S. dollar)	EXC	International Monetary Fund, International Financial Statistics
Credit Default Swap Premium (5-year)	CDSTR	Bloomberg
Share of Foreign Investors in BIST	SHARE	Banking Regulation and Supervision Agency

To investigate the relation, two separate models were built. These are:

$$\text{Model 1: } EXC_t = \beta_0 + \beta_1 ETF_t + \beta_2 CDSTR_t + \beta_3 SHARE_t + e_t \quad (1)$$

$$\text{Model 2: } ETF_t = \alpha_0 + \alpha_1 EXC_t + \alpha_2 CDSTR_t + \alpha_3 SHARE_t + u_t \quad (2)$$

In models, β_0 and α_0 are constant terms, β_i and α_i are slope parameters for $i = 0,1,2,3$. t is defined as follows: $t = 2008:03, 2008:05, 2008:06, \dots, 2022:06$ and e_t and u_t are error terms representing variables which were not included in the model. The sources of data belonging to variables are presented in Table 1. Sources of data are listed also in the same table.

In the first model, the dependent variable is the exchange rate (EXC, hereafter), and the independent variables are ETF, credit default swap premium of the Turkish economy (CDSTR, hereafter), and foreign investment share in the BIST (SHARE, hereafter). In the second model, the dependent variable is ETF, and the independent variables are EXC, CDSTR and SHARE.

In the first step, unit root tests are applied. To test structural breaks in series, we employ both conventional unit root tests, unit root tests taking structural breaks into account and Fourier-based unit root tests taking smooth transition breaks into account. According to unit root test results, all variables are stationary in the first differences, and we accept variable I (1).

In the second step, we test the co-integration relation between variables in the long run by using the conventional Engle-Granger (1987) (EG, hereafter) co-integration test and residual-based co-integration test with a Fourier approximation. The residual-based co-integration test with a Fourier approximation (FEG, hereafter) is developed by Yılancı (2019). It aims to adapt to an unknown number and shape of structural breaks in the presence of soft structural changes with the help of Fourier functions. Yılancı (2019) has shown in his study that it is a test with good size and strength properties in the presence of fractures. In addition, the causal relationships between the variables were also investigated. Traditional Toda-Yamamoto (1995) and Fourier Toda-Yamamoto causality Nazlioglu et al. (2016) tests were used.

Descriptive statistics of the variables considered for both models in the study are presented in Table 2, and the time path graph of the variables is shown in Figure 2.

Table: 2
Descriptive Statistics of Variables

	<i>EXC</i>	<i>ETF</i>	<i>CDSTR</i>	<i>SHARE</i>
<i>Average</i>	3.866	41.365	284.926	24.433
<i>Median</i>	2.664	41.832	243.796	24.508
<i>Maximum</i>	16.684	74.043	803.610	25.082
<i>Minimum</i>	1.159	17.663	117.809	23.532
<i>Standard Dev.</i>	3.172	14.968	128.495	0.367
<i>Skewness</i>	1.966	0.111	1.293	-0.520
<i>Kurtosis</i>	6.997	1.922	4.429	2.270
<i>Jarque – Bera</i>	225.342 (0.000)	8.678 (0.013)	62.563 (0.000)	11.582 (0.003)

Note: Values in parentheses show probability values.

In Table 2, results imply that series belonging to variables do not show normal distribution.

Figure: 2
Time Path Graph of The Variables

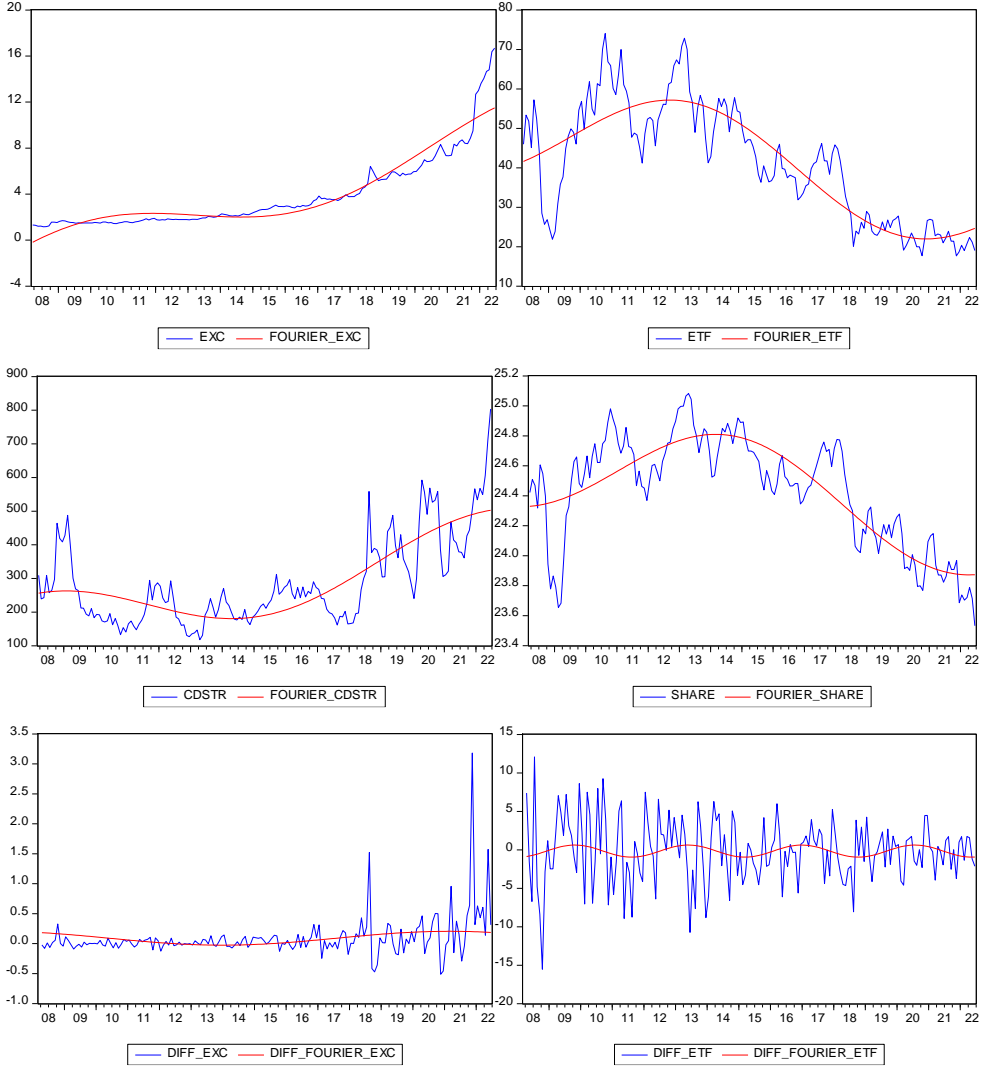

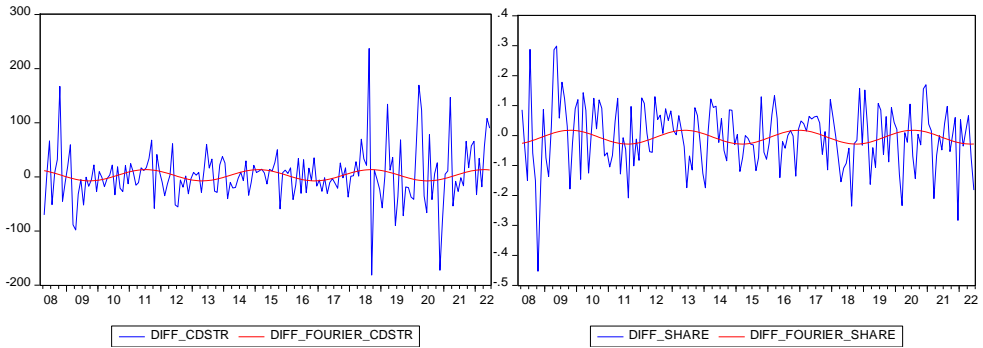

As shown in Figure 2, after taking the difference of the variables, they return to the mean and their appropriate frequencies are seen.

5. Empirical Findings

The first step to investigate the co-integration relation between variables for both models is unit root analysis. The unit root test results are presented in the following tables.

Table: 3
ADF and PP Unit Root Test Results

	Variables	ADF Test Stat.	P-P Test Stat.
Constant	ETF	-0.934 (0.775) [10]	-1.631 (0.465)
	Δ ETF	-5.745 (0.000) [9]***	-11.775 (0.000)***
	EXC	3.692 (0.998) [12]	6.455 (0.999)
	Δ EXC	0.576 (0.998) [7]	-10.564 (0.000)***
	CDSTR	-1.033 (0.741) [0]	-0.903 (0.786)
	Δ CDSTR	-13.167 (0.000) [0]***	-13.220 (0.000)***
	SHARE	-2.031 (0.273) [1]	-1.739 (0.409)
	Δ SHARE	-10.703 (0.000) [0]***	-10.499 (0.000)***
Constant and Trend	ETF	-3.077 (0.115) [6]	-2.883 (0.171)
	Δ ETF	-6.007 (0.000) [9]***	-11.741 (0.000)***
	EXC	3.089 (0.997) [12]	5.240 (0.998)
	Δ EXC	-11.264 (0.000) [0]***	-11.264 (0.000)***
	CDSTR	-2.251 (0.458) [0]	-2.294 (0.434)
	Δ CDSTR	-13.254 (0.000) [0]***	-13.371 (0.000)***
	SHARE	-2.730 (0.226) [1]	-2.484 (0.336)
	Δ SHARE	-10.706 (0.000) [0]***	-10.509 (0.000)***

Note: *** indicates significance at the 1% level. Values in parentheses present probability, and values in brackets show suitable lag length.

In Table 3, the unit root test results of Dickey-Fuller (1981) (ADF, hereafter) and Phillips-Perron (1988) (PP, henceforth) are presented. According to results obtained from ADF and PP, the series are stationary in both models with constant and constant trends when we consider the first difference of the series.

Table 4 presents the unit root test results with structural breaks developed by Lee-Strazicich (2003). Results obtained from conventional unit root tests and unit root tests with structural breaks are similar. Model A allows two structural breaks in the model with a

constant, and Model B allows two structural breaks in the model with a constant and constant, and the trend is stationary in the series of the first difference.

Table: 4
Lee-Strazichic (2003) Unit Root Test Results

Test	Variable	Test Stat.	Break Date	Critical Value		
				1%	5%	10%
LS (Model A)	ETF	-3.238	2009:11,2018:07	-4.087	-3.579	-3.321
	ΔETF	-9.805***	2014:02,2017:03	-4.087	-3.579	-3.322
	EXC	-0.925	2011:12,2020:08	-4.087	-3.579	-3.321
	ΔEXC	-12.247***	2016:08,2020:12	-4.087	-3.579	-3.321
	CDSTR	-3.195	2012:06,2020:02	-4.087	-3.579	-3.321
	ΔCDSTR	-10.076***	2009:12,2020:12	-4.087	-3.579	-3.321
	SHARE	-2.640	2018:07,2020:02	-4.087	-3.579	-3.321
	ΔSHARE	-8.900***	2014:02,2016:01	-4.087	-3.579	-3.321
LS (Model C)	ETF	-4.082	2009:08,2013:06	-6.552	-5.801	-5.424
	ΔETF	-11.923***	2010:09,2018:09	-6.299	-5.737	-5.427
	EXC	-5.063	2016:08,2021:01	-6.552	-5.801	-5.424
	ΔEXC	-13.233***	2017:05,2018:08	-6.172	-5.611	-5.321
	CDSTR	-4.816	2018:05,2020:11	-6.179	-5.617	-5.327
	ΔCDSTR	-13.864***	2012:06,2020:08	-6.299	-5.737	-5.427
	SHARE	-3.906	2009:08,2012:08	-6.179	-5.617	-5.327
	ΔSHARE	-10.749***	2012:06,2013:12	-6.414	-5.720	-5.408

Note: *** presents a 1% significance level.

Table 5 presents conventional KPSS (Kwiatkowski, 1992) and Fourier KPSS (Becker et al., 2006) unit root test results. Fourier KPSS unit root test results show that the series presents a stationary level for some models. However, it is possible to conclude that all series are stationary in the first difference when considering the financial series' long-run memory features. In the light of all results, we include series belonging to variables into analyses with their first difference.

Table: 5
KPSS and Fourier KPSS Unit Root Test Results

		KPSS Test Stat.	Freq	Min. SSR	Fourier KPSS Test Stat.	F Test Stat.	Critical Values		
							1%	5%	10%
Constant	ETF	1.106	1	11645.310	0.186	193.505***	0.269	0.172	0.131
	ΔETF	0.069***	4	2924.735	0.698	1.508	0.722	0.459	0.347
	EXC	1.340	1	969.015	0.623	65.492***	0.269	0.172	0.131
	ΔEXC	0.883	1	19.102	0.468	5.004**	0.269	0.172	0.131
	CDSTR	0.920	1	1478988.000	0.326	76.810***	0.269	0.172	0.131
	ΔCDSTR	0.263***	4	428214.6	0.318	1.803	0.722	0.459	0.347
	SHARE	0.774	1	8.315	0.202	150.192***	0.269	0.172	0.131
	ΔSHARE	0.146***	4	1.911	0.166	1.979	0.722	0.459	0.347
Constant and Trend	ETF	0.228	1	10080.67	0.037	78.133***	0.071	0.054	0.047
	ΔETF	0.031***	4	2920.924	0.034	1.449	0.217	0.147	0.118
	EXC	0.337	1	186.631	0.081	154.464***	0.071	0.054	0.047
	ΔEXC	0.227	1	17.028	0.062	6.585**	0.071	0.054	0.047
	CDSTR	0.307	1	1134401.000	0.049	57.045***	0.071	0.054	0.047
	ΔCDSTR	0.044***	4	423979.9	0.060	1.612314	0.217	0.147	0.118
	SHARE	0.316	1	7.149	0.044	115.212***	0.071	0.054	0.047
	ΔSHARE	0.023***	4	1.899	0.028	1.858	0.217	0.147	0.118

Note: *, **, and *** show significance levels of 10%, 5% and 1%, respectively. In a model with constant, F test statistics is used to test KPSS test statistics and significance of trigonometric terms and F statistics critical values for 1%, 5%, and 10% are 0.739, 0.463, 0.347 and 6.730, 4.929, 4.133, respectively. In a model with constant and trend, the critical values of the F test used to test the significance of KPSS test statistics and trigonometric terms are 0.216, 0.146, 0.119 and 6.873, 4.972, 4.162, respectively.

The second step is co-integration analysis. Table 6 presents conventional Engle-Granger and Fourier Engle-Granger co-integration test results. According to conventional co-integration test results, neither model is statistically significant. On the other hand, the Fourier Engle-Granger co-integration test results imply that in Model 2, variables are co-integrated when we consider smooth structural breaks. In light of this result, it is possible to conclude that there is a long-run relation between variables. To determine the size of the long-run relation, fully modified ordinary least squares (FMOLS, hereafter), dynamic ordinary least squares (DOLS, hereafter) and canonical co-integration regression (CCR) methods are employed in the third step.

Table: 6
Engle-Granger and Fourier Engle-Granger Co-integration Analysis Results

		Test Stat.	Min. KKT	k	Critical Values 1% 5% 10%		
Model 1	EG	-2.762 (0.545)	-	-			
	Fourier – EG	-4.166	389.038	4	-5.271	-4.605	-4.252
Model 2	EG	-0.817 (0.992)	-	-			
	Fourier – EG	-4.977**	849.237	1	-5.596	-4.957	-4.640

Note: ***, ** and * denote significance levels 1%, 5% and 10%, respectively; values in parentheses present probability values.

In Table 7, results belonging to FMOLS, DOLS and CCR analyses are presented. Long-term estimates of results obtained from FMOLS, DOLS and CCR methods are similar. According to these results, all variables, except the exchange rate variable and the trigonometric terms included in the model, are statistically significant. In addition, it is found that the R^2 value, which represents the model's explanatory power, is relatively high in all three methods.

Table: 7
Long Run Analysis Results

Method		Coefficient	Standard Error	Statistical value
FMOLS	EXC	-0.008	0.161	-0.047 (0.962)
	CDSTR	0.017	0.007	2.573 (0.011) **
	SHARE	42.416	2.442	17.370 (0.000) ***
	Constant	-999.791	61.074	-16.370 (0.000) ***
	SIN	6.304	0.556	11.329 (0.000) ***
	COS	4.434	0.610	7.263 (0.000) ***
	R^2			0.98
DOLS	EXC	0.061	0.208	0.293 (0.770)
	CDSTR	0.023	0.009	2.481 (0.014) **
	SHARE	44.299	3.263	13.577 (0.000) ***
	Constant	-1047.595	81.824	-12.803 (0.000) ***
	SIN	6.337	0.597	10.610 (0.000) ***
	COS	4.471	0.668	6.698 (0.000) ***
	R^2			0.98
CCR	EXC	-0.002	0.164	-0.014 (0.989)
	CDSTR	0.020	0.008	2.587 (0.011) **
	SHARE	43.012	2.608	16.495 (0.000) ***
	Constant	-1015.008	65.388	-15.523 (0.000) ***
	SIN	6.361	0.561	11.345 (0.000) ***
	COS	4.456	0.599	7.436 (0.000) ***
	R^2			0.97

Note: *** and ** indicate significance at the 1% and 5% levels and represent the probability values in parentheses, respectively.

Long run analysis results show that *CDSTR* and *SHARE* variables are positively effective on ETF price. So, *CDSTR* and *SHARE* variables create a positive effect on ETF

price. When we interpret results, theoretically, findings belonging to the SHARE variable are significant. Because an increase in portfolio investments from abroad will increase ETF prices; on the other hand, results show that an increase in credit default swap premiums will increase ETF prices. This is opposite to theoretical expectations. In this regard, the share of foreign investments in BIST is the dominant variable affecting ETF price in the long run.

In the fourth step, we made an error correction analysis. Results are also listed in Table 8. ECT represents the error correction mechanism, and according to the results presented in Table 8, it is seen that the error correction mechanism works because it is statistically significant and is between -1 and 0. In addition, it is found that the short-term imbalances in the system are resolved approximately in 18 (1/0.055) months. The causality tests of the variables were carried out, and the traditional Toda-Yamamoto (1995) analysis results are presented in Table 9 below.

Table: 8
Short Run Analysis Results

	Coefficient	Standard Error	t-Statistic	Prob.
EXC	-0.533	0.562	-0.948	0.344
CDSTR	-0.006	0.005	-1.338	0.183
SHARE	31.251	1.974	15.833	0.000***
Constant	0.067	0.170	0.393	0.695
ECT	-0.055	0.029	-1.873	0.063*

Note: *** and * indicate significance at the 1% and 10% levels.

Table: 9
Toda-Yamamoto Causality Test Results

H_0	Lag Length	Wald Test Stats.	Asymp. Prob Value	Bootstrap Prob. Value
ETF \leftrightarrow EXC	8	4.877	0.771	0.733
EXC \leftrightarrow ETF	8	5.321	0.723	0.720
ETF \leftrightarrow CDSTR	1	2.883	0.089*	0.094*
CDSTR \leftrightarrow ETF	1	0.024	0.877	0.822
ETF \leftrightarrow SHARE	8	7.794	0.454	0.457
SHARE \leftrightarrow ETF	8	6.151	0.630	0.625
EXC \leftrightarrow CDSTR	1	0.380	0.537	0.484
CDSTR \leftrightarrow EXC	1	0.293	0.588	0.559
EXC \leftrightarrow SHARE	8	18.366	0.019**	0.024**
SHARE \leftrightarrow EXC	8	5.337	0.721	0.674
CDSTR \leftrightarrow SHARE	2	8.618	0.013**	0.015**
SHARE \leftrightarrow CDSTR	2	1.629	0.443	0.445

Note: * and ** present 10% and 5% significance levels, respectively. Number of bootstrap simulations is 10,000.

Figure: 3
Conventional Toda-Yamamoto Causality Analysis Results

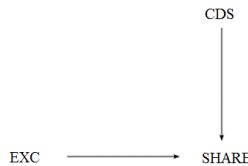

According to conventional Toda-Yamamoto causality test results, there is a uni-directional causality running from *ETF* to *CDSTR*, from *EXC* to *SHARE* and *CDSTR* to *SHARE*. Results show that exchange rate and CDS premium are effective on share of foreign investors in BIST. Statistical significance is 5% for both variables. On the other hand, statistical significance of effects of ETF on *CDSTR* is low and theoretically it is almost insignificant. Results are also seen in Figure 3.

Table: 10
Fourier Toda-Yamamoto Causality Test Results

H_0	Lag length	Frequency	Wald Test Stat.	Asymp. Prob. Value	Bootstrap Prob. Value
<i>ETF</i> \leftrightarrow <i>EXC</i>	8	1	3.402	0.907	0.878
<i>EXC</i> \leftrightarrow <i>ETF</i>	8	1	2.559	0.959	0.954
<i>ETF</i> \leftrightarrow <i>CDSTR</i>	2	1	2.475	0.290	0.298
<i>CDSTR</i> \leftrightarrow <i>ETF</i>	2	1	1.442	0.486	0.483
<i>ETF</i> \leftrightarrow <i>SHARE</i>	8	1	9.169	0.328	0.342
<i>SHARE</i> \leftrightarrow <i>ETF</i>	8	1	6.073	0.639	0.630
<i>EXC</i> \leftrightarrow <i>CDSTR</i>	8	1	17.546	0.025**	0.072*
<i>CDSTR</i> \leftrightarrow <i>EXC</i>	8	1	7.493	0.484	0.455
<i>EXC</i> \leftrightarrow <i>SHARE</i>	8	1	18.742	0.016**	0.018**
<i>SHARE</i> \leftrightarrow <i>EXC</i>	8	1	5.150	0.741	0.711
<i>CDSTR</i> \leftrightarrow <i>SHARE</i>	2	1	10.426	0.005***	0.007***
<i>SHARE</i> \leftrightarrow <i>CDSTR</i>	2	1	0.805	0.669	0.668
<i>SHARE</i> \leftrightarrow <i>CDSTR</i>		2	1.629	0.443	0.445

Note: * and ** present 10% and 5% significance levels, respectively. Number of bootstrap simulations is 10,000.

Fourier Toda-Yamamoto causality analysis results powered by Fourier terms are similar to conventional Toda-Yamamoto causality test results. Uni-directional causation linkages running from *EXC* to *SHARE* and *CDSTR* to *SHARE* are found. Statistical significance level is 1% for both results. When we compare conventional analysis, significance level is higher than conventional one. On the other hand, there is a uni-directional causality running from *EXC* to *CDSTR*. This is different from conventional analysis. Also, significance level is 10%. Although statistical significance is low, theoretically increasing exchange rate is risky for both financial and real sectors. Increasing risk will accelerate CDS premium. In the light of results obtained from causality analyses, exchange rate does not have direct effect on ETF prices. But it is effective via share of foreign investors and CDS premium. Results are also presented in Figure 4.

Figure: 4
Fourier Toda-Yamamoto Causality Test Results

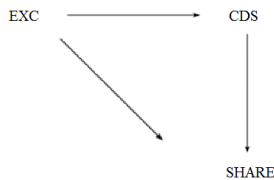

6. Conclusion

In recent years, the ETF has been one of the most popular passive investment instruments in the financial markets. As mentioned in the introduction section, the share of ETFs in the stock markets increases yearly. Increasing interest in ETFs made it an important instrument to investigate. There are few studies analysing different aspects of ETFs. The tracking error of ETF with the underlying assets, return and volatility correlation and effect of uncertainty on ETF performance are all tested in different financial markets. A few studies analyse the possible interaction between ETF prices and exchange rates.

This study investigates the relationship between exchange rate and ETF prices in the Turkish economy between 2008 and 2022 via advanced and conventional econometric methods. According to the results, risk premiums and shares of foreign investors effectively affect ETF prices in the long run. On the other hand, the coefficient belonging to the exchange rate is not significant. That means the exchange rate is ineffective on ETF prices in the Turkish economy. Moreover, only the share of foreign investors is effective on ETF prices in the short run. The short and long-run analyses imply that the exchange rate is effective on ETF prices neither in the short nor long run. However, risk premiums and shares of foreign investors are effective on ETF prices.

When we apply causality analysis, it is seen that risk premium and exchange rate affect the share of foreign investors in the BIST. Fourier's causality analysis also indicates a unidirectional relation between the exchange rate and the share of foreign investors in BIST. Combining all these results makes it possible to conclude that there is no direct effect of the exchange rate on ETF price, but it is effective on the share of foreign investors. Also, foreign investors' shares affect ETF prices in the short- or long-term. The transmission mechanism works from the exchange rate to the share of foreign investors in BIST and from the share of foreign investors in BIST to ETF prices. Another mechanism works from exchange rate to risk premium, risk premium to share of foreign investors in BIST and from share of foreign investors in BIST to ETF prices.

We can compare results with the theoretical explanations summarised before. As mentioned earlier, four approaches are trying to explain the relationship between stock prices and exchange rates. Results are similar to the "Asset market" approach, claiming no or weak relation between ETF and exchange rate. But, different from this approach, we have findings indicating an indirect relation. So, it is possible to imply that the relationship between ETF prices and the exchange rate is somewhat different from the stock price exchange rate nexus. This result may come from the structure of the Turkish capital market. As the Turkish economy is an emerging market, the financial system is still on the way to developing. For this reason, a relatively fordable market does not reflect exchange shocks efficiently and induce possible indirect relations, as found in the study.

References

- Ali, S. & J. Hussain (2013), "Impact of Portfolio Investments on Stock Market Performance", *SSRN Discussion Paper*, <<https://ssrn.com/abstract=2334119>>, 28.02.2013.
- Aydoğan, B. & G. Vardar (2021), "Portfolio Flows - Exchange Rate Volatility: Is There a Puzzling Relationship?", *Journal of Economic and Administrative Sciences*, 37(4), 611-642.
- Becker, R. et al. (2006), "A Stationarity Test in the Presence of an Unknown Number of Smooth Breaks", *Journal of Time Series Analysis*, 27(3), 381-409.
- Branson, W.H. (1983), "Macroeconomic Determinants of Real Exchange Risk", in: R.J. Herring (ed.), *Managing Foreign Exchange Risk*, Cambridge University, Cambridge.
- Çiçek, M. & F. Öztürk (2007), "Yabancı Hisse Senedi Yatırımcıları Türkiye'de Döviz Kuru Volatilitelerini Şiddetlendiriyor mu?", *Ankara Üniversitesi SBF Dergisi*, 62(4), 83-107.
- Da, Z. & S. Shive (2018), "Exchange Traded Funds and Asset Return Correlations", *European Financial Management*, 24(1), 136-168.
- Dedi, L. & B.F. Yavas (2016), "Return and Volatility Spillovers in Equity Markets: An Investigation Using Various GARCH Methodologies", *Cogent Economics & Finance*, 4(1), 1266788.
- Dickey, D.A. & W.A. Fuller (1981), "Likelihood Ratio Statistics for Autoregressive Time Series with a Unit Root", *Econometrica*, 49(4), 1057-1072.
- Dornbusch, R. & S. Fischer (1980), "Exchange Rates and the Current Account", *American Economic Review*, 70(5), 960-971.
- Fidora, M. et al. (2007), "Home Bias in Global Bond and Equity Markets: The Role of Real Exchange Rate Volatility", *Journal of International Money and Finance*, 26(4), 631-655.
- Frankel, J.A. (1983), "Monetary and Portfolio-Balance Models of Exchange Rate Determination", in: J.S. Bhandari & B.H. Putnam (eds.), *Economic Interdependence and Flexible Exchange Rate*, MIT, Cambridge.
- Geetha, E. et al. (2020), "Are Global Exchange Traded Fund Pretentious on Exchange Rate Fluctuation? A Study Using GARCH Model", *Investment Management and Financial Innovations*, 17(4), 356-366.
- Gümüş, G.K. & B. Güngör (2013), "The Relationship Between Foreign Portfolio Investment and Macroeconomic Variables", *European Scientific Journal*, 9(34), 209-226.
- Haidar, M.A. et al. (2017), "The Impact of Stock Market Performance on Foreign Portfolio Investment in China", *International Journal of Economics and Financial Issues*, 7(2), 460-468.
- Joshi, A. et al. (2021), "Dynamic Analysis Between ETF and Underlying Asset Using Tracking Error", in: S. Chakrabarti et al. (eds.), *In Interdisciplinary Research in Technology and Management* (82-85), CRC Press, London.
- Kwiatkowski, D. et al. (1992), "Testing the Null Hypothesis of Stationarity Against the Alternative of a Unit Root", *Journal of Econometrics*, 54(1), 159-178.
- Lee, J. & M. Strazich (2003), "Minimum Lagrange Multiplier Unit Root Test with Two Structural Breaks", *The Review of Economics and Statistics*, 85(4), 1082-1089.
- Lu, L. et al. (2009), "Long Term Performance of Leveraged ETFs", *SSRN Discussion Paper*, <<https://ssrn.com/abstract=1344133>>, 28.02.2013.

- Mateev, M. & E. Marinova (2019), "Relation Between Credit Default Swap Spreads and Stock Prices: A Non-Linear Perspective", *Journal of Econ Finance*, 43(1), 1-26.
- Muhammad, N. & A. Rasheed (2002), "Stock Prices and Exchange Rates: Are They Related? Evidence from South Asian Countries", *The Pakistan Development Review*, 41(4), 535-550.
- Nazlioglu, S. et al. (2016), "Oil Prices and Real Estate Investment Trusts (REITs): Gradual-Shift Causality and Volatility Transmission Analysis", *Energy Economics*, 60, 168-175.
- Ngene, G. & K. Hassan (2012), *Momentum, Nonlinearity in Cointegration and Price Discovery: Evidence from Sovereign CDS and Equity Markets of Emerging Countries*, <http://cbt2.nsuok.edu/kwok/conference/submissions/swfa2013_submission_200.pdf>, 28.04.2023.
- Ogundipe, A.A. et al. (2019), "Exchange Rate Volatility and Foreign Portfolio Investment in Nigeria", *Investment Management and Financial Innovations*, 16(3), 241-250.
- Phillips, P. & P. Perron (1988), "Testing for a Unit Root in Time Series Regression", *Biometrika*, 75(2), 335-346.
- Ramaswamy, S. (2011), "Market Structures and Systemic Risks of Exchange-traded Funds", *BIS Working Papers*, (343), 01.04.2011.
- Sakarya, B. & A. Ekinçi (2020), "Exchange-traded Funds and FX Volatility: Evidence from Turkey", *Central Bank Review*, 20(4), 205-211.
- Shin, S. & G. Soydemir (2010), "Exchange-traded Funds, Persistence in Tracking Errors and Information Dissemination", *Journal of Multinational Financial Management*, 20(4-5), 214-234.
- Singh, A. & B.A. Weisse (1998), "Emerging Stock Markets, Portfolio Capital Flows and Long-term Economic Growth: Micro and Macroeconomic Perspectives", *World Development*, 26(4), 607-622.
- Toda, H.Y. & T. Yamamoto (1995), "Statistical Inference in Vector Autoregressions with Possibly Integrated Processes", *Journal of Econometrics*, 66(1-2), 225-250.
- Todorov, K. (2021), "The Anatomy of Bond ETF Arbitrage", *BIS Quarterly Review*, March, 41-53.
- Tsalikis, G. & S. Papadopoulos (2019), "ETFs-Performance, Tracking Errors and Their Determinants in Europe and the USA", *Risk Governance & Control: Financial Markets & Institutions*, 9(4), 67-76.
- Williams, S.O. (2014), "Country ETFs, Currencies and International Diversification", *Journal of Asset Management*, 25(6), 392-414.
- Yang, J. et al. (2010), "Nonlinearity, Data-Snooping, and Stock Index ETF Return Predictability", *European Journal of Operational Research*, 200(2), 498-507.
- Yıldız, A. (2014), "Döviz Kuru ile Hisse Senedi Endeksleri Arasındaki İlişki", *Finans Politik ve Ekonomik Yorumlar Dergisi*, 51(593), 77-91.
- Zhao, H. (2010), "Dynamic relationship between exchange rate and stock price: Evidence from China", *Research in International Business and Finance*, 24(2), 103-112.

Orta Gelir Tuzağı ve Vergi Gelirlerinin Kompozisyonu Arasındaki İlişki: Yükselen G20 Ülkeleri Örneği

Tayfun MOĞOL (<https://orcid.org/0000-0002-2435-890X>), Anadolu University, Türkiye;
tmogol@anadolu.edu.tr

Burak PİRDAL (<https://orcid.org/0000-0002-7856-5701>), Anadolu University, Türkiye;
burakpirdal@anadolu.edu.tr

Relationship Between the Middle-Income Trap and the Composition of Tax Revenues: Evidence from Emerging G20

Abstract

It is widely stated that countries that cannot reach the high-income level by being stuck in the middle-income level for a long time may be caught in the middle-income trap. In this study, firstly, whether the examined countries (Emerging G20) are in the middle-income trap or not was investigated with the Narayan & Popp (ADF Test) (Model A) unit root test with structural break(s), which is one of the second-generation unit root tests structural break(s) that allows two breaks at the level. In the second stage, the Dumitrescu & Hurlin Panel Causality Test was applied to investigate the possible causal relationship between the composition of tax revenues and income level in the examined countries. In the last stage, the potential impact of getting rid of the middle-income trap on the composition of tax revenues in the countries subject to the analysis was investigated with the static panel data analysis method. In the study, a mutual causality relationship was determined between the composition of tax revenues and the income level of the countries, and at the same time, it was detected that although the increase in income enhances the share of indirect taxes in total tax revenues in the countries that still in the middle-income trap, this share decreased in case of exit from the middle-income trap with the increase in income level.

Keywords : Middle Income Trap, Tax Revenues, Direct Taxes, Indirect Taxes, Dumitrescu & Hurlin Panel Causality, Narayan & Popp ADF, Panel Data Analysis.

JEL Classification Codes : C50, E60, H20, O40.

Öz

Uzunca bir süre orta gelir düzeyinde takılıp kalarak yüksek gelir düzeyine ulaşamayan ülkelerin orta gelir tuzağına yakalanmış olabileceği yaygın olarak ifade edilir. Bu çalışmada, öncelikle, incelenen ülkelerin (Yükselen G20) orta gelir tuzağında olup olmadıkları ikinci nesil yapısal kırılmalı birim kök testlerinden olan *düzeyde iki kırılmaya izin veren Narayan & Popp (ADF Testi) (Model A) yapısal kırılmalı birim kök testi* ile araştırılmıştır. İkinci aşamada ise incelenen ülkelerde vergi gelirlerinin kompozisyonu ile gelir düzeyleri arasındaki muhtemel nedensellik ilişkisinin sınanması amacıyla *Dumitrescu & Hurlin Panel Nedensellik Testi* uygulanmıştır. Son aşamada ise analize konu ülkelerde gelirdeki artışın ve orta gelir tuzağından kurtulma durumunun vergi gelirlerinin kompozisyonu üzerindeki olası etkileri *statik panel veri analizi* yöntemiyle araştırılmıştır. Çalışmada, vergi gelirlerinin kompozisyonu ile ülkelerin gelir düzeyi arasında karşılıklı nedensellik ilişkisi tespit edilmiş olup aynı zamanda, gelirdeki artışın orta gelir tuzağında bulunan ülkelerde dolaylı vergilerin toplam vergi gelirleri içindeki payını artırmasına karşın, gelirdeki artış ile birlikte orta gelir tuzağından çıkışın sağlanması durumunda ise bu payın azalış sergilediği bulgulanmıştır.

Anahtar Sözcükler : Orta Gelir Tuzağı, Vergi Gelirleri, Dolaysız Vergiler, Dolaylı Vergiler, Dumitrescu & Hurlin Panel Nedensellik, Narayan & Popp ADF, Panel Veri Analizi.

1. Giriş

Gelir ve refahın maksimizasyonu temel makroekonomik amaçlardandır. Makroiktisadi politikaların çoğu bu amaç doğrultusunda dizayn edilip uygulanır. Bu çerçevede, gelirin artırılmasının kalkınma ve refahın maksimize edilmesinde oynadığı önemli rol aşikardır. Ancak, büyümenin hızı kadar sürekliliği de önemlidir. Bu ise büyümeye politikalarının etkinliğini ve sürdürülebilirliğini gerekli kılar. Arzu edilen düzeylerdeki büyüme rakamlarının sürdürülemez olduğu ülkeler ise gelir tuzaklarına yakalanabilir ve bunlardan biri de orta gelir tuzağıdır.

Orta gelir tuzağı kavramının ortaya çıkışı ve başta ekonomi bilimi olmak üzere birçok alanda ilgi çekmesi esas itibariyle 2000'li yılların başında gerçekleşmiştir. Nispeten yeni bir kavram olmasına rağmen günümüze kadar orta gelir tuzağına ilişkin çok sayıda çalışma yapılmıştır. Ülkelerin orta gelir tuzağına yakalanmasının nedenlerinin yanı sıra tuzaktan çıkılması için ne tür ekonomik, kurumsal ve/veya yapısal reformların yapılması gerektiğine ilişkin hususları çeşitli yönleriyle araştırılmıştır.

Orta gelir tuzağı kavramının ne olduğu, ortaya çıkış nedenleri, ölçüm yöntemleri, sonuçları ve alınması gereken önlemler konusunda araştırmacılar arasında ortak bir fikir birliği bulunmamaktadır. Genel anlamda, kavram, gelişmekte olan ülkelerin düşük gelir düzeylerinden kurtulabilmesine rağmen orta gelir düzeyinden üst gelir grubuna çıkmakta zorlanması olarak tanımlanabilir. Bu tanım içerisinde yer alan düşük, orta ve yüksek gelir düzeyleri nedir, nasıl ölçülmektedir konuları ayrıca önemlidir. Diğer yandan, literatürde, orta gelir tuzağından söz edebilmek için orta gelir grubunda ne kadar süre kalınmış olması gerektiği sorusu da henüz net olarak yanıtlanmamıştır.

Orta gelir tuzağı ile makroekonomik dinamikler ve ekonomi politikaları arasında yakın bir ilişki mevcuttur. Bu çalışmanın temel amacı orta gelir tuzağı ile ülkelerin vergi gelirlerinin kompozisyonu arasındaki olası ilişkinin incelenmesidir. Bu çerçevede, çalışmanın araştırma soruları şunlardır:

- Ülkelerin orta gelir tuzağından kurtulmasının söz konusu ülkelerin vergi gelirlerinin kompozisyonu (dolaylı vergilerin toplam vergi gelirleri içindeki payı) üzerinde istatistikî olarak anlamlı bir etkisi bulunmakta mıdır?
- Bahsi geçen etkinin varlığı varsayımı altında bu ilişkinin niteliği ve niceliği ne şekilde tezahür etmektedir?
- Ülkelerin vergi gelirlerinin kompozisyonundaki (dolaylı vergilerin toplam vergi gelirleri içindeki payındaki) değişmeler ile kişi başı gayrisafi yurtiçi hasılları arasında istatistikî olarak anlamlı herhangi bir nedensellik ilişkisi mevcut mudur?

- Söz konusu nedensellik ilişkisi mevcut ise bu ilişkinin niteliği ne tür özellikler arz etmektedir?

Diğer yandan, çalışmanın hipotezleri ise aşağıdaki gibidir:

H₁: Ülkelerin gelirlerindeki artış ile söz konusu ülkelerin vergi gelirlerinin kompozisyonu (dolaylı vergilerin toplam vergi gelirleri içindeki payı) arasında istatistiki olarak anlamlı ve karşılıklı bir nedensellik ilişkisi mevcuttur.

H₂: Ülkelerin gelirlerindeki artış söz konusu ülkelerde dolaylı vergilerin toplam vergi gelirleri içindeki payını azaltmaktadır.

H₃: Ülkelerin orta gelir tuzağından kurtulmasının söz konusu ülkelerin vergi gelirlerinin kompozisyonu (dolaylı vergilerin toplam vergi gelirleri içindeki payı) üzerinde istatistiki olarak anlamlı bir etkisi mevcuttur.

H₄: Bir ülkenin orta gelir tuzağından kurtulması söz konusu ülkede dolaylı vergilerin toplam vergi gelirleri içindeki payını azaltmaktadır.

Çalışmada, vergi gelirlerinin kompozisyonu ile dolaylı vergilerin toplam vergi gelirleri içindeki payı kastedilmektedir. Diğer yandan, orta gelir tuzağından kurtulma durumu üst gelir grubuna çıkmış olma anlamına gelmeyip, en genel tabirle, üst gelir grubuna doğru ivme kazanma anlamında orta gelir grubunda durağan bir biçimde sıkışıp kalmamış olma durumunu ifade etmektedir. Çalışmada önce orta gelir tuzağına düşmenin nedenleri, daha sonra orta gelir tuzağının ölçüm yöntemleri açılanmaktadır. Orta gelir tuzağının ülkelerin vergi hasılatları üzerinde olası etkileri teorik olarak değerlendirildikten sonra ampirik olarak önce incelenen ülkelerin orta gelir tuzağında olup olmadıkları tespit edilmiş olup sonrasında ise gelirdeki artış ile orta gelir tuzağından kurtulmanın vergi gelirlerinin kompozisyonuyla arasındaki olası ilişki ampirik yöntemlerle analiz edilmiştir.

İlgili literatürde vergi gelirlerinin GSYİH düzeyleri ile orta gelir tuzağı üzerindeki etkisinin incelendiği muhtelif çalışmalar olmasına karşın, tarafımızca yapılan literatür taraması neticesinde orta gelir tuzağından çıkış durumunun vergi gelirlerinin kompozisyonu üzerindeki etkisini ampirik yöntemlerle araştıran herhangi bir çalışmaya rastlanmamıştır. Ayrıca, çalışmada imkânlar dahilinde en güncel verilerden yararlanılmış olup kapsamlı ve uygun ampirik metodoloji neticesinde elde edilen bulgular teorik temellerle desteklenmiştir. Bu yönleriyle, çalışmamızın özgün değer içerdiğini ve literatüre katkı sağlama anlamında yaygın etkide bulunacağı beklenmektedir.

2. Orta Gelir Tuzağı Kavramı

Orta gelir tuzağı kavramının ne olduğu konusunda ekonomistler arasında bir görüş birliği bulunmamaktadır. Araştırmacılar net bir tanım vermektense, ne olduğu hakkında görüş bildirmektedirler. Genel anlamda, orta gelir tuzağı, ülkelerin gelişme süreçlerinde düşük gelir düzeyinden orta gelir düzeyine hızlı bir biçimde çıktıkları ancak, orta gelir düzeyinden yüksek gelir düzeylerine çıkmakta zorlandıklarını ifade etmektedir. Bir başka ifade şekli, gelişmenin başladığı ilk yıllarda orta gelirli ülkelerin ve yüksek gelirli ülkelerden

daha yüksek büyüme oranlarına ulaşmaları ancak, orta gelir düzeyindeki büyüme oranlarının özellikle gelişmiş ülke büyüme oranlarından düşük kalmaları şeklindedir. Dolayısıyla, bu ülkeler, yüksek gelirli ülkelerin büyüme oranlarına göre daha düşük seviyelerde gerçekleşen büyüme oranları nedeniyle orta gelir düzeyinden çıkamamaktadırlar ve bir şekilde bu tuzağa yakalanmış gibi tanımlanmaktadırlar.

Bu çerçevede, orta gelir tuzağında olma durumu çeşitli biçimlerde açıklanmaktadır. Bir görüşe göre orta gelir tuzağındaki ülkeler düşük ücretlerle ihracata yönelik üretim yapan düşük gelirli ülkeler ile inovasyona dayalı teknolojik ve kaliteli üretim yapan yüksek gelirli ülkeler arasından kalmaktadırlar (Gill et al., 2007). Orta gelir düzeyinde iken gerekli endüstriyel ürün çeşitlendirmesini yapamamakta, yüksek katma değerli ürünleri üretmekte zorlanmakta, işgücünün verimliliğini artırmakta başarısız olmakta ve ölçek ekonomilerini sağlayacak biçimde üretim kapasitelerini artıramamaktadırlar. Orta gelir grubundaki ülkelerin söz konusu gerekli ekonomik, kurumsal, siyasi düzenlemeleri yapamadıkları için tutaktan çıkamadığı belirtilmektedir. (Kharas & Kohli, 2011).

Orta gelir grubunun alt-üst eşiklerinin belirlenmesi ve ülkelerin muhtelif gelir gruplarına göre tasnifinde en sık kullanılan kıstaslardan biri Dünya Bankası tarafından oluşturulan ve her yıl güncellenen '*gelir grupları sınıflandırması*'dır. Tablo 1'de 2022-2023 yılı için Dünya Bankası'nın gelir düzeyine göre ülke sınıflandırmasına temel teşkil eden kişi başı milli gelir aralıkları yansıtılmaktadır:

Tablo: 1
Dünya Bankası Gelir Grupları Sınıflandırması (2022-2023)

Gelir Grubu	Kişi Başına Düşen Milli Gelir (USD)
Düşük Gelir	1085 USD ve altı
Orta Gelir	1086-13205 USD arası
<i>Alt-Orta Gelir</i>	1086-4255 USD arası
<i>Üst-Orta Gelir</i>	4256-13205 USD arası
Yüksek Gelir	13205 USD ve üzeri

Kaynak: Dünya Bankası, 2023a.

Tablo 1'e göre yıllık kişi başı milli geliri 1085 USD ve altında bulunan ülkeler alt gelir grubu, 1086-13205 USD arasında olan ülkeler orta gelir grubu, 13205 USD ve üzerinde olanlar ise üst gelir grubu olarak tasnif edilmektedir. Bununla birlikte, bahsi geçen sınıflandırmada orta gelir grubu iki alt gelir grubuna ayrılmıştır: (i) alt-orta gelir grubu ve (ii) üst-orta gelir grubu. Bu çerçevede, yıllık kişi başı milli geliri 1086-4255 USD arası ve 4256-13205 USD arası olan ülkeler sırasıyla alt-orta gelir ve üst-orta gelir grupları olarak nitelendirilmektedir (Dünya Bankası, 2023a).

Orta gelir tuzağının tanımlanması nicel veya ampirik olarak da yapılmaktadır. Bu tanımlamalarda orta gelir eşikleri mutlak kriterlere veya göreceli kriterlere göre belirlenmektedir. Glawe ve Wagner'e (2016) göre -izleyen bölümlerde ayrıntılı olarak açıklanacağı üzere- mutlak kriterler, kesin ve net orta gelir eşiklerine bağlıdır. Düşük, orta, yüksek gelirli ülkeler mutlak eşiklere göre sınıflanmaktadır. Buna karşılık, göreceli kriterlere göre, orta gelir eşikleri, ülkelerin genellikle kişi başına düşen gelirinin, ABD veya

Japonya gibi gelişmiş ülkelerin kişi başına düşen gelirine oranlanarak hesaplanmaktadır. Ancak farklı çalışmalar kapsamında gelir eşiklerinin veya nispi gelir oranı aralıklarının farklı tanımları ve ampirik analizlerde farklı GSYİH veri setlerinin kullanılması, literatürde birçok nicel/ampirik orta gelir tanımının ortaya çıkmasına neden olmuştur.

Grafik: 1
Kişi Başı GSYİH (Güney Kore-KOR, Güney Afrika-ZAF, Brezilya-BRA; USD, 1960-2021)

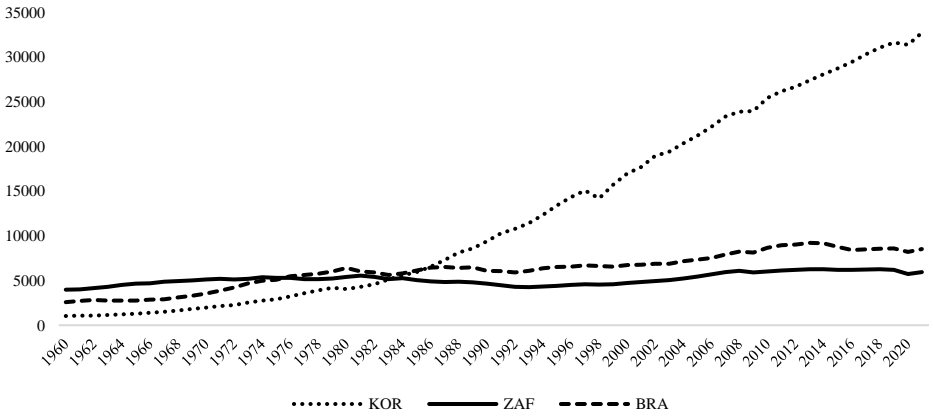

Kaynak: Dünya Bankası, 2023b.

Grafik 1’de üç ülkenin, Güney Kore, Güney Afrika ve Brezilya’nın, 1960 yılından 2022’ye kadar kişi başı GSYİH’ları görülmektedir. Grafik 1’de oldukça açık bir şekilde iki ülkenin, Güney Afrika ve Brezilya’nın, kişi başı GSYİH’nın altmış iki yıldır 5.000-10.000 USD arasında kaldığı, ancak Güney Kore’nin grafiği ise 1980’li yılların ortasından itibaren istikrarlı bir biçimde yukarıya çıkıp 30.000 USD üzerlerine geldiği görülmektedir. Grafik 1’den Güney Afrika ve Brezilya’nın GSYİH’nı artırmakta zorlandığı ancak Güney Kore’nin önemli bir gelişme kaydettiği söylenebilir. Bir başka deyişle iki ülkenin orta gelir tuzağında kaldığı ve Güney Kore’nin orta gelir tuzağından çıktığı sonucuna kabaca ulaşabiliriz.

Grafik: 2

Kişi Başı GSYİH (Arjantin-ARG, Türkiye-TUR, Uruguay-URY; Güney Kore-KOR; USD, 1960-2021)

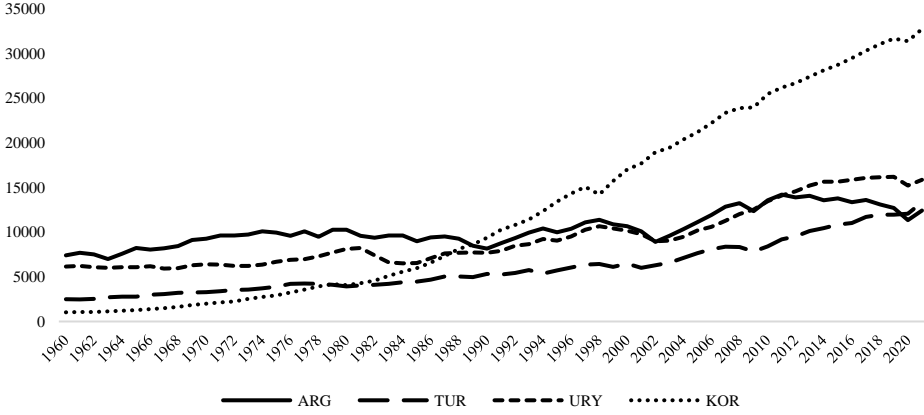

Kaynak: Dünya Bankası, 2023b.

Ancak, orta gelir tuzağında olan ve olmayan ülkeleri belirlemek açısından Grafik 2'ye bakıldığında durumun o kadar net net olmadığını görebiliriz. Grafik 2'de Arjantin, Türkiye, Uruguay ve Güney Kore'nin kişi başı GSYİH'larına bakıldığında; Güney Kore'nin kişi başı GSYİH'sinin 1980'li yılların ortasından itibaren düzenli artışı göstermesine rağmen diğer üç ülkenin 2000'li yılların başına kadar yatay bir görüntüde olduğu, ancak sonraki yıllarda artış görülmektedir. Grafik 2'deki bu görüntüden, Güney Kore'nin orta gelir düzeyinden çıktığı sonucuna varılabilirken, diğer üç ülkenin 2000'li yılların başından itibaren orta gelir tuzağından çıkıp çıkmadığını söylemek oldukça zordur. Bu nedenle, öncelikle orta gelir düzeyi nedir? Ne kadar süre orta gelir düzeyinde kalınması, orta gelir tuzağı olarak kabul edilmektedir? Orta gelir düzeyinden üst gelir düzeyine çıkıp çıkmama nasıl belirlenecektir? gibi soruların yanıtlarını ampirik yöntemlerle belirlemek gereği ortaya çıkmaktadır. Çalışmanın izleyen bölümlerinde literatürdeki bu yöntemler de tartışılacaktır.

2.1. Orta Gelir Tuzağına İlişkin Teoriler

Bazı ülkelerin neden belirli bir gelir düzeyinde uzun süre kalıp, diğerlerinin yüksek gelir düzeylerine çıktığını açıklamaya çalışan teorik ve ampirik gerekçeler bulunmaktadır. Ekonomi literatüründe bu durumun gerekçeleri genellikle büyüme, kalkınma teorilerine dayanmaktadır (Yereli vd., 2019). Literatürde orta gelir tuzağını tanımlamaya çalışan birçok teorik yaklaşım bulunmaktadır. Bu yaklaşımlardan birisi, Malthus'un nüfus teorisidir. Nüfus teorisi bir ülkenin büyümesindeki yavaşlama ve ardından yoksulluk tuzağına girmesini açıklamaktadır (Koçak & Bulut, 2014). Nüfus teorisine göre, kişi başına düşen GSYİH arttıkça, nüfusun artması, ölüm oranı azalması ve özellikle marjinal verimliliğin azalmasıyla büyüme hızı yavaşlamakta ve bunların sonucunda yoksulluk tuzağı ortaya çıkar. Ancak, orta

gelir tuzağının bir yoksulluk tuzağı olmadığı da belirtilmektedir. Orta gelir tuzağı, başlangıçta hızlı büyüme oranları nedeniyle yoksulluk tuzağından çıkıp, orta gelir düzeyine ulaşabilen, ancak daha sonra orta gelir düzeyinden çıkamaz hale gelen ülkelerin karşılaştığı bir durumdur.

Neoklasik büyüme teorisinde ölçüğe göre sabit getiri varsayımı yapılmaktadır. Dolayısıyla teknoloji, inovasyon gibi üretim faktörleri veri alınıp, sadece sermaye artışlarının büyüme artırdığı varsayılmaktadır. Sermayenin verimliliğin zaman içerisinde düşmesi sonucunda ise ülkelerin büyüme oranlarında düşüş de kaçınılmaz olup, orta gelir tuzağında bulunmaları mümkündür. Ancak günümüz modern büyüme teorilerinde ortak bir unsur vardır: ölçüğe sabit getiri varsayımını gevşeterek ve ölçek ekonomilerini vurgulamak. Ölçek ekonomileri, üretim hacmi arttıkça üretim maliyetlerinin düşme veya yeni çeşitlilikler ortaya çıktıkça ürün geliştirme maliyetlerinin düşme eğilimini ifade eder. Büyüme, uzmanlaşma ve inovasyon yoluyla ölçek ekonomilerinin bir sonucu olarak ortaya çıkar ve ürünlerin, paranın ve fikirlerin değişimi yoluyla oluşan uluslararası entegrasyona uyumla gerçekleşmektedir. Elbette bu entegrasyon, yurtiçinde kentleşme sürecinde ve gelir dağılımında vb. olası olumsuz etkileri de olacaktır. Bu değişimler iyi yönetilirse, ölçek ekonomilerine dönüşebilir. Kötü yönetilirse, bu olumsuz etkiler, politik tıkanıklık, kirlilik, sosyal sorunlar ve yolsuzluklar yoluyla ölçek ekonomilerinin ekonomik faydalarının ortadan kalkmasına yol açabilir (Gill et al., 2017). Bir başka deyişle modern büyüme teorilerinde de orta gelir tuzağının ortaya çıkması olasıdır.

Aoki (2012), üç Asya ülkesinin (Çin, Japonya ve Güney Kore) ekonomik değişimlerinden kalkınmanın 5 evresini açıklamıştır. Birinci evre, gelirin görece düşük seviyelerde ve durağan özellikte bulunduğu, istihdamın ise önemli bir kısmının yoğunlukla tarıma dayandığı "*Malthusyen evre (M-evre)*" ya da "*yoksulluk tuzağı evresi*"dir. Malthusyen evre sonrasında iki alt evreyle ilişkilendirmiştir. Birinci alt evre endüstriyel sermaye birikiminde yapısal değişimlerin yapıldığı devletin etkili olduğu, "*devlet liderliği evresi (G-evre)*" dir. Malthusyen evre sonrasında ikinci alt evresi tarımsal işgücünün azalması, yüksek doğurganlık ve bebek ölümlerinin azalmasıyla G evresinin izleyen, kalkınmanın gerçekleştiği "*Kuznets evresi (K-evre)*" dir. Dördüncü evre ise sağlık ve eğitim alanlarında gelişme sağlanması ve görece düşük doğurganlık neticesinde, işgücü verimliliğinde artış sağlanması ile kalkınmanın daha çok beşerî sermayenin gelişimine bağlı bulunduğu, "*beşerî sermaye tabanlı kalkınma evresi (H-evresi)*" dir. Beşinci ise toplam faktör verimliliğinin ve işgücünün üretim süreçlerine katılımının artış sergilediği "*post-demografik geçiş evresi (PD-evresi)*" dir (Koçak & Bulut, 2014).

Ohno (2009) Doğu Asya ülkelerinin gelişmiş ülkeleri yakalayabilmeleri için beş aşama belirlemiştir. Aşama sıfır, mono-kültür ihracatın, geçimlik tarım üretiminin olduğu ve dış yardıma muhtaç olunan aşamadır. Madencilik, tarım gibi konvansiyonel sektörler tarafından yaratılan katma değer küçüktür ve sanayileşmeye giden yolun oldukça uzun olduğu aşamadır. Birinci aşamada; fason üretim, gıda işleme, elektronik parçaların montajı gibi basit üretimler yabancıların rehberliğinde yapılmaktadır. Hemen hemen tüm girdiler yurt dışından ithal edilmekte ve üretim süreçleri yabancılar tarafından

gerçekleştirilmektedir. İkinci Aşamada, fason üretim ve makine montajı önemli boyutlara ulaşmakta, yerli endüstriler gelişmeye başlar. Zaman içerisinde, karmaşık olanlar dışındaki çoğu parça ve bileşen, yabancı doğrudan sermaye veya yerel üreticiler tarafından üretilmektedir. Ancak, üretim hala yabancı teknolojiye ve yabancıların yönetimine büyük ölçüde bağımlıdır. Üçüncü aşamada teknoloji ve yönetim yetenekleri gelişir, dışa bağımlılık önemli ölçüde azalır. Ülke, yüksek kaliteli mamul ürünlerin ihracatçısı haline gelir ve yurtdışında üretim yapmak için güçlü bir şekilde yatırım yapar. Dördüncü aşamada, inovasyon yoluyla yeni ürünler üretme ve küresel endüstriyel pazarlara liderlik etme yeteneği elde edilir. Bu aşamalara gelmek çoğu gelişmekte olan ülke için son derece zordur. Çok sayıda düşük gelirli ülke, çok az doğrudan yabancı sermaye almaktadır. Güneydoğu Asya Uluslar Birliği 4 (Endonezya, Malezya, Filipinler ve Tayland), ülkelerinden hiçbirini ikinci aşamadan üçüncü aşamaya geçememiştir. Bu noktada görünmeyen bir "cam tavan" 3. Aşamaya geçmeyi engellemektedir. Orta gelirli ülkelerin üçüncü aşamaya geçiş sağlayamaması orta gelir tuzağının varlığına işaretler (Ohno, 2009). Şekil 1'de ASEAN ülkelerinin gelişim aşamaları ve orta gelir tuzağı gösterilmektedir.

Şekil: 1
Endüstrileşmeyi Yakalayabilme İçin Beş Aşama

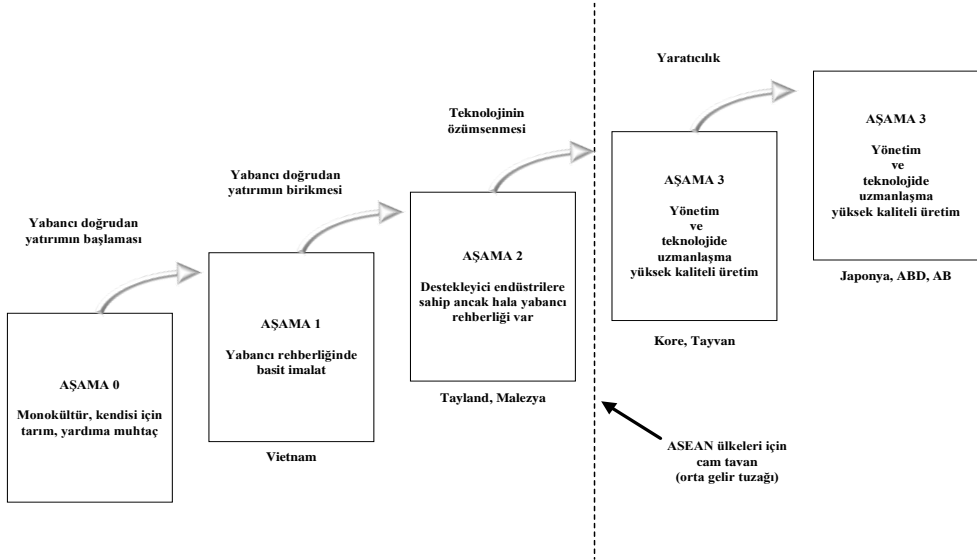

Kaynak: Ohno, 2009.

Tho (2013), ekonomik gelişme sürecini üç temel aşamaya dayandırarak, orta gelir tuzağını tanımlamaya çalışmıştır. Şekil 2'de, bir ekonominin üç ana kalkınma aşaması görülmektedir. Şekildeki A-B arası az gelişmiş ülkelerin bulunduğu, yoksulluk tuzağında bulunan aşamadır. B-C arasında ise yoksulluk tuzağından çıkılıp orta gelir düzeyine ulaşıldığı aşamadır. C-D ise orta gelir düzeyinden, düzenli büyüme oranlarıyla gelişmiş ülke

düzeyine çıktığı aşamadır. C orta gelirli noktasından sonra yeterli büyüme oranı yakalanamazsa, kişi başına gelir E noktasına doğru yatay bir seyir izlerse ülke orta gelir tuzağında demektir. Tho, çalışmasında çarpıcı bir hesaplama yapmıştır. "Kişi başına düşen yıllık gelir 500 \$ ile başlayan bir ülke için, kişi başına düşen gelirin yıllık ortalama büyüme oranı %7 ise gelir düzeyi 10 yılda iki katına çıkar. Gelirlerin üst-orta gelir seviyesine (yaklaşık 8.000 \$'a) ulaşmak için dört kez iki katına çıkması yani 40 yıl gerekir." (Tho, 2013). Bunu başarmanın çok zor olduğu ve günümüzde birçok ülkenin bunu başaramaması orta gelir tuzağı olarak adlandırılmaktadır.

Şekil: 2
Ekonomik Kalkınma Aşamaları

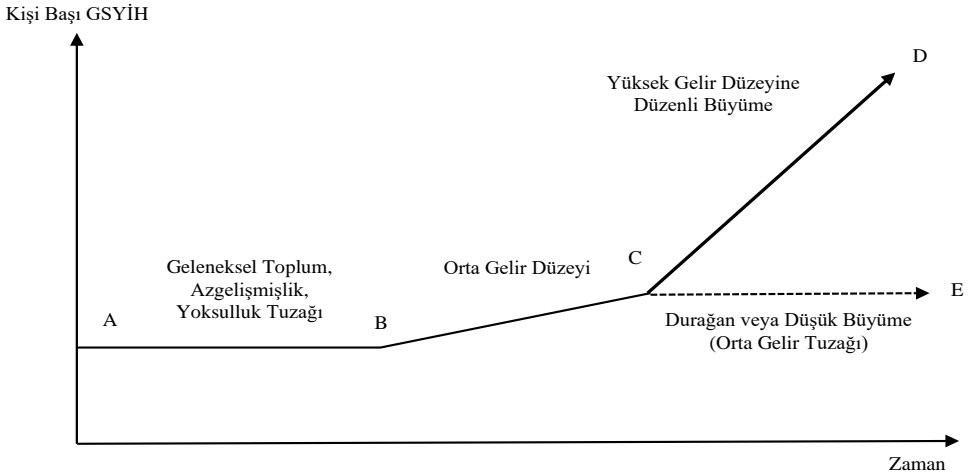

Kaynak: Tho, 2013.

Azgelişmişlikte orta gelire geçişte (B'den C'ye) üretim ve istihdam içerisinde imalat ve hizmet sektörlerinin artan paylarıyla tarımdan endüstriye dönüşüm yaşanır. Bu dönüşümde ekonomiler, faktör piyasalarında, teknolojik seviyelerinde ve karşılaştırmalı üstünlüklerde önemli yapısal değişimler yaşar. Ekonomi C'ye ulaştığında (orta gelir aşaması) bu değişimler, ülkenin yüksek gelir seviyesine geçişte (D'ye doğru geçiş), üstesinden gelinebilir zorluklar meydana getirir.

Bu zorlukların başında özellikle işgücü piyasasında işgücü fazlasından emek kıtlığına kaymasıyla birlikte reel ücretler yükselmesi bir "dönüm noktası" oluşturur ki Şekil 2'de C noktasını ifade eder. Bu noktadan sonra, ücretlerdeki reel artışa ayak uydurmak için emeğin daha verimli olması gerekir. Endüstrinin ihtiyacı olan emeğin yüksek verime dönüşümünü sağlamak için emeğin kalitesinin yükseltilmesi gerekir. Bu nedenle, hükümetlerin çabaları, yüksek gelir düzeyine geçiş için nitelikli bir işgücü sağlama yönünde olması gerekir.

İkinci olarak B'den C'ye geçiş emek ve sermayenin yoğun kullanımıyla gerçekleşmektedir. Bu aşamada emek bol, sermaye nispeten kıt. Ancak altyapıya ve endüstriyel üretime yapılan ilk yatırımlarda sermayeye duyulan ihtiyaç giderek genişlerken, teknolojik gelişme olmamaktadır. Bununla birlikte, yüksek gelir seviyesine doğru sürdürülebilir büyüme için, ülkeye giderek daha fazla teknolojik ve yönetsel kaynaklarla donatılmalı ve sermaye verimli bir şekilde kullanılmalıdır. Başka bir deyişle, ekonominin büyümesi giderek artan bir şekilde toplam faktör verimliliğine (TFP) yönltilmesi gerekir. Bu nedenle, girdi odaklı büyümeden, TFP bazlı büyümeye dönüşüm noktası yaklaşık olarak C noktasını ifade edebilir.

Üçüncü zorluk, reel ücretler artıkça, orta gelir düzeyindeki ekonomiler emek-yoğun endüstrilerde elde ettikleri karşılaştırmalı üstünlüklerini kaybederler. Bu nedenle, orta gelirli ülkelerin büyümesi, yüksek düzeyde teknik bilgi/beceri gerektiren yoğun endüstrilere ve fiziki/beşerî sermayenin artırılmasına dayanmalıdır. Orta gelirli ekonomiler, emek-yoğun endüstrilere sahip düşük gelirli rakip ülkeler ile yenilikçi ve görece hızlı teknolojik değişim gerçekleştiren yüksek gelirli ülkeler arasında sıkışmış durumdadır. Bu durum, ülkenin karşılaştırmalı üstünlük yapısının zaman içinde değişmesi gerektiği anlamına gelmektedir. Bu tür dinamik karşılaştırmalı avantajlar, yalnızca faktör donanımında, özellikle de beşerî sermayedeki değişiklikler ile teknolojik ve yönetsel kaynakların mevcudiyetiyle sağlanabilir. Açık ekonomide, özellikle küreselleşme ve bölgesel serbest ticaret anlaşmaları çağında, uluslararası rekabet gücünün iyileştirilmesi, sürdürülebilir büyüme için esastır. Bu dönüşüm noktası, ülkelerin uygulayacağı, ekonomik, teknolojik, yönetsel ve inovasyona yönelik politikaların sonucunda yaşanacaktır. Yukarıda da sözü edildiği gibi, bu tür politikaların uygulanmaması, uygulamadaki başarısızlıklar sonucu ülkeler orta gelir tuzağından çıkamamaktadırlar. Neticede, Şekil 2'de gösterilen C noktasından D seviyesine evrimde güçlüklerle karşılaşmaktadırlar.

Chen ve Dai (2014), orta gelir tuzağının sebeplerini açıklayan politik iktisat, kamusal tercihler teorisi açısından yeni bir yaklaşım getirmişlerdir. İlk olarak, ekonomik kurumlar üzerine uzun bir literatür ekonomik kalkınma için sınırlandırılmış hükümet ve regüle edilmemiş kredi piyasasının avantajlarını vurgulamıştır. Çalışmalarında, siyasi aktörlerin çarpık politikalar üreterek ekonominin daha iyi ekonomik performans göstermesini engelleyeceğini iddia etmektedirler. İkincisi, orta gelir tuzağına ilişkin mevcut görüşler/teoriler, benzer teknolojik ve demografik geçmişe sahip ülkelerin orta gelir tuzağından kaçmak için neden farklı sonuçlar elde ettiklerini açıklayamadığını belirtmişlerdir. Bu farklılığın nedenini hükümet müdahalesinin piyasalarda bozucu etkiler yaratıp büyümenin önüne geçtiğini ileri sürmektedirler. Dolayısıyla hükümetlerin siyasi destek kazanmak için ve özel çıkar gruplarının istediği politikalar uygulamasını önleyici bir monitör sistemine ihtiyaç olduğunu belirtmişlerdir. Son olarak devlet müdahalesinin, finans piyasalarındaki regülasyonun, yolsuzluğun azaltıldığı bir ekonomide orta gelir tuzağından çıkılacağı belirtilmektedir.

2.2. Orta Gelir Tuzağının Tespit Edilmesine Yönelik Yöntemler

2000'li yıllarda ortaya çıkan "orta gelir tuzağı" kavramı, iktisat literatüründe nispeten yeni bir olgudur ve bu kavramın tanımlanması noktasında literatürde herhangi bir fikir birliği bulunmamaktadır. Ancak, bu kavramın, en genel manada, orta gelirli ekonomilerde kişi başına düşen gelirin belirli bir düzeyi aşmaması veya aşmakta güçlük çekmesiyle ilgili olduğu söylenebilir. Bu çerçevede, ilgili literatürde orta gelir tuzağının varlığının tespitine yönelik çeşitli yaklaşımlar geliştirilmiştir. Bu yönde ortaya atılan iki ana yaklaşımdan ilki orta gelir tuzağını kişi başına gelir düzeylerinde zayıf veya durgun sayılabilecek büyüme performansı ile ilişkilendirmektedir (Felipe et al., 2012; Eichengreen et al., 2013). İkinci yaklaşım ise orta gelir tuzağını temelde kişi başına gelir düzeylerini gelişmiş ekonomilerdeki verilerle kıyaslama ve düşük gelirli ülkelerin kişi başına gelir düzeyi bakımından gelişmiş ülkelere göreli olarak yakınsama durumlarını analiz ederek açıklamaktadır (Woo, 2012; Robertson & Ye, 2013).

Eichengreen vd. (2013) orta gelir tuzağını en genel tabirle yüksek kişi başı gelir seviyelerine ulaşılması için yeterince yüksek büyüme oranlarının sürekliliğinin olmaması durumu ile, diğer bir ifadeyle, "büyüme yavaşlaması" olgusu ile açıklamaktadır. Çalışmaya göre "büyüme yavaşlaması" durumu üç koşulun bir arada bulunmasına bağlı kılınmıştır. Bu koşullar; (i) yedi yıllık ortalama kişi başına düşen gelir artış oranının (2005 sabit fiyatlarla ve satın alma gücü paritesine göre uyarlanmış) minimum %3,5 olması, (ii) kişi başına düşen gelir artış hızında ardışık dönemler itibarıyla en az %2 azalma olması ve (iii) bu azalmanın kişi başına düşen GSYİH'nin en az 10.000 USD olduğu görece olgun ekonomilerde gerçekleşmesi şeklindedir. Yazarlar büyüme yavaşlamasının GSYİH'nin 10.000-11.000 USD ve 15.000-16.000 USD olmak üzere iki ayrı seviyede farklı biçimlerde gözlemlendiğini belirtmişlerdir.

Felipe vd. (2012) orta gelir tuzağını 'alt orta gelir tuzağı' ve 'üst orta gelir tuzağı' olarak ikiye ayırmaktadır. Çalışmada, satın alma gücü paritesine göre belirlenen kişi başına gelir kategorileri ise şu şekildedir: (i) 2.000 USD altındakiler düşük gelir, (ii) 2.000 USD ile 7.250 USD arasında olanlar düşük-orta gelir, (iii) 7.250 USD ile 11.750 USD arasında olanlar üst-orta gelir ve (iv) 11.750 USD üzerindeki ise yüksek gelir grubudur. Çalışmaya göre, bir ülkenin orta gelir tuzağında olması için 28 yıldan fazla bir süre alt orta gelir kategorisinde ve 14 yıldan fazla sürede de üst orta gelir kategorisinde bulunması gerekmektedir.

Woo (2012) orta gelir tuzağını açıklamak için 'yakalama endeksi yaklaşımı'nı (Catch-Up Index-CUI) geliştirmiştir. Yazara göre bu yaklaşım, genel itibarıyla, ülkelerin ekonomik ve teknolojik olarak lider bir ülkeyi yakalaması olarak tanımlanabilir (genellikle ABD veya Japonya). Bu yaklaşıma göre bir ülkede yakalama endeksi %55'ten büyük ise yüksek gelirli, %55-%20 arasında ise orta gelirli, %20'den küçükse ülke düşük gelirli bir ülkedir.

Robertson ve Ye (2013) ise orta gelir tuzağının varlığını sınamak için ampirik bir yöntem geliştirmişlerdir. Bu yöntemde orta gelir grubundaki ülkelerin kişi başına gelir artış oranı (2005 sabit fiyatlarla ve satın alma gücü paritesine göre uyarlanmış) için ADF birim kök testinin kullanılması öngörülür. Bu yöntemde göre eğer orta gelir grubunda bulunan bir ülkenin kişi başına düşen gelir düzeyi uzun dönemde ABD'nin kişi başına düşen gelirine yakınsama sergilemiyorsa bu ülkede orta gelir tuzağının mevcudiyetinden söz edilebilir. Robertson ve Ye (2013) kişi başına düşen GSYİH'si ABD'ninkinin %8'i ile %36'sı düzeyinde bulunan ve kişi başı gelir düzeylerinin gelişmiş ekonomilere yakınsaması bakımından yetersiz kalan ülkelerin orta gelir tuzağında olabileceğini belirtmektedir. Bu yöntemde, incelenen örnek ülkenin GSYİH'sinin doğal logaritmasından ABD'nin GSYİH'sinin doğal logaritmasının çıkarılması suretiyle elde edilen '*fark serisi*'ne birim kök testlerinin uygulanmasıyla durağanlık analizi gerçekleştirilir. Bu analiz neticesinde ilgili serinin (fark serisinin) durağan olduğunun tespit edilmesi durumunda incelenen ülkenin orta gelir tuzağında olduğu sonucuna ulaşılır. Ayrıca, bu yöntemle, incelenen örnek ülkenin gelişmiş ülkelerle mukayese edilmesi suretiyle de kişi başı gelir bakımından bu ülkeleri yakalama eğiliminde olup olmadığı da tespit edilebilmektedir. Bu çalışmada incelenen ülkelerin orta gelir tuzağında bulunma durumlarının sınanması amacıyla bu yöntem benimsenmiştir.

3. Amaç, Kapsam ve Yöntem

Çalışma dahilinde üç farklı ampirik yöntemden yararlanılmıştır. Bu çerçevede, öncelikle, çalışma kapsamında incelenen ülkelerin orta gelir tuzağında olup olmadıkları hususunun tespiti için Robertson-Ye (2012) yöntemine başvurulmuştur. Bu amaçla, ikinci nesil yapısal kırılmalı birim kök testlerinden olan '*düzeyde iki kırılmaya izin veren Narayan & Popp (ADF Testi) (Model A) yapısal kırılmalı birim kök testi*' uygulanmıştır. İkinci aşamada ise incelenen ülkelerde vergi gelirlerinin kompozisyonu (dolaylı vergilerin toplam vergi gelirleri içindeki payı) ile gelir düzeyi (kişi başı GSYİH) arasındaki nedensellik ilişkisi sınanmıştır. Bu amaç doğrultusunda ise bahsi geçen serilere "*Dumitrescu & Hurlin Panel Nedensellik Testi*" uygulanmıştır. Son olarak, çalışma kapsamında analiz edilen ülkelerde orta gelir tuzağından kurtulma durumunun, dolaylı vergilerin toplam vergi gelirleri içindeki payı üzerindeki olası etkileri "*statik panel veri analizi*" yöntemi yardımıyla araştırılmıştır. Analizde incelenen ülke grubu olarak genel çerçevede yükselen piyasa ekonomileri ve özelde ise Yükselen G20 ülkeleri örnek alınmıştır. Verilerin mevcudiyeti dahilinde incelenen örnek ülkeler; Arjantin, Brezilya, Meksika, Güney Afrika ve Türkiye'dir.

3.1. Orta Gelir Tuzağının Robertson & Ye Yöntemiyle Analizi

Bir ülkenin orta gelir tuzağında olup olmadığının test edilmesine yönelik yaklaşımlardan biri de Robertson ve Ye (2013) tarafından geliştirilmiş olan '*Robertson & Ye Yaklaşımı*'dir. Bu yaklaşımın temelinde, düşük gelirli ülkelerin gelişmiş ülkelerdeki kişi başı GSYİH rakamlarına yakınsayıp yakınsamama durumunun incelenmesi bulunur.

Bu yöntem referans ülke olarak ABD'yi belirlemiştir. Nitekim bu yaklaşımda, incelenen ülkenin ya da ülkelerin kişi başı GSYİH verisinin doğal logaritmasından ABD'nin GSYİH'sinin doğal logaritması çıkarılır ve böylece elde edilen seriyeye (fark serisine) durağanlık analizi (birim kök testleri) uygulanır. Uygulanan testlerin sonucunda fark serisinin durağan olduğu bulgulanmış ise incelenen ülkenin orta gelir tuzağında olduğu; aksi durumda ise analize konu ülkenin orta gelir tuzağında olmadığı sonucu elde edilir.

Bu çalışmada, incelenen ülkelerin orta gelir tuzağında olup olmadığının ampirik olarak sınanmasında Robertson & Ye (2013) yöntemi esas alınmıştır. İncelenen ülkelerin hangilerinin orta gelir tuzağında olduğu ve hangilerinin tuzaktan kurtulmuş bulunduğu hususunun tespitine yönelik ikinci nesil yapısal kırılmalı birim kök testi olan düzeyde iki kırılmaya izin veren Narayan & Popp (ADF Testi) (Model A) yapısal kırılmalı birim kök testinden faydalanılmıştır.

Veri

Analizde, çalışma kapsamına dahil edilen ülkelerin kişi başına GSYİH verisi (sabit-2015/USD) kullanılmıştır. Veriler yıllık bazda olup 1960-2021 yılları arası döneme aittir ve Dünya Bankası veri tabanından elde edilmiştir (Dünya Bankası, 2023b). Kullanılan yöntem uyarınca önce incelenen ülkelerin kişi başı GSYİH'sinin doğal logaritması alınmış ve referans ülke ABD'nin logaritmik kişi başına GSYİH verisi bu ülkelerin logaritmik verilerinden çıkarılarak fark serileri elde edilmiştir. Son olarak ise logaritmik fark serilerine düzeyde iki kırılmaya izin veren Narayan & Popp (ADF Testi) (Model A) yapısal kırılmalı birim kök testi uygulanmıştır.

Bu çerçevede, Tablo 2'de Narayan & Popp (ADF Testi) yapısal kırılmalı birim kök testinde kullanılan serilere ilişkin tanımlayıcı istatistik değerleri yansıtılmıştır. Tanımlayıcı istatistik değerlerinin verilere ilişkin ön fikir sağlama fonksiyonunu haizdir.

Tablo: 2
Betimletici İstatistikler (Narayan & Popp (ADF) Yapısal Kırılmalı Birim Kök Testi)

	Arjantin	Brezilya	Meksika	Güney Afrika	Türkiye	ABD
Ortalama	10355,27	6146,803	7547,897	5169,119	6004,498	39806,71
Medyan	9946,598	6407,569	7864,122	5129,213	5286,042	39158,85
Maksimum	14200,27	9216,143	10120,36	6263,104	13341,60	61855,52
Minimum	6986,565	2578,432	3897,084	3974,034	2468,316	19135,27
Std. Sapma	1917,590	1942,351	1759,686	650,5111	2886,084	12848,52
Çarpıklık	0,495713	-0,367450	-0,554729	0,220421	0,873442	0,055127
Basıklık	2,309096	2,246881	2,232834	2,059361	2,746435	1,665604
Jarque-Bera	3,772372	2,860442	4,700218	2,787786	8,049402	4,631316
Olasılık	0,151649	0,239256	0,095359	0,248108	0,017869	0,098701
Gözlem	62	62	62	62	62	62

Aşağıda ise Narayan & Popp (ADF Testi) yapısal kırılmalı birim kök testinde kullanılan serilere (logaritmik fark serilerine) ilişkin grafikler yer almaktadır:

Grafik: 3
Logaritmik Fark Serileri

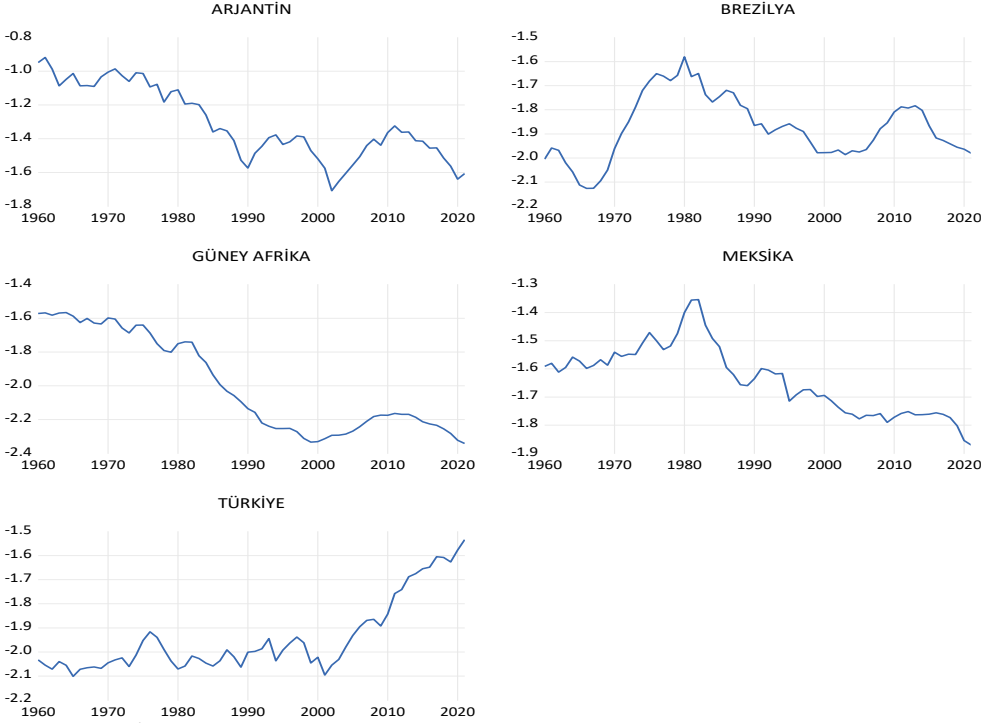

Yukarıdaki serilere ilişkin grafikler incelendiğinde yalnızca Türkiye'nin kişi başı GSYİH bazında referans ülke olan ABD'ye yakınsadığını, diğerlerinde ise ABD ile aralarındaki gelir düzeyi farkının açıldığı anlaşılmaktadır. Bu durum incelenen ülkelerden yalnızca Türkiye'nin orta gelir tuzağından kurtulmuş olabileceği yönünde ön fikir sağlamaktadır. Bunun ampirik olarak test edilmesi amacıyla logaritmik fark serilerine uygulanan yapısal kırılmalı birim kök test bulguları ise Tablo 3'te yansıtılmaktadır:

Tablo: 3
Narayan & Popp (ADF Testi) Yapısal Kırılmalı Birim Kök Test Sonuçları

Narayan & Popp (ADF Testi) Model A: Düzeyde İki Kırılma					
Ülke	İstatistik	Kırılma Yılı	λ	Gecikme	Karar
Arjantin	-4,406	1983/2004	0,371/0,726	0,000	Durağan
Brezilya	-5,294	1968/2005	0,145/0,742	1,000	Durağan
Meksika	-4,792	1972/1984	0,210/0,403	1,000	Durağan
Güney Afrika	-5,120	1981/2003	0,355/0,710	1,000	Durağan
Türkiye	-3,938	2003/2009	0,710/0,806	0,000	Durağan Değil

Logaritmik fark serilerine ikinci nesil yapısal kırılmalı birim kök testlerinden olan ve düzeyde iki kırılmaya izin veren Narayan & Popp (ADF) yapısal kırılmalı birim kök testi (Model A) uygulanmıştır. Tablo 3'te yansıtılan bulgular incelendiğinde logaritmik fark serilerinden yalnızca Türkiye'nin istatistiki olarak %5 anlamlılık seviyesinde durağan olmadığı tespit edilmiştir. Diğer ülkelere ilişkin logaritmik fark serilerinin ise durağan olduğu anlaşılmaktadır. Bu ise orta gelir tuzağının mevcudiyetinin sınanmasında benimsenen Robertson & Ye yaklaşımı uyarınca, incelenen ülkelerden Türkiye haricindekilerin orta gelir tuzağından kurtulamamış olduğunu yansıtır niteliktedir. Türkiye'nin 2003 yılında orta gelir tuzağından kurtulacak şekilde kırılma göstermesinin (orta gelir tuzağından kurtulmasının) belki en geçerli nedeni 2001 ekonomik krizinden sonra IMF ile birlikte uygulanan ekonomi programı olabilir. Güçlü Ekonomiye Geçiş Programı olarak adlandırılan tedbirler arasında, para ve sermaye piyasalarının kurala bağlanması, merkez bankasının bağımsızlığıyla ilgili kararlar, mali disiplin ve mali şeffaflıkla ilgili kararlar sonucunda yüksek büyüme oranlarının yakalanması sağlanmıştır. Bu çerçevede, Narayan & Popp (ADF) yapısal kırılmalı birim kök testi (Model A) neticesinde Türkiye'ye ait logaritmik fark serisinde 2003 yılında tespit edilen yapısal kırılma çalışmamız dahilindeki statik panel analizine esas ekonometrik modele orta gelir tuzağından çıkışı temsilen kukla değişken olarak eklenecektir. Nitekim Grafik 3'te yer alan Türkiye'nin logaritmik fark serisi görseli incelendiğinde, serinin söz konusu kırılma tarihinden itibaren artan trend göstermeye başladığı, diğer bir ifadeyle, bahsi geçen kırılma tarihinden itibaren Türkiye'nin kişi başı GSYİH rakamlarının ABD'ninkine yakınsama sergilediği anlaşılmaktadır.

3.2. Vergi Gelirlerinin Kompozisyonu ile GSYİH Arasındaki Nedensellik İlişkisi

Çalışmamızın bu kısmında vergi gelirlerinin kompozisyonu (dolaylı vergilerin toplam vergi gelirlerindeki payı) ile kişi başı GSYİH arasındaki muhtemel nedensellik ilişkisi incelenmiştir. Vergi hasılatını etkileyen çok sayıda faktör vardır. Ekonomik, politik, sosyolojik, psikolojik, tarihsel, kültürel birçok faktör vardır. Bu faktörlerin vergi hasılatını ne yönde etkilediğine yönelik birçok çalışma yapılmıştır. Ekonomik faktörler arasında fiyatlar genel düzeyi, ekonomik büyüme, gelir dağılımı, toplam üretimin sektörel yapısı, ülkenin uluslararası ticarete açıklık derecesi, toplam iç/dış borç düzeyi, kayıt dışı ekonomi ve vergi oranları sayılabilir. Makroekonomik faktörler arasında en önemli olanları elbette gelir ve tüketim ile gelir dağılımıdır. G20 ülkelerinin gelir dağılımıyla ilgili istatistiki verilerinde eksiklik olduğu için araştırmaya dahil edilmemiştir.

Büyüme/GSYİH ve vergi gelirleri arasındaki nedensellik ilişkisini inceleyen çok sayıda araştırma yapılmıştır. Bu ilişki iki yönlü olarak araştırılmıştır. Bir başka deyişle, vergilerin büyümeyi ne yönde etkilediği ile büyümenin vergi hasılatlarını nasıl etkilediği araştırma konusu yapılmıştır (Terzi & Yurtkuran, 2016). Bu çalışmalardan bazıları vergi gelirleri ile büyüme arasında çift yönlü nedensellik tespit etmiştir (Ray et al., 2012). Vergilerin kompozisyonu ile GSYİH arasındaki ilişkinin incelendiği bazı çalışmalardan bazılarında (Abdiyeva & Baygonuşova, 2016; Açıkgoz, 2008; Helhel & Demir; 2012)

dolaysız vergilerden GSYİH'ye doğru tek yönlü nedensellik tespit edilirken; çift yönlü nedensellik ilişkisinin bulunduğu çalışmalar da mevcuttur (Durkaya & Ceylan, 2006).

Vergilerin ekonomik büyüme/GSYİH'yi negatif yönde etkilemesi genel kabul görmüş bir yaklaşımdır. Ekonomik büyümeyi etkileyen faktörlerin artışı, ekonomik büyüme artırarak vergi tabanı genişleyecektir (Sen Gupta, 2007; Sağdıç, 2019). Bu açıdan fiziki ve beşerî sermayenin artması, teknolojik yenilikler, yatırımların artışı, tüketim düzeylerinin artması, firma gelirlerinin artması gibi birçok faktör dolaysız vergi gelirlerini arttıracaktır (Sağdıç & Aydın, 2021). Bu yaklaşımın bir sonucu olarak vergi indirimlerinin büyüme/GSYİH'yi artırıcı etki yapacağı önerilir. Büyüme/GSYİH'nin vergi gelirleri üzerine etki yönüne bakıldığında ise genellikle pozitif yönde bir ilişki beklenir. Bir başka deyişle gelir düzeyi arttıkça vergi hasılatının da artması beklenir¹. Bu noktada, vergi hasılatının ekonomik büyüme ve tüketim düzeyi ile ilişkisi, orta gelir tuzağından çıkıldığı zaman vergi hasılatının bileşimini nasıl etkilediğinin belirlenmesi açısından önem kazanmaktadır. Bu nedenle, çalışmamızda, ekonomik büyümenin vergi hasılatının bileşimi üzerindeki olası etkilerini tartışmanın yararlı olacağını düşündük.

Vergi gelirlerini dolaylı ve dolaysız olarak iki ana gruba ayırmak, büyümenin vergi gelirlerinin kompozisyonunu nasıl etkilediğini açıklamak için faydalı olacaktır (Turhan, 1987). Öncelikle, dolaysız vergilerin bireysel ve kurumsal gelir üzerinden alındığı düşünüldüğünde, ekonomik büyümenin tüm diğer değişkenler sabit iken, dolaysız vergi gelirlerinde artış sağlayacağı söylenebilir. Ancak, bir vergi hasılatı artışı var mı? veya artışın miktarı ne kadar olacak? sorularının yanıtları, dolaysız vergilerin gelir esnekliğiyle ilişkilidir. Gelir esnekliği pozitif ve aynı zamanda görece yüksek ise orta gelir tuzağından çıkıldığında vergi hasılatı da o kadar çok artacaktır.

İkinci ilişki olarak, orta gelir tuzağından çıkıldığında gelir dağılımının nasıl etkilendiği de önemlidir. Eğer gelir dağılımı yüksek gelirli lehine daha da bozulmuş ise özellikle artan oranlı dolaysız vergilerin (genellikle bireysel gelir vergileri) yüksek gelirli dolaysız vergi hasılatını oransal olarak artıracığı söylenebilir. Gelir dağılımının daha adil hale gelmesi halinde ise artan oranlılığın etkisi çok fazla olmayacaktır.

Dolaylı vergiler açısından da benzer bir ilişki kurulabilir. Orta gelir tuzağından çıkıldığında, ekonomik büyümenin ilk bakışta dolaylı vergi hasılatını olumlu etkilemesi beklenir. Ancak, orta gelir tuzağından çıkıldığında dolaylı vergi hasılatının nasıl etkilendiğinin belirlenmesinde tüketim düzeyindeki değişim özellikle önemlidir. Tüketim düzeyi ise temelde kullanılabilir gelir düzeyi ve marjinal tüketim eğilimine bağlıdır. Ekonomik büyümedeki artış, tüm diğer değişkenler sabit iken, kullanılabilir geliri artırabilir. Ancak kullanılabilir gelirdeki bu artışın tüketim düzeyindeki etkisi marjinal tüketim eğilimi düzeyine bağlıdır. Marjinal tüketim eğilimi yüksek veya orta gelir tuzağından çıkıldığında

¹ Ancak bu pozitif ilişki her zaman ve her ülkede gerçekleşmeyebilir.

yükselmiş ise dolaylı vergi gelirlerinin artması beklenir. Tersini durumda ise dolaylı vergi gelirlerinin azalışı sergilemesi beklenebilir.

Dolaylı vergi hasılatları, üzerinden alındığı tüketim mallarının fiyat esnekliğine de bağlıdır. Eğer fiyat esnekliği düşük mal/hizmetlerden yoğun bir şekilde dolaylı vergi alınmıyorsa vergi hasılatı tüketim arttıkça daha da artacaktır. Ancak fiyat esnekliği yüksek mal/hizmetlerden alınmıyorsa toplam vergi hasılatı olumsuz etkilenecektir.

Veri

Bu kısımda çalışma dahilinde incelenen ülkelerde vergi gelirlerinin kompozisyonu ile kişi başı GSYİH arasındaki nedensellik ilişkisi Dumitrescu & Hurlin Panel Nedensellik testi yardımıyla incelenmiştir. Analizde vergi gelirlerinin kompozisyonunu temsilen dolaylı vergilerin toplam vergi gelirleri içindeki payı verisi (DV/TV) yıllık olarak alınmıştır. Analizde kullanılan diğer veri ise incelenen ülkelerde kişi başı GSYİH'daki yıllık büyüme oranıdır. Veriler Dünya Bankası veri tabanından elde edilmiştir (Dünya Bankası, 2023b). Tablo 4'te Dumitrescu & Hurlin panel nedensellik testinde kullanılan serilere ilişkin tanımlayıcı istatistikler yansıtılmıştır.

Tablo: 4
Betimleyici İstatistikler (Dumitrescu & Hurlin Panel Nedensellik Testi)

İSTATİSTİK	DV/TV	GSYİH (%)
Ortalama	0.607216	1,253180
Medyan	0.652528	1,580821
Maksimum	0.856304	9,844296
Minimum	0.374946	-11,84595
Std. Sapma	0.130225	4,090714
Çarpıklık	-0,259615	-0,562876
Basıklık	1,756584	3,386590
Jarque-Bera	11,72628	9,149979
Olasılık	0,002842	0,010306
Gözlem	155	155

Diğer yandan aşağıda ise panel nedensellik analizinde kullanılan serilere ilişkin görseller yer almaktadır:

Grafik: 4
Dolaylı Vergiler/Toplam Vergi Gelirleri

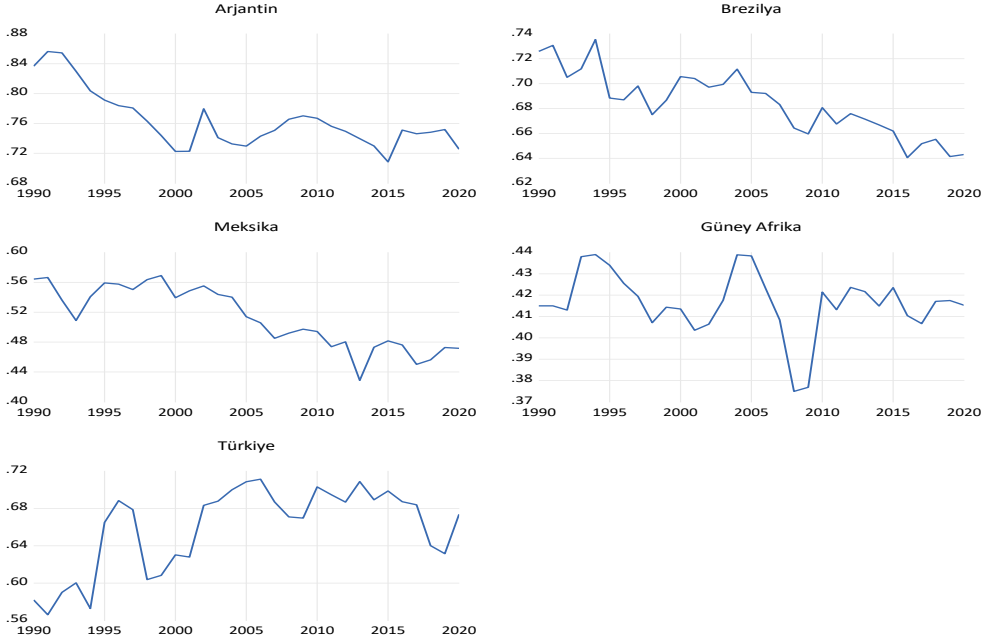

Grafik: 5
Kişi Başı GSYİH (Yıllık Büyüme Oranı)

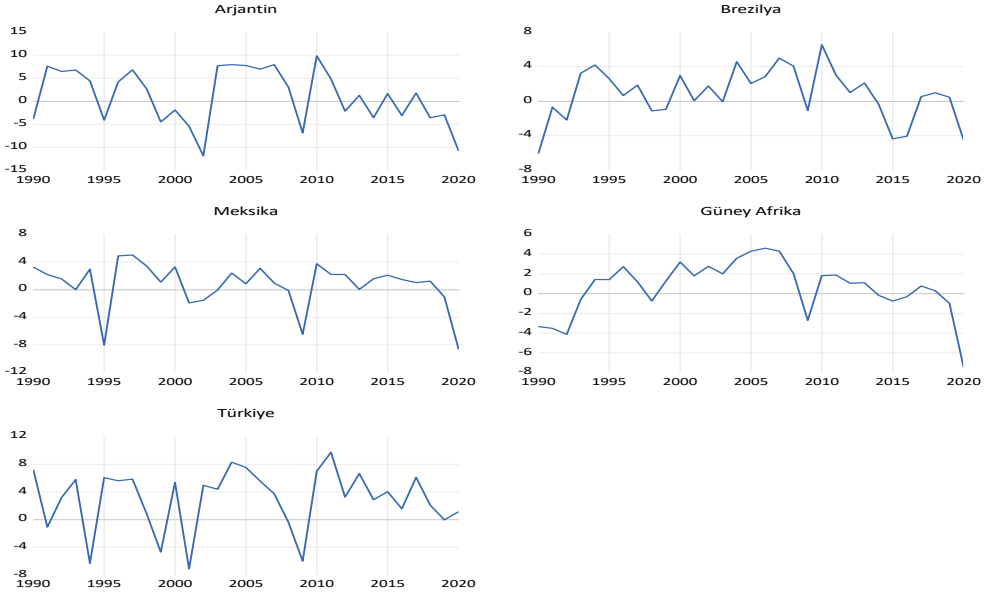

Analizde yararlanılan serilere ilişkin olası bir birimler arası korelasyon ilişkisinin mevcudiyetinin sınanması amacıyla Pesaran CD testine (2004) başvurulmuştur. Pesaran CD Testinin (2004) hipotezleri aşağıdaki gibidir:

H_0 : Birimler arası korelasyon (yatay kesit bağımlılığı) yoktur.

H_1 : Birimler arası korelasyon (yatay kesit bağımlılığı) vardır.

Bu doğrultuda, Tablo 5'te yatay kesit bağımlılığı testinin (Pesaran CD Testi- 2004) bulguları yansıtılmıştır:

Tablo: 5
Yatay Kesit Bağımlılığı Testi (Pesaran CD Testi) Bulguları

Değişken	Pesaran CD Testi	
	t İstatistiği	Olasılık Değeri
DV/TV	1,147	0,251
GSYİH	6,814	0,000

Yatay kesit bağımlılığı testi sonucunda birimler arası korelasyonun tespit edilmesi durumunda yatay kesit bağımlılığını dikkate alan birim kök testlerinin kullanılması gerekir. Aksi durumda ise birimler arasında yatay kesit bağımlılığını dikkate almayan birim kök testlerinin kullanılması gereklidir. DV/TV serisine (vergi gelirlerinin kompozisyonu serisine) ilişkin yatay kesit bağımlılığı test sonucuna göre H_0 hipotezi reddedilemez, diğer

bir ifadeyle, DV/TV değişkeninde yatay kesit bağımlılığı mevcut değildir. Bu sebeple, DV/TV değişkeninin durağanlık sınamalarında birimler arasında yatay kesit bağımlılığını dikkate almayan birim kök testlerinin kullanılması gerekir. GSYİH serisinin yatay kesit bağımlılığı test sonucuna göre ise H_0 hipotezi reddedilmektedir. Dolayısıyla, GSYİH değişkeninde yatay kesit bağımlılığını dikkate alan birim kök testlerinin kullanılması gereklidir.

Değişkenlerin durağanlık durumlarının sınanması amacıyla serilere birim kök testleri uygulanmıştır. Nitekim serilerin analiz edilmeleri için durağan olmaları gerekmektedir.

Birim kök testlerinin hipotezleri aşağıdaki şekildedir:

H_0 : Birim kök vardır (Seri durağan değildir).

H_1 : Birim kök yoktur (Seri durağandır).

Tablo 6'da değişkenlere uygulanan birim kök test sonuçları yer almaktadır:

Tablo: 6
Birim Kök Testi Bulguları- Dumitrescu & Hurlin Panel Nedensellik Testi

DV/TV		GSYİH	
IM, Pesaran & Shin		Pesaran CIPS	
Sabitli Model	Sabitli ve Trendli Model	Sabitli Model CIPS t ist.: -3.356	Sabitli ve Trendli Model CIPS t ist.: -3.152
-2,103 (0,017)	-2,179 (0,014)	%1 %5 %10 -2,57 -2,33 -2,21	%1 %5 %10 -3,10 -2,86 -2,73

Not: Parantez içi değerler olasılık değerlerini gösterir.

GSYİH serisine ilişkin CIPS t istatistiği değerleri kritik değerlerden (%1, %5 ve %10 istatistiki anlamlılık düzeylerinde) küçük olduğu için H_0 hipotezi reddedilir. Tablo 7'de DV/TV serisi için parantez içi değerler olasılık değerleridir. Parantez içindeki olasılık değerleri %1'den küçük olduğu için (sabitli model ile sabitli ve trendli model için) H_0 hipotezi %1 anlam düzeyinde reddedilir. Bu çerçevede, değişkenlere ilişkin birim kök test sonuçları incelendiğinde hem DV/TV hem de GSYİH değişkeni için H_0 hipotezi reddedilmiştir. Dolayısıyla her iki serinin de durağan olduğunu ifade eden H_1 hipotezi reddedilemez. Sonuç olarak, nedensellik analizinde DV/TV ve GSYİH değişkenleri analizde düzey durumlarıyla kullanılacaktır.

Tanı testlerini takiben DV/TV ve GSYİH serilerine Dumitrescu & Hurlin panel nedensellik analizi uygulanmıştır. Dumitrescu & Hurlin panel nedensellik testi hipotezleri aşağıdaki şekildedir:

H_0 : Nedensellik yoktur.

H_1 : Nedensellik vardır.

Dumitrescu & Hurlin Panel Nedensellik Testi sonuçları Tablo 7'de yansıtılmaktadır:

Tablo: 7
Dumitrescu & Hurlin Panel Nedensellik Testi Bulguları

Hipotez	W istatistiği	Z istatistiği	Olasılık Değeri
GSYİH DV/TV'nin nedeni değildir.	5,678	3,271	0,001
DV/TV GSYİH'nin nedeni değildir.	5,016	2,651	0,008

Dumitrescu & Hurlin panel nedensellik testi bulguları incelendiğinde; DV/TV ile GSYİH arasında karşılıklı (çift yönlü) nedensellik ilişkisi tespit edilmiştir (H_0 hipotezi reddedilmiş H_1 hipotezi kabul edilmiştir). Başka bir ifadeyle; GSYİH değişkeni DV/TV değişkeninin nedenidir, GSYİH değişkenindeki değişiklikler DV/TV üzerinde istatistiki olarak %1 düzeyinde anlamlı değişikliğe neden olmaktadır.

Benzer şekilde, DV/TV değişkeni GSYİH'nin nedenidir. DV/TV'deki değişiklikler GSYİH değişkeni üzerinde istatistiki olarak %1 anlamlılık düzeyinde istatistiki olarak anlamlı bir değişikliğe neden olmaktadır.

Panel nedensellik test bulguları kişi başı GSYİH'deki büyüme ile dolaylı vergilerin toplam vergi gelirlerindeki payı arasında karşılıklı bir nedensellik ilişkisinin bulunduğu yönündedir. Bu ise her iki değişkenin de karşılıklı olarak birbirinden etkilendiğini açıklamaktadır.

Türkiye'de Kasım 2000 ve Şubat 2001 ekonomik krizlerinden sonra "*Güçlü Ekonomiye Geçiş Programı*" çerçevesinde IMF ile yapılan istikrar programında özellikle mali yapının düzenlenmesi amacını güden uzun vadeli vergi ve harcama politikalarına da odaklanılmıştır. Bu çerçevede, vergi sisteminin basitleştirilmesi ve dolaysız vergilerde gerçekleştirilecek değişiklikler üzerinde durulmuştur (Ay & Haydanlı, 2018: 67). Bu uygulamalar neticesinde, 2006-2007 yıllarından sonra Türkiye'de dolaylı vergilerin toplam vergiler içindeki payının azalış trendi sergilemeye başladığı söylenebilir. Nitekim Grafik 5'te yer alan Türkiye'ye ait görsel incelendiğinde bu durum açıkça görülmektedir.

Diğer yandan, gelişmekte olan ülkelerde dolaylı vergilerin toplam vergiler içindeki payı genellikle gelişmiş ekonomilere göre daha yüksektir. Örneğin, Türkiye'de bu oran 1990'lardan günümüze %60-70 seviyelerinde seyretmektedir. Söz konusu oranın görece yüksek olması kısmen dolaysız vergiye karşı direncin de yüksek olması durumuyla açıklanabilir. Bu çerçevede, direncin azaltılması, özellikle de gelişmekte olan ülkelerde, merkezi ve yerel yönetimlerce gerçekleştirilen yatırımların halka anlatılarak vergiye uyumun artmasıyla sağlanabilir (Oluklulu & Çakır, 2018: 34).

3.3. Orta Gelir Tuzağı ve Vergi Gelirlerinin Kompozisyonu Arasındaki İlişki

Çalışmanın bu kısmında ise analize konu ülkelerin orta gelir tuzağından kurtulmasının söz konusu ülkelerin vergi gelirlerinin kompozisyonu üzerindeki olası etkileri incelenmiştir. Bu amaç doğrultusunda, statik panel veri analizi yöntemi uygulanmıştır. Analize temel teşkil eden ekonometrik model aşağıdaki gibidir:

$$DV/TV = \alpha + \beta_1 GSYİH + \beta_2 DYY + \beta_3 TASARRUF + \beta_4 İŞSİZLİK + \beta_5 OGT + \epsilon_t$$

Yukarıda yer alan ekonometrik modelde bağımlı değişken olan DV/TV dolaylı vergilerin toplam vergi gelirleri içindeki payını (vergi gelirlerinin kompozisyonunu) yansıtırken, açıklayıcı değişkenler olan GSYİH kişi başı gayri safi yurtiçi hasıla artış oranını, DYY yıllık doğrudan yabancı yatırımları, TASARRUF toplam tasarrufları, İŞSİZLİK yıllık işsizlik oranını ve OGT ise 1990-2002 arası 0; 2003 ve sonrası için 1 değerini alan ve yalnızca Türkiye için orta gelir tuzağından çıkışı temsil eden kukla değişkendir.

Tablo: 8
Betimleyici İstatistikler- Statik Panel Veri Analizi

İSTATİSTİK	DV/TV	GSYİH	DYY	TASARRUF	İŞSİZLİK
Ortalama	0,606631	1,313643	1,969734	18,54090	11,03329
Medyan	0,657417	1,605242	1,956964	18,17149	9,350000
Maksimum	0,856304	9,844296	8,460582	27,80366	25,54000
Minimum	0,374946	-11,84595	0,002285	11,39392	2,600000
Std. Sapma	0,129672	4,043303	1,290089	3,926837	6,172915
Çarpıklık	-0,278479	-0,606419	1,072864	0,258990	0,719237
Basıklık	1,738236	3,569472	6,055345	1,926316	2,366906
Jarque-Bera	11,88908	11,22047	87,12048	8,881876	15,43761
Olasılık	0,002620	0,003660	0,000000	0,011785	0,000444
Gözlem	150	150	150	150	150

Öncelikle, kurulan ampirik modelde birim ve/veya zaman etkilerinin mevcudiyetinin saptanması amacıyla muhtelif tanı testleri uygulanmıştır. Bahsi geçen test bulguları Tablo 9'da yansıtılmaktadır:

Tablo: 9
Birim ve/veya Zaman Etkilerinin Mevcudiyetine İlişkin Tanı Testleri Bulguları

Birim ve/veya Zaman Etkilerinin Tespiti			
Test	İstatistik D.	Olasılık D.	Karar
LR Testi	268,29	0,00	+
Zaman Etkisi Tespiti			
	İstatistik D.	Olasılık D.	Karar
LR Testi	0,00	1,00	-
Birim Etkisinin Tespiti			
	İstatistik D.	Olasılık D.	Karar
LR Testi	268,29	0,00	+
En Çok Olabilirlik Testi	268,29	0,00	+
Skor Testi	6,30	0,00	+
F Testi	243,17	0,00	+
Hausman Testi			
	İstatistik D.	Olasılık D.	Karar
Hausman Testi	125,02	0,00	---

Not: Tabloda "-" ifadesi varlığı sananan etkisinin mevcut olmadığını, "+" ise mevcudiyetini temsil etmektedir.

Tablo 9'da ilk kısımda yer alan birim ve zaman etkisine ilişkin LR testi bulguları değerlendirildiğinde, birim ve zaman etkilerinin bulunmadığını ifade eden temel hipotez (H_0) reddedilirken birim ve zaman etkilerinden en az birinin mevcut olduğunu ifade eden alternatif hipotez (H_1) kabul edilmektedir. Tablonun ikinci kısmında zaman etkisinin varlığı benzer şekilde LR testi ile sınanmıştır. Test sonuçları incelendiğinde zaman etkisinin olmadığını ifade eden temel hipotezin (H_0) reddedilemediği görülmektedir. Dolayısıyla yapılan çalışmada zaman etkisinin mevcut olmadığı anlaşılmaktadır. Tablonun üçüncü kısmında ise birim etkisinin mevcudiyeti sırasıyla; LR, En Çok Olabilirlik, Skor ve F Testleri ile sınanmıştır. Bulgular incelendiğinde birim etkisinin mevcut olmadığını ifade eden temel

hipotezin (H_0) tüm testler tarafından reddedildiği görülmektedir. Diğer bir ifadeyle, birim etkisine ilişkin testlerin tümü modelde birim etkisinin varlığını teyit etmektedir. Son olarak, Hausman testi sonucuna göre ise hata terimleri ile bağımsız değişkenler arasında ilişki olmadığını ifade eden sıfır hipotezi (H_0) reddedilmektedir. Hata terimleri ile bağımsız değişkenler arasında ilişki olduğunda sabit etkiler tahmincisi tutarlı, tesadüfi etkiler tahmincisi ise tutarsız sonuçlar vermektedir. Bu yüzden model tahmininde tek yönlü birim etkiye sahip sabit etkiler tahmincisi kullanılacaktır.

Diğer yandan, değişen varyans ve otokorelasyona ilişkin varsayımlar panel veri analizinde hata terimine ait temel varsayımları oluşturur. Bu temel varsayımlara ilişkin test bulguları tabloda yansıtılmıştır.

Tablo: 10
Otokorelasyon ve Değişen Varyans Testlerine İlişkin Bulgular

Bhargava, Franzini & Narendranathan-Durbin Watson ve Baltagi & Wu-Yerel En İyi Değişmez Otokorelasyon Testleri		
	<i>Istatistik D.</i>	<i>Karar</i>
<i>Durbin – Watson</i>	0,498	+
<i>Baltagi - Wu LBI</i>	0,626	+
Wald Değişen Varyans Testi		
	<i>Istatistik D.</i>	<i>Karar</i>
<i>Wald Testi</i>	264,94 (0,000)	+

Not: Tabloda "-" ifadesi varlığı sınanan etkinin mevcut olmadığını, "+" ise mevcudiyetini temsil etmektedir. Parantez içindeki değer ilgili istatistiğe ilişkin "olasılık" değeridir.

Tablo: 11
Panel Veri Modeli Nihai Tahmin Bulguları

Bağımlı Değişken	DV/TV			
Örneklem	1990-2020			
Toplam Gözlem	150			
Bağımsız Değişkenler	Katsayı D.	Std. Hata	z-İstatistiği	Olasılık Değeri
GSYİH	0,005	0,018	3,17	0,002***
DYY	0,006	0,005	1,15	0,249
TASARRUF	-0,023	0,002	-10,86	0,000***
İŞSİZLİK	0,004	0,002	2,00	0,045**
OGT	-0,083	0,034	-2,44	0,015**
C	0,982	0,055	17,65	0,000
R ²	0,56			
Wald İstatistiği	189,38			
Wald İstatistiği Olasılık D.	0,000			

Not: "****", "***" ve "**" sırasıyla %1, %5 ve %10 istatistiksel anlamlılık düzeylerini temsil etmektedir.

Tablo 10'da yer alan otokorelasyon test sonuçları incelendiğinde DW ve Baltagi-Wu LBI test istatistikleri 2'den küçük olduğu için çalışmanın modelinde otokorelasyonun mevcut olduğu anlaşılmaktadır. Aynı tabloda Wald testi sonuçları da görülmektedir ve bu teste göre "Değişen varyans yoktur" şeklinde kurulan temel hipotez (H_0) reddedilmektedir, dolayısıyla, modelin hata terimlerinin değişen varyanslı olduğu tespit edilmiştir. Test sonuçları dikkate alındığında otokorelasyon ve değişen varyansın mevcut olması durumunda nihai model tahmini gerçekleştirilirken otokorelasyon ve değişen varyansa karşı dirençli tahminci kullanılması gerekir. Bu çerçevede, tanı testlerinin bulguları doğrultusunda, birim etkisine sahip nihai dirençli sabit etkiler modeli sonuçları Tablo 11'de yansıtılmıştır.

Birim etkiye sahip tek yönlü sabit etkiler modeli analizi sonuçları dikkate alındığında, bağımlı değişkendeki değişimlerin yaklaşık %56'sının (R^2 değeri) bağımsız değişkenler tarafından açıklandığı görülmektedir. Ayrıca, Wald istatistiğinin olasılık değeri dikkate alındığında kurulan modeldeki bağımsız değişkenlerin tümünün bağımlı değişkeni açıklamada istatistiki olarak anlamlı olduğu anlaşılmaktadır.

Değişkenler arası ilişkiler incelendiğinde ise bağımlı değişken olan ve vergi gelirlerinin kompozisyonunu temsil eden dolaylı vergilerin toplam vergiler içindeki payı (DV/TV) ile yıllık kişi başı GSYİH büyüme oranı (GSYİH), toplam tasarruflar (TASARRUF), yıllık işsizlik oranı (İŞSİZLİK) ve orta gelir tuzağından çıkılmasını temsil eden kukla değişken olan OGT kuklası arasında istatistiki olarak anlamlı ilişki tespit edilmiştir. Doğrudan yabancı yatırımlarla (DYY) vergi gelirlerinin kompozisyonu arasında ise istatistiki olarak anlamlı bir ilişki tespit edilememiştir.

Bu çerçevede, gelirdeki artışın (GSYİH) incelenen ülkelerde dolaylı vergilerin toplam vergi gelirleri içindeki payı (DV/TV) üzerinde istatistiki olarak anlamlı pozitif bir etkisi olduğu bulunmuştur. Ancak, gelirdeki artışla birlikte aynı zamanda orta gelir tuzağından kurtulma durumu başarılıymışsa, bu durumda, dolaylı vergilerin toplam vergi gelirlerindeki payının azalış sergilediği görülmektedir. Nitekim OGT değişkeni yalnızca Türkiye için orta gelir tuzağından çıkışı temsil eden kukla değişkendir. Önceki kısımlarda gerçekleştirilen yapısal kırılmalı birim kök testleri neticesinde ise incelenen ülkelere Türkiye dışındakilerin orta gelir tuzağından kurtulmadığı tespit edilmişti. OGT kukla değişkeninin katsayı değeri göz önüne alındığında bu değişkenin dolaylı vergilerin toplam vergi gelirleri içindeki payı üzerinde negatif etkide bulunduğu görülmektedir.

4. Sonuç

Vergi hasılatının ekonomik büyüme ile ilişkisi, orta gelir tuzağından çıkılması durumunun vergi hasılatının kompozisyonunu ne şekilde etkilediğinin belirlenmesi açısından önem arz etmektedir. Bu nedenle, çalışmamızda, ekonomik büyümenin ve büyümeyle birlikte orta gelir tuzağından kurtulmanın vergi hasılatının bileşimi içindeki olası etkilerini araştırma ve tartışmanın yararlı olacağını düşündük. Nitekim bu çalışmada temel olarak gelir düzeylerindeki artış ve bu artışla birlikte orta gelir tuzağından kurtulma durumunun vergilerin kompozisyonu ile muhtemel ilişkisi incelenmiştir.

Çalışmada örnek ülke grubu olarak -verilerin mevcudiyeti dahilinde- Yükselen G20 ülkeleri incelenmiştir. Öncelikle, incelenen ülkelere hangilerinin orta gelir tuzağına bulunduğu ve hangilerinin tuzaktan kurtulduğunun tespiti ampirik yaklaşımlarla analiz edilmiştir. İkinci aşamada ise vergi gelirlerinin kompozisyonu ile gelirdeki artış arasındaki olası nedensellik ilişkisi sınanmış olup son kısımda ise hem gelirdeki artışın hem de gelir artışıyla birlikte orta gelir tuzağından kurtulmanın vergilerin kompozisyonu üzerindeki muhtemel etkileri ve bu etkilerin nicelik ve nitelik açısından özellikleri ampirik yöntemlerle incelenmiştir. Çalışmada vergilerin kompozisyonu "*dolaylı vergilerin toplam vergiler içindeki payı*" ile temsil edilmiştir.

Çalışmamız neticesinde incelenen ülkelerden yalnızca Türkiye'nin orta gelir tuzağından kurtulmuş olduğu; Arjantin, Meksika, Brezilya ve Güney Afrika Cumhuriyeti'nin tuzaaktan kurtulmadığı tespit edilmiştir. Ayrıca, incelenen ülkeler temelinde dolaylı vergilerin toplam vergi gelirleri içindeki payı ile gelir düzeylerinin artması arasında istatistiki olarak anlamlı ve karşılıklı bir nedensellik ilişkisi tespit edilmiştir. Bu bağlamda, vergi politikalarının büyümeye dönük politikaları destekleyecek şekilde düzenlenmesi ve uygulanması büyümenin sürdürülebilirliğine katkı sağlayabilir. Bir başka deyişle, orta gelir tuzağından çıkılabilmesi için vergi politikalarının arzu edilen doğrultuda ve etkin bir biçimde dizaynı ve icrası uygun olabilecektir.

Diğer yandan, çalışmanın en çarpıcı bulgusu ise, gelirdeki artışın orta gelir tuzağında bulunan ülkelerde dolaylı vergilerin toplam vergi gelirleri içindeki payını artırmasına karşın, gelirdeki artış ile birlikte orta gelir tuzağından çıkışın sağlanması durumunda ise bu payın azalışı sergilemesidir. Bu durum ise orta gelir tuzağında bulunan ülkelere marjinal tüketim eğiliminin orta gelir tuzağından kurtulan ülkelere kıyasla daha yüksek olmasıyla açıklanabilir. Ayrıca, dolaysız vergilerin gelir esnekliğinin yüksek olması sonucunda dolaysız vergi gelirlerinin toplam vergi gelirleri içindeki payında artışa neden olmasıyla da ilgilidir. Nitekim, orta gelir tuzağından kurtulan ülkelere dolaysız vergi gelirlerindeki artışın dolaylı vergi gelirlerindeki artıştan daha yüksek olduğu anlaşılmaktadır.

Gelecek çalışmalarda, farklı vergi politikalarının orta gelir tuzağındaki ülkelere gelir düzeyi üzerindeki muhtemel etkileri çeşitli ampirik yöntemlerle araştırılabilir.

Kaynaklar

- Abdiyeva, R. & D. Baygonuşova (2016), “Geçiş Ekonomilerinde Vergi Gelirleri ve Ekonomik Büyüme İlişkisi: Kırgızistan Örneği”, *Akademik Bakış Dergisi*, 53, 59-71.
- Açıkgöz, Ş. (2008), “Türkiye’de Vergi Gelirleri, Vergi Yapısı ve İktisadi Büyüme İlişkisi:1968-2006”, *Ekonomik Yaklaşım*, 19(68), 91-113.
- Aoki, M. (2012), “The five phases of economic development and institutional evolution in China, Japan, and Korea”, in: *Institutions and Comparative Economic Development* (13-47), London: Palgrave Macmillan UK.
- Ay, H. & L. Haydanlı (2018). “Kuruluşundan günümüze Türkiye’de vergi yükü ve gelir dağılımının analizi”, *Sosyoekonomi*, 26(38), 53-70.
- Chen, C. & L. Dai (2014), *The middle-income trap, branching deregulation, and political influence*, <https://www.econ.cuhk.edu.hk/econ/images/content/news_event/seminars/2014-2015-2nd-semester/Bank_Deregulation_and_Political_Contribution.pdf>, 25.06.2023.
- Dünya Bankası (2023a), <<https://blogs.worldbank.org/opendata/new-world-bank-country-classifications-income-level-2022-2023>>, 18.03.2023.
- Dünya Bankası (2023b), <<https://data.worldbank.org/indicator/NY.GDP.PCAP.KD>>, 08.05.2023.
- Durkaya, M. & S. Ceylan (2006), “Vergi Gelirleri ve Ekonomik Büyüme”, *Maliye Dergisi*, 150, 79-89.

- Eichengreen, B. et al. (2013), "Growth Slowdowns Redux: New Evidence on the Middle-Income Trap", *NBER Working Paper*, 18673, National Bureau of Economic Research, Cambridge.
- Felipe, J. et al. (2012), "Tracking the Middle-Income Trap: What Is It, Who Is in It, and Why?", *Levy Economics Institute of Bard College Working Paper*, 715, Levy Economics Institute of Bard College, New York.
- Gill, I.S. et al. (2007), *An East Asian renaissance: Ideas for economic growth*, World Bank Publications.
- Glawe, L. & H. Wagner (2016), "The middle-income trap: Definitions, theories and countries concerned - A literature survey", *Comparative Economic Studies*, 58, 507-538.
- Helhel, Y. & Y. Demir (2012), "The Relationship between Tax Revenue and Economic Growth in Turkey: The Period of 1975-2011", *International Symposium on Sustainable Development*, 1(1), 32-40.
- Kharas, H. & H. Kohli (2011), "What is the middle-income trap, why do countries fall into it, and how can it be avoided?", *Global Journal of Emerging Market Economies*, 3(3), 281-289.
- Koçak, E. & Ü. Bulut (2014), "Orta Gelir Tuzağı: Teorik Çerçeve, Ampirik Yaklaşımlar ve Türkiye Üzerine Ekonometrik bir Uygulama", *Maliye Dergisi*, 167, 1-21.
- Ohno, K. (2009), "Avoiding the middle-income trap: renovating industrial policy formulation in Vietnam", *ASEAN Economic Bulletin*, 26(1), 25-43.
- Oluklulu, S. & T. Çakır (2018) "Kentsel Atık Su Arıtma Hizmetinin Kamusalılık Özelliği ve Türkiye'de Hizmetin Finansmanında Kullanılan Mali Araçlar", *Vergi Dünyası*, 38(446), 24-36.
- Ray, S. et al. (2012), "A Causality Analysis on Tax-Growth Nexus in India:1950-51 to 2011-12", *Journal of Expert Systems*, 1(4), 104-114.
- Robertson, P.E. & L. Ye (2013), "On the Existence of a Middle-Income trap", *University of Western Australia Economics Discussion Paper*, 13-12, Australia.
- Sağdıç, E.N. & D. Aydın (2021), "Dolaylı ve Dolaysız Vergiler ile Ekonomik Büyüme Arasındaki Nedensellik İlişkisi: Türkiye Örneği (2006-2018)", *International Journal of Public Finance*, 6(1), 21-46.
- Sağdıç, E.N. (2019), "Vergi gelirlerini belirleyen faktörlerin bölgesel analizi: Türkiye örneği", *Dumlupınar Üniversitesi Sosyal Bilimler Dergisi*, (60), 155-178.
- Sen Gupta, A. (2007), "Determinants of tax revenue efforts in developing countries", *IMF Working Paper*, 07-184, 1-39.
- Terzi, H. & S. Yurtkuran (2016), "Türkiye'de dolaylı/dolaysız vergi gelirleri ve GSYH ilişkisi", *Maliye Dergisi*, 171, 19-33.
- Tho, T.W. (2013), "The Middle-Income Trap: Issues for Members of the Association of Southeast Asian Nations", *VNU Journal of Economics and Business*, 29(2), 107- 128.
- Turhan, S. (1987), *Vergi Teorisi ve Politikası*, Der Yayınları: İstanbul.
- Woo, W.T. (2012), "China Meets the Middle-Income Trap: The Large Potholes in the Road to Catching-up", *Journal of Chinese Economic and Business Studies*, 10(4), 313-336.
- Yereli, A.B. vd. (2019), "Middle-Income Trap: A Literature Review", *Selçuk Üniversitesi Sosyal Bilimler Meslek Yüksekokulu Dergisi*, 22(2), 950-964.

Küreselleşme, Hidroelektrik Enerji, Ekonomik Büyüme, CO₂ Emisyonları ve Ekolojik Ayak İzi İlişkisinin ABD İçin Analizi: Kesirli Fourier ADL Eşbütünleşme Yöntemi

Ahmet KAMACI (<https://orcid.org/0000-0002-7858-6131>), Sakarya University of Applied Sciences, Türkiye; ahmetkamaci@subu.edu.tr

The Analysis of Globalization, Hydroelectric Energy, Economic Growth, CO₂ Emissions and Ecological Footprint Relationships for the USA: Fractional Fourier ADL Cointegration Method

Abstract

Environmental problems such as global climate change and global warming pose a great threat to future generations. The USA, which has a very high ecological footprint and carbon emissions, is at the forefront of the countries that pose this threat. In this direction, this study aims to investigate the effects of globalisation, economic growth and hydroelectric energy on carbon emission and ecological footprint in the USA with Fourier ADL cointegration and Fourier Toda-Yamamoto causality tests. According to the findings, there is a negative relationship between electricity generation from hydroelectric sources and CO₂ emissions and a positive relationship between per capita GDP and ecological footprint. In addition, unidirectional causality from KOF to CO₂, hydroelectric-powered electricity generation, and per capita GDP to ecological footprint are also determined.

Keywords : Ecological Footprint, CO₂ Emissions, Globalization, Hydroelectric Energy, Fourier ADL Cointegration Test.

JEL Classification Codes : F64, Q57, C32.

Öz

Küresel iklim değişikliği ve küresel ısınma gibi çevresel sorunlar gelecek kuşaklar için büyük bir tehdit oluşturmaktadır. Bu tehdidi oluşturan ülkelerin başında da ekolojik ayak izi ve karbon emisyonu oldukça yüksek olan ABD gelmektedir. Bu doğrultuda, bu çalışmanın amacı, ABD’de küreselleşme, ekonomik büyüme ve hidroelektrik enerjinin karbon emisyonu ve ekolojik ayak izi üzerindeki etkisini Fourier ADL eşbütünleşme ve Fourier Toda-Yamamoto nedensellik testleri ile araştırmaktır. Elde edilen bulgulara göre, hidroelektrik kaynaklardan elektrik üretimi ile CO₂ emisyonları arasında negatif ilişki ve kişi başı GSYİH ile ekolojik ayak izi arasında pozitif ilişki bulunmaktadır. Ayrıca KOF’dan CO₂’ye doğru ve hidroelektrik kaynaklardan elektrik üretiminden ve kişi başı GSYİH’den ekolojik ayak izine doğru tek yönlü nedensellik tespit edilmiştir.

Anahtar Sözcükler : Ekolojik Ayak İzi, CO₂ Emisyonu, Küreselleşme, Hidroelektrik Enerji, Fourier ADL Eşbütünleşme Testi.

1. Giriş

Küreselleşmeyle beraber ülkelerde üretim kapasitesi arttıkça ekonomik büyüme-çevre ilişkisi daha çok ilgi görmüştür. Bu kapsamda genelde çevreyi kirleten kirleticiler ekolojik gösterge olarak kullanılmaktadır. Bu çalışmada da çevre kalitesinin gösterilmesi için CO₂ emisyonu ve ekolojik ayak izi gibi göstergeler belirlenmiştir.

Dünya Kalkınma Göstergesine göre 1960'lı yıllarda %25 olan uluslararası ticaretin dünya ekonomisindeki payı 2015 yılında %58'e yükselmiştir. %73'ü CO₂ emisyonu olan sera gazı emisyonları da ekonomik büyümeyle beraber hızla artmıştır. Bu doğrultuda sera gazı emisyonlarını azaltmak ve küresel ısınmayı kontrol altına almak amacıyla 1997 yılında Kyoto Protokolü imzalanmış ve küresel emisyonların %95'inden fazlasını oluşturan ülkelerin anlaşması ile kabul edilmiştir (Zhang et al., 2017).

Dünyada son yıllarda ortaya çıkan yüksek sıcaklıklar, küresel ısınmanın ne denli büyük çapta olduğunu göstermektedir. Sera gazları içinde en çok karbon emisyonu bulunmaktadır. Öyle ki, 2019'da sera gazları içinde yaklaşık 34.169 milyon ton CO₂ emisyonu bulunmaktadır. 2017'de CO₂ emisyon miktarı milyonda 405,5 parçaya, metan gazı miktarı milyarda 1859 parçaya ve nitrojen dioksit miktarı da milyarda 329,9 parçaya yükselmiştir ve bu da sanayi öncesine göre sırasıyla %146, %257 ve %122 artış göstermektedir. CO₂ emisyonlarının yanında, başka kirleticiler de küresel iklim değişikliği ve küresel ısınmayı etkilemektedir. Bu çerçevede Wackernagel ve Rees'in önerdiği ekolojik ayak izi (ecological footprint) su, hava ve toprak kirliliğinin eş zamanlı analizine olanak sağlayan kümülatif bir çevresel göstergedir. Ekolojik ayak izi, meskûn arazi, tarım arazisi, karbon, mera, balıkçılık alanları ve orman ayak izi gibi 6 alt bileşen içermektedir. 1970'lerden bu yana ekolojik ayak izi, dünyanın yenilenme kapasitesini aşmıştır ve bu çevresel bozulma, insan refahı ve gezegenin sağlığı üzerinde olumsuz etkilere yol açmaktadır (Pata, 2021: 198). Fosil yakıtlar ve mineraller gibi yenilenemeyen kaynakların tükenmesine odaklanan diğer yaklaşımlardan farklı olarak Ekolojik Ayak İzi analizi, sürdürülebilirliğe giden yolun sürdürülebilir uygulamalarla döşenmesi gerektiğini öne sürmektedir (Bazan, 1997).

Bu çalışma, küreselleşme, ekonomik büyüme ve hidroelektrik enerjinin çevresel bozulma üzerindeki rolüne odaklanmaktadır. Ayrıca küreselleşme için ekonomik, politik ve sosyal küreselleşmeyi içeren küreselleşme endeksi kullanılmıştır. Bu bağlamda, çalışma aşağıdaki sorulara cevap aramaktadır: (1) Hidroelektrik kaynaklardan elde edilen elektrik üretimi çevre kalitesine nasıl etkide bulunur, ekolojik ayak izini ve karbon emisyonunu ne derece etkiler? (2) Küreselleşme çevresel bozulmanın temel itici gücü müdür? (3) Kişi başı GSYİH'daki değişimler çevre kalitesini etkiler mi? Çalışma, bu sorulara yanıt arayarak ekolojik ayak izi ve karbon emisyonu çok olan ABD'de çevresel bozulmanın iyileştirilmesine yönelik çözüm önerileri sunmaktadır.

Bu çalışmanın amacı, ABD'de küreselleşme, hidroelektrik enerji, ekonomik büyüme, CO₂ emisyonu ve ekolojik ayak izi ilişkisini kesirli Fourier ADL eşbütünlüşme yöntemi ile

test etmektir. Bu amaçla öncelikle teorik çerçeve belirlenmiştir. Sonrasında ABD'ye ait temel göstergelere yer verilmiştir. Çalışmanın özgün değeri, çalışmanın iki farklı modelle ele alınmasıdır. Bu amaçla konu Kesirli Fourier ADL eşbütünlüşme testi ile incelenmiştir. Söz konusu yöntem oldukça güncel olmakla birlikte, incelenen konuya dair literatürün genişletilmesi noktasında önemli katkı sağlayacağı düşünülmektedir. Çünkü söz konusu yöntemin ele alındığı çalışma sayısı oldukça sınırlıdır. Ayrıca çalışmada, karşılaştırma yapabilmek adına Fourier ADL eşbütünlüşme testine de yer verilmiştir. Aynı zamanda yenilenebilir enerji değişkeni yerine hidroelektrik enerji verisi kullanılması ve ABD'de hidroelektrik enerjinin CO₂ emisyonları, ekolojik ayak izi, ekonomik büyüme ve küreselleşmeye etkisini ele alan çalışmalar oldukça sınırlı olması açısından, bu çalışmanın literatüre katkı sağlayacağı düşünülmektedir.

Çalışmanın izlenen ikinci bölümünde teorik arka plan belirlenmiş ve ABD'ye ait temel göstergelere yer verilmiştir. Üçüncü bölümde ise ilgili literatür yer almaktadır. Dördüncü bölümde çalışmada kullanılan 2 farklı model ve veri seti tanımlanmış ve ampirik analiz sonuçları verilmiştir. Beşinci ve son bölümde ise sonuç ve tartışmalara yer verilmiştir.

2. Teorik Çerçeve

Küreselleşme bir ekonomide üretim, yatırım, ihracat, ticaret ve daha birçok ekonomik göstergelyi etkilemektedir. Bu göstergeler enerji tüketimini artırarak çevresel kaliteyi de etkilemektedir (Latif et al., 2018). Küreselleşme, hizmet sektörünün büyümesine yönelik olarak çevreye dolaylı katkılar sağlasa da (Jena & Grote, 2008), kompozisyon etkisi dolayısıyla sanayi sektöründen hizmet sektörüne geçiş sürecinde çevresel kaliteyi azaltabilmektedir (Amri, 2018).

Küreselleşme, üretimde ve tüketimde artışa neden olduğu için hem karbon emisyonunu hem de ekolojik ayak izini artırmakta ve böylece çevresel bozulmayı artırmaktadır. Bu yönüyle küreselleşme, küresel iklim değişikliği ve küresel ısınma gibi temel çevre sorunlarına da neden olmaktadır. Küreselleşme sürecinde üretim teknikleri değişmezse, çevre koşulları bozulacaktır. Ancak küreselleşme sürecinde çevre dostu yeni teknolojiler getirilirse bu durumda çevre kalitesi artacaktır (Pata, 2021: 198).

İnsanların tükettiği kaynakların yeniden üretilmesi ve oluşan atıkların eritilmesi için gerekli olan verimli alanlar ekolojik ayak izi olarak adlandırılmaktadır. Çevresel sürdürülebilirliğin temel göstergesi olan ekolojik ayak izi, bilinçli tüketim alışkanlıklarıyla ve dış kaynaklar yerine öz kaynakların kullanılmasıyla azaltılabilmektedir (Keleş, 2010: 5-8). Ekolojik ayak izinin büyük çoğunluğunu karbon emisyonları oluşturmaktadır. Karbon ayak izinin son 50 yılda 11 kat artması küresel iklim değişikliğine neden olmaktadır (<wwf.org>). Küresel iklim değişikliğinin önemli bir göstergesi olan karbon emisyonu aynı zamanda çevre kirliliğinin de önemli bir göstergesidir.

Ekolojik Ayak İzi analizi, belirli bir popülasyonun sürdürülebilir bir şekilde var olması için gereken toplam arazi alanını ölçmektedir. Bir şehrin ekolojik ayak izinin hem

nüfus hem de kişi başına düşen malzeme tüketimi ile orantılı olacağı açık olmalıdır. Ekolojik ayak izi, dünyanın neresinde olursa olsun, tanımlanmış nüfusun ihtiyaç duyduğu tüm araziyi içermektedir. Bu nedenle ekolojik ayak izi aynı zamanda ilgili popülasyonun toplam "uygun taşıma kapasitesini" de temsil etmektedir. Wackernagel ve Rees, kişi başına 11 dönüm ile ABD'nin kişi başına en yüksek ayak izine sahip olduğunu belirtmiştir ve bu sayının kişi başına 6 dönüme yakın olması gerektiğini öne sürmektedir. Ayrıca, ABD %80 oranında bir "ekolojik açık" ile karşı karşıyadır, bu da torunlarımızın mirasından ödünç aldığımız ve dünyanın başka yerlerinden arazileri kamulaştırdığımız anlamına gelmektedir. Tipik bir Kuzey Amerikalının (4-5 hektar) mevcut ekolojik ayak izi, dünya ortalamasının 3 katıdır. Aslında, dünyadaki herkes ortalama bir Kanadalı veya Amerikalı gibi yaşasaydı, sürdürülebilir bir şekilde yaşamak için en az üç gezegene ihtiyacımız olurdu. Buna karşılık, her Avrupalı yaklaşık 5 akreye ihtiyaç duymaktadır; ancak Avrupalılar daha küçük arazi alanlarına sahip oldukları için daha yüksek ekolojik açıklarla karşı karşıyadır (Wackernagel & Rees, 1996; Bazan, 1997).

ABD, dünyada karbon emisyonu en çok olan 10. ülkedir. Aynı zamanda Kuzey Amerika kıtası dünyada karbon emisyonu en çok olan kıtadır (<atabank.worldbank.org>). Diğer bir çevre kalitesi göstergesi olan kişi başına düşen ekolojik ayak izi sıralamasında ise ABD, Birleşik Arap Emirlikleri, Katar, Danimarka ve Belçika'dan sonra ekolojik ayak izi en çok olan 5.ülkedir. Öyle ki; bir Amerikalının ayak izi, 43 Afrikalının ayak izine eşittir. Aynı zamanda gelişmiş ülkelerin ekolojik ayak izi, gelişmekte olan ülkelerin 5 katıdır ve 31 OECD ülkesi dünyadaki toplam ayak izinin %40'ını oluşturmaktadır (<wwf.org>).

Grafik 1'de 2019 yılı için ülkelere ait CO₂ emisyonlarına yer verilmiştir.

Grafik: 1
CO₂ Emisyonu (2019)

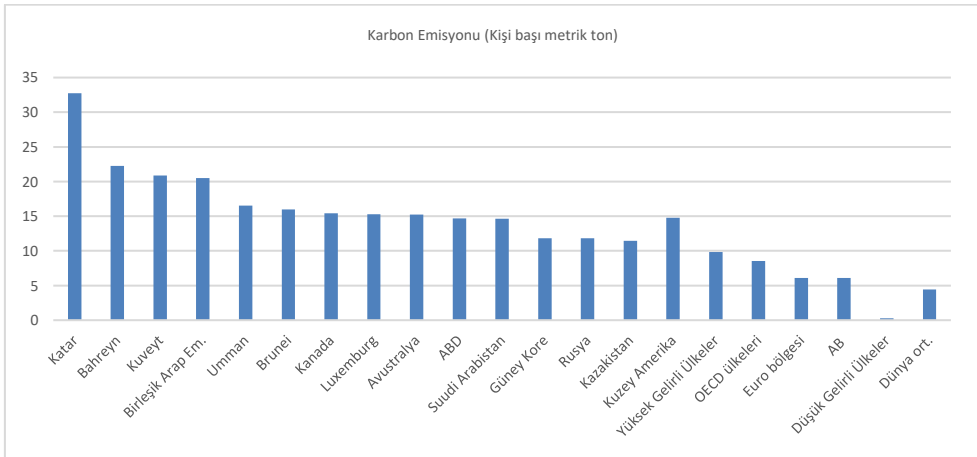

Kaynak: <atabank.worldbank.org>.

Grafik 1’e göre 2019 yılı için en yüksek CO₂ emisyonuna sahip ülke 32,76 metrik ton ile Katar’dır. ABD 14,76 metrik ton ile dünya ortalamasının (4,43) oldukça üstündedir. Aynı zamanda Kuzey Amerika kıtası diğer kıtalara göre en çok CO₂ emisyonuna sahip kıtadır. ABD’deki CO₂ emisyonları yıllar itibariyle azalsa da halen çok fazladır. Grafik 2’de ABD’de 1997-2019 arası CO₂ emisyonları yer almaktadır.

Grafik: 2
ABD’deki CO₂ Emisyonları (1997-2019)

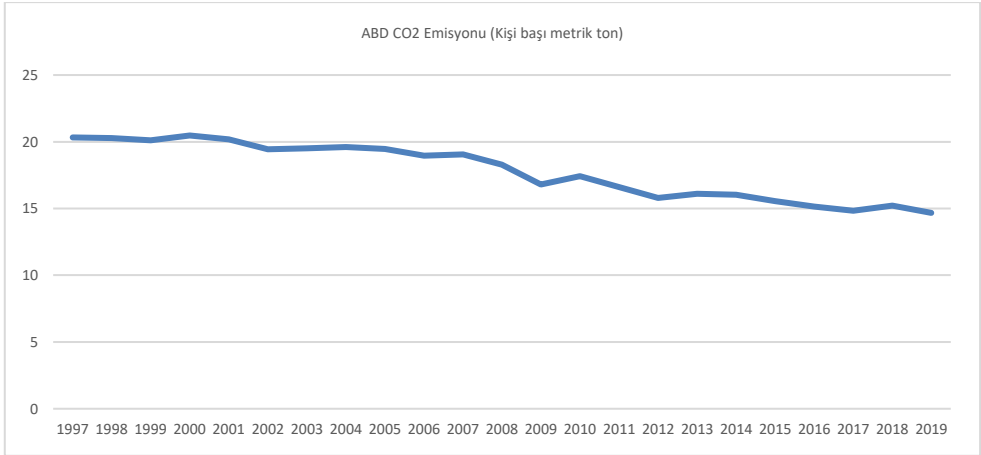

Kaynak: <databank.worldbank.org>.

Grafik 2’de görüldüğü üzere ABD’de CO₂ emisyonları sürekli azalmaktadır. Öyle ki; 2000’de 20,46 iken yıllar itibariyle azalış göstermiş ve 2019’da 14,67’ye düşmüştür.

2015 yılında yayınlanan “State of State: A New Perspective on Our Nation of Wealth” adlı raporda eyaletler bazında ABD’ye ait göstergelere yer verilmiştir. Bu göstergeler Tablo 1’de özetlenmiştir.

Tablo: 1
ABD ve ABD’deki Bazı Eyaletlerin Ekolojik Zenginliği

Durum	Nüfus (milyon)	Kişi Başı GSYİH	Doğuşta Beklenen Yaşam Süresi	İnsani Gelişim İndeksi	Karbon Ayak İzi (kişi başı küresel dönüm)	Karbon Olmayan Ayak İzi (kişi başı küresel dönüm)	Toplam Ekolojik Ayak İzi (kişi başı küresel dönüm)	Biyolojik Kapasite (kişi başı küresel dönüm)
ABD	310,38	49469	78,9	5,03	11,5	5,7	17,2	9,3
Kaliforniya	37,25	54462	80,8	5,40	10,5	6,0	16,5	1,9
Tekساس	25,14	54433	78,5	4,65	12,8	5,8	18,6	6,7
New York	19,37	64818	80,5	5,66	9,3	5,0	14,2	3,5
Florida	18,8	38690	79,4	4,82	10,9	5,2	16,1	4,6
Illinois	12,83	52827	79,0	5,31	11,3	5,8	17,2	5,9
Kuzey Carolina	9,53	44281	77,8	4,57	12,2	5,4	17,6	7,6
Michigan	8,88	42110	78,2	4,76	11,2	5,5	16,6	11,8
New Jersey	8,79	56405	80,3	6,12	11,9	6,8	18,7	1,3
Virjinya	8,001	51338	79,0	5,47	17,0	7,7	24,6	7,4

Kaynak: <https://www.footprintnetwork.org>.

Tablo 1'e göre, ABD'deki toplam ekolojik ayak izi 17,2'dir ve bunun da 11,5'i karbon ayak izinden oluşmaktadır. Eyaletler bazında bakıldığında, toplam ekolojik ayak izi ve karbon ayak izi en çok olan eyalet Virjinya iken; en az olan eyalet ise New York'tur.

3. Literatür

Hızlı nüfus artışı, küreselleşme, enerji tüketimindeki artış, üretim artışı ve ekonomik göstergelerdeki artışlar çevre üzerinde baskı oluşturmaktadır. Bu nedenle son yıllarda CO₂ emisyonu üzerine çalışmalar son yıllarda oldukça fazladır. Bu çalışmalar çevresel Kuznets eğrisi de (EKC) denilen Grossman ve Krueger (1991) tarafından önerilen Ters U hipotezine dayalıdır. EKC hipotezi, ekonomik büyümenin ilk evrelerinde çevre kirliliğinin artacağını, daha sonra kişi başı gelirdeki artışın belli noktaya gelmesiyle çevresel iyileşmenin olacağını ifade etmektedir.

EKC hipotezinin teorik temeli, ölçek, kompozisyon ve teknik etkidir (Grossman & Krueger, 1995: 355). Ölçek etkisi, üretim artışının çevresel bozulmayı artıracığını; bileşim etkisi, ticaretin çevre kirliliğine etkisini; teknik etki ise ticari açıklıkla beraber teknolojik yeniliğin daha temiz bir çevre sağladığını ifade etmektedir (Barrett, 2000; Chebbi et al., 2011; Dauda et al., 2021).

EKC hipotezinde ticari açıklık ile CO₂ emisyonu arasında negatif bir ilişki mevcuttur ve EKC hipotezini destekleyen birçok çalışma mevcuttur. Örneğin, Shafik ve Bandyopadhyay (1992), Cole vd. (1997), Dinda vd. (2000), Stern (2004), Managi vd. (2009), Shahbaz vd. (2013), Akın (2014), Sbia vd. (2014), Kasman ve Duman (2015), Zhang vd. (2017), Salman vd. (2019), Shahbaz vd. (2019), Lv ve Xu (2019), Essandoh vd. (2020). Buna karşın bazı çalışmalarda EKC hipotezi desteklenmemektedir. Örneğin, Farhani vd. (2013), Ertuğrul vd. (2016), Shahbaz vd. (2017a), Dauda vd. (2021).

EKC hipotezini doğrulamaya çalışan bu çalışmaların yanı sıra son zamanlardaki çalışmalar CO₂ emisyonu ve bunun belirleyicilerini incelemiştirlerdir. Bu kapsamda enerji tüketimi (yenilenemez ya da yenilenebilir enerji), küreselleşme ve ekonomik büyüme gibi değişkenleri de çalışmalara dâhil etmişlerdir. Ekonomik büyüme, küreselleşme ve enerji tüketimi ile CO₂ emisyonunu inceleyen birçok çalışma mevcuttur. Örneğin, Shahbaz vd. (2017b), Kalaycı and Hayaloğlu (2018), Sharmin ve Tareque (2018), Khan vd. (2020), Sahu ve Kumar (2020), Anser vd. (2021), Baydoun ve Aga (2021), Chienwattanasook vd. (2021). Bu çalışmaların çoğunda ekonomik büyüme, küreselleşme ve enerji tüketimi CO₂ emisyonlarını artırırken; Shahbaz vd. (2017b) çalışmalarında küreselleşme CO₂ emisyonlarını azaltmaktadır. Bazı çalışmalarda ise farklı değişkenler analize dâhil edilmiştir. Örneğin, Phong vd. (2018) çalışmalarında sanayileşmeyi de eklemiş ve enerji tüketiminin, sanayileşmenin ve kişi başına düşen GSYİH'nın uzun vadede CO₂ emisyonunu artırdığını, küreselleşmenin ise CO₂ emisyonunu azalttığını tespit etmişlerdir. Salahuddin vd. (2019) ise enerji tüketimi yerine enerji yoksulluğunu çalışmaya eklemiş ve ekonomik büyüme ve enerji yoksulluğunun CO₂ emisyonlarını artırdığını; küreselleşme ile CO₂ emisyonları arasında ters bir ilişki olduğunu belirlemiştir. Li vd. (2022) ise yeşil yatırım, yenilenemeyen enerji,

teknolojik yenilik ve küreselleşmenin CO₂ emisyonundaki etkilerini incelemiş ve yenilenemeyen enerji ile teknolojik yeniliklerin çevresel bozulmayı artırdığını; yeşil yatırım ve küreselleşmenin ise uzun dönemde çevresel bozulmayı azalttığını belirlemiştir. Bazı çalışmalarda ise enerji tüketimi yerine yenilenebilir enerji kullanılarak bu ilişki incelenmiştir. Örneğin, Bashir vd. (2020), Cao vd. (2021), He vd. (2021), Adebayo vd. (2022). Bu çalışmaların çoğunda yenilenebilir enerji CO₂ emisyonunu azaltmaktadır. Bu çalışmalardan Adebayo (2022), 1990-2018 dönemi için MINT ülkelerinde küreselleşme, ekonomik büyüme, yenilenemeyen ve yenilenebilir enerjinin CO₂ emisyonundaki etkilerini incelemiştir. Çalışmanın sonucuna göre, ekonomik büyümenin ve yenilenemeyen enerji kullanımının çevrenin bozulmayı artırdığı; küreselleşme ve yenilenebilir enerji kullanımının ise çevrenin bozulmasını engellemeye yardımcı olduğunu ortaya çıkarmıştır.

Küreselleşme ticaret faaliyetleri arttığında ölçek etkisi yoluyla kirliliği doğrudan artırabilirken; (Cole, 2004) politik küreselleşme ise kirliliği azaltıp çevre kalitesini artırmaktadır. (Bernauer et al., 2010). Küreselleşmenin CO₂ emisyonlarını azaltmadaki uzun vadeli olumlu etkisi, küreselleşmenin emisyonları azaltmadaki olumlu rolünü vurgulayan "California etkisi" hipotezini desteklerken; küreselleşme sonucu oluşan ticari açıklığın CO₂ emisyonlarını artırdığını ele alan "kirlilik cenneti-pollution haven" hipotezi ile çelişmektedir (Vogel, 1995). "California etkisi" çerçevesinde küreselleşmeyle beraber ülkelere FDI girişleri artmakta ve böylece CO₂ emisyonları azalmaktadır. Kirlilik Hale etkisi de (Pollution Halo Hypothesis) denilen bu hipoteze göre, yüksek teknoloji seviyelerine sahip ülkeler daha iyi yönetime ve daha az CO₂ emisyonuna sahip olacaktır (Shahbaz et al., 2011). Sasana vd. (2018) küreselleşmeyi farklı boyutlarıyla ele almış ve sosyal ve politik küreselleşmenin CO₂ emisyonunu artırdığını, ekonomik küreselleşmenin ise CO₂ emisyonunu azalttığını tespit etmiştir.

CO₂ emisyonunun yanında çevre kalitesini ekolojik ayak izi ile ölçen çalışmalarda son zamanlarda hızla artmıştır. Bu çalışmalarda enerji tüketimi, ekonomik büyüme, küreselleşme, ticari açıklık, finansal gelişme, kentleşme gibi değişkenler ile ekolojik ayak izi ilişkisi incelenmiştir. Bu çalışmalardan bazıları enerji verisi olarak yenilenebilir enerji tüketimini kullanarak çevresel kaliteyi ölçmüştür. Örneğin, Destek ve Sinha (2020), Ahmed vd. (2021), Alnour ve Atik (2021). Bu çalışmalarda yenilenebilir enerji tüketiminin artması, ekolojik ayak izini azaltarak daha temiz bir çevre oluşturmaktadır. Destek ve Sinha (2020) çalışmalarında, 1980-2013 dönemi için 24 OECD ülkesinde yenilenebilir ve yenilenemez enerji kullanımı, ekonomik büyüme ve ticari açıklığın ekolojik ayak izi üzerindeki etkisini incelemiştir. Çalışmanın sonucuna göre, yenilenebilir enerji tüketiminin artması ekolojik ayak izini azaltırken, yenilenemeyen enerji tüketiminin artması çevresel bozulmayı artırmaktadır. Ayrıca ekonomik büyüme ile ekolojik ayak izi arasında U şekilli bir ilişki olduğu tespit edilmiştir. Bazı çalışmalarda ise enerji tüketimi verisi kullanılarak ekolojik ayak izi ilişkisi incelenmiştir. Örneğin, Al-Mulali ve Öztürk (2015), Öztürk vd. (2016), Öcal vd. (2020), Abid vd. (2021), Nathaniel (2021a), Nathaniel (2021b), Rehman vd. (2021). Bu çalışmalarda enerji tüketimi ve ekonomik büyümenin çevresel tahribatı artırdığı görülmektedir. Örneğin, Öcal vd. (2020) 1968-2016 dönemi için Türkiye'de ekonomik büyüme, ticari açıklık, dış ticaret açıkları ve enerji tüketimindeki artışın ekolojik ayak izini

artırarak çevreyi kirlettiğini belirtmektedir. Ayrıca çalışmanın bulguları, yalnızca kirlilik emisyonlarını değil aynı zamanda çevresel bozulma için ekolojik ayak izini de dikkate almanın gerekli olduğunu göstermektedir.

Yapılan literatür çalışmalarının çoğunluğu Çevresel Kuznets eğrisi üzerinden konuyu ele almaktadır. Ancak bu çalışmada kübik bir fonksiyon olmaksızın, düz bir fonksiyonla çevre kalitesi tahmin edilmeye çalışılmıştır. Çalışmaya temel referans Pata'nın (2021) çalışmasıdır. Bu çalışma literatürdeki çalışmalardan farklı olması için Çevresel Kuznets ele alınmadan güncel yöntem ve modelle çevre kalitesi ölçülmüştür.

Yapılan literatür çalışmalarında çevre kalitesi karbon emisyonu ve ekolojik ayak izi değişkenleri kullanılarak ölçülmüştür. Ancak literatürde çevre değişkeni olarak hem karbon emisyonunu hem de ekolojik ayak izini aynı anda ele alan çalışmalar oldukça azdır. Aynı zamanda literatürde yenilenebilir enerjinin alt bileşenlerini analize dâhil eden çalışmalar sınırlıdır. Çalışmaların birçoğunda, enerji tüketimi, ekonomik büyüme ve küreselleşmenin karbon emisyonunu artırdığı ve ticari açıklık ile karbon emisyonu arasında negatif bir ilişki olduğu görülmektedir. Ancak yenilenebilir enerji tüketiminin karbon emisyonunu azalttığı tespit edilmiştir. Diğer taraftan, enerji tüketimi, ekonomik büyüme, ticari açıklık ve küreselleşme ekolojik ayak izini artırırken; yenilenebilir enerji tüketiminin artması ekolojik ayak izini azaltmaktadır. Kısacası yenilenebilir enerji tüketimi arttıkça hem karbon emisyonu azalmakta hem de ekolojik ayak izi azalmaktadır. Diğer bir deyişle, yenilenebilir enerji tüketiminin artması çevresel tahribatı azaltmaktadır.

4. Ampirik Analiz

Çalışmada ampirik analiz başlığı altında, öncelikle incelenen modeller ve veri seti hakkında bilgi verilmektedir. Daha sonra konuya dair durağanlık incelemesi, eşbütünlüşme analizi, model tahmini ve nedensellik incelemesi yapılmaktadır. Sonuç bölümünde ise, ampirik sonuçlar ekonomik açıdan yorumlanarak, politika önerileri sunulmaktadır.

4.1. Model ve Veri Seti

Çalışmada konu ekolojik ayak izi ve CO₂ emisyonları perspektifinden ele alınmaktadır. Bu noktada, konunun kıyaslamalı analizi için iki farklı model kıyaslamalı bir şekilde incelenmiştir. Çalışmada kullanılan modeller aşağıdaki şekilde gösterilmektedir:

$$\text{Model 1: } \ln EF_t = \beta_0 + \beta_1 \ln KOF + \beta_2 \ln GDP + \beta_3 \ln HYE + \varepsilon_t \quad (1)$$

$$\text{Model 2: } \ln CO2_t = \beta_0 + \beta_1 \ln KOF + \beta_2 \ln GDP + \beta_3 \ln HYE + \varepsilon_t \quad (2)$$

Çalışmada ampirik analiz için, 1971-2014 dönemi yıllık veriler kullanılmıştır. Hidroelektrik kaynaklardan elektrik üretimi verisinin son dönem verileri olmadığı için, çalışmanın veri aralığı bu şekilde oluşturulmuştur. Ülkelerin karbon salınımlarına bakıldığında, ABD zirvede olan ülkelerin başında yer almaktadır. Bu nedenle konu ABD

için, güncel yöntemlerle incelenmiştir. Değişkenlere ilişkin kısaltmalar ve veri kaynakları Tablo 2'de gösterilmektedir.

Tablo: 2
Veri Seti

Değişken	Değişkenlere Dair Kısaltmalar	Veri Kaynağı
EF	Ekolojik Ayak İzi	Global Footprint Network
CO ₂	CO ₂ emisyonları (kişi başına metrik ton)	World Bank
KOF	Ekonomik, politik ve sosyal küreselleşmeyi içeren endeks	KOF İsviçre Ekonomi Enstitüsü Veri Tabanı
HYE	Hidroelektrik kaynaklardan elektrik üretimi (toplamın yüzdesi)	World Bank
GDP	Kişi başına GSYİH	World Bank

4.2. Durağanlık Analizi

Değişkenlerin arasındaki ilişkiyi analiz etmeden önce, durağanlık incelemesi yapılmıştır. Durağanlık incelemeleri geleneksel ADF ve Zivot-Andrews birim kök incelemesiyle yapılmıştır. Perron (1989) yapısal kırılmaların söz konusu olduğu durumlarda, birim kök temel hipotezinin reddedilememesinin söz konusu olabileceğini vurgulamıştır. Ayrıca geleneksel ADF testinin de gücünün azaldığını ortaya koymuştur. Bu nedenle, yapısal kırılmaların dikkate alınabilmesi için birim kök incelemesi Zivot-Andrews (1992) testiyle yapılmıştır. Zivot-Andrews (1992) testiyle birlikte, geleneksel ADF testine göre de durağanlık incelemesi sonuçları raporlanmıştır. Söz konusu birim kök analiz sonuçları Tablo 3'te gösterilmektedir.

Tablo: 3
Birim Kök Analiz Sonuçları

Değişkenler	Zivot-Andrews Sonuçları			ADF Sonuçları	
	Test İstatistikleri	Kırılma Tarihleri	p	Test İstatistikleri	p
lnEF	-2.890	2007	0	-1.099	0.707
lnCO ₂	-2.985	2008	3	-0.296	0.916
lnKOF	-2.863	1985	0	-1.231	0.652
lnHYE	-4.518	1987	0	-1.703	0.422
lnGDP	-4.629	2008	1	-1.604	0.471
ΔlnEF	-7.546***	1984	0	-6.595***	0.000
ΔlnCO ₂	-5.963***	1984	0	-5.476***	0.000
ΔlnKOF	-7.273***	1982	0	-6.485***	0.000
ΔlnHYE	-7.764***	2002	0	-7.512***	0.000
ΔlnGDP	-5.398***	1983	0	-4.867***	0.000

Not: *** ve ** sırasıyla %1 ve %5 düzeyinde anlamlılığı göstermektedir.

Tablo 3'de yer alan birim kök incelemesi sonuçlarına göre, tüm değişkenlerin hem Zivot-Andrews birim kök testi hem de geleneksel ADF testine göre, I(1) itibariyle durağan olduğu tespit edilmiştir. Bu noktada, bir sonraki aşama olan eşbütünleşme analizine geçilmiştir.

4.3. Eşbütünleşme Analizi

Banerjee vd. (2017) tarafından önerilen Fourier ADL eşbütünleşme analizinin temeli, otoregresif dağıtılmış gecikme modeline dayanmaktadır. Söz konusu model şu şekilde gösterilmektedir:

$$\Delta y_{1t} = d(t) + \vartheta_1 y_{1,t-1} + \gamma' y_{2,t-1} + \alpha \Delta y_{2t} + e_t \quad (3)$$

$d(t)$ deterministik terimi ifade etmekle birlikte şu şekilde gösterilmektedir:

$$d(t) = \beta_0 + \delta_1 \sin\left(\frac{2\pi kt}{T}\right) + \delta_2 \cos\left(\frac{2\pi kt}{T}\right) \quad (4)$$

Yukarıda yer alan denklemde, t , T ve π sırasıyla trende terimini, örneklem büyüklüğünü ve π sayısını (3.1416) ifade etmektedir. Ayrıca k frekans değerini temsil etmektedir. Denklem 2 modelde yerine yazıldığında, model şu şekilde gösterilmektedir:

$$\Delta y_{1,t} = \beta_0 + \delta_1 \sin\left(\frac{2\pi kt}{T}\right) + \delta_2 \cos\left(\frac{2\pi kt}{T}\right) + \vartheta_1 y_{1,t-1} + \gamma' y_{2,t-1} + \alpha \Delta y_{2t} + e_t \quad (5)$$

Banerjee vd. (2017) çalışmasında, frekans değerlerinin tam sayı değerler [1, 2, ..., 5] almasını önermişlerdir. Bu noktada, Ilkay vd. (2021) kalıcı kırılmalara vurgu yaparak, Christopoulos ve Leon-Ledesma (2011) çalışmalarında önerdiği kesirli frekans değerlerini dikkate almışlardır. Dolayısıyla frekans değerlerinin (k) tam sayı değerler [1, 2, ..., 5] yerine, kesirli şekilde [0.1, 0.2, ..., 5] değişmesine izin verilmiştir.

Çalışmada değişkenlerin fark itibarıyla durağan olduğu tespit edildikten sonra, eşbütünleşme ilişkisinin incelenmesindeki ön koşulu sağlandığı tespit edilmiştir. Bu noktada, eşbütünleşme ilişkisinin gerekli ön koşulunun sağlandığı ortaya konulmuştur. Eşbütünleşme ilişki Fourier ADL ve Kesirli Fourier ADL yöntemleriyle karşılaştırmalı olarak ele alınmıştır. Bu noktada, Tablo 4'te Fourier ADL eşbütünleşme test sonuçlarına yer verilirken; Tablo 5'te Kesirli Frekanslı Fourier-ADF test sonuçlarına yer verilmektedir.

Tablo: 4
Fourier-ADL Eşbütünleşme Testi Sonuçları

Modeller	$t_{ADL}^f(\hat{k})$	\hat{k}	AIC	Gecikme	1%	5%	Eşbütünleşme İlişkisi
$\ln EF = f(\ln KOF, \ln GDP, \ln HYE)$	-5.472***	1	-4.371	ADL(3,4,2,4)	-5.17	-4.51	✓
$\ln CO_2 = f(\ln KOF, \ln GDP, \ln HYE)$	-4.589**	1	-4.757	ADL(4,3,1,1)	-5.17	-4.51	✓

Not: *** ve ** sırasıyla %1 ve %5 düzeyinde anlamlılığı göstermektedir.

Tablo 4'te yer alan Fourier ADL eşbütünleşme analizi sonuçlarına göre, her iki modelde de eşbütünleşme ilişkisinin var olduğu saptanmıştır. Elde edilen bu sonuç, uzun dönemli ilişkinin varlığını ortaya koymaktadır.

Tablo: 5
Kesirli Frekanslı Fourier-ADL Eşbütünleşme Testi Sonuçları

Models	$t_{ADL}^f(\hat{k})$	\hat{k}	AIC	Lags	1%	5%	Eşbütünleşme İlişkisi.
$\ln EF = f(\ln KOF, \ln GDP, \ln HYE)$	-5.548***	1.1	-4.393	ADL(3,4,2,2)	-5.16	-4.48	✓
$\ln CO_2 = f(\ln KOF, \ln GDP, \ln HYE)$	-0.448	3.3	-4.884	ADL(4,4,2,2)	-4.828	-4.114	X

Not: *** ve ** sırasıyla %1 ve %5 düzeyinde anlamlılığı göstermektedir. Tablo değerleri için Ilkay, Yılanca, Ulucak ve Jones (2021) çalışmasından yararlanılmıştır.

Tablo 5'te yer alan Kesirli Frekanslı Fourier ADL eşbütünleşme analizi sonuçlarına göre, ilk modelde eşbütünleşme ilişkisinin varlığı saptanırken; ikinci modelde eşbütünleşme

ilişkinin olmadığı ortaya konulmuştur. Bu noktada, nedensellik incelemesinde tam sayı frekans değerleri ele alındığı için, Fourier ADL eşbütünleşme analizi sonuçlarına göre model tahmini aşamasına geçilmiştir.

4.4. Model Tahmini

Katsayı tahmini için, FMOLS tahmincisi kullanılmıştır. Tablo 6'da katsayı tahmin sonuçlarına yer verilmektedir. Buna göre hem model 1 hem de model 2'de, GDP ve HYE değişkenlerinin istatistiki olarak anlamlı olduğu tespit edilmiştir. Her iki modelde de GSYİH'nin ekolojik ayak üzerinde pozitif etkisi olduğu tespit edilmiştir. Benzer şekilde her iki modelde HYE'nin CO₂ emisyonları üzerinde negatif etkisi olduğu ortaya konulmuştur. Bu sonuçlar, teorik ve istatistiki olarak anlamlıdır.

Tablo: 6
Uzun Dönem Katsayı Tahmincisi Sonuçları (FMOLS)

Modeller	$\ln EF = f(\ln KOF, \ln GDP, \ln HYE)$		$\ln CO_2 = f(\ln KOF, \ln GDP, \ln HYE)$	
	Katsayılar	p-değeri	Katsayılar	p-değeri
KOF	0.514	0.149	0.339	0.275
GDP	1.368***	0.000	1.134***	0.000
HYE	-0.043*	0.071	-0.040*	0.052
SIN	-0.004	0.249	-0.003	0.309
COS	-0.003	0.401	-0.003	0.380
C	-0.035	0.000	-0.030	0.000

Not: *, ** ve *** sırasıyla %10, %5 ve %1 düzeyinde anlamlılık göstermektedir.

4.5. Nedensellik Analizi

Toda-Yamamoto (1995), VAR(p+d) modelinin tahminine vurgu yapmaktadır. Bu noktada, serilerin seviyede durağan olması gereklilik olmaktan çıkmaktadır. Bu sayede, serilerin daha fazla bilgi taşıması mümkün hale gelmektedir. Toda-Yamamoto (TY) nedensellik testinde iki önemli parametre bulunmaktadır. Bunlardan ilki, uygun gecikme uzunluğu (p) iken, diğeri maksimum entegrasyon derecesidir. Söz konusu parametrelerin dahil olduğu model şu şekilde gösterilmektedir:

$$y_t = d(t) + \vartheta_1 y_{t-1} + \dots + \vartheta_{p+d} y_{t-(p+d)} + e_t \quad (6)$$

$d(t)$ deterministik terimi ifade etmektedir. Nazlıoğlu vd. (2016) çalışmalarında, Toda-Yamamoto çerçevesini Fourier yaklaşımı yoluyla yapısal değişimlerle genişleterek, Granger nedensellik analizindeki kırılmaları hesaba katmak yeni bir yaklaşım ortaya koymuşlardır. Tarihi, sayısı ve kırılma şekli bilinmeyen kademeli bir süreç olarak, yapısal değişimleri yakalamak için Fourier açılımı şu şekilde ifade edilmektedir:

$$d(t) = \beta_0 + \sum_{k=1}^n \delta_{1k} \sin\left(\frac{2\pi kt}{T}\right) + \sum_{k=1}^n \delta_{2k} \cos\left(\frac{2\pi kt}{T}\right) \quad (7)$$

Yukarıda yer alan denklemde, n frekans sayısını, δ_{1k} frekans boyutunu, δ_{2k} frekans değişikliğini ifade etmektedir. Nazlıoğlu vd. (2016) çalışmalarında deterministik terimi modele dahil ederek, modeli yumuşak yapısal kırılmalarla ifade etmiştir. Bu noktada, Nazlıoğlu vd. (2016) tekli Fourier frekansı ile $d(t)$ 'yi şu şekilde ifade etmektedir:

$$d(t) = \beta_0 + \delta_1 \sin\left(\frac{2\pi kt}{T}\right) + \delta_2 \cos\left(\frac{2\pi kt}{T}\right) \quad (8)$$

$d(t)$ 'nin Model 4'te yerine yazılmasıyla birlikte Denklem 9 elde edilmektedir.

$$y_t = \beta_0 + \delta_1 \sin\left(\frac{2\pi kt}{T}\right) + \delta_2 \cos\left(\frac{2\pi kt}{T}\right) + \vartheta_1 y_{t-1} + \dots + \vartheta_{p+d} y_{t-(p+d)} + e_t \quad (9)$$

Denklem 9'da yer alan modelde öncelikle, Fourier frekansının (k) ve gecikme uzunluğunun (p) tespit edilmesi gerekmektedir. Burada, k ve p'nin optimal sayısı tespit edilirken bilgi kriterlerinden en küçük değerleri veren k ve p değerleri ele alınmaktadır (Nazlıoğlu et al., 2016: 15). Nedensellik analizine ilişkin söz konusu hipotezler şu şekilde kurulmaktadır:

H_0 =Nedensellik ilişkisi yoktur.

H_1 = Nedensellik ilişkisi vardır.

Nedensellik ilişkisini tespit etmek için, Fourier Toda-Yamamoto nedensellik analizi yapılmıştır. Söz konusu analiz sonuçları Tablo 7'de gösterilmektedir.

Tablo 7
Fourier Toda-Yamamoto Nedensellik Testi Sonuçları

H_0 Hipotez	Wald Test İstatistiği	Asymptotic Olasılık Değeri	Bootstrap Olasılık Değeri	Uygun Gecikme Uzunluğu	Uygun Frekans Değeri
lnEF= f (lnKOF, lnGDP, lnHYE)					
KOF/→ EF	1.315	0.240	0.250	1	1
GDP/→ EF	4.607	0.031**	0.038**	1	1
HYE/→ EF	2.703	0.100*	0.112	1	1
EE/→ KOF	2.539	0.111	0.120	1	1
EE/→GDP	3.159	0.075*	0.082*	1	1
EE/→HYE	0.736	0.390	0.396	1	1
lnCO ₂ = f (lnKOF, lnGDP, lnHYE)					
KOF/→ CO ₂	7.102	0.007***	0.010***	1	1
GDP/→ CO ₂	0.158	0.690	0.699	1	1
HYE/→ CO ₂	1.442	0.229	0.239	1	1
CO ₂ /→ KOF	0.054	0.814	0.813	1	1
CO ₂ /→GDP	0.258	0.610	0.614	1	1
CO ₂ /→HYE	0.012	0.910	0.914	1	1

Not: *, ** ve *** sırasıyla %10, %5 ve %1 düzeyinde anlamlılık göstermektedir. 10.000 adet bootstrap simülasyonu ile analizler yapılmıştır.

Tablo 7'de yer alan nedensellik analiz sonuçlarına göre, ilk modelde kişi başı GSYİH'den EF'ye doğru tek yönlü nedensellik ilişkisi tespit edilmiştir. Benzer şekilde, HYE'den EF'ye doğru tek yönlü nedensellik ilişkisi tespit edilmiştir. İkinci modelde ise, sadece KOF'dan CO₂'ye doğru tek yönlü nedensellik ilişkisi tespit edilmiştir. Analiz sonucunda ortaya konulan nedensellik sonucu ve nedenselliğin yönü Tablo 8'de özetlenmektedir.

Tablo: 8
Nedensellik Sonuçlarının Özeti

Modeller		Nedensellik
$\ln EF = f(\ln KOF, \ln GDP, \ln HYE)$	GDP \leftrightarrow EF HYE \rightarrow EF	✓
$\ln CO_2 = f(\ln KOF, \ln GDP, \ln HYE)$	KOF \rightarrow CO ₂	✓

5. Sonuç

Küresel ısınma, küresel iklim değişikliği ve su kirliliği gibi çevresel sorunlar gelecek nesilleri tehdit etmektedir. Küresel emisyonların nerdeyse tamamına sahip olan ülkeler, küresel ısınmayı kontrol edebilmek ve sera gazı emisyonlarını azaltmak için önce 1997'de Kyoto Protokolünü, daha sonra 2016'da Paris iklim anlaşmasını kabul etmesine rağmen halen karbon emisyonlarını ve ekolojik ayak izini artırmaya devam etmektedir. Bu eksenle, yaşadığımız çevre kirlenmekte ve çevresel tahribat artmaktadır. Bu bağlamda, bu çalışma küreselleşme, ekonomik büyüme ve hidroelektrik enerjinin karbon emisyonu ve ekolojik ayak izi üzerindeki etkisini araştırmaktadır. Karbon emisyonu ve ekolojik ayak izinde, dünyada ilk 10 ülke içinde olan, diğer bir deyişle çevresel bozulmayı artıran ABD örneklem ülke olarak seçilmiştir. Bu amaçla, pürüzsüz kırılmaları da ele alan Fourier yaklaşımıyla ADL eşbütünlüşme ve Fourier Toda-Yamamoto nedensellik testleri kullanılmıştır.

Çalışmada konu iki farklı modelle ele alınarak detaylı şekilde incelenmiştir. Bu noktada, İlkay vd.'nin (2021) çalışmalarında önerilen Kesirli Fourier ADL eşbütünlüşme testi ile konu incelenmiştir. Söz konusu yöntem oldukça güncel olmakla birlikte, incelenen konuya dair literatürün genişletilmesi noktasında önemli katkı sağlayacağı düşünülmektedir. Çünkü söz konusu yöntemin ele alındığı çalışma sayısı oldukça sınırlıdır. Ayrıca çalışmada, karşılaştırma yapabilmek adına Fourier ADL eşbütünlüşme testine ve Fourier Toda-Yamamoto nedensellik testine yer verilmiştir.

Çalışmada, ABD'de küreselleşme, ekonomik büyüme ve hidroelektrik kaynaklardan elektrik üretiminin karbon emisyonu ve ekolojik ayak izi üzerindeki etkisi, Fourier ADL eşbütünlüşme ve Fourier Toda-Yamamoto nedensellik testleri ile araştırılmıştır. Çalışmada ampirik analiz için, 1971-2014 dönemi yıllık veriler kullanılmıştır. Hidroelektrik kaynaklardan elektrik üretimi verisinin son dönem verileri olmadığı için, çalışmanın veri aralığı bu şekilde oluşturulmuştur. Çalışmada ABD'nin ele alınmasının nedeni hem ekolojik ayak izi hem de karbon emisyonunda ABD'nin ilk sıralarda yer almasıdır. Diğer bir deyişle dünyanın en büyük çevre kirleticilerinden biri olan ABD'de hidroelektrik enerjinin öneminin vurgulanmasıdır.

Fourier ADL testi sonuçları, hidroelektrik kaynaklardan elektrik üretimi, küreselleşme, kişi başı GSYİH, ekolojik ayak izi ve CO₂ emisyonlarının eş bütünlüşük olduğunu ortaya koymaktadır. Kesirli Frekanslı Fourier ADL eşbütünlüşme analizinde de ekolojik ayak izini inceleyen Model 1'de eşbütünlüşük ilişki mevcutken; CO₂ emisyonunu inceleyen Model 2'de eşbütünlüşme ilişkinin olmadığı ortaya konulmuştur. Bu noktada, nedensellik incelemesinde tam sayı frekans değerleri ele alındığı için, Fourier ADL

eşbütünlüşme analizi sonuçlarına göre model tahmini aşamasına geçilmiştir. Tahmin sonuçlarına göre, kişi başı GSYİH'daki artışlar ekolojik ayak izini artırmaktadır. Ayrıca hidroelektrik kaynaklardan elektrik üretiminin CO₂ emisyonları üzerinde negatif etkisi vardır. Dolayısıyla yenilenebilir enerji kaynakları içinde hidroelektrik kaynaklar kullanıldıkça ABD'de CO₂ emisyonları azalmaktadır. Fourier Toda-Yamamoto nedensellik testi sonuçları, hidroelektrik kaynaklardan elektrik üretiminden ve kişi başı GSYİH'dan ekolojik ayak izine doğru tek yönlü nedenselliklerin varlığını göstermektedir. Ayrıca KOF'dan CO₂'ye doğru tek yönlü nedensellik ilişkisi bulunmaktadır.

Çalışmada kişi başı GSYİH'daki artışların ekolojik ayak izini artırdığı tespit edilmiştir. Elde edilen bu sonuçlar Öcal vd. (2020) ve Rehman vd.'nin (2021) sonuçlarıyla örtüşmektedir. Çalışmada yenilenebilir enerji değişkeni yerine hidroelektrik enerji kullanılmıştır. Ele alınan literatürde hidroelektrik enerji kullanılmamıştır. Yapılan analiz neticesinde hidroelektrik enerjideki artışın CO₂ emisyonlarını azalttığı belirlenmiştir. Bu sonuçlar Bashir vd. (2020), Khan vd. (2020), Cao vd. (2021) ve Adebayo vd.'nin (2022) sonuçlarıyla örtüşmektedir.

Bulunan ekonometrik bulgular ışığında çalışma bazı politika öneriler sunmaktadır:

I) ABD için yenilenebilir enerji çevre kalitesinin artırılması ve çevresel bozulmayı önlemek için önemli bir etkidir. Hidroelektrik enerjiler kurulum aşamasında çevreye zarar verse de ve yeni projeleri sınırlasa da uzun dönemde çevre kirliliğini azaltacaktır. Ayrıca diğer enerji kaynaklarına göre daha ucuz olmasından dolayı alternatif enerji kaynaklarına göre tercih edilmektedir. Çalışmada da hidroelektrik kaynaklardan elektrik üretiminin CO₂ emisyonlarını azalttığı görülmektedir. Bu nedenle dünyanın en büyük çevre kirleticilerinden biri olan ABD'de hidroelektrik enerjinin kullanılması hem daha temiz bir ABD hem de daha temiz bir dünya yaratacaktır. Aynı zamanda diğer enerji kaynaklarına göre daha temiz bir enerji kaynağı olan hidroelektrik enerji, küresel iklim değişikliği ve küresel ısınmaya karşı tüm ülkelerin daha fazla kullanması gereken bir enerji kaynağı olmalıdır.

II) Dünyanın en büyük ekonomik gücü olan ABD, küreselleşmenin ve ticaretin merkezidir. Küreselleşme ve GDP, çevresel tahribatın artmasına neden olmaktadır. ABD, ekolojik ayak izi ve CO₂ emisyonunda dünyada ilk 10'da yer alan ülkelerden biridir. Ortalama bir Amerikalının ekolojik ayak izi dünya ortalamasının 3 katıdır. Bu nedenle ABD, dünyanın en büyük kirleticilerinden biridir. Dolayısıyla oluşan bu çevresel bozulmayı önlemenin yolu, yenilenebilir enerji kaynaklarına yönelmektir. Çünkü yapılan çalışmaların birçoğunda görüldüğü üzere, yenilenebilir enerji kullanımı arttıkça karbon emisyonu ve ekolojik ayak izi azalmaktadır. Böylece ABD'deki ve dünyadaki çevresel tahribat azalacaktır.

Bu çalışmada yenilenebilir enerji kaynaklarından hidroelektrik enerjisi kullanılmıştır. Yakın gelecekte ABD için bu konu özelinde yapılacak çalışmalarda hidroelektrik enerjisi yerine başka değişkenler kullanılabilir. Öyle ki; ABD, jeotermal enerji kurulu gücü ve nükleer enerji santrali kurulu gücü açısından dünyada 1. sıradadır. Aynı zamanda, güneş ve

rüzgâr enerji santrali kurulu gücü açısından ise Çin'in ardından dünyada 2. sıradadır. Bu nedenle gelecekte yapılacak çalışmalarda, bu dört değişken kullanılabilir. Diğer bir tavsiye olarak da ekolojik ayak izinin 6 alt bileşeni kullanılarak da bu çalışma ABD ya da farklı ülke grupları için ele alınabilir. Böylece yenilenebilir enerjinin çevre üzerindeki etkileri için daha kapsamlı bilgilere ulaşılabilecektir.

Kaynaklar

- Abid, A. et al. (2021), "Analyzing ecological footprint through the lens of globalization, financial development, natural resources, human capital and urbanization", *Pakistan Journal of Commerce and Social Sciences*, 15(4), 765-795.
- Adebayo, T.S. et al. (2022), "The influence of renewable energy usage on consumption-based carbon emissions in MINT economies", *Heliyon*, 8(2), e08941.
- Ahmed, Z. et al. (2021), "Economic growth, renewable energy consumption, and ecological footprint: Exploring the role of environmental regulations and democracy in sustainable development", *Sustainable Development*, 30, 595-605.
- Akın, C.S. (2014), "The impact of foreign trade, energy consumption and income on CO₂ emissions", *International Journal of Energy Economics and Policy*, 4(3), 465-475.
- Al-Mulali, U. & İ. Özturk (2015), "The effect of energy consumption, urbanization, trade openness, industrial output, and the political stability on the environmental degradation in the MENA (Middle East and North African) region", *Energy*, 84, 382-389.
- Alnour, M. & H. Atik (2021), "The dynamic implications of globalization and renewable energy in Turkey: Are they vital for environmental sustainability? An Svar analysis", *Bilgi*, 23(2), 288-314.
- Amri, F. (2018), "Carbon dioxide emissions, total factor productivity, ICT, trade, financial development, and energy consumption: testing environmental Kuznets curve hypothesis for Tunisia", *Environmental Science and Pollution Research*, 25(33), 33691-33701.
- Anser, M.K. et al. (2021), "Does globalization affect the green economy and environment? The relationship between energy consumption, carbon dioxide emissions, and economic growth", *Environmental Science and Pollution Research*, 28, 51105-51118.
- Banerjee, P. et al. (2017), "Fourier ADL cointegration test to approximate smooth breaks with new evidence from Crude Oil Market", *Econ. Modell.*, 67, 114-124.
- Barrett, S. (2000), "Trade and environment: local versus multilateral reforms. Environment and Development Economics", 5(4), 349-359.
- Bashir, M.F. et al. (2020), "The nexus between environmental tax and carbon emissions with the roles of environmental technology and financial development", *Plos One*, 15(11), e0242412.
- Baydoun, H. & M. Aga (2021), "The effect of energy consumption and economic growth on environmental sustainability in the GCC countries: does financial development matter?", *Energies*, 14(8), 5897.
- Bazan, G. (1997), "Our ecological footprint: reducing human impact on the Earth", *Electronic Green Journal*, 1(7), doi: 10.5070/G31710273.

- Bernauer, T. & P.M. Kuhn (2010), "Is there an environmental version of the Kantian peace? Insights from water pollution in Europe", *European Journal of International Relations*, 20(10), 1-26.
- Cao, H. et al. (2021), "Impact of globalization, institutional quality, economic growth, electricity and renewable energy consumption on carbon dioxide emission in OECD countries", *Environmental Science and Pollution Research*, 29, 24191-24202.
- Chebbi, H.E. et al. (2011), "Trade openness and CO₂ emissions in Tunisia", *Middle East Development Journal*, 3(1), 29-53.
- Chienwattanasook, K. et al. (2021), "The impact of economic growth, globalization, and financial development on CO₂ emissions in ASEAN countries", *Academy of Strategic Management Journal*, 20(3), 1-14.
- Christopoulos, D.K. & M.A. Leon-Ledesma (2011), "International output convergence, breaks, and asymmetric adjustment", *Studies in Nonlinear Dynamics and Econometrics*, 15(3), <https://doi.org/10.2202/1558-3708.1823>.
- Cole, M.A. & E. Neumayer (2004), "Examining the impact of demographic factors on air pollution", *Population and Environment*, 26(1), 5-21.
- Cole, M.A. et al. (1997), "The environmental Kuznets curve: An empirical analysis", *Environment and Development Economics*, 2(4), 401-416.
- Dauda, L. et al. (2021), "Innovation, Trade Openness and CO₂ Emissions in Selected Countries in Africa", *Journal of Cleaner Production*, 281, 125143.
- Destek, M. & A. Sinha (2020), "Renewable, non-renewable energy consumption, economic growth, trade openness and ecological footprint: Evidence from organisation for economic Co-operation and development countries", *MPRA Paper No. 104246*.
- Dinda, S. et al. (2000), "Air quality and economic growth: An empirical study", *Ecological Economics*, 34, 409-423.
- Ertuğrul, H.M. et al. (2016), "The impact of trade openness on global carbon dioxide emissions: evidence from the top ten emitters among developing countries", *Ecological Indicators*, 67, 543-555.
- Essandoh, O.K. et al. (2020), "Linking international trade and foreign direct investment to CO₂ emissions: any differences between developed and developing countries?", *Science of the Total Environment*, 712, 136437.
- Farhani, S. et al. (2013), "Panel analysis of CO₂ emissions, GDP, energy consumption, trade openness and urbanization for Mena countries", *MPRA Paper No. 49258*.
- Global Footprint Network (2022), <<https://www.footprintnetwork.org/our-work/ecological-footprint/>>, 28.12.2022.
- Grossman, G.M. & A.B. Krueger (1991), *Environmental impacts of a North American free trade agreement*, National Bureau of Economic Research, 3914.
- He, K. et al. (2021), "Does globalization moderate the effect of economic complexity on CO₂ emissions? Evidence from the top 10 energy transition economies", *Frontiers in Environmental Science*, 9, 778088.
- İlkay, S.C. et al. (2021), "Technology spillovers and sustainable environment: Evidence from time-series analyses with Fourier extension", *Journal of Environmental Management*, 294, 113033.

- Jena, P.R. & U. Grote (2008), "Growth-trade-environment nexus in India", *Economics Bulletin*, 17(11), 1-11.
- Kalaycı, C. & P. Hayaloğlu (2018), "The impact of economic globalization on CO₂ emissions: The case of NAFTA countries", *International Journal of Energy Economics and Policy*, 9(1), 356-360.
- Kasman, A. & Y.S. Duman (2015), "CO₂ emissions, economic growth, energy consumption, trade and urbanization in New EU member and candidate countries: a panel data analysis", *Economic Modelling*, 44, 97-103.
- Keleş, Ö. (2010), "Sürdürülebilir yaşam göstergesi: Ekolojik ayak izi", *Tabiat ve İnsan*, 2(2), 3-10.
- Khan, M.K. et al. (2020), "The relationship between energy consumption, economic growth and carbon dioxide emissions in Pakistan", *Financial Innovation*, 6(1), 1-13.
- KOF (2022), *KOF Globalisation Index*, <<https://kof.ethz.ch/en/forecasts-andindicators/indicators/kof-globalisation-index.html>>, 29.12.2022.
- Latif, Z. et al. (2018), "The dynamics of ICT, foreign direct investment, globalization and economic growth: Panel estimation robust to heterogeneity and cross-sectional dependence", *Telematics and Informatics*, 35(2), 318-328.
- Li, S. et al. (2022), "The impact of green investment, technological innovation, and globalization on CO₂ emissions: evidence from MINT countries", *Frontiers in Environmental Science*, 10, 868704.
- Lv, Z. & T. Xu (2019), "Trade openness, urbanization and CO₂ emissions: dynamic panel data analysis of Middle-income countries", *The Journal of International Trade & Economic Development*, 28(3), 317-330.
- Managi, S. et al. (2009), "Does trade openness improve environmental quality?", *Journal of Environmental Economics and Management*, 58(3), 346-363.
- Nathaniel, S.P. (2021a), "Ecological footprint and human well-being nexus: accounting for broad-based financial development, globalization, and natural resources in the Next-11 countries", *Future Business Journal*, 7(24), 1-18.
- Nathaniel, S.P. (2021b), "Natural resources, urbanisation, economic growth and the ecological footprint in South Africa: the moderating role of human capital", *Quaestiones Geographicae*, 40(2), 63-76.
- Nazlıoğlu, S. et al. (2016), "Oil prices and real estate investment trusts (REITs), Gradual-shift causality and volatility transmission analysis", *Energy Economics*, 60, 168-175.
- Öcal, O. vd. (2020), "The effects of economic growth and energy consumption on ecological footprint and carbon emissions: evidence from Turkey", *Ekonomi, Politika & Finans Araştırmaları Dergisi*, 5(3), 667-681.
- Öztürk, I. et al. (2016), "Investigating the environmental Kuznets curve hypothesis: the role of tourism and ecological footprint", *Environmental Science and Pollution Research*, 23(2), 1916-1928.
- Pata, U.K. (2021), "Linking renewable energy, globalization, agriculture, CO₂ emissions and ecological footprint in BRIC countries: A sustainability perspective", *Renewable Energy*, 173, 197-208.
- Perron, P. (1989), "The great crash, the oil price shock, and the unit root hypothesis", *Econometrica*, 57, 1361-1401.

- Phong, L.H. et al. (2018), "The role of globalization on carbon dioxide emission in Vietnam incorporating industrialization, urbanization, gross domestic product per capita and energy use", *International Journal of Energy Economics and Policy*, 8(6), 275-283.
- Rehman, A. et al. (2021), "The impact of globalization, energy use, and trade on ecological footprint in Pakistan: Does environmental sustainability exist?", *Energies*, 14, 5234.
- Sahu, N.C. & P. Kumar (2020), "Impact of globalization, financial development, energy consumption, and economic growth on CO₂ emissions in India: Evidence from ARDL approach", *Journal of Economics, Business and Management*, 8(3), 241-245.
- Salahuddin, M. et al. (2019), "Urbanization-globalization-CO₂ emissions nexus revisited: empirical evidence from South Africa", *Heliyon*, 5, e01974.
- Salman, M. et al. (2019), "Different impacts of export and import on carbon emissions across 7 ASEAN countries: a panel quantile regression approach", *Science of the Total Environment*, 686, 1019-1029.
- Sasana, H. et al. (2018), "The impact of globalization against environmental condition in Indonesia", *E3S Web of Conferences* 73, 02012, ICENIS 2018.
- Sbia, R. et al. (2014), "A contribution of foreign direct investment, clean energy, trade openness, carbon emissions and economic growth to energy demand in UAE", *Economic Modelling*, 36, 191-197.
- Shafik, N. & S. Bandyopadhyay (1992), "Economic growth and environmental quality: time series and cross-section evidence", *Background Paper for the 1992 World Development Report*, Washington DC: The World Bank.
- Shahbaz, M. et al. (2011), "Environmental consequences of economic growth and foreign direct investment: evidence from panel data analysis", *MPRA Paper* 32547.
- Shahbaz, M. et al. (2013), "The effects of financial development, economic growth, coal consumption and trade openness on CO₂ emissions in South Africa", *Energy Policy*, 61, 1452-1459.
- Shahbaz, M. et al. (2017a), "Trade openness-carbon emissions nexus: the importance of turning points of trade openness for country panels", *Energy Economics*, 61, 221-232.
- Shahbaz, M. et al. (2017b), "The impact of globalization on CO₂ emissions in China", *The Singapore Economic Review*, 62(4), 929-957.
- Shahbaz, M. et al. (2019), "The technical decomposition of carbon emissions and the concerns about FDI and trade openness effects in the United States", *International Economics*, 159, 56-73.
- Sharmin, M. & M. Tareque (2018), "Econometric analysis of the effect of economic globalization, energy intensity, urbanization, industrialization and growth on CO₂ emissions of Bangladesh", *Managing Global Transitions*, 16(4), 335-354.
- Stern, D.I. (2004), "The rise and fall of the environmental Kuznets curve", *World Development*, 32(8), 1419-1439.
- Toda, H.Y. & T. Yamamoto (1995), "Statistical inference in vector autoregressions with possibly integrated processes", *Journal of Econometrics*, 66(1-2), 225-250.
- Vogel, D. (1995), *Trading up: consumer and environmental regulation in a global economy*, Cambridge/MA.

- Wackernagel, M. & W. Rees (1996), *Our ecological footprint: reducing human impact on the Earth*, Canada: New Society Publishers.
- Worldbank (2022), *World Development Indicators*, <<https://databank.worldbank.org/source/world-development-indicators>>, 29.12.2022.
- wwf (2022), *World Wildlife-Kırmızı Alarm*, <<https://wwf.org.tr>>, 29.12.2022.
- Zhang, S. et al. (2017), "Does trade openness affect CO₂ emissions: evidence from ten newly industrialized countries?", *Environ Sci Pollut Res*, 24, 17616-17625.
- Zivot, E. & D.W.K. Andrews (1992), "Further Evidence on the Great Crash, the OilPrice Shock, and the Unit-Root Hypothesis", *Journal of Business & Economic Statistics*, 10(3), 251-270.

Kamacı, A. (2024). "Küreselleşme, Hidroelektrik Enerji, Ekonomik Büyüme, CO₂ Emisyonları ve Ekolojik Ayak İzi İlişkisinin ABD İçin Analizi: Kesirli Fourier ADL Eşbütünleşme Yöntemi", *Sosyoekonomi*, 32(59), 249-267.

Avrupa Birliđi Ülkelerinde Çevre Vergilerinin Çevre, Ekonomik Büyüme ve İşsizlik Üzerindeki Etkisinin Ampirik Analizi¹

Sema DİRGEN-ÖZ (<https://orcid.org/0000-0002-5614-6565>), Akdeniz University, Türkiye;
semaoz@akdeniz.edu.tr

Hüseyin Güçlü ÇİÇEK (<https://orcid.org/0000-0003-2883-9468>), Süleyman Demirel University, Türkiye;
huseyincicek@sdu.edu.tr

Empirical Analysis of the Effects of Environmental Taxes on Environment, Economic Growth and Unemployment in European Union Countries²

Abstract

In the study, which aims to examine the effect of environmental taxes on the environment, economic growth and unemployment, the Augmented Mean Group (AMG) method was applied to 24 EU countries for the 1998-2018 period. It has been determined that the current environmental tax policies do not reduce greenhouse gas emissions or positively affect economic growth and unemployment. The study found evidence of the necessity of restructuring environmental taxes according to environmental criteria and disseminating taxes whose primary purpose is to protect the environment, not financial or economic concerns.

Keywords : Environmental Tax, Economic Growth, Unemployment and Panel Augmented Mean Group (AMG).

JEL Classification Codes : H23, O40, O44, J60.

Öz

Amacı çevre vergilerinin çevre, ekonomik büyüme ve işsizlik üzerindeki etkisini incelemek olan çalışmada 1998-2018 dönemi için 24 AB ülkesi üzerinde Panel Güçlendirilmiş Ortalama Grup Etkisi (Augmented Mean Group: AMG) yöntemi uygulanmıştır. Çalışma sonucunda literatürde ağırlıklı olarak yer bulan iyimser görüşü desteklemez nitelikte mevcut çevre vergisi politikalarının emisyonları azaltmadığı, ekonomik büyüme ve işsizlik üzerinde "çifte yarar" anlamında bir etkisinin olmadığı tespit edilmiştir. Çalışmada, çevre vergilerinden beklenen çevresel etkilere ulaşılabilmesi için çevre vergilerinin daha etkin vergi politikalarıyla çevresel kriterlere göre yeniden yapılandırılması, öncelikli amacı mali ya da ekonomik kaygılar değil çevreyi korumak olan vergilerin yaygınlaştırılmasının gerektiğine yönelik kanıtlar bulunmuştur.

Anahtar Sözcükler : Çevre Vergisi, Ekonomik Büyüme, İşsizlik ve Panel Güçlendirilmiş Ortalama Grup Etkisi.

¹ Bu çalışma Süleyman Demirel Üniversitesi'nde Prof.Dr. Hüseyin Güçlü Çiçek danışmanlığında, 21.06.2022 tarihinde Sema Dirgen-Öz tarafından savunulan "Çevre Vergilerinin Ekonomik Büyüme ve İstihdam Üzerindeki Etkileri: Avrupa Birliđi Ülke Uygulamaları" başlıklı doktora tezinden üretilmiştir.

² This study was produced from the doctoral thesis titled "The Effects of Environmental Taxes on Economic Growth and Employment: European Union Country Practices", defended by Sema Dirgen-Öz on 21.06.2022, under the supervision of Prof. Hüseyin Güçlü Çiçek at Süleyman Demirel University.

1. Giriş

Çevrenin vergilendirilmesi havaya veya suya yayılan kirlilik birimi başına devlet tarafından emisyon ücreti uygulanması anlamına gelmektedir (Jaeger, 2003: 1; EC, 2010: 395; OECD, 2017: 6). Arthur Pigou'nun (1920) refah ekonomisi üzerine temel çalışmasına dayanan mikro ekonomik analizi piyasa fiyatlarının çoğu zaman bireysel seçimlerin tüm sosyal ve çevresel maliyetleri ile faydalarını yanlış temsil ettiğini göstermektedir. Bu analize göre hükümetler, fiyatları düzelteren, dışsal çevresel maliyetleri içselleştiren veya fiyatları çevresel hedeflere ulaşacak seviyelerde belirleyen vergiler veya diğer fiyatlandırma mekanizmalarını getirmelidir (Baumol, 1972: 307).

1970'li yıllarda çevre vergileri terimi “negatif dışsallıklar teorisi” ve “kirleten öder ilkesi” (OECD, 1992), ile anılmış 80'li ve 90'lı yıllarda etkinliği sağlamada en uygun piyasa tabanlı araçlar olarak değerlendirilmiştir. Günümüzde ise çevresel vergiler artık ekonomik büyüme ve istihdam üzerinde olumlu etkilerini savunan “çifte yarar (kazanç) teorisi” (double-dividend theory) (Pearce, 1991) ile anılmakta ve vergi reformlarının bir parçası haline getirilmektedirler. Çevre politikası içerisinde vergi araçlarının kullanımına fırsat penceresi açan süreç, bahsedilen tüm bu gerekçelerle canlandırılmıştır (Soares, 2011: 35).

20. yüzyılın son yirmi yılında, emek üzerindeki yüksek vergiler ekonomik büyümenin düşük olduğu ve ekonomilerin buhran içinde olduğu bir durumda istihdamının önünde bir engel algılanmış, yüksek işsizlik oranlarının sorumlusu olarak görülmüştür. Aynı zamanda çevre sorunlarının da farkına varılmaya başlandığı bu dönemde ortaya atılan emek üzerindeki vergi yükünün çevre vergisiyle dengelenebileceği görüşü günümüzde hala tartışılmaktadır. Bu nedenle de günümüzde çevresel vergiler ekonomi politikası ve çevre politikasını entegre etmenin bir aracı olarak görülmektedir.

Çevre politikasının kapsamlı bir şekilde düzenlendiği Maastricht Anlaşması'ndan 2020 Avrupa Sürdürülebilir Kalkınma Stratejisine kadar geçen dönemde çevreye duyarlı sürdürülebilir ekonomik büyüme ön plana çıkmış özellikle çevrenin korunmasının ekonomi politikalarıyla uyum içerisinde gerçekleşmesi gerekliliğinin altı çizilmiştir. Bu uyum literatürde çifte yarar hipotezi altında emek gibi “iyiler” yerine kirlilik veya doğal kaynakların aşırı kullanımı gibi “kötüleri” vergilendirmenin daha adil olduğu ve ekonomik büyüme ve istihdam açısından daha olumlu sonuçlar doğuracağı üzerinedir. Çevreyle ilgili vergilerden elde edilen gelirin çeşitli ekonomik kazanç biçimleri tartışılmakta ve Avrupa Birliği ülkelerinin bu yönde çevresel mali reform uygulamalarına gittiği görülmektedir. Bu nedenle otuz yılı aşkın süredir siyasi gündemde yer alan çevresel mali reformlar birçok ülkede çevre ve insan sağlığı, ekonomik büyüme ve istihdam ile devlet gelirleri ve gelirlerin mali hedefleri üzerindeki olumlu etkileriyle tanıtılmaktadır. Dolayısıyla literatürde iyimserler veya büyüme yanlısı iktisatçılar olarak da bilinen ekonomistler, çevresel kalite ve ekonomik büyümenin el ele gittiğini savunmaktadır. Ekonomik büyümenin çevre sorunlarının sebebi olmaktan çok çevre sorunlarını çözmek için ihtiyaç duyulan bir hedef anlamına gelen “kazan-kazan (win-win)” senaryolarına inanmışlardır.

Literatürde kötümserler (Meadows et al., 1972; Daly, 1996), olarak da ifade edilen ekonomistler, ekonomik büyüme ile çevresel kalitenin korunması arasında bir değiş tokuş inanmaktadırlar. Çevresel kalitenin korunması ancak sıfır ve hatta negatif ekonomik büyüme oranlarında gerçekleştirilebilecektir. Ekonomik büyüme yoluyla elde edilen daha yüksek bir ekonomik faaliyet seviyesinin, doğal kaynakların daha fazla çıkarılmasına ve daha fazla emisyonla yol açtığı iddia edilmektedir (Ligthart, 1998: 19). Piyasa odaklı sürdürülebilirlik konusundaki iyimserlik zamanla daha da azalmıştır. Mikroekonominin çevre politikasına önemli bir katkı sağlamaya devam ederken, "fiyatları doğru belirlemenin" tek başına çevre ve ekonomik büyüme sorunlarına bir çözüm sağlayamayacağı düşünülmektedir. Çünkü uygulamada, hükümetler tarafından üretim ve tüketimde ihtiyaç duyulan değişiklikleri teşvik edecek seviyelerde ekonomik araçlar uygulamaya konulamamıştır. Sıkı ekonomik politika araçlarının ya da vergilerin ve etkin uygulamanın yokluğu ise hükümetlerin rekabet edilebilirlik, gelir dağılımı problemleri, mali sürdürülebilirlik gibi endişelerinden kaynaklanmaktadır (EEA, 2021: 11).

Avrupa Birliği (AB) ülkelerinde ve literatürde çevre vergileri alanında bu gelişmelerden hareketle çalışmada ekonomik bir araç olarak çevresel vergilerin başta çevre olmak üzere ekonomik büyüme ve istihdam üzerindeki etkisi araştırılmıştır. Çevre vergileri kurgulandığı gibi sera gazı emisyonlarını azaltarak hem çevreyi hem de ekonomik büyüme ve istihdamı olumlu yönde mi etkilemektedir yoksa korkulduğu gibi emisyonların azaltılmasını sağlamaya çalışırken ekonomik büyüme ve istihdamı olumsuz mu etkilemektedir? Sorusuna cevap aranmaktadır.

Çevre vergisinin ekonomik büyüme ve istihdam ile ilişkisinin ampirik incelenmesi ekonomik büyüme ve istihdam ile pozitif ya da negatif bir korelasyonun olup olmadığını göstermesi açısından önemlidir. Bu konudaki ampirik literatür yakın zamana kadar uygun makro verilerin bulunmaması nedeniyle ekonometrik modellemeden ziyade çoğunlukla simülasyon çalışmalarından oluşmuştur. Bu modeller münferit ülkelerdeki vergi reformlarının etkilerini değerlendirmek için yararlıyken, diğer taraftan çok sayıda ülkenin yapısını ve değişimlerini hesaba katan modeli geliştirmek ve deneysel olarak ayırtmak zordur. Literatürde çevre vergilerinin ekonomik büyüme ve istihdam etkisini ekonometrik teknikler ile test eden çalışmalar da mevcuttur. Çevre vergilerinin seçili AB ülkelerinde ekonomik büyüme ve işsizlik üzerindeki etkilerini Panel Güçlendirilmiş Ortalama Grup Etkisi yöntemini kullanarak analiz eden bu çalışmanın literatüre en değerli katkısını kullanmış olduğu yöntem sunmaktadır. Yöntem seriler arasında yatay kesit bağımlılığına ve heterojenlik durumuna izin vermesi ve aynı zamanda hem panel geneli hem de kesit bazında sonuçlar vermesi sebebiyle tercih edilmiştir. Çalışmada ülkelerdeki farklılıkların, ortak faktörlerin ve dinamiklerin dikkate aldığı ekonometrik tekniklerin kullanılması güvenilir, tutarlı ve güçlü tahminler elde edilmesini sağlamakta ve bu yönüyle de literatürdeki çalışmalardan ayrılmaktadır.

Çalışmada son yıllarda giderek şiddetlenen çevre politikası tartışmalarının çevre, çevre vergisi ve ekonomik büyüme ile istihdam açısından teorik arka planı ortaya konulmuştur. Sonrasında teorik incelemeyi takiben ampirik literatürdeki son gelişmelere yer

verilmiştir. Çalışmada AB ülkelerinde 1998-2018 dönemi için çevre vergileri ile emisyonlar, ekonomik büyüme ve istihdam arasındaki bağlantı araştırılmış, analiz edilmiş, ulaşılan sonuçlar ve politika önerileri sunulmuştur.

2. Teorik Arka Plan

Ekonomik çıktı düzeyi diğer adıyla ekonomik büyüme ve çevresel kaynaklar arasındaki ilişki hakkındaki tartışmalar iki yüzyıldan daha eskiye uzanmaktadır. Quesnay, Smith, Ricardo, Malthus ve George da dahil olmak üzere 19. yüzyılın klasik ekonomistleri, ekonomik zenginlikte toprak (doğa) ve tarımsal üretimin rolüne büyük önem vermişlerdir. Malthus yüksek nüfus artışını karşılamak için doğanın sınırlı kapasitesinin altını çizerek dünyanın sınırları hakkındaki bugünkü tartışmaları şekillendirmiştir. John Stuart Mill (1848) bu düşünceyi daha da genişleterek, fiziksel sınırların nihayetinde ekonomik büyümeyi sınırlayacağını ve bunun da bir "durağan devlet ekonomisini" gerektirdiğini savunmuştur. Bugün, "durağan devlet" kavramı "sürdürülebilir büyüme" kostümü içinde geri dönmüştür (Daly, 1996: 9-10).

1970'lerin başında, yeni analitik yaklaşımlar, büyümenin sürdürülebilirliği hakkında daha acil soruları gündeme getirmiştir. Bunlar arasında Nicolas Georgescu-Roegen'in entropi yasasını ekonomik sürece uygulaması ve Roma Kulübü'nün ekonomi ve nüfus artışı ile kaynak kullanımı arasındaki etkileşimi modellemek için bilgisayar simülasyonlarını kullanan "Büyümenin Sınırları" (Meadows et al., 1972) raporu yer almaktadır. Ekonomik büyümenin aynı hızla devam etmesinin 21. yüzyılda nüfusun ve ekonomik sistemin çökmesine yol açacağını savunmuştur (Barbieri et al., 2021: 5).

Büyümenin sınırları, kamusal ve politik söylem üzerinde de güçlü bir etki yapmıştır. Seveso (1976), Three Mile Island (1979), Çernobil (1986) ve Exxon Valdez petrol sızıntısı (1989) ve 1980'lerde Avrupa'da ormanların geri dönüşümü, nehirlerin su kirliliği dâhil olmak üzere insan faaliyetlerinden kaynaklanan bir dizi felaket bunu daha da güçlendirmiştir. Bu yıllar boyunca uluslararası kuruluşlar, çevresel bozulmanın ölçeğini ve ekonomik kalkınma için doğal sermayenin önemini kabul etmeye başlamışlardır (EEA, 2021: 9).

Genel olarak, 1970'lerde ve 1980'lerde çevreciliğe yönelik siyasi itici güç, kaynakların ve ekosistemlerin sınırlı olduğu bir dünyada sonu gelmeyen ekonomik büyümenin sürdürülemeyeceğine dair anlayışı yansıtmaktadır. Bu, tüm ekonomi genelinde üretim ve tüketimin etkilerine odaklanan esasen makroekonomik bir çerçevedir. Bununla birlikte çevre-ekonomi tartışmasının, çağdaş ekonomik düşünceye girişi dışsallıklar ve politikalar üzerine Pigou gibi refah ekonomisindeki bazı erken gelişmelerin ve 1940'larda Anglo-Sakson iktisatçılar tarafından ele alınmaya başlayan piyasa başarısızlıklarının analizi yoluyla gerçekleşmiştir. Bu mikroekonomi çerçevesi, çevre politikalarında kirleten öder ilkesinin ve piyasaya dayalı araçların temeli kabul edilmektedir (Baumol & Oates, 1975: 1; Barbieri et al., 2021: 4).

Çevre politikasına ilişkin erken dönem teorik çalışmalar, mikro ekonomik yönelime sahiptir dolayısıyla çevre politikasının etkileri belirli bir firma, hane halkı veya pazar için kısmi denge analiziyle incelenmiştir. 1980'lerin sonundaki bazı gelişmeler, çevresel konuları makroekonomik bir bakış açısıyla ele almaya yönelik ilginin artmasına neden olmuştur. Bu gelişmelerden birincisi, ozon tabakasının incelenmesi ve ormansızlaşma gibi uluslararası boyutu olan çevre sorunlarının gerçekleşmesidir. İkincisi, ulusal çevre sorunlarının, yüksek gönülsüz işsizlik oranları ve düşük ekonomik büyüme oranları gibi makroekonomik sorunlardan ayrı incelenemeyeceğine dair artan bir anlayışın oluşmasıdır (Ligthart, 1998: 5).

Günümüzde birçok ülke için hem çevre sorunları hem de işsizlik büyük bir sorun olmaya başlamıştır. Bu sorunlar birbirinden oldukça bağımsız görünmekte ancak her ikisi de hem insan yaşamının kalitesini hem de ortak refahı olumsuz etkilemektedir. Günümüzdeki ekonomik büyüme modeli iki önemli kaynak olan emek ve doğanın yetersiz veya optimal olmayan bir kombinasyonuna neden olmaktadır. Dolayısıyla emek kaynaklarının yetersiz kullanımı ve doğal kaynakların aşırı kullanımı yaşam kalitesinin bozulmasına yol açmaktadır (Migliavacca, 2006: 267; Günaydın, 2014: 108). Bu nedenle de her iki sorunu da ele alabilecek ekonomik bir araç bulmanın faydalı olacağı yönünde ortak görüşler ortaya çıkmıştır. Ekonomik araçlar içinde ekonomi üzerindeki doğrudan ve dolaylı etkileriyle öne çıkan maliyet etkin araç ise vergilerdir. Vergilerin aynı anda hem çevresel kaynakların kullanımını azaltmak hem de emeğin kullanımını teşvik etmek için kullanılabileceği tartışılmıştır (Hur, 2000: 1).

Çevre vergisinin ortak kabul edilmiş bir tanımı olmadığı için politika oluşturmaya rehberlik edecek kavramsal bir kıyaslama eksikliği hissedilmektedir (Soares, 2011: 13). İstatistiksel çerçeve, 691/2011 Sayılı Tüzük (AB) uyarınca aşağıdaki çevre vergisi tanımını kullanır: *Vergi matrahı, çevre üzerinde kanıtlanmış, belirli bir olumsuz etkiye sahip ve ESA'da bir vergi olarak tanımlanan bir şeyin fiziksel birimi (veya fiziksel bir birimin vekili) olan bir vergidir.* Vergi matrahı, uluslararası karşılaştırmalar amacıyla çevre vergilerinin belirlenmesi için tek nesnel ölçüt olarak görülmüştür (EC, 2013: 10). AB içerisinde ortak bir çevre vergisi sistemi oluşturulmuş ve çevre vergileri bu sisteme göre dört kategoride sınıflandırılmıştır. Bu vergiler enerji, ulaşım, kirlilik ve doğal kaynak vergileridir. Akaryakıtlar, doğal gaz, kömür ve elektrik üzerinden alınan vergiler enerji vergisi kategorisindedir. Karbon vergileri de bu gruba dâhildir. Ulaşım ve sabit amaçlar için kullanılan enerji ürünleri üzerinden tüm AB ülkelerinde vergi alınmaktadır. Ayrıca AB ülkeleri yakıtların karbon içeriğine bağlı alınan karbon vergilerinde öncü olmuştur. AB ülkelerinde vergiden elde edilecek gelirlerin nereye kullanılacağı açık olarak tanımlanan enerji ve elektrige ek vergiler de uygulanmaktadır. Örneğin Slovenya ve Hollanda'da vergilerden elde edilen gelirler yenilenebilir kaynakların finansmanı için kullanılırken Avusturya, Finlandiya, Almanya ve Letonya'da stratejik petrol rezervlerinin finansmanı için ayrılmıştır (EEA, 2016: 23). 2008 sonrası İrlanda'daki karbon vergisi gelirleri bordro vergilerini korumak ve azaltmak için kullanılmaktadır. Fransa (iklim ikramiyesi), Lüksemburg (İklim ve Enerji Fonu), Portekiz (Orman Fonu) ve birçok AB ülkesinde enerji vergilerinden elde edilen gelirlerin farklı alanlara tahsis edildiği bilinmektedir (Marten &

Dender, 2019: 17). Ancak birçok ülkede rekabet gücü kaybı endişeleri nedeniyle enerji ürünlerine çeşitli muafiyetler sağlandığı da görülmektedir. Örneğin, İsveç'te sanayi, tarım, ormancılık ve balıkçılık sektörlerinde vergi ayrıcalıkları ve muafiyetleri yer almaktadır (Speck, 2008: 51-52). Karbonun fiyatlandırılması karbon emisyonlarının azaltılmasında doğrudan etkili bir araçtır. Ayrıca daha temiz teknolojilere yatırım konusunda teşvik edici etkisinden dolayı önemli bir çevre vergisidir. Emisyon Ticaret Sistemi'nden elde edilen gelirler çevre vergisi gelirlerine dâhil edilmektedir. Ulaşım vergileri ise bir motorlu taşıtın ithalatı ve satışıyla ilişkili bir kereye mahsus vergiler olabileceği gibi yıllık yol vergisi gibi belli dönemlerde alınan mükerrer vergiler şeklinde de olabilmektedir. Motorlu taşıt tescil vergileri, otoyol vergileri, taşıt pulu ve şehir geçiş ücretleri ulaşım vergilerindedir (EC, 2001: 12). Ulaşım vergilerinin tasarımı ülkeler arasında farklılık gösterebilmektedir. Örneğin Hollanda ve Danimarka 2009 yılından itibaren bu vergileri karbon verimliliğine bağlı hale getirmiştir. Motorlu araç vergileri tüketicilerin tercihlerini yakıt açısından verimli araçlara yönlendirmek için giderek daha yaygın kullanılmaktadır. Ancak vergi yapısı ile ilgili çevresel önemlerin vergilerden elde edilen gelirleri zamanla düşüreceği endişesi de tartışmalı bir konudur. Kirlilik vergilerine ise İtalya'da atık vergileri, pil fonu harcı, kimyasal ürünler harcı, plastik poşet vergileri ve İsveç'te araç hurdaya çıkarma ücreti-geri ödeme mekanizması örnek verilebilir. Kirlilik ve doğal kaynak vergilerinin çevre vergisi gelirleri içinde payı düşük olsa da belirli amaçlara tahsis edildiği için kullanıcı ve kirlenici davranışlarını yönlendirmede önemli bir rol oynayabilmektedir (OECD, 2017).

Çevre vergileri çevre politikasının düzenleyici ve teşvik edici araçlarıdır. Çevre vergisi, göreceli fiyatları ve dolayısıyla davranışları değiştirerek hem tüketicileri hem de üreticileri vergilendirilen varlığı daha az kullanma veya üretme konusunda teşvik eder (Soares, 2011: 7). Bu anlamda örneğin enerji vergileri enerji tüketimini (ve dolayısıyla enerji ile ilgili emisyonları) azaltarak ya da düzensiz artışını önleyerek doğrudan olumlu çevresel etkilere sebep olabilmektedir (Gago & Labandeira: 2000: 28-29). Ayrıca sorumluluğun paylaşıldığı ve farkındalığın sağlandığı bu fiyatlandırma sisteminin diğer bir etkisi ise vergilerin her bir kirlilik / emisyon birimi için fiyat belirleyerek firmaları sürekli yeni kirlilik azaltma olanakları aramaya ve daha az kirlenici teknolojilere yatırım yapmaya teşvik etmesidir (Kosonen & Nicodeme, 2009: 3; OECD, 2001: 23). Vergiler tarafından teşvik edilen her türlü yeniliğin aynı zamanda rekabet gücünün artışına da yardımcı olabileceği düşünülmektedir (Andersen, 2005: 79).

Çevre vergilerinin dolaylı etkisinin ise vergi gelirlerinin artışıyla kendini göstermesi beklenmektedir. Çevre vergileriyle kirlilik önlenmeye çalışılırken aynı zamanda geçmişte yapılan kirliliğin temizlenmesi için gerekli kaynakların sağlanabileceği belirtilmektedir. Örneğin, karbon fiyatlandırmasından elde edilen gelirlerle, düşük karbonlu altyapıya yatırım yapılması, iklim finansmanı için uluslararası hedeflere ulaşması, karbon fiyatlarından özellikle güçlü bir şekilde etkilenen hane halkı veya firmaların tazmin etmesi, yeşil inovasyon fonları oluşturulması önerilmektedir. Bu uygulamaların AB ülkelerinde de örnekleri ile karşılaşılmaktadır (OECD, 2017: 13-14). Çevre vergilerinin dışsallık sorununu çözmesinin yanında diğer dolaylı bir etkisi saptırıcı ya da bozucu vergileri azaltmak için kullanılacak vergi geliri üretebileceği ve böylece tüm vergi sisteminin etkinliğini

artıracağı yönündedir (Zhou & Segerson, 2012: 1333). Tüketim vergileri gibi bozucu vergilerin oraya çıkardığı aşırı vergi yükünü yani refah kaybını azaltarak toplumsal fayda artışı sağlanacağı belirtilmiştir (Topal, 2017: 3). Çevre vergilerinden elde edilen gelirlerin diğer vergi kaynakları (emek ve sermaye) üzerindeki vergi yükünü azaltıcı etkiye sahip olacağı böylece dolaylı olarak daha fazla büyüme ve istihdam odaklı hale getireceği beklenmektedir. Ancak çevre vergilerinin bozucu etkisinin bu etkinin ortaya çıkmasına engel olabileceği tartışılmaktadır. Ayrıca çevre vergileri etkilerini ne kadar hissettirirse, gelir artırıcı yanı azalacak, çevresel vergilendirmenin mali sınırlarına da ulaşılmış olacaktır (Şahin, 1999: 125). Bu etkilerin sürdürülebilirliği de tartışılan konular arasındadır. Çevre üzerinde hem doğrudan hem de dolaylı etkisi olan çevre vergilerinin çevresel amaçları gerçekleştirilmesinin uzun vadede gelirleri azaltması muhtemeldir.

AB üye ülkelerinin çoğunda, istihdam üzerindeki ağır vergi yükünün 1990'larda görülen işsizliğin başlıca nedenlerinden biri gösterilmesi ve aynı dönem çevresel sorunlara karşı maliyet etkin olarak görülen çevre vergilerinin aynı zamanda önemli gelir potansiyeli sağlayarak işgücü üzerindeki vergiyi hafifletebileceği düşüncesini doğurmuştur (Şaşmaz, 2016: 31; Pezzey & Park, 1998: 542). Böylece ilk olarak çevre sorunlarına karşı etkili ve maliyet etkin bir araç olarak önem kazanan çevre vergilerinin ikinci olarak işgücü üzerinden alınan vergiler yerine ikamesi tartışılmaya başlanmıştır (Tullock, 1967; Terkla, 1984; Lee & Misiolek, 1986; Repetto et al., 1992). Bu görüş "çifte kazanç", "çifte yarar", "çifte kâr", "çifte temettü" hipotezi şeklinde kavramsallaştırılmıştır (Pearce, 1991). Ayrıca zamanla çifte yarar hipotezi, kirlitici faaliyetler üzerindeki vergilerin artırılmasının daha iyi bir çevre ve iyileşmiş bir ekonomik faaliyet şeklinde çifte fayda sağlayabileceğinden hareketle daha ileriye taşınmıştır. 1990'ların başlarında, çoğu çevre ekonomisti Tullock'u (1967) takiben, dışsallıkların Pigovian vergilerle içselleştirilmesinin bir çifte yarar sağlayabileceğine inanmıştır. Bununla birlikte, bu argüman 90'ların ortasında Bovenberg, Goulder ve Parry gibi genel denge analizini kullanan ekonomistler tarafından kirlilik vergilerinin genellikle aşırı derecede bozucu olduğu savunularak eleştirilmiştir. Bu bozukluk veya çarpıklık nedeniyle, optimal vergi oranının genellikle marjinal sosyal zarardan -Pigovian optimum seviyesinden- daha düşük belirlendiği ileri sürülmüştür (Goodstein, 2003: 403; Jaeger, 2003: 4).

Birçok ülke son zamanlarda yürüttüğü çevre vergisi reformları ile elde edilen gelirlerden daha iyi bir çevre ve daha yüksek bir GSYH veya istihdam gibi çevresel olmayan ekonomik yararlar beklemektedir. Bunun için sürekli toplam vergi yükü ile işgücü üzerindeki vergilerin azaltılması ve çevre üzerindeki vergilerin artırılması savunulmaktadır. Bu nedenle özellikle son yıllarda gelişmiş ülkeler de dahil olmak üzere birçok ülke önemli adımlar atmaya başlamıştır. Devletler, gelir artırmanın bir yolu olarak çevre vergilerine giderek daha fazla yönelmektedir.

Çevre politikasıyla ilgili 1989 yılında yayınlanan Pearce Dergisi (Raporu) bir dönüm noktası olmuştur. Birleşik Krallık Çevre Bakanlığı için hazırlanan bu raporda (Pearce et al., 1989) çevredeki birçok kirlilik türünden tehdit altında olan unsurların nasıl maliyetlendirilebileceğini göstermektedir. Yapılan analizin sonucu olarak, hükümetlerin,

hem kirliliği çok maliyetli hale getirerek azaltacak vergilendirme sistemleri inşa edebileceklerini, hem de çevreye hasarın çoğunu temizlemek için gelir sağlanacağını vurgulamıştır (Barbieri et al., 2021: 5).

AB bağlamında, ekonomik araçlara olan ilgi 1989'da çevre ve iç pazarla ilgili Komisyon Görev Gücü Raporunda yansıtılmış Avrupa Parlamentosu'nun Haziran 1990'daki ekonomik araçlarla ilgili duruşmasında da güçlendirilmiştir. Ayrıca Çevre Konseyi'nin Eylül 1990'da Roma'da bir Avrupa karbon-enerji vergisi için bir öneri geliştirme kararı da etkili olmuştur (Ekins, 1999: 40). Hem Avrupa Konseyi'nin 1990 tarihli Dublin beyanı, hem de 1992'de Beşinci ve Altıncı Çevre Eylem Programı politika araçlarının kullanımında bu tür yeni yaklaşımların benimsenmesi ihtiyacına daha resmi işaret ederken, Büyüme, Rekabet Edebilirlik ve İstihdam üzerine hazırlanan Beyaz Kitap, böyle bir çevre politikasının daha geniş olumlu makro-ekonomik sonuçlarına işaret etmiştir (Hey, 2005: 21). Hem çevresel hem de ekonomik hedeflerin fayda sağlayabileceği kazan-kazan durumları belirlenmiştir. Büyüme, Rekabet Edebilirlik ve İstihdam Üzerine Beyaz Kitap (CEC, 1993: 8), işgücü ve enerjinin göreceli fiyatlarında bir değişiklik yaparak istihdam yaratmaya ve kaynak kullanımının verimliliğini artırmaya çalışan yeni bir kalkınma modeli önermiştir. Sürdürülebilir kalkınma, çevrenin durumunu, sosyal verimliliği ve rekabet gücünü aynı anda iyileştirmenin bir aracı olarak algılanmaya başlanmıştır.

"Fiyatlar, ürünlerin ve hizmetlerin gerçek ekonomik, sosyal ve çevresel maliyetlerini yansıtmalıdır". Bu, 2001 yılında Göteborg'da benimsenen ve ekonomik (piyasa temelli) araçların kullanımını savunan AB sürdürülebilir kalkınma stratejisinin temel taşlarından biridir (CEC, 1993: 7). Çevre için ekonomik araçların daha yoğun kullanımı, AB'nin altıncı çevre eylem programında ve yenilenen AB sürdürülebilir kalkınma stratejisinin yanı sıra büyüme ve istihdam için yenilenen Lizbon stratejisinde teşvik edilmiştir. 2020'ye kadar on yıl için Lizbon stratejisinin yerini alan Yeni Avrupa 2020 girişimi, kaynak verimliliğinin artırılarak çevreye duyarlı, sürdürülebilir ve yenilikçi büyümenin yakalanmasında ekonomik araçların önemini vurgulamaya devam etmiştir (Eurostat, 2010: 320).

Çevre sorunlarıyla yüzleşmek için, mevcut üretim ve tüketim modellerinde kapsamlı değişikliklere ihtiyaç vardır. Bu değişiklikler önemli ekonomik maliyetler içermekle birlikte işgücü ve sermaye piyasalarını önemli ölçüde etkileyebilir. Minimum maliyet ve etkiyle tüm sektörlerde davranış değişiklikleri üretebilen araçlar arayışı, AB'yi çevre için ekonomik ya da piyasa temelli araçlara yöneltmiştir. Birçok ülkede, çevre vergisi gelirleri, vergi sistemini daha az bozucu ve daha fazla büyüme ve istihdam dostu hale getirmek için vergi reformuyla desteklenen çevresel vergi reformlarında kullanılmaktadır (OECD, 2017: 14). Çevresel mali reform ya da çevre vergisi reformu: "eş zamanlı olarak çevresel hedefleri yürütürken geliri artırabilecek bir dizi vergilendirme veya fiyatlandırma aracı" olarak tanımlanmaktadır. Bir bakıma çevresel mali reform çevreyle ilgili vergilerin uygulanması ve yaygınlaştırılmasıdır (WB, 2005: 1). Çevresel reformlar diğer vergilendirme biçimlerinde açık indirimler olmadığı durumlarda bile, çevresel vergi gelirlerini artırıp mali konsolidasyon sağlayarak dolaylı yoldan diğer vergilerin seviyesini, aksi halde geçerli olabilecek seviyenin altında tutabilir (OECD, 2017: 6). Bu nedenlerle yirmi yılı aşkın süredir siyasi gündemde yer alan

çevresel mali reformlar birçok ülkede çevre ve insan sağlığı, ekonomik büyüme ve istihdam ile vergi gelirleri ve gelirlerin mali hedefleri üzerindeki olumlu etkileriyle tanıtılmaktadır (Schlegelmilch & Joas, 2015: 2).

3. Literatür

Çevre vergilerinin ekonomik büyüme ve istihdam üzerindeki etkileri temelde "çifte yarar" kapsamında tartışılmakta ve analiz edilmektedir. Temel fikir, farklı vergilerden kirlenmiş ürünlere uygulanan vergilere geçişin hem çevrede iyileşme hem de ekonomik fayda sağlayabileceği yönündedir. Çevre vergilerinden elde edilen gelirler sayesinde işgücü üzerindeki verginin hafifletilebileceği dolayısıyla vergi yükümlülükleri üzerinde refah kaybına yol açan aşırı yükü azaltılabileceği bu durumda dolaylı yoldan istihdam ve ekonomik büyüme için olumlu sonuçlar doğurabileceği varsayılmaktadır. Bu varsayımlar birçok simülasyon senaryoları çalışmalarıyla analiz edilmiştir. Çalışmaların çoğu ekonomik büyüme ve istihdam üzerinde olumlu etkinin nasıl ortaya çıkabileceğini test etmiştir. Ayrıca çevre vergisinin çifte yarar sağlayıp sağlamadığına dair daha güçlü kanıtlar elde etmek için mevcut çalışmalar üzerine literatür entegrasyonu çalışmaları da yürütülmüştür. Literatürde çevre vergilerinin ekonomik büyüme ve istihdam etkisini ekonometrik teknikler ile test eden çalışmalar da bulunmaktadır. Çevre vergilerinin ekonomik büyüme ve istihdam üzerindeki etkisini araştıran ampirik çalışmaların bazıları çevre vergilerinin ekonomik büyüme, GSYİH ve refah üzerindeki etkilerini ölçerken bazıları istihdam etkilerini ölçmektedir. Hem ekonomik büyüme hem de istihdam etkilerini ölçen çalışmalar da mevcuttur.

Gökmen (2012), 29 Avrupa ülkesinin 1996-2010 yılları için Panel Vektör Otoregresif model kullanılarak yapılan çalışmada çevre vergilemesinin ekonomik büyüme üzerindeki uzun vadeli etkisini araştırmış, çevresel vergilendirmenin ekonomik büyümeyi artırmasının teorik ve ampirik olarak mümkün olduğunu göstermiştir. Şaşmaz (2016), 1995-2012 verilerini kullandığı panel eşbütünleşme analizinde 15 AB üyesi ülkesi için çevresel vergilendirmenin istihdam üzerinde etkisini ölçmüş, çevre vergilerinin hem karbondioksit salınımını hem de işsizlik oranını azalttığı için çifte yarar hipotezinin 15 AB üyesi ülke için geçerli olduğu sonucuna ulaşılmıştır. Topal (2017), 1994-2013 yılı verilerinden yararlanarak çevresel vergilerin çevre kirliliğini azaltma amacı yanında istihdamı artırıcı ikinci bir faydasının olup olmadığını OECD ekonomileri için panel eşbütünleşme ve nedensellik analizleri ile test etmiş, çevre vergilerinin hem çevre kirliliğini hem de işsizliği azaltma anlamında çifte yarar hipotezinin 14 OECD ekonomisi için geçerliliğini tespit etmiştir. Yamazaki (2017), Britanya Kolombiya'sında 2008 yılında gelirden bağımsız olacak şekilde tasarlanan, yani tüm vergi gelirlerinin kişisel ve kurumsal gelir vergilerinin azaltılmasını sağlayan veya düşük gelirli hane halklarına götürü transferler şeklinde uygulanmaya başlanan karbon vergisinin istihdam etkilerini incelemiş, karbon vergisinin ortalama olarak, 2007-2013 döneminde istihdamda yıllık ortalama %0,74 oranında küçük ama istatistiksel olarak anlamlı bir artış sağladığını tespit etmiştir. Toplam etkiler küçük olmakla birlikte, karbonun yoğun olduğu sektörlerden karbonun yoğun olmadığı sektörlerle önemli bir iş kaymasına ulaşılmıştır. He vd. (2019), 1994'ten 2014'e kadar OECD'nin 36 ülkesinde uygulanan çevresel verginin çifte yarar sağlayıp sağlamadığını araştırmış, çevre vergisinin

ekonomik büyüme üzerinde olumlu etkide bulunurken, istihdamın artırılmasında etkisinin olumsuz olduğunu tespit etmiştir. Metcalf (2019), 1990-2016 döneminde Kanada eyaleti Britanya Kolombiya'sı üzerine Farkların Farkı (Difference-in-Difference) analizine dayanarak yürüttüğü çalışmada karbon vergisinin olumsuz bir GSYİH etkisine rastlamamıştır. Avrupa ülkelerinin panel verileri kullandığı durumda ise 1985-2017 zaman dilimi arasında GSYH üzerinde mütevazı bir olumlu etki bulmuştur. Metcalf ve Stock (2020), 1985-2017 tarihleri arasında 31 Avrupa ülkesinin panel verilerine uyarlanan yerel projeksiyon (LP) yöntemini kullanarak bir karbon vergisinin GSYİH ve istihdam artış hızı üzerinde olumlu etkileri olduğunu tespit etmiş, olumlu etkiler bazı durumlarda istatistiksel olarak anlamlı olsa da genellikle tutarlı bulunmamıştır. Avrupa deneyimi için, karbon vergilerinin istihdam veya GSYİH büyümesi üzerinde olumsuz bir etkisi olduğuna dair güçlü bir kanıt bulunamamıştır.

Morley (2010), 1995'ten 2005'e kadar çoğu AB ülkesini ve Norveç'i kapsayan ve yakın zamanda AB'ye katılan geçiş ülkeleri de dahil olmak üzere çevre vergileri ve ekonomik büyüme arasındaki ilişkiyi incelediği panel veri analizinde, Avrupa'da çevre vergilerinin ekonomik büyüme üzerinde olumlu etkisini gösteren çifte yarar hipotezinin geçerli olmadığı sonucuna ulaşmış, aynı zamanda yenilenebilir enerjinin büyüme üzerinde olumsuz bir etkisi olduğuna dair kanıtlar da bulmuştur. Arbolino ve Romano (2014), 26 Avrupa ülkesinde uygulama öncesi ve sonrası çevre vergilerinin etkilerini karşılaştırmalı olarak inceleyerek çevre vergilerinin çevre üzerinde olumlu bir etkiye sahip olduğunu, ancak işsizlik oranının iyileştirilmesi üzerindeki etkinin açık olmadığını ve olumsuz bir etki gösterdiğini bulmuştur. Nerudová ve Dobranschi (2014), 15 AB üyesi ülke için 1995-2011 dönemi verilerini kullandığı panel Granger nedensellik analizi sonucunda karbon vergilendirmesinin aşırı yükünü telafi etmek için dengeleme önlemleri olarak gelir vergisi kesintilerinin ikincil bir yarar sağlamayacağı aksine çevrenin korunması üzerinde olumsuz bir etkisi olduğu sonucuna ulaşmıştır. Morley ve Abdullah (2014), 1995-2006 yılları arasında OECD ülkelerinin panel verilerini kullandıkları çalışmalarında çeşitli çevresel vergi birleşiminin ekonomik büyüme üzerinde istatistiksel olarak anlamlı bir nedensel etkisi gözlemlenmemiştir. Ayrıca, çevre vergisindeki artış, çeşitli ülkelerdeki emisyonları azaltma hedefini etkilememiştir. Radulescu vd. (2017), Vektör Hata Düzeltme Modeli (VECM) teknikleri ve En küçük kareler yöntemiyle yaptıkları çalışmada 1996-2015 yılları arasında Romanya ve 28 AB ülkesinde çevresel vergilendirmenin işsizlik ve ekonomik büyüme üzerinde etkisini araştırmaktadır. Çifte yarar hipotezi ne Romanya'da ekonomik büyüme alanında ne de bir bütün olarak AB bölgesinde işsizlikte doğrulanamamıştır. Bernard vd. (2018), Kanada'nın Britanya Kolombiya'sı eyaletinde 2008'de uygulanmaya başlanan benzin ve dizel karbon vergilerinin GSYİH üzerinde olumlu ya da olumsuz bir etkisinin olup olmadığını test etmiştir. Karbon vergilerinin GSYİH değişimi üzerinde istatistiksel olarak anlamlı bir etkisi olmadığı sonucuna varmıştır. Hassan vd. (2018), 1994'ten 2013'e kadar 31 OECD ülkenin panel veri kümesine dayanarak ve eksiklik modelini ele almak için çoklu impütasyon algoritması kullanarak enerji vergilerinin ekonomik büyüme üzerindeki etkisini analiz etmiştir. Ampirik sonuçlar, enerji vergilerinin kısa vadede ekonomik büyüme oranı üzerinde olumsuz bir etkiye sahip olduğunu göstermektedir.

4. Ampirik Analiz

4.1. Veri Seti

Çalışmanın bu bölümünde 24 AB ülkesinde³ 1998-2018 dönemi için çevre vergileri ile emisyonlar, ekonomik büyüme ve istihdam arasındaki ilişki araştırılmıştır. Analizin yapıldığı dönem ve ilgili ülkeler verilerin ulaşılabilirliğine göre belirlenmiştir.

AB ülkelerinin tercih edilmesinin sebebi 1990'lardan sonra AB ülkelerinde çevre vergilerine çevresel amaç yanında ekonomik büyüme ve istihdam amacının da yüklenerek bu yönde geliştirilen politikalarından beklenen pozitif etkilerin ortaya çıkıp çıkmadığının tahmin edilmek istenmesidir.

Tablo: 1
Değişkenleri Açıklayıcı Bilgiler

Değişkenler	Açıklama	Kaynak
Ekonomik Büyüme (GROWTH)	Sabit ABD doları kuruna dayalı kişi başına GSYH'nin yıllık yüzde büyüme oranı *	Dünya Bankası
İşsizlik Oranı (UNEMP)	15-24 yaş arası cari ücret düzeyinde çalışmak isteyip de iş bulamayanların işgücüne oranı	Dünya Bankası
Sera Gazı Emisyonları (GHG)	Ülkelerin kişi başı sera gazı emisyon düzeyi **	Eurostat
Çevresel Vergi Yüklü (ENVFAT)	Çevre vergileri gelirleri toplamının GSYH içindeki payı ***	Eurostat
Enerji Tüketimi (ENECONS)	Bir ülkedeki nihai enerji tüketimini ölçen kişi başı fosil enerji tüketimi (ton eşdeğeri)	EIA ****
Sermaye Oluşumu (CAPFOR)	Ekonominin sabit varlıklarına yapılan harcamalar ve stok seviyesindeki net değişikliklerden oluşan gayri safi sermaye oluşumu	Dünya Bankası

Not: Tarafımızca hazırlanmıştır.

* Topamlar, sabit 2010 ABD dolarını temel almaktadır. Kişi başına GSYH, gayri safi yurtiçi hasılamın yıl ortası nüfusa oranıdır. Alıcı fiyatları üzerinden GSYH, ekonomideki tüm yerleşik üreticiler tarafından eklenen brüt değer artı tüm ürün vergileri ve ürünlerin değerine dahil edilmeyen tüm sübvansiyonların toplamıdır. Üretilen varlıkların amortismanı veya doğal kaynakların tükenmesi ve bozulması için kesinti yapılmadan hesaplanır.

** Gösterge, uluslararası havacılık da dahil "Kyoto sepeti" olarak adlandırılan sera gazlarından karbon dioksit (CO₂), metan (CH₄), nitroz oksit (N₂O) benceri emisyon envanterlerinin tüm sektörlerinden (arazi kullanımı, arazi kullanımı değişikliği ve ormancılık (LULUCF) hariç uluslararası havacılık dahil) F-gazları (hidroflorokarbonlar, perflorokarbonlar, nitrojen triflorür (NF₃) ve kükürt heksaflorür (SF₆) toplam ulusal emisyonları (hem ESD hem de ETS sektörlerinden) ölçer. Her bir gazın bireysel küresel ısınma potansiyeli (GWP) kullanılarak, CO₂ eşdeğeri birimlerinde ifade edilen tek bir göstergeye entegre edilir. Sera gazı emisyon envanterleri, AB Üye Devletleri tarafından Birleşmiş Milletler İklim Değişikliği Çerçeve Sözleşmesi'ne (UNFCCC) yıllık olarak sunulur.

*** Çevre vergisi, vergi tabanı, çevre üzerinde kanıtlanmış, belirli olumsuz etkisi olan ve ESA 2010'da vergi olarak tanımlanan bir şeyin fiziksel birimi (veya fiziksel birimin vekili) olan bir vergidir. Çevre vergisi istatistikleri, referans olarak ulusal hesapların vergi tanımına dayanır, çünkü bu istatistiklerin uluslararası karşılaştırılabilirliğini artırır ve vergi verilerinin ulusal hesaplarla ve çevresel ve ekonomik muhasebe sistemleriyle entegrasyonuna izin verir. Çevre vergilerinin tam olarak tanımlanması ve uluslararası karşılaştırılabilirliğin sağlanması için vergi matrahları listesi oluşturulmuştur. Ulusal hesaplarda bu şekilde tanımlanan ve oluşturulan vergi matrahlarına dayanan tüm vergiler, çevre vergisi tanımına uygun kabul edilir. Analitik amaçlar için, çevre vergileri dört kategoriye ayrılmıştır: enerji vergileri (CO₂ vergileri dahil), nakliye vergileri, kirlilik ve kaynak vergileri. CO₂ vergileri, tüm AB Üye Devletleri tarafından kaydedilen AB Emisyon Ticareti Sistemi (EU ETS) kapsamında emisyon izinlerinin açık artırmalarından elde edilen hükümet gelirlerini de kapsamaktadır.

**** Enerji Bilgi Yönetim İdaresi (EIA-U.S. Energy Information Administration) tarafından sunulan birincil fosil yakıt tüketimi (kömür, petrol ve doğalgaz) ve Dünya Bankası tarafından sunulan nüfus verilerinden yararlanılarak tarafımızca hesaplanmıştır Enerji Bilgi Yönetim İdaresi tarafından quad BTU cinsinden verilen fosil yakıt tüketimi kg eşdeğer petrole dönüştürülüp nüfusa oranlanarak kişi başı fosil yakıt tüketimine ulaşılmıştır. (Quad, 10¹⁵ BTU veya SI birimlerinde 1.055 × 10¹⁸ joule'e eşit bir enerji birimidir. Birim, ABD Enerji Bakanlığı tarafından dünya ve ulusal enerji bütçelerinin tartışılmasında kullanılmaktadır).

Çalışmada çevre kirliliğini temsilen ülkelerin kişi başı sera gazı emisyon düzeyi (ghg), 2010 yılı dolar cinsinden kişi başına düşen GSYİH (growth), çevre vergileri gelirleri

³ Avusturya, Belçika, Kıbrıs, Çekya, Danimarka, Estonya, Finlandiya, Almanya, Yunanistan, Macaristan, İrlanda, İtalya, Letonya, Litvanya, Lüksemburg, Malta, Hollanda, Polonya, Portekiz, Romanya, Slovakya, Slovenya, İspanya, İsveç.

toplamının GSYH içindeki payı (envtax), 15-24 yaş arası cari ücret düzeyinde çalışmak isteyen ve iş bulamayanların işgücüne oranı olarak ifade edilen işsizlik oranı (unemp), bir ülkedeki nihai enerji tüketimini ölçen fosil enerji tüketimi (enecons) değişkenleri kullanılmıştır. Ayrıca, sermaye ve yatırım ölçütlerinin nüfus gibi diğer modellerde de önemli belirleyiciler olduğu kanıtlandığından, sermaye ve emek arzı arasındaki oranı temsil etmek için kişi başına sermaye oluşumu (capfor) (Morley, 2012: 1818) da modele dahil edilmiştir. Nihai belirleyici, bu çalışmaya dahil edilen her ülkede uygulanan çevre vergisi yüküdür.

Söz konusu veriler Avrupa Birliği İstatistik Ofisinin (Eurostat) veri tabanından ve Dünya Bankası Kalkınma Göstergelerinden (World Bank-World Development Indicators) elde edilmiştir. Tablo 1 değişkenleri açıklayıcı bilgiler sunmaktadır.

4.2. Model

Ekonomik araştırmalar yapılırken yatay kesit serileri, zaman serileri ve panel verileri olmak üzere üç farklı veri setinden faydalanılabilir. Ekonomide zaman serilerini ve kesitleri birleştiren veri kümeleri yaygındır. Örneğin, AB ve OECD'nin yayınlanan istatistikleri, birçok ülke için yıllık olarak gözlemlenen çok sayıda ekonomik toplam serisini içermektedir. Bu veri setleri ekonomi hakkında zengin bilgi kaynakları sağlar. Panel verilerin analizi, panel verilerin tahmin tekniklerinin ve teorik sonuçlarının geliştirilmesi için zengin bir ortam sağlaması nedeniyle ekonometrideki en aktif ve yenilikçi araştırma organlarından görülmektedir. Son zamanlarda yapılan birçok çalışma, yalnızca kesit veya zaman serisi ayarlarında çalışılmayan sorunları incelemek için panel veri setlerini kullanmıştır (Greene, 2003: 283-284). İşte belli bir dönem ait yatay kesit serilerin bir araya getirilerek ekonomik ilişkilerin tahmin edilmesi yöntemine panel veri analizi denilmektedir. Panel veri analizi zaman boyutuna sahip kesit verileri olarak da tanımlanabilir. Bu çalışmada değişkenler arasındaki ilişkinin araştırılmasında panel veri tekniklerinden faydalanılmıştır.

Panel veri teknikleri ile yapılan analizler sadece zaman serileri ya da kesit serileri ile yapılabilecek bir analize göre daha fazla gözlem sayısı ile çalışılmasını sağlamaktadır. Daha fazla bilgilendirici veri, serbestlik derecesi ve verimlilik sağlaması böylece daha güvenilir parametre tahminleri üretilebilmesi (Hsiao, 2003: 2-3), bireyin zamanın bir noktasındaki deneyimlerini ve davranışını, zamanın başka bir noktasındaki diğer deneyimler ve davranışlarla ilişkilendirebilmesi, yatay kesit ve zaman serisi verilerinde kolayca saptanamayan etkileri daha iyi tanımlayabilmesi ve ölçülebilmesi, yatay kesit veya zaman serisi verilerinden daha karmaşık davranışsal modellerin test edilmesine olanak tanınması gibi birçok avantajı bulunmaktadır (Baltagi, 2001: 4-6; Doğan & Şeker, 2016: 14649; İlgün, 2014: 76).

Panel veri kullanımının avantajları yanında dezavantajları da vardır. Panel modelleri heterojenlik ve kesit bağımlılığı sorunlarından zarar görebilirken, genellikle makroekonomik değişkenlerin karmaşık davranışını yakalama yeteneğine sahiptir ve tek ülke zaman serisi verilerine göre daha fazla serbestlik derecesi ve daha fazla örnek varyasyonu içerir. Diğer taraftan son zamanlarda geliştirilen ekonometrik yaklaşımlar hem

yatay kesit bağımlılığı hem de heterojenlik konularını dikkate almakta ve dolayısıyla bahsedilen dezavantajları ortadan kaldırmaktadır (Doğan & Şeker, 2016: 14653). Dolayısıyla öncelikle bu çalışmada kullanılan panel verilerin bahsedilen sorunlardan etkilenip etkilenmediğini araştırılmış buna göre uygun panel modelleri kullanılmıştır.

Bu kapsamda üç ayrı panel regresyon modeli oluşturulmuştur. Birinci modelde bağımlı değişken çevre kirliliğini temsilen ülkelerin kişi başı sera gazı emisyon düzeyi (ghg); bağımsız değişkenler ise çevre vergileri gelirleri toplamının GSYH içindeki payı (envtax), 2010 yılı dolar cinsinden kişi başına düşen GSYİH (growth), bir ülkedeki nihai enerji tüketimini ölçen fosil enerji tüketimi (enecons) değişkenleri kullanılmış, çevre vergilerinin sera gazı emisyonları üzerindeki etkisi araştırılmaktadır. İkinci modelde bağımlı değişken 2010 yılı dolar cinsinden kişi başına düşen GSYİH (growth), bağımsız değişkenler ise çevre vergileri gelirleri toplamının GSYH içindeki payı (envtax), bir ülkedeki nihai enerji tüketimini ölçen fosil enerji tüketimi (enecons) çevre vergilerinin ekonomik büyüme üzerindeki etkisi incelenmektedir. Üçüncüde 15-24 yaş arası cari ücret düzeyinde çalışmak isteyen ve iş bulamayanların işgücüne oranı olarak ifade edilen işsizlik oranı (unemp) bağımlı değişken; çevre vergileri gelirleri toplamının GSYH içindeki payı (envtax), 2010 yılı dolar cinsinden kişi başına düşen GSYİH (growth) ve sermaye ve emek arzı arasındaki oranı temsilen kişi başına sermaye oluşumu (capfor) bağımsız değişkenlerdir. Çevre vergilerinin işsizlik üzerindeki etkisi araştırılmaktadır.

$$GHG_{it} = f(\text{envtax}_{it}, \text{growth}_{it}, \text{enecons}_{it}) \quad (1)$$

Denklem (1) aşağıdaki gibi modellenmiştir:

$$\text{Model 1: } GHG_{it} = \beta_0 + \beta_1 \text{envtax}_{it} + \beta_2 \text{growth}_{it} + \beta_3 \text{enecons}_{it} + \varepsilon_{it} \quad (2)$$

$$\text{GROWTH}_{it} = f(\text{envtax}_{it}, \text{enecons}_{it}) \quad (3)$$

Denklem (2) aşağıdaki gibi modellenmiştir:

$$\text{Model 2: } \text{GROWTH}_{it} = \beta_0 + \beta_1 \text{envtax}_{it} + \beta_2 \text{enecons}_{it} + \varepsilon_{it} \quad (4)$$

$$\text{UNEMP}_{it} = f(\text{envtax}_{it}, \text{growth}_{it}, \text{capfor}_{it}) \quad (5)$$

Denklem (3) aşağıdaki gibi modellenmiştir:

$$\text{Model 3: } \text{UNEMP}_{it} = \beta_0 + \beta_1 \text{envtax}_{it} + \beta_2 \text{growth}_{it} + \beta_3 \text{capfor}_{it} + \varepsilon_{it} \quad (6)$$

Burada β_1 odaklanmış değişkenin katsayısıdır; yani, çevre vergisi/GSYH; β_2 ve β_3 diğer kontrol değişkenlerinin katsayılarıdır. Denklemde i ($i = 1, \dots, N$) ülkeleri, t terimi de

⁴ Ekonomik büyümeyi açıklayan birçok değişken olmakla birlikte analizde ceteris paribus varsayımı altında diğer değişkenler sabitken çevre vergisi yükü ve fosil enerji tüketiminin ekonomik büyüme üzerindeki etkisi üzerinde durulmaktadır.

zaman periyodunu ($t = 1, \dots, T$) temsil etmektedir. Bununla birlikte ε_{it} ise hata terimini göstermektedir.

Analizde öncelikle serilerin durağanlığının panel birim kök testleriyle tahmin edilmesi gerekmektedir. Ancak değişkenlerin durağan özelliklerini tespit etmeden önce, uygun panel birim kök testlerini kullanmak için panel verinin özellikleri daha fazla detaylandırılmalıdır. Bir panel zaman serisi verilerinin homojen ve kesitsel olarak bağımsız olmaması durumunda geleneksel panel birim kök testleri tutarsız ve güvenilmez sonuçlar verir (Doğan & Aslan, 2017: 241). Heterojenliği ve yatay kesit bağımlılığını hesaba katmayan panel tahmin yöntemleri, panel zaman serisi verilerinin homojen ve yatay kesitten bağımsız olmaması durumunda hatalı sonuçlar verebilir (İnglesi-Lotz & Dogan, 2018: 38). Bu bağlamda çalışmaya değişkenlerin homojen olup olmadıkları ve yatay kesitler arasındaki bağımlılık test edilerek başlanmıştır.

"Yatay kesit bağımlılığı yoktur" varsayımı ülkelerin birinde ortaya çıkan şokun diğer ülkeleri etkilememesini ifade etmektedir. Yatay kesit bağımlılığı (cross-section dependence) reddedilirse serilerin durağanlığının test edilmesinde birinci nesil birim kök testleri, yatay kesit bağımlılığının varlığında İkinci nesil birim kök testlerini kullanmanın daha tutarlı, güvenilir ve güçlü tahminler yapılmasını sağlayabileceği tahmin edilmektedir (Yalçınkaya & Hüseyini, 2019: 350; Çınar vd., 2012: 18).

Bu nedenle her bir panel verinin kesitsel olarak bağımsız olup olmadığını görmek için Pesaran (2004) ve Pesaran, Ullah ve Yamagata (2007) tarafından geliştirilen yatay kesit bağımlılığı CD ve CD_{Adj} testleri analiz edilen değişkenlere uygulanmıştır.

Homojenlik varsayımı paneldeki tüm birimler için β_1 katsayılarının aynı olduğunu ifade etmektedir (İlgün, 2014: 76). Ülkelerin farklı ekonomik yapıya sahip olmalarından dolayı homojenlik varsayımı sapmalı sonuçlara ve yanlış çıkarımlara yol açabilir ve bu durum yanlış politik önermelere sebep olabilir (Özcan & Arı, 2014: 48). Bu nedenle ikinci olarak Pesaran ve Yamagata (2007) yöntemini kullanılarak homojenlik testi yapılmıştır.

Homojenlik ve yatay kesit bağımsızlığı varsayımlarının geçerliliğinin test edilmesi uygulanacak olan birim kök ve eşbütünleşme testlerini belirlemektedir. Ulaşılan sonuçlar doğrultusunda yatay kesit bağımlılığını ve heterojenliği hesaba katan ikinci nesil Im, Pesaran ve Shin (CIPS) (2003) panel birim kök testlerini uygulanmıştır. Değişkenler arasındaki uzun dönemli eşbütünleşme ilişkisinin tahmininde ise Westerlund ve Edgerton (2007) tarafından geliştirilen Bootstrap Panel Eşbütünleşme testi kullanılmıştır. Son olarak da değişkenler arasındaki uzun dönemli ilişki AMG tahmincisi ile ortaya konulmaktadır. Modellerin tahmininde Eviews 10, Gauss 10 ve Stata 14 paket programlarından yararlanılmıştır.

4.3. Metodoloji

4.3.1. Yatay Kesit Bağımlılığı Testi

Ulusların artan ekonomik entegrasyonu ve iş birliği nedeniyle panel veri modellerinde yatay kesit birimleri arasındaki ilişki önemlidir. Kesit veriler arasındaki ilişkiler dikkate alınmazsa yanıltıcı sonuçlara neden olur. Çalışmada AB ülkeleri incelendiği için önce yatay kesit bağımlılık testleri yapılmıştır. Yatay kesit bağımlılığının test edilmesinde Pesaran (2004) ve Pesaran vd. (2008) tarafından sunulan testler kullanılmıştır. Bu test, Breusch ve Pagan (1980)'ın geliştirdiği testin düzeltilmiş halidir (Aydın, 2019: 623).

Breusch ve Pagan yatay kesit bağımlılığını test etmek için aşağıdaki panel veri modelini kullanmıştır (Pesaran et al., 2007: 107):

$$CD_{BP} = T \sum_{i=1}^{N-1} \sum_{j=i+1}^N \hat{\rho}_{ij}^2 \quad (7)$$

Breusch ve Pagan testi, N'nin büyük olduğu durumlarda bir dezavantaja sahiptir ve $N \rightarrow \infty$ olduğunda uygulanamaz. Pesaran (2004) bu sorunun üstesinden gelmek için LM istatistiğini geliştirmiştir. Pesaran'a göre kesit boyutu (N) zaman boyutundan (T) ($N > T$) büyük ise aşağıdaki test istatistiği kullanılmalıdır (Pesaran, 2004: 9; Aydın, 2019: 623; İlgün, 2015: 76; Topallı, 2016: 435):

$$CD = \sqrt{\frac{2T}{N(N-1)}} \left(\sum_{i=1}^{N-1} \sum_{j=i+1}^N \hat{\rho}_{ij} \right) \quad (8)$$

$\hat{\rho}_{ij}$ hatalar arasındaki ilişkiyi gösterir. Yatay kesit bağımlılığı için kullanılan sıfır ve alternatif hipotezler testler aşağıdaki gibidir:

$$H_0 : \text{cov}(u_{it}, u_{ij}) = 0 \text{ kesit bağımlılığı yoktur} \quad (9)$$

$$H_1 : \text{cov}(u_{it}, u_{ij}) \neq 0 \text{ kesit bağımlılığı} \quad (10)$$

Pesaran, Ullah ve Yagamata (2007) ise Breusch ve Pagan (1980) CD_{BP} testi T'nin küçük değerleri için sapmalı olduğu için, test istatistiğine varyans ve ortalamayı dahil ederek bu sapmayı düzeltilmiş LM_{adj} testi olarak sunmuşlardır (İlgün, 2016: 76). H_0 hipotezinin sınanıldığı test aşağıdaki gibidir:

$$CD_{LM_{\text{adj}}} = \sqrt{\frac{2}{N(N-1)}} \sum_{i=1}^{N-1} \sum_{j=i+1}^N \hat{\rho}_{ij}^2 \frac{(T-k)\hat{\rho}_{ij}^2 - \mu_{Tij}}{v_{Tij}} \quad (11)$$

4.3.2. Homojenlik Testi

Çalışmada da yatay kesit analizini takiben ikinci olarak Pesaran ve Yamagata tarafından geliştirilen $\hat{\Delta}$ ve $\hat{\Delta}_{\text{adj}}$ eğim homojenlik testleri ile kesit birimlerinin heterojenliği araştırılmıştır. Burada eğim katsayılarının homojen olup olmadığını tespit etmek için $\hat{\Delta}$ ve

$\hat{\Delta}_{adj}$ tahmin eden Swamy (1970) yaklaşımına dayanan Pesaran ve Yamagata (2007) yöntemini kullanılmıştır. Bu test T (zaman boyutu) N'den (kesit sayısı) büyük olduğunda güvenilir sonuçlar verebilir (Doğan & Şeker, 2016: 14649).

Pesaran ve Yamagata (2007), Swamy (1970) test modelini geliştirerek değiştirilmiş bir test istatistiği geliştirmişlerdir. $\hat{\Delta}$ Olarak adlandırılan test istatistiği aşağıdaki gibidir (Aydın, 2019: 623):

$$\hat{\Delta} = \sqrt{N} \left(\frac{N^{-1}\bar{s} - k}{\sqrt{2k}} \right) \quad (12)$$

\bar{s} , değiştirilmiş Swamy modelini gösterir. $\hat{\Delta}$ İstatistiği, normal dağıtılmış hatalar altında daha iyi, küçük örnek özellikleri için aşağıdaki gibi düzeltilbilir (Aydın, 2019: 623):

$$\hat{\Delta}_{adj} = \sqrt{N} \left(\frac{N^{-1}\bar{s} - E(\bar{z}_{it})}{\sqrt{var(\bar{z}_{it})}} \right) \quad (13)$$

$E(\bar{z}_{it})$ Ve $var(\bar{z}_{it})$ sırasıyla k ve 2k (T-k-1) / T+1'e eşittir. Her iki test istatistiğinin homojen eğimlerini ifade eden boş hipotez, heterojen eğimlerin hipotezine karşı test edilir.

4.3.3. Panel Birim Kök Testi

Ampirik analizin üçüncü kısmında Yatay kesit bağımlılığı ve heterojenlik konularına duyarlı panel birim kök testlerinden yararlanmak amacıyla, Pesaran (2007) tarafından önerilen CIPS (Cross-sectionally Augmented Version of IPS) panel birim kök testi kullanılarak değişkenlerin durağanlık düzeyleri test edilmiştir.

Yatay kesit bağımlılığının olduğu durumda panel verileriyle uygulanacak birim kök testlerinden güvenilir ve tutarlı sonuçlara ulaşmak için ikinci nesil birim kök testleri kullanılması gerekir. Bu nedenle çalışmada panelin geneli için durağanlıklarını sınyan ikinci nesil birim kök testlerinden CIPS tahmincisi kullanılmıştır (Çınar vd., 2012: 220; Doğan & Şeker, 2015: 14650).

Im, Pesaran ve Shin (IPS) (2003)'in testine bağlı olan CIPS (Cross-sectionally Augmented Version of IPS), her bir ülkeye ait bireysel CADF birim kök test istatistiklerinin ortalaması alınarak panel ülkelerinin bütünü için birim kök test istatistiğini tahmin etmektedir (Çınar vd., 2012: 2020).

Pesaran, tarafından kullanılan kesitsel olarak artırılmış DF (CADF) regresyon aşağıdaki gibidir (Pesaran, 2007):

$$\Delta Y_{i,t} = a_i + b_i Y_{i,t-1} + c_i \bar{Y}_{t-1} + d_i \Delta \bar{Y}_t + \varepsilon_{i,t} \quad (14)$$

$$\text{Burada } \bar{Y}_t = \frac{1}{N} \sum_{i=1}^N Y_{i,t}, \Delta \bar{Y}_t = \frac{1}{N} \sum_{i=1}^N \Delta Y_{i,t} \text{ ve } \varepsilon_{i,t} \text{ hata terimidir.} \quad (15)$$

Her birim için CADF istatistiği hesaplandıktan sonra bu değerlerin ortalamasını alarak, Pesaran (2007) panelin geneli için durağanlık durumunu temsil eden IPS testinin kesitsel bir versiyonunu (CIPS) önermiştir. CIPS istatistiği aşağıdaki gibidir:

$$CIPS = \frac{1}{N} \sum_{i=1}^N CADF_i \quad (16)$$

Burada $CADF_i$ denklemdeki kesitsel olarak artırılmış Dickey-Fuller istatistiğidir. CIPS paneli birim kök testinde birim kökü ifade eden boş hipotez, durağanlığı ifade eden alternatif hipoteze karşı test edilir. Test istatistiği kritik değerlerden büyükse, boş hipotez reddedilir, küçükse boş hipotez reddedilemez (Aydin, 2019: 624).

4.3.4. Panel Eşbütünleşme Testi

Ampirik analizin sonraki aşamasında, yatay kesit bağımlılığını göz önünde bulunduran LM bootstrap panel eşbütünleşme testi yardımıyla değişkenler arasındaki eşbütünleşme ilişkisi araştırılmıştır. Westerlund ve Edgerton (2007) tarafından geliştirilmiştir.

Westerlund ve Edgerton (2007)'in eşbütünleşme testi McCoskey ve Kao (1998) tarafından sunulan Langrage Çarpanı (LM) testine dayanmakta olup eşbütünleşmenin olduğu sıfır hipotezine sahiptir. Değişkenler arasındaki ilişki aşağıdaki model yardımıyla elde edilmiştir:

$$y_{it} = \alpha_i + x'_{it} \beta_i + z_{it} \quad (17)$$

Westerlund ve Edgerton (2007) bu hipotezleri test etmek için aşağıdaki test istatistiklerini kullanmıştır:

$$LM_N^+ = \frac{1}{NT^2} \sum_{i=1}^N \sum_{t=1}^T \widehat{w}_i^{-2} s_{it}^2 \quad (18)$$

Burada s_{it}^2 hata terimlerinin kısmi toplamlarını gösterir, \widehat{w}_i^2 hata terimlerinin uzun dönemli varyanslarını gösterir. Bootstrap LM panelinde eşbütünleşme testinin sıfır hipotezi modelde eşbütünleşmenin olduğu, alternatif hipotez ise modelde eşbütünleşme olmadığıdır. Hesaplanan olasılık değerleri anlamlılık değerlerinden küçükse boş hipotez reddedilir, büyükse boş hipotez reddedilemez. Kesit bağımlılığı olması durumunda, teste bootstrap ile hesaplanan kritik değerler kullanılır. Monte Carlo simülasyonları, testin küçük örnek durumlarda da kullanılabileceğini göstermektedir (Aydin, 2019: 624).

4.3.5. Uzun Dönem Eşbütünleşme Katsayılarının Tahmin Edilmesi

Modelin uzun dönem katsayıları Genişletilmiş Ortalama Grup Tahmincisi (Augmented Mean Group) AMG yöntemi kullanılarak tahmin edilmiştir. Bu yöntem Eberhardt ve Bond (2009) tarafından geliştirilmiştir.

AMG, ülke regresyonuna bir ortak dinamik etki dahil ederek kesit bağımlılığını açıklayan yeni bir tahmin edicidir. Tüm ülkelerde gözlemlenmeyen ortak faktörlerin eşdeğer ortalama gelişimini temsil eder. Gözlemlenmemiş ortak faktörlerin ülkeye özgü eşbütünleşme ilişkisinin bir parçasını oluşturması koşuluyla, artırılmış ülke regresyon modeli, ülkeler arasında farklılık göstermesine izin verilen eşbütünleşme ilişkisini kapsar (Eberhard & Bond, 2009: 3). Hem panelin geneline ait sonuç hem de birimlerin katsayıları ağırlıklandırılarak ortalama grup etkisini hesaplayan yöntem bu yönüyle diğer yöntemlere göre daha güçlü sonuçlar sunmaktadır (Göçer, 2013: 233).

AMG tahmincisinde benimsenen ampirik model aşağıdaki gibidir (Eberhard & Bond, 2009: 2):

$$y_{it} = \beta' x_{it} + u_{it} = a_i + \lambda' i + \varepsilon_{it} \quad (19)$$

$$x_{mit} = \pi_{mi} + \delta'_{mi} g_{mt} + \rho_{1mi} f_{1mt} + \dots + \rho_{nmi} f_{nmt} + v_{mit} \quad (20)$$

$$f_t = \varphi' f_{t-1} + \varepsilon_{it} \quad g_t = \chi' g_{t-1} + \varepsilon_{it} \quad (21)$$

Modelde f_t gözlemlenemeyen ortak faktörleri ve g_t ülkelere özel faktör yüklerini (country-specific factor loadings) ifade etmektedir.

4.4. Ampirik Sonuçlar

Modelde kullanılan değişkenlerin yatay kesit bağımlılığı durumları CD ve CD_{adj} testleriyle tahmin edilerek sonuçları Tablo 2'de gösterilmiştir. Test sonuçlarına göre altı değişkenin de istatistiksel olarak %1 anlamlılık düzeyinde "yatay kesit bağımlılığı yoktur" hipotezi reddedilebilmektedir. Dolayısıyla çalışmada yatay kesit bağımsızlığının sıfır hipotezi reddedilir, analiz edilen tüm değişkenlerde yatay kesit bağımlılığı bulunmaktadır. Sonuçlar analiz edilen ülkelere birinde ortaya çıkan şokun diğer ülkeleri de etkilediğini göstermekte, bu da analizin diğer aşamalarında yatay kesit bağımlılığını hesaba katan ikinci nesil testlerin uygulanması gerektiğini göstermektedir.

Tablo: 2
Yatay Kesit Bağımlılığı Test Sonuçları

DEĞİŞKENLER	Test istatistikleri	
	CD	CD_{adj}
GROWTH	152.2853*	56.19660*
UNEMP	48.78355*	17.40953*
GHG	124.4523*	30.80149*
ENCONS	108.2856*	31.44601*
CAPFOR	47.45254*	28.08794*
ENVTAX	54.08964*	4.536114*

Not: *, ** ve *** işaretleri sırasıyla %1, %5 ve %10 yanılma düzeylerini ifade eder. Yatay kesit bağımlılığı testlerinin tahmininde E-Views 10 programı kullanılmıştır.

İkinci olarak eğim katsayılarının homojen olduğunu ifade eden H_0 hipotezine karşılık eğim katsayılarının heterojen olduğunu ifade eden hipotez sınanmıştır. Delta testleri sonuçlarına göre homojenlik varsayımı %1 anlamlılık düzeylerinde reddedilir ve birimlerin katsayıları heterojen bulunur.

Tablo 3'te CIPS paneli birim kök testi sonuçları sunulmuştur. Panel birim kök testi sonuçları, tüm değişkenlerin birim köke sahip olduğunu göstermektedir. Buna karşılık seriler birinci farklarında durağandır yani birinci dereceden entegredir. CIPS panel birim kök testi için birim kökü ifade eden sıfır hipotezi, durağanlığı ifade eden alternatif hipoteze karşı test edilir. Test istatistiği kritik değerlerden büyükse sıfır hipotezi reddedilir. %1, %5 ve %10 anlamlılık düzeyinde sıfır hipotezinin reddedildiğini gösterir.

Tablo: 3
CIPS Panel Birim Kök Test Sonuçları

Değişkenler	Seviye	Birinci Fark
	Test istatistiği	Test istatistiği
GROWTH	0.481 [0.315]	-2.490* [0.018]
UNEMP	1.472 [0.930]	-2.347* [0.009]
GHG	4.148 [1.000]	-1.355*** [0.088]
ENCONS	2.569 [0.995]	-1.724** [0.042]
CAPFOR	-0.906 [0.182]	-3.500* [0.000]
ENVTAX	2.638 [0.996]	-1.592** [0.056]

Not: *, ** ve *** işaretleri sırasıyla %1, %5 ve %10 yanılma düzeylerini ifade eder. Panel birim kök testleri Stata 14 programı kullanılarak tahmin edilmiştir.

Tablo 4, panel eşbütünlüşme testi sonuçlarını göstermektedir. Bu testin sıfır hipotezi, değişkenler arasında eşbütünlüşme var. Bootstrap p değeri, anlamlılık değerlerinden küçükse, boş hipotez reddedilir. Sonuçlar dahilinde "eşbütünlüşme vardır" boş hipotezi istatistiksel olarak %1 anlamlılık düzeyinde reddedilememiştir. Bu bağlamda Bootstrap LM paneli eşbütünlüşme testine göre, değişkenler arasında uzun dönemli bir ilişki vardır. Başka bir deyişle çevre vergileri, ekonomik büyüme, işsizlik, sermaye stoku ve enerji tüketimi arasında eşbütünlüşme vardır. Bu uzun dönemli ilişkinin katsayıları ise değişkenlerin heterojenliği ve kesit bağımlılığı dikkate alan AMG tahmincisi kullanılarak hesaplanmaktadır.

Tablo: 4
LM Bootstrap Panel Eşbütünlüşme Test Sonuçları

	LM istatistiği	Bootstrap olasılık değeri
Model 1	11.270*	0.997
Model 2	4.533*	0.873
Model 3	9.448*	0.999

Not: *, ** ve *** işaretleri sırasıyla %1, %5 ve %10 yanılma düzeylerini ifade eder. Eşbütünlüşme testleri, Gaus 10 programı kullanılarak tahmin edilmiştir.

Son olarak uzun vadeli eşbütünlüşme katsayıları panel AMG yöntemiyle tahmin edilmiş ve elde edilen sonuçlar aşağıda sunulmuştur. Tablo 5 Model 1, Tablo 6 Model 2 ve Tablo 7 Model 3 için AMG tahmin sonuçlarını göstermektedir.

Tablo: 5
Model 1 İçin AMG Test Sonuçları

Bağımlı Değişken: GHG	Katsayı	Standart Hata	Olasılık Değeri
Değişkenler			
GROWTH	0.1411287*	0.06499812	0.030
ENCONS	0.5875943*	0.0607158	0.000
ENVTAX	0.0574878**	0.0313361	0.067
Sabit	-4.460592*	0.6564199	0.000

Not: *, ** ve *** işaretleri sırasıyla %1, %5 ve %10 yanılma düzeylerini ifade eder. AMG testleri, Stata 14 programı kullanılarak tahmin edilmiştir.

Tablo 5'teki bilgiler ekonomik büyüme, fosil enerji tüketimi ve çevre vergileri değişkenlerinin katsayılarının ve bu değişkenlerin sera gazı emisyonları üzerindeki öneminin incelenmesine yardımcı olmaktadır. AB ülkelerinde çevre vergilerinin, ekonomik büyüme ve enerji tüketiminin sera gazı emisyonlarını artırıcı yönde etkilediği sonucuna ulaşılmıştır. Dolayısıyla çevre kirliliğini temsilen kullanılan sera gazı emisyonları üzerinde çevre vergilerinden beklenen olumlu etkinin ortaya çıkmadığı anlaşılmaktadır. AB ülkeleri için çalışmanın bulgusu literatürdeki genel eğilimden farklı sonuçlar ortaya çıkarmıştır. Çevre vergilerindeki artışın emisyonları artırmasının nedeni çevre vergilerinin çevre üzerinde olumsuz etkisi olan ürünlerin kullanımında azalma sağlayamaması nedeniyle vergilerden beklenen teşvik etkisinin gerçekleşmemesi şeklinde yorumlanabilir. AB bazında alınan sonuçlar Soares (2011)'in değerlendirmeleriyle paraleldir. AB mevzuatının durumuna, çevre ve iklim değişikliği politikaları alanındaki başlıca AB hedeflerine ve stratejilerine bakıldığında son 30 yılda Avrupa çevre politikalarının ekonomik ve politik döngülere karşı çok hassas olduğu görülür. Bu nedenle çevre vergilerinden beklenen emisyon göstergelerinde azaltıcı etkinin ortaya çıkmadığı söylenebilir.

Tablo: 6
Model 2 İçin AMG Test Sonuçları

Bağımlı Değişken: GROWTH	Katsayı	Standart Hata	Olasılık Değeri
Değişkenler			
ENCONS	0.1587862*	0.0458423	0.001
ENVTAX	-0.0647873*	0.0283388	0.022
Sabit	8.79685*	0.354212	0.000

Not: *, ** ve *** işaretleri sırasıyla %1, %5 ve %10 yanılma düzeylerini ifade eder.

Tablo 6 ise fosil enerji tüketimi ve çevre vergilerinin ekonomik büyümeyi nasıl etkilediğini göstermektedir. Enerji tüketimindeki artışın ekonomik büyümeyi artırıcı yönde, çevre vergilerindeki artışın ise ekonomik büyümeyi aşağı yönlü etkilediği tespit edilmiştir. Çevre vergilerinin ekonomik büyüme üzerinde bozucu bir etkiye sahip olduğunu tespit eden Morley (2010), Radulescu vd. (2017), Hassan vd. (2018) ile benzer sonuçlara ulaşılmıştır. Emisyonlar ile ekonomik büyüme arasındaki ters yönlü ilişki literatürde kötümser olarak bilinen Meadows vd. 1972; Daly, 1996'nin ekonomik büyüme ile çevre kalitesinin korunması arasında değiş-tokuş olduğu inancını kuvvetlendirmektedir.

Tablo 7
Model 3 İçin AMG Test Sonuçları

Bağımlı Değişken: UNEMP	Katsayı	Standart Hata	Olasılık Değeri
Değişkenler			
GROWTH	-2.455713*	0.3687703	0.000
CAPFOR	-0.3153515**	0.160409	0.049
ENVTAX	0.321376**	0.1657856	0.053
Sabit	27.07609*	3.633203	0.000

Not: *, ** ve *** işaretleri sırasıyla %1, %5 ve %10 yanılma düzeylerini ifade eder.

Tablo 7’deki Model 3 için sonuçlara bakıldığında ekonomik büyümedeki ve sermaye dönüşümündeki eski adıyla yatırımlardaki artışın işsizliği düşürdüğü, çevre vergilerindeki artışın işsizliği artırdığı sonucuna ulaşılmıştır. Çevre vergilerinin istihdamı artırmak ya da işsizliği düşürmek yerine olumsuz bir etkide bulunduğu dair bulgu Nerudová ve Dobranschi (2014), Morley ve Abdullah (2014), Arbolino ve Romano (2014) ve He vd. (2019)’nin bulgularını destekler niteliktedir. Bu anlamda çevre vergilerinin ikinci bir yarardan ziyade ekonomik büyüme ve istihdamı olumsuz yönde etkileyebileceğini dile getiren (Bovenberg & de Mooij, 1994; Goulder, 1995; Parry, 1995; Ekins, 1999; Carraro et al., 1996) literatürü desteklemektedir.

5. Sonuç

Ağırlıklı olarak çevresel vergilendirme literatüründe iki yaklaşımın öne çıktığına şahit oluyoruz. Bu yaklaşımlardan ilki, çevre vergilerinin çevresel faydalar açısından mikro düzeyde ele alındığı, ikincisi ise daha geniş perspektifle kamu finansmanına ve istihdama yönelik katkılarının ortaya konduğu yaklaşımdır. 1970’lerde çevre vergileri terimi “negatif dışsallıklar teorisi” ve “kirlenen öder ilkesi” ile anılmış daha sonra 80’li ve 90’lı yıllarda etkinliği sağlamada en uygun piyasa tabanlı araçlar olarak değerlendirilmiştir. Günümüzde ise çevresel vergiler ekonomik büyüme ve istihdam üzerinde olumlu etkilerini savunan “çifte yarar (kâr, temettü ya da kazanç) teorisi” ile anılmakta ve vergi reformlarının bir parçası haline getirilmektedir. Bu kapsamda bu çalışmada son dönemlerde kirliliğin önlenmesine yönelik çoğu zaman da mali amaçlara sahip çevre vergilerinin çevre, ekonomik büyüme ve istihdam üzerindeki etkilerinin anlaşılmasına dayanan teorik görüşler Panel Güçlendirilmiş Ortalama Grup Etkisi (Augmented Mean Group: AMG) yöntemiyle test edilmiştir. 24 AB ülkesinde 1998-2018 dönemi için çevre vergileri ile ekonomik büyüme ve istihdam arasındaki ilişki araştırılmıştır.

Araştırmada AB ülkeleri incelenmiş ve öncelikle yatay kesit bağımlılık testleri yapılmıştır. Yatay kesit bağımlılığının test edilmesinde Pesaran (2004) ve Pesaran vd. (2008) tarafından sunulan testler kullanılmıştır. Ulaşılan sonuçlar doğrultusunda yatay kesit bağımlılığını ve heterojenliğini hesaba katan ikinci nesil Im, Pesaran ve Shin (CIPS) (2003) panel birim kök testleri uygulanmıştır. Değişkenler arasındaki uzun dönemli eşbütünleşme ilişkisinin tahmininde ise Westerlund ve Edgerton (2007) tarafından geliştirilen Bootstrap Panel Eşbütünleşme testi kullanılmıştır. Son olarak değişkenler arasındaki uzun dönemli ilişki AMG tahmincisi ile ortaya konulmuştur.

Çalışmanın emisyonlar, ekonomik büyüme ve istihdam açısından üç temel sonucu bulunmaktadır. Çalışma, analiz edilen ülkelerde çevre vergilerinden elde edilen gelirlerin artmasıyla, çevre dostu olmayan emisyon göstergesinde azalma yerine artış tespit etmiştir. Çalışmanın ekonomik büyümeye ilişkin sonucu, her ne kadar çevre vergilerinin politik kabul edilebilirliğini sağlamak için vergilerin mali amacı ön plana çıkarılsa da çevre vergilerinin olumsuz bir ekonomik etkiye sahip olma eğiliminde olduğudur. Avrupa Birliği ülkelerinde gelecekte çevreyi korumaya yönelik hayata geçirilecek çevre vergilerinin ekonomik büyüme üzerinde daha kısıtlayıcı ve maliyetli sonuçlar ortaya çıkaracağı beklenebilir. Çalışmanın sonuçları çevreyi korumaya ve kirliliği azaltmaya yönelik vergi politikalarının kaygıları doğrularak olumsuz bir ekonomik etkiye sahip olma eğiliminde olduğunu, ekonomik büyüme ya da istihdam yararı şeklinde ifade edilen "çifte yarar" beklentisinin ise sağlanmadığını göstermektedir.

AB ülkelerinde hayata geçirilen politikalar ve yapılan teorik tartışmalarda çevre vergilerinden beklenen etkilerin analiz edildiği bu çalışmanın bulgularından yapılan değerlendirmeler sonucunda çevre vergilerinden beklenen olumlu etkilerin görülebilmesi için aşağıdaki hususlara dikkat edilmesi gerektiği tespit edilmiştir:

Çevresel amaçların uzağında kalan çevre vergilerindeki artışın emisyonlar üzerindeki olumsuz etkisi kirlenici ürünlerin kullanımının yaygınlaşmasıyla çevre vergilerinin artışının ve emisyon artışının birbirini beslemesinin sonucudur. Bu durumun çevre vergilerinden beklenen teşvik edici etkinin yetersizliğinden kaynaklandığı düşünülmektedir. Sonuçlar AB’de çevresel vergi politikasının 1970’lerdeki “dışsalıkları içselleştirmek” argümanından, 1990’larda “çifte yarar” argümanına evriminin çevre politikasına rehberliği açısından zayıflığını göstermektedir. Çevre vergilerinin çevresel faydalarına yönelik dikkatlerin çifte yarar argümanı yoluyla elde edilen gelirlere çekilmesi çevre vergilerinin ana hedefi olan çevresel amacın gerçekleşmesini engellemektedir. Bu nedenle çevresel vergilerin çevresel iyileştirme amacının ön plana çıkarılması gerekmektedir.

İnsani gelişmiş endeksinin yüksek olduğu Avrupa Birliği ülkelerinde çevre vergilerinin emisyon üzerindeki olumsuz etkisi daha katı çevre vergisi uygulamalarına ihtiyaç olduğunu ortaya koymaktadır. Ekonomi politikası olarak çevresel vergi müdahaleleri, çevresel faydalar temelinde gerekçelendirilmeli, mevcut vergiler çevresel kriterlere göre yeniden yapılandırılmalıdır. Enerji hem kirliliğin hem de vergi gelirinin ana kaynaklarından biri olduğu için enerji vergilerinin “çevresel” amaçlı yeniden yapılandırılması bir zorunluluktur. Akaryakıt vergilerinin çevresel parametreler, partiküller veya karbon içeriği gibi diğer içerikler temelinde yeniden yapılandırılması sağlanmalıdır.

Sera gazı emisyonlarının dörtte birini temsil eden motorlu taşıtların üzerindeki vergilerin de bir taşıtın kullandığı yakıtın çevreye verdiği etkilere, tahmini yakıt tüketimine veya karbon verimliliğe göre yeniden yapılandırılması mümkündür. Avrupa Birliği ülkelerinde ağır vasıtalar ve muhtemelen yakın gelecekte binek otomobiller için mesafeye dayalı ücretlerin benimsenmesi yaygınlaştırılabilir.

Bir diğer öneri de öncelikli amacı çevreyi korumak olan yeni vergilerin düzenlenmesidir. Emisyonlar veya çevre sorunlarıyla yakından ilişkili ürünler üzerinden alınan vergilerin yaygınlaştırılması sağlanmalıdır. Doğal kaynak ve kirlilik vergileri bunun en yaygın kullanılan örnekleridir.

OECD veri tabanında 1150 muafiyet ve özel vergi hükümlerine rastlanmaktadır. Tutarlı bir çevre vergisi reformu için önemli bir seçenek de bu zararlı vergi hükümlerinin kaldırılmasıdır. 2030 yılına kadar önemli sayıda çevre ve iklim hedefi ve stratejisi hali hazırda kabul edilmiştir. Ancak, AB ülkelerinin her zaman bu hedefler doğrultusunda ilerleyemediği görülmektedir. Üye Devletlerin uyumluluğu ve çevre mevzuatının uygulanmasının daha kararlı bir şekilde ele alınması gerekmektedir. Biyoçeşitlilik kaybının önlenmesi ve kirleticilerin daha fazla azaltılması atık mevzuatına uyum ve fosil yakıtlara yönelik sübvansiyonların aşamalı olarak kaldırılması gibi uygulama, yaptırım, finansman ve politika entegrasyonundaki önemli boşluklar AB hedeflerine ulaşılmasını tehdit etmektedir.

Vatandaşların hükümetlerin çevresel vergi düzenlemelerini genel olarak vergileri artırmanın bir yolu olduğunu hissetmeleri de vergiye uyum açısından önemli bir engeldir. Bu sebeple çevre vergilerinden elde edilen gelirlerin kullanımı, gelir dağılımı ve rekabet gücü etkileri ve hükümetin bu durumlarla nasıl başa çıkmayı planladığı da dâhil olmak üzere açık ve şeffaf iletişimin başarılı bir uygulamanın anahtarı olduğunu kanıtlamaktadır.

Sonuç olarak, çevre vergilerinden elde edilen gelirler hem gelir yaratma hem de çevresel hedeflere ulaşmada oldukça önemlidir. İklim krizinin zirveye ulaştığı 21. yüzyılda çevresel vergi politikalarının daha yaygın ve etkin bir şekilde kullanılması gerekmektedir. Çevre vergilerinin ekonomik büyüme ve istihdam üzerindeki olumsuz etkisi diğer bozucu vergilerde indirim yoluyla azaltılabilir. Çevre vergilerinin istihdamı düşürücü etkisi yatırımların istihdam artırıcı etkisinden yola çıkılarak yeşil enerji ve çevre dostu üretime yatırım artışları ile tersine çevrilebilir. Söz konusu önerilerin de çevre vergilerinin alternatif bir vergi geliri kaynağı olarak ele alınmasından çok çevresel amaçları açıkça belirlenmiş bir tanımının yapılmasıyla sağlanabileceği kanaati oluşmuştur.

Kaynaklar

- Andersen, M.S. (2005), "Do 'Green' Taxes Work? Decoupling Environmental Taxes", *Public Policy Research*, 12(2), 79-84.
- Arbolino, R. & O. Romano (2014), "A Methodological Approach for Assessing Policies: the Case of the Environmental Tax Reform at European Level", *Procedia Economics and Finance*, 17, 202-210.
- Aydin, M. (2019), "The Effect of Biomass Energy Consumption on Economic Growth in BRICS Countries: A Country-Specific Panel Data Analysis", *Renewable Energy*, 138, 620-629.
- Baltagi, B.H. (2005), *Econometric Analysis of Panel Data*, England: John Wiley & Sons Ltd.
- Barbieri, N. et al. (2021), *Sustainability Transition and the European Green Deal: A Macro-Dynamic Perspective*, EEA.

- Baumol, W.J. & W. Oates (1975), *On Taxation and the Control of Externalities*, United States of America: The University of Cambridge.
- Baumol, W.J. (1972), "On Taxation and the Control of Externalities", *American Economic Review*, 62(3), 307-322.
- Bernard, J.-T. et al. (2018), "Effects of B.C.'s Carbon Tax on GDP", *USAEE Research Paper Series*.
- Bovenberg, A.L. & R.A. De Mooij (1994), "Environmental Levies and Distortionary Taxation", *The American Economic Review*, 84(4), 1085-1089.
- Carraro, C. et al. (1996), "Environmental Taxation and Unemployment: Some Evidence on the 'Double Dividend Hypothesis' in Europe", *Journal of Public Economics*, 62, 141-181.
- CEC (1993), *White Paper on Growth, Competitiveness and Employment*, Luxembourg: Office for Official Publications of the European.
- Çınar, S. et al. (2012), "Kirlilik Yaratan Sektörlerin Ticareti ve Çevre: Gelişmiş Ülkeler ve Gelişmekte Olan Ülkeler Karşılaştırması", *Doğuş Üniversitesi Dergisi*, 13(2), 212- 226.
- Daly, H.E. (1996), *Beyond Growth: The Economics of Sustainable*, Boston: Beacon Pres.
- Doğan, E. & A. Aslan (2017), "Exploring the Relationship Among CO2 Emissions, Real GDP, Energy Consumption and Tourism in the EU and Candidate Countries: Evidence from Panel Models Robust to Heterogeneity and Cross-Sectional Dependence", *Renewable and Sustainable Energy Reviews*, 77, 239-245.
- Doğan, E. & F. Şeker (2015), "An Investigation on the Determinants of Carbon Emissions for OECD Countries: Empirical Evidence from Panel Models Robust to Heterogeneity and Cross-Sectional Dependence", *Environmental Science and Pollution Research*, 23(14), 14646-14655.
- Eberhardt, M. & S. Bond (2009), *Cross-Section Dependence in Nonstationary Panel Models: a Novel Estimator*, Centre for the Study of African Economies.
- EC (2001), *Environmental Taxes - A Statistical Guide*, Luxembourg: European Communities.
- EC (2010), *Europe 2020: A Strategy for Smart, Sustainable and Inclusive Growth*, Brussels: European Commission.
- EC (2013), *Environmental Taxes: A Statistical Guide*, Luxembourg: European Union.
- EEA (2016), *Environmental Taxation and EU Environmental Policies*, Luxembourg: European Environment Agency.
- EEA (2021), *Reflecting on Green Growth Creating a Resilient Economy within Environmental Limits*, Copenhagen: European Environment Agency.
- Ekins, P. (1999), "European Environmental Taxes and Charges: Recent Experience, Issues and Trends", *Ecological Economics*, 31, 39-62.
- Eurostat (2010), *Environmental Statistics and Accounts in Europe*, Belgium: European Commission.
- Gago, A. & X. Labandeira (2010), "Towards a Green Tax Reform Model", *Journal of Environmental Policy & Planning*, 2(1), 25-37.
- Goodstein, E. (2003), "The Death of the Pigovian Tax? Policy Implications from the Double-Dividend Debate", *Land Economics*, 76(3), 402-414.
- Goulder, L. (1995), "Environmental Taxation and the Double Dividend: A Reader's Guide", *International Tax and Public Finance*, 2, 157-183.

- Göçer, İ. (2013), "Ar-Ge Harcamalarının Yüksek Teknolojili Ürün İhracatı, Dış Ticaret Dengesi ve Ekonomik Büyüme Üzerindeki Etkileri", *Maliye Dergisi*, (165), 215-240.
- Gökmen, G. (2012), "Environmental Tax and Economic Growth: A Panel Var Analysis", *Erciyes Üniversitesi İktisadi ve İdari Bilimler Fakültesi Dergisi*, (40), 43-65.
- Greene, W.H. (2003), *Econometric Analysis*, New Jersey: Prentice Hall.
- Günaydın, İ. (2014), "Yeşil Vergiler Çevreyi Koruma ve İşsizliği Azaltma Amaçlarını Aynı Anda Sağlayabilir Mi?", in: İ. Günaydın & T. Özsoy (eds.), *Disiplinler Arası Bakış Açısı ile Çevre* (108-136), İstanbul: Hiperlink.
- Hassan, M. et al. (2020), "Exploring the Link Between Energy Based Taxes and Economic Growth", *Environmental Economics and Policy Studies*, 22, 67-87.
- He, P. et al. (2019), "Does the Double Dividend of Environmental Tax Really", *Ekoloji*, 28(107), 49-62.
- Hey, C. (2005), "EU Environmental Policies: A Short History of the Policy Strategies", *EU Environmental Policy Handbook*, 18-30.
- Hsiao, C. (2003), *Analysis of Panel Data*, United Kingdom: Cambridge University Press.
- Hur, G.-h. (2000), "Double Dividend Hypothesis of Environmental Tax in Republic of Korea: For Sustainable Development", *2nd International Critical Geography Conference*.
- İnglesi-Lotz, R. & E. Dogan (2018), "The Role of Renewable Versus Non-Renewable Energy to the Level of CO2 Emissions a Panel Analysis of Sub-Saharan Africa's Big 10 Electricity Generators", *Renewable Energy*, 123, 36-43.
- İlgün, M.F. (2016), "Mali Sürdürülebilirlik: OECD Ülkelerine Yönelik Panel Veri Analizi", *Atatürk Üniversitesi İktisadi ve İdari Bilimler Dergisi*, 30(1), 69-90.
- Jaeger, W.K. (2003), *Environmental Taxation and the Double Dividend*, International Society for Ecological Economics, Internet Encyclopaedia of Ecological Economics.
- Kosonen, K. & G.J. Nicodème (2009), *The Role of Fiscal Instruments in Environmental Policy*, Center for Economic Studies and IFO Institute(CESifo), Munich.
- Lee, D.R. & W.S. Misiolek (1986), "Substituting Pollution Taxation for General Taxation: Some Implications for Efficiency in Pollution Taxation", *Journal of Environmental Economics and Management*, 13, 338-347.
- Ligthart, J.E. (1998), "The Macroeconomic Effects of Environmental Taxes: A Closer Look at the Feasibility of 'Win-Win' Outcomes", *IMF Working Paper*.
- Marten, M. & K. Dender (2019), *The Use of Revenues from Carbon Pricing*, OECD.
- Meadows, D. et al. (1972), *The Limits to Growth: A Report for the Club of Rome's Project on the Predicament of Mankind*, A Potomac Associates Book.
- Metcalfe, G. (2019), "On the Economics of a Carbon Tax for the United States", *Brookings Papers on Economic Activity*, 405-484.
- Metcalfe, G.E. & J.H. Stock (2020), "Measuring the Macroeconomic Impact of Carbon Taxes", *AEA Papers and Proceedings*, 110, 101-106.
- Migliavacca, S. (2006), "Environmental Taxation and The Double Dividend Hypothesis", in: *Critical Issues on Environmental Taxation III* (1-16), Pavia: Oxford University Press.
- Morley, B. & S. Abdullah (2014), "Environmental Taxes and Economic Growth: Evidence from Panel Causality Tests", *Energy Economics*, (42), 27-33.

- Morley, B. (2010), "Environmental Policy and Economic Growth: Empirical Evidence from Europe", *Bath Economics Research Working Papers*.
- Morley, B. (2012), "Empirical Evidence on the Effectiveness of Environmental Taxes", *Applied Economics Letters*, 19(18), 1817-1820.
- Nerudová, D. & M. Dobranschia (2014), "Double Dividend Hypothesis: Can it Occur When Tackling Carbon Emissions?", *Procedia Economics and Finance*, (12), 472-479.
- OECD (1992), *The Polluter-Pays Principle*, Paris: OECD.
- OECD (2017), *Environmental Fiscal Reform: Progress, Prospects and Pitfalls*, OECD.
- Özcan, B. & A. Arı (2014), "Araştırma-Geliştirme Harcamaları ve Ekonomik Büyüme İlişkisi: Panel Veri Analizi", *Maliye Dergisi*, (166), 39-55.
- Parry, I.W. (1995), "Pollution Taxes and Revenue Recycling", *Journal of Environmental Economics and Management*, (29), 64-77.
- Pearce, D. (1991), "The Role of Carbon Taxes in Adjusting to Global Warming", *The Economic Journal*, 101(407), 938-948.
- Pearce, D. et al. (1989), *Blueprint for A Green Economy*, New York: Earthscan.
- Pesaran, M.H. & T. Yamagata (2008), "Testing Slope Homogeneity in Large Panels", *Journal of Econometrics*, 142, 50-93.
- Pesaran, M.H. (2004), "General Diagnostic Tests for Cross Section Dependence in Panels", *IZA Discussion Paper No. 1240*.
- Pesaran, M.H. (2007), "A Simple Panel Unit Root Test in the Presence of Cross-Section Dependence", *Journal of Applied Econometrics*, 22, 265-312.
- Pesaran, M.H. et al. (2008), "A Bias-Adjusted LM Test of Error Cross-Section Independence", *Econometrics Journal*, 11, 105-127.
- Pezzey, J. & A. Park (1998), "Reflections on the Double Dividend Debate", *Environmental and Resource Economics*, 11(3-4), 539-555.
- Radulescu, M. et al. (2017), "Environmental Tax Policy in Romania in the Context of the EU: Double Dividend Theory", *Sustainability*, 9(11), 1-20.
- Repetto, R. et al. (1992), *Green Fees: How a Tax Shift Can Work for the Environment and the Economy*, World Resources Institute.
- Schlegelmilch, K. & A. Joas (2015), "Fiscal Considerations in the Design of Green Tax Reforms", in: *Green Growth Knowledge Platform* (1-50), Venice, Italy: Green Growth Knowledge Platform.
- Soares, C.A. (2011), "The Design Features of Environmental Taxes", *Doctoral Dissertation*, The London School of Economics and Political Science.
- Speck, S. (2008), "The Design of Carbon and Broad-Based Energy Taxes in European Countries", *Vermont Journal of Environmental Law*, 10, 31-59.
- Şahin, Y. (1999), "Türk Vergi Sisteminin Çevresel Vergiler Açısından Değerlendirilmesi", *Vergi Sorunları Dergisi*, (133), 119-137.
- Şaşmaz, M.Ü. (2016), "Validity of Double Dividend Hypothesis in EU-15 Countries", *Global Journal on Humanities and Social Sciences*, 2(2), 30-36.
- Terkla, D. (1984), "The Efficiency Value of Effluent Tax Revenues", *Journal of Environmental Economics and Management*, 11, 107-123.

- Topal, M.H. (2017), "Çifte Kazanç Hipotezinin OECD Ekonomileri için Testi:Panel Eşbütünlük ve Nedensellik Analizi", *Uluslararası Bilimsel Araştırmalar Dergisi*, 2(4), 1-20.
- Topallı, N. (2016), "CO2 Emisyonu ve Ekonomik Büyüme Arasındaki İlişki:Hindistan, Çin, Brezilya ve Güney Afrika için Panel Veri Analizi", *Çankırı Karatekin Üniversitesi İktisadi ve İdari Bilimler Fakültesi Dergisi*, 6(1), 427-447.
- Tullock, G. (1967), "Excess Benefit", *Water Resources Research*, 3(2), 643-644.
- Westerlund, J. & D.L. Edgerton (2007), "A Panel Bootstrap Cointegration Test", *Economics Letters*, 97, 185-190.
- World Bank (2005), *Environmental Tax Reform: What Should Be Done and How to Achieve It*, Washington: The International Bank for Reconstruction and Development.
- Yalçinkaya, Ö. & İ. Hüseyini (2016), "Tasarruf-Yatırım İlişkisi: Feldstein-Horioka Hipotezinin OECD Ülkeleri Açısından Değerlendirilmesi (1980-2013)", *Dokuz Eylül Üniversitesi İktisadi ve İdari Bilimler Fakültesi Dergisi*, 31(1), 343-369.
- Yamazaki, A. (2017), "Jobs and Climate Policy: Evidence from British Columbia's Revenue-Neutral Carbon Tax", *Journal of Environmental Economics and Management*, 93, 197-216.
- Zhou, R. & K. Segerson (2012), "Are Green Taxes a Good Way to Help Solve State Budget Deficits?", *Sustainability*, (4), 1329-1353.

Dirgen-Öz, S. & H.G. Çiçek (2024), "Avrupa Birliđi Ülkelerinde Çevre Vergilerinin Çevre, Ekonomik Büyüme ve İşsizlik Üzerindeki Etkisinin Ampirik Analizi", *Sosyoekonomi*, 32(59), 269-295.

Finansal İstikrarsızlığın Kamu Bankalarının İstikrarına Etkisi: Bir PMG/ARDL Panel Yaklaşımı

Mehmet Fatih ASLANTAŞ (<https://orcid.org/0000-0002-5987-2976>), Kafkas University, Türkiye; mfaslantas@gmail.com

Tuncer YILMAZ (<https://orcid.org/0000-0001-8956-5814>), Kafkas University, Türkiye; yilmaz-tuncer@hotmail.com

Mehmet Fatih ÇAPANOĞLU (<https://orcid.org/0000-0001-8549-2822>), Hakkari University, Türkiye; mehfatca@gmail.com

The Effect of Financial Instability on the Stability of Public Banks: A PMG/ARDL Panel Approach

Abstract

This paper aims to analyse the impact of some macro-financial instability variables specific to the Turkish economy on the financial stability performance of state-owned banks. The study utilises quarterly data for the period 2017-2022. The panel, PMG/ARDL technique, is used as the econometric model to achieve the study's cointegration of long-run and short-run empirical objectives. The findings of this study conducted in an emerging economy indicate a significant cointegration between the financial instability indicators in the model and the financial stability of banks. In the PMG impact analysis, it is observed that the indicators of total domestic loan volume, credit risk premium and non-performing loan ratio reduce the stability of banks in the long run, while banks can successfully manage this situation by turning it into a positive in the short run. Finally, there is statistically significant evidence that the indicators that cause instability have a negative impact and a cointegrated relationship in the long run on the financial stability of banks, which play an important function in the economic system for both the real and financial services sectors. In this context, the evidence of the banking sector's stability has implications for policymakers, academia, regulators and investors in the banking sector.

Keywords : Financial Instability, Public Banks, Financial Stability, PMG/ARDL.

JEL Classification Codes : E69, G21, G29, H41.

Öz

Bu makalede, Türkiye ekonomisine özgü bazı makro finansal istikrarsızlık değişkenlerinin kamu sermayeli bankaların finansal istikrar performansı üzerindeki etkisinin incelenmesi amaçlanmıştır. Çalışmada, 2017-2022 dönemi boyunca çeyreklik veriler kullanılmıştır. Çalışmanın eşbütünleşme, uzun ve kısa dönem ampirik amaçlarına ulaşmak için ekonometrik model olarak panel PMG/ARDL tekniği kullanılmıştır. Gelişmekte olan bir ekonomide yapılan bu çalışmanın bulgularında, modelde yer alan finansal istikrarsızlık göstergeleri ile bankaların finansal istikrarları arasında önemli düzeyde bir eşbütünleşmenin varlığına rastlanılmıştır. PMG etki analizlerinde ise, yurtiçi toplam kredi hacmi, kredi risk primi ile takipteki kredilerin oranı göstergelerinin uzun dönemde bankaların istikrarını azalttığı, kısa dönemde ise bankaların bu durumu pozitifte dönüştürerek başarılı bir şekilde yönetebildikleri görülmüştür. Son olarak, istikrarsızlığa neden olan göstergelerin hem reel sektör hem de finansal hizmetler sektörü için ekonomik sistemde önemli bir işlev gören bankaların finansal istikrarı üzerinde uzun dönemde negatif bir etkiye ve eşbütünleşik bir ilişki içinde olduğuna dair kanıtlar istatistiksel olarak anlamlı bulunmuştur. Bu bağlamda, bankacılık sektörünün istikrarına

yönelik elde edilen kanıtlar, bankacılık sektörüne yönelik politika yapıcılar, akademik çevre, düzenleyiciler ve yatırımcılar içinde çeşitli çıkarımlar sunmaktadır.

Anahtar Sözcükler : Finansal İstikrarsızlık, Kamu Bankaları, Finansal İstikrar, PMG/ARDL.

1. Giriş

Finansal istikrar hakkında kesin olarak belirlenen geniş çaplı kabul görmüş bir tanım bulunmamaktadır. İsveç Merkez Bankası Başkanı'nın tabiriyle açıklanacak olunursa “İstikrar muğlaktır ve tanımlanması zordur” (Allen & Wood, 2006: 152). Finansal istikrarın tanımlanmasındaki muğlaklık söz konusu kavramın tek bir gösterge ile açıklanamamasından kaynaklanmaktadır. Bir taraftan da finansal istikrarı açıklayan göstergelerin birbiri ile olan benzerliği de istikrar tanımlarının birbirinden tümüyle kopmasına da engel olmaktadır (Akyol & Varlık, 2010: 146). Finansal istikrarın tanımının yapılması için finansal sistem içerisinde bulunan tüm öğelerin ekonomik sistemle ilişkilerinin tümüyle değerlendirilerek risklerin de dahil edildiği bir perspektif geliştirilmelidir (Coşar & Köse, 2019: 5).

Finansal kurumlar için istikrar, sözleşmelerine bağlı olarak gelişen süreç içerisinde ortaya çıkan yükümlülüklerinin sekteye uğramadan ve tam olarak yerine getirilmesinde bir güven sorununun ortaya çıkmamasını ifade etmektedir (Göker, 2009: 11). Finansal istikrar, günümüzde dünyada merkez bankalarının ve finansal idari otoritelerin gündemlerinin üst sıralarını meşgul etmektedir. Dünyada ortaya çıkan finansal krizlerin artışı finansal istikrarın sağlanmasının önemini artırmıştır. Söz konusu krizlerin önlenmesi sistemik risklerin değerlendirilmesinden ve sistemik krizlerin engellenmesinden sorumlu olan merkez bankaları ve finansal otoriteler adına da önem arz etmektedir (Tabak & Staub, 2007: 188). Finansal istikrara kamu maliyesi açısından bakıldığında finansal istikrar küresel bir kamusal mal hükmündendir. Bu bağlamda kamusal mal özellikleri arasında gösterilen dışlanmama ve rekabetsizlik durumu finansal istikrar açısından da geçerli olmaktadır (Yıldırım, 2017: 326).

1990'lı yıllarda hız kazanan finansal entegrasyon süreci ülke ekonomilerinin dünyada meydana gelen finansal olaylardan geçmişe nazaran daha hızlı bir şekilde etkilenmeleri sonucunu doğurmuştur. Bir ülke ekonomisinde meydana gelen finansal problemler sadece o ülkenin ekonomisinde bir finansal istikrarsızlığa değil bulunduğu bölgede ya da küresel ölçekte bir finansal istikrarsızlığa neden olabilmektedir (Korkmaz & Yamak, 2015: 51). Bir başka ifade ile küreselleşmenin neticesinde ülke ekonomilerinin birbirine farklı alanlardaki yakınlığından dolayı birbiri ile bağlantısı güçlenmiştir. Ülke ekonomilerinin birinde oluşacak finansal istikrarsızlık durumu tüm dünyayı etkileyecek genel bir sonuca sebebiyet verebilmektedir (Miyat vd., 2010: 120).

Finansal istikrarsızlık ekonomi için büyük maliyetlere sebebiyet verebilmektedir. Finansal kurumlarda ortaya çıkan bir finansal başarısızlık diğer finansal kurumları da etkisi altına alabilmektedir. Özellikle kaos ortamında mevduat sahipleri mevduatlarını

bankalardan çekmek için aceleci davrandığında bankaların bu mevduatları aynı anda nakde çevirmeleri mümkün olmadığından banka krizlerinin oluşmasına sebebiyet verebildiğinden finansal istikrarsızlığın maliyetine sadece bütçesel olarak bakmamak gerekir. Varlık fiyatlarındaki düşüşlerin birçok alanda etkileri bulunmaktadır. İnsanların servetlerinde meydana gelen azalmalar yaşam ve tüketim standartlarını negatif yönde etkileyebilmektedir. Toplam harcamalardaki düşüşler iflas dalgalarına ve siyasi krizlere neden olarak büyük durağanlıkların oluşmasına sebebiyet verebilir (Wyplosz, 1998: 3).

Son zamanlarda dünya genelinde artan finansal istikrarsızlığa bağlı olarak politika yapıcılar ve merkez bankası yetkilileri neyin finansal istikrara yol açtığı ve finansal istikrarsızlığının nasıl giderileceği konusuna odaklanmışlardır (Mishkin, 1997: 55). Finansal istikrarsızlık ekonomide reformların yapılması başta olmak üzere yetkililerin büyük çaplı müdahalesi yoluyla çözülebilmektedir. Daha önce 1930'larda yaşanan Büyük Buhran ile 1997-98 yılında Endonezya, Malezya, Tayland ve Rusya gibi ülkelerdeki reformlar ekonomik sistemin çöküşünü engellemek için yapılan müdahalelere örnek verilebilir (Schinasi, 2004: 10). Ancak belirtmek gerekir ki finansal istikrarsızlık sorunu sadece finansal kurumların uyması gereken bazı standartların uygulamaya konması ile çözüme kavuşmamaktadır. Finansal kurumların da düzenlenmesi ve denetlenmesini de içeren geniş çaplı bir reform paketinin sürece dahil edilmesi gerekmektedir. Özellikle özel kesimin yükümlülüklerini yerine getirmesini sağlayacak çalışmaların yapılması önem arz etmektedir (Tokucu, 2012: 209). Denilebilir ki, son yıllarda finansal krizlerin sonuçlarının yıkıcı etkileri göz önünde bulundurulduğunda finansal istikrarsızlığı meydana getiren olayların ve yayılma mekanizmalarının nasıl oluştuğuna dair çıkarımlarda bulunmanın önemi artmıştır (Ionescu, 2012: 129).

Finansal istikrarın sağlanması için devletin finansal istikrarla uyumlu makroekonomik ve yapısal politikaları izlemesi gerekmektedir. Bu politikaların finansal istikrarla uyumlu olabilmesinin göstergeleri arasında mali disiplinin sağlanması, cari işlemler dengesinin oluşturulması ve bankacılık sisteminin etkin ve sağlıklı bir şekilde yürütülmesi gösterilebilir (Göker, 2009: 16). Son birkaç on yılda, deregülasyonlar, teknolojideki ilerlemeler ve dünyada yaşanan ekonomik entegrasyon ile birlikte bankacılık sektörü giderek daha fazla küreselleşmektedir. Bankacılık sektöründe sınır ötesi sermaye akımları ve doğrudan yabancı yatırımlarda hızlı bir büyüme olmuştur (Yin, 2019: 207). Bankacılık sisteminde oluşacak finansal istikrarsızlığın sebeplerinin başında farklı katılımcıların birbirini etkileme potansiyelinin bulunması gelmektedir. Finansal kurumlarda meydana gelecek mali sorunlar çok kısa süre içinde bankaları etkileyebilir. Bu durum, kredi ve borç verme kanalları aracılığıyla ülkenin genelini etkileyen bir hal alabilmektedir. Bankacılık sektöründeki bu yayılma finansal istikrarsızlığın oluşumunu tetikleyecek bir sorun olarak tanımlanabilir. Finansal sektörde olası bu gelişmeler ayrıca sistematik risk oluşumuna da sebebiyet verebilmektedir (Acedański & Karkowska, 2022: 2).

Ülke ekonomileri için önemli roller üstlenen kamu bankalarının tarihsel geçmişi yaklaşık 600 yıl öncesine kadar gitmektedir. İlk bankalar belediye bankaları olarak Barcelona ve Cenova'da kurulmuş daha sonraki yıllarda farklı coğrafyalarda kendisini

göstermiştir. Özellikle 19. Yüzyıl sonrasında değişen dünya konjonktürüne bağlı olarak kamu bankaları da farklı siyasal, ekonomik ve sosyal işlevleri yerine getirmişlerdir (Marouis, 2022: 356). Kamu işlemlerinin faaliyet gösterdiği alanlardan birisi de finans sektörüdür. Özellikle kamunun bankacılık sektöründe önemli derecede etkisi bulunmaktadır. Kamu bankalarının temel amaçları arasında ekonomik gelişmenin desteklenmesini sağlamak, güçlü bir bankacılık sisteminin meydana gelmesine katkı sağlamak, piyasa mekanizmasında meydana gelebilecek bazı aksaklıkların giderilmesine katkı sunmak ya da sorun yaşanmadan önce bazı önlemler almak olarak sıralanabilir. Ayrıca uzun vadede oluşturulacak artı değerlerle toplumsal refahın sağlanması da katkıda bulunması beklenmektedir (Uçarkaya, 2006: 1-2). Türkiye’de ekonomik alanda kamu bankalarının süreç içerisinde önemli roller oynadığı bilinmektedir. Özellikle kalkınma sürecinde devletin rolünün artmasına bağlı olarak kamu bankalarının ekonomik kalkınmadaki etkisi de yadsınamaz boyutlara ulaşmıştır. 1959-1964 yılları arasında bankacılık sektöründe kamu bankalarının toplam aktifleri %64 seviyesine ulaşmıştır Daha sonraları yapılan farklı hamlelere dayalı olarak toplam aktifler içinde payı düşüş göstermiştir (Bumin, 2009: 20).

Bu çalışmada, 2017Q1 ve 2022Q4 yılları arasındaki çeyrek veriler kullanarak Türkiye’de faaliyet gösteren kamu sermayeli bankaların finansal istikrarının belirleyicilerini incelemek için hem bankacılık sektörüne ve devlete özgü makroekonomik hem de firmalara özgü mikroekonomik perspektiften çok yönlü ele alınarak analiz edilmiştir. Bankacılık sektörü bir bütün olarak finans sektöründen reel ekonomiye kadar geniş bir piyasa yelpazesini kapsaması nedeniyle ekonomilerin büyümesinde ve kalkınmasına merkezi ve çok önemli bir rol oynamaktadır. Bu sebeple örnekleme yer alan bankaların finansal istikrarını etkileyen makroekonomik değişkenler belirlenirken, finansal sistemi çeşitli kanallardan etkileyerek istikrarsızlık veya strese neden olabilecek ekonomik değişkenler ele alınmıştır.

Finansal istikrarsızlık değişkenlerin bankaların finansal istikrarı üzerindeki etkisini incelerken yapılan ekonometrik analizlerde panel PMG/ARDL tahminleyicisi kullanılmıştır. PMG yaklaşımı, hem dinamik bir regresyon yöntemine sahip hem de bağımsız değişkenlerin bağımlı değişken üzerinde uzun ve kısa dönem etki parametre katsayılarını birlikte sunmaktadır. Ayrıca PMG tahminleyicisi, çalışmada yer alan bütün değişkenlere ait veri setinin seviyede, birinci farkında veya her ikisinin entegrasyonu olması durumunda analiz yapmaya olanak tanınması, eşbütünleşme testlerini içermesi, veri setinin az olmasına izin vermesi gibi avantajlardan dolayı son yıllarda diğer panel yöntemlerine göre finansal ekonomi çalışmalarında daha çok tercih edilmektedir. Çalışmada sadece kamu sermayeli bankaların ele alınması, yöntem olarak dinamik bir özelliğe sahip PMG/ARDL metodolojisinin kullanılması, uzun ve kısa dönem etkilerin dışında eşbütünleşme test sonuçlarına da yer verilmesi çalışmamızı diğer çalışmalardan farklılaştırmaktadır.

Makale çalışması 5 bölüm olarak planlanmıştır. Birinci bölümde finansal istikrarsızlık kavramı teorik ele alınmıştır. İkinci bölümde çalışmada yer alan finansal istikrarsızlık değişkenleri ve ekonomi üzerindeki olası etkilerine değinilmiştir. Üçüncü bölümde, Türkiye’de ve Türkiye dışında bankaların finansal istikrarı üzerine yapılan ampirik

çalışmalar özetlenmiştir. Dördüncü bölümde, çalışmanın veri seti, model ve PMG/ARDL yaklaşımı ile finansal istikrarsızlığın bankaların istikrarı üzerindeki etkileri analiz edilerek elde edilen bulgular yorumlanmıştır. Son bölümde, çalışmanın PMG ampirik bulguları bir bütün değerlendirilerek bazı çıkarımlar ve politika önerileri yer almaktadır.

2. Çalışmada Yer Alan Finansal İstikrarsızlık Göstergeleri

Bu bölümde, çalışmanın ampirik modelinde kullanılan finansal istikrarsızlık göstergeleri ve piyasalar üzerinde olası etkileri kısaca ele alınmıştır.

2.1. Kredi Risk Primi/Kredi Temerrüt Takası (Credit Default Swap-CDS)

Son yirmi yılın en önemli finansal yeniliklerinden biri olan CDS sözleşmeleri, alınan bir kredinin ödenmeme risklerinden korunmak için piyasada aktif olarak işlem görmekte ve kullanımı giderek artmaktadır (Qiu et al., 2022: 3611). Bir CDS, CDS alıcısının, şirketlerin ve ülkelerin borç sözleşmelerinden doğan taahhütlerini yerine getirememesi durumunda temerrüde düşmesi ile zararlarını alıcıya tazmin etmeyi kabul eden satıcıya sigorta primi ödediği bir borç sigorta sözleşmesidir (Clark et al., 2023: 1). Dolayısıyla CDS'ler riski iki taraf arasında transfer eden ikili bir finansal sözleşmedir. Diğer bir ifade ile, alıcı, satıcıya CDS primi ödemekte, bunun karşılığında ise temerrüde düşen borç yükümlülüğünü satıcıya teslim etme hakkını elde etmektedir (Liu & Morley, 2012: 129).

Günümüzde CDS sözleşmeleri, katılımcılar arasında kredi riskinin transferine izin veren ve potansiyel olarak kredi riskinin fiyatlanmasında ve dağıtımında etkinliği daha fazla kolaylaştıran finansal araçlar haline gelmiştir (Bomfim, 2022: 1). CDS primlerinin doğrudan ülke kredi piyasasına ait risk değerlendirmesini yansıttığı piyasa katılımcıları tarafından yaygın olarak kabul edilmektedir. Bir ülkenin temerrüde düşmesi veya borcunu yeniden yapılandırması durumunda ülke borcundaki kayıplara karşı yatırımcıların koruma satın almalarına izin veren CDS sözleşmelerine ödemesi gereken risk primi ülkenin kredi riskinin niteliğinden etkilenmektedir. Çünkü ülke kredi riski, ülke borç piyasalarındaki getirilerin özelliklerini belirlediğinden, yatırımcıların, bankaların ve diğer finansal kurumların küresel borç portföylerinin riskini çeşitlendirme kabiliyetini doğrudan etkilediği için çok önemlidir (Longstaff et al., 2007).

Ülke CDS piyasasına ait marjlar, piyasa koşullarındaki dinamikleri anlamak, portföy yatırımları arayan uluslararası yatırımcılar, kredi riski yönetimi ve riskten korunma stratejileri arayan yabancı borçlular için hayati önem taşımaktadır (Naifar, 2020). CDS notunun yükselmesi ülke riskinin arttığı, düşüş eğiliminde olması ise riskin azaldığı şeklinde yorumlanmaktadır. CDS piyasasında kredi risk seviyesinin yükselmesi likidite bulma riskinden doğabilecek kısa vadeli paranın maliyetini artırmaktadır. Devlet kredi temerrüt takaslarının yatırımcıların karar vermesi ve finansal piyasaların istikrarı üzerindeki önemli etkilerinden yola çıkarak bu çalışmanın veri setine dahil edilen Türkiye'nin 3 yıllık CDS verileri, küresel piyasalarla ilgili dünya çapında bilgi, analiz ve veri hizmeti sunan <investing.com> internet sitesinin finansal platformundan alınmıştır.

2.2. Finansal Baskı Endeksi/Finansal Stres Endeksi (Financial Pressure Index-FBI)

Finansal baskı veya finansal stres, finansal piyasa faaliyetlerindeki istikrarsızlık, kırılabilirlik ve finansal varlık fiyatlarında yaşanan kayıplar ile bir ülkenin finansal koşullarının olumsuz etkilenmesi yoluyla ekonomik birimler üzerinde uygulanan güç veya meydana gelen stres olarak tanımlanmaktadır (Illing & Liu, 2003: 1). Finansal baskıyı, finansal piyasalarda ve finansal aracılık faaliyetlerinde olumsuz gelişmelerin hâkim olması ve bundan dolayı piyasanın işleyişinin sekteye uğraması şeklinde de tanımlayabiliriz (Elekdağ vd., 2010: 3). Balakrishnan vd. (2011: 44) ise finansal stres dönemini, finansal sistemin baskı altında olduğu ve aracılık etme yeteneğinin bozulduğu bir dönem olarak tanımlamaktadırlar.

Finansal baskı endeksleri (Financial Pressure Index-FBI), bir ülkenin finansal piyasalarında zorlanma, stres veya sağlıklı bir şekilde işleyip işlemediği veya davranıp davranmadığı hakkında politika yapıcılara bilgi sağlamaktadır. Hakkio ve Keeton (2009) piyasa katılımcıları arasında varlıkların gerçek değeri hakkında artan belirsizlik, artan bilgi asimetrisi ve likiditenin finansal stres ile ilişkili olduğuna dikkat çekmektedirler. Bu gelişmelerin tümü piyasanın işleyişini azaltmakta, istikrarı bozmakta ve kırılabilirliği artırmaktadır. Piyasanın işleyişinin veya istikrarının bozulması, finansal işlemlerin yürütülmesinde artan zorluk veya finansal araçların piyasa yapıcı faaliyetlerini olağan vadelere finanse edememesi şeklinde gerçekleşmektedir. Dolayısıyla bir FBI, döviz krizi özelinden yola çıkarak finansal piyasaların işleyişi veya kırılabilirliği hakkındaki eğilimleri çözmeyi, yakalamayı, biçimlendirmeyi veya özetlemeyi amaçlamaktadır (Carlson et al., 2014: 60). Bu nedenle politika yapıcılar, finansal istikrarı izlemek için finansal baskı endeksleri de dahil olmak üzere çeşitli ölçüm araçları kullanarak finansal krizleri önlemeye çalışırlar. Bu açıdan mevcut zamanda meydana gelebilecek gelişmelere odaklanan finansal baskı endeksleri, günümüzde politika yapıcılar tarafından finansal istikrarı izlemek için bir araç olarak yaygın bir şekilde kullanılmaktadır (Vermeulen et al., 2015).

Finansal sistemin sağlamlığının izlenmesi ve denetlenmesi hem para hem de maliye otoritesi açısından büyük önem arz etmektedir. Özellikle finansal stresin ayrıntılı bir analizinin yapılması daha geniş bir mikro ve makro ihtiyati politika çerçevesinde önemli bir araç teşkil etmektedir. Finansal sistemin izlenmesi ve denetlenmesinin yanı sıra, finansal şokların ekonomi üzerindeki etkilerini anlamak için finansal stres analizi önemli bir sinyal görevi görmektedir. İktisat teorisi, finansal stresteki artışların özel sektör yatırım ve tüketim davranışlarının değişmesine yol açtığını ileri sürmektedir. Yatırım kanalından gelen etkiler, uzun vadeli faiz oranları ve sermayenin kullanım maliyetlerinden kaynaklanırken, tüketim kanalından gelen etkiler ise esas olarak servet ve gelir etkilerinden kaynaklanmaktadır. Bu gelişmeler ile birlikte piyasa katılımcılarının daha yüksek risk algısına sahip olması ve belirsizliğin artması ekonomik sistemde bir gerilemeye neden olabilir (Aboura & van Roye, 2017: 58). Bu çerçevede finansal stres, piyasalarda daralma, endişe, finansal kriz, krizlerin ekonomide yayılımı gibi ekonomik olayları izlemek veya sinyal almak için stresin ölçülmesi hem makro ekonomik politikaların işleyişinde ve alınacak kararlar açısından hem de teorik

ve ampirik yazında önemli bir nicel gösterge olarak görülmektedir (Yılmaz & Bulut, 2022: 157).

2.3. Toplam Kredi Hacmi

Finansal sistemin en önemli kurumları olan bankalar, ekonomik birimlerin (hane halkı, devlet, işletmeler) fon ihtiyacını kredi kanalı yoluyla karşılamaya aracılık etmektedirler. Ayrıca politika yapıcılar da ekonomik sisteme yön verirken parasal aktarım mekanizması içerisinde bankalar tarafından sağlanan kredi kanalından yararlanmaktadırlar. Bu açıdan kredi kanalı, merkez bankalarının parasal aktarım mekanizmasında para politikası ile reel ekonomi arasındaki etkileşimi sağlamada önemli bir işlev görmektedir. Ancak bankalar, piyasa çarklarının devinimi için ekonomik sistemde yer alan birimlerin yatırım ve tüketim harcamalarını finanse ederken, kredi kanalıyla sağlanan aşırı likidite üretiminin ekonomik dengenin bozulmasını tetikleyebileceğini göz önünde bulundurarak rasyonel bir zeminde hareket etmelidirler. Zira, ülkede istihdamın azalması, enflasyonun artması ile alım gücünün düşmesi, piyasada likiditenin azalması, işletmelerin ve hane halkının finansal kurumlara olan mevcut ödeme yükümlülüklerini yerine getirmeyerek borç yüklerinin artması gibi ekonominin genel sağlığının bozulması krediye olan talebi daha da genişletir.

Serbest piyasa ekonomilerinde finansal sistemin devinimi için başvuru likidite üretimi, tüm finansal aracılık teorilerinin merkezinde yer almaktadır. Bunun birinci nedeni; bankaların asimetrik bilgiyi işlemeleri ve varlık dönüştürme işlevleri aracılığıyla likidite üretmelerine izin verilmesidir (Diamond & Dybvig, 1983). İkincisi; bankalar borç alanlara kredi limitleri şeklinde ve mevduat sahiplerine talep üzerine fon sağlayarak likidite sağlamaktadır. Bu işlevler, bankaları, borçlulardan gelen aşırı likidite talebindeki sistematik artışlara karşı savunmasız bırakması ile mevduat sahiplerinin bankalara hücum etmelerine neden olabilir. Ayrıca, borçlulardan gelen likidite talebindeki sistematik artışlar dış piyasa koşullarına bağlı olduğundan bireysel bankaların içsel imkanları ile bu durumu yönetmesi çok zor olmaktadır. Çünkü Diamond ve Rajan (2001) bankaların borçlulara kredi ile likidite sağlarken bu kredilerin bankalar için nispeten likit olmayan varlıklar olduğunu belirtmektedirler (Cornett et al., 2011: 300-301).

Krugman (1979), sabit bir döviz kuru altında para talebindeki büyümeyi aşan yurt içi kredi genişlemesinin, uluslararası rezervlerde kademeli fakat kalıcı bir kayba neden olduğunu ve nihayetinde para birimine yönelik spekülasyon bir baskına yol açacağını belirtmektedir. Bu baskın rezervleri anında tüketir ve yetkilileri pariteyi terk etmeye zorlar. Bu istikrarsızlık durumu, bir döviz krizinden önceki dönemin uluslararası rezervlerde kademeli ancak kalıcı bir düşüş ve para talebine göre yerel kredide hızlı bir büyüme ile karakterize edileceğini göstermektedir. Ayrıca, aşırı para üretilmesi ile kamu sektörünü finanse etme ihtiyacı, mali dengesizlikler ve kamu sektörüne verilen krediler de yaklaşmakta olan bir kriz öncü göstergesi olabilir. Bu sonuçlar, genişletici maliye ve kredi politikalarının ticari mallar ve ticaret dışı mallar için daha yüksek talebe yol açarak ticari dengenin bozulmasına neden olmaktadır. Ayrıca ekonomi politikalarına yön veren yetkililerin pariteyi savunmak için sürdürmeye istekli oldukları kredi politikası veya rezerv kayıplarının seviyesi

hakkında belirsizlik getiren sonuçlar da aynı zamanda kriz olasılığı arttıkça yurt içi faiz oranlarının artacağını göstermektedir. Dolayısıyla bu modeller, reel döviz kurunun, ticaret veya cari işlemler dengesinin, reel ücretlerin ve yurt içi faiz oranlarının gelişiminin krizlerin öncü göstergeleri olarak kullanılabileceğini önermektedir (Kaminsky et al., 1998: 4).

2010’da kabul edilen bankacılık sektörünü düzenlemeye yönelik Basel III reformlarında, önceki sermaye düzenlemesinin potansiyel döngüsellliğini azaltmayı amaçlayan önemli bir makro ihtiyati unsur yer almaktadır. Basel Bankacılık Denetim Komitesi (The Basel Committee on Banking Supervision-BCBS), bankacılık sektöründeki aşırı kredi büyümesini genellikle sistematik riskteki büyümeyle ilişkilendirmektedir. Bu açıdan komite, bankaları aşırı kredi büyümesi dönemlerinden korumayı amaçlayan bir “döngü karşıtı sermaye tamponu” getirmiştir. Çünkü 2008 küresel finans krizinde bankacılık sektöründe meydana gelen kayıpların, verilen kredilerde bir gerileme olmadan önce aşırı bir kredi büyümesi döneminde son derece büyük olabileceğini açık bir şekilde tekrar göstermiştir. Bu kayıplar bankacılık sektöründe istikrarsızlık, finansal sistemdeki sorunların reel ekonomide gerilemeye ve ardından bankacılık sektörünü de içine alacak genişlikte bir kısır döngüye neden olabilir (BCBS, 2010: 8).

Aşırı kredi büyümesi birçok yönden makroekonomik istikrarı tehdit edebilir. Borç vermenin tüketimi desteklediği göz önüne alındığında; özel sektör kredilerindeki büyüme toplam talebi potansiyel üretim sisteminin ötesinde aşırı uyarabilir ve enflasyon, cari işlemler açığı, faiz oranları ve reel döviz kuru üzerinde zincirleme etkilerle ekonominin aşırı ısınmasına neden olabilir. Aynı zamanda, borç veren kurumlar, ekonomik büyüme aşamasında borç alanların gelecekteki borçlarını geri ödeme yetenekleri hakkında aşırı iyimser beklentilere sahip olabilir ve bu nedenle sıklıkla yüksek riskli borç alanlara borç verebilir. Sonuç olarak, potansiyel kötü kredilerin büyük bir kısmı, kredi döngüsünün aşırı seviyelerinde ortaya çıkmaktadır. Örneğin 2009 sonu itibarıyla bazı Orta ve Doğu Avrupa ülkelerinde yabancı faiz oranlarının daha düşük olması nedeniyle özel krediler döviz cinsinden sağlanmıştır. Steiner’e (2011) göre bu durum bankacılık sektörü için riskleri daha da artırmaktadır. Çünkü yerli para birimi ile borç ödeme maliyetleri yükselir ve kur riski kredi riskine döner. Bu nedenle gerek yerli gerekse yabancı para cinsinden kredi büyümesinin kontrol altına alınması ekonomik sistemin sağlıklı işlemesi için elzem bir durum teşkil etmektedir (Geršl & Seidler, 2010: 113-114).

2.4. Takipteki Krediler

Takipteki krediler, finansman ihtiyacı olan borçlulara verilen ve vadesinde ödenmediği için devam eden bir endişe kaynağı olan, düzgün bir şekilde yönetilirse sorunsuz bir duruma geri dönebilen kredileri ve artık aktif olarak faaliyet göstermeyen iflas halindeki firmalara verilen kredileri içermektedir. Takipteki krediler nispeten durgundur, değer biçilmesi zordur ve bu nedenle likit bir varlık değildir ve genel olarak sabit bir getiri sağlamadıkları için bankaların diğer dinamikleri eşit olduğunda büyük oranda takipteki kredi hacmine sahip bankalar daha az kârlı, göreceli riskli olarak algılanacak hem sermaye hem de likidite piyasalarına erişimde zorluklarla karşılaşabilecekleri için de risk primi öderler.

Ayrıca yüksek takipteki alacaklar aynı zamanda bankaların daha yüksek borç vermesine neden olabilir. Zayıf bilançolar ilke olarak bankaları "yeniden canlanmak için riske atmak" mantığıyla daha az yerine daha fazla borç vermeye teşvik edebilir (Angelini, 2018).

Bir bankanın finansal performansı ve sahip olduğu varlıkların kalitesi bankanın sağlıklı bir şekilde faaliyet göstermesinin önemli boyutunu oluşturmaktadır. Varlık portföyü kalitesine yönelik en büyük tehdit, bankalardan kredi alanların finansal taahhütlerini yerine getirme yeteneklerini kaybederek temerrüde düşen takipteki alacaklarda meydana gelen artışlardır. Takipteki alacaklarda yaşanan bu gelişme bankaların finansal istikrarının azalması ile sonuçlanabilir (Al-Khazali & Mirzaei, 2017: 193-164).

Yüksek takipteki kredi stokları bankaların borç verme kabiliyetini sınırlayarak parasal aktarım mekanizmasını bozabilecek tehditler içermeye özelliğine sahip olmasından dolayı bankacılık sektörüne ait denetim otoriteleri bu sorunun etkin yönetimini büyük bir önemle ele almalıdırlar (Bolognesi et al., 2020). Takipteki alacakların büyüklüğü, banka iflaslarıyla bağlantılı olduğu ve genellikle bankacılık krizlerinin habercisi olduğu için hem düzenleyiciler hem de bankalar için ilgi odağında yer almaktadır. Bankaların kredi portföylerinde takipteki alacakların payının artması, bankaların hem likiditesini hem de kârlılığını etkileyen daha büyük risklere işaret etmektedir. Ayrıca, bankaların kötüleşen bilançosunu da temsil etmektedir (Ghosh, 2015: 93).

Son küresel finans krizinde (2008 Mortgage Krizi) bankaların bilançolarındaki takipteki kredilerde yaşanan artışlar finansal piyasalarla ilgili ilk olarak göze çarpan önemli bir özellik olmuştur. TKO stoklarındaki keskin artış, bankaları önemli kredi riskleriyle karşı karşıya bırakmaktadır. Bunun yanında bankaların kredi sağlama kabiliyetini de bozar ve genel ekonomi üzerinde olumsuz bir etki bırakabilir. Takipteki alacakların gerek bankacılık sektör bilançolarında gerekse makroekonomik riskler üzerindeki etkisinin incelenmesi, bankacılık piyasasına ilişkin düzenlemelerin bir ülkenin finansal yapısı üzerindeki olumsuz etkisini iyileştirecek şekilde değiştirmesine yardımcı olabilir. Örneğin, takipteki kredilerin nispeten hızlı bir şekilde değiştirilmesini ve bankaların sorunlu kredi portföyünün temizlenmesine yönelik teşvik eden politikaların yürürlüğe konulması durumunda hem bankaların finansal sıkıntı dönemlerini daha iyi atlattırmasına yardımcı olabilir hem de ekonomik sistemi takipteki kredilerin sonuçlarına tepki vermede daha dirençli hale getirebilir (Ghosh, 2017: 29-30).

Sonuç olarak takipteki krediler, ekonomik sistemin işleyişinde yer alan tüm birimlerin finansman ihtiyacını karşılamak için adeta bir katalizör gibi işlev gören finansal sektörün istikrarı üzerinde önemli bir rol oynamaktadır. Özellikle gelişmekte olan ekonomilerde yatırım ve büyüme için krediye olan duyarlılığının fazla olması, o ülkelerin finansal piyasalarında yaşanacak bir istikrarsızlık ülke ekonomileri için önemli makroekonomik sorunlara neden olmaktadır. Bankacılık sisteminde takipteki kredilerde yaşanacak önemli artışlar reel sektör ve hane halkına sunulan kredi arzının azalmasına neden olur. Bu hususlara ek olarak, takipteki kredi miktarındaki artışlar, bankaların finansal sermayesini azaltarak finansal sistemi kredi riskine sürüklemesi, bankacılık sektöründe

verimliliği düşürerek iflas veya krizleri tetiklemesi, likidite açığı ile ekonomik sistemi zayıflatarak yatırımların önemli derecede azalması ile sonuçlanabilir.

3. Literatür Araştırması: Bankacılık ve Finansal İstikrar (Z-Skor)

Bu bölümde, çalışmamızda kullandığımız Z-Skor yöntemini Türkiye’de ve Türkiye dışında bankacılık sektörünün finansal istikrarı için kullanarak yapılmış ampirik çalışmaların kısa özetlerine yer verilmiştir.

Samet vd. (2018) kamu ve özel sektör bankalarının finansal risk alma durumlarını kurumsal sınıflandırılmış uluslararası örneklemeler üzerinden incelemişlerdir. Yapılan çalışmada 2000-2015 yılları arası 581’i kamu ve 6.235’i özel olmak üzere 85 ülkeden 6.816 ticari banka risk ölçümü aracı olarak Z-Skor kullanılarak ele alınmış ve neticede kamu bankalarının özel sektör bankalarına göre daha az riskli faaliyetlerde buldukları tespit edilmiştir. Ayrıca, halka açık bankaların 2008 kriz öncesi ve kriz sonrasında özel bankalara kıyasla daha az, ancak kriz sonrasında tüm ülkelerde daha fazla risk alma faaliyetlerinde buldukları tespit edilmiştir.

Ekinci ve Kök (2020), 26 Avrupa Birliği üyesi olan ülkelere ait 156 bankanın 2006-2014 dönemine ait verilerini kullanarak rekabet (Lerner ve Boone indeksi) ile istikrar (Z-Skor) arasındaki ilişkiyi analiz etmişlerdir. GMM yöntemi kullanılarak yapılan analizlerde elde edilen bulgularda, rekabet gücü ile bankaların finansal istikrarını temsil eden Z-Skor arasında pozitif yönde bir ilişkinin olduğu görülmüştür.

Louhichi vd. (2020) yaptıkları çalışmada bankalar için yapılan regülasyonların bankaların risk almasındaki etkisini Orta Doğu ve Asya’da faaliyet gösteren 123 İslami ve Konvansiyonel bankanın 10 yıllık verileri üzerinden panel veri analizi kullanarak hesaplamışlardır. Elde ettikleri bulgulara göre, bankacılık piyasa gücü sermaye düzenlemesi bankaların risk alması üzerindeki olumsuz etkisini güçlendirmektedir. Ayrıca bankaların piyasalarda güçlü hale geldikçe faaliyet kısıtlamalarının istikrar üzerindeki olumsuz etkisi de azalmaktadır.

Hoque ve Liu (2023) Basel komitesinin bankacılık sektörüyle ilgili düzenlemelerin 2004-2015 döneminde İslami ve konvansiyonel bankaların finansal riskleri (Z-skor) üzerinde etkisi olup olmadığını incelemişler. OLS regresyon yöntemi kullanılarak yapılan analiz sonuçlarında, açık ekonomi politikaları ve bankacılık denetimi kombinasyonunun, bankacılık sektöründeki riskleri önemli düzeyde etkilediği görülmüştür. Ayrıca bankacılık alanında yapılan düzenlemeler, 2007-2009 krizi sırasında örneklemde yer alan konvansiyonel ve İslami bankaların finansal riskini önleyemediği tespit edilmiştir. Araştırmacılar elde edilen bulgulardan yola çıkarak, Basel komitesinin kriz zamanlarında bankacılık düzenlemelerini yeniden ele alması gerektiği tavsiyesinde bulunmuşlardır.

Atellu vd. (2021) yaptıkları çalışmada Kenya’da gerçekleştirilen banka düzenlemelerin finansal istikrar üzerindeki etkisini ortaya koymayı amaçlamışlardır. Makro ve mikro ihtiyati düzenlemelerin finansal istikrar üzerindeki etkisini belirleyebilmek için

1990-2017 yılları arasında yapısal eşitlik modeli kullanılmış ve elde edilen bulgulara göre makro ve mikro ihtiyati düzenlemelerin finansal istikrarın sağlanmasında önemli bir unsur olduğu belirlenmiştir.

Ahsan ve Oureshi (2022) yaptıkları çalışmada bir İslami bankacılık endeksi geliştirmiş ve 2010-2018 yılları arasında 23 ülkeden topladığı 3542 veri ile oluşturduğu indeks üzerinden söz konusu ülkelerdeki İslami ve geleneksel bankaların performanslarını GMM yöntemi uygulayarak test etmişlerdir. Elde ettikleri bulgulara göre İslami finansın gelişiminin İslami bankaları destekleyici bir ortamı sağladığı sonucuna ulaşmışlardır.

Ece ve Çadircı (2022), kredi portföy yoğunlaşması ile Türkiye'de faaliyet gösteren ticari ve katılım bankalarının finansal istikrarı (Z-Skor) üzerindeki etkisini incelemişlerdir. Çalışmada örnekleme yer alan bankaların Ocak 2005-Aralık 2021 dönemine ait veri seti kullanılarak uzun dönem, kısa dönem etkiler ARDL, FMOLS, DOLS ve CCR eşbütünleşme testleri ile analiz etmişlerdir. Ampirik bulgularda, kredi portföy yoğunlaşması uzun dönemde ticari bankaların Z-Skor değerini negatif etkilediği, kısa dönemde ise hem negatif hem de pozitif yönde etkilere sahip olduğu görülmüştür. Örnekleme yer alan katılım bankalarına ait bulgularda ise, kredi portföy yoğunlaşmasına ait çeşitlendirmenin uzun dönemde etkisi anlamlı bulunmazken, kısa dönemde Z-Skor değerini anlamlı olarak artırdığı tespit edilmiştir. Sonuç olarak, kredi portföy çeşitlendirmesinin hem uzun dönemde hem de kısa dönemde bankaların istikrarı üzerindeki etkisinin çok önemli olmadığı ve incelenen banka gruplarında farklılaşma görülmemiştir.

Tunalı-Sarı (2023), Türk bankacılık sektöründe regülasyonların finansal istikrar üzerindeki etkisini test etmiştir. ARDL yönteminin kullanıldığı çalışmada aktif kalitesi, sermaye yeterlilik standart rasyosu, kaldıraç ve yabancı net pozisyonu bağımsız değişkenler, Z-Skor değeri ise bağımlı değişken olarak alınmıştır. 2010Q2-2022Q3 dönemine ait veri seti kullanılarak yapılan analizde, uzun dönemde geleneksel (ticari veya mevduat) bankalarda yabancı net pozisyonu her iki banka grubunun Z-Skor değerini pozitif ve anlamlı etkilemiştir. Aktif kalitesi katılım (Faizsiz, İslami) bankalarında etkisi pozitif ve anlamlı, sermaye yeterlilik standart rasyosu ise katılım bankalarına etkisi pozitif ve anlamlı bulunmuştur. Kısa dönemde ise, geleneksel bankalarda aktif kalitesinin gecikmeli değerleri pozitif ve negatif, sermaye yeterlilik rasyosu pozitif, katılım bankalarında ise kaldıraç negatif ve anlamlı bulunmuştur. Tüm bankalar modele alındığında, sadece uzun dönemde aktif kalitesi pozitif, kaldıraç ise Z-Skoru negatif ve anlamlı etkilemiştir.

Bankacılık sektörünün finansal istikrarı için Z-Skor değerinin vekil değişken olarak alındığı bazı çalışmaların kısa özetlerinin verildiği literatür araştırmasında da görüldüğü üzere Ece ve Çadircı (2022) kredi portföy yoğunlaşması, Tunalı Sarı ise (2023) bankacılık sektöründe yapılan çeşitli regülasyonların Türkiye'de faaliyet gösteren bankaların Z-Skor değerleri üzerindeki etkisini incelemişlerdir. Bu bağlamda gerek analizde kullandığımız yöntem gerek kullanılan bağımsız değişkenler gerekse kamu sermayeli bankaların finansal istikrarı özelinde bir çalışmanın yapılmaması çalışmamızı literatürden farklılaştırarak özgün kılmaktadır.

4. Metodoloji

4.1. Veri Seti

Bu çalışmada, Türkiye örnekleminde yola çıkarak piyasalarda finansal istikrarsızlığı temsil eden çeşitli göstergeler ile kamu sermayeli bankaların finansal istikrarı arasındaki nedensel ilişkiyi incelemek amaçlanmıştır. Bankacılık sektörü piyasaya sundukları krediler ile özellikle firmalar olmak üzere tüm ekonomik birimler için önemli bir dış finansman kaynağıdır. Bankacılık sektörünün ekonomik faaliyetleri canlandırmadaki rolü dikkate alındığında finansal açıdan istikrarlı olmaları önem arz etmektedir.

Finansal istikrarsızlık göstergeleri ile kamu sermayeli bankaların finansal istikrarı arasındaki ilişkiyi incelemek için 2017Q1-2022Q4 dönemine ait çeyreklik (Quarterly-Q) zaman serisi verileri kullanılmıştır. Bu çalışma için bağımlı değişken olarak Halk Bankası A.Ş., Vakıfbank A.Ş., Ziraat Bankası A.Ş., Ziraat Katılım A.Ş. ve Vakıf Katılım A.Ş. olmak üzere inceleme döneminde verileri süreklilik arz eden 5 kamu bankasının tarafımızca hesaplanan finansal istikrar göstergesi (Z-SKOR) vekil değişken olarak alınmıştır. Ampirik modelde Türkiye'nin 3 yıllık risk primi (CDS), Türkiye için hesaplanan finansal baskı endeksi (FBE), toplam yurtiçi kredi hacmi (TKYH) ve takipteki kredilerin toplam kredilere oranı (TKO) göstergeleri ise finansal istikrarsızlığa vekil olarak alınmıştır. Ayrıca ilgili bankaların büyüklüklerini de dikkate almak için toplam aktifleri (AKTF) ile finansal kaldıraçları (KLDRC) modele kontrol değişkeni olarak dahil edilmiştir. Çalışmada kullanılan veri setine ait açıklamalar Tablo 1'de sunulmuştur.

Tablo: 1
Veri Seti ve Açıklamaları

Değişken	Açıklama	Kaynak	Beklenen Etki
Z-SKOR	Bankalar için hesaplanan finansal istikrar göstergesi	KAP	
CDS	Türkiye'nin 3 yıllık risk primi	INVESTING	-
FBI	Türkiye için hesaplanan finansal baskı endeksi	TCMB	-
TYKH	Toplam yurtiçi kredi hacmi	TCMB	-
TKO	Takipteki kredilerin toplam kredilere oranı	BDDK	-
AKTF	Bankaların toplam aktifleri	KAP	+
KLDRC	Bankaların finansal kaldıraçları	KAP	-

Çalışmanın veri setinde yer alan değişkenlere ait açıklamaların yer aldığı Tablo 1'de bankaların finansal istikrarını temsilen Z-Skor değeri kullanılmıştır. Bu makalede, bankaların finansal istikrarına vekil olarak alınan Z-Skor değeri De Nicolo vd. (2006), Çihâk ve Hesse (2010), Lepetit ve Strobel (2013, 2015), Ekinci ve Kök (2020), Louhichi vd. (2020), Hoque ve Liu (2023), Ece ve Çadircı'nın (2022) çalışması dikkate alınarak formül 1'deki matematiksel yöntem kullanılarak hesaplanmıştır. Z-Skor hesaplama formülünde yer alan "i" bankaları, "t" çeyrek dönemlik zamanı, "σ" ise standart sapmayı temsil etmektedir.

$$Z - Skor_{i,t} = \left(\frac{\text{dönem sonu net kâr}_{i,t}}{\text{aktifler}_{i,t}} + \frac{\text{özkaynaklar}_{i,t}}{\text{aktifler}_{i,t}} \right) / \sigma \left(\frac{\text{dönem sonu net kâr}_{i,t}}{\text{aktifler}_{i,t}} \right) \quad (1)$$

Z-Skor, ampirik bankacılık literatüründe bir bankanın iflas olasılığını yansıtmak için yaygın olarak kullanılan bir risk göstergesidir. Bankacılık sektörüne yönelik olarak

kullanılan risk ölçümleri genellikle Boyd ve Graham (1986), Hannan ve Hanweck (1988) ve Boyd vd.'ne (1993) atfedilir ve hem bireysel banka riskinin hem de genel finansal istikrarın değerlendirilmesinde önemli bir rol oynamaktadır. Basit olması ve sadece muhasebe bilgileri kullanılarak hesaplanması nedeniyle kesitsel araştırmalarda Z-Skorun kullanımı yaygınlaşmıştır. Ayrıca piyasaya dayalı risk önlemlerinin aksine, önemli sayıda halka açık olmayan finansal kuruluşların finansal istikrarını ölçmek için de geçerli bir göstergedir (Lepetit & Strobel, 2013: 73).

Z-Skor değerinin yüksek olması bankanın finansal istikrarının yüksek ve iflas riskinin düşük, değer düşük olması ise bankanın finansal istikrarının zayıf ve iflas riskine maruz kalma olasılığının yüksek olduğunu göstermektedir (Boyd & Runkle, 1993; Hoque & Liu, 2023). Başka bir ifade ile Z-Skor değeri, bir bankanın finansal açıdan yükümlülüklerini yerine getirememeye riskinden ne kadar uzaklaştığını gösteren bir finansal istikrar ölçütüdür (Laeven & Levine, 2009; Beck et al., 2013). Bir ülkede hem ekonomik büyümeyi desteklemek hem de yatırımları teşvik etmek için finansal hizmetler sisteminde bir aracı olarak işlev gören bankacılık sektörünün performansı tartışmasız olarak tüm piyasa paydaşları açısından çok büyük önem arz etmektedir (Menicucci & Paolucci, 2021). Sonuç olarak, hükümetlerin ekonomi kurmayları ve merkez bankaları yöneticileri ekonomik aktivitede önemli rol oynayan bankacılık sektörünün finansal istikrarına büyük önem vermektedirler (Saliba et al., 2023: 3).

Devlet kredi temerrüt takaslarının yatırımcıların karar vermesi ve finansal piyasaların istikrarı üzerindeki önemli etkilerinden yola çıkarak bu çalışmanın veri setine dahil edilen Türkiye'nin 3 yıllık CDS verileri, küresel piyasalarla ilgili dünya çapında bilgi, analiz ve veri hizmeti sunan investing.com internet sitesinin finansal platformundan alınmıştır.

Bu çalışmada finansal istikrarsızlığın bankaların finansal istikrarı üzerindeki etkisini incelerken, piyasalarda döviz krizleri özelinden ekonomik ve finansal krizleri öngörmek için Kaminsky vd. (1998: 42) tarafından geliştirilen FBI göstergesi kullanılmıştır. Yazarlar çalışmalarında aşağıdaki formülde yer alan üç farklı ekonomik değişken kullanarak FBI'yi hesaplamışlardır.

$$FBI_t = w1.e_t + w2.r_t - w3.ir_t \quad (2)$$

Formül 2'de yer alan "e" döviz kurundaki üç aylık yüzdellik değişim "r" bankalarca açılan mevduatlara uygulanan ağırlıklı ortalama faiz oranındaki üç aylık yüzdellik değişim "ir" uluslararası rezervlerdeki üç aylık yüzdellik değişimdir. Eichengreen vd. (1996) yaptıkları çalışmada farklı ağırlıkların ampirik sonuçlar üzerinde önemli bir etkiye sahip olmadığını gösterdiğinden ve ideal olarak zaman içinde değişecek olan ağırlıkları tahmin etme gerekliliğinden kaçınmak için formülde yer alan ağırlık katsayıları $w1 = w2 = w3 = 1$ olarak standardize edilmiştir (Krkoska, 2001: 43).

FBI değerinin aşağı yönlü hareket etmesi piyasadaki stresin azalmakta olduğunu, yukarı yönlü hareket etme eğiliminde olması finansal piyasada baskının olduğuna işaret

etmektedir. Makale çalışmamızda kullanılan FBI endeksi sırasıyla, döviz kuru fiyatlaması, faiz oranı ve uluslararası rezervlerdeki değişim olmak üzere üç adet finansal serinin davranışına dayanmaktadır. Ayrıca Türkiye için hesaplanan bu endekste yer alan üç temel ekonomik özellik ile, risk, belirsizlik, likidite ve bankacılık piyasasının sağlığına ilişkin olumsuz durumları yakalamakla da ilişkilidir. FBI'yi hesaplamak için 2'nolu matematiksel denklemde yer alan finansal göstergeler EVDS'den alınarak yazarlar tarafından hesaplanmıştır.

Çalışmanın ampirik modelinde kullanılan toplam yurtiçi kredi hacmi, Türkiye'de bankacılık sektörünün yurtiçinde bireysel ve kurumsal yatırımcılara verdiği toplam kredi hacmi verileridir. Tablo 1'de yer aldığı üzere TYKH'nın verileri EVDS tarafından online ortamda kamuya sunulan veri paylaşım platformundan alınmıştır.

Takipteki kredilerin oranı (bundan sonra TKO denilecek), bankaların kullandırdıkları kredilerin kısmen veya tamamen tahsil süresi 90 gün veya daha fazla aşarak faiz ve anapara ödemeleri temerrüde düşen ve tahakkuk edilmeyen kredilerin toplamının, brüt toplam kredilere bölünmesidir. Çalışmada kullanılan TKO verileri, kısaca tasarruf sahiplerinin hak ve menfaatlerini güvence altına almak ve finansal kurumların sağlıklı, etkin ve rekabet edebilir şekilde faaliyetlerini yürütebilmeleri için bir kamu kurumu statüsüne sahip olan Bankacılık Düzenleme ve Denetleme Kurumu'nun (BDDK) internet sayfasından alınmıştır. BDDK'nın aylık kredi istatistiklerini paylaştığı takipteki alacakların (brüt) toplam nakdi kredilere oranı rasyosunun 3 aylık ortalaması alınarak ekonometrik analize dahil edilmiştir.

AKTF; bankaların toplam aktiflerinin doğal logaritması, KLDRC; bankaların toplam aktiflerinin özkaynaklara oranıdır. İnceleme kapsamında yer alan bankaların Z-SKOR, AKTF ve KLDRC değişkenlerine ait verilerin yer aldığı finansal tablolar, sermaye piyasası ve borsa mevzuatı uyarınca kamuya açıklanması için gerekli paylaşımların elektronik olarak yayımlandığı ve kamuya duyurulduğu Kamuyu Aydınlatma Platformu'nun (KAP) internet sayfasından alınarak matematiksel oranlar ile yazarlar tarafından hesaplanmıştır.

Genel finansal durum açısından bir bankayı sektörde önemli kılan göstergelerden biri bankanın sahip olduğu toplam aktiflerdir. Ekonometrik modelde banka büyüklüğünü temsilen aktif toplamının doğal logaritması vekil değişken olarak araştırmanın ampirik analizinde kontrol değişkeni olarak yer almaktadır. Finansal analiz yazınında özellikle bankacılık sektörü için farklı şekillerde hesaplanan kaldıraç oranı için aktiflerin özkaynaklara oranı en yaygın olarak kullanılan tanımdır. Bu oran hem firmaların varlıklarını finanse etmek için kullandıkları kaynakları hem de yükümlülüklerini ödeyebilme kabiliyetine yönelik olarak bilgi almak için hesaplanan önemli bir finansal göstergedir. Bu açıdan kaldıraç oranı da bankaların sınıflandırılmasına olanak sağlayan niteliksel özelliğe sahip finansal bir değer olarak kabul edilmektedir.

4.2. Ampirik Analiz ve Bulgular

Makale çalışmamızın bu bölümünde, Türkiye'ye ait finansal istikrar göstergelerinin finansal hizmetler sektöründe faaliyet gösteren kamu sermayeli bankaların finansal istikrarı arasında ampirik olarak yapılan analizlerde gözlemlenen bulgular ve yorumlar yer almaktadır.

4.2.1. Tanımlayıcı İstatistikler ve Birim Kök Analizi

Bu çalışma için kullanılacak ekonometrik tahminleyiciyi belirleyebilmek için modelde yer alan değişkenlerimizin istatistiksel özelliklerini test etmek için ilgili prosedürü takip ediyoruz. İlk olarak, değişkenlere ait tanımlayıcı istatistiklerin özeti Tablo 2'de sunulmaktadır. İncelenen finansal istikrar değişkenleri ile banka örnekleme ait veri seti 2017Q1-2022Q4 zaman aralığını temsil etmektedir. Analizlerde çalışmada kullanılan değişkenlerden Z-SKOR, CDS, TYKH ile AKTF'ye ait verilerin doğal logaritması alınarak kullanılmıştır.

Tablo: 2
Tanımlayıcı Testler

	Z-SKOR	CDS	FBI	TYKH	TKO	AKTF	KLDRC
Ortalama	5,081	5,908	0,124	21,827	3,579	19,129	12,887
Medyan	4,944	5,964	0,011	21,681	3,473	19,633	12,236
Maksimum	13,98	6,670	1,027	22,689	4,269	21,661	22,795
Minimum	2,400	5,170	-0,303	21,282	2,617	15,600	6,621
Standart sapma	1,424	0,425	0,368	0,403	0,575	1,559	3,095
Basıklık	2,200	-0,277	1,140	0,659	-0,022	-0,532	0,672
Çarpıklık	2,075	-0,516	3,521	2,354	1,508	2,069	3,225
Gözlem (N)	120	120	120	120	120	120	120

Tablo 2'de raporlanan tanımlayıcı sonuçlara göre, 5 kamu sermayeli bankanın inceleme dönemine ait Z-Skor ortalaması 5,081 bulunmuştur. Ayrıca banka özelinde ise Halk Bankası'nın 5,75, Vakıfbank'ın 4,76, Ziraat Bankası'nın 5,19, Ziraat Katılım'ın 4,7, Vakıf Katılım'ın ise 5,01 Z-Skor ortalamasına sahip olduğu görülmüştür. Türkiye'nin 3 yıllık CDS'i açısından 5,908, FBI %12,4, TYKH 21,827, TKO %3,579, AKTF 19,129, KLDRC ise 12,887 ortalama değere sahip olduğunu göstermektedir. Ayrıca tüm değişkenler için basıklık (kurtosis) ve çarpıklık (skewness) değerlerinin normallik koşulunu sağladığı da doğrulanmaktadır.

Yapılması gerek bir diğer önemli test de modelde dikkate alınan değişkenlerin durağanlığıdır. Çünkü modellerimizi tahmin etmeye geçmeden önce hangi modelin çalışmamızın veri setine uygun olduğundan emin olabilmek için değişkenlerin durağanlık seviyelerinin ele alınması önemlidir. Bu nedenle yapılan birim kök analiz sonuçları Tablo 3'te sunulmuştur.

Tablo 3
Birinci Nesil Panel Birim Kök Testi

Değişken	Entegrasyon I(0) & I(1)	Levin, Lin & Chu t*		Im, Pesaran and Shin W-stat		ADF-Fisher Chi-square	
		Sabitli	Sabitli ve Trendli	Sabitli	Sabitli ve Trendli	Sabitli	Sabitli ve Trendli
Z-SKOR	I(0)	-5,945***	-7,048***	-4,889***	-4,735***	41,889***	37,735***
	I(1)						
CDS	I(0)	-3,206***	-5,367***	-0,685	-3,144***	9,102	26,373***
	I(1)	-5,094***	-2,214**	-5,326***	-3,281***	45,894***	25,915***
FBI	I(0)	-7,223***	-5,432***	-5,222***	-3,631***	45,020***	30,048***
	I(1)						
TYKH	I(0)	7,252	3,305	9,566	5,507	0,001	0,076
	I(1)	-5,017***	-5,032**	-4,243**	-4,905***	35,022***	38,271***
TKO	I(0)	-0,758	0,490	-0,848	1,342	10,857	2,914
	I(1)	-1,802**	-2,521***	-0,958	-1,889**	11,370	16,077*
AKTF	I(0)	2,962	1,843	6,374	2,985	0,550	4,541
	I(1)	-9,173***	-8,139***	-7,193***	-5,110***	61,780***	42,681***
KLDRC	I(0)	-0,852	-4,963***	0,400	-4,889***	7,557	39,315***
	I(1)	-12,526***	-9,167***	-10,046***	-6,905***	89,610***	56,617***

Not: ***, ** ve * sırasıyla %, %5 ve %10 düzeyinde anlamlılığı ifade etmektedir.

Finansal istikrarsızlığın örneklemde yer alan bankaların finansal istikrar göstergesi olarak tarafımızca hesaplanan Z-Skor değeri üzerindeki etkisini analiz etmek için kullanılacak analiz yöntemine karar verebilmek için yapılması gereken testlerin başında birim kök analizi gelmektedir. Bu çalışmada kullanılan tüm değişkenlere uygulanan birinci nesil panel birim kök test sonuçları Tablo 3'te rapor edilmiştir. Tabloda yer alan birim kök analizine ait istatistiksel katsayılar incelendiğinde, Levin, Lin & Chu t* (2002), Im, Pesaran and Shin W-stat (2003) ve ADF-Fisher Chi-square (1979) sonuçlarına göre sabitli ve trendli modellerde değişkenlerin I(0), I(1) veya her ikisinin kombinasyonunda durağanlığın sağlandığı görülmüştür. Başka bir ifade ile birinci nesil birim kök testlerinde tüm zaman serileri I(0) veya I(1) seviyesinde entegre oldukları tespit edilmiştir.

Zaman serisine ait birim kök analizlerinde Akaike Bilgi Kriteri (1974), Newey West (1994) ve Parzen Metodu dikkate alınmıştır. Panel birim kök sonuçlarına göre, değişkenler arasında eşbütünleşmenin varlığı ile uzun ve kısa dönem etki sonuçlarını tespit etmek için çalışmamızın ekonometrik analizinde panel ARDL (Autoregressive Distributed Lag Model) yöntemi ile tahmin edilirken Havuzlanmış Ortalama Grup (Pooled Mean Group-PMG) yaklaşımını kullanmak için teorik olarak bir sorun görülmediğini söylemek mümkündür. Çünkü PMG/ARDL analiz yöntemi, modelde yer alan bağımlı ve bağımsız değişkenlerin sadece I(0) veya I(1) ya da bazı değişkenlerin I(0) bazı değişkenlerin ise I(1) seviyesinde durağan olma özelliğine sahip olma durumunda analiz yapmaya olanak tanımaktadır.

4.2.2. Model

Çalışmanın değişkenlerine ait detaylı açıklamaların yer aldığı Tablo 1'deki zaman serisi özelliğine sahip veri setine uygulanan birim kök analizlerin yer aldığı Tablo 3'teki sonuçlardan yola çıkarak analizlerde panel ARDL ile tahmin edilirken PMG yaklaşımı kullanılmıştır. PMG yönteminin hem dinamik bir özelliğe sahip olması hem uzun dönem hem de kısa dönem etki sonuçlarını birlikte vermesinden dolayı son yıllarda finansal ekonomi araştırmalarında yaygın bir şekilde tercih edilmektedir. Bu nedenle çalışmanın araştırma modelinde kullanılan finansal istikrarsızlık değişkenlerinin bankaların finansal

istikrar (Z-Skor) değişkeni üzerindeki uzun vadeli ve kısa vadeli regresyon etki katsayılarını test etmek için kullanılan PMG tahminleyicisi Pesaran, Shin ve Smith (1999) tarafından geliştirilmiştir.

PMG tahminleyicisi, bağımlı ve bağımsız değişkenlerin I (0), I (1) veya her ikisinin karışımı olduğu durumlarda Pesaran ve Smith (1995), Pesaran (1997) ve Pesaran ve Shin (1999) tarafından yeni bir eşbütünleşme testi olarak bir hata düzeltme modeli formunda yeniden parametrelendirilmiş Otoregresif Dağıtılmış Gecikme Modeli’ne (ARDL modeli) dayanmaktadır. Başka bir ifade ile PMG/ARDL modeli, incelenen değişkenlerin I(0), I(1) veya her ikisinin olduğu karışık entegrasyon seviyesine sahip değişkenlere izin vermektedir.

Panel ARDL modeli, kesitsel heterojenliği tahmin etmek için en popüler yöntemlerden biridir. Panel ARDL modellemesine yönelik PMG yaklaşımı, enine kesit birimleri boyunca homojen olmalarını kısıtlarken maksimum olasılık prosedürünü kullanarak uzun vadeli katsayıları tahmin etmektedir. Uzun vadeli katsayılar tahmin edildikten sonra, PMG yaklaşımı kesişmeleri, kısa vadeli eğim katsayılarını ve hata düzeltme mekanizmasını maksimum olasılık prosedürünü kullanarak birim bazında tahmin ederek bunların yatay kesit birimleri arasında değişmelerine izin vermektedir. Ayrıca, değişkenler uzun dönem ve kısa dönemde eşzamanlı olarak tahmin edildiği için modelde ihmal edilen değişkenler ve otokorelasyon sorunları tahminci tarafından azaltılan güçlü bir yöntemdir (Odugbesan & Rjoub, 2019: 6-9; 2020: 570).

Çalışmanın ekonometrik analizinde teorik olarak kullanılması sorun teşkil etmeyen PMG/ARDL metodolojisi için 3’ünlü fonksiyonel işlem, ampirik uygulamanın temel regresyon denklemi için ise 4’ünlü formül, PMG/ARDL için 5’ünlü formül dikkate alınmaktadır.

Fonksiyonel denklem:

$$Z_SKOR = f(CDS, FBI, TYKH, TKO, AKTF, KLDRC) \quad (3)$$

Temel denklem:

$$Z_SKOR_t = \phi_0 + \phi_1 CDS_t + \phi_2 FBI_t + \phi_3 TYKH_t + \phi_4 TKO_t + \phi_5 AKTF_t + \phi_6 KLDRC_t + \varepsilon_t \quad (4)$$

PMG/ARDL denklemi:

$$\begin{aligned} \Delta Z_SKOR_t = & \phi_0 + \gamma_1 Z_SKOR_{t-1} + \phi_2 CDS_{t-1} + \phi_3 FBI_{t-1} + \phi_4 TYKH_{t-1} + \\ & \phi_5 TKO_{t-1} + \phi_6 AKTF_{t-1} + \phi_7 KLDRC_{t-1} + \sum_{i=1}^p \psi_{1i} \Delta Z_SKOR_{t-i} + \sum_{i=0}^q \psi_{2i} \Delta CDS_{t-i} + \\ & \sum_{i=0}^r \psi_{3i} \Delta FBI_{t-i} + \sum_{i=0}^s \psi_{4i} \Delta TYKH_{t-i} + \sum_{i=0}^k \psi_{5i} \Delta TKO_{t-i} + \sum_{i=0}^l \psi_{6i} \Delta AKTF_{t-i} + \\ & \sum_{i=0}^v \psi_{7i} \Delta KLDRC_{t-i} + \omega_{8i} ECM_{t-i} + \varepsilon_t \end{aligned} \quad (5)$$

Denklem 5’te yer alan “ ϕ ” sabit katsayı, “ γ ” bağımlı değişkenin gecikmeli değerinin katsayısı “ ψ ” bağımsız değişkenlerin uzun dönem katsayıları, “ ψ ” kısa dönem katsayıları, “ECM” hata düzeltme mekanizması, “ ε ” ise hata terimini temsil etmektedir.

ARDL yaklaşımının sahip olduğu en önemli özelliklerden biri de modelde yer alan Hata Düzeltme Mekanizmasıdır (Error Correction Model-ECM). Modelde ECM mekanizmasının yer alması, regresyon modelinde bağımsız değişkenlerde kısa dönemde ortaya çıkan şokların uzun dönemde dengeye gelme hızını düzenlemektedir. ARDL metodolojisinde ECM yaklaşımı 6'no'lu denklem kullanılarak çalışmaktadır. PMG/ARDL analizi sonucunda kısa dönem etkilerin anlamlılığı için modelde yer alan ECM katsayısının (COINTEQ) negatif ve istatistiksel olarak %5 düzeyinde anlamlı olması gerekmektedir.

$$\Delta Z_SKOR_t = \phi_0 + \sum_{i=1}^p \psi_{1i} \Delta Z_SKOR_{t-i} + \sum_{i=0}^q \psi_{2i} \Delta CDS_{t-i} + \sum_{i=0}^r \psi_{3i} \Delta FBI_{t-i} + \sum_{i=0}^s \psi_{4i} \Delta TYKH_{t-i} + \sum_{i=0}^k \psi_{5i} \Delta TKO_{t-i} + \sum_{i=0}^l \psi_{6i} \Delta AKTF_{t-i} + \sum_{i=0}^v \psi_{7i} \Delta KLDRC_{t-i} + \omega_{8i} ECM_{t-i} + \varepsilon_t \quad (6)$$

4.2.3. Korelasyon Analizi

Modellerimizi tahmin etmeye geçmeden önce değişkenler arasında var olan korelasyonun tespit edilmesi bağımsız değişkenler arasındaki çoklu doğrusal bağlantı problemi açısından önem arz etmektedir. Değişkenlere uygulanan Pearson korelasyon analizine ait korelasyon katsayısı ve anlamlılık düzeyleri (Sig.(2-tailed)) Tablo 4'teki matriste rapor edilmiştir.

Tablo: 4
Değişkenler Arası Korelasyon Testi

Değişken		Z-SKOR	CDS	FBI	TYKH	TKO	AKTF	KLDRC
Z-SKOR		1						
CDS	Pearson korelasyon	-0.3643	1					
	Sig. (2-tailed)	0,0000***						
FBI	Pearson korelasyon	-0.1361	0,3678	1				
	Sig. (2-tailed)	0,1383	0,0000***					
TYKH	Pearson korelasyon	-0.3271	0,8431	0,4006	1			
	Sig. (2-tailed)	0,0003***	0,0000***	0,0000***				
TKO	Pearson korelasyon	-0.0459	0,0967	-0,5841	-0,2868	1		
	Sig. (2-tailed)	0,6185	0,2932	0,0000***	0,0015***			
AKTF	Pearson korelasyon	-0.0666*	0,3884	0,1426	0,4379	-0,0655	1	
	Sig. (2-tailed)	0,4700	0,0000***	0,1202	0,0000***	0,4775		
KLDRC	Pearson korelasyon	-0.2664	0,4294	0,1319	0,4663	-0,0312	0,2193	1
	Sig. (2-tailed)	0,0033***	0,0000***	0,1509	0,0000***	0,7348	0,0161**	

Not: ***, ** ve * sırasıyla %1, %5 ve %10 düzeyinde anlamlılığı ifade etmektedir.

Tablo 4'te yer alan korelasyon sonuçlarında, Z-Skor ile CDS, TYKH ve KLDRC arasında %1 düzeyinde negatif yönlü ve anlamlı, AKTF ile %10 düzeyinde negatif yönlü ve anlamlı bir ilişki görülmektedir. Bağımsız değişkenler arasında ise %84,31 ile en yüksek korelasyonun TYKH ile CDS arasında olduğu, en düşük ise %28,68 ile TYKH ile TKO arasında görülmüştür. Literatürde genellikle bağımsız değişkenler arasındaki korelasyonun %90 ve üzerinde olması doğrusallık için bir endişe kaynağı olup ve çoklu doğrusal ilişki olduğu kabul edilmektedir. Çünkü çoklu regresyon denkleminde bağımsız değişkenler arasında yüksek oranda bir ilişki olduğunda çoklu bağlantı problemi olarak kabul edilmektedir. Bu açıdan korelasyon matrisinde en yüksek korelasyonun %84,31 çıkmış olması çoklu doğrusal bağlantı problemi olmadığını göstermektedir. Çoklu regresyon sonuçlarımızın daha güvenli olması için bağımsız değişkenler arasında çoklu doğrusal ilişki

probleminin varlığı Colinearity gösterge testi ile incelenmiş olup elde edilen katsayı sonuçları Tablo 5'te sunulmuştur.

Tablo: 5
Collinearity Testi

Değişken	Collinearity istatistikleri	
	Tolerance (1/VIF)	VIF
CDS	0,160	6,253
FBI	0,515	1,941
TYKH	0,151	6,640
TKO	0,376	2,659
AKTF	0,804	1,243
KLDRC	0,772	1,295

VIF değerinin 10'dan büyük olması, düzeltilmesi gereken önemli bir çoklu doğrusal bağlantı problemi olduğuna işaret etmektedir. İstatistiksel analizlerde 10'u aşan VIF değerleri genellikle çoklu doğrusal bağlantı olarak kabul edildiğinden dolayı maksimum VIF seviyesi 10 olarak kabul edilebilir (Hair et al., 1995; Midi et al., 2010; Potters & Li, 2023). Makale çalışmamızda Z-Skor bağımlı, diğer değişkenler ise bağımsız değişkenlerdir. Bağımsız değişkenler arasındaki Colinearity istatistik değerlerinin yer aldığı Tablo 5'teki katsayı sonuçlarında, Tolerans değerleri yaklaşık olarak 0,2'dan az ve VIF (Variance Inflation Factor) değerleri yaklaşık olarak 6,7'den küçük bulunmuştur. Sonuç olarak, Tablo 5'te bağımsız değişkenlerimize ait rapor edilen VIF değerlerinin 6,7'nin altında olması yapılan çoklu regresyon analizinin güvenilirliği açısından bir endişe kaynağı teşkil etmediğini söylemek mümkündür.

4.2.4. Yatay Kesit Bağımlılığı ve Panel Eşbütünlüğe Analizi

Panel veri çalışmalarında yapılması gerek en önemli teşhis testlerinden biri de yatay kesit bağımlılığı testleridir. Çünkü panel çalışmalarında katsayı tahminlerinin tutarlı olması gerekmektedir. Bu açıdan panel veri analizinde yatay kesitin bağımsız olmasını sağlamak için öncelikle verilere yatay kesit bağımlılığı testlerinin yapılması gerekmektedir (Pesaran, 2021). Yapılan analizde çalışmanın verilerinde yatay kesit bağımlılığının olması durumunda analizde yansız tahminler elde etmek için kalıntı değerlere yatay kesit bağımlılığının varlığında panel birim kök testleri uygulayarak bir teşhis testi gerçekleştirilmelidir (Pesaran, 2007). Bu bağlamda çalışmamızın panel veri analizine geçmeden önce yatay kesit bağımlılığının varlığını tespit etmek için Breusch-Pagan (1980) LM, Pesaran (2004) scaled LM ve Pesaran (2004) CD testleri ile analiz edilmiş olup sonuçlar Tablo 6'da rapor edilmiştir.

Tablo: 6
Yatay Kesit Bağımlılığı Testi

Test	İstatistik	Serbestlik derecesi	P değeri
Breusch-Pagan LM	30,0540	10	0,0008***
Pesaran scaled LM	4,4842	10	0,0000***
Pesaran CD	3,1838	10	0,0015***

Nor: ***, %1 düzeyinde anlamlılığı ifade etmektedir.

Tablo 6’da enine kesit bağımlılığına ait elde edilen sonuçlarda, panelde yatay kesit bağımlılığı olmadığına ilişkin boş hipotezin üç test içinde %1 anlamlılık düzeyinde reddedildiğini göstermektedir. Çünkü her üç teste ait elde edilen p değeri 0,05’ten büyük çıkmıştır. Dolayısıyla bu sonuçlar verilerde yatay kesit bağımlılığının var olduğu anlamına geldiği için bundan sonra yatay kesit bağımlılığını dikkate alan testler ve tahmin teknikleri ile ilerlememiz gerekmektedir. Yatay kesit bağımlılığının varlığı altında yapacağımız panel PMG/ARDL analizinde yansız tahminler elde etmek için artık tahminlere yatay kesit bağımlılığının varlığında panel birim kök testleri uygulayarak bir teşhis testi gerçekleştirilmiştir (Pesaran, 2007). Panel PMG/ARDL analizine ait kalıntı değerlerin birim kök test sonuçlarının yer verildiği Tablo 9’daki sonuçlarda, kalıntının seviyede durağan olduğunu, başka bir ifade ile I(0) mertebesini takip ettiğini ve durağanlığın panel PMG/ARDL sonuçlarına ait tahminleri doğruladığını göstermektedir.

Örnekleme yer alan değişkenler arasında uzun dönemli bir ilişkinin varlığını saptamak için eşbütünlüğün yokluğunu savunan boş hipotezi test etmek için analizimizi biraz daha genişleterek, modele dinamik bir özelliğe sahip panel eşbütünlüğe uygulanmıştır. Değişkenler arasında var olan eşbütünlüğe bağlantısı Kao (1999), Pedroni (1999) ve Johansen Fisher (1995) birinci nesil çoklu eşbütünlüğe yöntemleri kullanılarak analiz edilmiştir. Birinci nesil panel eşbütünlüğe testlerin sonuçları Tablo 7’de rapor edilmiştir.

Tablo: 7
Panel Eşbütünlüğe Testi

Panel 1: Pedroni testi				
Common AR coefs. (within-dimension)				
	İstatistik	P değeri	W. İstatistik	P değeri
Panel v-Statistic	0.2314	0,4085	-3,2626	0,9994
Panel rho-Statistic	1.4960	0,9327	1,8556	0,9682
Panel PP-Statistic	-10,859	0,0000***	-17,7346	0,0000***
Panel ADF-Statistic	-5,1850	0,0000***	-3,5813	0,0002***
Individual AR coefs. (between-dimension)				
	İstatistik	P değeri		
Group rho-Statistic	2,3261	0,9900		
Group PP-Statistic	-20,8617	0,0000***		
Group ADF-Statistic	-5,2081	0,0000***		
Panel 2: Kao testi				
ADF	İstatistik	P değeri		
ADF	-2,8073	0,0025***		
Panel 3: Johansen Fisher testi				
Hypothesised No. of CE(s)	Fisher Stat.* (from trace test)	P değeri	Fisher Stat.* (from max-eigen test)	P değeri
None	305,3	0,0000***	387,1	0,0000***
At most 1	178,5	0,0000***	107,1	0,0000***
At most 2	88,52	0,0000***	44,66	0,0000***
At most 3	50,83	0,0000***	31,74	0,0004***
At most 4	26,44	0,0032***	14,59	0,1479
At most 5	20,36	0,0260**	16,56	0,0847*
At most 6	20,03	0,0290**	20,03	0,0290**

Not: ***, ** ve * sırasıyla %1, %5 ve %10 düzeyinde anlamlılığı ifade etmektedir.

Panel eşbütünlüğe test sonuçlarının özetlendiği Tablo 7’ye göre, Panel 1’de yer alan Pedroni eşbütünlüğe testlerinin 11’inden 6’sı ile panel 2’deki Kao eşbütünlüğe testi %1 anlamlılık düzeyinde anlamlı bulunmuştur. Panel 3’te yer alan Johansen Fisher panel

eşbütünleşme sonucunda Fisher iz (trace) testinde 4 değişkenin %1, iki değişkenin %5, maksimum öz değer (max-eigen) test ise 3 değişkenin %1, bir değişkenin %1 ile %5, bir değişkende ise anlamlı bulunmamıştır. Panel eşbütünleşme sonuçları farklı anlamlılık seviyelerinde olsa da değişkenler arasında uzun dönemde bir ilişkinin olmadığına dair boş hipotez önemli ölçüde reddedilmektedir. Pedroni, Kao ve Johansen Fisher panel eşbütünleşme testlerimizin bulguları göz önüne alındığında, incelenen kamu sermayeli bankaların finansal istikrarı ile finansal baskı endeksi, kredi risk primi, yurtiçi kredi hacmi, takipteki kredilerin oranı ile kontrol değişkeni olarak alınan toplam aktifler ve finansal kaldıraç arasında uzun dönemde güçlü bir ilişkinin varlığı doğrulanmaktadır. Değişkenlerin uzun dönemde dengeye sahip olduğuna dair önemli kanıtlar eşbütünleşme testleri ile belirlendikten sonra nedensellik ilişkisi için panel veri analizi aşamasına geçilebilir.

4.2.5. Panel PMG/ARDL Analizi

Değişkenler arasında eşbütünleşme ilişkisini doğruladıktan sonra, bu bölümde Türkiye ekonomisi için seçilen finansal istikrarsızlık göstergeleri ve kontrol değişkenlerinin kamu sermayeli bankaların finansal istikrarı üzerindeki uzun ve kısa dönem etkileri ampirik olarak analiz edilmiştir. Ampirik uygulamada dinamik bir regresyon özelliğine sahip olan PMG/ARDL’de maksimum 2 gecikme uzunluğu, sabitli ve trendli model ile Akaike Bilgi Kriteri (AIC) dikkate alınmıştır.

Tablo: 8
Panel PMG/ARDL Testi (2, 2, 2, 2, 2, 2)

Değişken	Katsayı	Standart hata	t-istatistik	P değeri
Panel 1: Uzun dönem etkiler				
CDS	-2,7921	0,5264	-5,3042	0,0000***
FBI	0,5936	0,2874	2,0654	0,0466**
TYKH	-3,5552	1,8014	-1,9736	0,0566*
TKO	-0,9281	0,2705	-3,4308	0,0016***
AKTF	-3,3222	0,7032	-4,7245	0,0000***
KLDRC	0,0810	0,0193	4,2016	0,0002***
Panel 2: Kısa dönem etkiler				
D(Z-SKOR(-1))	0,3033	0,2004	1,5140	0,1393
D(CDS)	3,4040	0,7545	4,5118	0,0001***
D(CDS(-1))	0,7182	1,0400	0,6906	0,4945
D(FBI)	0,0597	0,3808	0,1568	0,8763
D(FBI(-1))	0,9853	0,3525	2,7952	0,0085***
D(TYKH)	-1,8656	7,2068	-0,2589	0,7973
D(TYKH(-1))	-0,2432	5,3699	-0,0453	0,9641
D(TKO)	1,9155	2,0314	0,9429	0,3524
D(TKO(-1))	3,5675	0,5122	6,9653	0,0000***
D(AKTF)	0,6016	2,4880	0,2418	0,8104
D(AKTF(-1))	-2,0248	5,6664	-0,3573	0,7231
D(KLDRC)	-0,1780	0,1159	-1,5358	0,1339
D(KLDRC(-1))	0,0002	0,0910	0,0016	0,9987
C	212,9343	64,5700	3,2977	0,0023***
@TREND	1,0703	0,3685	2,9047	0,0064***
COINTEQ01	-1,3950	0,4418	-3,1574	0,0033***

Not: ***, ** ve * sırasıyla %1, %5 ve %10 düzeyinde anlamlılığı ifade etmektedir.

Finansal istikrarsızlık göstergeleri ile kontrol değişkenlerinin PMG/ARDL uzun dönem etki sonuçlarının yer aldığı Panel 1’de görüldüğü üzere, uzun dönemde finansal baskı endeksi ile finansal kaldıraç etkisinin pozitif, kredi risk primi, toplam yurtiçi kredi hacmi,

taktipteki kredilerin oranı ile toplam aktiflerin etkisi negatif ve anlamlı bulunmuştur. Yurtiçi kredi hacminin etkisi % 10, finansal baskı endeksinin %5, diğer değişkenlerin etkisi ise %1 düzeyinde anlamlı çıkmıştır. Finansal istikrarsızlık ile kontrol değişkenlerinde uzun dönemde 1 birimlik bir artışın Z-Skor üzerinde sırasıyla, 2,79'luk bir azalış, 0,59'luk bir artış, 3,56, 0,93 ile 3,32'lik bir azalış ve 0,08'lik bir artışa yol açtığı görülmektedir. PMG bulguları, çalışmanın araştırma sorunsalını teşkil eden finansal istikrarsızlık göstergelerinden FBI'deki artışların piyasalarda neden olduğu istikrarsızlığın örneklemde yer alan bankalar tarafından önemli ölçüde olumlu bir görünüme dönüştürmeyi başarabildikleri, ancak CDS, TYKH, TKO'nun bankaların istikrarı üzerinde neden olduğu şokların potansiyel etkisinin önemli olduğu gözlemlenmiştir.

Panel 2'deki PMG/ARDL kısa dönem etki sonuçları incelendiğinde, CDS'in cari dönemde, FBI ile TKO'nun ise bir gecikmeli katsayılarının Z-Skor üzerinde pozitif yönde ve %1 düzeyinde anlamlı bir etkiye neden olduğunu göstermektedir. Kısa dönemde etki katsayıları anlamlı bulunan CDS, TYKH ve TKO'da 1 birimlik bir artış Z-Skor üzerinde sırasıyla 3,40, 0,99 ve 3,57'lik bir artış sağlamaktadır. Finansal istikrarsızlık göstergelerinin PMG/ARDL uzun ve kısa dönem etkileri arasındaki farklılaşmadan yola çıkarak, kamu sermayeli bankaların kısa dönemde finansal istikrarlarını korumayı başarabildikleri, ancak uzun dönemde FBI hariç diğer göstergelerdeki artışların neden olduğu risklere karşı finansal istikrarlarındaki olumlu görünümü korumayı başaramadıklarını göstermektedir. Ayrıca modelin @trend ile COINTEQ01 (ECM) katsayısı % 1 düzeyinde anlamlı, R² değeri %45,97 ve Durbin-Watson istatistik değeri 2,01'dir.

Panel 2'de yer alan hata düzeltme mekanizması, kısa vadeli dengesizlikten uzun vadeli dengeye ayarlama hızını göstermekte ve parametre katsayısının negatif ve anlamlı olması beklenmektedir. Tablo 8'deki PMG tahmincisine ait ECM değeri negatif ve anlamlıdır. ECM'nin katsayısı PMG tahminci için dengeye doğru ayarlama hızı -1,3950'dir. Bu bulgu kısa dönemde meydana gelen dengesizliğin yaklaşık %140'ının bir sonraki dönemde düzeltilerek uzun dönem dengesine ulaştığı anlamına gelmektedir.

Tablo: 9
Panel PMG/ARDL Kalıntı Birim Kök Testi

Metod	İstatistik	P değeri	Kesitler
Levin, Lin & Chu t*	-9,4144	0,0000***	5
Im, Pesaran and Shin W-stat	-6,2230	0,0000***	5
ADF - Fisher Chi-square	50,9860	0,0000***	5
PP - Fisher Chi-square	67,6997	0,0000***	5

Not: ***, %1 düzeyinde anlamlılığı ifade etmektedir.

Sonuç olarak, uzun ve kısa dönem etki sonuçlarının yer aldığı Tablo 8'deki parametre katsayıları ile Tablo 9'da kalıntı birim kök test bulguları PMG/ARDL tahminleyicisine ait modelin sonuçlarını doğrulamaktadır.

5. Sonuç ve Değerlendirme

Finansal piyasaların en önde gelen kuruluşları olan bankalar, ülke ekonomilerinde ekonomik gelişme ve kalkınma için gerek yurtdışından gelen sermayenin gerekse yurt içinde tasarruf fazlası olan ekonomik birimlerden toplanan fonların etkin ve doğru yatırım alanlarına aktarılmasında ve reel ekonominin verimlilik ve üretkenliği için yapılacak yatırımların finansmanında öncülük etmektedir. Bankaların topladığı ve yönlendirdiği büyük miktarda fonlar toplumsal refahın artması için doğru alanlara kanalize edilmediği zaman genellikle ülke ekonomileri üzerinde ani olarak olumsuz birtakım yansımalar neden olabilir. Çünkü bankacılık sektörünün faaliyetleri finansal hizmetler sektöründen reel ekonomiye kadar geniş bir aktarım mekanizmasını kapsadığı için sektörde yaşanacak bir istikrarsızlık bütün ekonomik sistem üzerinde sistematik bir krize yol açabilme yayılımına sahiptir. Bu açıdan gelişmiş ve gelişmekte olan ekonomilerde reel kesim ile finansal kesime sermaye tahsis eden bankacılık sektörünün güçlü bir sermaye yapısı ve aktif kalitesine sahip olması ülkenin makro finansal görünümü ve dolayısıyla finansal istikrarı için büyük önem arz etmektedir.

Bankacılık sektörünün finansal istikrarının öneminden yola çıkarak yaptığımız bu çalışmada hem firmaya özgü hem de piyasaya özgü göstergeler ile dinamik bir özelliğine sahip panel regresyon yöntemi kullanılmıştır. Çalışmanın örnekleminde yer alan kamu sermayeli bankaların finansal istikrarı için tarafımızca hesaplanan Z-Skor değeri kullanılmıştır. Sektörün istikrarını etkilediği düşünülen ve akademik literatürde de kriz öncü göstergeleri olarak kabul gören makro göstergelerin uzun ve kısa dönem etkileri ile Z-Skor arasında uzun dönemde bir eşbütünleşmenin varlığı analiz edilmiştir. Yapılan ampirik analizde Z-Skor değeri ile çalışmanın modelinde yer alan finansal istikrarsızlık göstergeleri arasında hem uzun dönemde önemli bir eşbütünleşmenin olduğu hem de uzun dönem panel PMG analiz etki sonuçları anlamlı bulunmuştur. Uzun dönem analizinde sadece finansal baskı endeksinin etkisi beklenenin tersine çıkarken, diğer istikrarsızlık göstergelerinin etki sonuçları ise literatür ile uyumlu bulunmuştur. Kısa dönem bulgularında ise modelde kullanılan finansal istikrarsızlık göstergelerindeki artışlara karşı bankaların finansal istikrarlarını korumayı başardıkları görülmüştür.

Sonuç olarak elde edilen bulgularda, çalışmada kullanılan finansal istikrarsızlık göstergelerinden kredi risk primi (CDS), yurtiçi toplam kredi hacmi (TYKH) ve takipteki kredilerin oranı (TKO) değişkenlerinin uzun dönemde bankaların istikrarını azaltan ve riskini karakterize eden makro temelleri yansıtan göstergeler olduğunu göstermektedir. Bankacılık sektörünün finansal istikrarının başarısı ve sürekliliği için sektöre yönelik politika yapımcıların piyasalarda olası olumsuz gelişmeleri erken öngörebilmek, finansal istikrarı iyileştirmek, optimal varlık ve sermaye yönetimi sağlamak ve istikrarsızlığa sebep olan potansiyel nedenleri tespit etmek için karar vericiler için son derece önemlidir. Kamu bankalarını istikrarsızlaştıran makro göstergelere yönelik olarak elde edilen bu bulgular, aynı zamanda bir bütün olarak finansal sistem için de sistematik riske yol açması nedeniyle makro ihtiyati düzenleyiciler için finansal piyasadaki olası olumsuzlukları erken bir aşamada tespit etmeye yönelik çok önemli çıkarımlar sunmaktadır. Ayrıca, Türkiye’de finansal

sektörde önemli bir itici güç olan kamu bankaları, kamu maliyesi ve para politikasının sorunsuz ve istikrar politikalarının sürdürülebilmesi açısından güçlü bir finansal yapıya sahip olması ve ülke riskini karakterize eden makroekonomik göstergelere karşı güçlü olması ülkenin finansal istikrarına da katkı sağlamaktadır.

Son olarak, bankacılık sektörünün finansal istikrarı üzerine yapılacak yeni çalışmalarda özel sektör bankaları, yerli ve yabancı sermayeli bankalar, farklı gelişmekte olan ülke bankacılık sektörü, farklı finansal istikrarsızlık göstergeleri, daha geniş bir veri seti, GMM, QREG, DOLS, FMOLS gibi farklı panel analiz yöntemleri kullanarak gelecekte yeni çalışmalar yapmaları araştırmacılara önerilmektedir.

Kaynaklar

- Aboura, S. & B. van Roye (2017), “Financial Stress and Economic Dynamics: The Case of France”, *International Economics*, 149, 57-73.
- Acedański, J. & R. Karkowska (2022), “Instability Spillovers in the Banking Sector: A Spatial Econometrics Approach”, *The North American Journal of Economics and Finance*, 61, 101694.
- Ahsan, T. & M.A. Qureshi (2022), “The Impact of Islamic Banking Model and Islamic Financial Development on Bank Performance: Evidence from Dual Banking Economies”, *International Journal of Islamic and Middle Eastern Finance and Management*, 15(3), 602-625.
- Akaike, H. (1974), “A New Look at the Statistical Model Identification”, *IEEE Transactions on Automatic Control*, 19(6), 716-723.
- Akyol, S. & S. Varlık (2010), “Bir Küresel Kamu Malı Olarak Finansal İstikrar: Eleştirel Değerlendirmeler”, *Ekonomik Yaklaşım*, 21(75), 141-162.
- Al-Khazali, O.M. & A. Mirzaei (2017), “The Impact of Oil Price Movements on Bank Non-Performing Loans: Global Evidence from Oil-Exporting Countries”, *Emerging Markets Review*, 31, 193-208.
- Allen, A.A. & G. Wood (2006), “Defining and Achieving Financial Stability”, *Journal of Financial Stability*, 2, 152-172.
- Angelini, P. (2018). “Do High Levels of NPLs Impair Banks’ Credit Allocation”, *Notes on Financial Stability and Supervision*, 12, 1-9.
- Atellu, A.R. et al. (2021), “Do Bank Regulations Matter for Financial Stability? Evidence from a Developing Economy”, *Journal of Financial Regulation and Compliance*, 29(5), 514-532.
- Balakrishnan, R. et al. (2011), “The Transmission of Financial Stress from Advanced to Emerging Economies”, *Emerging Markets Finance and Trade*, 47(sup2), 40-68.
- BDDK (2023), *Aylık Bankacılık Sektörü Verileri (Temel Gösterim)*, <<https://www.bddk.org.tr/BultenAylık>>, 10.05.2023.
- Beck, T. et al. (2013), “Bank Competition and Stability: Cross-Country Heterogeneity”, *Journal of Financial Intermediation*, 22(2), 218-244.
- Bolognesi, E. et al. (2020), “Non-Performing Loans and the Cost of Deleveraging: The Italian Experience”, *Journal of Accounting and Public Policy*, 39(6), 106786.

- Bomfim, A.N. (2022), "Credit Default Swaps", *Finance and Economics Discussion Series 2022-023*, Washington: Board of Governors of the Federal Reserve System, 1-25, <<https://ssrn.com/abstract=4108364>>, 25.04.2023.
- Boyd, J.H. & D.E. Runkle (1993), "Size and Performance of Banking Firms: Testing the Predictions of Theory", *Journal of Monetary Economics*, 31(1), 47-67.
- Boyd, J.H. & S.L. Graham (1986), "Risk, Regulation, and Bank Holding Company Expansion into Nonbanking", *Quarterly Review*, 10(2), 2-17.
- Breusch, T.S. & A.R. Pagan (1980), "The Lagrange Multiplier Test and its Applications to Model Specification in Econometrics", *The Review of Economic Studies*, 47(1), 239-253.
- Bumin, M. (2009), "Kamu Bankalarının Yeniden Yapılandırılması ve Sonuçları", *Bankacılar Dergisi*, 70, 18-36.
- Carlson, M. et al. (2014), "Using Policy Intervention to Identify Financial Stress", *International Journal of Finance & Economics*, 19(1), 59-72.
- Čihák, M. & H. Hesse (2010), "Islamic Banks and Financial Stability: An Empirical Analysis", *Journal of Financial Services Research*, 38(2), 95-113.
- Clark, B. et al. (2023), "Credit Default Swaps and Debt Specialization", *Journal of Financial Intermediation*, 54, 101029.
- Cornett, M.M. et al. (2011), "Liquidity Risk Management and Credit Supply in the Financial Crisis", *Journal of Financial Economics*, 101(2), 297-312.
- Coşar, K. & N. Köse (2019), "Zamanla Değişen Parametrelili Geliştirilmiş Taylor Kuralı: Türkiye için Finansal İstikrarın Rolü", *İstanbul Gelişim Üniversitesi Sosyal Bilimler Dergisi*, 6(1), 1-17.
- De Nicola, M.G. et al. (2006), "Bank Risk-Taking and Competition Revisited: New Theory and New Evidence", *IMF Working Paper WP/06/297*.
- Diamond, D.W. & P.H. Dybvig (1983), "Bank Runs, Deposit Insurance, and Liquidity", *Journal of Political Economy*, 91(3), 401-419.
- Diamond, D.W. & R.G. Rajan (2001), "Liquidity Risk, Liquidity Creation, and Financial Fragility: A Theory of Banking", *Journal of Political Economy*, 109(2), 287-327.
- Dickey, D.A. & W.A. Fuller (1979), "Distribution of the Estimators for Autoregressive Time Series with a Unit Root", *Journal of the American Statistical Association*, 74(366a), 427-431.
- Ece, O. & B.D. Çadırcı (2022), "Kredi Portföy Yoğunlaşma Düzeyinin Finansal İstikrar ve Performans Üzerine Etkisi: İkili Bankacılık Sisteminde Karşılaştırmalı Bir Analiz", *İktisat Politikası Araştırmaları Dergisi*, 9(2), 523-556.
- Eichengreen, B. et al. (1996), "Contagious Currency Crises", *NBER Working Paper 5681*, National Bureau of Economic Research.
- Ekinci, R. & R. Kök (2020), "Avrupa Birliği Bankacılık Endüstrisinde Rekabet ve İstikrar İlişkisi: Ticari Bankalar Üzerine Bir Deneme", *İzmir İktisat Dergisi*, 35(4), 879-894.
- Elekdag, S. et al. (2010), "Finansal Stres ve İktisadi Faaliyet", *Central Bank Review*, 10(2), 1-8.
- Gerşl, A. & J. Seidler (2010), "Excessive Credit Growth as an Indicator of Financial (in) Stability and Its Use in Macroprudential Policy", *CNB Financial Stability Report*, 2010/2011, 112-122.

- Ghosh, A. (2015), "Banking-Industry Specific and Regional Economic Determinants of Non-Performing Loans: Evidence from US States", *Journal of Financial Stability*, 20, 93-104.
- Ghosh, A. (2017), "Sector-Specific Analysis of Non-Performing Loans in the US Banking System and Their Macroeconomic Impact", *Journal of Economics and Business*, 93, 29-45.
- Göker, Z. (2009), "Küresel Kamusal Bir Mal: Finansal İstikrar", *Akdeniz İ.İ.B.F. Dergisi*, (17), 7-22.
- Hair, J. et al. (1995), *Multivariate Data Analysis* (3rd ed), New York: Macmillan.
- Hakkio, C.S. & W.R. Keeton (2009), "Financial Stress: What is it, How can it be Measured, and Why Does it Matter", *Economic Review*, 94(2), 5-50.
- Hannan, T.H. & G.A. Hanweck (1988), "Bank Insolvency Risk and the Market for Large Certificates of Deposit", *Journal of Money, Credit and Banking*, 20(2), 203-211.
- Hoque, H. & H. Liu (2023), "Impact of Bank Regulation on Risk of Islamic and Conventional Banks", *International Journal of Finance & Economics*, 28, 1025-1062.
- Illing, M. & Y. Liu (2003), "An Index of Financial Stress for Canada", *Bank of Canada Working Papers No.14*.
- Im, K.S. et al. (2003), "Testing for Unit Roots in Heterogeneous Panels", *Journal of Econometrics*, 115(1), 53-74.
- Investing (2023), Türkiye CDS 3 Yıllık, <<https://tr.investing.com/rates-bonds/turkey-cds-3-years-usd-historical-data>>, 18.05.2023.
- Ionescu, C. (2012), "The Herd Behavior and The Financial Instability", *Annals of the University of Petroşani, Economics*, 12(1), 129-140.
- Johansen, S. (1995), *Likelihood-Based Inference in Cointegrated Vector Autoregressive Models*, New York: Oxford University Press.
- Kaminsky, G. et al. (1998), "Leading Indicators of Currency Crises", *Staff Papers*, 45(1), 1-48.
- Kao, C. (1999), "Spurious Regression and Residual-Based Tests for Cointegration in Panel Data", *Journal of Econometrics*, 90(1), 1-44.
- Korkmaz, Ö. & R. Yamak (2015), "Minsky Finansal İstikrarsızlık Hipotezi ve Türkiye Örneği", *Anadolu Üniversitesi Sosyal Bilimler Dergisi*, 15(3), 51-70.
- Krkoska, L. (2001), "Assessing Macroeconomic Vulnerability in Central Europe", *Post-Communist Economics*, 13(1), 41-55.
- Krugman, P. (1979), "A Model of Balance-of-Payments Crises", *Journal of Money, Credit and Banking*, 11(3), 311-325.
- Laeven, L. & R. Levine (2009), "Bank Governance, Regulation and Risk Taking", *Journal of Financial Economics*, 93(2), 259-275.
- Lepetit, L. & F. Strobel (2013), "Bank Insolvency Risk and Time-Varying Z-Score Measures", *Journal of International Financial Markets, Institutions and Money*, 25, 73-87.
- Lepetit, L. & F. Strobel (2015), "Bank Insolvency Risk and Z-Score Measures: A Refinement", *Finance Research Letters*, 13, 214-224.
- Levin, A. et al. (2002), "Unit Root Tests in Panel Data: Asymptotic and Finite-Sample Properties", *Journal of Econometrics*, 108(1), 1-24.
- Liu, Y. & B. Morley (2012), "Sovereign Credit Default Swaps and the Macroeconomy", *Applied Economics Letters*, 19(2), 129-132.

- Longstaff, F.A. et al. (2007), "How Sovereign is Sovereign Credit Risk?", *NBER Working Paper No.* 13658.
- Louhichi, A. et al. (2020), "The Regulations-Risk Taking Nexus under Competitive Pressure: What about the Islamic Banking System?", *Research in International Business and Finance*, 51, 101074.
- Marois, T. (2022), "A Dynamic Theory of Public Banks (and Why it Matters)", *Review of Political Economy*, 34(2), 356-371.
- Menicucci, E. & G. Paolucci (2022), "Gender Diversity and Bank Risk-Taking: An Empirical Investigation in Italy", *Corporate Governance: The International Journal of Business in Society*, 22(2), 317-339.
- Midi, H. et al. (2010), "Collinearity Diagnostics of Binary Logistic Regression Model", *Journal of Interdisciplinary Mathematics*, 13(3), 253-267.
- Mishkin, F.S. (1997), "The Causes And Propagation of Financial Instability: Lessons for Policy Makers", in: *Proceedings-Economic Policy Symposium-Jackson Hole* (55-96), Federal Reserve Bank of Kansas City.
- Miyat, M. et al. (2010), "Bir Küresel Dışsal Maliyet Örneği Olarak Finansal İstikrarsızlıklarla Mücadele Yöntemleri", *Maliye Dergisi*, 159, 119-136.
- Naifar, N. (2020), "What Explains the Sovereign Credit Default Swap Spreads Changes in the GCC Region?", *Journal of Risk and Financial Management*, 13(10), 245.
- Newey, W.K. & K.D. West (1994), "Automatic Lag Selection in Covariance Matrix Estimation", *The Review of Economic Studies*, 61(4), 631-653.
- Odugbesan, J.A. & H. Rjoub (2019), "Relationship among HIV/AIDS Prevalence, Human Capital, Good Governance, and Sustainable Development: Empirical Evidence from Sub-Saharan Africa", *Sustainability*, 11(5), 1348.
- Odugbesan, J.A. & H. Rjoub (2020), "Evaluating HIV/Aids Prevalence and Sustainable Development in Sub-Saharan Africa: The role of Health Expenditure", *African Health Sciences*, 20(2), 568-578.
- Pedroni, P. (1999), "Critical Values for Cointegration Tests in Heterogeneous Panels with Multiple Regressors", *Oxford Bulletin of Economics and Statistics*, 61(S1), 653-670.
- Pesaran, M.H. & R. Smith (1995), "Estimating Long-Run Relationships from Dynamic Heterogeneous Panels", *Journal of Econometrics*, 68(1), 79-113.
- Pesaran, M.H. (2007), "A Simple Panel Unit Root Test in the Presence of Cross-Section Dependence", *Journal of Applied Econometrics*, 22(2), 265-312.
- Pesaran, M.H. (2021), "General Diagnostic Tests for Cross-Sectional Dependence in Panels", *Empirical Economics*, 60(1), 13-50.
- Pesaran, M.H. et al. (1997), *Pooled Estimation of Long-Run Relationships in Dynamic Heterogeneous Panels*, <<https://www.econ.cam.ac.uk/people-files/emeritus/mhp1/jasaold.pdf>>, 10.05.2023.
- Pesaran, M.H. et al. (1999), "Pooled Mean Group Estimation of Dynamic Heterogeneous Panels", *Journal of the American Statistical Association*, 94(446), 621-634.
- Potters, C. & T. Li, (2023), *Variance Inflation Factor (VIF)*, <<https://www.investopedia.com/terms/v/variance-inflation-factor.asp>>, 02.08.2023.

- Qiu, L. et al. (2022), “Impact of Credit Default Swaps on Firms’ Operational Efficiency”, *Production and Operations Management*, 31(9), 3611-3631.
- Saliba, C. et al. (2023), “Does Country Risk Impact the Banking Sectors’ Non-Performing Loans? Evidence from BRICS Emerging Economies”, *Financial Innovation*, 9(1), 1-30.
- Samet, A. et al. (2018), “Does Public-Private Status Affect Bank Risk Taking? Worldwide Evidence”, *Journal of International Financial Markets, Institutions and Money*, 53, 287-306.
- Schinasi, G.J. (2004), “Defining Financial Stability”, *IMF Working Paper WP/04/187*.
- Steiner, K. (2012), “Households’ Exposure to Foreign Currency Loans in Ceseu Eu Member States and Croatia”, *Focus on European Economic Integration No. Q1/11*, 6-24, <<https://ssrn.com/abstract=1981910>>, 10.05.2023.
- Tabak, B.M. & R.B. Staub (2007), “Assessing Financial Instability: The Case of Brazil”, *Research in International Business and Finance*, 21, 188-202.
- The Basel Committee on Banking Supervision (2010), *Consultative Document: Countercyclical Capital Buffer Proposal*, <<https://www.bis.org/publ/bcbs172.pdf>> 13.05.2023.
- Tokucu, E. (2012), “Hyman Minsky’nin Finansal İstikrarsızlık Hipotezi Çerçevesinde Finansal Krizler ve Çözüm Önerileri”, *Ankara Üniversitesi SBF Dergisi*, 67(2), 189-212.
- Tunalı-Sarı, H.N. (2023), “Finansal İstikrar ile Finansal Regülasyon Arasındaki İlişkinin Katılım Bankacılığı ve Geleneksel Bankacılık Perspektifinden Değerlendirilmesi: Türkiye İçin Bir Analiz”, *Doktora Tezi*, Bursa Uludağ Üniversitesi Sosyal Bilimler Enstitüsü.
- Uçarkaya, S. (2006), “Kamu Bankalarının Bankacılık Sistemindeki Rolü”, *Uzmanlık Yeterlilik Tezi*, T.C. Merkez Bankası Bankacılık ve Finansal Kuruluşlar Genel Müdürlüğü, Ankara.
- Vermeulen, R. et al. (2015), “Financial Stress Indices and Financial Crises”, *Open Economies Review*, 26, 383-406.
- Wyplosz, C. (1998), *International Financial Instability*, <https://www.researchgate.net/profile/CharlesWyplosz/publication/242484653_International_Financial_Instability/links/02e>, 18.05.2023.
- Yıldırım, Y. (2017), “Küresel Kamusal Mal Olarak Finansal İstikrar Kavramı”, *Sinop Üniversitesi Sosyal Bilimler Dergisi*, 1(2), 325-344.
- Yılmaz, T. & Ö.U. Bulut (2022), “İktisadi ve İdari Bilimlerde Akademik Analiz ve Tartışmalar”, içinde: M. Göl & O. Özevin (eds.), *Belirsizliğin Spekülatif Baskı Endeksi Üzerindeki Asimetrik Etkisi: Türkiye Örneği (2005-2022)* (151-181), Gaziantep: Özgür Yayınları.
- Yin, H. (2019), “Bank Globalization and Financial Stability: International Evidence”, *Research in International Business and Finance*, 49, 207-224.

Çevre Vergileri, Karbon Emisyonu ile Ekonomik Büyüme Arasındaki İlişki: OECD Ülkeleri Üzerine Bir Analiz¹

Füsün ÇELEBİ-BOZ (<https://orcid.org/0000-0002-3884-0465>), Sakarya University of Applied Sciences, Türkiye; fusuncelebi@subu.edu.tr

Tuğba ÖRS-ONUR (<https://orcid.org/0000-0001-6851-1315>), Sakarya University of Applied Sciences, Türkiye; tors@subu.edu.tr

The Relationship Between Environmental Taxes, Carbon Emissions and Economic Growth: An Analysis of OECD Countries²

Abstract

The study examined the relationship between environmental taxes, economic growth, and carbon emissions by considering 34 OECD countries from 1995 to 2020. First, unit root tests were carried out to determine whether there is a relationship between carbon emissions, economic growth and environmental taxes. Then, the Dumitrescu Panel Granger causality test was applied. The panel quantile regression method was used depending on the relationship that emerged. According to the results, it has been determined that there is a positive relationship between environmental taxes and economic growth and a negative relationship between carbon emissions and economic growth. In addition, it can be said that while the effect of environmental taxes on economic growth is high in developing countries, this effect decreases in developed countries.

Keywords : Environmental Tax, Economic Growth, Carbon Emission, OECD Countries.

JEL Classification Codes : C33, B27, B22.

Öz

Çevre vergileri, ekonomik büyüme ve karbon emisyonu arasındaki ilişki 34 OECD ülkesi ve 1995-2020 dönemi ele alınarak incelenmiştir. Çalışmada öncelikle karbon emisyonu, ekonomik büyüme ve çevre vergileri arasında ilişki olup olmadığını belirlemek amacıyla birim kök testleri uygulandıktan sonra ülkelere göre çevre vergileri ve karbon emisyonunun ekonomik büyüme üzerindeki etkisini belirleyebilmek amacıyla panel kantil regresyon yöntemi ile model tahmini yapılmaya çalışılmıştır. Daha sonra ise heterojenliği dikkate alan Dumitrescu Hurlin panel testi ile değişkenler arasındaki ilişki incelenmiştir. Elde edilen sonuçlara göre, çevre vergileri ile ekonomik büyüme arasında pozitif yönlü karbon emisyonu ile ekonomik büyüme arasında ise negatif yönlü bir ilişki olduğu tespit edilmiştir. Ayrıca gelişmekte olan ülkelerde çevre vergilerinin ekonomik büyüme üzerindeki etkisi yüksek iken, gelişmiş ülkelerde ise bu etkinin düştüğü söylenebilmektedir.

¹ Bu çalışma 2. Uluslararası İktisadi ve İdari Bilimler Kongresi - Küresel Siyaset Ekonomide Yeni Tehditler ve Fırsatlar adlı sempozyumda sunulan "Çevre Vergileri ile Ekonomik Büyüme Arasındaki İlişki OECD Ülkeleri Üzerine Bir Analiz" adlı bildirinin değiştirilmiş ve geliştirilmiş halini içermektedir.

² This study includes a modified and improved version of the paper titled "An Analysis of OECD Countries: The Relationship Between Environmental Taxes and Economic Growth", presented at the 2nd International Congress of Economics and Administrative Sciences - New Threats and Opportunities in Global Politics and Economy.

Anahtar Sözcükler : Çevre Vergisi, Ekonomik Büyüme, Karbon Emisyonu, OECD Ülkeleri.

1. Giriş

Günümüzde, ulaşım, iletişim ve endüstri gibi yaşam standartlarının göstergesi olan unsurlardaki gelişme, büyük oranda enerjiye bağlıdır. Devletler, enerji kullanımı ile ekonomik kalkınma, ekonomik kalkınmanın sürdürülebilirliği ve toplumun refahının artması arasında bir ilişki kurmaktadır (Popescu, 2015: 68). Son yıllarda yapılan çalışmalarda enerji tüketiminin ekonomik büyüme üzerinde olumlu bir etkisinin olduğu vurgulanmıştır (Kahouli 2017: 20). Ancak, gelişmekte olan ülkeler, çevre sorunlarını yeterince dikkate almadan ekonomik büyümeye odaklanmaktadırlar. Hızlı ekonomik büyüme sağlanması için doğal kaynakların fazla kullanılması çevre kirliliği sonucunu doğurmaktadır (Mitić et al., 2019: 111).

Uzun yıllar boyunca ekonomi de odak nokta, ekonomik gelişmenin hızlandırılması, işsizlik oranlarının azaltılması, enflasyon oranlarının düşürülmesi gibi göstergeler olmuştur (Özdemir, 2009: 3). Çevre sorunları ile yüzleşen devletler ekonomik büyüme ve çevre sorunları arasında bir denge kurulması gerektiğinin farkına varmıştır. İşletmeler açısından ise çevreci üretimi benimsemeleri maliyetli ve zaman alıcı olması sebebiyle, devletlerin işletmeleri çevreci üretimler yapması için sübvansiyonlar, çevre vergileri, para cezaları gibi çeşitli araçlar ile teşvik etmesi gerekmektedir (Gao et al., 2019: 2).

Bazı iktisatçılar, ekonomik büyüme ve çevre politikası arasında bir seçim yapılmalıdır şeklinde görüşe sahip olsa da çevre koruma politikaları, sürdürülebilir ekonomik kalkınma için gerekli bir unsurdur (Mirović et al., 2021: 94). Önlem alınmadığı takdirde çevre kirliliği, insanların yaşamlarını sürdürmeyeceği bir boyuta ulaşması kaçınılmaz bir gerçektir (Beladi et al., 2021: 630).

Ekonomik faaliyetlerin artmasıyla birlikte üretim miktarları artmış ekonomik gelişme sağlanmıştır. Bu olumlu artışın olumsuz etkilerinden biri de kaynakların kontrolsüz kullanımı ile yaşanan çevre kirliliğidir. Bu olumsuzluğun giderilmesi için çevresel vergiler önemli bir araçtır (Bekmez & Nakipoğlu, 2012: 641). Devletlerarası İklim Değişikliği Panelinde (IPCC) sunulan raporlarda iklim değişikliğinin sebebi insanların faaliyetleri sonucu meydana gelmiştir. İklim değişikliğini tetikleyen başlıca etkenler, enerji tüketimi, karbon emisyonu (CO₂) ve bazı ürünlerin arzı ile endüstriyel faaliyetlerdir. Dolayısı ile uzun süre bu etkenlere maruz kalma sonucu ortaya çıkan sorunlara, üretilecek çözümler de uzun vadede etki edebilecek araçlar aracılığı ile sağlanabilecektir (Jamali, 2007: 19).

Ekonomist Marshall'ın 1920'lerde önerdiği refah ekonomisinden kaynaklanan, çevre vergisi, 19. yüzyılın sonlarında ortaya çıkan ekonomik bir kavramdır (He et al., 2019: 49). Birleşmiş milletler tarafından 1972'de yapılan çevre konferansı ile çevre koruma ile ilgili

araştırmalar önem kazanmıştır (Cural & Saygı, 2016: 78). Bu konferans ile birlikte ilk defa çevre sorunlarına ilişkin farkındalık oluşturulmuştur (Kılınc & Altıparmak, 2020: 219).

Çevre vergisinin, OECD ülkelerinde görünümü üç aşamada gerçekleşmiştir. Birinci aşama 1970 ile 1980 arasında olup, bu zaman içerisinde ilk etapta kirleten öder ilkesi benimsenmiştir. İkinci aşama ise 1980'den başlayıp 1990'ların ortasına kadar devam etmektedir. Bu dönemde OECD ülkeleri kirlilik vergisi, üretim vergisi ve enerji vergisi gibi çeşitli vergilerle çevreyi korumayı ve insanlara örnek olmayı amaçlamıştır. Üçüncü aşama 1990'ların ortasından günümüze kadar olan dönemi nitelendirmektedir. Bu dönemde kapsamlı bir şekilde çevreye yönelik olarak vergi sistemi oluşturulmaya çalışılmış ve birçok OECD ülkesi çevrenin korunmasına ilişkin politikalar geliştirmiştir. (He et al., 2019: 49). Dışsal etkilerin böylelikle içselleştirilmesinin sağlanması düşünülmüştür (Mutlu, 2006: 64). 1980'lerden, 1990'ların ilk yarısına kadar çevre duyarlılığı olan OECD ülkesi sayısı artmış, çevre vergileri daha fazla alanda kabul görmeye başlamıştır. 1990'ların ilk yarısından itibaren ise bu vergilere ilişkin politikalar ön plana çıktığı için bir sistem dahilinde ele alınmaya çalışılmıştır.

Çalışmada çevre vergileri, ekonomik büyüme ve karbon emisyonu arasındaki ilişki değerlendirilmiştir. Çevresel kaliteyi artırabilmek için ortaya konulan önemli unsurlardan birisi de çevre vergileridir. Çevre vergilerinin artması ve çevreye yönelik olarak uygulamaların ön plana çıkartılması hükümetlerin bir anlamda çifte kazanç sağlamalarına yol açmaktadır. Buna göre çevre vergileri çevre kirliliğinin daha az olmasına olanak sağlamasının yanı sıra aynı zamanda gelir vergisi üzerindeki çarpıklıkları da hafifleterek ekonomik büyümeyi teşvik etmektedir (Bovenberg, 1997: 208). Çevre vergileri ekonominin büyümeyi yavaşlatmadan da çevrenin korunmasında etkili olabilmektedir. Tahribatı sağlayan unsurlardan alınan vergilerin artırılması ile çevreyi korumayı ön plana çıkaran teknolojilere bağlı olarak verimlilik artışlarının ortaya çıkacağı ve böylelikle üretim hacminin artacağı düşünülmektedir. Ayrıca uygulanan çevre politikaları ile birlikte çalışanların sağlıklı bir ortamda çalışmaları sağlanarak verimliliklerinin artacağı ve böylelikle üretim kapasitesinin artacağı düşünülmektedir. Ülkelerin sahip olduğu kaynakları Araştırma- Geliştirme faaliyetlerine ayırmaları sonucunda çevresel kaliteyi ön plana çıkaran üretim süreçleri ortaya çıkmakta ve ekonomi politikaları açısından çevre vergilerinin büyüme üzerindeki etkisi daha fazla hissedilir bir hale gelmektedir. (Bedir & Güneş, 2016: 10-11). Dolayısıyla çevre vergilerinin ekonomik büyüme üzerindeki etkisinin olumlu yönde olacağı düşünülmektedir. Aynı zamanda gelişmiş ülkeler ile gelişmekte olan ülkeler arasındaki farklılığın ne yönde seyredeceği önem arz etmektedir. Çevre vergilerinin ekonomik büyümeyi olumlu etkilemesine karşın karbon emisyonunun değişkenin etkisinin ise negatif yönlü olacağı düşünülmektedir. Bu durum Omri (2013), Tiwari (2011) ve Pala (2018) sonuçları ile örtüşmektedir.

Yapılan çalışmada 34 OECD ülkesi için ve 1995-2020 dönemi ele alınarak inceleme yapılmıştır. Çevre vergilerinin ekonomik büyümeyi etkileyip etkilemediği karbon emisyonu ile birlikte değerlendirilmeye çalışılmıştır. Hem farklı dönemleri ele alması hem de çevre ile ilgili tüm resim harç vb. diğer unsurların toplamını ifade etmesi ve aynı zamanda

diğer bir değişken olarak karbon emisyonunu modele dahil etmesi açısından çalışma yapılan diğer çalışmalardan farklılaşmaktadır. Aynı zamanda normal dağılımın olmaması ve değişen varyans sorununun bulunmasına bağlı olarak panel kantil regresyon tahmini yapılmış ve heterojenliği dikkate alan panel nedensellik testi ile de ilişkinin yönü belirlenmeye çalışılmıştır.

2. Literatür

Yazar	Değişkenler	Yöntem ve Bulgu
Pearce (1991)	Çevre Vergileri, Karbon Emisyonu ve Ekonomik Büyüme	Çift getiri hipotezini incelemiş ve bu hipotez sonucunda hem çevrenin iyileşeceğini hem de ekonomik kalkınmanın gerçekleşeceğini belirtmiştir.
Patuelli (2005)	Çevre vergileri, Karbon Emisyonu, İstihdam, Firmaların Yatırımları ve Gayri Safi Yurtiçi Hasıla	Meta analiz yöntemini kullanmış ve 1992-2000 yılları kapsayan analizi sonucunda vergi ve geri dönüşüm politikalarının toplam etkisinin ekonomik değişkenler üzerinde anlamlı bir etkisinin olduğunu vurgulamıştır.
Morley (2010)	Çevre vergileri, Ekonomik Büyüme ve Net Tasarruflar	Panel veri yöntemi yöntemi kullanarak 1995-2006 yılları arasında OECD ülkelerin incelemiş ve analiz sonucunda kısa dönemde çevre vergilerinin ekonomik büyümeyle doğru bir ilişki bulmuşlardır.
Bekmez ve Nakipoğlu (2012)	Kişi Başına Milli Gelir, Karbon Emisyonu ve Çevre Vergileri	Vektör Otoregresif yöntem kullanarak Türkiye için 1994-2009 yılları arasında incelemiştir. Analiz sonucuna göre uzun dönemde değişkenler arasında ilişki olduğunu tespit etmiştir.
Liao ve Cao (2013)	Kentleşme, Nüfus yoğunluğu, Ticaret, Ekonomik Çevre ve Enerji ile Karbon Emisyonu	En Küçük Kareler Yöntemi (OLS) ile Genelleştirilmiş En Küçük Kareler Yöntemi kullanılmıştır. Kentleşme, Nüfus Yoğunluğu, Ekonomik Çevre, Ticaret ve Enerjinin karbon emisyonunu üzerinde etkili olduğu sonucuna ulaşılmıştır.
Stram (2014)	Vergi gelirleri ve Karbon emisyonu	Vergi gelirlerinin karbon emisyonunu azaltmada etkili olacağı ve ekonomik tercihin de bu yeni teknolojilerin dönüşümüne katkı sağlayacağını vurgulamıştır.
Castiglione vd. (2014)	Çevre vergileri ile Kişi başına Gayri Safi Yurt İçi Hasıla ve Yenilenebilir Enerji Üretimi	Çevre vergileri ile ekonomik büyüme arasında pozitif ve anlamlı yönde bir etki olduğunu ortaya koymuşlardır.
Alexeev vd. (2016)	Sermaye ve çevre vergileri	Çifte kar sistemi meydana geldiğinde çevresel paylaşımların vergi sisteminin etkinliğini artırdığını ve kamu ve özel tüketimin ortaya çıkardığı bozulmayı azalttığını belirtmiştir.
Andrei (2016)	Ekonomik büyüme, çevre vergileri, enerji üretimi ve tüketimi	Çevre vergilerinin uygulanan Granger nedensellik testi sonucunda hem GSYH'ı artırdığı hem de kirliliği azaltarak çevresel bozulmayı önlediği ortaya çıkarılmıştır.
Bedir ve Güneş (2016)	Çevre vergileri ve ekonomi büyüme	Panel veri analizi kullanılarak AB ülkeleri için 1995-2012 yılları arasında çevre vergileri ile ekonomik büyüme arasında ters yönlü ilişki bulmuşlardır.
Yıldız ve Ağ (2018)	Çevre vergileri ve ekonomik büyüme	1994-2014 yılları arasındaki verileri kullanarak Johansen Eşbütünlük Testi, Tam Değiştirilmiş EKK teknikleri ile araştırılmış ve yapılan analiz sonucunda büyüme oranındaki artışla birlikte çevre vergilerinin de arttığını ortaya koymuşlardır.
Kirchner vd. (2019)	Karbon vergisi, eşitlik ve makroekonomik göstergeler	Avusturya için Dinamik Keynes Modeli kullanarak çevre vergilerinin etkilerini incelemiş ve yapılan analiz sonucunda iyi düzenlenmiş çevre vergisinin Avrupa Birliği'nin karbon emisyonu başarmada etkili olacağını vurgulamışlardır.
Aubert ve Assouline (2019)	Çevre vergisi ve gelir dağılımı	Çevre vergisi reformunun sonuçları ile etkileri eksik ve heterojen emek piyasası için değerlendirmiş ve vergi reformunun azaan şekilde olduğu durumda çifte kazançtan elde edilen sonuçların Pareto optimumuna ulaştırileceğini belirtmişlerdir.
Labeaga ve Labandeira (2020)	Çevre vergileri	Çevre vergilerinin temiz teknolojilerin geliştirilmesine katkıda bulunduğunu belirtmektedir.
Mirović vd. (2021)	Çevre vergileri ve ekonomik büyüme	28 Avrupa Birliği üyesi ülkeler 1994-2018 yılları arasında panel eşbütünlük testi yapılarak analiz etmiştir. Analiz sonucunda çevre vergilerinin ekonomik büyümeyi olumlu yönde etkilediğini ortaya koymuşlardır.
Gül ve Akyol (2022)	Çevre vergileri, ekonomik büyüme ve yolsuzluk	OECD ülkeleri için 1995-2019 yılları arasında bir panel veri tahmincileri kullanarak bir çalışma yapmış ve çalışma sonucunda çevre vergilerinin ekonomik büyüme üzerinde farklılaştığını göstermiştir.
Mirović vd. (2023)	Çevre vergileri ve Ekonomik Büyüme	28 Avrupa Birliği ülkesi için panel veri tekniğini kullanarak analiz yapmış ve analiz sonucunda uzun dönemde çevre vergilerinin ekonomik büyümeyi etkilediğini belirtmiştir.

Kaynak: Yazarlar tarafından oluşturulmuştur.

3. Veri Seti ve Yöntem

Bu çalışmada OECD'ye üye olan 38 ülkeden veri yetersizliği nedeniyle 34 ülke seçilmiş olup, 1995-2020 yılları arasında çevre vergileri, karbon emisyonu ve ekonomik büyüme arasında bu ülkelerde ilişki belirlenmeye ve ilişkinin olması durumunda ilişkinin yönünün hangi yönde olduğu gösterilmeye çalışılmıştır.

Çevre vergilerini göstermek üzere toplam çevre vergilerinin miktarı alınırken, ekonomik büyüme verisi için sabit değerlerle kişi başına GSYH analize dâhil edilmiş ve diğer çalışmalardan farklı olarak karbon emisyonu da bu model içerisinde değerlendirilmeye çalışılmıştır. Çevre vergileri OECD veri tabanından elde edilmiş olup bu veriler çevre ile ilgili ücretler, harçlar, ticari izinler ile çevreye ilişkin verilen teşvikleri ve gönüllü uygulamaları içermektedir. Aynı zamanda enerji, ulaştırma, hava kirliliği ve kaynaklar üzerinden alınan çevre vergilerinin toplamını içermektedir. Ekonomik büyümeyi hesaplamak için 2015 sabit değerlerle kişi başına GSYH modelde kullanılmış, karbon emisyon verileri ise BP (British Petroleum) sitesinden temin edilmiştir. Bütün veriler, esnekliğin artırılabilmesi, analizde yer alan serilerin birbirine yakınsaması ile doğrusallığın artırılması ve küçük değerlerle çalışılabilmesi sebebiyle logaritmik değerleri alınarak ortaya konulmuştur. Aynı zamanda Mirovic (2021) ve Mirovic (2023) çalışmalarından yola çıkılarak ve karbon emisyonu araç değişkeni olarak kullanılarak aşağıdaki model tahmin edilmiştir.

$$\ln gdp_{it} = \alpha_{it} + \beta_1 \ln cev_{it} + \beta_2 \ln carb_{it} \quad (1)$$

Yukarıdaki modelde $\ln gdp_{it}$ i ülkesinin, 2015 yılının t dönemine ait kişi başına düşen geliri (2015 sabit fiyatlarla) bağımlı değişkeni, $\ln cev_{it}$ i ülkesinin t dönemindeki toplam çevreye ilişkin vergi gelirlerini (milyon dolar), $\ln carb_{it}$ ise i ülkesinin t dönemindeki karbon emisyon miktarları da bağımsız değişkenleri (milyon ton) ifade etmektedir. Çalışmada ortaya konulan veriler arasındaki ilişkiler panel veri analiziyle tahmin edilmiştir.

3.1. Yöntem

Çalışmada öncelikle serilerle ilgili tanımlayıcı istatistikler ortaya konulmuş, sonrasında aralarında bir korelasyon ilişkisinin olup olmadığı korelasyon matrisi çerçevesinde değerlendirilmiştir. Aşağıdaki Tablo 1'de serilere ilişkin istatistikî değerler bulunmaktadır.

Tablo: 1
Tanımlayıcı İstatistikler

	$\ln gdp$	$\ln cev$	$\ln carb$
Ortalama	10.15077	8.572388	4.505602
Ortanca	10.39777	8.774506	4.159957
Maximum	11.62998	11.94886	8.680029
Minimum	8.282379	-9.73989	0.595894
Standart Sapma	0.766248	2.238503	1.563726
Skewness	-0.40698	-3.52075	0.232459
Kurtosis	2.254533	27.93449	3.095387
Jarque-Bera	44.87245	24.72664	8.296612
Probability	0.000*	0.000*	0.015791**
Gözlem	884	884	884

Not: * Yazarlar tarafından hesaplanmıştır. *%1 ve **%5 düzeyine göre anlamlılıklarını göstermektedir.

Değişkenlerin istatistikî bilgilerine baktığımızda, $\ln gdp$ 'nin ortalama değeri 10.15077 iken, $\ln cev$ 'in 8.572388 ve $\ln carb$ 'ın da 4.505606 şeklinde gerçekleştiği görülmektedir. Bağımlı değişken olan $\ln gdp$ 'nin maksimum değeri 11.62998 olurken, diğerlerinin ise sırasıyla 11.94886 ve 0595894 olduğu, minimum değerlerinin ise $\ln gdp$ 'de

8.282379, Incev'de -9.73989 ve Incarb'da 0.595894 olarak ortaya çıktığı söylenebilmektedir. Ayrıca Jarque-Bera normallik testine bakıldığında serilerin normal dağılmadığı da ifade edilebilmektedir.

Tanımlayıcı istatistikler belirlendikten sonra çoklu doğrusal bağlantı sorununun olup olmadığını tespit etmek için korelasyon matrisi değerlendirilmeye alınmıştır. Yapılan incelemeler sonucunda değişkenlere ilişkin korelasyon katsayılarının 1'e yakın olmadığı ve bu nedenle çoklu doğrusal bağlantı probleminin ortaya çıkmadığı Aşağıdaki Tablo 2'de görülmektedir.

Tablo: 2
Korelasyon Matrisi

	Lngdp	Incev	Incarb
Lngdp	1		
Incev	0.06	1	
Incarb	0.37	0.56	1

Not: * Yazarlar tarafından hesaplanmıştır.

Değişkenlerle ilgili tanımlayıcı istatistikler ve korelasyon matrislerine bakıldıktan sonra değişkenler ve modele ilişkin yatay kesit bağımlılıklarına bakılmış hem model hem de değişkenlerle ilgili yatay kesit bağımlılığının olduğu sonucuna varılmıştır.

3.1.1. Yatay Kesit Bağımlılığının Tespit Edilmesi

Bir ülkede meydana gelen şokun diğer ülkeleri etkileme derecesinin aynı olduğunu ve ülkelerin herhangi birinde ortaya çıkan makroekonomik bir şokun diğer ülkeleri etkilemediği varsayımı yatay kesit bağımsızlığı olarak nitelendirilmektedir. Ancak küreselleşmeyle birlikte iletişim kanallarının yoğunlaşması ve ticari faaliyetlerin hız kazanması ülkelerin birbiriyle etkileşim halinde olduğu gerçeğini ortaya koymaktadır (Menyah, 2014: 389; Koçbulut, 2016: 152). Bu bağlamda, çalışmada eşbütünleşme ve birim kök testlerine bakılmadan önce yatay kesit bağımlılığının varlığının tespit edilmesi gerekmektedir.

Yatay kesit bağımlılığı, seriler arasındaki eş bütünleşme ve birim kök var olduğunun tespiti yapılmadan önce ele alınması gerekmektedir. Çünkü seriler arasında yatay kesit bağımlılığını tespit etmeden yapılacak olan analizler, elde edilecek olan sonuçları kayda değer bir şekilde etkilemektedir (Breusch & Pagan, 1980; Pesaran, 2004).

Bu nedenle seriler arasında var olan yatay kesit bağımlılığının kesit boyutu (N), zaman boyutundan (T) küçük ise Breusch Pagan (1980) LM testiyle, kesit boyutu (N) zaman boyutundan (T) büyük olduğu durumda CDLM testiyle, kesit boyutu(N) ile zaman boyutu(T) aynı olduğu durumda ise CD testiyle değerlendirilmektedir. (Pesaran, 2004: 4). Bireysel ortalamaların sıfırdan farklı ve grup ortalaması ise sıfır olduğu Breusch Pagan testi sapmalı sonuçlar ortaya koymaktadır. Pesaran (2008), ilgili sapmayı test istatistiğine varyansı ve ortalamayı ilave ederek düzeltmesini sağlamıştır. Testin ilaveler ile düzeltilmiş

şekli LMadj şeklinde ifade edilmektedir. (Pesaran, 2008: 109). Bu çalışmada 34 ülke (N=34) ve 26 dönem (T=26) olduğu için CDLM testi ile LMadj testinden yararlanılmıştır.

Pesaran (2008), test istatistiğine ortalamayı ve varyansı ve ilave ederek bu sapmayı düzeltmiştir. Testin düzeltilmiş hali ise LMadj şeklinde ifade edilmektedir. (Pesaran, 2008: 109).

Yatay kesit bağımlılığını belirlemek için hipotezler aşağıdaki şekildedir:

H_0 = Yatay Kesit Bağımlılığı yoktur,

H_1 = Yatay Kesit Bağımlılığı vardır.

Testlerden elde edilen olasılık değerleri %1, %5 ve %10'deki istatistiki değerlerden anlamlılık olarak küçük olması durumunda yatay kesit bağımlılığının olduğu sonucuna varılır. Tablo 3'te Yatay Kesit Bağımlılığı testi sonuçlarına göre hem birim hem de model bağlamında yatay kesit bağımlılığının olduğu sonucuna varılmıştır.

Tablo: 3
Yatay Kesit Bağımlılığının Sonuçları

Testler/Değişkenler	lngdp	Incev	Incarb	Esbütünleşme Denklemi
LM Testi	1323.917(0.000)*	4430.567(0.000)*	827.205(0.000)*	701.891(0.000)*
CD_M Testi	22.776(0.000)*	115.522(0.000)*	7.947 (0.000)*	14.783(0.000)*
CD Testi	-0.261(0.397)*	49.825(0.000)*	-2.412(0.008)*	-2.575(0.005)*
LMadj Testi	4.451(0.000)*	1.932 (0.027)*	13.356(0.000)*	6434(0.000)*

Not: * %1 ve %5 anlamlılık düzeyinde yatay kesit bağımlılığı sonuçlarını göstermektedir.

3.1.2. Panel Birim Kök ve Delta Testleri

Yatay Kesit Bağımlılığı test edildikten sonra serilerin durağanlık analizi için ikinci nesil birim kök testlerinin kullanılması gerekmektedir. Bu testler, CADF, SURADF, Hadri ve Kurazomi (2012) şeklinde belirtilebilmektedir.

Bu çalışmada ekonomik büyüme, çevre vergileri ve karbon emisyonu arasındaki ilişki yatay kesit bağımlılığının olması nedeniyle CADF birim kök testi (Pesaran, 2007) ile tespit edilmiştir.

CADF testi ile paneli oluşturan serilerdeki her bir yatay kesit biriminde birim kök testi yapılmasına olanak tanımaktadır. Serilerin durağanlığı hem yatay kesit için hem de paneli geneli için incelenebilmektedir.

$T > N$ ve $N > T$ olduğu durumlarda da CADF test uygulanabilmektedir. Aynı zamanda bu test her bir ülkenin zaman etkilerinden farklı bir şekilde etkilendiğini varsaymakla birlikte mekânsal otokorelasyonu da dikkate alan bir testtir.

$$Y_{i,t} = (1 - \phi_i)\mu_i + \phi_i Y_{i,t-1} + u_{it} \quad i = 1, 2, \dots, N \text{ ve } t = 1, 2, \dots, T \quad (2)$$

$$u_{it} = \gamma_{if} + \epsilon_{it} \quad (3)$$

$$Y_{i,t} = (1-\phi_i)\mu_i + \phi_i y_{i,t-1} + u_{it} \quad i = 1, 2, \dots, N \text{ ve } t = 1, 2, \dots, T \quad (2)$$

$$uit = yift + it \quad (3)$$

Denkleme göre, it , bireysel spesifik hataları ifade ederken ft , gözlenemeyen ortak etkileri belirtmektedir. Denklem (3) ve denklem (4)' e ait birim kök hipotezleri aşağıdaki gibi gösterilmektedir.

$$\Delta y_{it} = \alpha_i + \beta_i y_{it,t-1} + \gamma ift + it \quad i = 1, 2, \dots, N \text{ ve } t = 1, 2, \dots, T \quad (4)$$

$H_0: \beta_i = 0$ tüm i 'ler için seri durağan değildir.

$H_1: \beta_i < 0$ seri durağandır $i=1, 2, \dots, N_1, \beta_i = 0,$

$i = N_1+1, N_1+2, \dots, N$

Ülkelere ait her bir yatay kesit için birim kök test istatistiklerinin ortalaması alınmaktadır. Panelin genelini ifade eden CIPS testi ile birim kök hesaplamaları yapılabilmektedir CIPS test istatistiği de aşağıdaki gibidir.

$$CIPS(N,T) = t\text{-bar} = N^{-1} \sum_{i=1}^N t_i(N,T) \quad (5)$$

Panelin geneli için oluşturulan CIPS testi ve Pesaran (2007) tarafından elde edilen kritik değerler Tablo 4'te gösterilmiştir. Burada hesaplanan değerler kritik tablo değerlerinden mutlak değer olarak büyük olması sonucunda temel hipotez (seride birim kök vardır) reddedilmekte ve alternatif hipotez (birim kök yoktur) kabul edilmektedir (Pesaran, 2007: 265-312). Buna göre Tablo 4'te görüldüğü üzere paneli geneli için serilerin düzey değerinde durağan olduklarına karar verilmiştir. Serilerin durağan olduğu belirlendikten sonra aralarında bir ilişkinin olup olmadığı normal dağılımın olmadığı ve değişen varyans sorununda da^3 kullanılabilen panel kantil regresyon modeli ile tespit edilmiştir.

Tablo: 4
CADF ve CIPS Birim Kök Testi Sonuçları

	Sabit		Sabit ve Trendli	
	Gecikme	İst. Değ.	Gecikme	İst. Değ.
lngdp	3	-5.357	3	-5.484
Incev	3	-4.415	3	-4.380
Incarb	3	-3.698	3	-3.599

Not: * %1, ** %5 ve *** %10 anlamlılık düzeylerinde serilerin durağanlığını göstermektedir. CIPS testinde sabit değerler için kritik değerler sırasıyla -2.30, -2.15 ve -2.07 (Pesaran, 2007: 281). Aynı testte sabit ve trendli için kritik değerler ise sırasıyla, 2.81, -2.66 ve -2.58 şeklindedir. Ülkelerin her biri için hesaplanan CADF istatistiklerinin ortalaması panel istatistiğini oluşturmaktadır.

3.1.3. Panel Kantil Regresyon

Ekonomik büyüme, çevre vergileri ve karbon emisyonu arasındaki ilişki panel kantil regresyon modeliyle tahmin edilmiştir. Panel kantil regresyon modeli gözlenemeyen heterojenliği ve heterojen ortak değişkenleri de incelemeye izin vermektedir. Bu yöntemle

³ Değişen varyans için kullanılan White testi sonucuna göre, chiquare 356,97 olasılık değeri de 0.0000 şeklindedir. Bu durumda değişen varyans sorunun olduğu görülmektedir.

panel veri analizinde bazı gözlenemeyen ortak değişkenlerin sabit etkileri de hesaplanabilmektedir (Canay, 2011). Aynı zamanda değişkenlerin normal bir dağılım takip etmesinin gerekmemesi (Troster et al., 2018: 446; Mishra et al., 2019: 295-296; Sharif et al., 2020: 5; Banday & Kocoğlu, 2022: 6) ve bir diğer anlamda kantil regresyon modelinin kalıntılarının en küçük kareler yönteminin sıfır ortalama, sabit varyans, normal dağılım gibi geleneksel varsayımları karşılama ihtiyacının bulunmaması gibi unsurlardan dolayı bu model tercih edilmektedir. Ayrıca en küçük kareler yöntemi hata karelerinin toplamını minimize ederken, kantil regresyon modeli hatanın kesin değerini minimize eden nesnel bir fonksiyona dayanmaktadır (Opuko & Aluko, 2021: 179; İlarıslan & Yıldız, 2022: 1404-1405). Kantil regresyon yöntemi ilk olarak Koenker ve Bassett (1978) tarafından ortaya konulmuştur. Bu yöntem hem kesit hem de zaman boyutuna izin verecek şekilde Koenker (2004) tarafından panel formuna dönüştürülmüştür. Ayrıca 2011 yılında bu modeli sabit etkilerle birlikte koşullu kantil regresyon olarak aşağıdaki şekilde yeniden ortaya koymuştur.

$$Q_{ij}(\tau | x_{ij}) = \alpha_i + x_{ij}^T \beta(\tau) \quad j = 1, \dots, m_i \quad i = 1, \dots, n \quad (6)$$

Bu model çeşitli kantilleri eşanlı olarak test etmek için yeniden çözümlenmiş ve α 'ların cevabın koşullu kantilleri üzerinde saf bir konum kaydırma etkisine sahip olduğu belirtilmiştir. Ayrıca ortak değişken etkilerinden x_{ij} 'nin ilgili τ kantil değerine bağlı olmasına izin verilmektedir. Denklemin çözümü aşağıdaki şekilde nitelendirilebilmektedir (Koenker, 2011: 6).

$$\min_{(\alpha, \beta)} \sum_{k=1}^q \sum_{j=1}^n \sum_{i=1}^{m_j} \rho_{\tau_k}(j_{ij} - \alpha_i - x_{ij}^T \beta(\tau_k)) \quad (7)$$

Denklemden, $\rho_{\tau_k}(u) = u(\tau - I(u < 0))$ olarak tanımlanmakta aynı zamanda $\rho_{\tau_k}(u) = u(\tau - 1) u < 0$ 'de nitelendirilmektedir. $\rho_{\tau_k}(u) = u(\tau) u > 0$ olduğunda belirtilebilmektedir (Gökçe & Uyar, 2017: 369; Tekin & Baştaç, 2022: 201-202). Değişkenler arasındaki ilişki panel kantil regresyon ve karşılaştırmak için OLS tahmin sonuçları ile incelenmiş ve tahmin sonuçları aşağıdaki Tablo 5'te verilmiştir.

Tablo: 5
Panel Kantil Regresyon Sonuçları

Kantiller	İngdp	Katsayı	Standart Hata	t İstatistiği	P
OLS⁴	InceV	0.171197	0.012666	13.51573	0.000*
	Incarb	-0.109619	0.018132	-6.045487	0.000*
	Sabit	9.177099	0.095111	96.48786	0.000*
q10	InceV	0.6346669	0.0386504	16.42	0.000*
	Incarb	-0.5245891	0.0441007	-11.9	0.000*
	Sabit	6.332783	0.1864025	33.97	0.000*
q20	InceV	0.6258859	0.0348489	17.96	0.000*
	Incarb	-0.49888	0.0463685	-10.76	0.000*
	Sabit	6.487825	0.1329828	48.79	0.000*

⁴ En Küçük Kareler Yöntemini göstermektedir.

q30	InceV	0,5976777	0,0615128	9,72	0,000*
	Incarb	-0,4321171	0,0681727	-6,34	0,000*
	Sabit	6,59772	0,2339958	28,2	0,000*
q40	InceV	0,6047658	0,0812145	7,45	0,000*
	Incarb	-0,4509593	0,0911758	-4,95	0,000*
	Sabit	6,749542	0,3217391	20,98	0,000*
q50	InceV	0,5141877	0,0615329	8,36	0,000*
	Incarb	-0,426587	0,0609585	-7,00	0,000*
	Sabit	7,627038	0,3268735	23,33	0,000*
q60	InceV	0,3970026	0,090071	4,41	0,000*
	Incarb	-0,3589564	0,0784434	-4,58	0,000*
	Sabit	8,530285	0,5036237	16,94	0,000*
q70	InceV	0,2146435	0,0973675	2,2	0,028**
	Incarb	-0,2218322	0,0906648	-2,45	0,015**
	Sabit	9,685565	0,4957512	19,54	0,000*
q80	InceV	0,0866761	0,0515943	1,68	0,093***
	Incarb	-0,1061391	0,048775	-2,18	0,030**
	Sabit	10,43663	0,2784773	37,48	0,000*
q90	InceV	0,0931034	0,0160923	5,79	0,000*
	Incarb	-0,123542	0,0170679	-7,24	0,000*
	Sabit	10,79178	0,1441024	74,89	0,000*
q95	InceV	0,0976924	0,0107832	9,06	0,000*
	Incarb	-0,1399128	0,0111286	-12,57	0,000*
	Sabit	10,93924	0,1116972	97,94	0,000*

Not: * %1, ** %5, *** %10 düzeyinde anlamlılıklarını göstermektedir.

Kaynak: Yazarlar tarafından oluşturulmuştur.

Tabloda yer alan sonuçlara göre karbon emisyonu ile ekonomik büyüme arasında ters yönlü bir ilişki bulunmuştur. Çevre vergileri ile ekonomik büyüme arasında ise doğru yönlü bir ilişkinin olduğu görülmektedir. Bu bağlamda çevre vergileri ekonomik büyümeyi düşük kantil düzeyinde 0.63, 0.62, 0.59 şeklinde yüksek bir şekilde etkilerken, yüksek kantil düzeylerinde bu etkinin azaldığı 0.08, 0.09 olarak gerçekleştiği ve çevre vergilerinin etkinliğinin düştüğü söylenebilir.

Karbon emisyonuna baktığımızda ise düşük kantil düzeylerinde karbon emisyonunun ekonomik büyüme üzerindeki etkisi daha fazla iken yüksek kantil düzeylerinde bu oran daha az olmaktadır. Bir anlamda gelişmekte olan ülkelerde ekonomideki üretim hacmi artarken sera gazı salınımının da hızla arttığı görülmektedir. Ancak iklim değişikliğinin etkisiyle beraber bu ülkelerin uymaları gereken yükümlülüklerin ortaya çıkması ve toplumsal duyarlılıkların artması ile beraber çevre vergilerinin ön plana çıkmaya başladığı ve çevre dostu teknolojilerin de bu ülkelerde gelişmeye başladığı söylenebilmektedir. Gelişmiş ülkelerde diğer bir deyişle yüksek kantil düzeylerinde hizmet sektörünün yoğun olması, kirliliğe neden olan teknolojilerin az gelişmiş ülkelere aktarması ve bu toplumdaki çevre bilincinin daha yüksek olması karbon emisyonunun ekonomik büyüme üzerindeki etkisinin daha sınırlı düzeyde olmasına yol açmaktadır⁵.

Şekil 1'de kantillere göre çevre vergileri ile karbon emisyonunun dağılımı görülmektedir. Şekil 1'e göre düşük kantil düzeylerinde bir anlamda gelişmekte olan ülkelerde çevre vergilerinin ekonomik büyüme üzerinde etkisi yüksek iken yüksek kantil düzeylerinde bu etki azalmaktadır. Ekonomik büyümenin karbon emisyonu üzerindeki etkisine baktığımızda ise düşük kantil düzeylerinde (0.50)'a kadar etki yüksek iken yüksek

⁵ Çalışmamızda yer alan kişi başına düşen gelire bağlı olarak oluşturulan OECD içerisindeki gelişmiş ve gelişmekte olan ülkeler grubu Ek 1'de yer almaktadır.

kantillerde diğer bir deyişle gelişmiş ülkelerde bu etkinin azalarak yavaşladığı görülmektedir.

Şekil: 1
Değişkenlerin Kantil Dağılımı

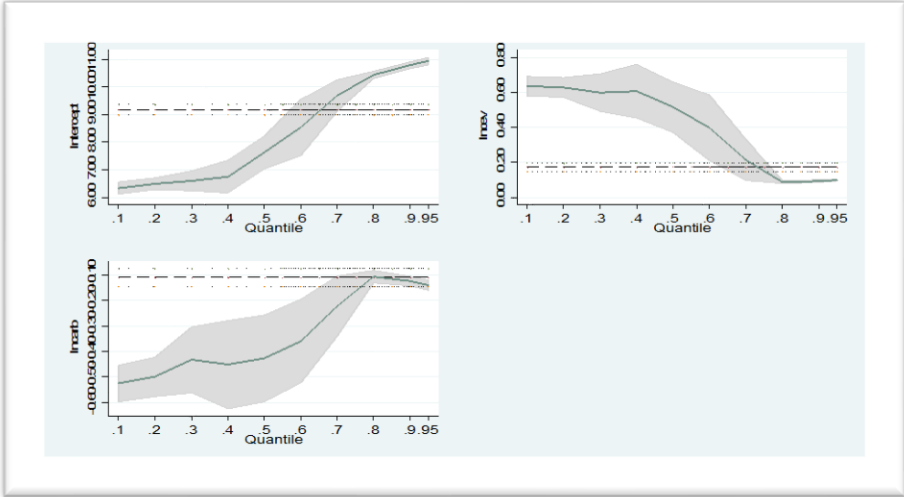

Kaynak: Yazarlar tarafından oluşturulmuştur.

3.1.4. Dumitrescu-Hurlin Nedensellik Testi

Seriler arasında nedensellik ilişkisine bakabilmek için panel veri analizlerinden öncelikle eğim katsayılarının homojen ya da heterojen olduğuna bakılması gerekmektedir. Eğim parametresi tüm birimler için sabit ise Panel Granger nedensellik analizi, eğer birimler farklılık gösteriyorsa ve eğim parametresi ülkeden ülkeye değişiyorsa bir anlamda heterojen ise Dumitrescu Hurlin (2012) nedensellik testi ile değişkenler arasındaki ilişkiye bakılması gerekmektedir (Güriş vd., 2019: 95). Swamy tarafından 1970 yılında sunulan delta testi, eğim katsayısının eşbütünleşme denkleminde homejenlik durumunu ifade etmeye yaramaktadır. Delta testini, Pesaran ve Yamagata tekrar düzenlenmiştir (Boz vd., 2019: 1118). Yeniden düzenlenen delta istatistiği ile Pesaran ve Yamagata (2008), bu hipotezleri test edebilmek için büyük ve küçük örneklem için farklılaşan iki farklı test istatistiği daha geliştirmiştir.

$$\text{Büyük örneklem için: } = \hat{\Delta} \sqrt{N} \left(\frac{N-1 \bar{S}-k}{2k} \right) \sim X^2_k$$

$$\text{Küçük örneklem için: } \hat{\Delta}_{adj} = \sqrt{N} \left(\frac{N-1 \bar{S}-k}{v(T,K)} \right) \sim N(0,1) \quad (8)$$

Burada N; yatay kesit sayısını ifade ederken, S; Swamy test istatistiğini, k; açıklayıcı değişken sayısını ve $v(T,K)$ ise standart hatayı göstermektedir. Tablo 6'da

verilen homojenlik testi sonuçlarına göre H_0 hipotezi reddedilmiştir. Reddedilme ile ilişkili olarak, eşbütünleşme denkleminde sabit terim ile eğim katsayılarının heterojen olduğu sonucuna varılmıştır.

Tablo: 6
Homojenlik Testi Sonuçları

Testler	Test İstatistiği	Olasılık Değeri
$\hat{\Delta}$ Testi	46.332	0.000*
$\hat{\Delta}_{adj}$ Testi	50.200	0.000*

Not: * %1 ve %5 seviyesine göre H_0 hipotezinin reddedildiğini göstermektedir.

Bu test aynı zamanda $N>T$ ve $N<T$ olduğu durumda ve dengesiz panellerde de etkin çözüm üretebilmektedir. Testin sıfır hipotezi değişkenler arasında nedensellik ilişkisinin olmadığını belirtirken, alternatif hipotez var olduğunu ortaya koymaktadır (Dumitrescu & Hurlin, 2012: 1451-1452; Bhujabal et al., 2021: 10; Iqbal et al., 2022: 15).

Dumitrescu Hurlin panel nedensellik test etmek için aşağıdaki model oluşturulmuştur.

$$y_{i,t} = \alpha_i + \sum_{k=1}^K \gamma_i^{(k)} y_{i,t-k} + \sum_{k=1}^K \beta_i^k x_{i,t-k} \quad (9)$$

$\beta_i = \beta_i^{(1)}, \beta_i^{(2)}, \dots, \beta_i^{(k)}$ şeklindedir. k belirlenen optimal gecikme uzunluğu olup, α_i birim etkilerini, $\gamma_i^{(k)}$ gecikme katsayılarını ve $\beta_i^{(k)}$ regresyon eğim katsayıları olarak nitelendirilebilmektedir.

$$H_0 = \beta_i = 0 \quad \forall i = 1, 2, \dots, N \quad (10)$$

$$\beta_i = \beta_i^{(1)}, \beta_i^{(2)}, \dots, \beta_i^{(k)}$$

$$H_1: \beta_i = 0 \quad \forall i = 1, 2, \dots, N, \beta_i \neq 0 \quad \forall i = 1, 2, \dots, N \quad (11)$$

$N_1=0$ olduğu durumda homojen panel nedensellik durumu ortaya çıkacağından panelin tüm birimleri için geçerli olmuş olacaktır. Ancak $N_1>0$ olduğunda nedensellik tüm birimler açısından gözlenebilirken, regresyon modeli ve nedensellik ilişkileri birbirinden farklı olarak ortaya çıkmaktadır.

Dumitrescu Hurlin nedensellik testinin farklı gecikme değerlerine göre sonuçları aşağıdaki Tablo 7'de verilmiştir. Nedensellik testi sonuçlarına göre gecikme sayısı 1 olduğunda çevre vergileri ile ekonomik büyüme, ekonomik büyüme ile de çevre vergileri arasında çift yönlü bir Granger nedensellik ilişkisi olduğu görülmektedir. Aynı zamanda karbon emisyonu ekonomik büyüme ile çevre vergileri karbon emisyonu arasında çift yönlü bir Granger nedensellik ilişkisinin ortaya çıktığı söylenebilmektedir. Gecikme değeri ve 2 ve 3 olduğunda çevre vergilerinden ekonomik büyümeye yönelik Granger nedensellik ilişkisi

bulunmamaktadır. Aynı zamanda ekonomik büyümeden çevre vergilerine doğru bir nedensellik ilişkisinin olduğu tespit edilmektedir. Çevre vergileri ile karbon emisyonu arasında da aynı şekilde çift yönlü nedensellik ilişkisinin olduğu görülmektedir.

Tablo: 7
Dumitrescu-Hurlin Panel Nedensellik Testi Sonuçları

Gecikme=1	W-Stat.	Zbar-Stat.	Prob.
Incev→Ingdp	1,91957	2,84411	0,0045*
Ingdp→Incev	2,56595	5,08719	4,00E-07*
Incarb→Ingdp	1,76934	2,32277	0,0202**
Ingdp→Incarb	4,42248	11,5298	0,0000*
Incarb→Incev	2,42807	4,60871	4,00E-06*
Incev→Incarb	3,76947	9,26367	0,00000*
Gecikme=2	W-Stat.	Zbar-Stat.	Prob.
Incev→Ingdp	2,40667	0,39722	0,6912
Ingdp→Incev	4,11111	4,34774	1,00E-05*
Incarb→Ingdp	2,9659	1,69338	0,0904***
Ingdp→Incarb	5,11444	6,67324	3,00E-11*
Incarb→Incev	3,43717	2,7857	0,0053*
Incev→Incarb	4,69913	5,71066	1,00E-08*
Gecikme=3	W-Stat.	Zbar-Stat.	Prob.
Incev→Ingdp	3,46555	0,06471	0,9484
Ingdp→Incev	5,50682	3,63694	0,0003*
Incarb→Ingdp	4,75306	2,31786	0,0205**
Ingdp→Incarb	5,82688	4,19704	3,00E-05*
Incarb→Incev	5,65636	3,89863	0,0001*
Incev→Incarb	5,83342	4,20849	3,00E-05*

Not: * %1 ** %5, *** %10 düzeyinde anlamlılıklarını göstermektedir.

4. Sonuç

İklim değişikliğinin etkilerini yaşadığımız bu dönemde sera gazı salınımı ve bu salınımı önlemeye yönelik politikalar dünya kamuoyunda yoğun bir şekilde tartışılmaktadır. Düzenlenen toplantılarda hem gelişmiş hem de gelişmekte olan ülkelere çeşitli yükümlülükler belirtilerek sıcaklık artışının sınırlandırılması ile ilgili kararlar alınmaktadır. Ancak gelişmekte olan ülkelerin üretim hacmini artırabilmeleri ve refah seviyelerini yükseltebilmeleri için petrol, doğalgaz gibi yenilenemez enerji kaynaklarına ihtiyaç duymaktadırlar. OECD ülkelerinin içerisinde yer alan bazı ülkelerde bu bağlamda karbon emisyonunun ekonomik büyüme üzerindeki etkisi güçlü bir şekilde ortaya çıkmaktadır. Dolayısıyla bu ülkelerde çevre politikalarının ekonomi üzerinde etkisinin daha fazla olacağı söylenebilir. Yapmış olduğumuz çalışmada öncelikle karbon emisyonu, ekonomik büyüme ve çevre vergileri arasında ilişki olup olmadığını belirlemek amacıyla birim kök testleri yapıldıktan sonra serilerin normal dağılmaması ve değişen varyans sorunu olması nedeniyle Koenker (2004) tarafından ortaya konulan Panel Kantil regresyon modeli uygulanmış ve farklı kantillere göre çevre vergilerinin ve karbon emisyonunun ekonomik büyüme üzerindeki etkisi araştırılmaya çalışılmıştır. Elde edilen sonuçlara göre düşük kantil düzeylerinde diğer bir deyişle gelişmekte olan ülkelerde çevre vergilerinin etkinliğinin yüksek olduğu ortaya çıkarken, yüksek gelir düzeylerinde bu vergilerin büyümeyi olumsuz yönde etkilediği görülmektedir. Karbon emisyonu ile ekonomik büyüme arasındaki ilişkiye baktığımızda negatif yönlü olduğu söylenebilmektedir. Bu durum düşük kantil düzeylerinde yani gelişmekte olan ülkelerde karbon emisyonunun ekonomi büyüme üzerinde etkisinin daha fazla, yüksek kantil düzeylerinde ise etkisinin giderek azaldığını göstermektedir.

Gelişmiş ülkelerde çevre dostu teknolojilerin kullanımının olması ve halkın çevre bilinci düzeyi daha yüksek seviyede bulunması nedeniyle karbon emisyonunun büyüme üzerindeki etkisinin giderek azaldığı görülmektedir. Aynı şekilde gelişmekte olan ülkelerde ise ikisi arasındaki ilişkinin daha etkin olduğu ve gelişmiş olan ülkelerde olduğu gibi negatif etkilediği belirtilebilmektedir. Panel Kantil regresyon analizi sonrasında uygulanan heterojen panel nedensellik testi ile de ilişkinin yönü de değerlendirilmiştir. İlk gecikmede hem çevre vergileri hem de karbon emisyonundan ekonomik büyümeye, ekonomik büyümeden çevre vergilerine ve karbon emisyonuna doğru çift yönlü bir nedensellik ilişkisi ortaya çıkarken, aynı şekilde çevre vergilerinden karbon emisyonuna, karbon emisyonundan çevre vergilerine doğru bir nedensellik ilişkisinin olduğu görülmektedir. İkinci ve üçüncü gecikmelerde ise karbon emisyonundan ekonomik büyümeye doğru nedensellik ilişkisinin devam ettiği çevre vergileri ile ekonomik büyüme arasında ise bir ilişkinin olmadığı söylenebilmektedir. Dolayısıyla iklim değişikliği ile mücadele kapsamında hem gelişmiş hem de gelişmekte olan ülkelerin sera gazı salınımı azaltma hususunda işbirliği yapmaları ve gereken yükümlülükleri ortaya koymaları önem arz etmektedir. Bu yükümlülüklerin başında alternatif enerji kaynaklarına (güneş, rüzgâr gibi) yatırımların artırılarak enerji arzının çeşitlendirilmesi ve düşük karbonlu yeni teknolojilerin ortaya konularak enerji tasarrufunun sağlanması gerektiği söylenebilmektedir. Gelişmiş ve gelişmekte olan ülkelerin ortak bir sorumluluk alarak yükümlülüklerini yerine getirebilmeleri daha yaşanılır ve sürdürülebilir bir çevre açısından kaçınılmaz olacaktır. Bu kapsamda düzenlemelerin de çevresel tehditleri içerek şekilde yeniden gözden geçirilmesi ve üretim faaliyetlerinin de çevreye uyumlu şekilde hareket etmesi gerekmektedir. Çalışmada 38 OECD ülkesi incelenmek istenmesine karşın veri yetersizliği nedeniyle 34 ülkenin 1995-2023 yılları arasındaki verilere ulaşılabilmektedir. Bu çalışma sonucunda çevre vergilerinin ekonomik büyüme üzerindeki etkisine ilişkin Mirovic vd. (2021), Akyol ve Gül (2022) ve Mirovic vd. (2023) ile benzer sonuçlara ulaşılmış ve çevre politikalarının bu kapsamda değerlendirilmesi gerektiği kanaatine varılmıştır.

Kaynaklar

- Akyol, H. & K. Gül (2022), "Yolsuzluklar, ekonomik büyüme ve çevre vergileri ilişkisinin gözden geçirilmesi: OECD ülkeleri örneği", *Karadeniz Teknik Üniversitesi Sosyal Bilimler Enstitüsü Sosyal Bilimler Dergisi*, 12(24), 267-293.
- Alexeev, A. et al. (2016), "Environmental taxation and the double dividend in decentralized jurisdictions", *Ecological Economics*, 122, 90-100.
- Andrei, J. et al. (2016), "The Impact and Determinants of Environmental Taxation on Economic Growth Communities in Romania", *Energies*, 9(11), 902.
- Aubert, D. & M. Chiroleu-Assouline (2019), "Environmental tax reform and income distribution with imperfect heterogeneous labour markets", *European Economic Review*, 116, 60-82.
- Bachus, K. & F. Vanswijgenhoven (2018), "The use of regulatory taxation as a policy instrument for sustainability transitions: old wine in new bottles or unexplored potential?", *Journal of Environmental Planning and Management*, 61(9), 1469-1486.

- Banday, U.J. & M. Kocoglu (2022), "Modelling simultaneous relationships between human development, energy, and environment: Fresh evidence from panel quantile regression", *Journal of the Knowledge Economy*, 14(10), 1559-1581.
- Bedir, S. & H. Güneş (2016), "Çevre Vergileri ve Ekonomik Büyüme Arasındaki İlişki: AB Ülkeleri için Eşbütünlüşme ve Nedensellik Analizleri", *Finans Politik ve Ekonomik Yorumlar*, (616), 9-21.
- Bekmez, S. & F. Nakipoğlu (2012), "Çevre Vergisi-Ekonomik Büyüme İkilemi", *Gaziantep University Journal of Social Sciences*, 11(3), 641-658.
- Beladi, H. et al. (2021), "Environmental taxes and economic growth with multiple growth engines", *The BE Journal of Macroeconomics*, 21(2), 629-658.
- Bhujabal, P. et al. (2021), "ICT, Foreign Direct Investment and Environmental Pollution in major Asia Pacific countries", *Environmental Science and Pollution Research*, 28, 42649-42669.
- Bovenberg, A.L. & A. de Mooij Ruud (1997), "Environmental tax reform and endogenous growth", *Journal of Public Economics*, 63(2), 207-237.
- Boz, F.Ç. vd. (2019), "BRICS ve MIST Ülkelerinde Ar-Ge Harcamaları ile Yüksek Teknolojili Ürün İhracatı Arasındaki İlişki Üzerine Bir Araştırma", *İnsan ve Toplum Bilimleri Araştırmaları Dergisi*, 8(2), 1111-1124.
- BP (2022) *Statistical Review of World Energy*, June, <https://www.bp.com/en/global/corporate/energy_economics/statistical-review-of-world-energy.html>, 01.01.2023.
- Breuer, J. et al. (2001), "Misleading Inference from Panel Unit Root Tests with an Illustration from Purchasing Power Parity", *Review of International Economics*, 9(3), 482-493.
- Breusch, T. & A. Pagan (1980), "The Lagrange Multiplier Test and Its Applications to Model Specification in Econometrics", *Review of Economic Studies*, 47(1), 239-253.
- Canay, I.A. (2011), "A simple approach to quantile regression for panel data", *Econometrics Journal*, 14, 368-386.
- Castiglione, C. et al. (2014), "Environmental taxation in Europe: What does it depend on?", *Cogent Economics & Finance*, 2(1), 1-8.
- Cural, M. & H.E. Saygı (2016), "Avrupa Birliği'nde Çevre Vergisi Uygulamaları ve Çevre Vergilerinin Gelişimi", *Çukurova Üniversitesi Sosyal Bilimler Enstitüsü Dergisi*, 25(1), 77-92.
- Dumitrescu, E.I. & C. Hurlin (2012), "Testing for Granger Noncausality in Heterogeneous Panels", *Economic Modelling*, 29(4), 1450-1460.
- Gao, X. et al. (2019), "Tax Policy, Environmental Concern and Level of Emission Reduction", *Sustainability*, 11(4), 1-17.
- Güriş, S. vd. (2019), "Üçüz Açıklar Hipotezinin Geçerliliğinin Analizi: Panel Veri Yaklaşımı", *Social Sciences Research Journal (SSRJ)*, 8(3), 91-101.
- Hadri, K. & E. Kurozumi (2012), "A Simple Panel Stationarity Test in The Presence of Serial Correlation and A Common Factor", *Economics Letters*, 115, 31-34.
- He, P. et al. (2019), "Does the double dividend of environmental tax really play a role in OECD countries? A study based on the panel ARDL Model", *Ekoloji*, 28(107), 49-62.

- Iqbal, A. et al. (2022), "Investigating the nexus between CO2 emissions, renewable energy consumption, FDI, exports and economic growth: Evidence from BRICS countries", *Environment, Development and Sustainability*, 25, 2234-2263.
- İlarslan, K. & M. Yıldız (2022), "Yenilenebilir enerji yatırımlarının finansal belirleyicileri üzerine karşılaştırmalı bir analiz: Asya-Pasifik ve Latin Amerika ülkeleri", *Business & Management Studies: An International Journal*, 10(4), 1397-1415.
- Jamali, T. (2007), *Ekolojik Vergiler*, Yaklaşım Yayınları, Ankara.
- Kahouli, B. (2017), "The short and long run causality relationship among economic growth, energy consumption and financial development: Evidence from South Mediterranean Countries (SMCs)", *Energy Economics*, 68, 19-30.
- Kılınç, E.C. & H. Altıparmak (2020), "Çevre Vergilerinin CO2 Emisyonu Üzerindeki Etkisi Üzerine Bir Uygulama", *Ordu Üniversitesi Sosyal Bilimler Enstitüsü Sosyal Bilimler Araştırmaları Dergisi*, 10(1), 217-227.
- Kirchner, M. et al. (2019), "CO2 taxes, equity and the double dividend-Macroeconomic model simulations for Austria", *Energy Policy*, 126, 295-314.
- Koçbulut, Ö. & H. Altıntaş (2016), "İkiz Açıklar ve Feldstein-Horioka Hipotezi: OECD Ülkeleri Üzerine Yatay Kesit Bağımlılığı Altında Yapısal Kırımlı Panel Eşbütünlük Analizi", *Erciyes Üniversitesi İktisadi ve İdari Bilimler Fakültesi Dergisi*, 48, 145-174.
- Koenker, R. & G. Bassett Jr (1978), "Regression Quantiles", *Econometrica*, 46(1), 33-50.
- Koenker, R. (2004), "Quantile regression for Longitudinal Data", *Journal of Multivariate Analysis*, 91(1), 74-89.
- Koenker, R. (2011), *Quantile Regression LSE Short Course*, CEMMAP and University of Illinois, Urbana-Champaign.
- Labeaga, J. & X. Labandeira (2020), "Economics of environmental taxes and green tax Reforms", *Sustainability*, 12(1), 350.
- Liao, H. & H.-S. Cao (2013), "How does carbon dioxide emission change with the economic development? Statistical experiences from 132 countries", *Global Environmental Change*, 23(5), 1073-1082.
- Menyah, K. et al. (2014), "Financial Development, Trade Openness and Economic Growth in African Countries: New Insights from a Panel Causality Approach", *Economic Modelling*, 37, 386-394.
- Mirović, V. et al. (2021), "Panel Cointegration Analysis of Total Environmental Taxes and Economic Growth in EU Countries", *Economic Analysis*, 54(1), 92-103.
- Mirović, V. et al. (2023), "Implications of Environmental Taxation for Economic Growth and Government Expenditures in Visegrad Group countries", *Politická Ekonomie*, 71(4), 422-446.
- Mishra, S. et al. (2019), "Does oil price impede Islamic stock indices? Fresh insights from wavelet-based quantile-on-quantile approach", *Resources Policy*, 62, 292-304.
- Mitić, P. et al. (2019), "A literature survey of the environmental Kuznets curve", *Economic Analysis*, 52(1), 109-127.
- Morley, B. & S. Abdullah (2010), "Environmental taxes and economic growth: evidence from panel causality tests", *Bath Economics Research Papers*, No: 04/10.

- Mutlu, A. (2006), "Küresel kamusal mallar bağlamında sağlık hizmetleri ve çevre kirlenmesi: Üretim, finansman ve yönetim sorunları", *Maliye Dergisi*, 150, 53-78.
- OECD (2021), <<https://stats.oecd.org/Index.aspx?DataSetCode=ERTR>>, 01.01.2023.
- Omri, A. (2013), "CO2 emissions, energy consumption and economic growth nexus in MENA countries: Evidence from simultaneous equations models", *Energy Economics*, 40, 657-664.
- Opoku, E.E.O. & O.A. Aluko (2021), "Heterogeneous effects of industrialization on the environment: Evidence from panel quantile regression", *Structural Change and Economic Dynamics*, 59, 174-184.
- Özdemir, B. (2009), "Küresel kirlenme sürdürülebilir ekonomik büyüme ve çevre vergileri", *Maliye Dergisi*, 156(1), 1-36.
- Pala, A. (2018), "Gelişmekte Olan Ülkelerde Enerji Tüketimi, Karbon Emisyonu ve Ekonomik Büyüme İlişkisinin ARDL Yaklaşımı İle İncelenmesi", *Ekonomik ve Sosyal Araştırmalar Dergisi*, 14(Özel Sayı), 1-29.
- Patuelli, R. (2005), "Environmental tax reform and the double dividend: A meta-analytical performance assessment", *Ecological Economics*, 55(4), 564-583.
- Pearce, D. (1991), "The role of carbon taxes in adjusting to global warming", *The Economic Journal*, 101(407), 938-948.
- Pesaran, M.H. & T. Yamagata (2008), "Testing slope homogeneity in large panels", *Journal of Econometrics*, 142(1), 50-93.
- Pesaran, M.H. (2004), "General diagnostic tests for cross section dependence in panels", *University of Cambridge Working Paper*, 0435.
- Pesaran, M.H. (2007), "A simple panel unit root test in the presence of cross-section dependence", *Journal of Applied Econometrics*, 22(2), 265-312.
- Pesaran, M.H. et al. (2008), "A bias-adjusted LM test of error cross-section independence", *The Econometrics Journal*, 11(1), 105-127.
- Popescu Ljungholm, D. (2015), "Pay-for-performance in the public sector. Geopolitics", *History and International Relations*, 7(1), 90-95.
- Sharif, A. et al. (2020), "The renewable energy consumption-environmental degradation nexus in Top-10 polluted countries: Fresh insights from quantile-on-quantile regression approach", *Renewable Energy*, 150, 670-690.
- Stram, B.N. (2014), "A new strategic plan for a carbon tax", *Energy Policy*, 73, 519-523.
- Swamy, P.A.V.B. (1970), "Efficient Inference in a Random Coefficient Regression Model", *Econometrica*, 38(2), 311-323.
- Tekin, B. & S.N. Bastak (2022), "Panel kantil regresyon yaklaşımı ile getiriye etkileyen içsel faktörlerin modellenmesi: BIST 100 Örneği", *Karamanoğlu Mehmetbey Üniversitesi Sosyal ve Ekonomik Araştırmalar Dergisi*, 24(42), 194-208.
- Tiwari, K.A. (2011), "Energy Consumption, CO2 Emissions And Economic Growth: A Revisit of The Evidence From India", *Applied Econometrics and International Development*, 11(2), 165-189.
- Troster, V. et al. (2018), "Renewable energy, oil prices, and economic activity: A Granger-causality in quantiles analysis", *Energy Economics*, 70, 440-452.

Uyar, U. & A. Gökçe (2017), “Gelişmekte olan piyasalarda enerji tüketimi ve büyüme ilişkisinin panel kantil regresyon ile incelenmesi: VISTA ülkeleri örneği”, *Pamukkale Üniversitesi Sosyal Bilimler Enstitüsü Dergisi*, 27, 364-373.

Worldbank (2022), <[https://databank.worldbank.org/source/sustainable-development-goals-\(sdgs\)/Series/NY.GDP.PCAP.KD](https://databank.worldbank.org/source/sustainable-development-goals-(sdgs)/Series/NY.GDP.PCAP.KD)>, 01.01.2023.

Yıldız, Ş. & A. Ağ (2018), “Çevre vergileri ile büyüme arasındaki ilişki: Türkiye üzerine bir analiz (1994-2014)”, *Electronic Turkish Studies*, 13(22), 591-606.

Ek: 1 OECD Ülkeleri

Gelişmiş Ülkeler	Gelişmekte Olan Ülkeler
Avustralya	Sili
Avusturya	Kolombiya
Danimarka	Yunanistan
Finlandiya	Türkiye
Fransa	Macaristan
Almanya	Litvanya
İzlanda	Letonya
İrlanda	Meksika
İtalya	Polonya
Japonya	Portekiz
Lüksemburg	Slovakya
Hollanda	Çekya
Yeni Zelanda	Slovenya
Norveç	Estonya
İsveç	
İsviçre	
İngiltere	
Amerika	
İspanya	
Belçika	

Dünyada Ulaştırma Sektöründe Kamu-Özel Ortaklığının Gelişimi¹

Duran BÜLBÜL (<https://orcid.org/0000-0002-3890-2304>), Atılım University, Türkiye;
durand.bulbul@atilim.edu.tr

Zehra AKGÜNGÖR (<https://orcid.org/0000-0003-4434-8896>), Burdur Mehmet Akif Ersoy University, Türkiye;
zakgungor@mehmetakif.edu.tr

Development of Public-Private Partnerships in the Transportation Sector in The World²

Abstract

The globalisation process in recent years has led to the formation of alternative methods of delivering public services worldwide. In the provision of public services, under the name of “public-private partnership”, the private sector has started taking a critical degree. It has become an application on the agenda of both developed and developing countries. In this respect, it is seen that the transportation sector is one of the costliest services among public services; large-scale projects have been created by applying the PPP model in the financing and development of the transportation sector in many countries. The study evaluates the PPP model in the world’s transportation sector and the increase in private participation in the transportation sector with PPP.

Keywords : Public-Private Partnership, Public Services, Transport Sector.

JEL Classification Codes : E60, E62, E69.

Öz

Dünyada son yıllarda yaşanan küreselleşme süreci kamu hizmetlerinin sunumunda alternatif yöntemlerin oluşmasına yol açmıştır. Kamu hizmetlerinin sunumunda “kamu-özel sektör ortaklığı (KÖÖ)” adı altında, özel sektör önemli derecede yer almaya başlamış olup hem gelişmiş hem de gelişmekte olan birçok ülkenin gündeminde olan bir uygulama haline gelmiştir. Bu bakımdan ulaştırma sektörünün kamu hizmetleri arasında en maliyetli hizmetlerden biri olduğu görülmekte olup, birçok ülkede ulaştırma sektörünün finansmanında ve gelişmesinde KÖÖ modeli uygulanarak büyük ölçekli projeler oluşturulmuştur. Çalışmada dünyada ulaştırma sektöründe KÖÖ modeli ve ulaştırma sektöründe KÖÖ ile özel katılımın artışı değerlendirilmeye çalışılmaktadır.

Anahtar Sözcükler : Kamu-Özel Ortaklığı, Kamu Hizmetleri, Ulaştırma Sektörü.

¹ Bu çalışma Ankara Hacı Bayram Veli Üniversitesi Lisansüstü Eğitim Enstitüsü Maliye Anabilim Dalında “Türkiye’de Kamu-Özel Ortaklığı Deneyimi: Ulaştırma Sektörü Üzerine Bir Analiz” başlığı ile sunulan doktora tezinden türetilmiştir.

² This study is derived from the “Public-Private Partnership Experience in Turkey: An Analysis of the Transportation Sector” dissertation at Ankara Hacı Bayram Veli University, the Institute of Graduate Studies, Department of Finance.

1. Giriş

20. yüzyılın sonlarında dünya genelinde kamu hizmetlerinin finansmanında alternatif yöntemler arasında yer alan KÖO modeli uygulaması gündeme gelmiştir. KÖO'ları aracılığıyla özel sektör finansmanı ulaşım, sağlık, atık su arıtımı ve içme suyu gibi kamu hizmetleri, enerji gibi sektörlerde kamu sektörü altyapısının sağlanması ve sürdürülmesi amacıyla kullanımı tüm dünyada artış gösteren bir model olmuştur. Bu bakımdan dünya çapında KÖO modelinin uygulamasında belirgin bir artış vardır. Çünkü yüksek maliyetli kamu hizmetleri birçok ülke ekonomisi içinde önemli bir paya sahiptir ve bundan dolayı yüksek maliyetli kamu hizmetlerinin bütçe üzerinde yük oluşturmadan düşük maliyet ile bu hizmetleri kullanıcılarına ulaştırmak ciddi bir problemdir. Bu probleme hem gelişmiş ülke ekonomilerinin hem gelişmekte olan ülke ekonomilerinin çözüm arayışları sonucu KÖO modeli ortaya çıkmıştır ve günümüzde birçok ülkede uygulanarak popüler hale gelmiştir.

Ulaştırma altyapısının KÖO modeli ile gerçekleştirilmesi hükümetlere mali alan yarattığı gibi eğer bu projeler doğru bir şekilde uygulanırsa ekonomik kalkınma, ticaret ve diğer faktörleri de kolaylaştıracağı için önemli ölçüde ekonomik etkisi olacaktır. Ünlüöner (1992: 331) çalışmasında ulaştırma sektörünün önemini şu şekilde belirtmiştir; "ulaştırma sektörü gelişmeyen ülkelerin kalkınmasından bahsetmek güçtür. Ulaştırma ağını bir vücudun kan dolaşımına benzetirsek ulaştırma ağı yetersiz olan ülkelerin solunum yetmezliği yüzünden hayatiyeti tehlikeye girer." Burada da belirtildiği gibi ulaştırma sektörünün gelişmesi ekonomik büyüme ve kalkınma açısından önemli olduğu kabul edilen temel hizmetler arasında yer almakta olup, devlet politikaları içinde önemli bir yer tutmaktadır. Dolayısıyla, ulaştırma altyapısı bir ülke ekonomisi için ciddi ölçüde önem arz etmesinin yanında ayrıca uluslararası ekonomide de önem arz etmektedir.

2. Kamu-Özel Ortaklığının Kavramsal Çerçevesi

Kamu alımları, birçok ülkede ekonomik faaliyetin önemli bir bölümünü kapsamaktadır ve dolayısıyla yüksek kaliteli kamu hizmetlerinin düşük maliyetle vergi mükelleflerine ve kullanıcılara nasıl ulaştırılacağı önemli bir sorun haline gelmiştir. Bu soruna çözüm bulabilmek için hem sanayileşmiş ülkelerde (örneğin; İngiltere'de 1992 yılında başlatılan Özel Finans Girişimi gibi) hem de gelişmekte olan ülkelerde (1990'larda Latin Amerika, Doğu Avrupa ve Çin gibi) yeni bir gelişme çabasıyla kamu-özel ortaklığı modeli büyümeye başlamıştır (Maskin & Tirole, 2008: 142).

Bu model hakkında literatürde genel kabul görmüş bir tanım üzerinde fikir birliği bulunmamaktadır. Dünya Bankası (DB), OECD, IMF, Avrupa Komisyonu gibi uluslararası kuruluşların ve çeşitli ülkelerin yaptığı çeşitli tanımlamalar mevcuttur.

Dünya Bankası'na göre, kamu-özel ortaklığı, bir kamu varlığını veya hizmetini sağlamak için, kamu ve özel sektör arasında, özel sektörün önemli ölçüde risk ve yönetim sorumluluğu üstlendiği ve performansla bağlantılı ödemelerin olduğu uzun dönemli sözleşme şeklinde tanımlanmaktadır (PPP RG, 2014: 5).

Kalkınma Bakanlığı tarafından yapılan tanıma göre ise KÖO, bir sözleşmeye dayalı olarak, yatırım ve hizmetlerin, projeye yönelik maliyet, risk ve getirilerinin, kamu ve özel sektör arasında paylaşılması yoluyla gerçekleştirilmesi, şeklinde ifade edilmektedir (Kalkınma Bakanlığı, 2012: 6).

Farklı tanımlamalar mevcut olmakla birlikte genel olarak kamu-özel ortaklığı, kamu hizmetlerinin veya kamu altyapısının geliştirilebilmesi için kamu ile özel sektör arasında sorumlulukların paylaşıldığı uzun vadeli bir sözleşme olup, girdi yerine proje çıktılarının belirlenmesi, özel finansman uygulaması, özellikle projenin tasarımı, inşası, işletilmesi veya finansmanı ile ilgili olarak risklerin kamu ve özel sektör arasında tahsisi ve sunulan hizmetler için özel sektörle birlikte gerçekleştirilen ortaklıktır, şeklinde genelleştirilebilir.

Yukarıda da yapılan tanımlamalardan anlaşılacağı üzere kamu-özel ortaklığı modeli hakkında hem Türkiye’de hem de uluslararası uygulamasında kapsayıcı bir tanım yapmak mümkün olmamaktadır. Bunun sebebi, kamu-özel ortaklığının gerek bütün ülkelerde farklı sektör ve projelerde değişik şekillerde yeniden tasarlanması gerekse sözleşme tipi, hazine garanti türü, kamu finansman modeli ve bir yandan da özel sektör yatırım türü niteliğinde olmasından dolayı bu kavram hakkında basit, kapsayıcı ve kısa bir tanım yapmak mümkün değildir (Bülbül, 2017: 94). Ancak KÖO tanımı üzerine son yıllarda ortak bir yaklaşıma ulaşılmıştır.

3. Ulaştırma Sektöründe Kamu-Özel Ortaklığı

Kamu varlıkları, kamu kullanımına tabi ya da tahsis edilmiş veya bir kamu hizmetinin sağlanmasına eşlik eden sabit varlıklardır³. Burada kamu varlıkları yerine aslında kamu altyapısına atıfta bulunulmakta olup, normalde bir KÖO kapsamında satın alınan kamu varlık türü olarak geniş anlamda altyapı kullanılmaktadır ve Oxford İngilizce sözlüğünde altyapı; "Bir toplumun veya işletmenin işleyişi için gerekli olan temel fiziksel ve organizasyonel yapılar ve tesisler (örneğin binalar, yollar)" şeklinde tanımlanmaktadır (APMG, 2016: 56). TDK’ya göre altyapı; "bir yerleşim yeri veya bir yapı için gerekli olan yol, kanalizasyon, su, elektrik vb. tesisatın tümü" anlamına gelmektedir.

Ekonomi literatüründe ise altyapı dar anlamda ve geniş anlamda tanımlanmaktadır. Dar anlamda altyapı; bir yatırımın gerçekleştirilebileceği yerde aranan ulaştırma (tünel, hava sahası, yol, köprü), haberleşme (telekomünikasyon), enerji, su gibi maddi olanakları ifade ederken, geniş anlamda altyapı ise ekonominin sahip olduğu ya da olması gereken ulaştırma, haberleşme, enerji, su ve kanalizasyon gibi tesisleri, eğitim ve sağlık alanlarındaki kuruluşları, ayrıca bu konularla ilgili bilgi ve beceriyi içine alan sosyal sabit sermayeyi ifade etmektedir (Aktan vd., 2005: 5).

Bir KÖO modelinin odak noktası altyapıyı geliştirmektir. Ancak bununla birlikte, birçok KÖO’ları, altyapının bu tür bir hizmetle ilgili olması veya kamu makamlarının

³ Uzun süreli kullanım için satın alınan varlıklar.

hizmeti vermesine izin veren bir platform olması durumunda, bir kamu hizmetinin yönetimini veya operasyonlarını da içermektedir. Örneğin; büyük bir ulaşım sistemindeki bir KÖO, ulaşım hizmetlerinin işletilmesi de dahil olmak üzere KÖO'nun kapsamına girmektedir (APMG, 2016: 17-18). Ayrıca ulaştırma sektöründe KÖO'ları işletmeciler, sponsorlar, bankacılar ve yatırımcılar da dahil olmak üzere giderek yoğunlaşan sayıda katılımcının elinde gibi görünmektedir (Estache et al., 2007: 23).

Gelişmekte olan ekonomilerdeki KÖO'ları başlangıçta ulaşım, savunma ve enerji sektörlerinde yoğunlaşmaktadır. Ancak KÖO'lar, ulaşım sistemlerinin, su, ısı dağıtımı, atık su ve kanalizasyon gibi belediye altyapılarının yanı sıra sağlık, eğitim ve hapishanelerin inşası veya geliştirilmesi için de kullanılabilir. Ayrıca bir KÖO sosyal, ticari ve çevresel hedeflere ulaşmak için de tasarlanabilmektedir (Grimsey et al., 2004: 221). KÖO modeli birçok ülkenin altyapı açığını kapatmanın kilit unsurlarından biri olan kamu hizmetlerinin verimliliğini artırmada çok önemli bir rol oynamaktadır. Son 25 yılda, 121 düşük ve orta gelirli ülke ekonomilerinde 5000'den fazla altyapı projesi KÖO'lar ile teslim edilmiştir ve bu projeler 1,5 trilyon dolarlık yatırım taahhüdünü temsil etmektedir. Bu model ile karayolları, köprüler, hafif ve ağır raylı sistemler, havaalanları, limanlar, enerji santralleri gibi önemli altyapıların geliştirilmesi hedeflenmektedir (PPIAF, 2017: 14). KÖO modeli genellikle her ekonomide kamu kurumunun farklı seviyeleri tarafından gerçekleştirilmekte olup, bazen de sektörel olarak yürütülmektedir (PPIAF, 2017: 16). Ancak KÖO'lar birçok ülkede uygulanmış olmasına rağmen, tüm altyapı sektörlerine eşit olarak uygulanmamaktadır. Çoğu ülkede KÖO projeleri yollar, köprüler, tüneller, demiryolları ve havaalanları gibi ulaşım projelerine odaklanmaktadır. Bununla birlikte, KÖO'ların kullanımı son yıllarda çeşitli sektörlerde genişletilmiştir. Örneğin, Kore'de KÖO'lar okulların, hastanelerin ve toplu konutların geliştirilmesinde; ABD'de hapishaneler, su temini ve atık su arıtma gibi sektörlerde kullanılmaktadır (Kwak et al., 2009: 56).

Ulaştırma altyapısı genellikle talep edilmemiş teklifler yoluyla rekabetçi bir pazarda oluşturulmaz, ancak ulusal veya bölgesel bir hükümet planına tabi olarak oluşturulmaktadır (Makovsek et al., 2014: 23). Ulaşım ise bu erişimi kolaylaştırmaktadır. Yüksek performanslı ulaşım altyapısına yapılan yatırım, maliyeti optimize etmektedir, büyüme ve gelişme için kritik olan ulaşım hizmetlerinin güvenilirliğini artırmaktadır (Juhel, 2012: 7).

IMF'nin Latin Amerika'ya odaklanan bir çalışmasında, altyapı kalitesine yapılan yatırımların sadece ekonomik büyümeyi artırmakla kalmayıp aynı zamanda genel yatırımı da artırdığı ve böylece topluma önemli ekonomik faydalar sağladığına işaret edilmektedir (ABCR, 2018: 19). Ayrıca, bir ulusun zenginliğinin, mal ve hizmetleri üretme ve tüketme yeteneğine bağlı olduğu, bu bağlamda verimli bir ulaştırma altyapısı, bu kapasitenin maksimize edilmesinde temel unsur olduğu ifade edilmektedir (ABCR, 2018: 23). Juhel, 2012 yılındaki çalışmasında da ulaştırma altyapısı ile ilgili olarak;

"Yıllar önce Etiyopya'nın o zamanki Ulaştırma Bakanı bana ulaşım bağlantılarının bölgesel ruhtaki yerini açıkladı. "Bu kadar geniş bir alana dağılmış bu kadar çok farklı etnik grup varken, hepsini birbirine bağlayan

kapsamlı bir yol ağı olmadan herkesin aynı ulusun bir parçası olduğunu hissetmesini nasıl mümkün kılabiliriz?" diye sordu. Daha sonra kendi sorusunu yanıtladı. "Yollar olmadan demokrasi olmaz" dedi. Ulaşım sektörünün sosyal, ekonomik ve politik entegrasyonu desteklediğini belirtti (Juhel, 2012: 7-8)." şeklinde ifade edilerek ulaşım ağının geliştirilmesinin birçok pozitif etkene yol açtığı belirtilmektedir.

Tablo 1'de de ulaştırma altyapısının alt sektörleri olan karayolları, havaalanları, demiryolları ve limanların özel sektör katılımının finansmanı ile birlikte KÖO gelişmelerinin görüldüğü bu alt sektörlerde gerçekleştirilen projelerin örnekleri sıralanmaktadır.

Tablo: 1
Bir KÖO Programı Kapsamında Ulaştırma Sektörü Alanının Hangi Altyapı Varlıklarına Uygulanacağı Dair Örnekler

Sektöre Göre Varlık Türü	Örnekler
Ekonomik Altyapı - Ulaştırma - Karayolları	<ul style="list-style-type: none">✓ Yeni yol/otoyollar✓ Spesifik tünel veya köprü projeleri✓ Bağlantılara erişim (örneğin, bağlantı noktalarına)✓ Yolların ve ağların iyileştirilmesi ve genişletilmesi
Ekonomik Altyapı - Ulaştırma - Demiryolları	<ul style="list-style-type: none">✓ Yüksek hızlı tren hatları✓ Ağır konvansiyonel demiryolu hatları✓ Hızlı bağlantılar (örneğin, havaalanlarına)✓ Demiryolu araçlarının operasyonel kiralaması✓ Metro ve diğer toplu taşıma projeleri✓ Biletleme ve ücret toplama sistemleri✓ Metro istasyonları
Ekonomik Altyapı - Ulaştırma - Limanlar ve Havaalanları	<ul style="list-style-type: none">✓ Yeni veya yükseltilmiş havaalanları✓ Yeni veya yükseltilmiş bağlantı noktaları
Ekonomik Altyapı - Ulaştırma - Diğer Kentsel Hareketlilik Altyapısı	<ul style="list-style-type: none">✓ Otobüs hızlı ulaşım altyapısı✓ Otopark

Kaynak: APMG, 2016: 59-60.

KÖO modeli çok çeşitli sektörlerde kullanılmaktadır ve en yaygın olarak kullanılan sektörler arasında ulaştırma sektörü yer almaktadır. Ancak ulaştırma sektörü alanında KÖO modeli ile gerçekleştirilecek olan projelerin geliştirilebilmesi ve etkin uygulanabilmesi için dikkate alınması gereken birkaç temel strateji yer almaktadır. Bunlar (Perlman & Pulidindi, 2012: 4);

- ✓ Özel sektör ortağının dikkatli bir şekilde seçilmesi,
- ✓ Potansiyel gelir akışının göz önünde bulundurulması,
- ✓ KÖO modelinin netleştirilebilmesi için paydaşlarla etkili bir şekilde iletişim kurulabilmesi,
- ✓ Sadece KÖO modeli ile ilgili olacak bir kamu yapısı oluşturulması,
- ✓ Kamu ve özel finansmanın uygun bir şekilde dengesinin korunması.

Kamu kurumları, ulaşım altyapısını geliştirmek ve yenilemek için KÖO gibi alternatif satın alma yaklaşımlarını kullanırken pek çok amaç peşinde koşmaktadırlar. Örneğin; değerlendiriciler genellikle "ekonomik verimliliğe" odaklanmaktadır (Bolaños et

al., 2019: 290). Şekil 1'de de temel performans göstergeleri doğrultusunda ulaştırma sektöründe KÖO performans adımları gösterilmektedir.

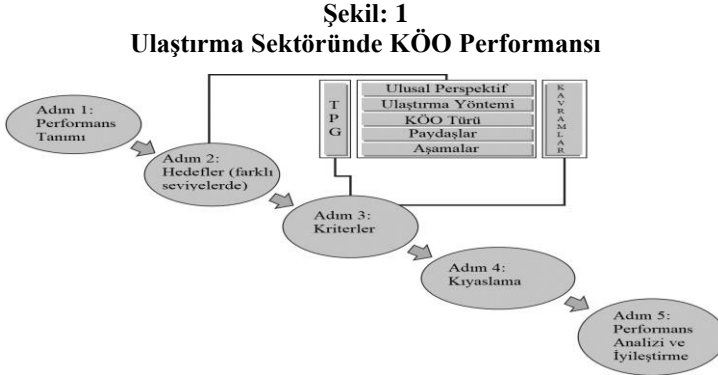

KÖO'ları, çeşitli nedenlerden dolayı, ulaştırma altyapısı projeleri ve hizmetleri sunulması amacıyla popüler yönetim modelidir (Verweij, 2020: 334). KÖO'lar ile ulaşım projelerini finanse etmenin dört evrensel faydası; (i) finansal erişim, (ii) daha hızlı ve daha az masraflı proje uygulaması, (iii) ekonomik kalkınma ve yatırım olanakları, (iv) özel sektör uzmanlığına erişim, şeklinde sıralanmaktadır. Ancak bu faydalarının yanında KÖO modelinin kullanımıyla ilişkili; (i) ulaştırma altyapısı KÖO'larına ilişkin resmi mevzuat, (ii) özel ortağın iflas veya temerrüt riski, (iii) paydaş algıları, şeklinde engeller ve riskler de bulunmaktadır (Perlman et al., 2012: 2-3-4). Bu kapsamda ulaştırma sektöründe KÖO projelerinin gerçekleştirilmesinin faydalarının yanında riskleri de bulunmaktadır ve dolayısıyla projeler gerçekleştirilmeden önce hazırlık aşamasında bütün kriterlerin değerlendirilmesi gerekmektedir.

4. Dünyada Ulaştırma Sektöründe Kamu-Özel Ortaklığı ile Özel Katılımın Artışı

Birçok ülkede yüksek maliyetli altyapı hizmetleri ekonomide önemli bir yere sahiptir. Dolayısıyla yüksek maliyetli altyapı hizmetlerinin bütçe üzerinde yük oluşturmadan düşük maliyet ile kullanıcılarına ulaştırmak da ciddi bir problemdir.

Altyapı ihtiyaçları ve finansman kısıtlamaları, gelişmekte olan ülkelerde gelişmiş ülkelere göre daha yoğun bir durumdadır. Özellikle gelişmekte olan ülkelere kamu iktisadi teşebbüslerinin performansından duyulan memnuniyetsizliğin giderek artış göstermesi ve bazı durumlarda devlet öncülüğündeki kalkınma programlarının işe yaramadığının kabul edilmesinden dolayı hükümet bütçeleri baskı altına girmiştir (Grimsey et al. 2004: 30). Bu gelişmelerle birlikte iki durum ortaya çıkmıştır (Grimsey et al. 2004: 30); (i) altyapı harcamalarının devlet bütçeleri üzerindeki etkisini azaltma arzusu (hem devlet borçlanmasını en aza indirmenin bir yolu olarak hem de ekonomik açıdan gerekli ancak

siyasi açıdan vazgeçilebilir altyapı harcamalarını genel bütçe baskılarından korumanın bir yolu olarak), (ii) hükümetlerin altyapı finansmanı için özel sermaye piyasalarına yönelmesi, olmuştur.

Gelişmekte olan ülkelerde, kamu altyapısının geliştirilmesi için sınırlı bütçeye sahip olan hükümetler, hangi altyapının geliştirilmesi gerektiğini seçmektedir ve çoğu ülkede, toplum için doğrudan ekonomik etkiye sahip olduğu düşünüldüğü, sosyal altyapıdan ziyade ekonomik altyapıya yönelmektedir (Oktavianus, 2018: 1). Uygulamada da özel sektörün kamu altyapı finansmanına katılımı onlarca yıldır KÖO şeklinde gerçekleştirilmektedir (Oktavianus, 2018: 1). Ekonomik altyapılar kapsamında bulunan ve KÖO çerçevesinde kamu hizmetinin sunumunda yer alan yollar, tüneller, köprüler, demiryolu, hava ve deniz limanları vb. ulaşım altyapısı gibi çoğu alanda dünya çapında yayılmaktadır. Ancak bu ortaklığın verimli bir şekilde sağlanabilmesi için sözleşmelerin uygun şekilde tasarlanması ve şeffaf bir şekilde raporlanması daha önce sadece kamu sektörü tarafından sağlanan hizmetlerin geliştirilmesinde faydalı bir rol oynayacaktır (Sadka, 2006: 4).

KÖO'ların küresel bir şekilde büyümesi etkileyici boyutlara ulaşmış olup, 1990'dan 2001'e kadar olan dönemde gelişmekte olan ülkelerde yaklaşık 2.500 altyapı projesine özel sektör katılmış ve bu projelerin toplam değeri 750 milyar dolar olmuştur ve bu oluşan etki sektörler arasında farklılık göstermiş olsa da bunların büyük bir kısmı KÖO'lardır (Benz et al., 2005: 2).

Grafik 1'de gelişmekte olan ülkelerdeki 2010-2019 yılları arasındaki Özel Katılımlı Altyapı (PPI) projelerinin sektörel yatırım taahhütlerinin payı gösterilmektedir. Ulaştırma sektörünün diğer altyapılar içindeki yerinin analizi yapılmaktadır. Buradaki özel katılımlı ulaşım projelerine yatırım ile; finansal olarak sona eren ve doğrudan veya dolaylı olarak halka hizmet eden ulaştırmadaki altyapı projelerine yönelik taahhütleri⁴ ifade etmektedir ve dahil edilen proje türleri ise, yönetim ve kiralama sözleşmeleri, büyük sermaye harcamalı operasyonlar ve yönetim sözleşmeleri, sıfırdan alan projeleri (özel bir kuruluşun veya bir kamu-özel ortak girişiminin yeni bir tesis inşa edip işlettiği) ve elden çıkarmalardır (The World Bank).

2010-2019 yılları arasında gelişmekte olan ülkelerdeki özel katılımlı altyapı projelerinin toplam sayısı 4.090 ve yatırım değeri de 1.072.522 milyar ABD dolardır. Bu çerçevede KÖO kapsamında olan proje sayısı ve yatırım değerleri tüm projelerin %94'ünü oluşturmaktadır (KÖO kapsamında olan proje sayısı 3.864 olup, yatırım değeri 1.003.383 milyar ABD doları, KÖO kapsamında olmayan proje sayısı ise 226, yatırım değeri ise 69.139 milyar ABD dolarıdır) (WB, 2020; 2021). 2010-2019 yılları arasında gelişmekte olan ülkelerdeki özel katılımlı altyapı projelerinin sektörel dağılımı incelendiğinde, 2019 yılında

⁴ "Yatırım taahhütleri, tesislere yapılan yatırımların ve devlet varlıklarına yapılan yatırımların toplamıdır. Tesislere yapılan yatırımlar, proje şirketinin sözleşme süresi boyunca yeni tesislere veya mevcut tesislerin genişletilmesi ve modernizasyonuna yatırım yapmayı taahhüt ettiği kaynaklardır. Devlet varlıklarına yapılan yatırımlar, proje şirketinin devlete ait işletmeler veya belirli bir alanda hizmet sağlama gibi devlet varlıklarını elde etmek için harcadığı kaynaklardır." (The World Bank).

ulaştırma sektörü, 123 projede 47,8 milyar ABD doları ile enerji sektörünü geride bırakmıştır ve bu, 2019 yılı küresel PPI yatırımlarının yarısını oluşturmaktadır. Enerji sektörü 169 projede 40,1 milyar ABD doları ile 2019 yılındaki yatırım taahhütlerinin %41'ini oluşturmaktadır. Belediye Katı Atık (MSW) sektörü 64 projede 4,7 milyar ABD doları, su sektörü 51 proje üzerinden 4,0 milyar ABD doları, BİT (Bilgi ve İletişim Teknolojileri) sektörü ise 3 proje için 174 milyon ABD doları yatırım taahhütlerinin olduğu görülmektedir (WB, 2020: 16).

Grafik 1
Özel Katılımlı Altyapı (PPI) Projelerinde Sektörel Yatırım Taahhütlerinin Payı (2010-2019)

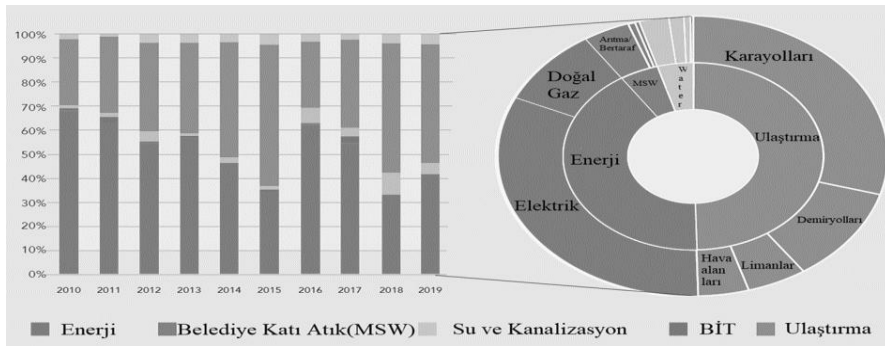

Tablo 2
1990-2020 (ilk yarısı) Yılları Arasında Düşük ve Orta Gelirli Ülkelerdeki KÖÖ'ların Sektörlere Göre Gerçekleşen Boyutu

Sektör	Proje Yatırım Değerleri (milyar ABD dolar)	Proje Sayısı
Elektrik	815.045	3.448
Ulaştırma	693.025	1.973
Su ve Kanalizasyon	97.025	1.119
Doğal Gaz	68.503	313
Bilgi ve İletişim Teknolojileri	19.144	132
Belediye Katı Atık (MSW)	7.045	48

Kaynak: DB PPI Veri Tabanındaki filtelenmiş verilerden yararlanılarak yazar tarafından hazırlanmıştır (The World Bank).

Tablo 2’de Dünya Bankası veri tabanından filtelenerek elde edilmiş olan son otuz yıldaki düşük ve orta gelirli ülkelerde gerçekleşmiş olan, KÖÖ kapsamındaki sektörler raporlanmaktadır. Dünya Bankası verilerine göre düşük ve orta gelirli ülkelerde 815.045 milyar ABD dolar ile en yüksek yatırım değeri payına sahip olan ve 3.448 proje sayısı ile de ilk sırada yer alan sektör elektrik sektörüdür. Bu sektörü takip eden ikinci sektör 693.025 milyar ABD dolar yatırım değeri, 1.973 proje sayısı ile ulaştırma sektörüdür. Bu sektörleri sırasıyla su ve kanalizasyon, doğal gaz, BİT, MSW sektörleri takip etmektedir.

Grafik 2 ve Grafik 3’te, 1990 ve 2020 (ilk yarısı) yılları arasında Dünya Bankası’nın filtelenmiş veri tabanından elde edilen veriler doğrultusunda düşük ve orta gelirli ülkelerin bölgelere göre sınıflandırılmasında ulaştırma sektörü alanındaki kamu-özel ortaklığı

projelerinin sayısı ve toplam yatırım değerinin (milyar ABD doları cinsinden) tutarları gösterilmektedir. Doğu Asya ve Pasifik, Avrupa ve Orta Asya, Latin Amerika ve Karayipler, Orta Doğu ve Kuzey Afrika, Sahra-altı Afrika ve Güney Asya ülkelerinin ekonomilerini 1990-2020 (ilk yarısı) yılları arasında ulaştırma sektörü (havaalanı, karayolu, demiryolları ve limanlar) alanında bölgelere göre incelediğimizde en yüksek proje sayısının yer aldığı bölge 584 proje sayısı ile diğer bölgeler içinde %30'luk bir dilimi kapsayan Latin Amerika ve Karayipler oluşturmaktadır. Bu bölgeyi 580 proje sayısı ile Güney Asya ve 518 proje sayısı ve %27'lik dilimle de Doğu Asya ve Pasifik takip etmektedir. En düşük proje sayısının yer aldığı bölge ise 40 proje sayısı ve diğer bölgelere göre %2'lik dilimde bulunan Orta Doğu ve Kuzey Afrika bölgesidir.

Grafik: 2
Ulaştırma Sektörü Alanında Bölgelere Göre Kamu-Özel Ortaklık Projelerin Sayısı [1990-2020 (ilk yarısı)]

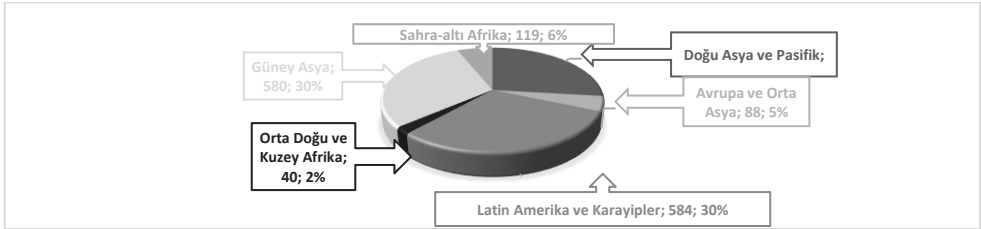

Kaynak: DB PPI Veri Tabanındaki filtrelenmiş verilerden yararlanılarak yazar tarafından hazırlanmıştır (The World Bank).

Grafik 3'te görüleceği üzere, bu bölgeler arasında ulaştırma sektörü kapsamında 1990-2020 (ilk yarısı) yılları arasında en büyük yatırım payına sahip olan bölge 243.348 milyar ABD dolar ile Latin Amerika ve Karayipler yer almaktadır. İkinci sırada 175.902 milyar ABD doları ile Doğu Asya ve Pasifik ve üçüncü sırada da 124.620 milyar ABD dolar ile Güney Asya bölgesi takip etmektedir. Bu bölgeler arasında ulaştırma sektörü kapsamında en düşük yatırım payına sahip olan bölge ise 8,351 milyar ABD dolar ile Orta Doğu ve Kuzey Afrika yer almaktadır.

Grafik: 3
Ulaştırma Sektörü Alanında Bölgelere Göre Kamu-Özel Ortaklık Proje Yatırımları [1990-2020 (ilk yarısı)]



Kaynak: DB PPI Veri Tabanındaki filtrelenmiş verilerden yararlanılarak yazar tarafından hazırlanmıştır (The World Bank).

Grafik 4'te ise bölgelerde ulaştırma altyapısının alt sektörlerine göre proje yatırımlarının 1990-2020 (ilk yarısı) yılları arasındaki dağılımı yığılmış sütunda gösterilmektedir. Doğu Asya ve Pasifik bölgesinde 1990-2020 (ilk yarısı) yılları arasında yatırım tutarlarında yüzde olarak bir azalma görülmüş olsa da, 2019 yılındaki Doğu Asya ve Pasifik bölgesinde ulaştırma sektörüne yapılan yatırımlarının bu bölgede gerçekleşen toplam KÖO yatırımlarına oranının yaklaşık %66'sını ve tüm bölgelerde gerçekleşmiş olan toplam KÖO projelerinin ise yaklaşık %30'unu ve yine tüm bölgelerde gerçekleşmiş olan ulaştırma altyapısına yapılan yatırımların %53'ünü oluşturarak küresel yatırımlarda hakim bir rol oynamaktadır. Altı bölge arasında, 1990-2020 (ilk yarısı) yılları arasında ulaştırma altyapısının alt sektörleri bazında önemli artış gösteren tek bölge ise Latin Amerika ve Karayipler olup, altı bölgede gerçekleştirilen toplam ulaştırma altyapısının Latin Amerika ve Karayipler'in payı 2018 yılında %8'den 2019 yılında %18'e çıkmıştır. 2016 yılındaki düşüştü sonra yatırımlar artmaya başlamış olup, 2017, 2018 ve 2019 yıllarında artma eğilimli bir trend gözlemlenmiştir. 1990-2020 (ilk yarısı) yıllarında Orta Doğu ve Kuzey Afrika ile Sahra-Altı Afrika bölgelerinde ise ulaştırma sektörüne yapılan yatırımlarda kayda değer bir değişiklik görülmemiştir (The World Bank).

Grafik: 4

Bölgelere Göre Ulaştırma Altyapısının Alt Sektörlerinin 1990-2020 (ilk yarısı) Yılları Arasındaki Dağılımı

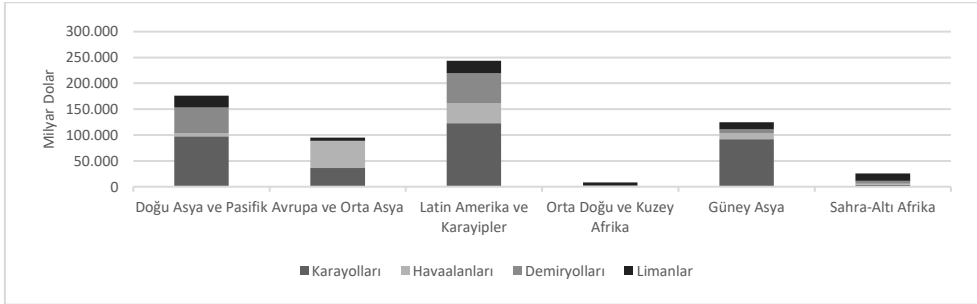

Kaynak: DB PPI Veri Tabanındaki filtrelenmiş verilerden yararlanılarak yazar tarafından hazırlanmıştır (The World Bank).

Avrupa ve Orta Asya bölgesinde ise, ulaştırma altyapısı için gerçekleştirdiği yatırımlarında 2018 yılında 9.573 milyar ABD dolarından, 2019 yılında 3.305 milyar ABD dolarına keskin bir düşüş yaşanmıştır. Bu bölgede yer alan Türkiye'nin ise sadece 2018 yılında 6.831 milyar ABD doları değerinde yatırımı bulunmaktadır ve bu tutar 2018 yılında bölgede ulaştırma altyapısına yapılan toplam yatırımın yaklaşık %71'ini kapsamaktadır. Ancak 2019 yılında Türkiye'de, ulaştırma altyapı yatırımlarında yalnızca 237.800 milyon ABD doları bir tutar ile önceki yıla göre gerilemiştir. Dolayısıyla Avrupa ve Orta Asya bölgesinde gerçekleşen keskin düşüşün başlıca nedeni, Türkiye'de altyapıya yönelik özel yatırım taahhütlerindeki önemli düşüşten kaynaklanmış olabilir (WB, 2020: 12). Türkiye'deki bu düşüşün bir kısmı zayıf makroekonomik ortamla açıklanabilir; ekonomik büyümenin üst üste iki çeyrek düşmesi, Türkiye'nin birçok yatırım projesini askıya almasına neden olmuştur ve ayrıca liranın değer kaybetmesi de bunda rol oynamaktadır (WB, 2020:

12). Şöyle ki; Türkiye’de altyapının geliştirilmesi için sağlanan borç finansmanı çoğunlukla döviz cinsinden olup, liranın değer kaybetmesi altyapı sektörü için önemli bir aşağı yönlü risk yaratarak altyapı yatırımlarını olumsuz etkilemiştir (WB, 2020: 12).

Grafik: 5
1990-2020 (ilk yarısı) Yılları Arasında Gelişmekte Olan Ülkelerde Ulaştırma Altyapısındaki KÖO Projelerinin Sayısı ve Yatırım Tutarlarının Dağılımı

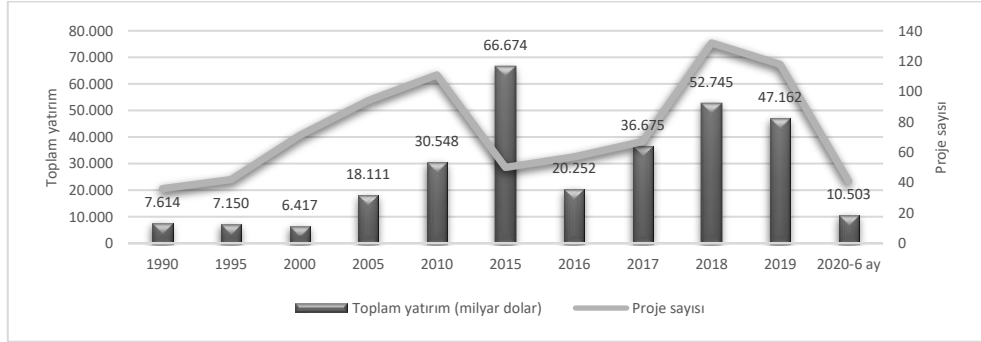

Kaynak: DB PPI Veri Tabanındaki filtrelenmiş verilerden yararlanılarak yazar tarafından hazırlanmıştır (The World Bank).

Grafik 5’te Dünya Bankası veri tabanından KÖO kapsamında filtrelenerek elde edilen veriler kapsamında 1990-2020 (ilk yarısı) yılları arasında düşük ve orta gelirli ülkelerdeki ulaştırma altyapısının KÖO projelerinin sayısı ve yatırım değerlerinin dağılımı gösterilmektedir. Grafığe göre, gelişmekte olan ekonomilerde ulaştırma altyapısına (havaalanları, limanlar, karayolları ve demiryolları) özel sektör yatırımı 2015 yılında zirvede gerçekleşmiştir, devam eden yılda düşüş yaşanmasına rağmen günümüze kadar istikrarlı bir şekilde arttığı görülmektedir.

Grafik: 6
2019 Yılında Gelişmekte Olan Ülkelerde Ulaştırma Sektörü Alanının KÖO Projelerinde En Yüksek Toplam Yatırımı Olan İlk Beş Ülke

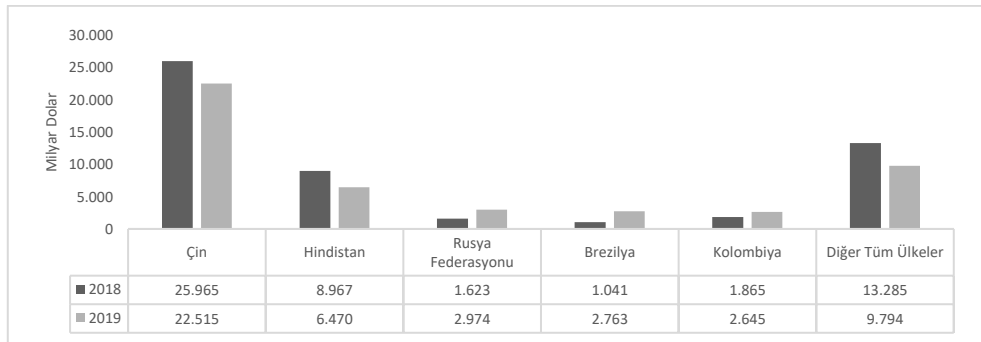

Kaynak: DB PPI Veri Tabanındaki filtrelenmiş verilerden yararlanılarak yazar tarafından hazırlanmıştır (The World Bank).

Bahsedildiği üzere 2015 yılında düşük ve orta gelirli ülkelerde ulaşım sektöründe KÖO projelerine yapılan yatırım diğer yıllara göre daha yüksek bir seyir izlemektedir. Son beş yılın ortalaması olan 42.297 milyar ABD doları ile yaklaşık %63'ün üzerinde 66.674 milyar ABD dolar olarak gerçekleşmiştir. Bunun sebebi ise, Avrupa ve Orta Asya bölgesinde yer alan Türkiye'nin 35.586 milyar ABD dolar tutarındaki İGA Havalimanı (Yeni Uluslararası Havalimanı)'dır. Bu yatırım Avrupa ve Orta Asya bölgesinde, KÖO verilerinde bu zamana kadar kaydedilmiş olan en büyük yatırım taahhüdü ile ulaşım sektörüne yapılan yatırımda son beş yılın ortalamasının yaklaşık %63'ünü oluşturarak en büyük payı almaktadır. Diğer bölgelerde ise 2015 yılında beş yıllık ortalamanın altında yatırım yapılmıştır.

2019 yılına bakıldığında, gelişmekte olan ülkelerde ulaştırma sektörü alanında toplam 118 proje sayısı mevcut olup, 47.162 milyar ABD dolar da toplam yatırımı bulunmaktadır. En yüksek yatırıma sahip ilk beş ülke ise sırasıyla Çin, Hindistan, Rusya Federasyonu, Brezilya ve Kolombiya olmuştur. Bu beş ülkenin hepsi toplamda 37.367 milyar ABD doları yatırım tutarı olup, gelişmekte olan ülkeler arasında ulaştırma sektörüne yapılan yatırımın yaklaşık %79'una sahiptir. Asya ve Pasifik bölgesinde yer alan Çin toplam 57 proje sayısı ve 22.515 milyar ABD dolar toplam yatırım ile, Güney Asya bölgesindeki Hindistan toplam 24 proje sayısı ve 6.470 milyar ABD dolar toplam yatırım, Avrupa ve Orta Asya bölgesindeki Rusya Federasyonu toplam 6 proje sayısı ve 2.974 milyar ABD dolar toplam yatırım ile takip etmektedir (The World Bank).

2019 yılında, demiryolları sektöründe 2018 yılına kıyasla yatırımda önemli bir artış olmuştur. 2018 yılında demiryolu yatırımı sadece 1 proje de gerçekleşmiştir ve 91.810 milyon ABD dolar yatırımı bulunmaktadır. Ancak 2019 yılında ise toplam 10.565 milyar ABD dolar tutarında yatırım taahhüdü olan sekiz demiryolu projesi bulunmaktadır. Havaalanı sektörünün Hindistan, Rusya, Jamaika ve Filipinler'de toplam 3,919 milyar ABD dolar tutarında yedi projesi yer almaktadır. Liman sektörü alanında ise, toplam 15 proje sayısı bulunmaktadır ve 13 ülkede 4,477 milyar ABD doları değerinde liman yatırımı görülmektedir ve bu beş yıllık ortalamaya göre değerlendirilir ise %42'lik bir artış anlamına gelmektedir (The World Bank).

Genel olarak, 1990-2020 (ilk yarısı) yıllarında gelişmekte olan ülkelerde KÖO kapsamında gerçekleştirilen sözleşme türleri⁵ çerçevesinde ulaştırma altyapısının kahverengi alan projesi bakımından toplam 1.106 proje sayısı ve 329.231 milyar ABD dolar yatırım tutarı ve yeşil alan projesi bakımından ise, toplam 722 proje sayısı ve 333.187 milyar ABD dolar yatırım tutarı gerçekleşmiştir (WB, 2020; 2021).

⁵ *KÖO'ları yerleşim yerinin geçmiş kullanımına göre ayırt edilebilmektedir ve yatırımcı açısından şu alternatif tanımlar yaygın olarak kullanılmaktadır (Yescombe, 2007: 335-341); Kahverengi alan projeleri: Mevcut bir tesisin yenilenmesini veya daha önce büyük yapıların bulunduğu bir alanda inşa edilmesini içeren projedir. Yeşil alan projeleri: Tamamen yeni bir tesis inşa etmeyi veya daha önce büyük yapıların olmadığı bir sahada inşa etmeyi içeren projedir.*

Grafik: 7

1990-2020 (ilk yarısı) Yılları Arasında KÖO Ulaştırma Altyapısının Alt Sektörlerine Göre Gerçekleştirilen Sözleşme Türlerinin Yatırım Tutarları Bakımından Dağılımı

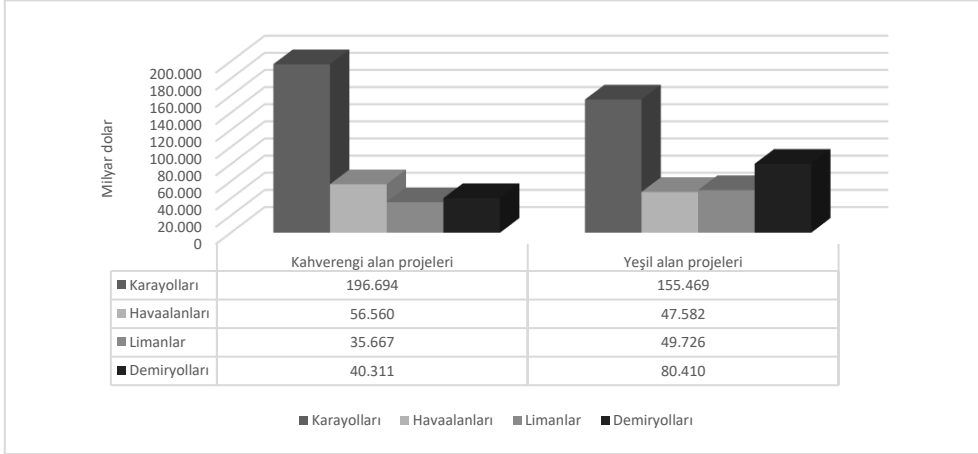

Kaynak: DB PPI Veri Tabanındaki filtrelenmiş verilerden yararlanılarak yazar tarafından hazırlanmıştır (The World Bank).

2019 yılında tüm bölgelerdeki ulaştırma altyapısı projelerinin toplam 69 proje sayısı ile 30.392 milyar ABD dolar yatırım tutarı değerinde yeşil alan projesi gerçekleştirilmiştir ve bu 2019 yılında tüm bölgelerde gerçekleştirilmiş olan ulaştırma altyapısı yatırımlarının yaklaşık %64'ünü oluşturmaktadır. 2019 yılına kıyasla 2018 yılında yeşil alan projeleri yaklaşık %81'lik bir orana sahiptir. Bu da 2019 yılında yeşil alan projelerinin 2018 yılına göre görece olarak bir düşüş yaşadığını göstermektedir. Kahverengi alan projeleri KÖO ulaştırma altyapısı çerçevesindeki yatırımlarının payı, 2018 yılında tüm bölgelerde gerçekleştirilmiş olan ulaştırma altyapısı yatırımlarının yaklaşık %18'den 2019 yılında yaklaşık %30'a yükselmiştir. KÖO kapsamında gerçekleştirilen ulaştırma altyapısı faaliyetlerinde yeşil alan ve kahverengi alan projeleri daha çok karayolları sektöründe yapılmıştır (The World Bank).

Güney Asya ve Latin Amerika, özellikle Hindistan ve Brezilya, dünyada gelişmekte olan ülkelerde karayolu KÖO faaliyetlerinin merkezi olmaya devam edeceği düşünülmektedir (Militaru & Eerd, 2012: 16). Ancak 2020 yılında gerçekleşen küresel salgın nedeniyle özellikle ulaştırma sektörü 2019 yılına kıyasla büyük bir darbe almıştır ve sadece 41 proje finansal olarak sona ermiştir. Dünya çapında karantina önlemleri toplu taşıma hizmetlerini ve paralı yolları, konteyner ve kargo hacminin azalmasıyla limanlar ve demiryolları, havaalanları KÖO'ları, uluslararası seyahatte ani ve şiddetli düşüşlerle ağır şekilde etkilenmiştir ve bu sebeplerden dolayı, boru hattındaki bazı projeler de ertelenmiştir (WB, 2021: 19). Bu bakımdan Covid-19'un ulaşım trafiğini olumsuz etkilemesiyle beraber, kullanıcı ücretlerine veya tarifelerine dayalı projelerde gelir ve talepte önemli düşüşler yaşanmış, temizlik ve sosyal mesafe protokollerinin uygulanması için artan maliyetlerle de

karşı karşıya kalınmıştır ve dolayısıyla sektördeki birçok proje için finansal kapanış ertelenme durumunda kalmıştır (WB, 2021: 19).

Bu kapsamda KÖO'nun genel durumu düşük ve az gelişmekte olan ülkeler çerçevesinde özetlenmiştir. Avrupa ülkelerindeki KÖO faaliyetlerinin genel durumu ise şu şekildedir. KÖO, projelerinin ve yatırım değerlerinin kaydının tutulup, raporlanmasının yapılması Dünya Bankası yanında, Avrupa KÖİ Uzmanlık Merkezi (EPEC)'de, Avrupa Birliği (AB) ülkelerinde yer alan kamu idarelerine danışmanlık ve rehberlik hizmeti vermek amacıyla, Avrupa Yatırım Bankası (EIB) çatısı altında, Türkiye'nin de üye olduğu (Kalkınma Bakanlığı, 2014: 18) ve EIB, Avrupa Komisyonu, Avrupa Birliği Üye Devletleri, Aday Devletler ve diğer bazı devletleri içeren bir girişimdir (EPEC, 2021). Avrupa ülkeleri, düzeyler arasında güçlü bağlantılara sahip hem merkezi hem de yerel düzeyde büyük, profesyonelleşmiş ve oldukça üniter bürokrasilere sahiptir (Grimsey et al., 2004: 15).

KÖO modeli de Avrupa'da, yeniliği kolaylaştırdığı, farklı çıkarları bir araya getirdiği ve kamu otoritelerinin ortak hedefler etrafında birleşmesine olanak sağladığı görüldüğünden, ortaklıklar aynı zamanda mevcut AB ekonomik kalkınma ve rekabet edebilirlik girişimlerinin merkezinde yer almaktadır ve trans-Avrupa ulaşım, telekomünikasyon ve enerji altyapılarının geliştirilmesi, büyük ortaklık programları için önerilmektedir (Grimsey et al., 2004: 16).

EPEC tarafından raporlanmış olan Grafik 8'deki verilerde Avrupa'daki KÖO projeleri sayıları ve yatırım değerinde ilk sıralarda yer alan ülkeler gösterilmektedir. Bu veriler incelendiğinde ise 2020 yılında Almanya toplam 2,8 milyar avro ile bu ülkelere göre projelerin toplam değer sıralamasında Avrupa'daki en yüksek KÖO pazarını oluşturarak ilk sırayı almaktadır. Ancak ülkelere göre finansal kapanışa ulaşan proje sayısı bakımından ise 12 anlaşma ile Fransa sıralamada zirvede olan ülke konumundadır.

Grafik: 8

2020 Yılında Avrupa'daki KÖO Projelerinin Ülkelere Göre Yatırım Değeri ve Sayısı
Ülkelere Göre Projelerin Toplam Değeri (milyar avro) Ülkelere Göre Proje Sayısı

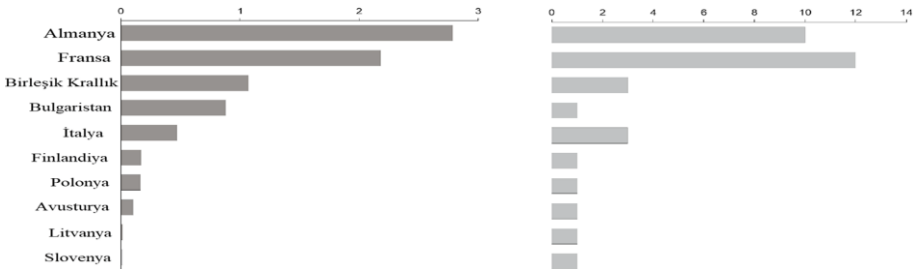

Kaynak: EPEC, 2021: 2.

Grafik 9'da 2020 yılında finansal kapanışa ulaşmış olan KÖO projelerinin yatırım tutarlarının ve sayısının ana sektörler bazında dağılımı gösterilmektedir. Grafik

incelendiğinde ise sektörel bazda proje sayıları ve yatırım değerlerine göre yapılan sıralamada oldukça yüksek farklılıklar olduğu görülmektedir. Proje yatırım değerleri itibariyle aralarında yaklaşık 4 kat fark bulunan 4,9 milyar avro ile ilk sırada ulaştırma sektörüne yapılan yatırımlar önde gelmektedir. İkinci sırada telekom ve üçüncü sırada eğitim sektörleri takip etmektedir. Ancak proje değeri bakımında ulaştırma sektörü ilk sırada yer almasına rağmen proje sayısı bakımından eğitim sektörü ilk sırada yerini almaktadır.

Grafik: 9

2020 Yılında KÖO Projelerinin Sektörlere Göre Yatırım Değeri ve Sayısı Sektörlere Göre Toplam Proje Değeri (milyar avro) Sektöre Göre Proje Sayısı

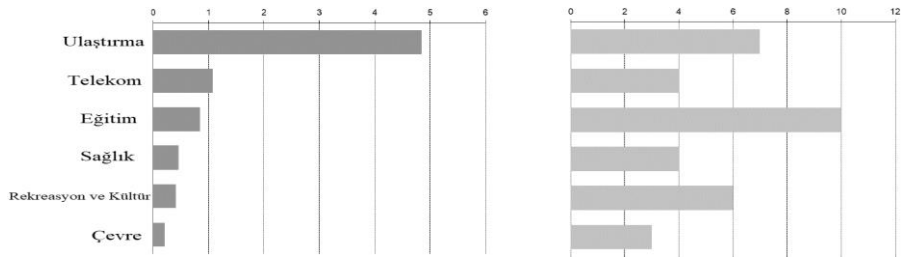

Kaynak: EPEC, 2021: 3.

Avrupa KÖO pazarının dağılımını 2016-2020 yıllarında proje sayıları ve yatırımlar bazında önde gelen ülkelerin detaylı bir şekilde gösterimi Grafik 10'da yer almaktadır. Bu grafiği incelediğimizde, son beş yılda Fransa ve Birleşik Krallık, finansal kapanışa ulaşan anlaşma sayısı kapsamında Avrupa KÖO piyasasında öncü durumundadır. Bu ülkeleri KÖO pazarının oluşturması bakımından Almanya ve Türkiye takip etmektedir. Proje yatırım değeri açısından incelendiğinde ise, 2016-2020 yıllarını kapsayan son beş yılda 13,54 milyar avro ile Fransa ilk sırada yer alırken, Türkiye 12,68 milyar avro ile ikinci sırada, Birleşik Krallık 10,29 milyar avro ile üçüncü sırada yer almaktadır.

Grafik: 10

Ülkelere Göre Avrupa KÖO Piyasasının Dağılımı (2016-2020)

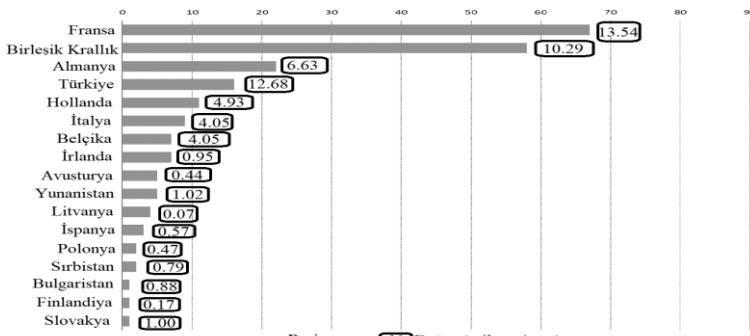

= Proje sayısı (N) Değer (milyar Avro)

Kaynak: EPEC, 2021: 8.

Bu grafiğe göre proje değerleri itibariyle Türkiye'nin ilk üç sırada bulunmasına rağmen, proje sayısı bakımından ise proje tutarına göre daha alt sıralarda yer alması; proje büyüklüklerinin başka bir deyişle proje başına yatırım tutarının diğer ülkelere göre yüksek olduğu anlamına gelmektedir (TASAV, 2017: 2).

Ulaştırma sektörünün eğitim ve sağlık ana sektörleri içindeki yerine daha ayrıntılı incelemek için ise son on yıldaki proje sayıları ve proje yatırım tutarları ile ulaştırma, sağlık ve eğitim sektörlerinde KÖO piyasasının gelişimi (2011-2020) Grafik 11 ve Grafik 12'de gösterilmektedir.

Grafik: 11
Proje Sayısına Göre Ana KÖO Sektörlerinin Dağılımı (2011 - 2020)

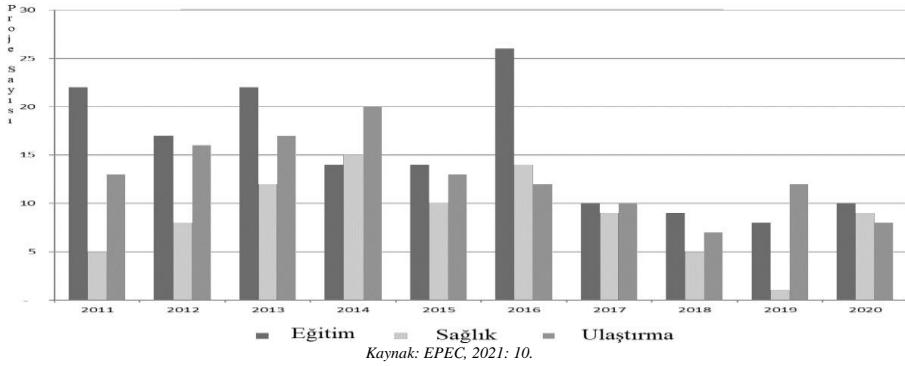

2011-2020 yılları arasında finansal kapanışa ulaşan KÖO projelerinin yatırım tutarlarının üç ana sektör bazındaki dağılımını incelediğimizde, tüm yıllarda ulaştırma sektörünün ilk sırada geldiği görülmektedir. Bu durum bize ulaştırma sektörünün proje sayısı bakımından diğer sektörlerden az olmasına rağmen yapılan proje yatırım değerinin diğer sektörlerle göre daha fazla olduğunu göstermektedir.

Grafik: 12
Proje Değerine Göre Ana KÖO Sektörlerinin Dağılımı (2011 - 2020)

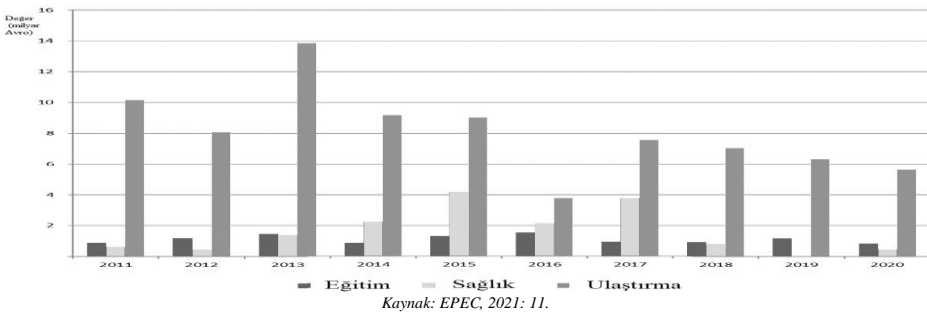

2020 yılında Avrupa'da finansal kapanışa ulaşan bazı büyük projeler (EPEC, 2021: 1);

- ✓ A3 Yol Genişletme - Almanya'da (1,5 milyar avro);
- ✓ A49 Kassel-Schwalm Otoyolu - Almanya'da (1 milyar avro);
- ✓ Sofya Havalimanı İmtiyazı - Bulgaristan'da (881 milyon avro);
- ✓ Rota Merkez-Avrupa Atlantique - Fransa'da (548 milyon avro).

Grafik: 13
2020 Yılında Gerçekleşmiş Olan Genel Faaliyetlerin Bir Oranı Olarak Büyük KÖO Projeleri (500 milyon avro veya daha fazla)

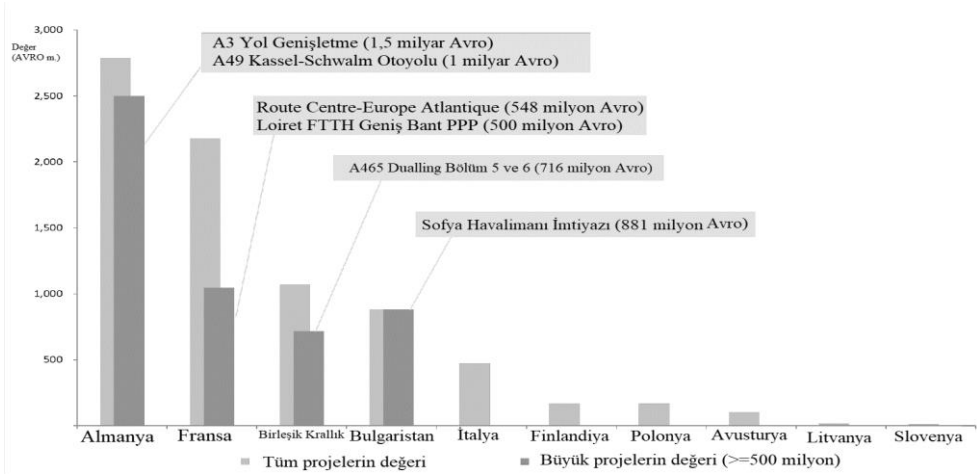

Kaynak: EPEC, 2021: 7.

1980'lerin sonlarından 2003 yılına kadarki sürede dahi, EIB, AB ülkelerinde geniş anlamda KÖO olarak kabul edilebilecek 100'den fazla projeyi onaylamıştır (Grimsey et al., 2004: 16). Ancak AB'nin, ulusal hükümetlerin ve kamu mali kurumlarının (yerli veya uluslar üstü) rolü 2020'de nispeten sınırlı kalmıştır. EIB ise bununla ilgili olarak (EPEC, 2021: 4);

- ✓ Yıl içinde mali kapanışa ulaşan 34 KÖO projesinden üçü, toplam 874 milyon avro kredi hacmiyle EIB tarafından finanse edilmiştir.
- ✓ Söz konusu üç proje ise, Finlandiya'daki Espoo Okulları Projesi ile Almanya'daki A49 Fritzlar-Ohmtal Dreieck Otoyolu ve A3 Biebelried - Furth Erlangen Otoyolu.

5. Sonuç

Ulaştırma altyapı hizmetleri günümüzden çok eskilere dayanmaktadır. Bu altyapının geliştirilmesinin önemi birçok çalışmada da belirtilmektedir. Ulaştırma sektöründe yapılacak olan iyileştirmeler bir dizi pozitif etkiyi beraberinde getirmektedir. Yeni ve

genişleyen ulaşım ağları ile bölgesel uzmanlaşma ve ticaret desteklenerek, firmaların, sanayilerin teknik ilerlemelerinin daha hızlı bir şekilde yayılması sağlanmaktadır. Bununla ilgili olarak Atatürk “Ekonomik hayatın etkinlik ve canlılığı ancak ulaştırma vasıtalarının, yolların, demiryollarının, limanların durumu ve derecesiyle orantılıdır.” şeklinde de ifade ederek ulaştırma altyapısının ekonomi üzerindeki önemine dikkat çekmiştir. Bu kapsamda ulaştırma altyapısının geliştirilmesi sürdürülebilir ekonomik büyüme ve kalkınma açısından önemli olduğu kabul edilen temel hizmetlerin arasında yer almaktadır ve devlet politikaları içinde önemli bir yer tutmaktadır. Dolayısıyla, ulaştırma altyapısı bir ülke ekonomisi için ciddi ölçüde önem arz etmesinin yanında ayrıca uluslararası ekonomide de önem arz etmektedir.

EPEC tarafından raporlanmış olan Avrupa’daki KÖO projeleri sayıları ve yatırım değeri ile ilgili veriler incelendiğinde sektörel bazda proje sayıları ve yatırım değerlerine göre yapılan sıralamada oldukça yüksek farklılıklar olduğu görülmektedir. 2020 yılında Almanya toplam 2,8 milyar avro ile ülkelere göre projelerin toplam değer sıralamasında Avrupa’daki en yüksek KÖO pazarını oluşturarak ilk sırayı almaktadır. Ayrıca Avrupa’da proje yatırım değerleri itibariyle aralarında yaklaşık 4 kat fark bulunan 4,9 milyar avro ile ilk sırada ulaştırma sektörüne yapılan yatırımlar önde gelmektedir. Ancak proje değeri bakımında ulaştırma sektörü ilk sırada yer almasına rağmen proje sayısı bakımından eğitim sektörü ilk sırada yerini almaktadır.

Dünya Bankası veri tabanından filtrelenerek elde edilmiş olan son otuz yılda düşük ve orta gelirli ülkelerde 815.045 milyar ABD doları ile en yüksek yatırım değeri payına sahip olan ve 3.448 proje sayısı ile de ilk sırada yer alan sektör elektrik sektörüdür. Bu sektörü takip eden ikinci sektör 693.025 milyar ABD doları yatırım değeri, 1.973 proje sayısı ile ulaştırma sektörüdür. Bu sektörleri sırasıyla su ve kanalizasyon, doğal gaz, BİT, MSW sektörleri takip etmektedir.

Gelişmiş ülkelerin ulaştırma sektörü ve diğer bazı sektörlerde KÖO modelini uygulamalarından sonra gelişmekte olan ülkelerde de kamu hizmetlerinin geliştirilmesinde alternatif bir model olarak KÖO modeli tercih edilmiştir. Bu bakımdan gelişmekte olan ülkelerde KÖO modelinin uygulamasında özellikle ulaştırma sektöründe önemli adımlar atılmıştır. Aynı şekilde Türkiye’de de özellikle ulaştırma sektörü alanında KÖO modeli tercih edilmektedir. Şehir içi yolların, otoyolların, köprülerin, tünellerin, demiryollarının, limanların, toplu taşıma sistemlerinin, havaalanlarının geliştirilmesi ve bakımı için ülke genelinde birçok KÖO projeleri bulunmaktadır. SBB tarafından elde edilen bilgilere göre, 2021 Ağustos ayı itibariyle güncellenen uygulama sözleşmesi imzalanan projeler toplamında ulaştırma sektörü yaklaşık %33’lük kısmını oluşturmaktadır.

KÖO projelerinin avantajlarının olmasının yanında ayrıca yüksek ihale ve işlem maliyetleri, karmaşık müzakere süreçleri, risk transferi, uzun vadeli sözleşmeler gibi dezavantajları da bulunmaktadır. Dolayısıyla projelerin hazırlık ve fizibilite aşamalarında doğru bir şekilde değerlendirilmesi gerekmektedir. Aksi takdirde altyapı sektörlerine yapılacak olan yatırımlarda aşağı yönlü bir risk meydana gelebilir.

Kaynaklar

- Aktan, C.C. vd. (2005), *Altyapı Ekonomisi (Altyapı Hizmetlerinde Serbestleşme ve Özelleştirme)*, Seçkin Yayınları, Ankara.
- APMG (2016), *The APMG Public-Private Partnership (PPP) Certification Guide*, ADB, EBRD, IDB, IsDB, and WBG.
- Benz, A. et al. (2005), *What Should Governments Buy from the Private Sector - Assets or Services?*, University of Bristol, Callej.
- Bolaños, L. et al. (2019), "U.S. Surface Transportation Public-Private Partnerships: Objectives and Evidence-Extended Findings", *Transportation Research Record: Journal of the Transportation Research Board*, 2673(12), 290-300.
- Brazilian Association of Highway Concessionaires (ABCR) (2018), *New Ways for Highway Concessions In Brazil*, Sao Paulo.
- Bülbül, D. (2017), "Türkiye'de Kamu Özel İşbirliği Uygulamasının Mali Saydamlık Açısından Değerlendirilmesi", *Uluslararası Bilimsel Araştırmalar Dergisi*, 2(7), 93-108.
- EPEC (2021), *Market Update Review of the European PPP Market in 2020*, European Investment Bank.
- Estache, A. et al. (2007), "Public-Private Partnerships in Transport", *Policy Research Working Paper*, WPS4436, The World Bank, Sustainable Development Vice-Presidency, December.
- Grimsey, D. & M.K. Lewis (2004), *Public Private Partnerships: The Worldwide Revolution in Infrastructure Provision and Project Finance*, Edward Elgar Publishing, USA.
- Juhel, M.H. (2012), "Roads and Railways Keep Development on Track", in: T.S. Oliveira & A. Buckholtz (eds.), *Road and Rail PPPs (Handshake)*, IFC's *Quarterly Journal on Public-Private Partnerships* (7-9), Washington, D.C.: World Bank Group.
- Kalkınma Bakanlığı (2012), *Dünya'da ve Türkiye'de Kamu-Özel İşbirliği Uygulamalarına İlişkin Gelişmeler*, Yatırım Programlama İzleme ve Değerlendirme Genel Müdürlüğü.
- Kalkınma Bakanlığı (2014), *2014-2018 Onuncu Kalkınma Planı Kamu Özel İşbirliği Özel İhtisas Komisyonu Raporu*, Ankara.
- Kwak, Y.H. et al. (2009), "Towards a Comprehensive Understanding of Public Private Partnerships for Infrastructure Development", *California Management Review*, 2(51), 51-78.
- Makovsek, D. et al. (2014), "Public Private Partnerships for Transport Infrastructure Renegotiations, How to Approach them and Economic Outcomes - Roundtable Summary and Conclusions", *International Transport Forum (ITF)*, Paris, France, OECD.
- Maskin, E. & J. Tirole (2008), "Public-Private Partnerships and Government Spending Limits", *International Journal of Industrial Organization*, 26, 412-420.
- Militaru, A. & R.V. Eerd (2012), "Paving The Way Forward - Private Investment in Roads", in: T.S. Oliveira & A. Buckholtz (eds.), *Road and Rail PPPs (Handshake)*, IFC's *Quarterly Journal on Public-Private Partnerships* (13-17), Washington, D.C.: World Bank Group.
- Oktavianus, A. et al. (2018), "A Global Review of Public Private Partnerships Trends and Challenges for Social Infrastructure", *MATEC Web of Conferences* 147, SIBE 2017.

- Perlman, M. & J. Pulidindi (2012), "Public-Private Partnerships for Transportation Projects", *Municipal Action Guide*, The National League of Cities (NLC), Center for Research and Innovation.
- PPIAF (2017), *Benchmarking Public-Private Partnerships Procurement 2017 - Assessing Government Capability to Prepare, Procure, and Manage PPPs*, International Bank for Reconstruction and Development / The World Bank.
- PPP RG (2014), *Public-Private Partnerships: Reference Guide Version 2.0 (English)*, Washington, D.C. World Bank Group 2014.
- Sadka, E. (2006), "Public-Private Partnerships: A Public Economics Perspective", *IMF Working Paper*, Fiscal Affairs Department.
- TASAV - Türk Akademisi Siyasal Sosyal Stratejik Araştırmalar Vakfı (2017), *Kamu-Özel İşbirliği Projeleri: Türkiye ve Diğer Ülke Örnekleri*, TASAV Ekonomi Araştırmaları Merkezi, No: 27.
- The World Bank (2022), *World Bank's PPI Database*, <<https://ppi.worldbank.org/>>, 20.08.2021.
- Ünlüöner, K. (1992), "Türkiye'de Ulaştırma Sektörünün Tarihi Gelişimi", *Dicle Üniversitesi Hukuku Fakültesi Dergisi*, 5, 331-351.
- Verweij, S. (2020), "Public-Private Partnerships for Infrastructure Development: Finance, Stakeholder Alignment, Governance", *Public Works Management & Policy*, 25(3), 333-336.
- Voordijk, J.T. et al. (2016), "Critical Success Factors in Different Stages of Delivery in PPP Transport Infrastructure Projects", in: A. Roumboutsos (ed.), *Public Private Partnerships in Transport: Trends and Theory (201-217)*, European Cooperation in Science and Technology.
- World Bank (2020), *Private Participation in Infrastructure (PPI) 2019 Annual Report*, The World Bank.
- World Bank (2021), *Private Participation in Infrastructure (PPI) 2020 Annual Report*, The World Bank.
- Yescombe, E.R. (2007), *Public-Private Partnerships: Principles of Policy and Finance*, Elsevier Finance, Amsterdam-Boston: Elsevier, Butterworth-Heinemann.

D-8 Ülkeleri İçin Karbondioksit Emisyonun Yapay Sinir Ağları ile Tahmin Edilmesi: Levenberg-Marquardt Algoritması

Ayşe ÇAY-ATALAY (<https://orcid.org/0000-0002-3600-368X>), Atatürk University, Türkiye;
ayatalay@atauni.edu.tr

Forecasting Carbon Dioxide Emissions for D-8 Countries by Artificial Neural Networks: Levenberg-Marquardt Algorithm

Abstract

In recent years, growth, development, and sustainability-oriented lifestyles have created a separate problem, especially for developing countries. In this study, GDP per capita, energy consumption per capita (renewable, fossil, total), and urban population for D-8 countries (Indonesia, Bangladesh, Iran, Egypt, Malaysia, Pakistan, Nigeria, and Türkiye), all of which are developing countries, between 1990 and 2020. The carbon dioxide emission rates of the countries were estimated using the artificial neural networks (ANN) method by using the data of increase and carbon dioxide emission. In the ANN model established in the study, 70% of the database data was randomly divided into training, 15% validation and 15% test data. This artificial neural network is trained with the Levenberg-Marquardt method. Regression R values, one of the performance indicators of the model, were determined as 0,99 for training data, 0,97 for validation data and 0,99 for test data. The regression R-value for all data used in the model was determined as 0,99.

Keywords : D8 Countries, Artificial Neural Networks (ANN), Levenberg-Marquardt Method, Carbon Dioxide Emission.

JEL Classification Codes : B21, B23, C45, C55, C67.

Öz

Son yıllarda büyüme, kalkınma ve sürdürülebilirlik odaklı yaşam tarzı özellikle gelişmekte olan ülkeler için ayrı bir sorunsalı oluşturmaktadır. Bu çalışmada 1990-2020 yılları arasında tamamı gelişmekte olan ülkelere ait karbondioksit emisyonu oranları tahmin edilmiştir. Çalışmada kurulan YSA modelinde veri tabanı verilerinin rastgele olarak %70'i eğitim, %15'i doğrulama ve %15'i test verilerine ayrılmıştır. Oluşturulan bu yapay sinir ağı, Levenberg-Marquardt algoritması ile eğitilmiştir. Modelin performans göstergelerinden Regresyon R değerleri eğitim verileri için 0,99, doğrulama verileri için 0,97 ve test verileri için 0,99 olarak belirlenmiştir. Modelde kullanılan tüm veriler için regresyon R değeri 0,99 olarak belirlenmiştir.

Anahtar Sözcükler : D8 Ülkeleri, Yapay Sinir Ağları (YSA), Levenberg-Marquardt Yöntemi, Karbondioksit Emisyonu.

1. Giriş

Dünya hızla artan bir çevre kirliliği sorunu ile karşı karşıyadır. Buna rağmen son 50 yılda tüm ülkeler için büyüme vazgeçilemez ve yavaşlatılamaz bir kavramdır. Kirlilik ise büyüme ile doğru orantılı artmaktadır. Bu ikilem içerisinde büyüme durdurulamazken kirliliği azaltmak için yenilenebilir enerji kaynakları ve yeşil büyüme stratejileri gün geçtikçe önemli hale gelmektedir (OECD, 2012: 31-35). Dünyada ise ülkeler arasında hem büyüme hem kirlilik ile mücadele açısından eşit rekabet koşulları mevcut değildir. Gelişmiş olan ülkeler çevre ve enerji üzerine çalışmalarını 1990'lı yılların başında yoğunlaştırmışlardır. Bunu yaparken ilk aşamada kirlilik yaratan fosil yakıt tüketimini azaltmak için yenilenebilir enerji kaynaklarının tüketimini artırıp, geri dönüşümü desteklemeye özen göstermişlerdir. Hatta gelişmiş ülkeler üretimlerinin büyük bir kısmını az gelişmiş ve gelişmekte olan ülkelere kaydırmışlardır (Zhou et al., 2018: 1). Bu durumda az gelişmiş ya da gelişmekte olan ülkeler, gelişmiş ülkelerdeki sanayi kollarının "kirlilik sığınağı" ya da "kirlilik cenneti" (Pollution Haven Hypothesis) haline gelmesine sebep olmuşlardır (Fullwood et al., 2009: 58-64).

Çevre ile ilgili çalışmaları yaparken şüphesiz Çevresel Kuznets Eğrisi hipotezi ışığında, endüstriyel gelişmenin ekonomik büyüme üzerindeki etkisini göz ardı etmemek gerekmektedir. Çevresel Kuznets Eğrisi (ÇKE) hipotezi, ekonomik büyüme ile çevre arasında ilişki kuran modeller içinde, büyümenin çevreye verdiği zararları yorumlamak için en yaygın kullanılan yöntemlerden biridir. ÇKE hipotezine göre; büyüme ile paralel olarak önce gelir artmakta, gelir artışı çevre kirliliğini artırmakta bu artış belli bir süre devam ettikten sonra hem gelir artışı hem de çevre kirliliği azalmaktadır (Grossman & Krueger, 1991: 3914). Endüstriyel üretim dünya çapında ekonomik büyümeye katkı sağlarken, aynı zamanda çevresel bozulmanın maliyetlerini de artırmaktadır. Çevresel maliyetler başta küresel nüfus olmak üzere, özellikle az gelişmiş ve gelişmekte olan ülkelerde daha yüksek olabilmektedir. Herhangi bir ülkenin özellikle sanayileşme yoluyla büyümesi, enerji tüketimi ve doğal kaynak tüketimini artırırken, çevre kirliliğini de aynı oranda artırmaktadır. (Xing et al., 2023; Musah et al., 2021). Günümüzde büyümenin çevre üzerindeki etkilerini farklı yöntemler (Stirpat, ARDL, PMG vb.) ile test etmeye yönelik çalışmaların sayısı gün geçtikçe artmaktadır. Bu çalışmada son yıllarda tüm bilim dallarında ve çevre çalışmalarında da yaygın olarak kullanılmaya başlanan yöntemlerden biri olan Yapay Sinir Ağı yöntemi de eklenmiştir.

Bu çalışma, tamamı gelişmekte olan ülkelere oluşan, D-8 ülkeleri üzerine yapılmıştır. D-8 ülkelerinin toplam nüfusu 1,1 milyar olup, dünya nüfusunun 1/7'sini oluştururken bu ülkelerin toplam ekonomik büyüklükleri 4 trilyon doları aşmaktadır (<www.mfa.gov.tr>). D-8 ülkeleri aynı zamanda doğal kaynak zenginliği ile petrolde Dünya rezervlerinin %12'sini doğal gazda ise toplam Dünya rezervlerin %21'ini bünyesinde barındırmaktadır. D-8 ülkeleri batılı ülkeler ile karşılaştırıldığı zaman kişi başına düşen gelir miktarı (GSYH) açısından düşük olmalarına rağmen, yoğun nüfusları nedeniyle toplu olarak oldukça önemli bir paya sahiplerdir (Kamel, 2001: 251). Ayrıca topluluğa üye ülkelerin

sosyoekonomik ve coğrafi farklılıklarının, büyüme ve kirlilik ilişkisine etkisi D-8 ülkeleri üzerine çalışma yapmayı cazip kılmıştır.

Çalışmada kullanılan veri seti için aralık olarak 1990-2020 dönemi belirlenmiştir. Belirlenen zaman aralığı seçilirken, tüm dünyada özellikle kirlilik artışının yoğunlaşmaya başladığı 1990 yılı başlangıç noktası olarak belirlenirken, en son verilere ulaşılabilen ve çalışmanın güncelliğini artırmak için en yakın zamana tekabül eden 2020 yılları seçilmiştir. Değişkenler seçilirken, gelişmekte olan ülkelerin içinde bulunduğu büyüme kirlilik sarmalı dikkate alınmıştır. Çünkü gelişmekte olan ülkeler, sürdürülebilir kalkınmaya ulaşma konusunda, gelişmiş ekonomilere göre farklı sorunlarla karşı karşıyadırlar. Gelişmişliğin en belirgin göstergesi olan kişi başı gelir (GSYH), gelişmiş ülkelere göre daha düşük seviyededir. Bu durumdan kurtarmak isteyen gelişmekte olan ülkeler için çözüm ise üretimi daha da artırmaktır (Gürlük, 2010: 85-99). Üretim artışı ise çevre sorunlarını artırıcı başlıca unsurdur. Ancak gelişmekte olan ülkeler sürdürülebilir büyümenin devam edebilmesi için yol haritası belirlerken, gelişmiş ekonomilerin çevreyi dikkate almadan hazırladıkları kalkınma süreçlerinde yaptıkları hataları dikkate almalıdırlar. Geçmiş tecrübelerden yararlanma gelişmekte olan ülkeler için avantaja dönüşecektir. Bu durumda gelişmekte olan ekonomilerin büyüklüğü ve enerji sistemleri, radikal dönüşümlerin uygulanmasını kolaylaştıracaktır. Böylece gelişmiş emsallerine göre daha hızlı ve daha yönetilebilir hale getirme fırsatı sunacaktır (Cantarero, 2020: 70).

Gelişmekte olan ülkelerin daha fazla büyüme ihtiyaçları daha fazla enerji talebini kaçınılmaz kılmaktadır (BP Enerji İstatistikleri Sitesi; Muhumuza et al., 2018; Solarin, 2020). 2017 ile 2040 arasında dünya genelinde büyümenin %48 artacağı tahmin edilmektedir. (Dünya Enerji Görünümü, 2017: 1-5). Büyüme ile birlikte artan enerji talebinin çevre üzerindeki olumsuz etkileri ise sürdürülebilir kalkınma açısından risk teşkil etmektedir. Bu açıdan değerlendirildiği zaman kirliliğin oluşturduğu tehdit, sadece gelişmekte olan ülkeler için değil tüm dünya ülkeleri için büyük sorun oluşturmaktadır (Nepal & Paija, 2019: 164-173). Gelişmekte olan ülkelerin yenilenebilir enerji kullanımları ise daha kısıtlıdır (Cherni & Jouini, 2017; Kararaslan & Çamkaya, 2022). Bu nedenle, bu ülkelerin CO₂ emisyonunu azaltmak için enerji tüketim tercihlerini, yenilenebilir enerjiden yana kullanmaları daha önemlidir. Karbondan arındırma ve sürdürülebilir kalkınma arasındaki korelasyon göz önüne alındığında, birçok gelişmekte olan ülke bunu başlatmıştır. Hatta son birkaç yılda, GSYH bazında bakıldığında, gelişmekte olan ülkelerin bu teknolojilere, gelişmiş ülkelere daha fazla yatırım yaptıkları gözlemlenmektedir (REN21; Renewables 2020 Global Status Report, 2020). Bununla birlikte, 2019 yılında başlayan Covid-19 pandemisi nedeniyle ortaya çıkan ekonomik ve finansal sıkıntılar, gelecekte yenilenebilir enerji projelerine yapılacak yatırımları önemli ölçüde etkileyeceği tahmin edilmektedir. Sürdürülebilir kalkınma çerçevesinde, sürdürülebilir ve yenilenebilir enerji sistemlerine başarılı bir geçiş yapan ya da yapacak olan ülkelerin bu noktada desteklenmesi büyük önem arz etmektedir (Ouedraogo, 2017: 106).

Gelişmekte olan ülkelerde, büyüme ile birlikte artan kentleşme olgusu, kirlilik artışını tetikleyen başka bir unsurdur (Liang & Yang, 2019; Aslan et al., 2021). Birleşmiş Milletler

Nüfus Departmanına göre; 2040 yılına kadar Dünya nüfusunun yaklaşık üçte ikisi kentlerde yaşayacaktır. Bu süreçte kentsel değişim üç şekilde gerçekleşecektir. İlk olarak, daha fazla insan kent merkezlerine taşınacak, küresel nüfusun büyük bir bölümü kentlerde yaşayacaktır. İkinci olarak, gelecek nüfusu dünyadaki yoksulların daha büyük bir kısmına ev sahipliği yapacaktır. Üçüncüsü, gerçekleşen değişimler mekânsal yayılım gösterip şehirler, çevre ve insanlar üzerinde olumsuz etkiler oluşturacaktır (Vlahov et al., 2007: 16-26). Ayrıca, plansız şehirleşme bu ülkelerde doğal kaynakların sürdürülemez şekilde kullanımını ve doğal afetleri (su kıtlığı, iklim değişikliği, bitki ve hayvan türlerindeki azalma / yok olma) daha hissedilir kılacaktır (Baloch et al., 2019: 632-638).

Dünya çapında ekonomik, coğrafi, nüfus ve doğal kaynaklar açısından büyük bir potansiyele sahip olmasına rağmen D-8 ülkeleri üzerine yapılan çalışma sayısı, nedeni bilinmeyen bir şekilde sınırlıdır. Bu çalışma ile D-8 ülkelerinin sahip olduğu potansiyele tekrar dikkat çekilmesi hedeflenmiştir. Çalışma sonucunda; elde edilen bulguların güçlü tahmin içermesi, bu tarz sınamaların, farklı ülke ve bölgelerin çok uluslu veri kümelerinin üzerine yapılması hususunda, literatüre katkı sağlayacağı umulmaktadır. (YSA)'nın kullanarak CO₂ emisyonu tahmini yapmak, mevcut literatürdeki (EKC, STIRPAT vb.) büyüme kirlilik ilişkisini farklı yöntemler ile de ölçülmesinin geliştirilmesi adına literatüre farklı bakış açılarıyla yönelme eğilimini destekleyecektir. Çünkü kirlilik ile ilgili çalışmalar yapılırken, merak edilen soru daima, sonuçlar ne kadar tutarlı sorusuna cevap aramak olmuştur. Yine literatürde önceden yapılmış çalışmalarla sonuçların karşılaştırılması yapılarak, yöntemler arası karşılaştırma olanağı da katkı sağlayacaktır.

2. Literatür

Dünya son yıllarda iki sorunla ciddi şekilde mücadele etmektedir. Bir yandan küresel ısınmayı 1,5 °C ile sınırlamak; diğer yandan, kapsayıcı ve eşitlikçi bir sosyoekonomik kalkınmanın sağlanması (Aktaş, 2023: 5). Her iki sorunun çözümü içinse gelişmekte olan ülkeler kilit rol oynamaktırlar. Özellikle gelişmekte olan ülkelerde, ekonomik kalkınma, sosyal içerme ve çevresel sürdürülebilirlik beklentileri daha fazladır. Yine yenilenebilir enerji potansiyelinin çoğu, gelişmekte olan ülkelerde bulunduğundan, bu ülkeler kilit role sahiptir (Wang et al., 2021: 277). Bu makale, ulusal ve uluslararası literatür incelenerek hazırlanmıştır. Aşağıda konu ile ilgili dikkat çeken araştırmaların bazılarında örnekler sunulmuştur.

Pabuççu ve Bayramoğlu (2016), çalışmalarında Türkiye için büyüme kirlilik paradoksuna dikkat çekmek istemişlerdir. Sera gazı emisyonlarının en önemli nedenlerini; enerji üretimi ve tüketimi, kitlesel üretim ve ulaşım için gerekli olan enerji ihtiyacından kaynaklandığını savunmuşlardır. Avrupa Birliği ülkelerine Türkiye'yi de dahil ederek, 1990-2030 yılları arasında beşer yıllık dönemler halinde Yapay Sinir Ağları Modeli (YSA) ile tahmin yapmışlardır. Değişken olarak nüfus, enerji üretimi ve tüketimi, GSYH, ulaşım için talep edilen enerji miktarı ve sera gazı salınım miktarlarını kullanmışlardır. Türkiye'nin 2020-2025-2030 yılları için CO₂ eş değeri salım miktarlarını tahmin etmişlerdir. Elde edilen bulguların Türkiye'nin Paris İklim Zirvesi'nde 2030 yılı için söz verdiği 929 milyon ton CO₂

salınım miktarının çok üzerinde olduğuna vurgu yapmışlardır. Çalışmada CO₂ emisyonu tahmini yaparken, YSA yönteminin kullanılması ve AB ülkelerine Türkiye'nin de dahil edilerek analiz yapılması bu çalışmayı da destekleyici niteliktedir. Çalışmada YSA yöntemi ile dönemler halinde geleceğe yönelik tahmin yapmak ise bu çalışmadan farklı yönünü ortaya koymaktadır.

Marjanovic vd. (2016), yaptıkları çalışmada karbondioksit emisyonları ile gayri safi yurtiçi hasıla (GSYH) arasındaki bağıntıyı ortaya koymaya çalışmışlardır. Çalışma Avrupa Birliği üzerine yapılmış olup, CO₂ emisyonuna neden olan enerji kaynakları; katı, sıvı, gaz olarak ayrıştırılmıştır. Bilindiği üzere, ekonomik büyüme ile karbondioksit emisyonları arasındaki ilişki en önemli ampirik kanıtlardan biri olarak kabul edilmektedir. Ancak, güvenilir iklim değişikliği politikaları için karbondioksit CO₂ emisyonları ile ekonomik büyüme arasındaki ilişkinin nedensel analizi hala sınırlıdır. Bu çalışmada, CO₂ emisyonlarına dayalı olarak GSYH'daki değişimi tahmin etmek için Ekstrem Öğrenme Makinesi (ELM) geliştirilerek, uygulanmıştır. ELM sonuçları, Genetik Programlama (GP) ve Yapay Sinir Ağı (YSA) ile karşılaştırılmıştır. Hesaplamalı modellerin güvenilirliğine, simülasyon sonuçlarına dayalı olarak ve çeşitli istatistiksel göstergeler kullanılarak erişilmiştir. ELM, YSA ve GP yöntemleri için belirleme katsayıları sırasıyla 0.9271, 0.8756 ve 0.4475 olarak bulunmuştur. ELM yöntemi ile GSYH tahminlerinin tutarlı olduğu sonucuna varılmıştır. Çalışma AB üzerine yapılsa da kullanılan yöntem ve büyüme ile enerji kullanımı arasındaki ilişkinin CO₂ emisyonu üzerindeki etkisi, bu çalışmada da destekleyici olmuştur. Birden fazla yöntemin karşılaştırılması olarak kullanımı ise bu çalışmadan farklı yönünü ortaya koymaktadır.

Zeng vd. (2017) çalışmalarında dünya üretiminin önemli bir ölçөгünü elinde bulunduran Çin ekonomisi üzerinde yapmışlardır. 1978-2013 arası Çin'in yıllık enerji arzı, enerji tüketimini karşılayamamıştır. Çalışmada, enerji tüketimini tahmin etmek için uyarlanabilir bir geri yayılma sinir ağı (BPNN) modeli olan ADE-BPNN adlı melez model uygulanmıştır. Önerilen melez modelde, girdi olarak nüfus, ithalat, ihracat ve gayri safi yurtiçi hasıla, verileri yer almaktadır. Elde edilen bulgular ile karbon emisyonunu azaltan bir yöntem geliştirmeyi hedeflenmiştir. Önerilen ADE-BPNN modelinin uygulanabilirliğini ve doğruluğunu karşılaştırmalı bir örnek (Çin ve ABD) üzerinde sınımışlardır. Test veri kümelerindeki hatalar, modelin alışılmışı gelmiş geri yayımlı sinir ağı modeli ve diğer bilinen mevcut modellerle karşılaştırılması yapıldığı zaman enerji tüketimini başarılı bir şekilde tahmin edilebildiği gözlemlenmiştir. Çalışmanın özellikle YSA modellerinin mevcut modeller ile karşılaştırıldığı zaman daha başarılı sonuçlar içermesinin ampirik olarak kanıtlanması bu çalışmada kullanılan modelin özgünlüğünü destekleyici nitelikte olmuştur.

Ahmadi vd. (2023) çalışmalarında, Sera gazı emisyonlarının, küresel ısınmaya ve iklim değişikliğine önemli ölçüde neden olduğunu belirtmişlerdir. Çalışmada, birincil enerji kaynağı olarak kullanılan çeşitli enerji kaynaklarının paylarını temelinde en önemli sera gazı olan karbondioksit emisyonlarını belirlemek için bir Yapay Sinir Ağı (YSA) yaklaşımı olan Grup Veri İşleme Yöntemi (GMDH) kullanılmışlardır. Çalışmalarında, Birleşik Arap Emirlikleri (BAE), Katar, Kuveyt, İran, Suudi Arabistan da dahil, beş orta doğu ülkesi

üzerine yapmışlardır. Geliştirilen model tarafından elde edilen sonuçlar ile gerçek büyüklüklerin karşılaştırılması sonucunda, YSA modelinin CO₂ tahmininde kabul edilebilir doğruluğa sahip olduğunu tespit etmişlerdir. Çalışmanın, beş Ortadoğu ülkesi üzerine yapılması, bu çalışmanın ise D-8 ülkeleri üzerine yapılması benzer coğrafi alan açısından destekleyici olmuştur. Çalışmada kullanılan değişkenler ve yöntem ilişkisi ise bu çalışmanın özgünlüğüne vurgu yapmaktadır.

Acheampong ve Boateng (2019), çalışmalarını Avustralya, Brezilya, Çin, Hindistan ve ABD üzerinde yapmışlardır. CO₂ emisyonu fazla olan bu ülkelerde emisyon yoğunluğunu tahmin etmek için Yapay Sinir Ağı (YSA) yöntemini uygulamışlardır. Çalışmada, modelleri geliştirmek, eğitmek ve doğrulamak için adı geçen ülkelere ait 1980-2015 dönemine ait üç aylık veriler kullanılmıştır. Girdi değişkenler; Ar-Ge, ekonomik büyüme, ticari açıklık, finansal gelişme, doğrudan yabancı yatırımları, enerji tüketimi, sanayileşme ve kentleşme seçilmiştir. Çalışma sonucunda yüksek belirleme katsayısına sahip olan ülkeler ve değişkenler ise şöyledir. Avustralya için Ar-Ge, Brezilya ve ABD için kentleşme, Çin için nüfus büyüklüğü, Hindistan'da ise enerji tüketimi en yüksek belirleme katsayısı olan (R²)'ye sahip oldukları belirlemişlerdir. Çalışma nüfus yoğunluğu fazla olan ülkelerin CO₂ emisyonunun YSA yöntemi ile tahmini yaparken, ekonomik büyüme, enerji tüketimi ve kentleşme oranı değişkenlerinin kullanılması, bu çalışmayı da destekler niteliktedir.

Ashin-Nishan ve Villanthenkodath (2020) çalışması Hindistan üzerinde yapılmıştır. Çalışmanın amacı Hindistan gibi hızla büyüyen gelişmekte olan ülkelerde temiz enerjinin büyüme üzerine etkisini ortaya koyabilmektir. Çalışmada enerji kullanımı (fosil ve yenilenebilir enerji) girdi değişkeni olarak alarak, karbondioksit emisyonlarının ve büyüme tahminini Yapay Sinir Ağı (YSA) tekniği ile tahmin etmişlerdir. Elde edilen bulgular ile büyüme devam ederken CO₂ emisyonunu azaltmak için makine öğrenimi teknikleri kullanılarak, iyileştirilebileceğini ileri sürmüşlerdir. Sonuçta, fosil yakıt kullanımından yenilenebilir enerji kullanımına geçişin, ekonomik büyümeden ödün vermeden karbondioksit emisyonlarını azaltmanın olası bir yolu olduğunu özellikle vurgulamışlardır. Çalışma çevre çalışmaları için umut verici olmuştur. Bu çalışma göstermiştir ki oluşturulacak politikalar fosil yakıt kullanımını azaltacak veya enerji verimliliğini artıracak şekilde düzenlenebilirse, daha iyi sonuçlar alınabilir. Çalışma gelişmekte olan ve nüfus yoğunluğu fazla olan Hindistan üzerine yapılırken, kullanılan yöntem ve değişkenler ile elde edilen sonuçlar bu çalışma ile benzer bulguları desteklemektedir.

Özhan (2020), çalışmasında Türkiye'nin 1960-2014 yılları arasındaki özellikle sektörlerin yarattığı sera gazı emisyon miktarlarının ölçümü ve gelecek tahmini yapılması hedeflenmiştir. CO₂ eşdeğeri sera gazı emisyonu ölçümleri ile yaptığı çalışmasında sera gazlarının atmosferdeki buldukları şekillerine ve paylarına göre metan (CH₄), azot oksit (N₂O), hidroflorokarbonlar (HFC'ler), perflorokarbonlar (PFC'ler), sülfür heksaflorür (SF₆) değerlerini CO₂ eşdeğerlerine dönüştürerek emisyonları ölçümlemeyi hedeflemiştir. Çalışmada için önce Zaman serisi analizi yapılmış, ardından Yapay Sinir Ağları (YSA) ve algoritmaları ile örüntüler elde edilmiştir. Bu değerlere göre iki model arasında yapılan karşılaştırma sonucu en az hata veren modelin YSA olduğu tespit edilmiştir. YSA'nın daha

doğru tahminler yapacağı bulgusundan hareketle 2021 yılına kadar olan tahminler yapılmıştır. Model sonucunda Türkiye için 2021 yılı CO₂ emisyonunu tahmini 366,3972 milyon tondur. Çalışma mantık olarak YSA yöntemi ile CO₂ emisyonun tahminini yaparak bu çalışma ile benzerlik göstermektedir. Ancak tek ülke Türkiye üzerine yapılması, sera gazlarının atmosferdeki şekillerine göre ölçülmesi ve farklı iki yöntem sınanıp, yöntem karşılaştırmasına gitmesi bu çalışmadan, farklı yönlerini ortaya koymaktadır. Bir başka farklılık olarak ise çalışmada geleceğe yönelik tahminlerde bulunulmuştur.

Jena vd. (2021), çalışmalarında gelişmiş ve gelişmekte olan 17 kilit ülkenin CO₂ emisyonlarını tahmin ediyorlar. Emisyonları tahmin etmek için doğrusal istatistiksel modellemelerin aksine çok katmanlı bir yapay sinir ağı modeli kullanmışlardır. Modelde, CO₂ emisyonlarının öngörücüleri olarak gayri safi yurtiçi hasılayı (GSYH), kentsel nüfus oranını ve ticari açıklığı kullanmışlardır. Sonuçlar, Çin, Hindistan, İran, Endonezya ve Suudi Arabistan gibi yüksek emisyonla sahip ülkelerin yakın gelecekte emisyonlarının daha da artacağını göstermiştir. Brezilya, Güney Afrika, Türkiye ve Güney Kore gibi düşük emisyonlu ülkeler de ise emisyonun büyüme ile orantılı artacağı öngörülmüştür. Öte yandan ABD, Japonya, İngiltere, Fransa, İtalya, Avustralya ve Kanada gibi ülkelerin ise emisyonlarını sürekli azaltacağını belirtmişlerdir. Çalışmada, bu çalışmadan farklı olarak gelişmiş ve gelişmekte olan ülkelerin karması oluşturulmuştur. Ayrıca GSYH, kentsel nüfus oranı değişkenlerine, diğer bu ve diğer çalışmalardan farklı olarak, ticari açıklık değişkeni sınanmıştır. Çalışmanın YSA yönteminin kullanılması ise bu çalışmayı destekler niteliktedir.

Sel ve Tekgün (2022), Türkiye üzerine yaptıkları çalışmada, sera gazı salınımının artması nedeniyle, büyümenin gerekliliği ile sürdürülebilirlik endişesi arasındaki çelişkiye vurgu yapmışlardır. Çalışmada, karbondioksit salınımı tahmini için hem bulanık mantık hem Yapay Sinir Ağları (YSA) yönteminin birlikte kullanıldığı Uyarlamalı Sinirsel Bulanık Çıkarım Sistem (ANFIS) yöntemi kullanılmışlardır. Uygulamanın ilk kısmında ithalat, ihracat, Gayri Safi Yurt İçi Hasıla (GSYH), nüfus, değişkenleri kullanılarak 1998- 2018 yılları için aylık veri seti kullanılarak 2019-2020 yılları karbon emisyonu ($R^2=0,964$) olarak tahmin edilmiştir. İkinci kısımda ise ilk kısımda elde edilen veriler kullanılarak aylık karbon emisyonu değerleri ile birlikte 2021, 2022 ve 2023 yılları için karbon emisyonu tahmininde bulunmuşlardır. Çalışmada, bu çalışmadan farklı olarak yine tek ülke üzerine analiz yapılmıştır. CO₂ emisyonun tahmini için yöntem olarak ise YSA yöntemi ile birlikte ANFIS yöntemi de sınanmıştır. Ayrıca gelecek ile ilgili tahminler yapılmıştır.

Birjandi vd. (2022), yaptıkları çalışmalarında, dört Güneydoğu Asya ülkesinin 2000-2019 yılları arasındaki enerji kullanımı ve ekonomik büyümenin, sera gazı emisyonları üzerindeki etkisini incelemişlerdir. Çalışmada; Malezya, Endonezya, Singapur ve Vietnam'ın GSYH verileri ile enerji tüketim miktarları ve türleri girdi olarak belirlenmiştir. CO₂ emisyonunun üretimini modellemek için normalleştirilmiş radyal tabanlı ve tansig olmak üzere iki transfer fonksiyonlu Yapay Sinir Ağı (YSA) yöntemini kullanmışlardır. Model kurulurken farklı enerji kaynaklarının kullanılmasından kaynaklanan farklı CO₂ emisyon miktarlarının oluşacağı dikkate alınmıştır. Çalışma sonucunda CO₂ emisyonlarının

oluşmasında en büyük payın enerji ile ilgili faaliyetlerin oluşturduğunu tespit etmişlerdir. Çalışmada CO₂ emisyonun tahmini için YSA yönteminin farklı bir modelini kullanmıştır. Kullanılan değişkenlerden biri olan, enerji değişkeni ise türlerine göre modellenerek, bu ve benzeri çalışmalara aynı değişkenlerin farklı özellikleri dikkate alınarak da CO₂ emisyonu üzerindeki etkisinin ölçülebileceğini göstermiştir.

Çalışmaların tamamına bakıldığı zaman, karbon emisyonu tahmini yapılırken, kirlilik üzerinde etkili çok sayıda değişken olması, değişkenler ile yapılan çalışmanın niteliğine ve kullanılan yöntemlere göre değişiklik gösterebilmektedir. Yapay Sinir Ağı (YSA) ile yapılan tahminlerin ise kullanılan değişkenler gibi farklı YSA modelleri ile sınılanması mümkündür. Ancak tüm çalışmalarda YSA'nın kullanımının genelde sağlıklı ve güvenilir sonuçlar vermesi yöntemin kullanımı ve sağladığı avantajlar açısından daha da yaygınlaşacağı bakımından umut vericidir.

3. Veri ve Yöntem

Yapay Sinir Ağları (ANN - Artificial Neural Network), insan beynini baz alınarak tasarlanan ve basit sinir hücresinin çalışma şeklini taklit eden bir yazılımdır. Yapay sinir ağları aracılığıyla öğrenme işlemi, hedeflenen gayeye ulaşmak için hücreler arasındaki sinaptik iletim (komşu sinir hücreleri arasındaki gönderim) bağlantılarının ayarlanması ile çalışır (Nilson, 1998; Luger, 2002). İlk yapay sinir ağı örneği 1943 yılında nörolog Warren McCulloch ve mantıkçı olan Walter Pitts tarafından "A Logical Calculus of Ideas Immanent in Nervous Activity" başlıklı makalenin yayınlanması ile çığır açmıştır. Literatüre McCulloch-Pitts nöronu olarak geçmiştir. YSA aslında insan beyninde bulunan biyolojik sinir ağlarını taklit eden bileşimsel yapılardır. Eğitimden sağlığa, savunmadan mühendisliğe kadar birçok alanda geleneksel yöntemler ve işlemleyicilerin yetki sunmadığı alanlarda sorunların çözümünde etkindirler. Günümüzde YSA kullanılarak başarılı çalışmalara imza atılmıştır (Russell & Norving, 1995: 27).

Şekil: 1
Biyolojik ve Sentetik Yapay Sinir Ağı Hücresi

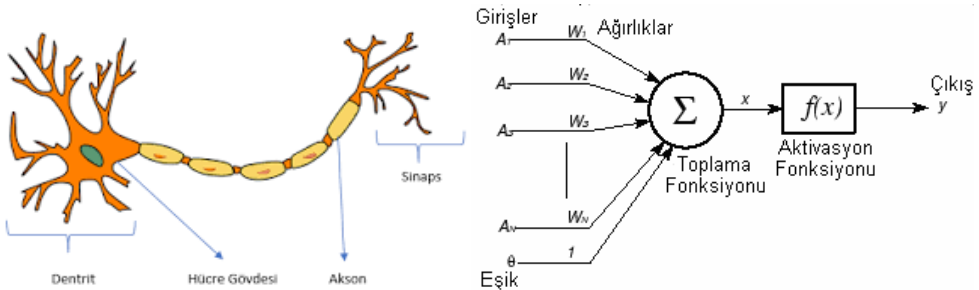

Girdiler (x_1, x_2, \dots, x_n), başka hücrelerden ya da ortam dışından hücreye giren bilgilerdir. Girdiler ağı öğrenmesini istediğimiz örnekler aracılığıyla belirlenir. Ağırlıklar (w_1, w_2, \dots, w_n), ise girdiler ya da kendinden bir önceki katmandaki başka bir işlem elemanının süreç üzerindeki etkisini gösteren değerlerdir. Her girdi, o girdiyi süreç ögesine bağlayan ağırlık değeriyle çarpılarak, (b) eşik değeri ile toplanır. Toplam fonksiyonu vasıtasıyla da birleştirilir. Toplam fonksiyonu bir hücreye gelen net fonksiyonu hesaplar. Eşitlik (1) de ki gibi gösterilir.

$$net = \sum_{i=1}^n w_i x_i + b \quad (1)$$

Toplam fonksiyonu sonucunda elde edilen değer doğrusal ya da doğrusal olmayan biçimde türevi alınabilir. Böylece transfer fonksiyonundan geçirilen işlem ögesinin çıktısı hesaplanmış olur (Eşitlik 2).

$$y = f(net) = f(\sum_{i=1}^n w_i x_i + b) \quad (2)$$

Yapay Sinir Ağlarında bilgiler ve algoritmalar kesin değildir, istenen sonuca ulaşmak için geçmiş deneyimlerden yararlanır. Gerekli deneyimlerden faydalanmak için çeşitli öğrenme algoritmaları sınanır. Bu çalışmada, MATLAB programı ve Neural Net Fitting araç kutusu (toolbox) kullanılarak, Levenberg- Marquardt yöntemi ile Yapay Sinir Ağı eğitilmiş olup, belirlenen değişkenler ile D-8 ülkeleri için karbon emisyonu tahmini yapılmıştır.

Şekil: 2
Geri Yayımlı Öğrenme Algoritması

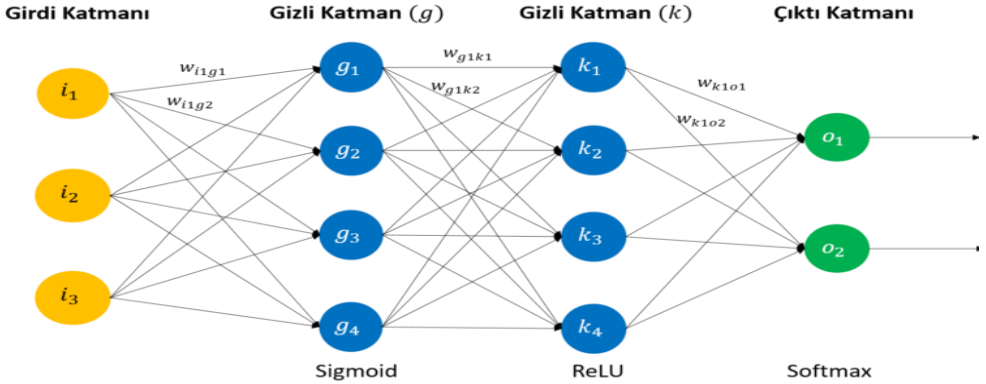

Kaynak: Öztürk & Şahin, 2018: 31.

3.1. Geri Yayımlı Öğrenme

Geri yayımlı öğrenme algoritması çok tabakalı ağ yapısında (Şekil 2) kullanılan algoritmalardan bir tanesidir. Ağa gönderilen eğitim verisi (input) ve ağı kendi ürettiği çıktı verisi (output), beklenen değer (target) ile karşılaştırılır. Gerçekleşen ve beklenen iki değer arasındaki fark ise hata değerini belirler. Bulunan hata değeri, bir sonraki tekrarlama aşamada ağı

ağırlık değerleri arasında yeniden dağıtılarak, işlem sonucundaki hata değerinin düşürülmesi amaçlanır (Nabiyev, 598: 2016).

Newton algoritmalarının türetilmesi ile oluşturulan Levenberg-Marquardt algoritması, değişken güncelleme işlemleri için bütün girdilerden oluşturulmuş hata vektörü ve Jakoben matrisi ile yapılmaktadır. Levenberg-Marquardt algoritmasının, bir başka avantajı ise sistem kaynaklarını diğer algoritmalara göre daha fazla kullanmaktadır. Böylece ağırlık eğitilmesi daha kısa sürede gerçekleşmektedir. Uygulamada genel olarak iyileşme durdurulduğunda, eğitim sonlanmaktadır (Marquardt,1963; Hagan & Menhaj, 1994; Hagan et al., 1996).

$$\Delta w = (J^T J + \mu I)^{-1} J^T e \quad (3)$$

Eşitlik 3'te belirtilen I, birim matrisi, μ , kombinasyon katsayısı ve w, ağırlık vektörüdür. J, [(P x n), N] boyutunda Jacobian matrisini, e, [(P x n), 1] boyutunda hata vektörünü ifade eder. P, eğitilen örnek sayısını, n, çıktı sayısını ve N, ağırlık sayısını gösterir. μ ayarlanabilir bir parametredir. Eğer elde edilen parametre çok küçükse Newton metodu gibi davranırken elde edilen parametre çok büyükse yöntem dik iniş metodu gibi davranacaktır. Söz konusu parametre için uyarlamalı bir yapı Eşitlik 4'te verilmiştir (Çizmeçi vd., 2018: 184).

$$\mu(n) = \begin{cases} \mu(n-1)k E(n) > E(n-1) \\ \mu(n-1)/k E(n) \leq E(n-1) \end{cases} \quad (4)$$

3.2. Matlab Programına Özel Geliştirilen Sinir Ağı Araç Kutusu (Neural Network Toolbox For Matlab)

YSA için kullanılacak birçok araç (toolbox) ve program arayüz bulunmaktadır. Bu araçlardan biri de bu çalışma içinde kullanılan MATLAB programı kapsamında geliştirilmiş Neural Network Toolbox'dır. Bu Toolbox yüzeysel ve derin sinir ağlarını oluşturmak, görselleştirmek, eğitmek için kullanılır. Ayrıca benzeşim için algoritmalar, daha önce eğitilmiş model ve uygulamaları da sunar.

3.3. Veri Tabanı

Bu çalışmada, aralarında Türkiye'nin de bulunduğu gelişmekte olan ülkeler (Developing-8) olarak adlandırılan D-8 (Türkiye, Bangladeş, Mısır, Endonezya, İran, Malezya, Nijerya ve Pakistan) ülkelerinde karbon emisyonu tahmini YSA yöntemi kullanılarak yapılmıştır. Çalışmada özellikle D-8 ülkelerinin seçilme nedeni; gelişmekte olan ülkeler arasında sahip oldukları geniş coğrafi alan, nüfus potansiyeli ve hızla gelişen ülkeler arasında yer almalarıdır.

Çalışmada 1990-2020 yılları arasındaki 30 yıllık dönem için D-8 Ülkelerine ait ve karbon emisyonu üzerinde etkili olduğu düşünülen değişkenler kullanılmıştır. Değişkenler belirlenirken literatürdeki çalışmalar (Aytun vd., 2017; Garces et al., 2019; Ashraf et al.,

2020; Patterson et al., 2021; Komeli-Birjandi et al., 2022) baz alınmıştır. Veriler yıllık olarak kullanılmıştır. Elde edilen veriler, Dünya Bankası veri tabanı, BP Dünya Enerji İstatistikleri Raporu ve ülkelerin kendi resmi istatistik sitelerinden parçalar halinde ve manuel olarak toplanmıştır. Matlab programı dahilinde geliştirilen sinir ağı araç kutusu (Neural Network Toolbox) içerisinde bulunan, Neural Net Fitting uygulamasına, eğitim verisindeki girdiler (inputs) ve hedefler (target) tanımlanmıştır.

Bu çalışmada kurulan YSA modelinde veri tabanı verilerinin rastgele olarak %70'i eğitim, %15'i doğrulama ve %15'i test verilerine ayrılmıştır. YSA modelinde girdi değişkenleri; yenilenebilir enerji tüketim miktarı, fosil yakıt tüketimi, Gayri Safi Yurtiçi Hasıla (GSYİH), kentsel nüfus artış oranı olurken, çıktı değişkeni CO₂ emisyonları olarak belirlenmiştir. Ağda kullanılan gizli nöron sayısı 10 olarak saptanmıştır. Oluşturulan bu yapay sinir ağı, Levenberg-Marquardt algoritması ile eğitilmiştir (Şekil 3).

Şekil 3
YSA Model Değişkenler

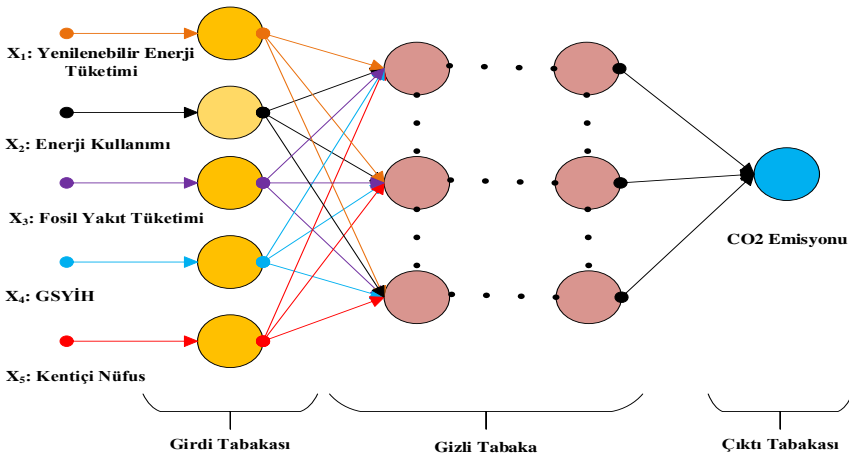

Not: Şekil 3 yazar tarafından oluşturulmuştur.

Tablo 1'de eğitim, doğrulama ve test verilerinin sayısal dağılımları şöyle olmuştur. Eğitim verisi 174, doğrulama verisi ve test verileri ise 37 şer tane olup, toplamda 248 tane veri kullanılmıştır.

Tablo: 1
Değişkenlerin Sayısal Dağılımları

Veri Seti Adı	% Oranı	Sayısı
Eğitim	70	174
Doğrulama	15	37
Test	15	37
Toplam	100	248

Not: Yazar tarafından oluşturulmuştur.

Yapay sinir ağı yönteminin iki önemli avantajı bulunmaktadır. Birincisi sürekli değerli girdi ve çıktılar için uygundur. İkincisi ise doğrusal olmayan verileri açıklamayı yeteneğine sahiptirler. Yapay sinir ağları insan beynindeki bilgi işleme ve saklama şeklini taklit ettiği için veriyi çevreden alan, saklayan gerektiğinde kullanan bir yapıya sahiptir. İnsan beynindeki sinir hücrelerini taklit eden, nöronlar aslında matematiksel işlemler arasında bağlantılar oluşturarak çalışır. Nöronlar birbirlerine ağırlıklı katmanlar halinde bağlanır ve düzenlenir. Bir katmanda yer alan sinir hücresi kendinden önceki ve sonraki katmanlarda bulunan sinir hücrelerine bağlıdır (Ercan, 2021: 3269).

YSA'daki nöronların işleyiş şekli (Şekil 4) şöyledir. Giriş kısmındaki x nöronlarından alınan veri seti toplam fonksiyonu ile birleştirilip daha sonra doğrusal olmayan bir aktivasyon fonksiyonuna gönderilerek elde edilen çıktı, tarafından diğer sinir hücrelerine yönlendirilir. Her bir sinir hücresi tek çıkış sinyali üretirken, tüm giriş sinyallerini aynı anda sinir hücresine ulaştırır. Her giriş sinyali aynı zamanda bir bağlantı ağırlığı ile ilişkilidir. Başka bir ifade ile bir sinir hücresi çok sayıda giriş sinyali alırken, sadece bir tane çıkış sinyali gönderir. Ağırlıklar ise giriş sinyalinin sinir hücresi tarafından iletilen sonuç sinyalini üretmedeki sahip olacağı göreceli önemi belirler. Bias olarak adlandırılan eşik değeri ise genellikle girdi olarak kullanılan ve regresyon modelindeki sabit olarak adlandırılan yapı ile benzerdir. Çalışmada verilen yapay sinir ağları denetimli bir öğrenme modeli olarak kullanılır. YSA'da öğrenme genelde geri yayılım algoritması adı verilen bir algoritma ile gerçekleştirilir (Giudici, 2003; Larose, 2005; Ercan, 2021).

Şekil: 4
YSA'da Yer Alan Nöronların Genel Yapısı

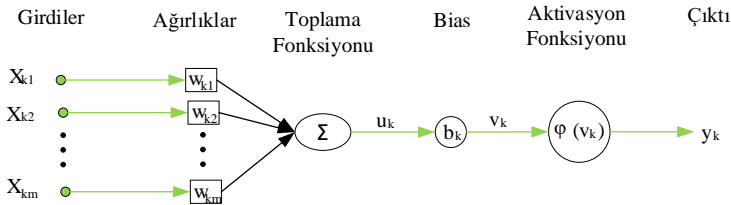

Kaynak: Haykin, 2008: 11.

Şekil: 5
YSA Modelinin Tabaka Sayıları

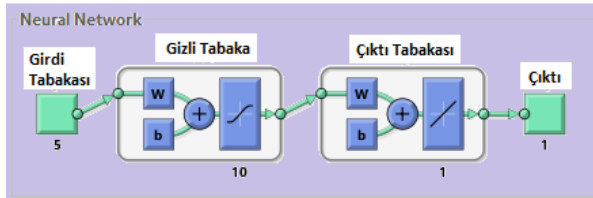

Not: Matlab programı aracılığı ile modele göre oluşturulan tabaka sayılarının gösterimidir.

Çalışmada YSA modeli beş adet girdi değişkeni ve bir adet çıktı değişkeni ile oluşturulmuştur. Modelin belirlediği gizli tabaka sayısı on ve çıktı tabaka sayısı birdir. Modelin yapısı, Şekil 5'teki gibi oluşmuştur. Modelin eğitim verilerini eğitmek için Levenberg-Marquardt algoritması kullanılmıştır. Modelin performans göstergeleri Tablo 4'te belirtilmiştir.

Tablo: 4
YSA Modelinin Performans Göstergeleri

Veri Seti	Veri Sayısı	Hata Kareler Ortalaması (MSE)	Regresyon Değeri (R)
Eğitim	174	0,0013455	0,992
Doğrulama	37	0,0025065	0,978
Test	37	0,0024826	0,990

Not: Yazar tarafından oluşturulmuştur.

Regresyon değeri, YSA model sonucu ile gerçek değer arasındaki korelasyon ilişkisinin değeridir. Regresyon (R) değeri, modeldeki bağımsız değişkenlere göre bağımlı değişkenin, değişkenliğinin ne kadarının model tarafından açıklanabileceğini gösterir. Korelasyon katsayısının karesidir. Regresyon modelinde fazla sayıda bağımsız değişken varsa model eğitim verilerine çok iyi sağlayabilir. Ancak test modelinde istenen sonuç alınamayabilir. Bu yüzden Düzeltilmiş R Kare kullanılır. R değerinin 1'e yakın olması modelin başarılı sonuç verdiğini göstermektedir. MSE değerinin küçük olması istenen bir durum olsa da sıfır olması durumunda modelin hata verdiği anlamına gelmez. Çalışmada elde edilen bulgular (Tablo 4: dördüncü sütun) üç test içinde modelin başarılı olduğunu göstermektedir.

$$R^2 = 1 - \frac{SS_{Kalıntı}}{SS_{Toplam}} \quad (5)$$

$$R^2_{adj} = 1 - \frac{MS_{Kalıntı}}{MS_{Toplam}} \quad (6)$$

Minimum karesel hata (MSE) / Kök ortalama kare hatası değeri, YSA model sonuçları ile gerçek sonuçlar arasındaki farkın karelerinin ortalama değeridir. Ortalama Kare Hatası, bize tahminler ile gerçek değerler arasında karşılaştırma yapacağımız mutlak bir sayı verir. Ancak farklı modeller ile karşılaştırıp daha sağlıklı sonuçlar elde etmek için Kök Ortalama Karekök Hatası (RMSE) kullanılır. Bu, MSE'nin kareköküdür. MSE'den farklı olarak sunduğu avantaj ise bazen MSE değeri kolayca karşılaştırma yapamayacak kadar büyük olabilir. Bu yüzden RMSE hata karesi ile hesaplanır ve böylece yorum yapmayı kolaylaştırır (Kendal et al., 1963: 552).

$$MSE = \frac{1}{N} \sum_{i=1}^N (y_i - \hat{y}_i)^2 \quad (7)$$

Bu çalışmada eğitim, doğrulama, test veri setleri ve tüm veriler kullanılarak YSA modeli oluşturulmuştur. YSA modelinin tahmin değerleri ile gerçek değerler arasındaki hata değerlerinin histogram grafiği Şekil 6'daki gibi elde edilmiştir. Gerçek değerler (Target), YSA modelinin tahmin sonuçları (Output) arasında oluşan matematiksel farkın ifadesidir.

Her bir histogram içerdiği test değerlerine göre farklı renklerden oluşmaktadır. Sarı düz çizgi sıfır hatayı temsil etmektedir. Yani tahmin ve test değerlerinin tamamen uyumlu olduğu noktayı ifade eder (Wang & Lu, 2018: 2).

Şekil: 6
Tahmin ve Test Değerlerinin Grafikselleştirilmesi

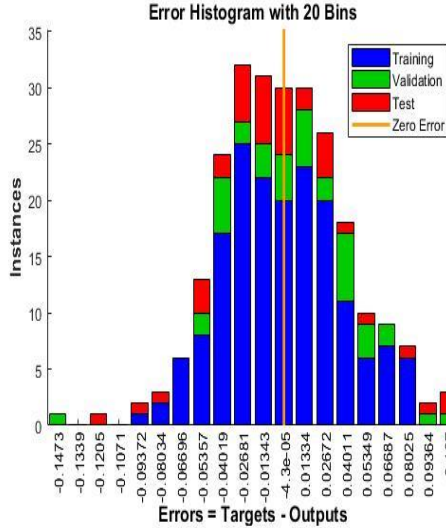

Not: Matlap programı aracılığıyla oluşturulan tahmin ve test değerleri grafiğidir.

Şekil 7’de eğitim, doğrulama, test ve tüm verileri bir arada gösteren regresyon çizgisi üzerinde sonuçlara göre oluşturulmuş değerler yer almaktadır. Belirleme katsayısı (R) değerleri beklenen ile gerçekleşen arasındaki farkı ifade etmektedir. Elde edilen R değerleri sırasıyla eğitim verileri için 0,99 doğrulama verileri için 0,97 test verileri için 0,99 tüm veriler için 0,99 olarak bulunmuştur. Elde edilen sonuçların 1’e yakın olması tahminlerin güçlü olduğunu göstermektedir. Çalışmada kullanılan bütün veri seti dikkate alındığında gerçek değerler ile YSA modelinin tahmin değerleri arasındaki ilişki eşitlik (7) deki gibi elde edilmiştir. Sonuçlar incelendiği zaman, tahmin ve test değerlerinin uygun aralık içerisinde oldukları görülmektedir. Yapılan bu çalışma ile ülkelerin karbon emisyonunu tahmin ederken geleneksel yöntemlerle (EKC, STIRPAT vb.) hesaplanmasının yanı sıra tahmin işlemlerinin, yapay sinir ağları kullanılarak da yapılabileceğini ortaya koymaktadır.

$$Output = 0,98 * Target + 1,3 * 10^2 \quad (7)$$

Eşitlik 7’de output, YSA model tahmin değeri, Target ise gerçek değeri göstermektedir.

Şekil 7
Modelin Sonuçları

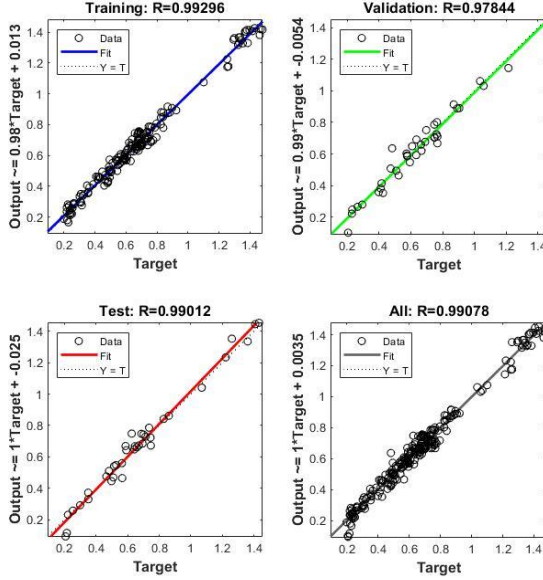

Not: Eğitim, doğrulama, test ve tüm verilerin model sonuçları ile karşılaştırılması.

4. Sonuç ve Öneriler

Son yıllarda yaşanan küresel iklim krizi nedeniyle çok sayıda çevre felaketinin yaşanması (kasırga, sel, yangınlar, kuraklık, aşırı soğuk ve sıcaklar vb.) çevre bozulması üzerinde insan faaliyetlerinin olumsuz etkisini sıklıkla gündeme getirmektedir. Ekonomik büyüme sürecine öncelik veren gelişmekte olan ülkelerin, kirlilik üzerinde yarattıkları olumsuz baskı nedeniyle, konu ile ilgili çalışmalarda sıkça gündeme gelmektedirler. Sadece gelişmiş ülkeler için çevre üzerine yapılan çalışmaların sonucuna bakarak, genel bir değerlendirme yapmak ise hatalı yorumlara yol açabilir. Çünkü küresel kirlilikte, gelişmekte olan ülkelerin sayıca fazla olmaları daha fazla negatif dışsallık oluşturmalarına yol açmaktadır.

Dünyanın neredeyse üçte ikisi gelişmekte olan ülkelere aittir. Çalışmanın D-8 ülkelerinin üzerine yapılmasının nedeni gelişmekte olan ülkelerin büyüme bazlı eğilimlerinin etkilerini, karbon emisyonu açısından değerlendirmektir. D-8 örgütünün kuruluş amacı, ülkelerin ellerinde bulundurdukları ekonomik potansiyeli ve sahip oldukları kaynakları geniş nüfus avantajı ile de birleştirerek, ticaret ilişkilerini daha avantajlı hale getirmektir. D-8 ülkelerinin diğer bir amacı ise bölgesel ekonomik bir güç olmaktan ziyade küresel ekonomik bir güç olabilmeyi başarabilmektir. Bu birlikteliğin başlatılmasında,

ülkelerin ekonomik potansiyeli, kaynak etkinliği, önemli nüfus avantajı ve geniş bir coğrafi alana yayılmaları şüphesiz etkin olmuştur. D-8 ülkelerinin, ticari ilişkilerde yeni olanaklar yakalamak ve çeşitlendirmek, uluslararası düzeyde karar alma süreçlerine katkıda bulunmak, muasır medeniyet düzeyinde yaşam koşulları sağlamak, belirli ortak projeler çerçevesinde iktisadi seferberlik geliştirmeleri hedeflenmektedir. Belirlenen amaçlar incelendiği zaman gelişmekte olan ülkelerin dünya ekonomisindeki perspektifleri de değişmektedir.

D-8 ülkelerinde kirlilik üzerinde etkin olan değişkenlerin tahmini için yapılan bu çalışmada YSA yöntemi kullanılmıştır. Son yıllarda bilim dünyasında yapay zekâ uygulamaları sıkça gündeme gelmektedir. YSA'da en yaygın yapay zekâ yazılımlarında birisidir. Çalışmada kullanılan veriler seçilirken literatürde özellikle son beş yılda kirlilik üzerine YSA ile yapılan çalışmalar ve değişkenleri dikkate alınmıştır. YSA kullanılarak yapılan çalışmaların sonuçlarında, genel olarak tahminlerin doğruluk derecesi ve başka yöntemler ile karşılaştırıldığı zaman daha başarılı sonuçlar elde edildiği vurgulanmıştır. Klasik kirlilik modellerinde (EKC, STIRPAT, ARDL vb.) kullanılan yabancı yatırımlar, ihracat, ithalat göstergelerinin aksine farklı değişkenler (enerji tüketimi, kentleşme oranı, vb.) kullanılarak da farklı bir bakış açısı geliştirmek hedeflenmiştir. Çalışmada veri seti olarak, yenilenebilir enerji tüketim miktarı, fosil yakıt tüketimi, Gayri Safi Yurtiçi Hasıla (GSYH), kentsel nüfus artış oranı ve çıktı değişkeni olarak CO₂ emisyonları olarak kullanılmıştır. Çalışma sonucunda eğitim, doğrulama ve test verilerine ait R değerleri sırasıyla; 0,99; 0,97; 0,99 olarak bulunmuştur. Tüm değişkenler için R değeri 0,99 olarak gözlemlenmiştir. Elde edilen bulgular, istenen aralıkta olup, tahmin başarılı kabul edilmiştir.

Çalışmanın kirlilik konusunda, gelecekte yapılacak farklı çalışmalara da katkı sağlaması beklenmektedir. Bunun için önceden klasik yöntemler ile yapılan çalışmalar aynı dönemler için YSA yöntemi ile yapıp, sonuçların yöntemler açısından karşılaştırması açısından fırsatı sunabilecektir. Çalışmalar yine tamamen farklı ülke ya da ülke grupları üzerinde sınanabilir. Çalışmanın gelişmiş ülkeler üzerinde sınanması yapılarak farklı bakış açıları geliştirilebilir. Böylece bu ve benzeri çalışmalarla farklı yöntemlerle ve farklı değişkenlerle de kirlilik çalışmaları yapılabileceğini destekleyecektir. Çalışma yapılırken en büyük kısıt veri bulma sıkıntısı olarak görülmüştür. Özellikle bazı ülkelerin son beş yıla ait değerleri kendi istatistik siteleri üzerinden manuel olarak toplanabilmiştir.

Gelişmekte olan ülkelerin kirlilik üzerindeki etkileri dikkate alındığı zaman, ekonometrik bulgularla uyumlu olarak, aşağıdaki politika önerilerini sunulmuştur. Bu politikalar ancak devlet eliyle hayata geçirilebilecek politikalardır. Çevresel politikaların bireysel önlemler olarak ya da kamu otoritesi olmaksızın başarılı olması çok olası değildir.

Ekonomik büyüme, küresel ısınmayla mücadelede önemli bir araçtır. Gelişmekte olan ülkelerin büyüme-kirlilik ilişkisini ortaya koyan Çevresel Kuznets Eğrisi hipotezinin temelinde de sürekli ekonomik büyüme ile belirli bir gelir düzeyine ulaşılabileceği ve bunun sonucunda CO₂ emisyonlarının azalacağı varsayılmaktadır. Bu açıdan bakıldığında,

ekonomik büyümenin ilerletilmesi gerekmektedir. Ancak büyüme CO₂ salınımını azaltıcı etkisi olan yenilenebilir enerji kullanımı ve yatırımları ile desteklenmesi önemlidir.

Fosil yakıtlardan elde edilen enerji yerine çevre dostu kaynakları ile yeni evlerin, işyerlerinin ve fabrikaların tükettikleri enerjinin en azından belli bir bölümünü karşılayan sistemler devlet tarafından desteklenebilir. Yine var olan yapıların bakımı ve revize edilmesi için devlet teşviki başlatılabilir. Ayrıca enerjiye çok ihtiyaç duyan ve yenilenemeyen enerji kaynaklarının büyük ölçüde kullanıldığı imalat sektöründe, sektör sahiplerine finansal destek sağlanabilir. Bu tür yatırımlar, kısa ve uzun vadede karbon salınımının azaltılmasına katkı sağlamanın yanı sıra, enerjide büyük ölçüde dışa bağımlılığı azaltacaktır.

Ulaşım şüphesiz son yüzyılın vazgeçilemez bir olgusudur. Aynı zamanda en fazla kirlilik saçan sektördür. Ulaşımında gelişmekte olan ülkeler yine büyük oranda fosil yakıt kullanımını sürdürmektedir. Gelişmekte olan ülkelerde de özellikle yenilenebilir enerji ile kullanılan araçların sayısı hızla artırılmalıdır. Bunun için devlet alımları artıracak şekilde ödeme kolaylığı ya da uzun süreli kredi kullanımı sağlayabilir. Kısa mesafeler için toplu ulaşım zorunluluğu, uçak seferlerinin belirli bir mesafe üzerinde gerçekleşmesi (Fransa 2,5 saat altındaki uçuşları 24.05.2023 tarihi itibarıyla yasakladı.) gibi ulaşımında kirliliği azaltmak için uygulamalar ile orta vadede ulaşımın neden olduğu kirlilik miktarı en aza indirilebilir.

Çevre konusunda mutlaka ki çok sayıda öneri sunmak mümkündür. Ancak hızla artan tüketim ve atık miktarı karşısında gelişmiş ülkelerin özellikle geri kalmış ya da gelişmekte olan ülkeleri para karşılığında kirlilik sığmağı olarak görmesi kabul edilebilir bir durum değildir. Ayrıca tüm dünya ülkeleri artık bilmelidir ki, kirlilik nerede olursa olsun sonuçları tüm dünyayı etkileyecektir. Geline nokta tüm ülkeler için sürdürülebilir büyüme olmadıkça, acımasız küçülmeye gidecektir. 22 Nisan 2016 Paris Konferansı'nda hazırlanan raporda, sürdürülebilir kalkınmanın ekonomik büyüme için önemli bir araç olduğu kabul edilirken, büyümenin ancak çevre dostu üretim politikaları devam edeceği vurgusu yapılmıştır. Böylece büyümenin yarattığı gelir etkisi önce kişisel geliri artıracak, artan kişisel gelir, uzun dönemde çevre bilinci ve çevreye dost kaynak kullanım talebini artıracaktır. Böylece büyümede sürdürülebilirlik yakalanabilecektir. Sürdürülebilir büyüme tüm Dünya ülkelerinin ortak sorumluluğunda olup, çözüm ancak ortak eylem planı ile mümkün olacaktır.

Kaynaklar

- Acheampong, A.O. & E.B. Boateng (2019), "Modelling Carbon Emission Intensity: Application of Artificial Neural Network", *Journal of Cleaner Production*, 225, 833-856.
- Ahmadi, M.H. et al. (2023), "Carbon Dioxide Emissions Prediction of Five Middle Eastern Countries Using Artificial Neural Networks", *Energy Sources, Part A: Recovery, Utilization, And Environmental Effects*, 45(3), 9513-9525.
- Aktaş, M.T. (ed.) (2023), *İklim ve Enerji Krizi Kısacasında İktisadi Kalkınma*, Efe Akademi Yayınları.

- Ashin-Nishan, M.K. & M.A. Villanthenkodath (2020), “Role of Energy Use in The Prediction of CO2 Emissions And Economic Growth in India: Evidence from Artificial Neural Networks (ANN)”, *Environmental Science And Pollution Research*, 27, 23631-23642.
- Ashraf, S. et al. (2020), “Relationships among environmental pollution, energy use and economic growth: a global perspective”, *OPEC Energy Review*, 44(4), 511-534.
- Aslan, A. et al. (2021), “The link between urbanization and air pollution in Turkey: evidence from dynamic autoregressive distributed lag simulations”, *Environmental Science and Pollution Research*, 28(37), 52370-52380.
- Association Internationale Pour L'évaluation du Rendement Scolaire (2017), *Energy Access Outlook 2017: From Poverty to Prosperity*, IEA.
- Aytun, C. vd. (2017), “Gelişen Ülkelerde Çevresel Bozulma, Gelir ve Enerji Tüketimi İlişkisi”, *Ömer Halis Demir Üniversitesi İktisadi ve İdari Bilimler Fakültesi Dergisi*, 10(1), 1-11.
- Baloch, M.A. et al. (2019), “Effect of Natural Resources, Renewable Energy and Economic Development on CO2 Emissions in BRICS Countries”, *Science of the Total Environment*, 678, 632-638.
- BP (2023), *Statistical Review of World Energy*, <<https://www.bp.com/en/global/corporate/energy-economics/statistical-review-of-world-energy.html>>, 20.05.2023.
- Cantarero, M.M.V. (2020), “Of Renewable Energy, Energy Democracy, And Sustainable Development: A Roadmap To Accelerate The Energy Transition in Developing Countries”, *Energy Research & Social Science*, 70, 101716.
- Cherni, A. & S.E. Jouini (2017), “An ARDL approach to the CO2 emissions, renewable energy and economic growth nexus: Tunisian evidence”, *International Journal of Hydrogen Energy*, 42(48), 29056-29066.
- Çizmeçi, H. vd. (2018), “Yapay Sinir Ağları Kullanılarak Yükseköğretimde Öğrenci Adaylarının Başarı Durumlarının Tahmin Edilmesi”, *20. Akademik Bişim Konferansı* (183-186), Karabük, Türkiye.
- Endonezya İstatistik Ofisi (2023), <<https://www.bps.go.id/>>, 18.04.2023.
- Ercan, U. (2021), “Ev Dışı Gıda Tüketim Sınıflarının Yapay Sinir Ağları ile Tahmin Edilmesi”, *İşletme Araştırmaları Dergisi*, 13(4), 3265-3277.
- Fullwood, M.J. et al. (2009), “An Oestrogen-Receptor-A-Bound Human Chromatin Interactome”, *Nature*, 462(7269), 58-64.
- Garcés, E.F.M. et al. (2019), “Artificial Neuronal Networks to Predict The Emissions of Carbon Dioxide (CO₂) Using A Multilayer Network With The Levenberg-Marquardt Training Method”, *WSEAS Transactions On Environment And Development*, 16, 346-354.
- Giudici, P. (2003), *Applied Data Mining Statistical Methods for Business and Industry*, West Sussex, England: John Wiley & Sons.
- Grossman, G.M. & A.B. Krueger (1991), “Environmental impacts of a North American free trade agreement”, *NBER Working Paper* No: 3914.
- Gürlük, S. (2010), “Sürdürülebilir kalkınma gelişmekte olan ülkelerde uygulanabilir mi”, *Eskişehir Osmangazi Üniversitesi İİBF Dergisi*, 5(2), 85-99.
- Hagan, M.T. & M. Menhaj (1994), “Training feed-forward networks with the Marquardt algorithm”, *IEEE Transactions on Neural Networks*, 5(6), 989-993.
- Hagan, M.T. et al. (1996), *Neural Network Design*, Boston, MA: PWS Publishing.

- Haykin, S. (2008), *Neural Networks and Learning Machines Third Edition*, New Jersey: Pearson, Prentice Hall.
- Jena, P.R. et al. (2021), "Forecasting The CO2 Emissions At The Global Level: A Multilayer Artificial Neural Network Modelling", *Energies*, 14(19), 6336.
- Kamel, A. (2001), "D-8 Ekonomik Birliği Örgütü", *Avrasya Dosyası*, 7(2), 250-260.
- Karaaslan, A. & S. Çamkaya (2022), "The relationship between CO2 emissions, economic growth, health expenditure, and renewable and non-renewable energy consumption: Empirical evidence from Turkey", *Renewable Energy*, 190, 457-466.
- Kendall, M.G. et al. (1963), *The advanced theory of statistics*, Griffin, London.
- Komeili-Birjandi, A. et al. (2022), "Modeling Carbon Dioxide Emission of Countries in Southeast of Asia by Applying Artificial Neural Network", *International Journal of Low-Carbon Technologies*, 17, 321-326.
- Larose, D.T. (2005), *Discovering Knowledge in Data an Introduction to Data Mining*, New Jersey: John Wiley&Sons, Inc.
- Liang, W. & M. Yang (2019), "Urbanization, economic growth and environmental pollution: Evidence from China", *Sustainable Computing: Informatics and Systems*, 21, 1-9.
- Luger, G.F. (2002), *Artificial Intelligence: Structures and Strategies for Complex Problem Solving*, 4th edition, Addison Wesley.
- Marjanović, V. et al. (2016), "Prediction of GDP Growth Rate Based on Carbon Dioxide (CO2) Emissions", *Journal of CO2 Utilization*, 16, 212-217.
- Marquardt, D. (1963), "An Algorithm for Least-Squares Estimation of Nonlinear Parameters", *SIAM Journal on Applied Mathematics*, 11(2), 431-441.
- Muhumuza, R. et al. (2018), "Energy consumption levels and technical approaches for supporting development of alternative energy technologies for rural sectors of developing countries", *Renewable and Sustainable Energy Reviews*, 97, 90-102.
- Musah, M. et al. (2021), "Trade openness and CO2 emanations: a heterogeneous analysis on the developing eight (D8) countries", *Environmental Science and Pollution Research*, 28, 44200-44215.
- Nepal, R. & N. Pajja (2019), "A multivariate time series analysis of energy consumption, real output and pollutant emissions in a developing economy: new evidence from Nepal", *Economic Modelling*, 77, 164-173.
- Nilsson, N.J. (1998), *Artificial Intelligence: A New Synthesis*, Morgan Kaufmann Publishers.
- Ouedraogo, N.S. (2017), "Africa Energy Future: Alternative Scenarios And Their Implications for Sustainable Development Strategies", *Energy Policy*, 106, 457-471.
- Özhan, E. (2020), "Yapay Sinir Ağları ve Üstel Düzleştirme Yöntemi ile Türkiye'deki CO2 Emisyonunun Zaman Serisi ile Tahmini", *Avrupa Bilim ve Teknoloji Dergisi*, (19), 282-289.
- Öztürk, K. & M.E. Şahin (2018), "Yapay Sinir Ağları ve Yapay Zekâ'ya Genel Bir Bakış", *Takvim-i Vekayi*, 6(2), 25-36.
- Pabuçcu, H. & T. Bayramoğlu (2016), "Yapay Sinir Ağları İle CO2 Emisyonu Tahmini: Türkiye Örneği", *Gazi Üniversitesi İktisadi ve İdari Bilimler Fakültesi Dergisi*, 18(3), 762-778.
- Pakistan Federal İstatistik Bürosu (2023), <<https://www.pbs.gov.pk/>>, 15.04.2023.

- Patterson, D. et al. (2021), “Carbon Emissions And Large Neural Network Training”, *Arxiv Preprint Arxiv*: 2104.10350.
- REN21 (2023), *Renewables Global Status Report 2020*, <https://www.ren21.net/wp-content/uploads/2019/05/gsr_2020_full_report_en.pdf>, 15.04.2023.
- Russell, S. & P. Norvig (1995), *Artificial Intelligence: A Modern Approach*, Prentice-Hall.
- Sel, A. & B. Tekgün (2022), “Anfis Yöntemi ile Türkiye Karbondioksit Salınımı Tahmini”, *Vizyoner Dergisi*, 13(34), 486-504.
- Solarin, S.A. (2020), “An environmental impact assessment of fossil fuel subsidies in emerging and developing economies”, *Environmental Impact Assessment Review*, 85, 106443.
- The Worldbank Orgazitation (2023), <<http://www.worldban.org>>, 15.03.2023.
- Türkiye Cumhuriyeti Dışişleri Bakanlığı (2023), <<https://www.mfa.gov.tr>>, 10.04.2023.
- Türkiye İstatistik Ofisi (2023), <https://www.tuik.gov.tr/Kurumsal/Istatistik_Ofisleri>, 10.04.2023.
- UNEP (2023), *Renewables Global Status Report 2021*, <<https://www.unep.org/resources/report/renewables-2021-global-status-report>>, 15.04.2023.
- URL 1 (2023), <<https://ennurcitur.wordpress.com/2020/02/19/yapay-sinir-aglari/>>, 24.08.2023..
- URL 2 (2023), <<https://www.akanesen.com/2017/09/yapay-sinir-agnn-ana-ogeleri.html>>, 24.08.2023.
- V.V. Nabiyev (2016), *Yapay Zeka*, Seçkin Yayıncılık, Ankara.
- Vlahov, D. et al. (2007), “Urban As A Determinant of Health”, *J Urban Health*, 84 (1), 16-26.
- Wang, S. et al. (2021), “Global value chains, technological progress, and environmental pollution: Inequality towards developing countries”, *Journal of Environmental Management*, 277, 110999.
- Wang, W. & Y. Lu (2018), “Analysis of the Mean Absolute Error (MAE) and the Root Mean Square Error (RMSE) in Assessing Rounding Model”, in: *IOP Conference Series: Materials Science And Engineering*, 324, 012049.
- Xing, L. et al. (2023), “Investigating the impact of economic growth on environment degradation in developing economies through STIRPAT model approach”, *Renewable and Sustainable Energy Reviews*, 182, 113365.
- Zeng, Y.R. et al. (2017), “Multifactor-Influenced Energy Consumption Forecasting Using Enhanced Back-Propagation Neural Network”, *Energy*, 127, 381-396.
- Zhou, Y. et al. (2018), “The impact of economic growth and energy consumption on carbon emissions: evidence from panel quantile regression”, *Journal of Physics: Conference Series*, 1053, 012118.

Sosyal Koruma Harcamalarının Gelir Eşitsizliği Üzerindeki Etkisi: Türkiye Örneği¹

Tarık Zeki YILMAZ (<https://orcid.org/0000-0003-0620-1308>), Trabzon University, Türkiye;
tz.yilmaz@trabzon.edu.tr

Cemil RAKICI (<https://orcid.org/0000-0003-1053-0411>), Karadeniz Technical University, Türkiye;
cemil.rakici@ktu.edu.tr

The Effect of Social Protection Expenditures on Income Inequality: The Case of Türkiye²

Abstract

Income inequality causes negativities in many areas, especially in the economy. Governments intervene in income distribution with the policies they implement. The effect of public social protection expenditures on income inequality is the subject of the study. Measuring the long-term impact of social protection expenditures on income inequality, together with its sub-components, constitutes the unique value of the study. The effect of social protection expenditures on income inequality with its sub-components in the 1987-2018 period in Türkiye was analysed using the ARDL model. The findings reveal that social protection expenditures, except for health expenditures, reduce income inequality in Türkiye.

Keywords : Income Inequality, Social Protection Expenditures, Türkiye, ARDL Model.

JEL Classification Codes : C22, E62, O24.

Öz

Gelir dağılımı, başta ekonomi olmak üzere birçok alanda olumsuzluklara neden olmaktadır. Gelir dağılımının piyasa güçlerine bırakıldığında kendi başına giderilememesi nedeniyle hükümetler, uyguladıkları politikalarla gelir dağılımına müdahale etmektedirler. Bu bağlamda, hükümetlerin yaptıkları sosyal koruma harcamalarının gelir dağılımı eşitsizliği üzerindeki etkisi çalışmanın konusunu oluşturmaktadır. Türkiye’de sosyal koruma harcamalarının alt bileşenleri ile birlikte gelir dağılımı eşitsizliği üzerindeki uzun dönemli etkisinin ölçülmesi, çalışmanın özgün değerini oluşturmaktadır. Bu noktadan hareketle, Türkiye’de 1987-2018 döneminde yapılan sosyal koruma harcamalarının alt bileşenleriyle birlikte gelir eşitsizliği üzerindeki etkisi ARDL modeli yardımıyla analiz edilmiştir. Elde edilen bulgular, Türkiye’de sağlık harcamaları haricinde sosyal koruma harcamalarının gelir dağılımı eşitsizliğini azalttığını ortaya koymaktadır.

Anahtar Sözcükler : Gelir Eşitsizliği, Sosyal Koruma Harcamaları, Türkiye, ARDL Modeli.

¹ Bu makale, Karadeniz Teknik Üniversitesi Sosyal Bilimler Enstitüsü Maliye Anabilim Dalında, Prof.Dr. Cemil Rakıcı danışmanlığında Tarık Zeki Yılmaz tarafından yazılan “Sosyal Koruma Harcamalarının Gelir Dağılımı Üzerindeki Etkisinin Türkiye Açısından Değerlendirilmesi” isimli doktora tezinden üretilmiştir.

² This article is produced from Tarık Zeki Yılmaz’s PhD dissertation entitled “Assessment of The Effect of Social Protection Expenditures on Income Distribution for Türkiye”, prepared at Karadeniz Technical University, Institute of Social Sciences, Department of Public Finance under the supervision of Prof.Dr. Cemil Rakıcı.

1. Giriş

Gelir dağılımı olarak adlandırılan ve milli gelirin toplumu oluşturan bireyler arasındaki bölüşümünü ifade eden kavram başta ekonomik olmak üzere birçok alanda olumsuz sonuçlara neden olmaktadır. Gelirin eşit olmayan bir şekilde dağılımının başta yoksulluk ve refah olmak üzere suç oranlarındaki artıştan bireylerin mutluluğuna kadar birçok alanda olumsuz anlamda etki gösterdiğini söylemek mümkündür. Bu nedenle hükümetler uyguladıkları politikalarla gelir dağılımındaki eşitsizliği gidermeyi amaçlamışlardır. Bu yönüyle gelir dağılımı sorunu geçmişten günümüze iktisat literatüründe birçok araştırmanın konusu olmuştur.

Ekonomik literatürde gelir dağılımındaki eşitsizliğin çözülemez bir sorun olmadığı yönündeki görüş genel kabul görmektedir. Buna göre, kaynakların yoksul kesime doğru; vergiler, sosyal transferler ve kamu hizmeti sunumuyla yeniden dağıtılmasında hükümet müdahalelerin yetersiz veya verimsiz oluşu, çoğu OECD ülkesinde gelir eşitsizliğindeki artışın temel nedenini oluşturmaktadır. Bu konuda yapılan çalışmalar neticesinde, özellikle nakdî transferlerin toplumda nispeten zayıf gruplar arasında gelir yeterliliğini sağlamada kilit rol oynadığı sonucuna varılmıştır (d'Agostino et al., 2018: 2).

Bir müdahale olmaksızın gelir dağılımında eşitsizliğin kendiliğinden gerçekleşmesi mümkün görülmemekte ve devlet, "sosyal devlet" anlayışı doğrultusunda gelir dağılımına müdahale etmektedir. Bu nedenle, kamu otoritesi; doğrudan gelir transferleri, vergi indirimleri ve tarımsal ihracatı desteklemek gibi politikalar uygulayarak gelir dağılımına müdahale etmektedir. Devlet ayrıca, sosyal hizmet harcamaları ve bu harcamaların finansmanı için toplanan kamu gelirleri yoluyla da gelir dağılımını etkilemektedir. Başta, gelir dağılımının bozuk olduğu gelişmekte olan ülkeler olmak üzere, gelir dağılımını iyileştirmeye yönelik uygulamaların maliye politikası amaçları içerisinde oldukça önemli bir yere sahip olduğu söylenebilir (Erçakar & Güvenoğlu, 2018: 46).

Hükümetler, vergi ve transfer sistemleri yoluyla özel sektör gelirlerindeki yüksek eşitsizliği ortadan kaldırmakta ve bu sayede daha eşit bir gelir dağılımını amaçlamaktadırlar. Bu doğrultuda kullanılan sosyal güvenlik sistemlerinin yeniden dağıtım üzerindeki etkisi; işsizlik ödeneği, çocuk ve aile yardımı ve sosyal emeklilik ödeneği gibi transfer ödemeleri yoluyla yeniden dağıtım öncesi en düşük gelire sahip olanlara fayda sağlamak olurken, ikinci mekanizma olan vergilerde ise, çoğu zaman vergi sisteminde, yüksek gelire sahip olanlar, düşük gelirli olanlara oranla daha yüksek gelir vergileri öderler. Artan oranlı vergilendirme ile zengin ve yoksul haneler arasındaki açık daraltmakta ve gelir eşitsizliği azalmaktadır. Kısacası, gelirin yeniden dağıtımında hükümetler tarafından kullanılan araçlardan sosyal transferler, yoksul kesime fayda sağlayarak gelirlerini artırırken, vergiler ise, zengin kesimin servetini azaltarak gelir dağılımındaki eşitsizliği gidermeye yardımcı olur (Luebker, 2011: 1).

Gelir eşitsizliğini azaltma amacı doğrultusunda gerçekleştirilen sosyal koruma harcamaları, topluma, bireylere ve hane halklarına riskleri yönetme ve yaşamın her alanında

aktif olarak yer almaları konularında yardım eden, tüm vatandaşlara destek sağlayan ve devlet tarafından finanse edilen bir dizi kamu tedbirlerini ifade eder (Holmes & Lwanga-Ntale, 2012: 4). Hedeflerine ve kapsadıkları risklere bağlı olarak farklı sosyal koruma programları söz konusudur. Gelişen dünya için kabul edilen sosyal koruma uygulamaları; sosyal sigortaları (katkı esasına dayalı), işgücü piyasaları programlarını (örneğin iş eğitimi) ve sosyal yardımları (herhangi bir katkıya dayalı olmayan) kapsamaktadır (Ait Mansour, 2016: 10). Sosyal koruma harcamaları, OECD'nin yapmış olduğu sınıflandırmaya göre; yaşlılık, dul ve yetim, malullük, sağlık, aile, işsizlik ve konut yardımlarının yanı sıra aktif işgücü piyasası programları ile kategorize edilmemiş diğer yardımlar olmak üzere 9 alt bileşenden oluşmaktadır (Sinram, 2019: 35).

Sosyal koruma programlarının bölgesel ve makro düzeyde eşitsizlik üzerinde büyük etkileri olduğunu söylemek mümkündür. Sosyal koruma politikaları, eşitsizlikleri azaltarak bireylerin fırsatlara eşit şekilde erişmesine katkıda bulunabilir. Bu sayede sosyal koruma programlarının gelir eşitsizliğinin azalmasına katkıda bulunduğunu söylemek mümkündür. Ayrıca, sosyal koruma programlarının eşitsizlikleri azaltarak sosyal uyumu teşvik ettiği ve ekonomik büyüme üzerinde önemli bir dolaylı pozitif etkiye sahip olduğu söylenebilir (OECD, 2019: 29).

Sosyal koruma programlarının, servetin yeniden dağıtımını sağlayarak ekonomik eşitsizliğin azalmasını sağladığı söylenebilir. Sosyal koruma programları yoluyla etkin bir yeniden dağıtım, ailelerin besleyici gıda, sağlık hizmetleri ve eğitim gibi olanaklara erişmesine yardımcı olarak ve yoksulluk tuzaklarından kaçınmak için gerekli insan sermayesini inşa ederek eşitsizliğin ve devamında da yoksulluğun nesiller arası aktarımını engelleyebilir. Gelişmiş ülkelerde sosyal korumanın gelir eşitsizliği üzerindeki etkisine ilişkin olumlu sonuçlar, gelişmekte olan ülkelere göre daha kolay elde edilebilir. Bunun nedenleri, gelişmekte olan ülkelere; transferlerin boyutunun sınırlı olması, yetersiz kapsam ve vergi sisteminin azalan oranlı etkisi olarak görülmektedir (Mahmud & Sharpe, 2021: 10).

Sosyal koruma, muhtaç durumdaki bireylere fayda sağlamanın yanı sıra toplumların refahını da artırır. Ekonomik krizler sırasında, özel harcamalar kısıldığında, sosyal koruma uygulamaları aracılığı ile artan kamu harcamaları, ekonomileri ve istihdamı canlandırmada hayati önem taşımaktadır. Sosyal koruma programlarının etkisi; onun nasıl dizayn edildiğine, uygulama düzeyine ve transferlerin yeterliliğine göre değişmekle birlikte, uygun şekilde tasarlanıp ve uygulanması halinde, sosyal korumanın sadece yoksulluğu önlemek için değil, eşitsizliği azaltma ve ekonomik büyümeyi teşvik etme potansiyeline sahip olduğunu göstermektedir (United Nations, 2018: 10).

Diğer taraftan, yardımların finansman yöntemlerinin makroekonomik göstergeler üzerinde etkisi olduğunu söylemek mümkündür. Şöyle ki, sosyal güvenlik sistemlerindeki aktüeryal dengenin bozulması sonucu oluşacak açığın borçlanma emisyon ya da kamu bütçesinden transferler gibi yollarla kapatılması makroekonomik göstergeleri olumsuz etkilemektedir. Finansman açığının emisyon veya bütçeden transferler yoluyla karşılanması enflasyon üzerinde baskı oluştururken, borçlanma faiz oranlarının yükselmesine ve

dolayısıyla yatırımların ve büyümenin olumsuz etkilenmesine neden olabilmektedir. Buna bağlı olarak da işsizliğin artacağı ve gelir dağılımı olumsuz etkileneceği ileri sürülebilmektedir (Baylan, 2015: 41).

2. Literatür

Literatürde, kamu harcamaları ile gelir dağılımı arasındaki ilişkiyi konu edinen çok sayıda çalışma yer almaktadır. Bu çalışmalar, sosyal nitelikli kamu harcamaları ile gelir dağılımı arasındaki ilişkinin yanı sıra, eğitim ve sağlık gibi harcama kalemlerinin gelir dağılımı üzerindeki etkisini konu edinmiştir. Ayrıca sosyal koruma harcamalarını oluşturan bileşenler bazında da gelir dağılımı üzerindeki etkisini inceleyen çalışmalara da literatürde sıkça rastlanmaktadır. Tablo 1’de, sosyal koruma harcamalarının gelir dağılımı üzerindeki etkisini inceleyen çalışmalara ilişkin literatür özetine yer verilmiştir.

Tablo: 1
Literatür Özeti

Yazar/Yıl	Dönem	Ülke	Yöntem	Bulgular
Dayar & Akıncı (2020)	1987-2018	Türkiye	<ul style="list-style-type: none">Maki Çoklu Yapısal Kırımlı Eşbütünlüşme TestiTam Düzeltilmiş En Küçük Kareler TestiHatemi-J Asimetrik Nedensellik Testi	Kamu sosyal transfer harcamalarındaki %1’lik artış, Gini katsayısını %0,505 oranında azaltmaktadır.
Baylan (2019)	1975-2010	Türkiye	VAR Modeli	Sosyal güvenlik harcamaları ile gelir eşitsizliği arasında negatif yönlü bir ilişki olduğu sonucuna ulaşılmıştır.
Demiryürek Ürper (2018)	1985-2016	Türkiye	Çoklu Regresyon Analizi	Transfer harcamalarının gelir dağılımı üzerinde olumlu etkisi olduğu sonucuna ulaşılmıştır.
Altunöz & Çondur (2018)	1985-2016	Türkiye	Johansen Eşbütünlüşme Testi	Gini katsayısı ve Sosyal Güvenlik Harcamaları değişkenleri arasında çift yönlü nedensellik ilişkisi bulunmuştur. Buna göre, sosyal güvenlik harcamalarında meydana gelecek artışın, gelir dağılımında eşitsizliği azalttığı sonucuna ulaşılmıştır.
Cammeraat (2020)	1990-2015	22 AB Ülkesi	Panel Veri Analizi (OLS ve 2SLS regresyon modelleri)	Kamu sosyal harcamaları ile gelir eşitsizliği arasında negatif yönlü ilişki bulunmuştur.
Kalkavan & Ersin (2020)	1980-2015	OECD Ülkeleri	Dumitrescu-Hurlin Nedensellik Testi	Sosyal harcamalar ile gelir dağılımı arasında istatistiksel olarak anlamlı bir ilişkinin olduğu ve sosyal harcamalardan gelir dağılımına doğru nedensellik ilişkisi olduğu sonucuna ulaşılmıştır.
Osabohien vd. (2020)	2000-2017	38 Afrika Ülkesi	Panel Veri Analizi (EKK) Yöntemi	Sosyal koruma harcamalarındaki %1’lik bir artışın, gelir eşitsizliğini %26 oranında azalttığı ortaya konulmuştur.
Polat (2020)	1996-2018	36 OECD Ülkesi	Panel Veri Analizi	Transfer ödemelerinin gelir dağılımı eşitsizliğini azalttığı ortaya konulmuştur.
İnam (2019)	2007-2015	29 AB Ülkesi (Türkiye dahil)	Panel Veri Analizi	Sosyal koruma harcamalarının Gini katsayısını negatif yönde etkilediği (sosyal koruma harcamalarındaki %1’lik artışın Gini katsayısını %0,3379309 kadar azalttığı) ortaya konulmuştur. Ayrıca, sağlık harcamalarının Gini katsayısını pozitif yönde etkilediği (sağlık harcamalarındaki %1’lik bir artışın Gini katsayısını %0,2705543 artırdığı) sonucuna ulaşılmıştır.
Sanchez & Perez-Corral (2018)	2005-2014	28 AB Ülkesi	Dinamik Panel Veri Analizi (GMM) Yöntemi	Kamu sosyal harcamaları ile gelir eşitsizliği arasında negatif yönlü bir ilişki bulunmuştur.
d’Agostino vd. (2018)	1980-2015	26 OECD Ülkesi	Panel Veri Analizi	Sosyal transferler ile gelir dağılımı eşitsizliği arasında istatistiksel olarak anlamlı ve negatif yönlü bir ilişkinin var olduğu ortaya konulmuştur.
Ulu (2018)	2004-2011	Seçilmiş Ülkeler	Panel Veri Analizi	Kamu sosyal harcamalarının GSYH’ye oranının arttıkça Gini katsayısının düştüğü ve gelir dağılımındaki eşitsizliğin azaldığı ortaya koymuştur. Çalışmada, kamu sosyal harcamalarının GSYH’da meydana gelecek %1’lik bir artışın, Gini katsayısını %0,0015 oranında azalttığı sonucuna ulaşılmıştır.
Kozuharov & Petkovski (2018)	2002-2014	Makedonya	Regresyon Analizi	Sosyal transfer harcamaları ile gelir eşitsizliği arasında ters yönlü bir ilişkinin olduğu ileri sürülmüştür.

İlgün (2015)	1995-2012	17 OECD Ülkesi	Panel Veri Analizi	Toplam kamu sosyal harcamalarının gelir dağılımı üzerinde anlamlı ve olumlu etkisi olduğu sonucuna ulaşılmıştır. Sosyal harcamaların alt kategorileri incelendiğinde ise, aktif emek piyasası programları, işsizlik sigortası ile dul ve yetim yardımlarının gelir dağılımı üzerinde anlamlı etkisinin olduğu ortaya konulmuştur.
--------------	-----------	----------------	--------------------	---

Tablo 1’de yer alan çalışmalara ilişkin ulaşılan sonuçlar incelendiğinde, kamu sosyal harcamalarının gelir eşitsizliğini azalttığına ilişkin görüşün literatürde kendine yer edindiği görülmektedir. Buna göre, sosyal nitelikli harcamalar arttıkça gelir dağılımındaki eşitsizliğin azaldığını söylemek mümkündür.

3. Ekonometrik Analiz

Çalışmanın bu bölümünde ekonometrik analiz için kullanılacak veri seti, yöntem ve ampirik bulgulara yer verilecektir.

3.1. Veri Seti ve Yöntem

Bu kısımda çalışmada kullanılan veri seti ve yöntemler hakkında bilgi verilecektir. Bu doğrultuda hazırlanan Tablo 2’de ekonometrik analizde kullanılacak veri seti, Tablo 3’te ise tanımlayıcı istatistiklere yer verilmiştir.

Tablo: 2
Veri Seti

Kısaltmaları	Veri Açıklaması	Kaynak
GINI	Gelir Dağılımı Eşitsizliği Katsayısı	SWIID
TSY	Toplam Sosyal Yardımlar/Gayri Safi Yurtiçi Hasıla	OECD-TÜİK
TNY	Toplam Nakdi Yardımlar/Gayri Safi Yurtiçi Hasıla	OECD-TÜİK
TAY	Toplam Aynı Yardımlar/Gayri Safi Yurtiçi Hasıla	OECD-TÜİK
YDY	Yaşlı-Dul-Yetim Yardımları/Gayri Safi Yurtiçi Hasıla	OECD-TÜİK
SGY	Sağlık Yardımları/Gayri Safi Yurtiçi Hasıla	OECD-TÜİK
AIY	Aile Yardımları/Gayri Safi Yurtiçi Hasıla	OECD-TÜİK
İŞY	İşsizlik Yardımları/Gayri Safi Yurtiçi Hasıla	OECD-TÜİK
MAL	Malullük Yardımları/Gayri Safi Yurtiçi Hasıla	OECD-TÜİK

Tablo 2’de yer alan değişkenlerden, Gini katsayısı bağımlı değişken, kamu sosyal yardımları ise bağımsız değişken olarak belirlenmiştir. Bağımlı değişken olan Gini katsayısı SWIID kaynağından, bağımsız değişkenler ise OECD ve TÜİK kaynağından elde edilmiştir.

Tablo: 3
Tanımlayıcı İstatistikler

	GINI	TSY	TNY	TAY	YDY	SGY	AIY	İŞY	MAL
Ortalama	41,92	8,07	5,00	3,07	4,08	2,80	0,47	0,26	0,27
Medyan	42,55	9,28	5,54	3,65	5,10	3,28	0,37	0,24	0,22
Maksimum	43,50	13,02	8,50	4,88	7,76	4,45	0,92	0,76	0,46
Minimum	40,00	2,18	1,33	0,74	0,27	0,70	0,20	0,05	0,13
Standart Sapma	1,31	3,72	2,68	1,12	3,06	0,98	0,23	0,21	0,10
Çarpıklık	-0,41	-0,21	-0,11	-0,49	-0,17	-0,52	0,63	0,53	0,57
Basıklık	1,49	1,38	1,29	1,93	1,22	2,07	1,87	2,14	1,88
Jarque-Bera	3,92	3,71	3,94	2,83	4,38	2,58	3,86	2,48	3,44
Olasılık	0,14	0,15	0,13	0,24	0,11	0,27	0,14	0,28	0,18

Not: Çarpıklık değeri > 0 ise değişkenlerin sağa çarpık; çarpıklık değeri < 0 ise değişkenlerin sola çarpık dağılıma sahip olduğu göstermektedir. Basıklık değeri < 3 olması değişkenlerin basık olduğu anlamına gelmektedir.

Tablo 3'e göre, GINI değişkenine ait en yüksek değer 43,5; en düşük değer ise 40'tır. TSY değişkenin en yüksek değeri 8,50, en düşük değeri 2,18'dir. TNY değişkenine ait en yüksek değer 8,50, en düşük değeri ise 1,33 olduğu görülmektedir. TAY değişkenin en yüksek değeri 4,88, en düşük değeri 0,74'tür. YDY değişkenin en yüksek değeri 7,76, en düşük değeri ise 0,27'dir. SGY değişkenin en yüksek değeri 4,45 en düşük değeri 0,70'tir. Tablo 3'te; AİY, İŞY ve MAL değişkenlerine ait sırasıyla en yüksek değerler 0,92, 0,76 ve 0,46 iken en düşük değerler ise 0,20, 0,05 ve 0,13 olduğu görülmektedir. Değişkenlere ait çarpıklık değerlerine bakıldığında; GINI, TSY, TNY, TAY, YDY ve SGY değişkenleri sola çarpık; AİY, İŞY ve MAL değişkenleri sağa çarpıktır. Bütün değişkenlerin basıklık değerleri 3'ten küçüktür ve dolayısıyla değişkenlerin basık dağılıma sahip olduğu görülmektedir.

Grafik: 1
Değişkenlere Ait Grafikler

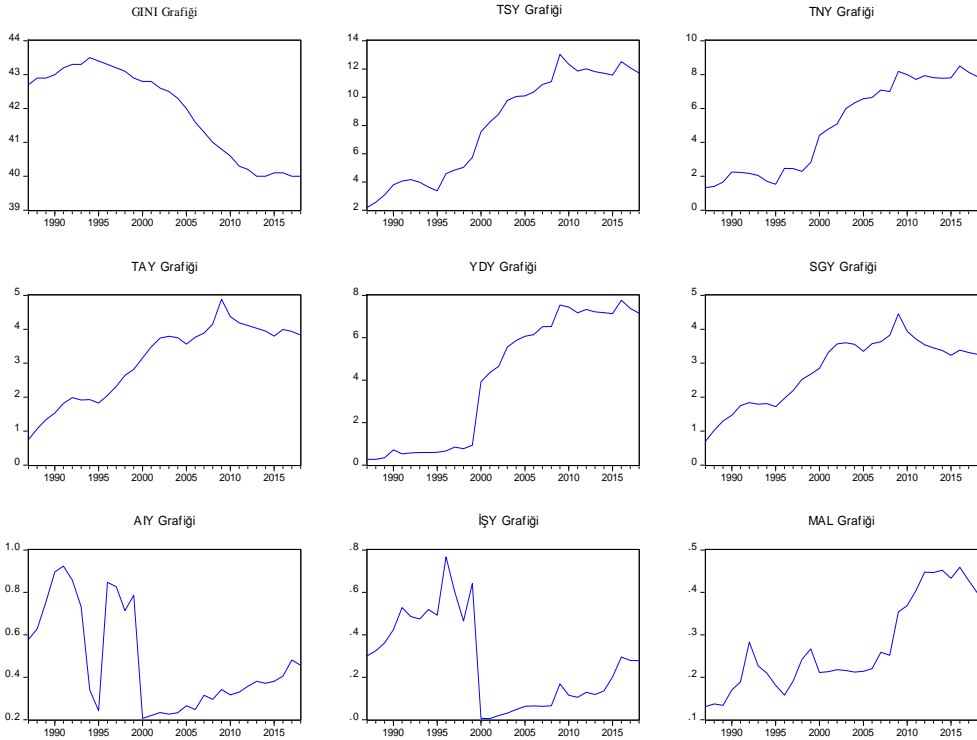

Değişkenlerin standart sapmaları açısından bakıldığında; TSY değişkeni en yüksek standart sapmaya sahip iken MAL değişkeni en düşük standart sapmaya sahiptir. Diğer bir ifadeyle, 1987-2018 dönemi diğer değişkenlerle kıyaslandığında; TSY değişkeninin daha oynak yapıda, MAL değişkeninin ise daha az oynaklığı sahip olduğu görülmektedir. Değişkenlere ait daha detaylı ve görsel bilgiler Grafik 1'de yer almaktadır. Grafik 1

incelendiğinde, değişkenlere ilişkin aşağıda belirtilen noktalar dikkat çekmektedir. Buna göre:

- GINI grafiğinde; 1987-2018 dönemi GINI değişkenine ait ortalama değer %41,92 seviyelerinde gerçekleşmiştir. GINI değişkeninin 1987-1994 yılları arasında artış eğiliminde olduğu yani eşitsizliğin giderek arttığı ve 1994 yılında en yüksek değerine ulaştığı görülmektedir. 1995 yılı itibarıyla azalmaya başlamıştır. 1995 yılında %43,4 olan değer 2018 yılına gelindiğinde %40 seviyesine gerilemiştir.
- TSY grafiğinde; 1987-2018 dönemi TSY değişkenine ait ortalama değer %8.07 seviyelerinde gerçekleştiği görülmektedir. TSY değişkeninin ele alınan dönem itibarıyla artış eğiliminde olduğu ve 2009 yılında en yüksek değerine ulaştığı görülmektedir.
- TNY grafiğinde görüldüğü gibi; 1987-2018 dönemi TNY değişkenine ait ortalama değer %5 seviyelerinde gerçekleşmiştir. TNY değişkeninde ele alınan dönem itibarıyla bazı dönemler azalma görülse de genel itibarıyla artış eğiliminde olduğu ve 2016 yılında en yüksek değerine ulaştığı görülmektedir.
- TAY grafiğinde; 1987-2018 dönemi TAY değişkenine ait ortalama değer %3,07 seviyelerinde olduğu görülmektedir. TAY değişkeninin ele alınan dönem itibarıyla genel olarak artış eğiliminde olduğu ve 2009 yılında en yüksek değerine ulaştığı görülmektedir.
- YDY grafiğinde; 1987-2018 dönemi YDY değişkenine ait ortalama değer %4.08 seviyelerinde gerçekleştiği görülmektedir. Ele alınan dönem itibarıyla artış eğiliminde olan YDY değişkeninin, 1987-1999 yılları arasında değerleri 0,27-0,93 aralığında iken 2000 yılından itibaren 3,92 seviyelerine ulaşarak 2018 yılında 7,15 olarak gerçekleşmiştir. 2016 yılında en yüksek değerine ulaştığı görülmektedir.
- SGY grafiğinde; 1987-2018 dönemi SGY değişkenine ait ortalama değer %2,08 olduğu görülmektedir. SGY değişkeninin ele alınan dönem itibarıyla genel olarak artış eğiliminde olduğu ve 2009 yılında en yüksek değerine ulaştığı görülmektedir.
- AİY grafiğinde, 1987-2018 dönemi AİY değişkenine ait ortalama değer %0,47 olduğu tespit edilmiştir. AİY değişkenine ait grafiğine göre 1987-2000 dönemi artış ve azalışları içeren dalgalı bir seyir izlese de 2001 yılı itibarıyla genel olarak bir artış eğiliminde olduğu görülmektedir. 1991 yılında en yüksek değerine ulaştığı görülmektedir.
- İŞY grafiğinde, 1987-2018 dönemi İŞY değişkenine ait ortalama değer %0,26 olduğu tespit edilmiştir. İŞY değişkenine ait grafiğine göre 1987-2000 dönemi artış ve azalışları içeren dalgalı bir seyir izlese de 2001 yılı itibarıyla genel olarak bir artış eğiliminde olduğu görülmektedir. 1996 yılında en yüksek değerine ulaştığı görülmektedir.
- MAL grafiğinde, 1987-2018 dönemi MAL değişkenine ait ortalama değer %0,27 olduğu tespit edilmiştir. MAL değişkeninde 1987-2018 dönemi artış ve azalışları içeren dalgalı bir seyir izlese de genel itibarıyla artış eğiliminde olduğu ve 2016 yılında en yüksek değerine ulaştığı görülmektedir.

3.2. Augmented Dickey-Fuller (ADF) ve Phillips-Perron (PP) Birim Kök Testleri

Dickey ve Fuller tarafından geliştirilen Augmented Dickey Fuller (ADF) birim kök testi sabitli (1) ve sabitli-trendli (2) olmak üzere (1) ve (2) nolu denklemdeki gibi ifade edilmektedir.

$$\Delta Y_t = \beta_0 + \beta_1 Y_{t-1} + \sum_{i=1}^m \mu_i \Delta Y_{t-i} + u_t \quad (1)$$

$$\Delta Y_t = \beta_0 + \beta_1 Y_{t-1} + \beta_2 \text{Trend} + \sum_{i=1}^m \mu_i \Delta Y_{t-i} + u_t \quad (2)$$

Tahmin edilen denklemlerde, β_0 , β_1 , β_2 ve μ katsayıları, Δ fark işlemcisini, u hata terimini ve $i=1,2,3,\dots,m$ optimal gecikme uzunluğunu temsil etmektedir. (1) ve (2) nolu denklemlerin tahmini ile bulunan β_1 katsayılarının anlamlılığı serilerin birim kök içermediğini ifade etmektedir. ADF denklemlerinde gecikme uzunlukları Schwarz Bilgi Kriteri (SIC) ile tespit edilmiştir.

Phillips-Perron (1988) tarafından geliştirilen PP birim kök testi için sabitli (3) ve sabitli-trendli modeller (3) ve (4) nolu denklemlerdeki gibi tahmin edilmektedir.

$$\Delta Y_t = \beta_0 + \beta_1 Y_{t-1} + u_t \quad (3)$$

$$\Delta Y_t = \beta_0 + \beta_1 Y_{t-1} + \beta_2 \text{Trend} + u_t \quad (4)$$

(3) ve (4) numaralı denklemlerde β_0 , β_1 , β_2 ve μ katsayıları, Δ fark işlemcisini, u hata terimini temsil etmektedir.

ADF ve PP testlerinde; H_0 hipotezi seride birim kök olduğunu, H_1 hipotezi ise seride birim kök olmadığını ifade etmektedir. ADF ve PP testleri yardımıyla denklemlerde yer alan β_1 katsayısına ait hesaplanan t istatistiklerinin mutlak değerleri, MacKinnon (1996) kritik mutlak değerlerinden küçükse serilerin durağan olmadığı (birim kök taşıdığı) kabul edilmektedir. Hesaplanan t istatistiklerinin mutlak değerleri, MacKinnon (1996) kritik mutlak değerlerinden büyükse serilerin durağan olduğu (birim kök taşımadığı) kabul edilmektedir.

3.3. ARDL Yöntemi

Pesaran, Shin ve Smith (2001) tarafından geliştirilen ARDL yönteminde kısa ve uzun dönem ilişkiler tahmin edilmektedir. ARDL yönteminde Sınır testi için kısıtlanmamış hata düzeltme modeli (7) nolu denklemdeki gibi tanımlanır.

$$\Delta Y_t = \beta_0 + \sum_{i=1}^m \beta_i \Delta Y_{t-i} + \sum_{i=0}^n \delta_i \Delta X_{t-i} + \mu_i Y_{t-1} + \pi_i X_{t-1} + u_t \quad (7)$$

(7) nolu denklemde β_0 , β_i , δ_i , μ_i ve π_i katsayıları, m ve n optimal gecikme uzunluklarını, Δ birinci dereceden farkları, u hata terimini temsil etmektedir. Optimal gecikme uzunlukları belirlendikten sonra değişkenler arasında eşbütünleşme ilişkisinin sınanması için Sınır testi yapılmaktadır.

ARDL Sınır testinde, $H_0: \beta_0 = \mu_i = \pi_i = 0$ ise seriler arasında eşbütünleşme ilişkisi yoktur, $H_1: \beta_0 \neq \mu_i \neq \pi_i \neq 0$ ise seriler arasında eşbütünleşme ilişkisi vardır şeklinde ifade edilmektedir. (7) nolu denklemde; seviyesinde değişkenlere ait μ_i ve π_i katsayılarına uygulanan Wald testi sonucunda hesaplanan F istatistiği tablo kritik değerinden büyük ise değişkenler arasında eşbütünleşme ilişkisinin olduğunu sonucuna ulaşılır. Değişkenler arasında eşbütünleşme ilişkisi tespit edildikten sonraki aşamada uzun ve kısa dönem katsayıları elde edilmektedir.

Değişkenlere ait uzun dönem ilişkileri belirlemek için, Akaike (AIC) kriterine göre seçilen uzun dönem ARDL (m,n) modeli (8) nolu denklemdeki gibi oluşturulmuştur.

$$Y_t = \beta_0 + \sum_{i=1}^m \mu_i Y_{t-i} + \sum_{i=0}^n \pi_i X_{t-i} + u_t \quad (8)$$

(8) nolu denklemde β_0 , μ_i ve π_i katsayıları, m ve n optimal gecikme uzunluklarını, u hata terimini temsil etmektedir. Seçilen ARDL (m,n) modelinin güvenilir ve istikrarlı olduğunu ortaya koymak için Breusch-Godfrey LM otokorelasyon, White değişen varyans ve Jarque-Bera (JB) normal dağılım (diagnostik) testleri kullanılmıştır.

ARDL(m,n) modelinden türetilen Hata Düzeltme modeli (9) nolu denklemdeki gibi ifade edilmektedir.

$$\Delta LY_t = \beta_0 + \sum_{i=1}^m \mu_i \Delta LY_{t-i} + \sum_{i=1}^n \pi_i \Delta LX_{t-i} + \tau ECT_{t-1} + u_t \quad (9)$$

(9) nolu denklemdeki β_0 , μ_i ve π_i kısa dönem katsayıları, τ hata düzeltme terimi katsayısını, m ve n optimal gecikme uzunluklarını temsil etmektedir. ECT_{t-1} hata düzeltme terimidir. τ katsayısının negatif ve anlamlı olması beklenmektedir.

3.4. Ampirik Bulgular

Çalışmanın bu bölümünde analiz sonucu elde edilen bulgular sunulacak ve değerlendirilecektir. Bu doğrultuda, Tablo 4 ve 5'te değişkenlere ait ADF ve PP birim kök test sonuçları yer almaktadır.

Tablo 4'te yer alan ADF testi sonucuna göre, bütün değişkenlerin birinci farkında I(1) durağan olduğu tespit edilmiştir.

Tablo: 4
ADF Birim Kök Testi

Değişkenler	ADF Testi			
	Seviyesinde		1.Farkında	
	Sabitli Model (C)	Sabitli+Trendli Model (C+T)	Sabitli Model (C)	Sabitli+Trendli Model (C+T)
GINI	-0.43(1)	-2.05(1)	2,77 ^a (0)	-2,54(0)
TSY	-1,34(0)	-0,74(0)	4,72 ^a (0)	-4,86 ^a (0)
TNY	-0,86(0)	-1,21(0)	-4,97 ^a (0)	-4,94 ^a (0)
TAY	-2,44(0)	-0,81(0)	-4,33 ^a (0)	-4,81 ^a (0)
YDY	-0,79(0)	-1,26(0)	-4,94 ^a (0)	-4,92 ^a (0)
SAG	-2,57(0)	-0,81(0)	-4,08 ^a (0)	-4,07 ^a (0)
AIY	-2,16(0)	-2,59(0)	-5,17 ^a (3)	-5,43 ^a (3)
İŞY	-1,84(0)	-2,16(0)	-6,94 ^a (0)	-6,82 ^a (0)
MAL	-1,02(0)	-1,86(0)	-5,23 ^a (0)	-5,13 ^a (0)
MacKinnon (1996) Tablo Kritik değerleri	%1	-3,66	-4,28	-3,69
	%5	-2,96	-3,56	-2,97
	%10	-2,61	-3,21	-2,62

Not: a: %1, b: %5, c: %10 seviyesinde anlamlılığı ifade etmektedir. () parantez içerisindeki değerler optimal gecikme uzunluğunu temsil etmektedir. Maksimum gecikme 7'dir.

Tablo 5'te yer alan PP testi sonucuna göre, bütün değişkenlerin birinci farkında I(1) durağan olduğu tespit edilmiştir. Bu sonuçlara göre, ADF ile PP testi sonuçları birbirini desteklemektedir.

Tablo: 5
PP Birim Kök Testi

Değişkenler	PP Testi			
	Seviyesinde		1.Farkında	
	Sabitli Model (C)	Sabitli+Trendli Model (C+T)	Sabitli Model (C)	Sabitli+Trendli Model (C+T)
GINI	-0,13(4)	-2,57(4)	-2,67 ^a (3)	-2,50(3)
TSY	-1,33(2)	-0,87(2)	-4,72 ^a (2)	-4,86 ^a (1)
TNY	-0,86(2)	-1,33(3)	-4,97 ^a (2)	-4,94 ^a (2)
TAY	-2,35(0)	-0,93(0)	-4,33 ^a (1)	-4,81 ^a (3)
YDY	-0,79(3)	-1,53(3)	-4,97 ^a (3)	-4,92 ^a (2)
SAG	-2,46(1)	-0,96(0)	-4,28 ^a (1)	-4,80 ^a (2)
AIY	-2,25(1)	-2,73(1)	-6,18 ^a (6)	-6,17 ^a (7)
İŞY	-1,70(4)	-2,06(4)	-6,85 ^a (3)	-6,74 ^a (3)
MAL	-1,02(0)	-1,94(1)	-5,25 ^a (2)	-5,15 ^a (2)
MacKinnon (1996) Tablo Kritik değerleri	%1	-3,66	-4,28	-3,67
	%5	-2,96	-3,56	-2,96
	%10	-2,61	-3,21	-2,62

Not: a: %1, b: %5, c: %10 seviyesinde anlamlılığı ifade etmektedir. Newey-West tahmincisi ile uyarlanmış gecikme uzunluğu belirlenmiştir. () parantez içerisindeki değerler gecikme uzunluğunu temsil etmektedir.

Sosyal koruma harcamalarının gelir dağılımı eşitsizliği üzerindeki etkisini araştırmak için değişkenler arasındaki kısa ve uzun dönem ilişkiler hakkında bilgi veren ARDL yöntemi tercih edilmiştir. ARDL yönteminde, $GINI=f(TSY)$, $GINI=f(TAY)$, $GINI=f(TNY)$, $GINI=f(AIY, İŞY, SGY, YDY, MAL)$ şeklinde modeller oluşturularak eşbütünleşme ilişkisi araştırılmıştır. Modellere ait hesaplanan F istatistikleri sonuçları Tablo 6'da yer almaktadır³.

³ Pesaran vd. (2001) tablo kritik değerleri $n=30$ gözlem sayısına sahip örnekler için verilmiştir. Gözlem değeri 30-80 arasında olan çalışmalar için Narayan tablo kritik değerleride dikkate alınmıştır. Dolayısıyla çalışmada gözlem sayısı 32 olduğu için Pesaran ve Narayan tablo kritik değerlerinin her ikisi de verilmiştir.

Tablo 6
ARDL Sınır Testi Sonuçları

Model	kk	F İstatistiği	Tablo Kritik Değerler	Pesaran vd, (2001)		Narayan (2005)	
				Tablo Kritik Değerleri		Tablo Kritik Değerleri	
				Alt Sınır I(0)	Üst Sınır I(1)	Alt Sınır I(0)	Üst Sınır I(1)
GINI=f(TSY)	11	17,50 ^a	%10	3,02	3,51	3,30	3,79
			%5	3,62	4,16	4,09	4,66
			%1	4,94	5,58	6,02	6,76
GINI=f(TNY)	11	17,38 ^a	%10	3,02	3,51	3,30	3,79
			%5	3,62	4,16	4,09	4,66
			%1	4,94	5,58	6,02	6,76
GINI=f(TAY)	11	17,75 ^a	%10	3,02	3,51	3,30	3,79
			%5	3,62	4,16	4,09	4,66
			%1	4,94	5,58	6,02	6,76
GINI=f(AİY, İŞY, SGY, YDY, MAL)	5	6,68 ^a	%10	2,08	3	2,40	3,51
			%5	2,39	3,38	2,91	4,19
			%1	3,06	4,15	4,13	5,76

Not: a: %1 anlamlılık düzeyini, k: bağımsız değişken sayısını ifade etmektedir. Narayan (2005: 1987) tablo kritik değerleri, case: II ve n=30 göre verilmiştir.

Tablo 6 incelendiğinde, modellere ait hesaplanan F-istatistiği değerlerinin, Pesaran vd. (2001) ve Narayan (2005) tablo kritik değerlerinden büyük olduğu görülmektedir. Diğer bir ifadeyle değişkenler arasında eşbütünlük ilişkisinin olduğu tespit edilmiştir.

Eşbütünlük ilişkisi tespit edildikten sonraki aşamada, AIC bilgi kriterine göre kısa ve uzun dönem ilişkilerini analiz etmek için en uygun ARDL modelleri tahmin edilmiştir⁴. Toplam Sosyal Yardımlara ilişkin tahmin edilen ARDL modeli sonuçları Tablo 7'de yer almaktadır.

Tablo 7
Toplam Sosyal Yardımlara İlişkin ARDL Modeli Tahmin Sonuçları

GINI=f(TSY)				
ARDL(1,1)				
Değişkenler	Katsayı	Standart Hata	t İstatistiği	P Değeri
GINI(-1)	0,85	0,03	25,39	0,00
TSY	-0,02	0,03	-0,81	0,42
TSY(-1)	-0,04	0,03	-1,16	0,25
C	6,55	1,49	4,3	0,00
Diagnostik(Tanım) Testler				
LM(F istatistikleri)				1,24 [0,30]
BPG(F istatistikleri)				0,62[0,60]
JB				1,17[0,55]

Not: LM: Breusch-Godfrey LM Otokorelasyon, BPG: Breusch- Pagan-Godfrey Değişen varyans, JB: Jarque-Bera Normallik testlerini ifade etmektedir. Köşeli parantez içindeki değerler ilgili istatistiğin olasılık değerini ifade etmektedir Modeldeki bağımsız değişkenlere ait katsayılar tabloda verilmiştir.

Tablo 7'de görüldüğü üzere, ARDL(1,1) modeli, uygun model olarak tahmin edilmiştir. Tablo 7'de yer alan tanımsal testlerden elde edilen bulgulara göre, ARDL modelinde otokorelasyon ve değişen varyans sorunlarının olmadığı, normal dağılıma sahip oldukları görülmektedir. Breusch-Godfrey LM, Breusch-Pagan-Godfrey ve Jarque-Bera test

⁴ Analizde Eviews 10 paket programı kullanıldığı için, ARDL modelleri için maksimum gecikme uzunluğu 4 alınmış ve AIC bilgi kriterine göre optimal gecikme uzunlukları belirlenerek en uygun modeller tahmin edilmiştir.

istatistikleri için sıfır hipotezi reddedilememektedir⁵. Tahmin edilen denklemde tanısız (diagnostik) açıdan bir problem olmadığı sonucuna ulaşılmıştır. ARDL (1,1) modeline ait uzun dönem katsayıları Tablo 8’de yer almaktadır.

Tablo: 8
Toplam Sosyal Yardımlara İlişkin Uzun Dönem Katsayıları

GINI=f(TSY)				
ARDL(1,1)				
Değişkenler	Katsayı	Standart Hata	t İstatistiği	P Değeri
TSY	-0,46	0,05	-8,78	0,00
C	45,14	0,39	114,155	0,00

Tablo 8’de görüldüğü üzere, TSY değişkenine ait uzun dönem katsayısı negatif ve istatistiksel olarak anlamlıdır. Uzun dönemde toplam sosyal yardımlar, GINI değişkenini negatif etkilemektedir. Tablo 19’daki bulgulara göre; toplam sosyal yardımlardaki %1’lik artış gelir dağılımı eşitsizliğini %0,46 azaltmaktadır. Tablo 9’da Toplam Sosyal Yardımlara İlişkin Hata Düzeltme Modeli yer almaktadır.

Tablo: 9
Toplam Sosyal Yardımlara İlişkin Hata Düzeltme Modeli

GINI=f(TSY)				
ARDL(1,1)				
Değişkenler	Katsayı	Standart Hata	t İstatistiği	P Değeri
$\Delta(TSY)$	-0,02	0,02	-0,96	0,34
ECT(-1)	-0,14	0,01	-7,51	0,00

Not: ECT(-1): Hata düzeltme katsayısını temsil etmektedir.

Tablo 9’da TSY değişkenine ait kısa dönem katsayısı negatif fakat istatistiksel olarak anlamsız olduğu için yorumlanmamıştır. ECT(-1) katsayısının -0.14 (negatif ve istatistiksel olarak anlamlı) olduğu görülmektedir. Kısa dönemde meydana gelecek sapmaların sonraki dönemlerde giderileceği sonucuna ulaşılmıştır. Buna göre, kısa dönemde meydana gelecek sapmanın %14’ü bir sonraki dönemde düzelecektir şeklinde ifade edilebilir. Toplam Nakdi Yardımlara ilişkin tahmin edilen ARDL modeli sonuçlarına Tablo 10’da yer verilmiştir.

⁵ Breusch-Godfrey LM ile Breusch-Pagan-Godfrey test istatistiklerine ait sıfır hipotezleri sırasıyla otokorelasyon ve değişen varyans sorunu yoktur; Jarque-Bera testi sıfır hipotezi normal dağılıma sahiptir şeklinde kurulmaktadır. Tanısal testlere ait hesaplanan t istatistiğine ait olasılık değerinin 0.10’dan büyük olması durumunda sıfır hipotezi reddedilememektedir. Diğer bir ifadeyle otokorelasyon ve değişen varyans sorunu olmadığı ve normal dağılıma sahip olduğu tespit edilmektedir.

Tablo: 10
Toplam Nakdî Yardımlara İlişkin ARDL Modeli Tahmin Sonuçları

GINI=f(TNY)				
ARDL(1,0)				
Değişkenler	Katsayı	Standart Hata	t İstatistiği	P Değeri
GINI(-1)	0,84	0,03	23,96	0,00
TNY	-0,09	0,01	-5,53	0,00
C	6,73	1,56	4,29	0,00
Diagnostik(Tanısıl) Testler				
LM(F istatistikleri)				0,84[0,44]
BPG(F istatistikleri)				0,19[0,82]
JB				1,49[0,47]

Not: LM: Breusch-Godfrey LM Otokorelasyon, BPG: Breusch- Pagan-Godfrey Değişen varyans, JB: Jarque-Bera Normallik testlerini ifade etmektedir. Köşeli parantez içindeki değerler ilgili istatistiğin olasılık değerini ifade etmektedir Modeldeki bağımsız değişkenlere ait katsayılar tabloda verilmiştir.

Tablo 10'da görüldüğü üzere, ARDL modelinde, otokorelasyon ve değişen varyans sorunlarının olmadığı, normal dağılıma sahip olduğu görülmektedir. Tahmin edilen denklemde tanısıl (diagnostik) açıdan bir problem olmadığı sonucuna ulaşılmıştır. ARDL modelinden hareketle hesaplanan uzun dönem katsayıları Tablo 11'de yer almaktadır.

Tablo: 11
Toplam Nakdî Yardımlara İlişkin Uzun Dönem Katsayıları

GINI=f(TNY)				
ARDL(1,0)				
Değişkenler	Katsayı	Standart Hata	t İstatistiği	P Değeri
TNY	-0,63	0,06	-9,19	0,00
C	44,65	0,30	144,18	0,00

Tablo 11'de görüldüğü üzere, TNY değişkenine ait uzun dönem katsayısı negatif ve istatistiksel olarak anlamlıdır. Uzun dönemde toplam nakdî yardımlar, GINI değişkenini negatif etkilemektedir. Tablo 11'deki bulgulara göre; toplam nakdî yardımlardaki %1'lik artış gelir dağılımı eşitsizliğini %0,63 azaltmaktadır. Tablo 12'de Toplam Nakdî Yardımlara İlişkin Hata Düzeltme Modeline yer verilmiştir.

Tablo: 12
Toplam Nakdî Yardımlara İlişkin Hata Düzeltme Modeli

GINI=f(TNY)				
ARDL(1,0)				
Değişkenler	Katsayı	Standart Hata	t İstatistiği	P Değeri
$\Delta(TNY)$	-0,09	0,01	-5,53	0,00
ECT(-1)	-0,15	0,02	-7,47	0,00

Not: ECT(-1): Hata düzeltme katsayısını temsil etmektedir. Modeldeki bağımsız değişkene ait katsayı tabloda verilmiştir. Literatürde (Esen vd., 2012: 262), (Özçağ, 2015: 16), (Tandoğan & Genç, 2020: 642) çalışmalarında referans alınarak tahmin edilen ARDL (1,0) modelinden elde edilen kısa dönem katsayılar kısa dönem ilişki yorumu için hata düzeltme modelinde verilmiştir.

Tablo 12'de, TNY değişkenine ait kısa dönem katsayısının negatif ve istatistiksel olarak anlamlı olduğu görülmektedir. Tablo 23'teki bulgulara göre, kısa dönemde toplam nakdî yardımlardaki %1'lik artış gelir dağılımı eşitsizliğini %0,09 azaltmaktadır. ECT(-1) katsayısının -0.15 (negatif ve istatistiksel olarak anlamlı) olduğu görülmektedir. Kısa dönemde meydana gelecek sapmaların sonraki dönemlerde giderileceği sonucuna ulaşılmıştır. Bu sonuç, kısa dönemde meydana gelecek sapmanın %15'i bir sonraki dönemde

düzelecektir şeklinde ifade edilebilir. Toplam Aynî Yardımlara ilişkin tahmin edilen ARDL modeli sonuçları Tablo 13'te yer almaktadır.

Tablo: 13
Toplam Aynî Yardımlara İlişkin ARDL Modeli Tahmin Sonuçları

GINI=f(TAY)				
ARDL(1,0)				
Değişkenler	Katsayı	Standart Hata	t İstatistiği	P Değeri
GINI(-1)	0,92	0,02	39,17	0,00
TAY	-0,16	0,02	-5,60	0,00
C	3,54	1,06	3,33	0,00
Diagnostik(Tamsal) Testler				
LM(F istatistikleri)			0,94[0,40]	
BPG(F istatistikleri)			0,49[0,61]	
JB			0,85[0,65]	

Not: LM: Breusch-Godfrey LM Otokorelasyon, BPG: Breusch- Pagan-Godfrey Değişen varyans, JB: Jarque-Bera Normallik testlerini ifade etmektedir. Köşeli parantez içindeki değerler ilgili istatistiğin olasılık değerini ifade etmektedir Modeldeki bağımsız değişkenlere ait katsayılar tabloda verilmiştir.

Tablo 13'te görüldüğü üzere, ARDL modelinde, otokorelasyon ve değişen varyans sorunlarının olmadığı, normal dağılıma sahip olduğu görülmektedir. Tahmin edilen denklemde tanısal (diagnostik) açıdan bir problem olmadığı sonucuna ulaşılmıştır. ARDL modelinden hareketle hesaplanan uzun dönem katsayıları Tablo 14'te yer almaktadır.

Tablo: 14
Toplam Aynî Yardımlara İlişkin Uzun Dönem Katsayıları

GINI=f(TAY)				
ARDL(1,0)				
Değişkenler	Katsayı	Standart Hata	t İstatistiği	P Değeri
TAY	-2,15	0,47	-4,56	0,00
C	47,61	1,22	39,00	0,00

Tablo 14'te görüldüğü üzere, TAY değişkenine ait uzun dönem katsayısı negatif ve istatistiksel olarak anlamlıdır. Uzun dönemde toplam aynî yardımlar, GINI değişkenini negatif etkilemektedir. Tablo 14'teki bulgulara göre; toplam aynî yardımlardaki %1'lik artış gelir dağılımı eşitsizliğini %2,15 azaltmaktadır. ARDL (1,0) modelinden elde edilen hata düzeltme sonuçları Tablo 15'te yer almaktadır.

Tablo: 15
Toplam Aynî Yardımlara İlişkin Hata Düzeltme Modeli

GINI=f(TAY)				
ARDL(1,0)				
Değişkenler	Katsayı	Standart Hata	t İstatistiği	P Değeri
$\Delta(TAY)$	-0,16	0,02	-5,60	0,00
ECT(-1)	-0,07	0,00	-7,55	0,00

Not: ECT(-1): Hata düzeltme katsayısını temsil etmektedir. Modeldeki bağımsız değişkene ait katsayı tabloda verilmiştir. Literatürde (Esen vd., 2012: 262), (Özçağ, 2015: 16), (Tandoğan & Genç, 2020: 642) çalışmalarında referans alınarak tahmin edilen ARDL (1,0) modelinden elde edilen kısa dönem katsayılar kısa dönem ilişkisi yorumu için hata düzeltme modelinde verilmiştir.

Tablo 15'te, TAY değişkenine ait kısa dönem katsayısının negatif ve istatistiksel olarak anlamlı olduğu görülmektedir. Tablo 26'daki bulgulara göre, kısa dönemde toplam aynî yardımlardaki %1'lik artış gelir dağılımı eşitsizliğini %0,16 azaltmaktadır. ECT(-1) katsayısının -0,07, negatif ve istatistiksel olarak anlamlı olduğu görülmektedir. Kısa

dönemde meydana gelecek sapmaların sonraki dönemlerde giderileceği sonucuna ulaşılmıştır. Bu sonuç, kısa dönemde meydana gelecek sapmanın %7'si bir sonraki dönemde düzeyecektir şeklinde ifade edilebilir. Toplam Sosyal Koruma Harcamalarının alt bileşenlerine ilişkin tahmin edilen ARDL modeli sonuçları Tablo 16'da yer almaktadır.

Tablo: 16
Sosyal Koruma Harcamalarının Alt Bileşenlerine İlişkin ARDL Modeli Tahmin Sonuçları

GINI=f(AİY, İŞY, SGY, YDY, MAL)				
ARDL(4, 3, 2, 3, 2, 3) Modeli				
Değişkenler	Katsayı	Standart Hata	t İstatistiği	P Değeri
GINI(-1)	1.50	0.51	2.90	0.03
GINI(-2)	-0.37	0.49	-0.74	0.48
GINI(-3)	-0.95	0.47	-2.02	0.09
GINI(-4)	-0.20	0.18	-1.11	0.31
AİY	-0.38	0.27	-1.39	0.22
AİY(-1)	0.40	0.24	1.66	0.15
AİY(-2)	-0.56	0.39	-1.43	0.21
AİY(-3)	-0.34	0.15	-2.26	0.07
İŞY	-0.38	0.39	-0.96	0.37
İŞY(-1)	-1.23	0.38	-3.19	0.02
İŞY(-2)	0.69	0.59	1.16	0.29
SGY	-0.00	0.17	-0.00	0.99
SGY(-1)	0.64	0.21	2.91	0.03
SGY(-2)	-0.49	0.28	-1.72	0.14
SGY(-3)	0.50	0.31	1.61	0.16
YDY	-0.12	0.10	-1.25	0.26
YDY(-1)	-0.28	0.11	-2.50	0.05
YDY(-2)	-0.09	0.05	-1.57	0.17
MAL	-3.06	2.11	-1.45	0.20
MAL(-1)	-2.08	0.90	-2.31	0.06
MAL(-2)	1.77	1.167	1.52	0.18
MAL(-3)	-2.50	1.83	-1.36	0.22
C	46.01	15.71	2.92	0.03
Diagnostik(Tansal) Testler				
LM(F istatistikleri)			1,45 [0,36]	
BPG(F istatistikleri)			1,09 [0,50]	
JB			0,29 [0,86]	

Tablo 16'da görüldüğü üzere ARDL (4,3,2,3,2,3) modeli, uygun model olarak tahmin edilmiştir. Tahmin edilen denklemde tanısal (diagnostik) açıdan bir problem olmadığı sonucuna ulaşılmıştır. Breusch-Godfrey LM otokorelasyon, Breusch-Pagan-Godfrey değişen varyans ve Jarque-Bera normallik testleri istatistikleri için sıfır hipotezi reddedilememektedir. ARDL(4, 3, 2, 3, 2, 3) modeline ait uzun dönem katsayıları Tablo 17'de yer almaktadır.

Tablo: 17
Sosyal Koruma Harcamalarının Alt Bileşenlerine İlişkin Uzun Dönem Katsayıları

GINI=f(AİY, İŞY, SGY, YDY, MAL)				
ARDL(4, 3, 2, 3, 2, 3)				
Değişkenler	Katsayı	Standart Hata	t İstatistiği	P Değeri
AİY	-0.86	0.54	-1.59	0.17
İŞY	-0.89	0.38	-2.34	0.06
SGY	0.63	0.23	2.76	0.03
YDY	-0.49	0.04	-10.50	0.00
MAL	-5.70	1.06	-5.36	0.00
C	44,61	0,57	77,44	0,00

Tablo 17’de görüldüğü üzere, İŞY, YDY ve MAL bağımsız değişkenlerine ait uzun dönem katsayılar negatif, SGY değişkenine ait katsayı ise pozitifdir. Katsayılar istatistiksel olarak anlamlıdır. AİY değişkenine ait uzun dönem katsayısı negatif ve anlamsızdır.

Diğer bir ifadeyle aile, işsizlik, yaşlı/dul/yetim ve malullük yardımları uzun dönemde GINI değişkenini negatif etkilemektedir. Tablo 17’deki bulgulara göre; işsizlik, yaşlı/dul/yetim ve malullük yardımlardaki %1’lik artışlar gelir dağılımı eşitsizliğini sırasıyla %0,89, %0,49 ve %5,70 azaltmaktadır. Sağlık yardımları ise GINI değişkenini pozitif etkilemektedir. Sağlık yardımlarındaki %1’lik artış gelir dağılımı eşitsizliğini %0,63 oranında artıracığı şeklinde yorumlanabilir. Aile yardımlarına ait uzun dönem katsayısı anlamsız çıktığı için yorumlanmamıştır. ARDL (4,3,2,3,2,3) modelinden elde edilen hata düzeltme sonuçları Tablo 18’de yer almaktadır.

Tablo: 18
Sosyal Koruma Harcamalarının Alt Bileşenlerine İlişkin Hata Düzeltme Modeli

GINI=f(AİY, İŞY, SGY, YDY, MAL)				
ARDL(4, 3, 2, 3, 2, 3)				
Değişkenler	Katsayı	Standart Hata	t İstatistiği	P Değeri
Δ (GINI(-1))	1,53	0,11	13,85	0,00
Δ (GINI(-2))	1,16	0,13	8,45	0,00
Δ (GINI(-3))	0,20	0,08	2,49	0,05
Δ (AİY)	-0,39	0,09	-4,14	0,00
Δ (AİY(-1))	0,90	0,09	9,72	0,00
Δ (AİY(-2))	0,34	0,05	6,06	0,00
Δ (İŞY)	-0,38	0,13	-2,91	0,03
Δ (İŞY(-1))	-0,69	0,11	-5,97	0,00
Δ (SGY)	-0,00	0,04	-0,01	0,99
Δ (SGY(-1))	-0,01	0,05	-0,29	0,77
Δ (SGY(-2))	-0,50	0,04	-11,23	0,00
Δ (YDY)	-0,12	0,03	-4,05	0,00
Δ (YDY(-1))	0,09	0,02	3,92	0,01
Δ (MAL)	-3,06	0,40	-7,58	0,00
Δ (MAL(-1))	0,73	0,32	2,23	0,07
Δ (MAL(-2))	2,50	0,34	7,26	0,00
ECT(-1)	-1,03	0,10	-10,13	0,00

Not: ECT(-1): Hata düzeltme katsayısını temsil etmektedir.

Tablo 18’de, İŞY, YDY ve MAL değişkenlerine ait katsayıların uzun dönemde olduğu gibi kısa dönemde de negatif ve istatistiksel olarak anlamlı olduğu tespit edilmiştir. İşsizlik, yaşlı/dul/yetim ve malullük yardımlarının gerek uzun dönemde gerekse kısa dönemde gelir dağılımı eşitsizliğini azalttığı tespit edilmiştir. Bulgulara göre; işsizlik, yaşlı/dul/yetim ve malullük yardımlardaki %1’lik artış gelir dağılımı adaletsizliğini sırasıyla %0,38, %0,12 ve %3,06 oranında azaltmaktadır. AİY değişkenine ait uzun dönem katsayısı negatif anlamsız iken kısa dönem katsayısının negatif ve anlamlı olduğu tespit edilmiştir. Bulgulara göre; aile yardımlardaki %1’lik artış gelir dağılımı eşitsizliğini %0,39 oranında azaltmaktadır. SGY değişkenine ait katsayı kısa dönemde anlamsız olduğu için yorumlanmamıştır.

Tablo 18’de, ECT(-1) katsayısının -1.03 olduğu (negatif ve istatistiksel olarak anlamlı) görülmektedir. Hata düzeltme katsayısının -1 ile -2 arasında değer alması kısa dönem dengeden sapma durumlarının azalan dalgalanmalarla dengeye geldiği şeklinde ifade

edilmektedir (Narayan & Smyth, 2006: 339; Alam & Quazi, 2003: 99). ECT(-1) katsayısının -1.03 olması; kısa dönemde meydana gelecek sapmanın azalan dalgalanmalar göstererek dengeye ulaştığı şeklinde yorumlanabilir.

Grafik 2'de ARDL modellerine ($GINI=f(TSY)$, $GINI=f(TAY)$, $GINI=f(TNY)$, $GINI=f(AIY, İŞY, SGY, YDY, MAL)$) ait Brown vd. (1975) tarafından geliştirilen Cusum ve Cusum-Sq grafikleri gösterilmiştir.

Grafik: 2
ARDL Modellerine ait Cusum-Cusum Sq Grafikleri

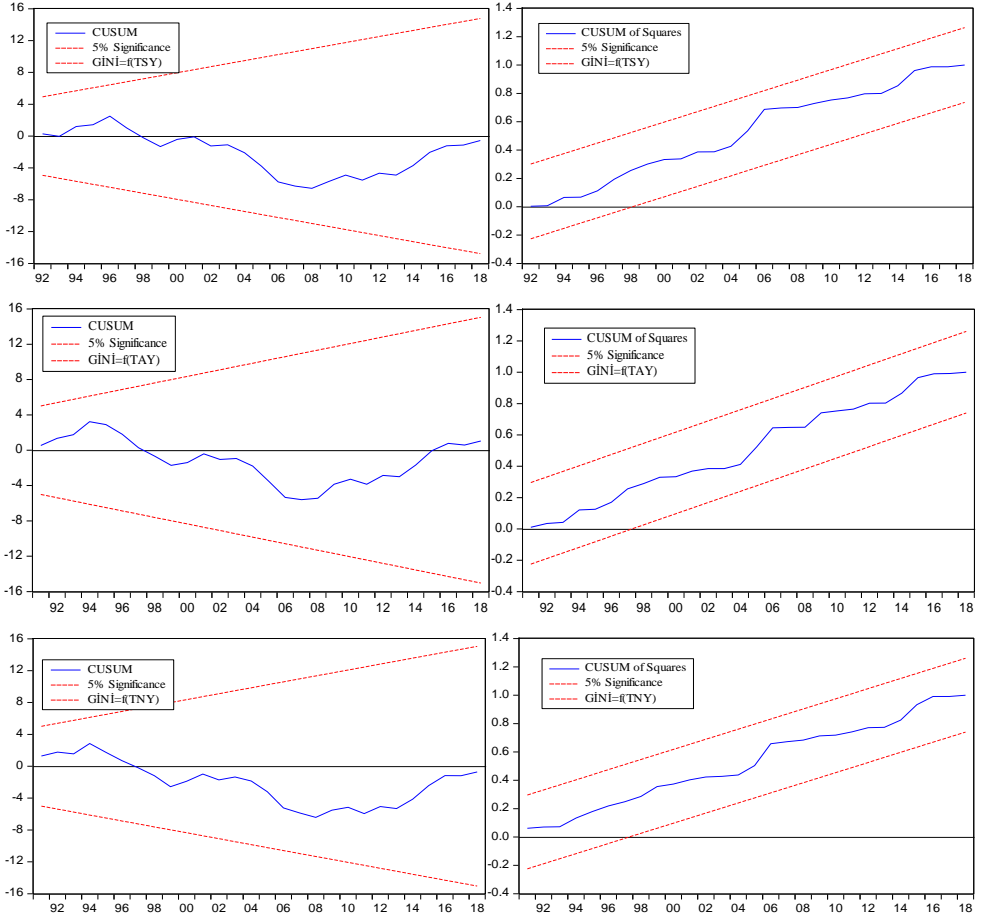

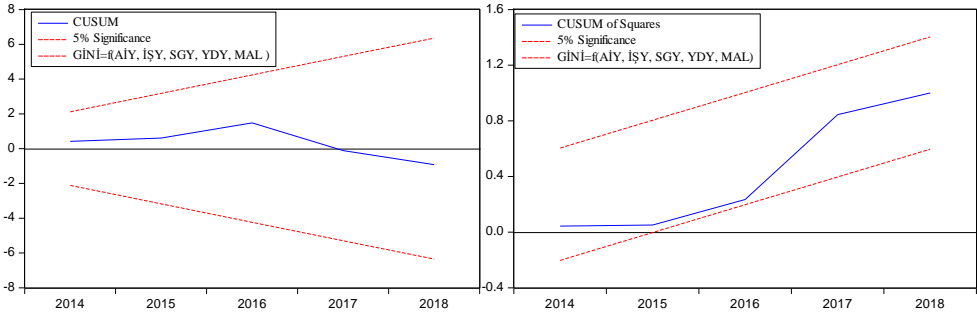

Grafik 2’de yer alan grafiklerde eğrilerin %5 güven aralıklarının dışına taşmadığı görülmektedir. Buna göre tahmin edilen ARDL modellerinde yer alan katsayıların istikrarlı olduğu ve herhangi bir yapısal kırılmanın olmadığı sonucuna ulaşılmıştır.

Tanısal (diagnostik) açıdan özetlenecek olursa; çalışmada tahmin edilen ARDL modellerinde değişen varyans, otokorelasyon ve yapısal istikrarsızlık problemlerinin olmadığı sonucuna ulaşılmıştır. Tahmin edilen ARDL modellerinden elde edilen bulgular yorumlanabilir nitelikte olup, teorik beklentilere uygun çıkmıştır.

4. Sonuç ve Değerlendirme

Sosyal koruma harcamalarının gelir dağılımı eşitsizliğini azalttığı yönündeki düşünceler literatürde genel kabul görmektedir. Bu bağlamda, Türkiye’de yapılan sosyal koruma harcamalarının gelir dağılımı eşitsizliğini düzeltmede ne ölçüde başarılı olduğunu ortaya koymak çalışmanın amacını oluşturmaktadır. Bu doğrultuda, 1987-2018 döneminde Türkiye’de sosyal koruma harcamalarının gelir dağılımı eşitsizliği üzerindeki etkisini ARDL Sınır Testi kullanılarak test edilmiştir. Gerek ADF gerekse PP testi sonucuna göre, bütün değişkenlerin birinci farkında I(1) durağan olduğu tespit edilmiştir. Bu bağlamda, ADF ile PP testi sonuçları birbirini desteklemektedir. Elde edilen sonuçlar doğrultusunda, sosyal koruma harcamalarının gelir dağılımı üzerindeki etkisini araştırmak için değişkenler arasındaki kısa ve uzun dönem ilişkiler hakkında bilgi veren ARDL yöntemi tercih edilmiştir.

Analizde öncelikle eşbütünleşme ilişkisi araştırılmış ve değişkenler arasında eşbütünleşme ilişkisinin olduğu tespit edilmiştir. Bu aşamadan sonra, AIC bilgi kriterine göre kısa ve uzun dönem ilişkilerini analiz etmek için en uygun ARDL modelleri tahmin edilmiştir. Analiz sonucunda değişkenlere ilişkin uzun ve kısa dönemde elde edilen bulgular aşağıda açıklanmıştır:

- Toplam sosyal yardımlara ait uzun dönem katsayılar negatif ve istatistiksel olarak anlamlıdır. Bu sonuca göre, uzun dönemde, toplam sosyal yardımlar Gini katsayısını negatif yönde etkilemektedir. Toplam sosyal yardımlardaki %1’lik artış, gelir dağılımı eşitsizliğini %0.46 azaltmaktadır. Toplam sosyal yardımlara

- ait kısa dönem katsayılar negatif fakat istatistiksel olarak anlamsızdır. Bu sonuca göre, toplam sosyal yardımlara yönelik kısa dönem için yorum yapılamamaktadır.
- Toplam aynı yardımlara ait uzun ve kısa dönem katsayıları negatif ve istatistiksel olarak anlamlıdır. Bu sonuca göre, uzun ve kısa dönemde, toplam aynı yardımlar Gini katsayısını negatif yönde etkilemektedir. Toplam aynı yardımlardaki %1'lik artış, gelir dağılımı eşitsizliğini uzun dönemde %2,15, kısa dönemde ise, %0,16 azaltmaktadır.
 - Toplam nakdî yardımlara ait uzun ve kısa dönem katsayıları negatif ve istatistiksel olarak anlamlıdır. Bu sonuca göre, uzun ve kısa dönemde, toplam nakdî yardımlar Gini katsayısını negatif yönde etkilemektedir. Toplam aynı yardımlardaki %1'lik artış, gelir dağılımı eşitsizliğini uzun dönemde %0,63, kısa dönemde ise, %0,09 azaltmaktadır.
 - Aile yardımlarına ait uzun dönem katsayısı istatistiksel olarak anlamsız çıktığı için yorumlanmamıştır. Bununla birlikte, AİY değişkenine ait kısa dönem katsayısının negatif ve anlamlı olduğu tespit edilmiştir. Bulgulara göre; kısa dönemde aile yardımlarındaki %1'lik artış gelir dağılımı eşitsizliğini %0,39 oranında azaltmaktadır.
 - Sağlık yardımlarına ait uzun dönem katsayısı pozitif ve istatistiksel olarak anlamlıdır. Elde edilen bu sonuç, sağlık yardımlarındaki %1'lik artışlar gelir dağılımı eşitsizliğini %0,63 oranında artıracak şekilde yorumlanabilir. Sağlık yardımlarına ilişkin kısa dönem katsayısı ise istatistiksel olarak anlamsız çıktığı için yorumlanmamıştır.
 - İşsizlik yardımlarına ait uzun dönem ve kısa dönem katsayıları negatif ve istatistiksel olarak anlamlıdır. Bu sonuca göre, işsizlik yardımlarının gerek uzun dönemde gerekse kısa dönemde Gini katsayısını negatif yönde etkilediği sonucu elde edilmiştir. Analiz sonucu elde edilen bulgulara göre, işsizlik yardımlarındaki %1'lik artışın, gelir dağılımı eşitsizliğini uzun dönemde %0,89, kısa dönemde ise, %0,38 oranında azalttığı sonucuna ulaşılmıştır.
 - Yaşlı/dul/yetim yardımlarına ait uzun dönem ve kısa dönem katsayıları negatif ve istatistiksel olarak anlamlıdır. Bu sonuca göre, yaşlı/dul/yetim yardımlarının gerek uzun dönemde gerekse kısa dönemde Gini katsayısını negatif yönde etkilediği sonucu elde edilmiştir. Analiz sonucu elde edilen bulgulara göre, yaşlı/dul/yetim yardımlarındaki %1'lik artışın, gelir dağılımı eşitsizliğini uzun dönemde %0,49, kısa dönemde ise, %0,12 oranında azalttığı sonucuna ulaşılmıştır.
 - Malullük yardımlarına ait uzun dönem ve kısa dönem katsayıları negatif ve istatistiksel olarak anlamlıdır. Bu sonuca göre, malullük yardımlarının gerek uzun dönemde gerekse kısa dönemde Gini katsayısını negatif yönde etkilediği sonucu elde edilmiştir. Analiz sonucu elde edilen bulgulara göre, malullük yardımlarındaki %1'lik artışın, gelir dağılımı eşitsizliğini uzun dönemde %5,70, kısa dönemde ise, %3,06 oranında azalttığı sonucuna ulaşılmıştır.

Tanısal testlerden elde edilen bulgulara göre, ARDL modellerinde otokorelasyon ve değişen varyans sorunlarının olmadığı, normal dağılıma sahip oldukları görülmektedir.

Breusch-Godfrey LM, Breusch-Pagan-Godfrey ve Jarque-Bera test istatistikleri için sıfır hipotezi reddedilememektedir. Dolayısıyla, tahmin edilen denklemde tanısal (diagnostik) açıdan bir problem olmadığı sonucuna ulaşılmıştır. Diğer taraftan, ARDL modellerine ilişkin Cusum ve Cusum Sq grafiklerinde yapısal bir kırılma görülmemiştir.

Analizden elde edilen bulgular neticesinde çalışmada araştırılan hipotezlerin sağlık yardımları haricinde kabul edildiği ve sonuçların literatür ile uyumlu olduğunu söylemek mümkündür. Buna göre, analiz sonucunda elde edilen bulgular neticesinde 1980-2018 dönemi için Türkiye’de sosyal koruma harcamalarının gelir dağılımı eşitsizliğini azalttığı çalışmada ortaya koyulmuştur.

Kaynaklar

- Ait Mansour, H. (2016), *Accessibility of Vulnerable Groups to Social Protection Programmes in the OIC Member Countries*, Standing Committee for Economic and Commercial Cooperation of the Organization of Islamic Cooperation (COMCEC), Ankara.
- Alam, I. & R.M. Quazi (2003), "Determinants of Capital Flight: An Econometric Case Study of Bangladesh", *International Review of Applied Economics*, 17(1), 85-103.
- Altunöz, U. & F. Çondur (2018), "Sosyal Güvenlik Harcamaları Gelir Dağılımında Etkin mi? Türkiye Ekonomisi için Nedensellik Analizi", *Uluslararası Yönetim İktisat ve İşletme Dergisi*, CEEİK 2018 Özel Sayısı, 173-189.
- Baylan, M. (2015), "Sosyal Güvenlik Harcamalarının Makroekonomik Etkileri: Bir Literatür Taraması", *Kahramanmaraş Sütçü İmam Üniversitesi Sosyal Bilimler Dergisi*, 12(1), 29-52.
- Baylan, M. (2019), "Impact of Social Security Expenditures on Income Distribution: Case of Turkey", *Manas Sosyal Araştırmalar Dergisi*, 8(3), 2579-2593.
- Cammeraat, E. (2020), "The Relationship Between Different Social Expenditure Schemes and Poverty, Inequality and Economic Growth", *International Social Security Review*, 73(2), 101-123.
- d'Agostino, G. et al. (2018), "Further Evidence of the Relationship Between Social Transfers and Income Inequality in OECD Countries", *ECINEQ WP Series*, 2018-482.
- Dayar, H. & A. Akıncı (2020), "Kamu Sosyal Transfer Harcamalarının Kişisel Gelir Dağılımına Etkisi", *Maliye Dergisi*, 179, 172-185.
- Demiryürek-Ürper, T. (2018), "Kamu Harcamalarının Gelir Dağılımı Üzerindeki Etkisi: Türkiye Örneği", *Yüksek Lisans Tezi*, Hacettepe Üniversitesi, Sosyal Bilimler Enstitüsü, Maliye Anabilim Dalı.
- Erçakar, M.E. & H. Güvenoğlu (2018), "Türkiye’de Gelir Dağılımı ve Sosyal Koruma Harcamalarına Bir Bakış", *NKÜ Sosyal Bilimler Metinleri*, 2018/1, 38-53.
- Esen, E. vd. (2012), "Feldstein-Horioka Hipotezinin Türkiye Ekonomisi İçin Sınanması: ARDL Modeli Uygulaması", *Eskişehir Osmangazi Üniversitesi İktisadi ve İdari Bilimler Dergisi*, 7(1), 251-267.

- Holmes, R. & C. Lwanga-Ntale (2012), “Social Protection in Africa: A Review of Social Protection Issues in Research”, Partnership for African Social and Governance Research (PASGR) *Scoping Study*, <http://www.pasgr.org/wp-content/uploads/2017/01/Social-protection-in-Africa_A-review-of-social-protection-issues-in-research.pdf>, 08.12.2023.
- İlgün, M.F. (2015), “Kamu Sosyal Harcamalarının Gelir Dağılımı Üzerindeki Etkisi: OECD Ülkelerine Yönelik Panel Veri Analizi”, *Dokuz Eylül Üniversitesi Sosyal Bilimler Enstitüsü Dergisi*, 17(4), 493-516.
- İnam, B. (2019), “Sosyal Harcamaların Gelir Dağılımı Üzerindeki Etkisi: Türkiye Örneği”, Doktora Tezi, Bursa Uludağ Üniversitesi, Sosyal Bilimler Enstitüsü.
- Kalkavan, H. & İ. Ersin (2020), “Sosyal Harcamalar ile Gelir Dağılımı Arasındaki İlişkinin İncelenmesi: OECD Üzerine Bir Uygulama”, *Sosyal Güvençe Dergisi*, (17), 265-282.
- Kozuharov, S. & V. Petkovski (2018), “The Impact of Social Transfers on Inequality Measured by Gini Index: The Example of Macedonia”, *UTMS Journal of Economics*, 9(1), 49-61.
- Luebker, M. (2011), “The Impact of Taxes and Transfers on Inequality”, International Labour Office, *Travail Policy Brief*, No: 4, <https://www.ilo.org/travail/info/publications/WCMS_160436/lang--en/index.htm>, 24.03.2023.
- MacKinnon, J.G. (1996), “Numerical Distribution Functions for Unit Root and Cointegration Tests”, *Journal of Applied Econometrics*, 11(6), 601-618.
- Mahmud F.E. & J. Sharpe (2021), *Social Protection's Contribution to Social Cohesion*, Canberra: Commonwealth of Australia, Department of Foreign Affairs and Trade.
- Narayan, P.K. & R. Smyth (2006), “What Determines Migration Flows from Low-income to High-Income Countries? An Empirical Investigation of Fiji-US Migration 1972-2001”, *Contemporary Economic Policy*, 24(2), 332-342.
- Narayan, P.K. (2005), “The Saving and Investment Nexus for China: Evidence from Cointegration Tests”, *Applied Economics*, 37(17), 1979-1990.
- OECD, (2019), *Can Social Protection Be an Engine for Inclusive Growth?*, Development Centre Studies, OECD Publishing, Paris.
- Osabohien, R. et al. (2020), “Population-Poverty-Inequality Nexus and Social Protection in Africa”, *Social Indicators Research*, 151, 575-598.
- Özçağ, M. (2015), “Türkiye’de Enerji Tüketimi, Ekonomik Büyüme ve Dışa Açıklık İlişkisi: ARDL Modeli”, *Finans Politik ve Ekonomik Yorumlar*, 605, 7-17.
- Pesaran, M.H. et al. (2001), “Bounds Testing Approaches to the Analysis of Level Relationships”, *Journal of Applied Econometrics*, 16, 289-326.
- Phillips, P.C.B. & P. Perron (1988), “Testing For A Unit Root in Time Series Regression”, *Biometrika*, 75(2), 335-346.
- Polat, M.A. (2020), “Sosyal Amaçlı Transfer Harcamalarının Gelir Dağılımına Etkisi: OECD Ülkelerine Yönelik Panel Veri Analizi”, *BMIJ*, 8(4), 764-796.
- Sanchez, A. & A.L. Perez-Corral (2018), “Government Social Expenditure and Income Inequalities in the European Union”, *Hacienda Pública Española/Review of Public Economics*, 227(4), 133-156.

- Sinram, S. (2019), *Opening the Black-Box of Cabinet-Level Politics*, <<https://books.google.com.tr/books?id=u42sDwAAQBAJ&printsec=frontcover&dq=inauthor:%22Sarah+Sinram%22&hl=tr&sa=X&ved=0ahUKewjqopSfq7roAhUqyaYKHacLADoQuwUILjAA#v=onepage&q&f=false>>, 08.12.2023.
- Tandoğan, D. & M.C. Genç (2020), "Türkiye'de Demokrasinin Doğrudan Yabancı Yatırımlar Üzerindeki Etkisi: ARDL Yaklaşımı", *Business and Economics Research Journal*, 11(3), 635-646.
- Ulu, M.İ. (2018), "The Effect of Government Social Spending on Income Inequality in OECD: A Panel Data Analysis", *International Journal of Economics Politics Humanities and Social Sciences*, 1(3), 184-202.
- United Nations (2018), "Promoting Inclusion Through Social Protection", *Report on the World Social Situation 2018*, <<https://www.un.org/development/desa/dspd/wp-content/uploads/sites/22/2018/06/rwss2018-full-advanced-copy.pdf>>, 24.03.2023.

Türkiye İçin Ekonomik Yapısal Reform Ölçüm Yöntemlerinin Geliştirilmesi ve Büyüme Üzerindeki Etkilerinin İncelenmesi¹

Ömer YALÇINKAYA (<https://orcid.org/0000-0002-1210-2405>), Atatürk University, Türkiye; oyalcinkaya@atauni.edu.tr

Vedat KAYA (<https://orcid.org/0000-0002-7206-4236>), Atatürk University, Türkiye; vkaya@atauni.edu.tr

Gökhan ERKAL (<https://orcid.org/0000-0002-5007-5065>), Atatürk University, Türkiye; gerkal@atauni.edu.tr

Development of Economic Structural Reform Measurement Methods for Türkiye and Examining the Effects on Growth²

Abstract

This study aims to define the economic structural reforms for Türkiye accompanied by the IMF-MONA program classifications, to measure them from the Official Gazette archive of the Presidency of the Republic of Türkiye in the period 1990-2021 and to examine their effects on economic growth with the BF-ARDL model. As a result of analysing the econometric models based on the expansion of the Cobb-Douglas production function in the study, it has been determined that the reforms carried out have positive/meaningful effects on Türkiye's growth in the financial, fiscal and real sectors and positive/meaningless in the trade sector. These results show that the reforms carried out in Türkiye support growth and indicate that it has a significant potential to be sustained and strengthened.

Keywords : IMF-MONA, Structural Reforms, Growth, BF-ARDL, Türkiye.

JEL Classification Codes : C13, F41, O11.

Öz

Bu çalışmada, IMF-MONA (Monitoring of Fund Arrangements) programı sınıflandırmaları eşliğinde ekonomik yapısal reformların Türkiye için tanımlanması, 1990-2021 döneminde Türkiye Cumhuriyeti Cumhurbaşkanlığı Resmî Gazete arşivinden ölçülmesi ve ekonomik büyüme üzerindeki etkilerinin BF-ARDL modeliyle incelenmesi amaçlanmıştır. Çalışmada Cobb-Douglas üretim fonksiyonunun genişletilmesine dayanan ekonometrik modellerin çözülmesi sonucunda, gerçekleştirilen reformların Türkiye'nin büyümesi üzerinde finansal, mali ve reel sektörlerde pozitif/anlamlı ve ticari sektörde ise pozitif/anlamsız etkilere sahip olduğu belirlenmiştir. Bu sonuçlar, inceleme döneminde Türkiye'de gerçekleştirilen reformların büyümeyi desteklediğini göstermekte ve güçlendirilerek sürdürülebilmesinde önemli bir potansiyele sahip olduğuna işaret etmektedir.

Anahtar Sözcükler : IMF-MONA, Yapısal Reformlar, Büyüme, BF-ARDL, Türkiye.

¹ Bu çalışma, Türkiye Bilimsel ve Teknolojik Araştırma Kurumu (TÜBİTAK) tarafından 121K526 nolu proje kapsamında desteklenmektedir.

² The Scientific and Technological Research Council of Türkiye (TÜBİTAK) supports this article as its 121K526 Project Nr.

1. Giriş

2008 küresel ekonomik krizi (KE) ve devamındaki büyük durgunluk döneminden itibaren ekonominin ana gündeminde, gelişmiş (G) ve gelişmekte olan (GO) ülkelerin krizden çıkış ve yeniden dengelenme için uyguladıkları iktisat politikaları ile etkinliği önemli bir yer tutmaktadır (IMF, 2020: 13-14). G ve GO hiçbir ülkenin uzun vadede dengeli ve sürdürülebilir büyüme hızlarını yakalayamadığı konjonktürde, küresel ekonomideki düşük büyüme ortamı giderek belirginleşmekte ve geciken toparlanmalar durgunluk sorununu yapısal boyutlara taşımaktadır. Nitekim 2008 yılından itibaren sürekli potansiyelinin (%4,5) altında kalan ve 2020 yılında süreç içerisindeki en düşük (%-3.3) büyüme hızlarına tanıklık eden küresel ekonominin 2024 yılına kadar bu görünümünü sürdürmesi beklenmektedir (IMF, 2023: 1-2). Para politikalarının beklentilerle uyumsuzluğu, maliye politikalarının yüksek borç stoğu karşısındaki sığılı, Orta Doğu kaynaklı gerilimlerin etki alanını genişletmesi, korumacı ticaret politikalarının yeniden uygulama alanı bulması, Brexit ile birliklerin geleceğinin sorgulanması (Al-Thaqeb & Algharabali, 2019: 1-2), Covid-19 salgınının tedarik zinciri üzerindeki etkileri sürerken emtia-enerji fiyatlarındaki artışı körükleyen Rusya-Ukrayna savaşının patlak vermesi vb. süreç içerisindeki ekonomik ve politik gelişmeler bu durumun muhtemel bazı nedenleri arasında sayılmaktadır.

Küresel ölçekte belirsizlik meydana getiren bu türden gelişmeler, iktisadi dengelenmenin en önemli bileşeni olan güven ortamının yeniden sağlanmasını güçleştirmekte ve para-maliye uygulamalarından oluşan iktisat politikalarının etkinliğini sınırlandırmaktadır (Chinn et al., 2018: 209-210). KE sonrasındaki bu konjonktür, G ve GO ülkelerde sürdürülebilir büyüme hızlarının yakalanabilmesinde geleneksel politikalarla mümkün olan neredeyse her şeyin uygulandığı görüşünün kanıksanmasına (TCMB, 2016: 5) ve IMF (International Monetary Fund), WB (World Bank) şeklindeki kuruluşların ekonomik yapısal reformları (EYR) yeniden gündeme getirmelerine yol açmaktadır (IMF, 2015: 6). Uluslararası kuruluşlar tarafından EYR'lerin ekonomik sistemin arz-talep yapısından kaynaklı sorunları giderici ve çıktı açığını azaltıcı etkileri üzerinde durulmakta, G ve GO ülkelerde sürdürülebilir büyüme hızlarının yakalanabilmesinde belirleyici olduğu kabul edilmektedir (Swaroop, 2016: 1-3). Nitekim EYR'ler ekonomik sistemi oluşturan sektörlerin kurumsal yapısında ve piyasaların işleyişinde kapsamlı iyileştirmelerin yapılması amacıyla gerçekleştirilmekte ve etkilerini ekonominin arz-talep tarafını hedefleyen çeşitli aktarım kanalları üzerinden göstermektedir. EYR'ler arz tarafında, piyasalardaki kısıtlamaları azaltarak verimliliği (Anderson et al., 2014: 790) ve kaynakların tahsisinde etkinlik sağlayarak yatırımları artırırken (Ostry et al., 2009: 2), talep tarafında ise piyasalara güven veren politika taahhütleri ile tüketim, yatırım ve tasarruf kararlarını yönlendirmekte (Bouis et al., 2012: 5-8) ve ücret-fiyatlar üzerindeki kontrolleri esneterek piyasaların içsel-dışsal şoklar karşısındaki dayanıklılığını artırmaktadır (Fischer & Stiglitz, 2018: 137). Bu aktarım kanalları üzerinden EYR'ler, ekonomik sistemin arz yapısında verimliliği azaltan talep yapısında ise bekleyişleri bozan sorunları gidermekte ve çıktı açığının azaltılabilmesine olanak sağlamaktadır. Mevcut konjonktürde EYR'lerin etkilerine yönelik bu bakış açısı ise G ve GO ülkelerde sürdürülebilir büyüme hızlarının yakalanabilmesi

amacıyla politika yapıcılarını kapsamlı reform programları uygulamaya yönlendirmektedir (De Almeida & Balasundharam, 2018: 4-5).

KE sonrasındaki dönemde sürdürülebilir büyüme hızlarının yakalanabilmesinde EYR'lere yeniden atfedilen önem dikkate alınarak GO ülke konumundaki Türkiye üzerine yürütülen bu çalışmada, EYR'ler ve ekonomik büyüme üzerindeki etkileri inceleme konusu yapılmaktadır. Bu kapsamda çalışmada, literatürde EYR'lerin tanımlanma ve ölçümlenme konusundaki gelişimi gözetilerek IMF-MONA (Monitoring of Fund Arrangements) programı eşliğinde Türkiye için EYR'lerin tanımlanması, 1990-2021 döneminde Türkiye Cumhuriyeti Cumhurbaşkanlığı Resmî Gazete (TCRG) arşivinden ölçümlenmesi ve ekonomik büyüme üzerindeki etkilerinin BF-ARDL (Bootstrap Fourier Autoregressive Distributive Lag) modeliyle incelenmesi amaçlanmaktadır. Çalışmanın EYR'ler ve makro düzeyde ekonomik büyüme üzerindeki etkilerini konu edinen literatüre muhtemel katkıları şu üç başlıkta sıralanabilmektedir: İlk katkıyı literatürde EYR'leri temsil etme derecesindeki üstünlüğü gözetilerek (IMF-MONA programı ve veri tabanı referans alınarak) 1990-2021 döneminde TCRG arşivinden ve doğrudan gerçekleştirilen reform önerilerinin sayısal verileri üzerinden Türkiye için EYR göstergelerinin hesaplanması oluşturmaktadır. Böylece EYR'ler, literatürde metodolojisi yazarları veya uluslararası kuruluşlar tarafından geliştirilen ve halihazırda kullanılmakta olan diğer vekil göstergelere kıyasla doğrudan ölçümlenebilen daha kapsayıcı göstergelerle temsil edilebilmektedir. İkinci katkıyı, EYR'lerin para, sermaye, mal ve emek şeklindeki tüm piyasaları kapsayacak şekilde finansal, mali, reel ve ticari sektör reformları başlıklarında ayrı ayrı hesaplanması oluşturmaktadır. Böylece kapsadıkları piyasalara göre gruplandırılan EYR'lerin Türkiye'nin ekonomik büyümesi üzerindeki etkileri sektör temelinde ve karşılaştırmalı bir bakış açısıyla incelenebilmektedir. Üçüncü katkıyı, literatürde EYR'lerin ekonomik büyüme üzerindeki etkilerini genellikle panel veri analizi kapsamında doğrusal modellerle araştıran çalışmalardan farklı olarak zaman serisi analizi kapsamında doğrusal ve doğrusal dışı dinamikleri gözetilen BF-ARDL modeliyle incelenmesi oluşturmaktadır. Böylece Cobb-Douglas (CD) üretim fonksiyonunun genişletilmesine dayanan ekonometrik modellerdeki değişkenlerin 1990-2021 dönemindeki zaman serisi özellikleri dikkate alınmakta ve EYR'lerin Türkiye'nin ekonomik büyümesi üzerindeki etkileri daha tutarlı bir şekilde belirlenebilmektedir.

Girişi izleyen ikinci bölümde, ilgili literatür özetlenerek çalışmanın konumu ortaya çıkarılmaktadır. Üçüncü bölümde EYR'lerin tanımlanıp ölçümlenmesine yönelik çalışma kapsamındaki metodoloji açıklanmaktadır. Dördüncü bölümde, çalışmanın verileri, modelleri ve ekonometrik metodolojisi tanıtılmaktadır. Beşinci bölümde ekonometrik modellerinin bulguları tartışılmaktadır. Çalışma bulgulara dayalı politika çıkarımları ile önerilerin bulunduğu sonuç bölümüyle tamamlanmaktadır.

2. Literatür Özeti

İlgili literatürde, KE sonrasında yeniden dünya ekonomisinin gündemine gelen EYR'leri konu edinen çalışmaların, dış borç yapısındaki ve ekonomik koşullardaki

bozulmaların giderilebilmesi amacıyla G ve GO ülkelerde reform programlarının önem ve yaygınlık kazanmaya başladığı 1990'lı yıllara dayandığı görülmektedir. Bu konudaki öncü çalışmalarda EYR'lerin tanımlanmasına ve mikro-makro düzeyde ilişkili olduğu değişkenler arasındaki etkileşim kanallarının teorik açıdan açıklanmasına odaklanılırken, ardıl çalışmalarda EYR'lerin ölçülmesine ve/ya mikro-makro düzeyde ilişkili olduğu değişkenler üzerindeki etkilerinin ampirik açıdan sınanmasına yoğunlaşılmaktadır (IMF, 2015: 14).

Literatür incelendiğinde, Easterly vd. (1996), Lora ve Barrera (1997), Lin ve Liu (2000) tarafından yapılan çalışmaların bu konudaki öncü çalışmalar arasında buldukları görülmektedir. Easterly vd. (1996) çalışmalarında gelişmiş ve gelişmekte olan 70 ülkede makroekonomik istikrar reformları (enflasyon oranı, kamu tüketim harcamalarının GSYH içerisindeki payı), finansal reformlar (geniş tanımlı para arzının GSYH içerisindeki payı), dış sektör reformları (ticaret hacminin GSYH içerisindeki payı, döviz işlemlerinin serbestleşme düzeyi) ve diğer reformlar (yatırım harcamalarının GSYH içerisindeki payı) başlıkları altındaki farklı nitelikteki göstergelerle temsil edilen EYR'lerin, makro düzeyde ekonomik büyüme üzerindeki etkilerini panel veri analiziyle incelemişlerdir. Yazarlar, doğrusal GMM (Generalized Method of Moments) modellerine dayalı analizlerinin sonucunda, ilgili ülkelerde finansal reformların, dış sektör reformlarının ve diğer reformların ekonomik büyüme üzerindeki etkilerinin pozitif olduğunu belirlerken, makroekonomik istikrar reformlarının ekonomik büyüme üzerindeki etkilerinin negatif olduğunu tespit etmişlerdir. Lora ve Barrera (1997) çalışmalarında 19 Latin Amerika ülkesinde ticaret, vergi, finans, özelleştirme ve işgücü reformları başlıkları altında piyasa aksaklıklarının derecesi üzerinden hesaplanan endeks biçimindeki göstergelerle temsil edilen EYR'lerin, makro düzeyde ekonomik büyüme üzerindeki etkilerini panel veri analiziyle incelemişlerdir. Yazarlar, doğrusal OLS (Ordinary Least Squares) modellerine dayalı analizlerinin sonucunda, ilgili ülkelerde ticaret, vergi, finans, özelleştirme ve işgücü reformlarının ekonomik büyüme üzerindeki etkilerinin pozitif olduğunu belirlemişlerdir. Lin ve Liu (2000) çalışmalarında Çin Halk Cumhuriyeti'nin 28 Bölgesinde mali yerelleştirme reformları (yerel bütçe gelirinin marjinal elde tutulma oranı) ve hanehalkı sorumluluk sistemi reformları (sisteme kayıtlı kırsal alanlardaki üretim ekiplerinin oranı) başlıkları altındaki farklı nitelikteki göstergelerle temsil edilen EYR'lerin, mikro düzeyde ekonomik büyüme üzerindeki etkilerini panel veri analiziyle incelemişlerdir. Yazarlar, doğrusal OLS modellerine dayalı analizlerinin sonucunda, ilgili bölgelerde reformların ekonomik büyüme üzerindeki etkilerinin pozitif olduğunu tespit etmişlerdir.

Yukarıdaki çalışmaların ardından oluşmaya başlayan ampirik literatür incelendiğinde, EYR'lerin mikro-makro düzeyde ilişkili olduğu değişkenler üzerindeki etkilerinin ampirik açıdan sınanan çok sayıda çalışmanın yapıldığı ve bu konudaki literatürün 2000'li yıllardan itibaren önemli bir gelişim gösterdiği görülmektedir. Bu çalışmaların sınırlı bir bölümünde Easterly vd. (1996) ve Lin ve Liu (2000) çalışmalarındaki gibi piyasaların ve/ya sektörlerin belirli boyutlarını kapsayan düzenlemelerin (değişkenlerin) basit değerleri üzerinden ölçülen EYR göstergeleri kullanılmaktadır (Escaith & Morley, 2000; Prati et al., 2013; Yu et al., 2014; Haan & Wiese, 2022). Bu çalışmaların ağırlıklı bir bölümünde ise

Lora ve Barrera (1997), çalışmalarındaki gibi piyasaların ve/ya sektörlerin belirli bir boyutunu kapsayan değişkenlerin bileşik değerleri üzerinden endeks biçiminde ölçümlenen (metodolojisi yazarları veya uluslararası kuruluşlar tarafından geliştirilen)³ EYR göstergeleri kullanılmaktadır (Abed & Davoodi, 2000; Greenaway et al., 2002; Correa, 2002; Staehr, 2003; Loayza et al., 2005; Falcetti et al., 2006; Ostry et al., 2009; Swiston & Barrot, 2011; Bouis et al., 2012; Campos & Horváth, 2012; Christiansen et al., 2013; Sertić et al., 2015; Marrazzo & Terzi, 2017; Brancaccio et al., 2018; Aksoy, 2019; Ostry et al., 2021).

Genellikle Latin/Orta Amerika, Batı/Doğu Avrupa, Geçiş Ekonomileri ve OECD ülkeleri şeklinde gruplandırılan G ve GO ülkeler üzerinde yapılan bu çalışmalarda, panel veri analizi başta olmak üzere zaman serisi analiz metodolojisine dayanan çeşitli doğrusal modeller kullanılmaktadır. Bu çalışmaların bazılarında EYR'lerin etkileri Lin ve Liu (2000) çalışmasında olduğu gibi mikro düzeyde (bölge, sektör ve firma) incelenirken, ağırlıklı bir bölümünde ise Easterly vd. (1996), Lora ve Barrera (1997) çalışmalarındaki gibi makro düzeyde (genel ekonomi) araştırılmaktadır. İlgili literatürde EYR'lerin mikro-makro düzeyde ilişkili olduğu çeşitli değişkenler üzerindeki etkileri inceleme konusu yapılmakla birlikte çalışmanın bu bölümünde, Easterly vd. (1996-1997), Lora ve Barrera (1997) çalışmalarındaki gibi EYR'lerin makro düzeyde ekonomik büyüme üzerindeki etkilerini konu edinen ampirik çalışmalara odaklanılmaktadır.

Bu kapsamdaki ampirik çalışmalar incelendiğinde, EYR'lerin makro düzeyde ekonomik büyüme üzerindeki etkilerini panel veri analiziyle araştıran ilk çalışmalardan birinin Escaith ve Morley (2000) tarafından yapıldığı görülmektedir. Escaith ve Morley (2000) 17 Latin Amerika ülkesinde finansal (borç alma ve borç verme oranları, banka rezervlerinin mevduatlara oranı), ticari (tarifelerin ortalama düzeyi ile dağılımı), vergilendirme (gelir ve kurumlar vergisi üzerindeki maksimum marjinal vergi oranları, katma değer vergisi oranları ile etkinliği), sermaye hesabı (yabancı yatırım üzerindeki kontrollerin genişliği, kâr ve faizlerin geri dönüşümü üzerindeki sınırlandırmalar, dış borçlanma ve sermaye çıkışları üzerindeki kontroller) ve özelleştirme (kamu iktisadi teşebbüsleri katma değerinin tarım dışı GSYH içerisindeki payı) şeklindeki farklı sektör ve/ya piyasaya ilişkin değişkenlerin basit ortalaması üzerinden endeks biçiminde hesaplanan EYR göstergesinin makro düzeyde ekonomik büyüme üzerindeki etkilerini incelemişlerdir. Yazarlar, doğrusal GLS (Generalized Least Squares) modellerine dayalı analizlerinin sonucunda, ilgili ülkelerde EYR'lerin ekonomik büyüme üzerinde pozitif bir etkiye sahip olduğunu belirlemişlerdir. EYR'lerin makro düzeyde ekonomik büyüme üzerindeki etkilerinin pozitif olduğu yönündeki bu sonuçlara, panel veri analizi kapsamında doğrusal

³ IMF, WB, OECD (Organisation for Economic Co-Operation and Development) ve EBRD (European Bank for Reconstruction and Development) tarafından geliştirilen bu EYR göstergeleri: IMF Serbestleştirme Endeksleri (Ekonomik, Ticari, Finansal, Sermaye, Ürün Piyasası), WB Serbestleştirme (İç ve Dış Piyasalar), Özelleştirme ve Düzenleme Endeksleri (Bankacılık, İşgücü Piyasası), OECD Denetleme (İstihdam) ve Düzenleme Endeksleri (Ürün Piyasası, Enerji, Ulaşım, İletişim) ve EBRD Serbestleştirme ve Özelleştirme Endeksleri şeklinde sıralanabilmektedir.

TOLS (Two Stage Least Square), PMG (Pooled Mean Group), VAR (Vector Autoregressive), OLS ve GMM modellerini kullanan diğer çalışmalarda ulaşımlardır (Abed & Davoodi, 2000 / OLS; Greenaway et al., 2002 / GMM; Staehr, 2003 / GMM; Falcetti et al., 2006 / OLS; Ostry et al., 2009 / OLS; Swiston & Barrot, 2011 / OLS; Bouis et al., 2012 / VAR; Campos & Horváth, 2012 / OLS; Prati et al., 2013 / OLS; Yu et al., 2014 / OLS; Sertić et al., 2015 / PMG; Marrazzo & Terzi, 2017 / OLS; Aksoy, 2019 / GMM; Ostry et al., 2021 / GMM).

Buna karşılık Correa (2002) 19 Latin Amerika ülkesinin ekonomi büyümesi üzerinde EYR'lerin etkilerini doğrusal GMM modelleriyle incelediği çalışmasında, finansal ve ticari serbestleşme, işgücü düzenlemeleri, özelleştirme ve vergi tarafsızlığı şeklindeki 5 farklı sektör ve/ya piyasaya ilişkin değişkenlerin basit ortalaması üzerinden endeks biçiminde hesaplanan EYR göstergesinin ilgili ülkelerin ekonomik büyümesi üzerinde negatif bir etkiye sahip olduğunu tespit etmiştir. Benzer sonuçlara finansal, ticari ve sermaye piyasalarına ilişkin serbestleştirme endeksleriyle temsil edilen EYR'lerin düşük, orta ve yüksek gelirli 90 ülkenin ekonomik büyümesi üzerindeki etkilerinin araştırıldığı Christiansen vd. (2013 / OLS) çalışmasında da ulaşılmıştır. Christiansen vd. (2013) çalışmalarında finansal piyasa EYR'lerinin ekonomik büyüme üzerindeki etkilerinin pozitif olduğunu belirlerken, ticari ve sermaye piyasası EYR'lerinin ekonomik büyüme üzerinde herhangi bir etkiye sahip olmadığını tespit etmişlerdir. EYR'lerin makro düzeyde ekonomik büyüme üzerindeki etkilerinin negatif veya anlamsız olduğu yönündeki bu sonuçlara, AIPW (Augmented Inverse Probability Weighted) ve OLS modellerini kullanan Loayza vd. (2005 / OLS), Brancaccio vd. (2018 / OLS) ve Haan ve Wiese (2022 / AIPW) çalışmalarında da ulaşılmıştır. Bu çalışmalarda, EYR'leri temsilen piyasaların ve/ya sektörlerin belirli bir boyutunu kapsayan değişkenlerin, basit değerleri üzerinden ölçümlenen veya bileşik değerleri üzerinden endeks biçiminde ölçümlenen göstergeler kullanılmaktadır. Bu göstergeler EYR'leri anlamlı ve tutarlı bir şekilde temsil etmekle birlikte dolaylı bir şekilde ölçümlenen vekil göstergeler olmaktadır. Bu göstergelerin EYR'leri temsil etme derecelerindeki eksikliklerin gözetildiği son yıllardaki bazı çalışmalarda ise IMF-MONA programına dayalı olarak piyasalarda ve/ya sektörlerde doğrudan gerçekleştirilen (uygulamaya konulan) EYR sayıları üzerinden ölçümlenen göstergeler kullanılmaktadır (Kouamé & Tapsoba, 2019: 158). IMF-MONA programına dayalı olarak ölçümlenen bu EYR göstergeleri, ilgili ampirik çalışmalardaki EYR'leri dolaylı bir şekilde ölçümlenen diğer vekil göstergelere kıyasla doğrudan gerçekleştirilen EYR sayıları üzerinden daha gerçekçi bir şekilde ölçümlenmesine olanak sağlamaktadır.

Buna karşılık ilgili literatür incelendiğinde, IMF-MONA programına dayalı olarak ölçümlenen EYR göstergelerinin kullanıldığı sınırlı sayıda ampirik çalışmanın bulunduğu ve bu konudaki öncü çalışmanın Kouamé ve Tapsoba (2019) tarafından yapıldığı görülmektedir. Kouamé ve Tapsoba (2019) çalışmalarında IMF-MONA veri tabanından ölçümlenen reel ve finansal sektörlerdeki EYR'lerin, mikro(firma) düzeydeki etkilerini panel veri analiz metodolojisine dayanan doğrusal olmayan MM (Multilevel Mixed) Modeliyle araştırmışlardır. Gelişmekte olan 37 ülkede reel ve finansal sektörlerdeki EYR'lerin işgücü verimliliği üzerindeki etkilerini inceledikleri çalışmalarının sonucunda,

İlgili ülkelerde EYR'lerin işgücü verimliliğini artırdığı yönünde sonuçlara ulaşımlardır. IMF-MONA veri tabanına dayalı olarak ölçümlenen EYR göstergelerinin kullanıldığı Daştan vd. (2020) ve Yalçınkaya vd. (2021) çalışmalarında ise finansal, mali, reel ve ticari sektörlerdeki EYR'lerin sırasıyla geçiş ekonomisi 18 ülkenin ve Türkiye'nin ekonomik büyümesi üzerindeki etkileri inceleme konusu yapılmıştır. Daştan vd. (2020) doğrusal panel veri analiz metodolojisine dayanan ARDL (Auto-Regressive Distributed Lag) modellerinin sonucunda EYR'lerin ilgili ülkelerin ekonomik büyümesi üzerinde pozitif bir etkiye sahip olduğunu tespit etmişlerdir. Yalçınkaya vd. (2021) zaman serisi analiz metodolojisine dayanan doğrusal ve doğrusal olmayan ARDL modellerinin sonucunda ise ticari sektör EYR'lerinin Türkiye'nin ekonomik büyümesi üzerinde herhangi bir etkiye sahip olmadığını belirlemişlerdir. Bu çalışmada ise literatürde IMF-MONA programına dayalı verilerin EYR'leri temsil etme derecesindeki üstünlüğü gözetilerek ulusal kaynaklar temelinde Türkiye için sektörel EYR göstergeleri oluşturulmakta ve makro düzeyde ekonomik büyüme üzerindeki etkileri zaman serilerindeki doğrusal ve doğrusal dışı dinamikleri hesaba katan BF-ARDL modeliyle incelemektedir. Finansal, mali, reel ve ticari sektörlerde doğrudan gerçekleştirilen reform önerilerinin sayıları üzerinden ölçümlenen EYR göstergeleri kullanılarak Türkiye üzerine yürütülen çalışma bulgularının, kapsadığı EYR göstergeleri ve ekonometrik yöntemleri itibarıyla ilgili literatürün gelişimine katkı sağlayacağı değerlendirilmektedir.

3. Ekonomik Yapısal Reformların Ölçülmesi

Bu bölümde, IMF-MONA programı ile veri tabanındaki sınıflandırmaların referansında sırasıyla Türkiye için EYR'ler tanımlanmakta, 1990-2021 dönemindeki TCRG arşiv verilerinden doğrudan gerçekleştirilen reform önerilerinin sayısal verileri üzerinden ölçümlenmekte ve endeks biçimindeki göstergelere dönüştürülmektedir.

3.1. MONA Programı ve Ekonomik Yapısal Reformlar

IMF tarafından geliştirilen MONA programı, üye ülkelerde Fon destekli düzenlemelerin ekonomik amaçlarını, hedeflerini ve sonuçlarını değerlendirebilmek üzere hazırlanan karşılaştırılabilir performans bilgilerini içermektedir. IMF-MONA programının performans bilgilerini içeren veri tabanı ise ülkelerde Fon destekli düzenlemelere dayanan finansal, mali, reel ve ticari sektörlerdeki EYR tanımlamaları, türleri, önerileri, sayıları vb., hakkındaki nicel ve nitel verileri kapsamaktadır. IMF-MONA veri tabanı, EYR önerilerinin onaylanma ve incelenme tarihi sırasında toplanan verilere dayanmakta ve programa katılan Fon üyesi 106 ülkenin 1993-2021 dönemindeki verilerini kapsamaktadır⁴.

IMF-MONA veri tabanındaki EYR önerilerinin onaylanması ve incelenmesi, programa katılan ülkelerin yetkilileri ile IMF yönetim kurulu tarafından kararlaştırılan dört farklı politika taahhüdüne dayanmaktadır. Bu politika taahhütleri, Öncelikli Eylemler (Prior Actions - PA), Nicel Performans Kriterleri (Quantitative Performance Criteria - QPC),

⁴ Bu ülkeler hakkında bakınız: IMF-MONA, 2022.

Gösterge Niteliğindeki Hedefler (Indicative Targets - IT) ve Yapısal Standartlar (Structural Benchmarks - SB) şeklinde sınıflandırılmaktadır⁵. Bu politika taahhütleri içerisinde SB'ler, IMF yönetim kurulu tarafından ülkelerin EYR taahhütlerini değerlendirebilmek üzere belirteçler olarak tasarlanan ve nitel formdaki verilerden oluşan EYR önerilerine karşılık gelmektedir. MONA programına katılan ülkelerde finansal, mali, reel ve ticari sektörler göre farklılıklar gösteren SB'lerin, makroekonomik göstergelerde dengenin yeniden sağlanabilmesinde önemli görülen EYR önerilerini içerdiği ve karşılanması durumunda gerçekleştirilen EYR'ler olarak tanımlanıp sayılabileceği kabul edilmektedir (IMF-MONA, 2022). IMF-MONA programında para-sermaye ve mal-emek piyasalarını kapsayan EYR önerilerini gösteren SB'ler, ilgili sektörlerdeki tanımlama ve kodlarına göre 33 başlıkta Tablo 1'deki gibi sınıflandırılmaktadır.

Tablo: 1
IMF-MONA Programı EYR Tanımlamaları ile Kodlamaları

EYR Sektörleri	EYR Kodları ve Tanımlamaları
Finansal	2. Merkez bankası. 2.1. Merkez bankası operasyonları ve reformları. 2.2. Merkez bankası denetimi, şeffaflık ve finansal kontroller. 6. Finansal sektör. 6.1. Finansal sektör yasal reformları, regülasyon ve denetlemeler. 6.2. Yeniden yapılandırma ve finansal kurumların özelleştirilmesi.
Mali	1. Genel hükümet. 1.1. Gelir ölçümleri (ticaret politikası dışındaki). 1.2. Gelir yönetimi (gümrükler dâhil). 1.3. Harcama önlemleri (borç ödemeleri dahil). 1.4. Kombine harcamalar ve haslat. 1.5. Borç yönetimi. 1.6. Harcama denetimi, harcama muhasebesi ve finansal kontroller. 1.7. Mali şeffaflık (ilan, parlamento denetimi). 1.8. Bütçe hazırlama (bütçe teklifleri veya onaylama). 1.9. Hükümetler arası ilişkiler. 4. Emeklilik ve diğer sosyal sektör reformları. 4.1. Emeklilik reformları. 4.2. Diğer sosyal sektör reformları (örneğin, sosyal güvenlik ağları, sağlık ve eğitim reformları). 10. Ekonomik istatistikler (mali, merkez bankası şeffaflığı ve benzeri önlemler dışındaki). 11.4. Yolsuzlukla mücadele mevzuatı/politikası.
Reel	3. Kamu hizmeti, kamu istihdam reformları ve ücretler. 5. Kamu teşebbüsü reformları ve fiyatlandırma (finansal sektör dışındaki). 5.1. Kamu teşebbüslerinde fiyatlama ve sübvansiyonlar. 5.2. Özelleştirme, kamu teşebbüsü reformları ve yeniden yapılandırma (fiyatlandırma dışındaki). 5.3. Fiyat kontrolleri ve pazarlama kısıtlamaları. 9. İş gücü piyasası (kamu sektörü istihdamı dışındaki). 11. Diğer yapısal önlemler. 11.1. Özel sektör yasal ve düzenleyici çevre reformu (finansal sektör dışındaki). 11.2. Doğal kaynaklar ve tarım politikaları (kamu teşebbüsleri ve fiyatlandırma dışındaki). 11.3. Yoksullukla mücadele stratejileri geliştirme ve uygulama.
Ticari	7. Kur sistemleri ve kısıtlamalar (para ve sermaye). 8. Uluslararası ticaret politikası (gümrük reformları dışındaki).

Not: Tablodaki EYR tanımlamaları ve kodlamaları IMF-MONA veri tabanına dayalı olarak yazarlar tarafından oluşturulmaktadır.

Kaynak: MONA Database.

3.2. TCRG Arşivi ve Ekonomik Yapısal Reform Endekslerinin Türetilmesi

7/10/1920 Tarihinde kurulan ve 07/02/1921 Tarihinde yayın hayatına başlayan TCRG'si, 21/6/1970 tarihinden bu yana ulusal bayram ve genel tatil günleri dışında günlük bazda yayınlanmakta ve 27/6/2000 tarihinden itibaren açık erişimli olarak hizmet sunmaktadır. TCRG'sinde, Cumhurbaşkanlığı, Türkiye Büyük Millet Meclisi-TBMM, Bakanlıklar ile Bakanlıklara bağlı tüm kamu kurum ve kuruluşları tarafından hazırlanarak Anayasaya, Kanunlara, Cumhurbaşkanlığı Kararnemelerine, Genel Hukuk Kurallarına, Cumhurbaşkanlığı Programına, Kalkınma Plan ve Programlarına uygun bulunan; kanunlar, TBMM iç tüzüğü, milletlerarası antlaşmalar-sözleşmeler, cumhurbaşkanlığı/bakanlar kurulu kararnemeleri-kararları, cumhurbaşkanlığı kararnemeleri-kararları, tüzükler, yönetmelikler, tebliğler ve diğer düzenleyici idari işlemlere ilişkin gerçekleştirilen düzenlemeler, değişiklikler vb., yayınlanmaktadır. Bu kapsamda TCRG'sinin, Türkiye'de ekonomik sistemi oluşturan sektörlerin ve piyasaların yasal çerçevesine, kurumsal yapısına ve

⁵ SB'lerin oluşturulmasına katkı sağlayan tamamlayıcı nitelikteki bu politika taahhütleri hakkında ayrıntılı bilgi için bakınız: IMF-MONA, 2022.

işleyişine ilişkin değişiklikler, dönüşümler, iyileştirmeler, düzenlemeler vb. yapılması amacıyla gerçekleştirilen EYR önerilerini Tablo 1'deki IMF-MONA sınıflandırmalarıyla uyumlu bir şekilde içerdiği noktasından hareket edilmektedir. Bu hareket noktasından başlanılarak bölümde sırasıyla IMF-MONA sınıflandırmaları eşliğinde Türkiye için EYR'ler tanımlanıp kodlanmakta, 1990-2021 döneminde TCRG arşivi taranarak doğrudan gerçekleştirilen (yürürlüğe konulan) reform önerilerinin sayısal verileri üzerinden ölçümlenmekte ve endeks biçimindeki göstergelere dönüştürülmektedir.

Türkiye'de EYR'lerin IMF-MONA sınıflandırmaları eşliğinde tanımlanıp kodlanmasının amaçlandığı ilk aşamada, öncelikle IMF-MONA veri tabanı 1993-2021 döneminde 106 ülkenin tamamı için EYR önerilerinin tanımlamaları ve kodlamaları açısından incelenmiş ve EYR önerileri Tablo 1'deki başlıklar altında tasnif edilip derlenmiştir. Akabinde bu analiz süreci sadece Türkiye için işletilmiş ve IMF-MONA veri tabanı Türkiye'nin programa dahil olduğu 1993-2008 döneminde EYR önerilerinin tanımlamaları ve kodlamaları açısından incelenerek Tablo 1'deki sınıflandırmalara göre tasnif edilip derlenmiştir. Böylelikle bu aşamada, IMF-MONA programına katılan 106 ülkede ilgili sektörlerdeki tanımlamalar ve kodlamalar altında önerilen EYR'lerin kapsamı ve içeriği belirlenebilmiştir. Bu aşamada ayrıca, Türkiye için EYR'lerin, Tablo 1'deki IMF-MONA sınıflandırmaları eşliğinde 4 sektörde ve 33 başlıkta tanımlanıp kodlanabileceği tespit edilmiştir.

Türkiye'de finansal, mali, reel ve ticari sektörlerde gerçekleştirilen EYR önerilerinin sayısal verilerinin ölçülmesinin amaçlandığı ikinci aşamada, IMF-MONA sınıflandırmaları eşliğinde ulusal bir kaynak olan TCRG arşivi taranmakta ve ilgili sektörlerde gerçekleştirilen EYR önerilerinin sayıları belirlenmektedir. Bu aşamada, öncelikle TCRG arşivi 1990-2021 dönemindeki 01/01/1990-31/12/2021 tarihleri aralığında günlük bazda taranmış, ulusal bayram ve genel tatil günleri dışında yayınlanan bütün TCRG sayıları temin edilmiş ve incelenmek üzere tasnif edilmiştir. Akabinde IMF-MONA programına katılan 106 ülkedeki ve Türkiye özelindeki EYR tanımlamaları gözetilerek günlük bazdaki TCRG sayıları taranmış ve Tablo 1'deki IMF-MONA sınıflandırmalarını içeren kanunlar, kanun hükmünde kararname ve kararlar (cumhurbaşkanlığı kararları-kararnameleri, bakanlar kurulu kararları-kararnameleri) tahlil edilerek EYR tanımlamalarını içeren ilgili mevzuatlar belirlenmiştir. Daha sonra ise IMF-MONA programına katılan 106 ülkedeki ve Türkiye özelindeki EYR tanımlamalarını içerdiği belirlenen ilgili mevzuatlardaki EYR'ler, Tablo 1'deki IMF-MONA sınıflandırmaları referansında eşleştirilmiş ve tanımlanıp kodlanmıştır. Bu aşamada son olarak IMF-MONA programı ve veri tabanındaki sınıflandırmalarla uyumlu olarak Türkiye'de 1990-2021 döneminde gerçekleştirilen ve TCRG arşivinden günlük bazda ölçümlenen EYR'lerin sayısal verileri, ilgili oldukları sektörlerle göre toplulaştırmış ve yıllık bazlı değerlere dönüştürülmüştür. Böylelikle bu aşamada IMF-MONA programı ve veri tabanındaki sınıflandırmalar eşliğinde Türkiye'de 1990-2021 döneminde gerçekleştirilen EYR'ler tanımlanıp kodlanabilmiş ve gerçekleştirilen EYR'lerin sayısal verileri ilgili oldukları sektörlerle göre ölçümlenebilmiştir. Ayrıca bu aşamada, IMF-MONA programı ve veri tabanındaki sınıflandırmalar eşliğinde TCRG arşivinden ölçümlenen ve Türkiye'de 1990-2021 döneminde finansal (22), mali (40),

reel (39) ve ticari (40) sektörlerde toplam (102) adet EYR gerçekleştirildiği belirlenmiştir. Türkiye'de 1990-2021 döneminde gerçekleştirilen 102 adet EYR önerisinden 45'inin, Türkiye'nin IMF-MONA programına dahil olduğu 1992-2008 döneminde ilgili sektörlerde Türkiye'ye özgü olarak önerilen ve süreç içerisinde (program döneminde veya sonrasında) gerçekleştirilen EYR önerilerinden oluştuğu bilgisi de yine bu aşamada tespit edilmiştir. IMF-MONA sınıflandırmaları eşliğinde TCRG arşivinden ölçümlenen ve Türkiye'de 1990-2021 döneminde gerçekleştirilen bu 102 adet EYR'ye ilişkin sayısal veriler, yazarlar tarafından EYR sayıları, sektörleri, kodlamaları, tanımlamaları ve TCRG arşiv taraması bilgilerini içerecek şekilde tablo halinde hazırlanmıştır⁶.

Türkiye için 1990-2021 döneminde TCRG arşivinden ölçümlenen EYR sayısal verilerinin endeks biçimindeki göstergelere dönüştürülmesinin amaçlandığı üçüncü aşamada, gerçekleştirilen EYR verileri kullanılarak ilgili sektörlerdeki EYR endeksleri, normleştirme yaklaşımına dayanan istatistiki Z-Skoru (ZS) yöntemiyle oluşturulmaktadır. Normleştirme yaklaşımı, EYR ham verilerindeki gibi sayısal farklılıkların fazla olduğu veri setlerine uygulanarak belirli bir aralıkta düzenli dağılım gösterecek şekilde yeniden ölçeklendirilmesine dayanmakta ve veri setindeki sayısal farklılıkların giderilebilmesine olanak sağlamaktadır. EYR ham verilerinin normleştirilmesinde kullanılan ZS yöntemi, ortalaması (μ) ve standart sapması (σ) ile sembolize edilen belirli bir (X) değişkenine ait ham verilerin merkezi-indirgenmiş normleştirmeyle ölçeklendirilerek yeni bir değişkene dönüştürülmesine imkân vermektedir. Uygulamalı literatürde sıklıkla kullanılan ZS yönteminde (X) değişkenine ait ham verilerin normleştirilerek endeks biçimindeki yeni bir değişkene dönüştürülmesi süreci aşağıdaki denklemlere dayanmaktadır: (Nardo et al., 2005: 60).

$$ZS = \left(\frac{X - \mu}{\sigma} \right) \quad (1)$$

Eşitlik 1'de (X) değişkeninin normal dağılıması durumunda, ZS sıfır ortalama ve bir standart sapma ile merkezi-indirgenmiş normal bir dağılım izlemektedir. Bu ölçeklendirmeye birlikte, gerçekleştirilen EYR ham verileri kullanılarak oluşturulan EYR göstergeleri aynı birimde ve benzer büyüklükte (yani ortalama ve standart sapmada) hesaplanabilmekte ve etkileri açısından istatistiki olarak anlamlı bir şekilde karşılaştırılabilmektedir (Kouamé & Tapsoba, 2019: 161). Türkiye'nin 1990-2021 dönemindeki EYR ham verilerinin ZS yöntemiyle endeks biçimindeki EYR göstergelerine dönüştürülmesinde temel alınan denklem Eşitlik 2'de gösterilmektedir:

$$EYR \text{ Endeksi}_{ct} = \left(\frac{(EYR_{ct} - EYR_{c\mu})}{EYR_{c\sigma}} \right) \quad (2)$$

Eşitlik 2'deki (EYR_{ct}) terimi Türkiye'de belirli bir sektörde (c) t yılında gerçekleştirilen EYR sayısal verilerinin toplamını göstermektedir. ($EYR_{c\mu}$) ve ($EYR_{c\sigma}$)

⁶ Çalışmada raporlanmayan bu tablo ve içeriği iletişim kurulması (istenilmesi) durumunda yazarlardan temin edilebilir.

terimleri ise sırasıyla Türkiye’de belirli bir sektörde örneklem döneminde gerçekleştirilen EYR sayısal verilerinin ortalamasını ve standart sapmasını belirtmektedir. Türkiye’de (t) yılında gerçekleştirilen EYR sayısal verilerinin toplam sayısının, örneklem döneminde gerçekleştirilen EYR sayısal verilerinin ortalamasına eşit olması durumunda EYR Endeksi 0 değerini alırken, diğer durumlarda 0’dan farklı değerler almaktadır. Böylelikle bu aşamada Türkiye’de ilgili sektörlerde gerçekleştirilen EYR önerilerinin 1990-2021 dönemindeki sayısal verileri, ampirik analizlerde kullanılacak endeks biçimindeki göstergelere dönüştürülebilmiştir.

4. Veri, Model ve Metodoloji

4.1. Veri Seti ve Modellerin Tanımlanması

Bu bölümde, Türkiye’de EYR’lerin ekonomik büyüme üzerindeki etkilerini incelemeyi amaçlayan çalışmanın, ekonometrik analizlerinde kullanılan verileri ile tahmin edilen modelleri tanımlanmaktadır. Zaman serisi analiz metodolojisi kapsamındaki çalışmanın ekonometrik analizlerinde kullanılan değişkenlerine ait veri setleri Tablo 2’de açıklanmaktadır⁷.

Tablo: 2
Değişkenlerin Tanımlanması

Kısaltma	Tanımlama	Veri Kaynağı
RGDP	Reel Gayrisafi Yurtiçi Hâsıla (Türk Lirası)	Dünya Bankası
RGFI	Reel Sabit Sermaye Yatırımları (Türk Lirası)	(Dünya Kalkınma Göstergeleri-WDI-2022) ¹
EMP	İstihdam Edilen İşçici (Milyon Kişi)	Groningen Üniversitesi Büyüme ve Kalkınma Merkezi (Penn Dünya Tabloları-PWT-10-2022) ²
TFP	Toplam Faktör Verimliliği (Türk Lirası)	Konferans Kurulu Toplam Ekonomi Veri Tabanı-(TED-2022) ³
F-ZS	Finansal Ekonomik Yapısal Reform Endeksi	Türkiye Cumhuriyeti Cumhurbaşkanlığı Resmi Gazete (TCRG) Arşiv Verileri ve Yazarların Hesaplamaları.
M-ZS	Mali Ekonomik Yapısal Reform Endeksi	
R-ZS	Reel Ekonomik Yapısal Reform Endeksi	
T-ZS	Ticari Ekonomik Yapısal Reform Endeksi	
TP-ZS	Toplam Ekonomik Yapısal Reform Endeksi	

Not: Tablodaki veri kaynaklarından "1" *The World Bank (World Development Indicators-WDI-2022)*, "2" *University of Groningen Growth and Development Centre (Penn World Table-PWT-10-2022)* ve "3" *The Total Economy Database of The Conference Board-(TED- 2022)* belirtilmektedir.

Tablo 2’de tanımlanan değişkenlerin türetilmesinde ve ekonometrik analizlerde kullanılan formlarına dönüştürülebilmesinde işletilen süreç aşağıdaki gibi açıklanabilmektedir: Ekonomik büyümeyi, fiziki-beşerî sermaye birikimini ve teknolojik gelişmişlik düzeyini temsilen kullanılan RGDP, RGFI, EMP ve TFP değişkenlerinin örneklem dönemindeki değerlerine ait veriler ilgili veri tabanlarından hazır veriler olarak derlenmiştir. Finansal, mali, reel ve ticari sektör ile toplam EYR’leri ZS yöntemiyle endeks biçiminde ölçmek üzere oluşturulan EYR-ZS değişkenlerinin verileri ise IMF-MONA programındaki sınıflandırmalar eşliğinde TCRG arşivinden derlenen EYR’lerin sayısal verileri kullanılarak hesaplanmıştır.

⁷ Çalışmada örneklem döneminin belirlenmesinde Türkiye için endeks biçiminde hesaplanan EYR değişkenlerine ait verilerin TCRG arşivinden 1990-2021 dönemi aralığında temin edilmesi etkili olmaktadır.

Bu kapsamda, Türkiye’de 1990-2021 döneminde gerçekleştirilen EYR’lere ilişkin yıllık bazlı sayısal verilerin yürürlük sürecindeki dönem aralıkları (IMF-MONA programı ile veri tabanında bütün EYR’ler için 3’er yıllık olarak belirlenen) gözetilerek ZS yöntemiyle hesaplanan EYR endeksleri sırasıyla aşağıdaki aşamalar takip edilerek türetilmiştir: İlk aşamada, Türkiye’de 1990-2021 döneminde gerçekleştirilen EYR’lerin yürürlük sürecindeki dönem aralıkları (bütün EYR’lerde 3’er yıllık olduğu kabul edilen) belirlenmiş ve bu dönem aralığında gerçekleştirilen EYR’lerin sayıları ilgili oldukları sektörler göre gruplandırılarak toplanmıştır. İkinci aşamada, ilgili oldukları sektörler göre gruplandırılarak sayılan ve toplanan EYR’ler, yürürlük sürecinde 3’er yıllık olduğu kabul edilen dönem aralıklarında ileriye doğru aynı değerleri alacak şekilde genişletilmiştir. Bu ilk iki aşama 1990-2021 döneminde gerçekleştirilen bütün EYR’ler açısından işletilmiş ve yürürlük sürecindeki dönem aralıkları temel alınarak Türkiye’nin yıllık bazlı finansal, mali, reel ve ticari sektör ile toplam EYR sayıları kümülatif olarak elde edilmiştir. (Kouamé & Tapsoba, 2019), Yalçınkaya vd. (2021) EYR’leri konu edinen çalışmalarına dayandırılan bu yöntemle, EYR’lerin yürürlük sürecindeki (ileriye dönük belirli bir dönem aralığındaki) etkilerinin gözetilerek hesaplanması amaçlanmıştır). Üçüncü ve son aşamada, ilgili sektörlerdeki EYR endeksleri ZS (F-ZS, M-ZS, R-ZS, T-ZS ve TP-ZS) yöntemiyle Eşitlik 2’deki denklemlerle ayrı ayrı hesaplanmıştır. Türkiye’nin ZS yöntemiyle hesaplanan ilgili sektörlerdeki EYR-ZS endekslerinin 1990-2021 dönemindeki gelişim seyri Ekte sunulan Şekil 1’deki grafiklerden izlenilebilmektedir. Şekil 1 incelendiğinde, FN, FS, RL ve TR şeklindeki reform endekslerinin örneklem dönemindeki en yüksek değerlerini, Türkiye’nin IMF-MONA programına dahil olduğu 1993-2008 dönemi aralığında aldıkları görülmektedir. Bu bulgular, Türkiye’de örneklem döneminde gerçekleştirilen reformlarda IMF-MONA programının önemli bir etkisinin ve yönlendirmesinin olduğunu göstermektedir. Bununla birlikte Şekil 1 incelendiğinde, FN, FS, RL ve TR şeklindeki reform endekslerinin, örneklem dönemi boyunca normal bir dağılım sergilemediği, 1990-1999 dönemi aralığında durağan, 2000-2008 dönemi aralığında artan ve 2009-2021 dönemi aralığında ise azalan bir trend izlediği görülmektedir. Bu bulgular, Türkiye’de örneklem döneminde gerçekleştirilen reformların önemli ölçüde IMF-MONA programına bağlı kalınarak gerçekleştirildiğini göstermekte ve konjonktürelilik taşıdığına işaret etmektedir.

Tablo: 3
Değişkenlerin Tanımlayıcı İstatistikleri

Değişken	Ortalama	Medyan	Maksimum	Minimum	Std. Sapma	Gözlem
RGDP	27.588	27.595	28.325	26.963	0.424	32
RGFI	26.113	26.164	26.943	25.247	0.601	32
EMP	3.089	3.020	3.362	2.866	0.156	32
TFP	0.002	0.001	0.092	-0.092	0.043	32
F-ZS	1.390	-0.034	1.599	-1.123	1.016	32
M-ZS	6.940	-0.398	2.792	-0.854	1.016	32
R-ZS	-1.110	-0.262	2.832	-1.588	1.016	32
T-ZS	1.730	-0.321	3.109	-0.321	1.016	32
TP-ZS	4.860	-0.389	2.923	-0.974	1.016	32

Tüm bu veri dönüştürme sürecinin ardından ekonometrik analizlerde doğal logaritmik değerleri kullanılan makroekonomik RGDP, RGFI, EMP ve TFP değişkenleri ile

endeks biçimindeki düzey değerleri kullanılan EYR-ZS değişkenlerinin 1990-2021 dönemindeki tanımlayıcı istatistikleri Tablo 3'te görülmektedir.

EYR'lerin Türkiye'nin ekonomik büyümesi üzerindeki etkilerini belirlemek üzere zaman serisi analiz metodolojisiyle tahmin edilecek ekonometrik modeller, Solow (1956) öncülüğünde geliştirilen Neo-Klasik büyüme modeli kapsamındaki CD stokastik üretim fonksiyonunun genişletilmesine dayanmaktadır. Ekonomik büyümenin (Y_t) fiziki sermaye birikiminin (K_t), beşerî sermaye birikiminin (L_t) ve teknolojik gelişmişlik düzeyinin (A_t) fonksiyonu olduğunu belirten ölçek getirilerinin sabit ve teknolojik gelişmenin dışsal olduğunu varsayan CD üretim fonksiyonu Eşitlik 3'teki gibi ifade edilebilmektedir:

$$Y_t = A_t K_t^\alpha L_t^\tau \quad (3)$$

Burada, (t) alt indisi zamanı gösterirken, ($\tau = 1 - \alpha$) olmak üzere (α) ve (τ) üst indisleri sırasıyla fiziki ve beşerî sermaye birikiminin üretim esnekliklerini belirtmektedir. Büyüme teorilerinin ekonomik büyümenin belirleyicileri konusundaki evrimi gözetildiğinde CD üretim fonksiyonu, Romer (1986) öncülüğünde geliştirilen İçsel büyüme teorileri kapsamında teknolojik gelişmişlik düzeyi ile diğer muhtemel belirleyicileri (ekonomik yapısal reformları) içermek üzere genişletilerek Eşitlik 4'teki gibi yeniden düzenlenebilmektedir:

$$Y_t = A_t K_t^\alpha L_t^\tau EYR_t^\gamma \mu_t^\varepsilon \quad (4)$$

Eşitlik 4'teki terimlerden; Y_t ekonomik büyümeyi (RGDP), K_t fiziki sermaye birikimini (RGFI), L_t beşerî sermaye birikimini (EMP) ve EYR_t finansal, mali, reel ve ticari sektör ile toplam EYR endekslerini göstermektedir. CD üretim fonksiyonundaki (A_t) teriminin ise büyüme teorilerinin teknolojik gelişmişlik düzeyini açıklama noktasındaki gelişim süreci gözetilerek toplam faktör verimliliğinden (TFP) oluştuğu kabul edilmektedir. Fonksiyonel gösterimle $A_t = f(TFP)_t^\delta$ olarak ifade edilen TFP'nin, ekonomik büyümenin fiziki-beşerî sermaye birikimi biçimindeki faktörlerinin miktarlarındaki değişimlerle açıklanamayan ve "Solow Artığı" olarak sadece teknolojik gelişmeyle gerçekleştirilen bölümünü oluşturduğu varsayılmaktadır (Solow, 1956: 85-91). Bu varsayımlar altında Eşitlik 4'te tanımlanan CD üretim fonksiyonunun doğal logaritmasının alınmasıyla birlikte genişletilerek aşağıdaki gibi yeniden düzenlenebilmektedir:

$$Y_t = \alpha + \delta_t A_t + \alpha_t K_t + \tau_t L_t + \gamma_t EYR_t + \varepsilon_t \quad (5)$$

Ekonomik büyümenin muhtemel belirleyicilerini içerecek şekilde CD üretim fonksiyonunun genişletilmesine dayanan modellerin tanımlanması ampirik literatürde sıklıkla kullanılmaktadır (Sala-i-Martin, 1997: 178-183). Zaman serisi analiz metodoloji izlenilerek çalışmada 1990-2021 dönemi için tahmin edilecek ekonometrik modellerin temel formu aşağıdaki denklemde gösterilmektedir:

$$\text{Model: } \text{RGDP}_t = \alpha_0 + \alpha_1 \text{RGFI}_t + \alpha_2 \text{EMP}_t + \alpha_3 \text{TFP}_t + \alpha_4 \text{EYR}_t + \varepsilon_t \quad (6)$$

Modeldeki terimlerden; (α_0) , (α) , (ϵ) ve (t) sabit parametreyi, eğim parametrelerini, normal dağılımlı hataları ve zamanı göstermektedir. Modelde EYR'ler F-ZS, M-ZS, R-ZS, T-ZS ve TP-ZS şeklindeki 5 değişkenle temsil edildiğinden, çoklu doğrusal bağlantı problemini önleyebilmek üzere, Eşitlik 6'daki temel modelin bu sıralamayla uyumlu 5 farklı varyasyonu tahmin edilmektedir. Modelde finansal, mali, reel ve ticari sektörlerde gerçekleştirilen ekonomik yapısal reformların toplamı üzerinden hesaplanan ve TP-ZS şeklindeki EYR değişkeninin kullanılmasında; ilgili sektörlerdeki EYR değişkenlerinin tanımlandığı modellerin ampirik bulgularının tutarlılığının tespit edilmesi amacı etkin olmaktadır. Bununla birlikte çalışmada, ZS yöntemiyle hesaplanan EYR endekslerinin güvenilirliğini ve sağlamlığını tespit etmek üzere ilgili sektörlerdeki EYR endeksleri, uygulamalı literatürde ZS yöntemine kıyasla verilerdeki standart sapmaları azaltabilme ve aykırı değerleri ayıklayabilmedeki üstünlüğüyle kullanılan bir diğer normalleştirme yaklaşımı olan Min-Mak yönteminin metodolojisiyle benzer aşamalarda türetilmiştir. Eşitlik 6'ta tanımlanan modeller için çalışmada kullanılan ekonometrik metodoloji ve analiz süreci ZS ve MM yöntemleriyle hesaplanan değişkenlere yönelik ayrı ayrı işletilmiş ve benzer bulgularla karşılaştırıldığından MM yöntemine dayalı modellerden elde edilen analiz bulguları çalışmada raporlanmamıştır. Çalışmada raporlanmayan MM yöntemine dayalı modellerin analiz bulguları, iletişim kurulması (istenilmesi) durumunda yazarlardan temin edilebilir.

4.2. Ekonometrik Metodoloji ve Analiz Süreci

EYR'lerin Türkiye'nin 1990-2021 dönemindeki ekonomik büyümesi üzerindeki etkilerini incelemek üzere Eşitlik 6'da tanımlanan denklemler BF-ARDL modeliyle tahmin edilmektedir. Farklı derecelerden $[I(0)]$ - $[I(1)]$ ve en fazla $[I(1)]$ düzeyinde durağan (bütünleşik), doğrusal ve/ya doğrusal dışı dinamiklere sahip değişkenler arasındaki kısa-uzun dönemli ilişkileri incelemek üzere geliştirilen BF-ARDL modeli, McNown vd. (2018), Solarin (2019) ve Yılancı vd. (2020) çalışmalarına dayanmaktadır. Pesaran vd. (2001) tarafından geliştirilen ARDL modelinin değişkenlerin gecikmeli değerlerini kullanmasının, regresyon denklemindeki otokorelasyon ve içsellik gibi tanımlama problemlerini giderilebildiği varsayılmaktadır (Pesaran et al., 2001: 290-310). Buna karşılık, ARDL modelinin bağımlı değişkenden bağımsız değişkenlere doğru geri bildirim gerektirmemesi McNown vd. (2018) çalışmalarında eleştirilmekte ve bu durumun zayıf formda da olsa içsellik problemini meydana getirebileceği belirtilmektedir. McNown vd. (2018) tarafından ARDL modelindeki muhtemel içsellik probleminin güç ve boyut özelliklerini zayıflattığı belirtilmekte ve küçük örneklerde bile kullanılabilen Bootstrap B-ARDL modeli geliştirilmektedir. B-ARDL modelinde, eşikli Monte Carlo simülasyonları kullanıldığından içsellik probleminin küçük örneklerde dahi güç ve boyut özelliklerini etkilemediği varsayılmaktadır (McNown et al. 2018: 1509-1521). UECM (Unrestricted Error Correction Model) dayanan McNown vd. (2018) B-ARDL modellerinde, (p) ve (q) gecikme uzunluklarını göstermek üzere (Y_t) ve (X_t) şeklindeki iki değişken arasındaki kısa-uzun dönemli ilişkiler aşağıdaki denklem üzerinden araştırılabilmektedir (McNown et al., 2018: 1509-1521):

$$\Delta Y_t = \beta_0 + \beta_1 Y_{t-1} + \beta_2 X_{t-1} + \sum_{i=1}^{p-1} \theta'_i \Delta Y_{t-i} + \sum_{i=1}^{q-1} \delta'_i \Delta X_{t-i} + e_t \quad (7)$$

Burada (Δ) birinci dereceden devresel farkları, (p) optimal gecikme uzunluğunu ve (e_t) normal dağılımlı kalıntıları göstermektedir. Denklemde (β_0) sabiti gösterirken (β_1) ve (β_2) ile (θ_i) ve (δ_i) terimleri sırasıyla değişkenlere ait kısa dönemli ve uzun dönemli katsayıları belirtmektedir. Eşitlik 7'deki denklem inceleme döneminde değişkenlerde meydana gelen yapısal kırılmaların $d(t)$ etkilerini içerebilecek şekilde genişletilerek aşağıdaki gibi yazılabilmektedir:

$$\Delta Y_t = \beta_0 + \beta_1 Y_{t-1} + \beta_2 X_{t-1} + \sum_{i=1}^{p-1} \theta'_i \Delta Y_{t-i} + \sum_{i=1}^{p-1} \delta'_i \Delta X_{t-i} + \sum_{j=1}^q \eta'_j D_{tj} + e_t \quad (8)$$

Burada $d(t)$ inceleme döneminde kukla değişkenlerle belirlenen yapısal kırılmaları gösterirken (D_t) terimi ise bu yapısal kırılmaların uzun dönemli katsayıları belirtmektedir. Denklemde kukla değişkenlerle belirlenen yapısal kırılmalarının niteliğinin (biçiminin, sayısının ve tarihinin) önceden bilindiği varsayıldığından sadece ani ve keskin bir şekilde meydana gelen yapısal kırılmalara izin verilmektedir (Sam et al., 2019: 130-141). Bu durumun, modelin değişkenlerine ait kısa-uzun dönemli katsayıları etkileyebileceği ve eş-bütünleşme denkleminin sınır (F) testi istatistiklerini yönlendirebileceği belirtilmektedir (McNown et al., 2018: 1509-1521). Solarin (2019) ve Yilanci vd. (2020) tarafından $d(t)$ yapısal kırılmaların $\sin(2\pi kt/T) + \cos(2\pi kt/T)$ şeklindeki trigonometrik terimlerle belirlenmesinin modelin katsayılarını ve eş-bütünleşme denklemini etkilemeyeceği belirtilmekte ve Bootstrap Fourier BF-ARDL modeli geliştirilmektedir. Tam sayılı(kesirli) frekanslı bileşenlerin küçük bir miktarının, niteliği bilinmeyen yapısal kırılmaları kademeli bir şekilde yakalayabileceğinin varsayıldığı BF-ARDL modelinde, kukla değişkenlerin trigonometrik terimlerle değiştirildiği denklem Eşitlik 9'daki gibi yazılabilmektedir (Solarin, 2019: 2877-78).

$$d(t) = \gamma_1 \sin\left(\frac{2\pi kt}{T}\right) + \gamma_2 \cos\left(\frac{2\pi kt}{T}\right) \quad (9)$$

Denklemdeki terimlerden (T) örneklem büyüklüğünü, (t) zamanı, ($\pi=3.14$) ve (k) kalıntı kareleri toplamının (SSR) minimum olduğu düzeyde kademeli yapısal kırılmaları belirlemek üzere seçilen optimal frekans sayısını belirtmektedir. Değişkenlerin bütünleşme düzeyi ile yapısal kırılmaların niteliği hakkında ön koşullarının bulunmadığı ve deterministik bileşendeki $d(t)$ keskin veya yumuşak yapısal kırılmaların kademeli bir şekilde belirlendiği BF-ARDL modelinin denklemi aşağıdaki gibi yazılabilmektedir (Solarin, 2019: 2877-78; Yilanci et al., 2020: 5-6):

$$\Delta Y_t = \beta_0 + \gamma_1 \sin\left(\frac{2\pi kt}{T}\right) + \gamma_2 \cos\left(\frac{2\pi kt}{T}\right) + \beta_1 Y_{t-1} + \beta_2 X_{t-1} + \sum_{i=1}^{p-1} \theta'_i \Delta Y_{t-i} + \sum_{i=1}^{p-1} \delta'_i \Delta X_{t-i} + \sum_{j=1}^q \eta'_j D_{tj} + e_t \quad (10)$$

Eşitlik 10'daki denklem, (k) frekans artışlarının 0.1 olarak gerçekleştiği ve $k=[0.1, \dots, 5]$ aralığındaki tüm k değerleri kullanılarak tahmin edilmektedir. Tahmin sonucunda SSR'nin en küçük olduğu düzeyde belirlenen optimal (k) değerine ve AIC (Akaike Information Criteria) bilgi kriteriyle belirlenen optimal (p, q) gecikme uzunluğuna sahip BF-ARDL modeli kullanılarak değişkenlerin kısa-uzun dönemli katsayıları ile eş-

bütünleşme denkleminin sınır (F) testi istatistikleri hesaplanmaktadır (McNown et al., 2018: 1509-1521).

BF-ARDL modelinin tahmininin, birbiri üzerine inşa edilen aşağıdaki dört temel aşama takip edilerek gerçekleştirilmektedir: İlk aşamada, BF-ARDL modelindeki değişkenlerin durağanlık derecelerinin birim kök testleriyle araştırılması ve en fazla birinci farklarında [I(1)] durağan olduklarının belirlenmesi gerekmektedir (Yılanci et al., 2020: 6; Li et al., 2022: 10918). BF-ARDL modelindeki değişkenlerin birim kök özelliklerinin incelenmesinden önceki ilk adımda, örneklem dönemindeki doğrusal ve doğrusal dışı dinamiklerinin doğrusallık testleriyle tespit edilmesi önem arz etmektedir. Nitekim BF-ARDL modelindeki değişkenlerin doğrusallık yapılarının belirlenmesi, kullanılacak birim kök testlerinin doğru bir şekilde tespit edilebilmesine ve sapmasız test istatistiklerinin elde edilebilmesine olanak sağlamaktadır (Cuestas & Garrant, 2011: 557). Çalışmada anılan koşulları karşılamak üzere BF-ARDL modelindeki değişkenlerin doğrusallık yapıları, durağanlık konusunda önsel varsayımlar içermeyen ve ampirik literatürde sıklıkla kullanılan Harvey vd. (2008-HLX) doğrusallık testiyle araştırılmaktadır (Harvey et al., 2008: 1-5)⁸.

İkinci adımda, doğrusallık yapıları gözetilerek birim kök özellikleri incelenecek BF-ARDL modeli değişkenlerindeki muhtemel yapısal kırılmaların da dikkate alınması gerekmektedir. Nitekim zaman serilerinin ekonomik, politik vb., koşullardaki değişimlere oldukça duyarlı oldukları ve zamanla içsel/dışsal şoklardan kaynaklı yapısal kırılmalara maruz kalabilecekleri bilinmektedir (Perron, 1989: 1361-63). Perron (1989) ve Kapetanios vd., (2003) çalışmalarından itibaren bilinen bu durum, yapısal kırılmaların hesaba katılması durumunda değişkenlerin birim kök özelliklerinin de değişebileceğini belirtmektedir (Enders & Lee, 2012: 574). Perron vd. (1989) doğrusal birim kök testlerinde keskin bir şekilde meydana geldiği varsayılan yapısal kırılmalar kukla değişkenlerle belirlenirken, Kapetanios vd. (2003), doğrusal olmayan birim kök testlerinde yumuşak bir şekilde meydana geldiği varsayılan yapısal kırılmalar deterministik bileşenin geçiş sürecinde tanımlanmaktadır. Ekonometri literatüründe yapısal kırılmaların önsel olarak belirlendiğini varsayan keskin/yumuşak kırılmalı bu birim kök testlerinin, kırılmaların sayısına göre test istatistiklerinin farklılaştığı ve kırılmaların sayısı arttıkça test istatistiklerinin gücünün zayıfladığı genel olarak kabul edilmektedir (Enders & Lee, 2012: 574-75). Buna karşılık Becker vd. (2006), Enders ve Lee (2012) ve Christopoulos ve Leon-Ledesma (2010) tarafından geliştirilen fourier fonksiyonlu birim kök testlerinde, yapısal kırılmalar kademeli bir şekilde belirlendiğinden kırılmalarının yapısının, sayısının ve tarihlerinin test istatistiklerinin gücünü değiştirmediği belirtilmektedir (Becker et al., 2006: 381-382). Çalışmada belirtilen üstünlükleri gözetilerek BF-ARDL modelindeki değişkenlerin birim kök özellikleri, regresyon denkleminin $(\sin(2\pi kt/T) + \cos(2\pi kt/T))$ şeklindeki

⁸ Bu testin metodolojisi hakkında kapsamlı bilgi için bakınız: Harvey vd., 2008.

trigonometrik terimlerle genişletildiği fourier fonksiyonlu doğrusal F-KPSS ve F-ADF ile doğrusal olmayan F-KSS birim kök testleriyle araştırılmaktadır⁹.

BF-ARDL modelindeki değişkenlerin en fazla [I(1)] düzeyinde bütünleşik olduklarının tespit edilmesinin ardından ikinci aşamada, AIC bilgi kriteri eşliğinde belirlenen spesifikasyonlar (p, q için optimal gecikme uzunlukları) kullanılarak değişkenler arasındaki uzun dönemli bütünleşik ilişkilerin sınır (F) testiyle araştırılması gerekmektedir (Ozgun et al., 2022:1660). Bu aşamada, BF-ARDL modelinin eş-bütünleşme vektörlerinde kademeli yapısal kırılmaların anlamlı olduğu belirlendiğinden, değişkenler arasındaki uzun dönemli bütünleşik ilişkiler, McNown vd., (2018), Solarin (2019) ve Yılancı vd., (2020) çalışmalarında önerilen sınır testinin (F) en genel formları olan (FA) ve (FB) testleriyle incelenabilmektedir. Eşitlik 10'da tanımlanan denklem üzerinden BF-ARDL modelindeki değişkenler arasındaki eş-bütünleşik ilişkiler; (FA) testinde bağımlı ve bağımsız değişkenlerin gecikmeli değerlerinin anlamlılığı birlikte ve ($H_{FA}: \beta_1 = \beta_2 = \beta_3 = 0$) şeklindeki temel hipotezle araştırılırken, (FB) testinde sadece bağımsız değişkenlerin gecikmeli değerlerinin anlamlılığı ($H_{FB}: \beta_2 = 0$) şeklindeki temel hipotezle incelenmektedir. Uygun güç ve boyut özelliklerine göre test istatistiklerinin ve kritik değerlerin oluşturulmasında asimptotik simülasyonlardan daha güçlü olduğu kabul edilen Monte Carlo simülasyonları ile yinelenmeli olarak hesaplanan (FA) ve (FB) test istatistiklerinin kritik tablo değerlerinden büyük olması durumunda, "eş-bütünleşme ilişkisi bulunmamaktadır" şeklindeki temel hipotezler reddedilmektedir (McNown et al., 2018: 1509). Deterministik bileşeninde ve eş-bütünleşme vektörlerinde kademeli yapısal kırılmaların anlamlı olduğu belirlenen BF-ARDL modelinde eş-bütünleşme ilişkilerinin bulunması durumunda üçüncü aşamada, Eşitlik 10'daki denklem AIC bilgi kriteri eşliğinde belirlenen spesifikasyon ve OLS yöntemiyle çözümlenerek kısa-uzun dönemli ARDL katsayıları hesaplanmaktadır (Ozgun et al., 2022: 1660). Dördüncü ve son aşamada tahmin edilen BF-ARDL modelleri, değişen varyans, otokorelasyon, normallik vb., gibi tanınal testlerden geçirilmekte ve modellerin istikrarlılık koşullarını sağlayıp sağlamadığı araştırılmaktadır (Solarin, 2019: 2880-81).

5. Bulgular

EYR'lerin 1990-2021 döneminde Türkiye'nin ekonomik büyümesi üzerindeki etkilerinin incelenmesinin amaçlandığı çalışmanın ampirik analizlerinin ilk aşamasında, BF-ARDL modellerindeki değişkenlerin önsel analizleri gerçekleştirilmekte ve bulguları Tablo 4'te sunulmaktadır.

⁹ Bu testlerin metodolojisi hakkında kapsamlı bilgi için sırasıyla bakınız: Becker vd., 2006; Enders & Lee, 2012; Christopoulos & León-Ledesma, 2010.

Tablo: 4
Değişkenlerin Önsel Analiz Bulguları

Değişken	Doğrusallık	Fourier			Normallik		
	HLX	F _i (k)	k	Jarque-Bera-JB	Çarpıklık	Baskılık	
RGDP	13.87 ^a [4.60]	10.77(0.000)	1.2	2.310(0.314)	0.176	1.731	
RGFI	6.68 ^b [4.60]	6.74(0.004)	1.5	3.097(0.212)	0.018	1.476	
EMP	29.41 ^a [4.60]	59.59(0.000)	1.5	3.210(0.200)	0.505	1.822	
TFP	1.65[4.60]	5.26(0.011)	2.3	0.065(0.967)	-0.032	2.788	
F-ZS	0.78[4.60]	25.50(0.000)	1.0	2.920(0.232)	0.210	1.581	
M-ZS	6.88 ^b [4.60]	33.57(0.000)	1.5	11.241 ^c (0.003)	1.395	3.798	
R-ZS	1.42[4.60]	6.77(0.000)	1.5	7.097 ^b (0.028)	1.044	3.980	
T-ZS	1.46[4.60]	6.29(0.000)	1.5	85.832 ^c (0.000)	2.787	8.770	
TP-ZS	8.34 ^a [4.60]	24.27(0.000)	1.4	11.742 ^c (0.002)	1.388	4.047	

Not: Tabloda HLX ve JB testi istatistiklerinin önündeki sembollerden "a" (%1), "b" (%5) ve "c" (%10) önem düzeyinde sırasıyla doğrusallık ve normallik temel hipotezlerinin reddedildiğini belirtmektedir. Tabloda "[]" parantezi içerisindeki değerler HLX testi için %10 önem düzeyindeki kritik tablo değerlerini ve "()" parantezi içerisindeki değerler F_i(k) ve JB testleri için olasılıkları göstermektedir.

Tablo 4'teki doğrusallık testi bulguları incelendiğinde, TFP, F-ZS, R-ZS ve T-ZS değişkenleri için doğrusallık temel hipotezlerinin % 10 önem düzeyinde bile reddedilemediği görülmektedir. RGDP, RGFI, EMP, M-ZS ve TP-ZS değişkenleri için ise doğrusallık temel hipotezlerinin farklı önem düzeylerinde reddedildiği Tablo 4'teki doğrusallık testi bulgularının incelenmesinden anlaşılabilir. HLX doğrusallık testi istatistiklerinin kritik tablo değerlerinden sırasıyla küçük ve büyük olmasıyla ulaşılan bu bulgular, BF-ARDL modellerindeki değişkenlerin durağanlığının doğrusal/doğrusal dışı dinamiklerini dikkate alan birim kök testleriyle incelenmesinin gerekli olduğunu göstermektedir. BF-ARDL modellerindeki değişkenlerin deterministik bileşenindeki kademeli yapısal kırılmaların anlamlılığını araştıran Tablo 4'teki Fourier (F) testi bulguları incelendiğinde, deterministik bileşenlerde trigonometrik terimlerin anlamlı olmadığını belirten temel hipotezlerin bütün değişkenler için %5 önem düzeyinde reddedildiği görülmektedir. F_i(k) test istatistiği olasılık değerlerinin 0.05'ten küçük olmasıyla ulaşılan bu bulgular, BF-ARDL modellerindeki değişkenlerin inceleme döneminde keskin veya yumuşak kırılmalara maruz kaldığını ve durağanlığının Fourier fonksiyonlu birim kök testleriyle incelenmesinin gerekliliğine işaret etmektedir. Tablo 4'teki normallik testi bulguları incelendiğinde ise RGDP, RGFI, EMP, TFP ve F-ZS değişkenleri için normallik temel hipotezlerinin 0.010 önem düzeyinde bile reddedilemediği görülmektedir. M-ZS, R-ZS, T-ZS ve TP-ZS değişkenleri için ise normallik temel hipotezlerinin farklı önem düzeylerinde olmakla birlikte reddedildiği normallik testi bulgularının incelenmesinden anlaşılabilir. Bu bulgular, örneklem döneminde BF-ARDL modellerindeki değişkenlerden ekonomik büyüme, fiziki-beşerî sermaye, teknolojik gelişmişlik düzeyi ile finansal EYR'lerin normal bir dağılıma sahip olduğunu belirtirken, mali, reel, ticari sektör ile toplam EYR'lerin normal bir dağılım sergilemediğini göstermektedir.

Ampirik analizlerin ikinci aşamasında, önsel testlerin ardından örneklem döneminde doğrusal veya doğrusal dışı dinamiklere sahip, kademeli yapısal kırılmalara maruz kaldığı belirlenen BF-ARDL modellerindeki değişkenlerin birim kök özellikleri doğrusal ve doğrusal olmayan fourier birim kök testleriyle incelenmekte bulguları Tablo 5'te sunulmaktadır.

Tablo: 5
Fourier Birim Kök Testleri Bulguları

CT	F-KPSS			F-ADF			F-KSS		
	Değişken	I(0)	I(1)	k(p)	I(0)	I(1)	k(p)	I(0)	I(1)
RGDP	0.074	0.036 ^a	1(0)[0.047]	-4.43 ^b	-	1(3)[-4.05]	-0.28	-3.38 ^c	1(2)[-3.26]
RGFI	0.073	0.043 ^a	1(0)[0.047]	-4.39 ^b	-	1(3)[-4.05]	-1.87	-4.49 ^a	1(0)[-3.26]
EMP	0.137	0.020 ^a	1(0)[0.047]	-0.72	-6.25 ^a	2(3)[-3.71]	-2.22	-3.43 ^c	1(3)[-3.26]
TFP	0.255	0.021 ^a	4(0)[0.118]	-2.86	-7.90 ^a	4(3)[-3.29]	-2.94	-4.46 ^a	2(0)[-2.96]
F-ZS	0.089	0.044 ^a	1(0)[0.047]	-2.55	-7.12 ^a	3(3)[-3.44]	-2.96	-5.38 ^a	1(1)[-3.26]
M-ZS	0.137	0.037 ^a	1(0)[0.047]	-1.61	-4.26 ^b	2(1)[-3.71]	-1.77	-3.38 ^c	1(1)[-3.26]
R-ZS	0.329	0.048 ^a	3(0)[0.114]	-1.72	-6.94 ^a	3(3)[-3.44]	-2.46	-4.45 ^a	3(0)[-2.75]
T-ZS	0.267	0.052 ^a	2(0)[0.103]	-2.24	-5.56 ^a	2(2)[-3.71]	-2.97	-5.44 ^a	1(0)[-3.26]
TP-ZS	0.124	0.039 ^a	1(0)[0.047]	-3.96	-5.49 ^a	1(4)[-4.05]	-2.23	-5.03 ^a	1(1)[-3.26]

Not: Tablodaki sütunlardan I(0) (seviye değerini), I(1)(birincil devresel farkı) ve "k(p)" AIC eşliğinde belirlenen optimal frekans sayısı ile gecikme uzunluklarını göstermektedir. Sabitli ve Trendli (CT) formda hesaplanan F-KPSS, F-ADF ve F-KSS testlerinde "[]" parantezi içerisindeki değerler %10 önem düzeyindeki kritik tablo değerlerini ve sembollerden "a" (%1), "b" (%5) ve "c" (%10) önem düzeyinde durağanlığı belirlemektedir.

Tablo 5'teki doğrusal F-KPSS ve F-ADF birim kök testlerinin bulguları incelendiğinde, RGDP ve RGFI değişkenlerinin seviye değerinde I(0) durağan oldukları ve diğer tüm değişkenlerin ise birinci farklarında I(1) durağanlaştıkları görülmektedir. Bu bulgulara RGDP ve RGFI değişkenleri için I(0) düzeyinde ve diğer tüm değişkenler için I(1) düzeyinde hesaplanan F-KPSS ile F-ADF test istatistiklerinin farklı önem düzeylerinde kritik tablo değerlerinden küçük olmasıyla ve F-KPSS (F-ADF) birim kök testinde durağanlık (birim kök) temel hipotezinin reddedilememesiyle (reddedilmesiyle) ulaşılmaktadır. Tablo 5'teki doğrusal olmayan F-KSS birim kök testinin bulguları incelendiğinde ise tüm değişkenlerin seviye değerinde I(0) durağan olmadığı ve birinci farklarında I(1) durağanlaştıkları görülmektedir. Bu bulgulara değişkenler için I(1) düzeyinde hesaplanan F-KSS test istatistiklerinin farklı önem düzeylerinde kritik tablo değerlerinden küçük olmasıyla ve birim kök temel hipotezinin reddedilememesiyle ulaşılmaktadır. Fourier birim kök testlerinin bulguları, tanımlı BF-ARDL modellerinin doğrusal ve doğrusal dışı dinamikler altında farklı derecelerde ve en fazla I(1) düzeyinde durağanlaşan değişkenlerden oluştuğunu ortaya koymaktadır.

Doğrusal ve doğrusal dışı dinamiklere sahip değişkenlerinin farklı derecelerde ve en fazla I(1) düzeyinde bütünlük olduklarının belirlenmesinin ardından diğer aşamaları takip edilerek tahmin edilen BF-ARDL modellerinin bulguları Tablo 6'da sunulmaktadır. BF-ARDL modellerinin kısa ve uzun dönemli katsayılarına ve sınır(F) ile tanısıl test istatistiklerine ilişkin bulguları Tablo 6'nın sırasıyla A, B ve C şeklindeki panellerinde gösterilmektedir: Panel C bulguları, tanımlı BF-ARDL modellerinin bağımlı (RGDP) ve bağımsız (RGFI, EMP, TFP ve EYR-ZS) değişkenleri için genelden özele yaklaşımı ve AIC bilgi kriteri eşliğindeki spesifikasyonlarla (maksimum 4 gecikmede) belirlenen sınır(F) ve tanısıl test istatistiklerini göstermektedir. Panel C'deki sınır(F) testi bulguları incelendiğinde, tanımlı bütün BF-ARDL modellerinin farklı derecelerden bütünlük olan değişkenlerinin eş-bütünlük olduğu görülmektedir. Bu bulgulara, tanımlı bütün BF-ARDL modelleri için Monte Carlo simülasyonlarıyla yinelemeli (1.000) hesaplanan (FA) ve (FB) sınır testi istatistiklerinin 0.010 önem düzeyinde kritik tablo değerlerinden büyük olmasıyla ve temel hipotezlerin reddedilmesiyle ulaşılmaktadır. Bu bulgular, tanımlı BF-ARDL

modellerinin değişkenlerinde örneklem döneminde meydana gelen kademeli yapısal kırılmalara rağmen eş-bütünleşme vektörlerinde yeniden bir denge ilişkisinin kurulabildiğini ve uzun dönemde değişkenlerinin birlikte hareket ettiklerini göstermektedir. Panel C bulgularında ayrıca, tanımlı BF-ARDL modelleri için tanımlama hatası (Ramsey Reset-RR), otokorelasyon (Lagrange Multiplier-LM), değişen varyans (Autoregressive Conditional Heteroscedasticity-ARCH), normallik (Jarque-Bera-JB), F ve R² şeklindeki tanısal test istatistikleri raporlanmaktadır. Panel C'deki bulgular tanısal test istatistikleri açısından incelendiğinde, tanımlı bütün BF-ARDL modellerinin açıklanma gücünü/anlamlılığını gösteren R² değerlerinin yüksek/F testi istatistikleri olasılık değerlerinin anlamlı olduğu ve tanısal açıdan istikrarlılık koşullarını büyük ölçüde karşıladıkları görülmektedir. Nitekim Panel C'deki bulgular incelendiğinde tanımlı bütün BF-ARDL modellerinde, tanımlama hatalarının, otokorelasyonun ve değişen varyansın bulunmadığı anlaşılabilmektedir.

Bu bulgulara RR, LM ve ARCH tanısal testleri için hesaplanan test istatistikleri olasılık değerlerinin 0.010'dan büyük olduğunun belirlenmesiyle ulaşılmaktadır. Buna karşılık Panel C'deki JB test istatistikleri incelendiğinde, tanımlı BF-ARDL modellerinde kalıntıların normal bir dağılım göstermediği (reel model hariç) görülmektedir. Bu bulgulara tanımlı BF-ARDL modelleri için hesaplanan JB test istatistikleri olasılık değerlerinin reel modelde 0.010'dan büyük olmasıyla ve diğer modellerde 0.010'dan küçük olmasıyla ulaşılabilmektedir. Uzun dönemde eş-bütünleşik ve tanısal istikrarlılık koşullarını büyük ölçüde karşılayarak güvenilir olduğu belirlenen BF-ARDL modellerinin, açıklayıcı değişkenleri için hesaplanan kısa ve uzun dönemli katsayılar ise Tablo 6'nın sırasıyla A ve B panellerinde sunulmaktadır.

Tablo: 6
BF-ARDL Modeli Bulguları

Katsayı Tahminleri	Finansal (1.1.2.1.0)		Mali (2.4.4.4.3)		Reel (2.0.2.2.0)		Ticari (2.4.4.4.3)		Toplam (1.0.1.1.0)	
	CE	SE	CE	SE	CE	SE	CE	SE	CE	SE
Panel A: Kısa Dönem										
RGDP _{t-1}	0.9867 ^a	0.0684 (0.000)	-1.7719 ^a	0.1469 (0.000)	-0.0605	0.2017 (0.767)	-1.4784 ^a	0.1544 (0.000)	0.8400 ^a	0.0392 (0.000)
RGDP _{t-2}	-	-	1.9069 ^b	0.1102 (0.000)	0.7753 ^a	0.1664 (0.000)	1.5842 ^a	0.1086 (0.000)	-	-
RGFI _{t-1}	-0.1279 ^b	0.0543 (0.030)	0.3246 ^a	0.0265 (0.000)	-	-	0.3219 ^a	0.0318 (0.000)	-	-
RGFI _{t-2}	-	-	-0.0247	0.0198 (0.280)	-	-	-0.0174	0.0264 (0.544)	-	-
RGFI _{t-3}	-	-	0.0304	0.0162 (0.134)	-	-	0.1025 ^b	0.0226 (0.010)	-	-
RGFI _{t-4}	-	-	-0.1031 ^a	0.0161 (0.003)	-	-	-0.1048 ^a	0.0167 (0.003)	-	-
EMP _{t-1}	-0.3323 ^a	0.1121 (0.008)	0.7977 ^a	0.0657 (0.000)	0.1354	0.1519 (0.385)	0.5178 ^a	0.0658 (0.001)	-0.4478 ^a	0.0864 (0.000)
EMP _{t-2}	-0.1424	0.1056 (0.194)	-0.3721 ^a	0.0373 (0.000)	-0.3136 ^a	0.1034 (0.007)	-0.3353 ^a	0.0427 (0.001)	-	-
EMP _{t-3}	-	-	-0.0411	0.0282 (0.217)	-	-	-0.0527	0.0366 (0.223)	-	-
EMP _{t-4}	-	-	0.2289 ^a	0.0392 (0.004)	-	-	0.3101 ^a	0.0544 (0.004)	-	-
TFP _{t-1}	-0.4958 ^a	0.1535 (0.004)	1.0490 ^a	0.1139 (0.000)	0.2841	0.2435 (0.259)	0.7068 ^a	0.1095 (0.003)	-0.8171 ^a	0.0732 (0.000)
TFP _{t-2}	-	-	-1.9090 ^a	0.1403 (0.000)	-0.8190 ^a	0.1718 (0.000)	-1.5841 ^a	0.1452 (0.000)	-	-

TFP_{t-3}	-	-	-0.2460 ^b	0.0566 (0.012)	-	-	-0.5094 ^a	0.0786 (0.002)	-	-	
TFP_{t-4}	-	-	0.4246 ^a	0.0434 (0.000)	-	-	0.4021 ^a	0.0523 (0.001)	-	-	
$EYRZ_{t-1}$	-	-	-0.0061 ^c	0.0025 (0.073)	-	-	0.0030 ^b	0.0009 (0.034)	-	-	
$EYRZ_{t-2}$	-	-	0.0017	0.0022 (0.471)	-	-	0.0053 ^a	0.0009 (0.005)	-	-	
$EYRZ_{t-3}$	-	-	0.0163 ^a	0.0016 (0.000)	-	-	0.0077 ^a	0.0009 (0.001)	-	-	
$EYRZ_{t-4}$	-	-	-	-	-	-	-	-	-	-	
Panel B: Uzun Dönem											
	CE.	SE.	CE.	SE.	CE.	SE.	CE.	SE.	CE.	SE.	
$RGFI$	0.1253 ^a	0.0341 (0.001)	0.1883 ^a	0.0164 (0.000)	0.1626 ^a	0.0286 (0.000)	0.1713 ^a	0.0176 (0.000)	0.0814 ^a	0.0196 (0.000)	
EMP	0.5436 ^a	0.0736 (0.000)	0.1757 ^c	0.0661 (0.056)	0.3314 ^a	0.0784 (0.000)	0.1838 ^b	0.0626 (0.042)	0.5791 ^a	0.0763 (0.000)	
TFP	0.7442 ^a	0.1395 (0.000)	0.5215 ^a	0.0473 (0.000)	0.5776 ^a	0.1118 (0.000)	0.5087 ^a	0.0527 (0.000)	0.9318 ^a	0.0826 (0.000)	
$EYRZS$	0.0049 ^b	0.0023 (0.049)	0.0099 ^a	0.0019 (0.007)	0.0052 ^b	0.0021 (0.036)	0.0020	0.0014 (0.216)	0.0056 ^b	0.0025 (0.038)	
C	0.2509 ^a	0.7842 (0.752)	10.6717 ^a	0.7862 (0.000)	3.2052 ^a	0.5915 (0.000)	10.4762 ^a	1.1080 (0.000)	1.9107 ^a	0.5118 (0.001)	
Panel C: Sınır ve Tanısal Test İstatistikleri											
FA	FB	41.77 ^a [19.38]	6.19 ^b [3.60]	43.19 ^a [17.62]	16.52 ^a [6.56]	28.48 ^a [13.05]	18.32 ^a [5.62]	39.75 ^b [20.67]	9.71 ^b [7.85]	43.47 ^b [30.10]	6.58 ^b [3.45]
R ²	F	0.99	(0.000)	0.99	(0.000)	0.99	(0.000)	0.99	(0.000)	0.99	(0.000)
RR	ARCH	0.436 (0.517)	1.80 (0.196)	0.023 (0.888)	0.961 (0.336)	1.786 (0.776)	1.976 (0.171)	0.391 (0.721)	1.418 (0.262)	0.866 (0.396)	1.235 (0.372)
LM	JB	2.311 (0.123)	10.433 (0.005)	3.136 (0.174)	6.053 (0.048)	0.014 (0.906)	0.371 (0.830)	1.180 (0.356)	9.431 (0.008)	1.829 (0.168)	12.929 (0.001)

Not: Tablodaki "CE" ve "SE" terimleri katsayıları ve standart hataları, "()" parantezi içerisindeki değerler ile "t" simgesi katsayıların olasılık değerlerini ve (t=0) olmak üzere AIC eşliğindeki spesifikasyonlarla belirlenen optimal gecikme düzenini göstermektedir. Tabloda "[]" parantezi içerisindeki değerler optimal frekans (k) sayısı (k=3) ve yinelemeli (1.000) olarak hesaplanan (FA) ve (FB) sınır testi istatistiklerine ait %10 önem düzeyindeki kritik tablo değerlerini belirlemektedir. Tablodaki sembollerden "a" (%1), "b" (%5) ve "c" (%10) önem düzeyinde katsayıların ve sınır testi istatistiklerinin anlamlılığı belirtilmektedir.

Panel A bulguları incelendiğinde, tanımlı BF-ARDL modellerinde RGDP, RGFI, EMP ve TFP değişkenlerine ait kısa dönemli katsayıların modellere ve gecikmelere göre değişen bir şekilde hesaplandığı görülmektedir. Nitekim Panel A'daki bulgular incelendiğinde, tanımlı BF-ARDL modellerinde RGDP, RGFI, EMP ve TFP değişkenlerinin gecikmeli değerlerine ait kısa dönemli katsayıların modellere göre pozitif/negatif yönlü ve istatistiki açıdan anlamlı/anlamsız olacak bir şekilde hesaplandığı anlaşılmaktadır. Bu bulgular, örneklem döneminde Türkiye'nin ekonomik büyümesi üzerinde fiziki-beşerî sermaye birikimi ile teknolojik gelişmişlik düzeyindeki artışların, kısa dönemde gecikmelere göre artırıcı veya azaltıcı etkiler meydana getirdiğini göstermektedir. Buna karşılık Panel A bulgularını incelendiğinde, EYR-ZS değişkenlerinin gecikmeli değerlerine ait kısa dönemli katsayıların tanımlı BF-ARDL modellerinden sadece mali ve ticari sektör EYR'lerinin ekonomik büyüme üzerindeki etkilerinin araştırıldığı modeller için hesaplanabildiği görülmektedir. Panel A'daki BF-ARDL modellerinin bulguları incelendiğinde, mali ve ticari sektör EYR değişkenlerine ait kısa dönemli katsayıların gecikmelere göre pozitif/negatif yönlü ve istatistiki açıdan anlamlı/anlamsız olacak bir şekilde hesaplandığı anlaşılmaktadır. Bu bulgular, örneklem döneminde Türkiye'nin ekonomik büyümesi üzerinde mali ve ticari sektör EYR'lerinin kısa dönemde etkili olduğunu göstermekte ve mali ve ticari sektör EYR'lerinin sayısındaki artışların kısa dönemde gecikmelere göre değişmekle birlikte genellikle artırıcı yönde etkiler meydana getirdiğini ortaya koymaktadır. Bulgular ayrıca, finansal ve reel sektör ile toplam EYR'lerin etkilerinin araştırıldığı BF-ARDL modellerinde değişkenler için AIC bilgi kriteri eşliğinde optimal olarak sıfır olduğu belirlenen gecikme

uzunluklarında Türkiye'nin ekonomik büyümesi üzerinde kısa dönemde herhangi bir etkiye sahip olmadığını göstermektedir.

Panel B bulguları incelendiğinde, tanımlı BF-ARDL modellerinde ekonomik büyümenin temel belirleyicisi niteliğindeki RGFI, EMP ve TFP değişkenlerine ait uzun dönemli katsayıların tüm modellerde beklentilerle uyumlu olarak pozitif yönlü ve istatistiki açıdan anlamlı olarak hesaplandıkları görülmektedir. Bu bulgular, örneklem döneminde fiziki-beşerî sermaye birikimi ile teknolojik gelişmişlik düzeyinde meydana gelen artışların, Türkiye'nin ekonomik büyümesi üzerinde uzun dönemde artırıcı bir etkiye sahip olduğunu göstermektedir. Bununla birlikte Panel B bulguları incelendiğinde, tanımlı bütün BF-ARDL modellerinde ekonomik büyümenin temel belirleyicisi niteliğindeki değişkenlerin pozitif/istatistiki açıdan anlamlı olan uzun dönemli katsayılarının fiziki sermaye değişkeni için (RGFI:0.0814/0.1883), beşerî sermaye değişkeni için (EMP:0.1757/0.5791) ve teknolojik gelişmişlik düzeyi değişkeni için (TFP:0.5087/0.9318) aralığında hesaplandığı görülmektedir. Bu bulgular, örneklem döneminde fiziki-beşerî sermaye birikimi ile teknolojik gelişmişlik düzeyinde meydana gelen birimlik (% l'lik) bir artışın uzun dönemde Türkiye'nin ekonomik büyümesi üzerinde sırasıyla yaklaşık (0.0814/0.1883), (0.1757/0.5791) ve (0.5087/0.9318) aralığında birimlik (% cinsinden) artışlar meydana getirdiğini göstermektedir. Panel B'deki bulgular RGFI, EMP ve TFP değişkenlerinin pozitif/istatistiki açıdan anlamlı katsayılarının büyüklüğü açısından incelendiğinde ise tanımlı bütün BF-ARDL modellerinde, Türkiye'nin ekonomik büyümesi üzerinde uzun dönemde en fazla etkili olan değişkenlerin sırasıyla TFP, EMP ve RGFI şeklinde oldukları görülmektedir. Bu bulgular, örneklem döneminde Türkiye'nin ekonomik büyümesinin, sırasıyla en fazla teknolojik gelişmişlik düzeyi ile beşerî sermaye birikiminden ve en az ise fiziksel sermaye birikiminden kaynaklandığını ortaya koymaktadır. Panel B bulguları araştırmanın özünü oluşturan ve ekonomik büyümenin muhtemel belirleyicisi niteliğindeki EYR değişkenleri açısından incelendiğinde ise EYR-ZS değişkenlerine ait uzun dönemli katsayıların tanımlı bütün BF-ARDL modellerinde beklentilerle uyumlu pozitif yönlü ve istatistiki açıdan anlamlı olarak (ticari model hariç) hesaplandıkları görülmektedir. Bu bulgular, örneklem döneminde finansal, mali ve reel sektörlerdeki ile toplam EYR'lerin sayısında meydana gelen artışların, Türkiye'nin ekonomik büyümesi üzerinde uzun dönemde artırıcı bir etkiye sahip olduğunu gösterirken, ticari sektördeki EYR'lerin Türkiye'nin ekonomik büyümesi üzerinde uzun dönemde anlamlı bir etkiye sahip olmadığını ortaya koymaktadır. Bununla birlikte Panel B bulguları incelendiğinde, tanımlı BF-ARDL modellerinde EYR-ZS değişkenlerinin pozitif/istatistiki açıdan anlamlı olan uzun dönemli katsayılarının finansal sektör EYR'lerinde (0.0049), mali sektör EYR'lerinde (0.0099), reel sektör EYR'lerinde (0.0052) ve toplam EYR'lerde (0.0056) şeklinde hesaplandığı görülmektedir. Bu bulgular, örneklem döneminde finansal, mali ve reel sektörlerdeki ile toplam EYR'lerin sayısında meydana gelen birimlik (% l'lik) bir artışın uzun dönemde Türkiye'nin ekonomik büyümesi üzerinde sırasıyla yaklaşık (0.0049), (0.0099), (0.0052) ve (0.0056) birimlik (% cinsinden) artışlar meydana getirdiğini göstermektedir. Panel B'deki bulgular EYR-ZS değişkenlerinin pozitif/istatistiki açıdan anlamlı katsayılarının büyüklüğü açısından incelendiğinde ise tanımlı bütün BF-ARDL

modellerinde, Türkiye'nin ekonomik büyümesi üzerinde uzun dönemde en fazla etkili olan değişkenlerin sırasıyla M-ZS, TP-ZS, R-ZS ve F-ZS şeklinde oldukları görülmektedir. Bu bulgular, örneklem döneminde Türkiye'nin ekonomik büyüme performansının sırasıyla en fazla mali ve reel sektör ile toplam EYR'lerden ve en az ise finansal sektör EYR'lerinden kaynaklandığını ortaya koymaktadır.

6. Sonuç ve Öneriler

Küresel ekonominin 2008 krizi sonrasındaki konjonktüründe, uluslararası kuruluşlar tarafından gelişmiş ve gelişmekte olan ülkelerde sürdürülebilir büyüme hızlarının yakalanabilmesinde EYR'lere atfedilen önem dikkate alınarak Türkiye üzerine yürütülen bu çalışmada, EYR'ler ve ekonomik büyüme üzerindeki muhtemel etkileri inceleme konusu yapılmaktadır. Bu kapsamda çalışmada, literatürde EYR'lerin tanımlanma ve ölçümlenme konusundaki gelişimi gözetilerek IMF-MONA programı eşliğinde Türkiye için sektörel EYR'lerin tanımlanması, 1990-2021 döneminde TCRG arşivinden ölçümlenmesi ve ekonomik büyüme üzerindeki etkilerinin BF-ARDL modeliyle incelenmesi amaçlanmaktadır. Bu amaçla birbiri üzerine inşa edilen iki temel aşamada gerçekleştirilen çalışmanın bulguları aşağıdaki gibi özetlenebilmektedir:

Çalışmanın ilk aşamasında IMF-MONA programındaki sınıflandırmaların referansında Türkiye için finansal, mali, reel ve ticari sektör EYR'leri tanımlanarak 1990-2021 döneminde TCRG arşivinden ve doğrudan gerçekleştirilen reform önerilerinin sayısal verileri üzerinden ölçümlenmiştir. Bu aşamada, IMF-MONA programındaki sınıflandırmalar eşliğinde Türkiye'de 1990-2021 döneminde 22 finansal, 40 mali, 39 reel ve 1 ticari olmak üzere toplam 102 adet EYR önerisinin gerçekleştirildiği belirlenmiştir. Ayrıca, 1990-2021 döneminde gerçekleştirilen 102 adet EYR önerisinden 45'inin, IMF-MONA programına dahil olunan 1992-2008 döneminde ilgili sektörlerde Türkiye'ye özgü olarak önerilen ve süreç içerisinde gerçekleştirilen EYR önerilerinden oluştuğu tespit edilmiştir. Finansal, mali reel ve ticari sektörlerdeki EYR'lerin ölçülmesinin ardından ikinci aşamada, EYR verileri Z-Skoru yaklaşımıyla normalize edilerek endeks biçimindeki göstergelere dönüştürülmüş ve genişletilmiş Cobb-Douglas (CD) üretim fonksiyonuna dayalı olarak Türkiye'nin ekonomik büyümesi üzerindeki uzun dönemli etkileri BF-ARDL modeliyle incelenmiştir. Bu aşamada, genişletilmiş CD üretim fonksiyonunda ekonomik büyümenin temel belirleyicileri olarak tanımlanan fiziki sermaye, beşerî sermaye ve teknolojik gelişmişlik düzeyi değişkenlerinin bütün modellerde Türkiye'nin büyümesi üzerinde pozitif ve istatistiki açıdan anlamlı etkilere sahip oldukları belirlenmiştir. Teorik açıdan genişletilmiş CD üretim fonksiyonunun beklentileriyle örtüşen bu bulgular, örneklem döneminde fiziki-beşerî sermaye birikimi ile teknolojik gelişmişlik düzeyinde meydana gelen artışların, Türkiye'nin ekonomik büyümesi üzerinde uzun dönemde artırıcı etkilere sahip olduğunu göstermektedir. Genişletilmiş CD üretim fonksiyonunda ekonomik büyümenin muhtemel belirleyicileri olarak tanımlanan değişkenlerinden finansal, mali, reel sektör ile toplam EYR'lerin Türkiye'nin büyümesi üzerinde pozitif ve istatistiki açıdan anlamlı etkilere sahip oldukları belirlenmiştir. Ampirik açıdan Ostry vd. (2009), Prati vd. (2013), Marrazzo ve Terzi (2017) çalışmalarıyla uyumlu bu bulgular, örneklem döneminde

finansal, mali, reel sektörlerdeki ile toplam EYR'lerin sayısında meydana gelen artışların, Türkiye'nin ekonomik büyümesi üzerinde uzun dönemde artırıcı etkilere sahip olduğunu göstermektedir. Buna karşılık ticari sektör EYR'lerinin ise Türkiye'nin büyümesi üzerinde pozitif ve/fakat istatistiki açıdan anlamlı bir etkiye sahip olmadığı belirlenmiştir. Örneklem döneminde Türkiye'de gerçekleştirilen ticari sektör EYR'lerinin sayısının azlığından ve/ya büyümeyi gerektiğince kanalize edememesinden kaynaklanabilecek bu durum, ampirik açıdan Christiansen vd. (2013), Brancaccio vd. (2018) ve Haan ve Wiese (2022) çalışmalarıyla da örtüşmektedir.

Bu bulgular, örneklem döneminde Türkiye'de gerçekleştirilen EYR'lerin ekonomik büyümeyi desteklediğini göstermekte ve güçlendirilerek sürdürülebilmesinde önemli bir potansiyele sahip olduğuna işaret etmektedir. Bu kapsamda, Türkiye'de politika yapıcılar tarafından ekonomik sistemin arz-talep yapısından kaynaklı sorunların doğru bir şekilde belirlenebilmesi ve kapsamlı iyileştirmeleri içeren reform programlarıyla düzenlenmesi gereklilik arz etmektedir. Bu amaçla, Türkiye'de ekonomik sistemi oluşturan sektörlerin kurumsal yapısındaki zayıflıkların ve piyasaların işleyişindeki aksaklıkların ihtiyaçları önceliklendiren bir planlama dahilinde çözümlenmesini hedefleyen reform programlarının tasarlanması ve düzenli bir şekilde uygulanması gerekmektedir. Ekonomik büyüme üzerindeki etkileri gözetilerek bu türden reform programlarının tasarımı ve uygulanmasında, IMF-MONA programı kapsamında Türkiye'nin birikimlerinden ve gelişmiş ve gelişmekte olan ülkeler için sektörel düzeyde önerilen EYR örneklerinden azami ölçüde faydalanılmasının önemli olduğu değerlendirilmektedir. Ekonomik sistemin işleyişine yönelik bu türden reform programlarının öngörülen etkilerinin güçlendirilip kalıcı hale getirilebilmesi için ise eğitim, sağlık, hukuk, siyasal vb., diğer alanlardaki reform programlarıyla da desteklenmesi önem arz etmektedir. Diğer yandan bu reform sürecinin küresel ekonomik gelişmeler ile uluslararası kuruluşların yönlendirmesine olan bağımlılığının azaltılması ve ekonomik sistemin arz-talep yapısından kaynaklı muhtemel bütün sorunların çözümlenebilmesine kadar kararlılıkla sürdürülmesi gerekmektedir. Reform sürecinin sürekliliğinin sağlanmasıyla ekonomik sistemin içsel-dışsal şoklar karşısındaki direnç düzeyinin artırılması ve böylece Türkiye'de ekonomik büyümeyi desteklemenin yanında güçlendirerek sürdürülebilirliğini sağlaması (büyümenin diğer potansiyel belirleyicileri sabitken) güçlü bir olasılık olarak görünmektedir. Türkiye'de yakın gelecekte yapılacak çalışmalarda, endeks biçimindeki göstergeler kullanılarak ekonomik yapısal reformların teorik açıdan mikro-makro düzeyde ilişkili olduğu diğer değişkenler arasındaki ilişkilerin ampirik açıdan sınanmasının, ilgili literatürün gelişimine ve kamu kesimi politikalarının tasarımına katkı sağlayabileceği değerlendirilmektedir. Diğer yandan, yapısal reformlar ekonomi, eğitim, sağlık, hukuk, siyasal vb., boyutları olan geniş kapsamlı bir kavram olmasına rağmen, bu çalışmada belirli bir metodoloji ile salt ekonomik boyutta sınırlandırılmaktadır. Türkiye'de yapısal reformların bu çalışmanın sınırlarının dışında kalan boyutlarını konu edinen ve belirli bir metodoloji ile ölçülmesine yönelik çalışmaların yapılmasının, önemli bir boşluğu doldurabileceği ve politika yapıcılarının yönlendirmesi bakımından önemli bilgiler sunabileceği değerlendirilmektedir.

Kaynaklar

- Abed, G.T. & H.R. Davoodi (2000), "Corruption, Structural Reforms, and Economic Performance in the Transition Economics", *IMF Working Paper*, 00/132.
- Aksoy, T. (2019), "Structural Reforms and Growth in Developing Countries", *Journal of Economic Policy Reform*, 22(4), 325-350.
- Al-Thaqeb, S.A. & B.G. Algharabali (2019), "Economic Policy Uncertainty: A Literature Review", *The Journal of Economic Asymmetries*, 20, e00133.
- Anderson, D. et al. (2014), "Fiscal consolidation in the euro area: How much pain can structural reforms ease?", *Journal of Policy Modeling*, 36(5), 785-799.
- Becker, R. et al. (2006), "A stationarity test in the presence of an unknown number of smooth breaks", *Journal of Time Series Analysis*, 27(3), 381-409.
- Bouis, R. et al. (2012), "The Short-Term Effects of Structural Reforms", OECD Economics Department *Working Papers* No: 949, 2-62.
- Brancaccio, E. et al. (2018), "Structural Labour Market Reforms, GDP Growth and the Functional Distribution of Income", *Structural Change and Economic Dynamics*, 44, 34-45.
- Campos, N.F. & R. Horváth (2012), "Reform redux: Measurement, determinants and growth implications", *European Journal of Political Economy*, 28(2), 227-237.
- Chinn, M. et al. (2018), "Impact of uncertainty shocks on the global economy", *Journal of International Money and Finance*, 88, 209-211.
- Christiansen, L. et al. (2013), "Growth and Structural Reforms: A New Assessment", *Journal of International Economics*, 89, 347-356.
- Christopoulos, D.K. & M.A. León-Ledesma (2010), "Smooth Breaks and Non-linear Mean Reversion: Post-Bretton Woods Real Exchange Rates", *Journal of International Money and Finance*, 29(6), 1076-1093.
- Correa, R. (2002), "Structural Reforms and Economic Growth in Latin America: a Sensitivity Analysis", *CEPAL Review*, 76, 87-104.
- Cuestas, J.C. & D. Garratt (2011), "Is Real GDP Per Capita a Stationary Process? Smooth Transitions, Nonlinear Trends and Unit Root Testing", *Empirical Economics*, 41, 555-563.
- Daştan, M. vd. (2020), "Yapısal Reformların Ekonomik Büyüme Üzerindeki Etkileri: Geçiş Ekonomilerinden Kamtlar", *Maliye Dergisi*, 179, 1-32.
- de Almeida, L.A. & V. Balasundharam (2018), "On the impact of structural reforms on output and employment: Evidence from a cross-country firm-level analysis", *IMF, WP/18/73*.
- de Haan, J. & R. Wiese (2022), "The Impact of Product and Labour Market Reform on Growth: Evidence for OECD Countries Based on Local Projections", *Journal of Applied Econometrics*, 37, 746-770.
- Easterly, W. et al. (1996), "Has Latin America's Post-Reform Growth Been Disappointing?", *The World Bank Policy Research Working Paper Series*, 1708.
- Enders, W. & J. Lee (2012), "The flexible Fourier form and Dickey-Fuller type unit root tests", *Economics Letters*, 117(1), 196-199.
- Escaith, H. & S. Morley (2000), *The Impact of Structural Reforms on Growth in Latin America and the Caribbean: An Empirical Estimation*, CEPAL Macroeconomia No: 1.

- Falchetti, E. et al. (2006), "Reforms and Growth in Transition: Re-Examining The Evidence", *Journal of Comparative Economics*, 34, 421-445.
- Fischer, K. & A. Stiglbauer (2018), "Structural reforms for higher productivity and growth", *Monetary Policy and the Economy*, Q2/18, 132-152.
- Greenaway, D. et al. (2002), "Trade Liberalisation and Growth in Developing Countries", *Journal of Development Economics*, 67, 229-244.
- Harvey, D.I. et al. (2008), "A Powerful Test for Linearity When the Order of Integration is Unknown", *Studies in Nonlinear Dynamics and Econometrics*, 12(3), 1-22.
- IMF (2015), "Structural Reforms and Macroeconomic Performance: Initial Considerations for The Fund", International Monetary Fund *Policy Papers*, <<http://www.imf.org>>, 23.08.2022.
- IMF (2020), "World Economic Outlook: A Long and Difficult Ascent", International Monetary Fund *Policy Papers*, <<https://www.imf.org>>, 23.08.2022.
- IMF (2023), "World Economic Outlook Update: Inflation Peaking amid Low Growth", International Monetary Fund *Policy Papers*, <<https://www.imf.org>>, 23.08.2022.
- IMF-MONA (2022), *Monitoring of Fund Arrangements (MONA) Database*, <<https://www.imf.org>>, 23.08.2022.
- Kouamé, W.A. & S.J.A. Tapsoba (2019), "Structural reforms and firms' productivity: evidence from developing countries", *World Development*, 113, 157-171.
- Li, F. et al. (2022), "The relationship between health expenditure, CO2 emissions, and economic growth in the BRICS countries based on the Fourier ARDL model", *Environmental Science and Pollution Research*, 1-20.
- Lin, J.Y. & Z. Liu (2000), "Fiscal Decentralization and Economic Growth in China", *Economic Development and Cultural Change*, 49(1), 1-21.
- Loayza, N.V. et al. (2005), *Regulation and macroeconomic performance*, Washington, DC: World Bank.
- Lora, E. & F. Barrera (1997), "A Decade of Structural Reform in Latin America: Growth, Productivity, and Investment are not What They Used to Be", Inter American Development Bank Office *Working Paper*, Green Series No: 350.
- Marrazzo, P.M. & A. Terzi (2017), "Structural reform waves and economic growth", European Central Bank *Working Paper*, No: 2111.
- McNown, R. et al. (2018), "Bootstrapping the autoregressive distributed lag test for cointegration", *Appl. Econ.*, 50(13), 1509-1521.
- Nardo, M. et al. (2005), "Handbook on constructing composite indicators: Methodology and user guide", OECD *Statistics Working Papers*, No. 2005/03.
- Ostry, J.D. et al. (2009), "Structural reforms and economic performance in advanced and developing countries", IMF *Occasional Paper* No: 268.
- Ostry, J.D. et al. (2021), "Growth-equity trade-offs in structural reforms", *Scottish Journal of Political Economy*, 68(2), 209-237.
- Ozgun, O. et al. (2022), "Nuclear energy consumption and CO2 emissions in India: Evidence from Fourier ARDL bounds test approach", *Nuclear Engineering and Technology*, 54(5), 1657-1663.

- Perron, P. (1989), "The Great Crash, The Oil Price Shock, and The Unit Root Hypothesis", *Econometrica*, 57(6), 361-1401.
- Pesaran, M.H. et al. (2001), "Bounds testing approaches to the analysis of level relationships", *Journal of Applied Econometrics*, 16(3), 289-326.
- Prati, A. et al. (2013), "Which Reforms Work Under What Institutional Environment? Evidence from A New Data Set on Structural Reforms", *The Review of Economics and Statistics*, 95(3), 946-968.
- Romer, P.M. (1986), "Increasing Returns and Long-Run Growth", *The Journal of Political Economy*, 1994(5), 1002-1037.
- Sala-i-Martin, X.X. (1997), "I Just Ran Two Million Regressions", *The American Economic Review*, 87(2), 178-183.
- Sertić, M.B. et al. (2015), "Impact of Labour Market Reforms on Economic Activity in European Union: Short Term Costs and Long Term Benefits", *Financial Theory and Practice*, 39(1), 83-107.
- Solarin, S.A. (2019), "Modelling the relationship between financing by Islamic banking system and environmental quality: evidence from bootstrap autoregressive distributive lag with Fourier terms", *Qual. Quantity*, 53(6), 2867-2884.
- Solow, R.M. (1956), "A Contribution to the Theory of Economic Growth", *The Quarterly Journal of Economics*, 70(1), 65-94.
- Staehr, K. (2003), "Reforms and economic growth in transition economies: Complementarity, sequencing and speed", Institute for Economies in Transition BOFIT, *Discussion Papers*.
- Swaroop, V. (2016), "World Bank's experience with structural reforms for growth and development", World Bank, MFM Discussion Paper No: 11.
- Swiston, M.A. & M.L. Barrot (2011), *The role of structural reforms in raising economic growth in Central America*, International Monetary Fund, WP/11/248.
- TCMB (2016), "Yapısal Reformlar ve Büyüme Üzerindeki Etkileri", *Türkiye Cumhuriyet Merkez Bankası Raporları*, 978-605-491.
- Yalçinkaya, Ö. et al. (2021), "The Impact of Structural Reforms on Economic Growth in Turkey: Evidence from Linear and Nonlinear ARDL Modeling", *Estudios de Economía*, 48(1), 59-87.
- Yilanci, V. et al. (2020), "Are BRICS countries pollution havens? Evidence from a Bootstrap ARDL Bounds testing approach with a Fourier function", *Sustain. Cities Soc.*, 55, 102035.
- Yu, J.S. et al. (2014), "Financial Sectors Reform and Economic Growth in Morocco: An Empirical Analysis", *Journal of Emerging Market Finance*, 13(1), 69-102.

Ek Şekil: 1
Türkiye'nin Ekonomik Yapısal Reform Endekslerinin (EYR-ZS) Gelişim Seyri (1990-2021)

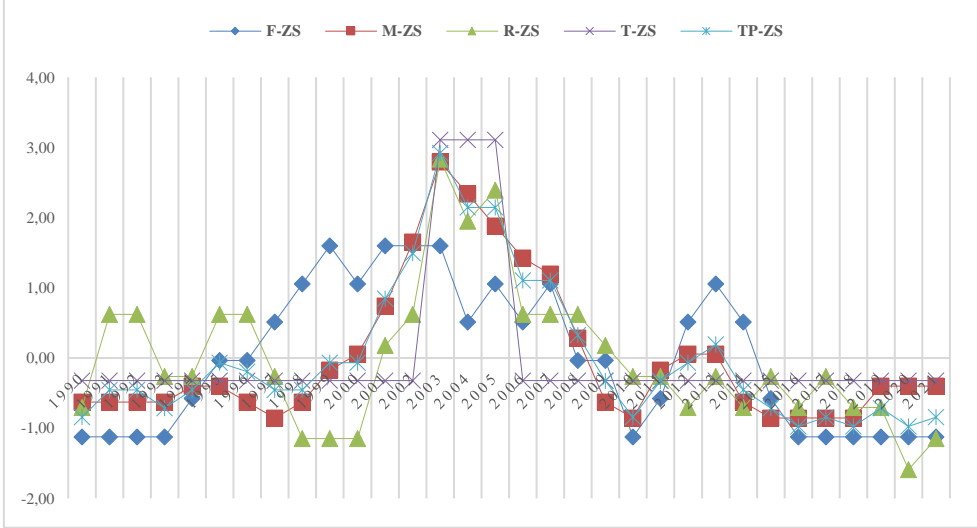

Türk Sivil Havacılığı Endüstrisinin Etkinliği ile Endüstri Yoğunlaşması Arasındaki İlişkinin İncelenmesi

Murat Ahmet DOĞAN (<https://orcid.org/0000-0002-4646-616X>), Samsun University, Türkiye;
muratahmet.dogan@samsun.edu.tr

Cankut AYDIN (<https://orcid.org/0000-0002-2441-465X>), Directorate General of Civil Aviation, Türkiye;
cankut.aydin@shgm.gov.tr

Analysing The Relationship Between the Efficiency of the Turkish Civil Aviation Industry and Industry Concentration

Abstract

This study uses absolute market concentration (CR_N) and relative market concentration (HHI) in three different categories for the first time to quantitatively analyse the degree of competition and concentration of Turkish civil aviation transport between 2012 and 2022. The production efficiency is calculated by the DEA method. Finally, these two factors are empirically tested by using a cointegration test. The relationship between production efficiency and market concentration in the Turkish civil aviation industry is unstable in the long run during this period. To accelerate the development of the industry and transform its efficiency into a stable structure, it could be beneficial to deepen the studies on international markets.

Keywords : Civil Aviation, Aviation Management, Market Concentration, Productivity Efficiency.

JEL Classification Codes : F12, R11, O14, L93.

Öz

Bu çalışmada, 2012-2022 yılları arasında Türk sivil havacılık taşımacılığının rekabet ve yoğunlaşma derecesini niceliksel olarak analiz etmek için ilk defa üç farklı kategoride mutlak piyasa yoğunlaşması (CR_N) ve görel piyasa yoğunlaşması (HHI) kullanılmaktadır. Endüstrinin üretim etkinliği VZA yöntemiyle hesaplanmaktadır. Son olarak, eş bütünleşme testi kullanarak bu iki faktör arasındaki ilişki ampirik olarak test edilmektedir. Elde edilen sonuçlar dikkate alındığında, Türk sivil havacılık taşımacılığı endüstrisindeki üretim etkinliği ile piyasa yoğunlaşması arasındaki ilişkinin inceleme dönemi içerisinde uzun vadede istikrarsız olduğunu göstermektedir. Endüstrinin gelişimini ivmелendirmek ve etkinliğini istikrarlı bir yapıya dönüştürmek için uluslararası pazarlar üzerine çalışmaların derinleştirilmesinin faydalı olacağı değerlendirilmektedir.

Anahtar Sözcükler : Sivil Havacılık, Havacılık Yönetimi, Piyasa Yoğunlaşması, Üretim Etkinliği.

1. Giriş

Endüstri yapısını incelemek ve buna göre stratejiler oluşturmak iktisat alanında yoğun olarak incelenmektedir. Marshall ve Sraffa'dan etkilenen Chamberlin ve Robinson, daha önce birbirinden ayrı ele alınan monopol ve tam rekabet teorilerini bir araya getirerek, monopolcü rekabet ve oligopol olarak ikiye ayrılabilir eksik rekabet teorisini formüle etmişlerdir (Lipczynsky et al., 2017). Neoklasik teori çerçevesinde rekabet yapısının farklı endüstrilerde incelenmesi giderek artmıştır. Eksik rekabet yapısında olan endüstrilerde, özellikle oligopol yapı, genellikle önemli kayıplara yol açabilen güçlü fiyat rekabetinden, firmaların fiyatları ve çıktı seviyeleri ile ilgili ortak kararlar aldıkları gizli anlaşmalara kadar çeşitlilik gösterebilmektedir (Moss, 1984). Buna karşılık, Schumpeter ve Avusturya Okulu iktisatçıları bu görüşe karşı çıkararak monopol gücün tüketiciler aleyhine negatif etkilerinin olabileceğine dair bir kanıt bulunmadığını ifade etmişlerdir (Young et al., 1996). Bu çerçevede, gelişimini sürdüren endüstriyel ekonomiye büyük katkıları Mason ve Bain sağlamışlardır (Mason, 1939, 1948; Bain, 1951; Bain, 1956). Bu çalışmalarla Yapı-Davranış-Performans (Structure-Conduct-Performance) analiz yaklaşımı geliştirilmiştir. Bu yaklaşıma göre bir piyasanın yapısı, piyasada faaliyet gösteren işletmelerin davranışlarını etkilemekte ve bu da söz konusu işletmelerin performansını etkileyebilmektedir (Caves, 2007).

Sivil havacılık endüstrisinin Amerika, Avrupa, Afrika ve Ortadoğu bölgelerindeki yapısı incelendiğinde kamu otoritesinin bir kural yapıcı rolü üstlenerek, havayolu işletmeleri kurabildiği gibi yeterlilikleri sağlayan girişimcilerin havayolu taşımacılığı yapabilmesine olanak sağladığı görülmektedir. Asya'da Çin haricindeki bölgelerde benzer yapı görülmesine karşılık Çin hava taşımacılığı sektöründe idari tekelleşmenin de söz konusu olduğu ifade edilmektedir (Schneider, 2009; Yu & Zhang, 2013). Buna ek olarak, hava taşımacılığında gerçekleştirilen yasal düzenlemeler ve teknolojik gelişmelerle hava taşımacılığı küresel ölçekte hem bireysel hem de kurumsal kazanımlar sağlamaktadır. Yasal düzenlemeler bu endüstride serbestleşme süreçleri olarak ele alınmakta olup, serbestleşme sürecini uygulamaya başlayan her ülkeye farklı kazanımlar sağladığı da gözlemlenmektedir (Doğan & Doğan, 2023).

Bu çalışma, ifade edilen teorik yapı ve yapısal farklılık çerçevesinde, ulaşım modülleri arasında daha kısa seyahat süreleriyle noktalar arasında ulaşım imkânı sunan ve Türkiye'nin rekabet üstünlüğünü artırdığı hava taşımacılığı endüstrinin piyasa yapısını incelemeyi amaçlamaktadır. Bu çerçevede, çalışmanın araştırma problemi "Türk sivil hava taşımacılığı endüstrisinin yoğunlaşma düzeyi ile Türkiye'de faaliyette bulunan havayolu işletmelerinin etkinlikleri arasındaki etkileşiminin yönü nedir?" olarak belirlenmiştir. Bu kapsamda, gelişen Türk sivil havacılık endüstrisinin yoğunlaşma seviyesi teorik ve alan yazındaki çalışmalar çerçevesinde ve yine alan yazında yoğun olarak tercih edilen endekslerle belirlenmektedir. Sivil havacılığın üretim etkinliği Veri Zarflama Analizi (VZA) ile hesaplanmaktadır. Hesaplanan endekslerin üretim etkinliği ile ilişkisinin testi içinde Eş Bütünleşme Testi kullanılmaktadır. Son aşamadaki analizde, hem ulusal hem de uluslararası çalışmalarda yoğunlaşma ile etkinlik arasındaki negatif ilişkinin vurgusu yapılarak durum

test edilmektedir (Kıracı et al., 2017; Dai et al., 2019). Son olarak, elde edilen sonuçlarla birlikte ve havacılık yönetimi kapsamında endüstri yapımcıları ve işletmeleri için öneriler sunulmaktadır.

2. Türk Sivil Havacılık Endüstrisinin Gelişimi

Türk sivil havacılığı da kazanımlar elde ederek hava taşımacılığının hem iç hatlarda hem de dış hatlarda gelişimini sürdürmektedir. Şekil 1 ve Şekil 2’de görüleceği üzere uçak ve taşınan yolcu sayıları olarak gelişim 20 yıldır pandemi süreci haricinde istikrarlı olarak devam etmektedir. Dış hatlardaki gelişimin, uluslararası sosyoekonomik durumlara daha hassas olduğundan dönemsel olumsuz etkilenmeleri söz konusu olsa da ana akım artış trendi sürdürülmektedir. Şekil 3’te yurtiçi (iç hat) ve yurtdışı (dış hat) yolcu taşıma oranları görülmektedir. Ülkenin ekonomik seviyesi geliştikçe iç hat taşımacılığının güçlendiği gözlemlenmektedir. Dış hat paylarında azalan ana trend pandemi sürecinden sonra yükselişe geçmiştir. Bu gelişime uçuş noktalarının (havalimanlarının) artışı katkı sağlamaktadır. Şekil 4’te 2001 yılında aktif olan ve hava taşımacılığına imkân sağlayan 37 şehir sayısı yatırımlarla gelişim göstererek Şekil 5’te görüleceği üzere 50’ye yükselmiştir.

Şekil: 1
Türk Sivil Havacılığı Uçak Trafik Gelişimi

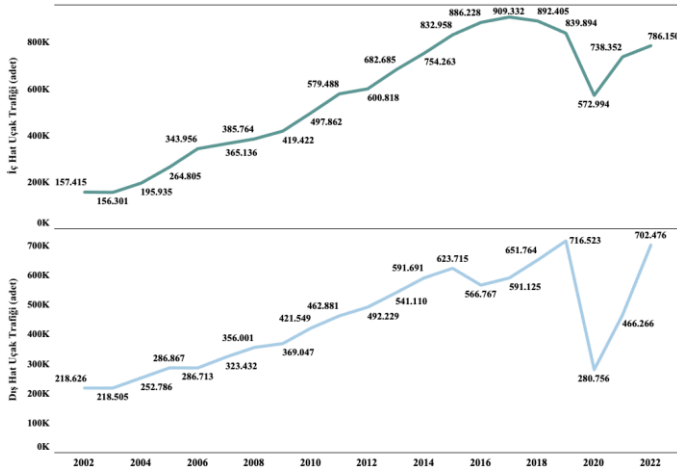

Şekil: 2
Türk Sivil Havacılığı Taşınan Yolcu Sayısı Gelişimi

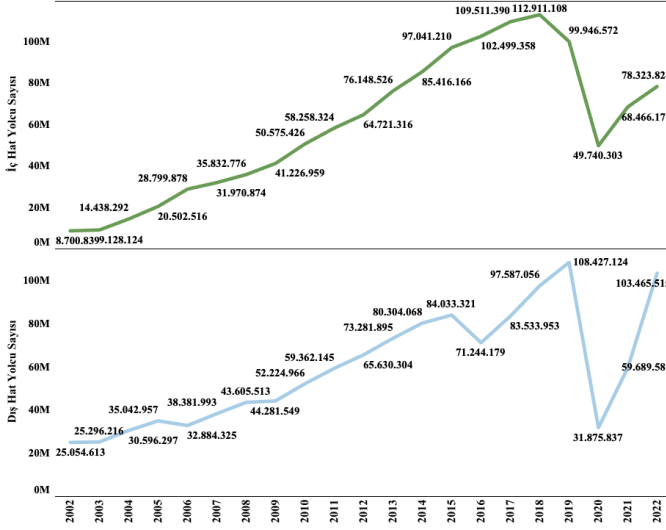

Şekil: 3
Türk Sivil Havacılığı İç ve Dış Hat Yolcu Taşıma Payları Değişimi

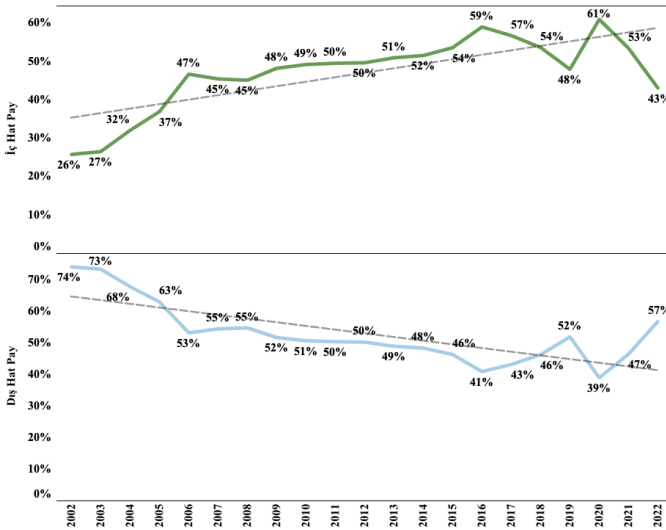

Şekil:4
2001 Yılı Faaliyette Olan Havalimanları Şehirleri

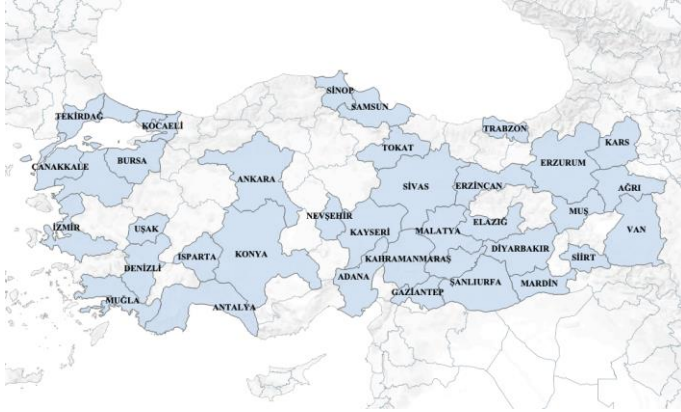

Şekil: 5
2022 Yılı Faaliyette Olan Havalimanları Şehirleri



3. Literatür

Ekonomide, tam rekabet koşullarının sağlanmasıyla endüstri davranışlarının diğer endüstri davranışlarıyla değerlendirilebileceği bir ölçüt sağlanmaktadır (Carlton & Perloff, 2005). Ancak, her endüstride tam rekabet koşullarını sağlayacak yapının var olmaması ve iki temel özelliğin işletmelerce sahip olunması da endüstri yapısını olumsuz etkilemektedir. Bu temel özelliklerin ilki, devlet tarafından işletmelere sağlanan imtiyazlarla elde edilen yasal pazar gücüdür. İkincisi de, bir işletmenin kendisinin endüstride oluşturduğu doğal pazar gücü olarak tanımlanmaktadır (Acemoglu et al., 2019). Endüstrilerin, bu özellikler kapsamında tam rekabet ve eksik rekabet piyasaları içerisinde yer aldıkları değerlendirilmektedir. Buna ek olarak, endüstriler tam rekabet piyasası koşullarına

yaklaştıkça etkinliklerinin de artacağı mikroekonomide teorik olarak kabul edilmektedir (Cabral, 2017). Bu sebeple, etkinlik kavramı mikroekonomi alanında tahsis, üretim ve dinamik etkinlikler olarak incelenmektedir (Ginevičius & Čirba, 2007; Çelik & Kaplan, 2010; Günalp, 2011; Van Reenen, 2011; Ildırar & Kırıl, 2018; Saridoğan, 2021; Rodríguez-Castelán et al., 2023).

Holmes ve Schmitz Jr (2010) bu kapsamda Amerikan endüstrilerinde rekabet ve verimlilik üzerine yapılan çalışmaları değerlendirmişlerdir. Yapılan çalışma sonucunda rekabetin artışıyla verimliliğin arttığını ve yüksek pazar gücüne sahip olabilecek işletmelerin endüstride bu güce sahip olmaktan kaçındıklarını ifade etmişlerdir. Bu durum monopol gücün elde edildiği bir endüstride yatırımı ve inovasyonu kötü etkilemenin nedeni olarak gösterilmiştir. Bu yapıda oluşan bir endüstride girdi tedarikçilerinin gücünü artıracığı ifade edilmiş olup, Porter vd. (2011) tarafından beş güç modelinde belirttiği gibi bir tehdit durumu söz konusu olmaktadır. Bu çerçevede, bu bölümde hava taşımacılığı endüstrisinde piyasa yapısı ile etkinlik ile ilgili yapılan çalışmalar derlenmiştir.

Pustay (1999) çalışmasında Kanada ve Amerika arasındaki hatlardaki rekabet yoğunluğunu 1995-1998 yılları arasında HHI endeksini kullanarak analiz etmiştir. Toronto ve Vancouver havalimanları çıkışlı Amerika uçuşlarında yapılan analizde talebin yoğun olduğu hatlara yeni işletme girişleriyle rekabet düzeyinin az bir seviyede iyileşerek genel HHI endeks skorlarının monopol yapıdan uzaklaştığı tespit edilmiştir.

Lijesen vd. (2001) Avrupa merkezli havayollarının rekabetini hem Avrupa hem de Avrupa dışı pazarlar için incelemiştir. HHI endeksini, ücret ve mesafe verilerini de kullanarak regresyon analizi gerçekleştirmiştir. Çalışma sonuçları, Avrupa'da da Amerika'da olduğu gibi merkez pazarların aktarmasız seferler sağlaması sebebiyle rekabeti etkilediği ve bunun bilet fiyatlarına yansıtıldığı ifade edilmektedir. Lijesen vd. (2002) bir önceki çalışmalarındaki gibi Amerika ve Avrupa odaklı bir rekabet analizi gerçekleştirmişlerdir. Bu çalışmalarında CR₄ ve HHI indekslerini Paris-New York ve Londra-New York pazar çiftlerinde uçuş imkânı sunan havayolları bazında oluşturulan beş farklı senaryo ile incelemiştir. Çalışma sonucunda rekabet analizlerinde CR_N ve HHI gibi endekslerin kullanımının faydalı olduğu ifade edilmekte olup, analizin daha güçlendirilmesi için ek göstergelerin de kullanılmasının gerekliliği de belirtilmektedir. Son olarak, ağ taşıyıcısı konumunda olan havayollarının rekabet analizlerinde sadece pazar çifti kullanımının uçuş ağlarının havayollarının rekabet güçlerine olan etkisini tam olarak göstermediği vurgulanmıştır. Lijesen (2004) önceki çalışmalarda kullandığı yöntemi geliştirerek Avrupa'daki uluslararası pazar çiftlerinde HHI endeksinin kalite ve maliyete duyarlı olan düzeltilmiş endeksini kullanarak regresyon analizi gerçekleştirmiştir. Elde edilen sonuçların düzeltilmiş endekte daha tutarlı olduğu vurgulanmış olup, her pazar çiftine göre düzeltme parametrelerinin değişmesinin uygun olacağını söylemiştir. Lijesen ve Behrens (2017) son çalışmalarında İngiltere ve Avrupa kıtası havayolları arasında pazar çiftlerinde rekabet analizi gerçekleştirmişlerdir. Aylık operasyonel verilerle birlikte HHI endeksiyle iki aşamalı kukla değişkenli regresyon analizi uygulamışlardır. Pazar çifti

piyasalarının büyük çoğunluğunun simetrik Cournot duopolünden daha az rekabetçi olduğunu göstermiş olup, HHI endeks sonuçlarının tutarlı olduğunu belirtmişlerdir.

Carlsson (2002) çalışmasında Avrupa'nın 172 pazar çiftinde pazar yapısının bilet ücretlerine ve uçuş sıklıklarına etkisini adresleme yöntemini kullanarak analiz etmiştir. Pazar çiftlerinde rekabetin azalması fiyatların artmasına ve uçuş sıklığının azalmasına sebep olduğu görülmüştür.

Alderighi vd. (2012) çalışmalarında Avrupa pazar çiftlerinde rekabet analizini tam hizmet sağlayıcı havayolları ile düşük maliyetli havayolları arasında gerçekleştirmişlerdir. Pazar çiftlerini modellerinde simetrik ve asimetric olarak monopol, duopol ve oligopol yapılar da olabileceği HHI endeksiyle tanımlamışlardır. İş ve tatil amaçlı yolcular kapsamında yapılan modellemedeki regresyon sonuçlarında düşük maliyetli havayollarının girişiy le rekabetin artmasına sebep olarak fiyatlarda gerilemeye sebep olduğu, özellikle orta düzey fiyatlarda, test edilmiştir. Ayrıca, pazar çiftlerinde rekabet analizinde iş ve tatil amaçlı pazarların ayrı değerlendirilmesi gerekliliğini de önermişlerdir. Bu çalışmaya benzer bir yapıda Calzada ve Fageda (2014) Avrupa pazar çiftleri ile 2002-2010 yılları arasında HHI endeksiyle ve uçuş sıklıklarını kullanarak regresyon modeli oluşturmuşlardır. Elde edilen sonuçlar kapsamında düşük maliyetli havayollarının olduğu pazar çiftlerinde rekabetin ve uçuş sıklıklarının yüksek olduğunu belirtmişlerdir. Ayrıca, fiyatlarda yapılan indirimlerin inceleme yapılan ülkelerde piyasa yoğunlaşmasını azalttığı ve uçuş sıklıklarını artırdığı tespit edilmiş olup, kamu yararına yapılan pazar çiftlerinin varlığının piyasa yoğunlaşmasını artırdığını da vurgulamışlardır.

Zhang vd. (2014) çalışmalarında Lerner endeksinden faydalanarak Çin kuruluşlu havayollarının pazar güçlerinin piyasa gücünü etkileyen faktörlerle ANOVA analizini gerçekleştirmişlerdir. Çin'de bölgesel olarak (doğu, batı ve merkez) havayollarının pazar güçlerinin değişkenlik gösterdiği tespit edilmiş olup, düşük maliyetli havayollarının piyasa gücünü etkilediği ifade edilmiştir. Çin sivil hava taşımacılığı endüstrisinin piyasa yapısını inceleyen Dai vd. (2019), idari monopolün endüstrinin etkinliği üzerine etkisini CR_N ve HHI endekslerini kullanarak incelemişlerdir. Yoğunlaşma seviyelerinin azalmasıyla verimlilik artışının gerçekleştiğini ifade etmişlerdir. Su vd. (2020) Çin hava taşımacılığı endüstrisinin son dönemlerdeki yükselişiy le düşük maliyetli havayolu olarak hizmet sunan havayollarıy la yüksek hızlı tren taşımacılığı hizmeti sunan işletmeler arasındaki rekabet analizini ele almışlardır. Serbestleşme süreciy le regülasyonların uluslararası standartlara uyumlu hale gelmesi her iki endüstride rekabeti artırdığı, buna karşılık işletmelerin kârlılık seviyelerinde azalışa sebep olduğunu belirtmişlerdir. Uzakdoğu bölgesinde ülkelerin serbestleşme süreciy le elde ettikleri kazanımları, karşılaştırmalı olarak güncel yazında araştırılmaktadır (Chang et al., 2022).

Bilotkach ve Lakew (2014) Amerika'daki havalimanlarında, 17 yıllık bir veri setini kullanarak, pazar gücünü HHI endeksiy le diğer faktörleri de regresyona dahil ederek analiz etmişlerdir. Çalışma, havalimanlarına hâkim olmanın pazar çiftlerindeki hakimiyetten, pazar gücünü elde etmek açısından daha önemli olduğunu vurgulamışlardır.

Oliveira ve Oliveira (2018) Brezilya havacılık endüstrisinin yapısını 2002-2013 yılları arasında incelemiştir. CR_2 ve HHI endeksleri kullanılarak oluşturulan regresyon modeliyle elde edilen en önemli sonuç pazar büyüklüğü ile pazar yoğunlaşması arasındaki ters ilişkidir.

Song vd. (2020) diđer çalışmalardan farklı olarak HHI endeksiyle piyasa yoğunlaşmasının havacılık endüstrisinin verimliliğine etkisini iki aşamalı veri zarflama analiziyle 56 ülke için gerçekleştirmişlerdir. Lenaerts vd. (2021) çalışmalarında geniş kapsamlı bir değerlendirme yaparak, havacılığın ekonomik kalkınmaya katkıda bulunabileceđi mekanizmaların tamamını kapsamlı bir şekilde ele alan teorik bir çerçeve sunmuşlardır. Çalışmada, etki mekanizmalarını kapsamlı bir şekilde tanımlamak için yeni ekonomik coğrafya yaklaşımını kullanmışlardır.

Türkiye sivil havacılık endüstrisi için yapılan çalışmalar incelendiğinde CR_N ve HHI endekslerinin kullanımının yaygın olduđu gözlemlenmektedir. Acar ve Karabulak (2015) iş modelleri kapsamında Türkiye'deki havayollarının rekabet analizini SWOT analiziyle gerçekleştirmişlerdir. Sarıbaş ve Tekiner (2015) CR_2 ve HHI endekslerini TOBB Sivil Havacılık Sektör raporlarında açıklanan pazar paylarına göre hesaplayarak yoğunlaşma seviyesinin yüksek olduğunu tespit etmişlerdir. Yaşar ve Gerede (2018) Türkiye iç hat pazarında serbestleşme sürecinin tamamlanmasıyla 2011-2013 yılları arasında piyasa yoğunlaşmasını CR_N , HHI ve entropi endekslerini kullanarak analiz etmişlerdir. Türkiye pazar çiftlerinde yoğunlaşma seviyesinin yüksek olduğu tespit edilmiştir. Türk havalimanları çerçevesinde CR_N ve HHI endekslerini kullanarak Kiracı vd. (2017) beş büyük havalimanının yoğunlaşma düzeylerini incelemiştir. Yaşar ve Kiracı (2018) aynı yöntemleri kullanarak dünya sivil hava taşımacılıđı endüstrisini yedi bölgeye ayırarak incelemiştir. Bölgesel olarak incelenen endüstride yoğunlaşmaların daha düşük ve rekabetçi bir piyasanın olduğunu vurgulamışlardır. Son olarak, Yaşar (2023) çalışmasında Türkiye'deki 28 havalimanının yoğunlaşma seviyelerini HHI endeksinin kullanarak panel veri analizi yardımıyla incelemiştir.

4. Veri ve Yöntem

Bir işletmenin rekabet ortamına ilişkin her türlü analiz, endüstri yapısının temel özelliklerinin belirlenmesini içermektedir. Genellikle, endüstri yapısının en önemli özellikleri arasında firmaların sayısı ve büyüklük dağılımı, giriş ve çıkış engellerinin varlığı ve yüksekliđi ve ürün farklılaştırma derecesi yer almaktadır. Satıcı yoğunlaşması, bu özelliklerin ilk ikisini ifade etmekte olup, endüstriyel organizasyon alanındaki ampirik araştırmalarda satıcı yoğunlaşmasının endüstri yapısının incelenmesinde kullanılan en yaygın göstergesi olarak gösterilmektedir (Lipczynsky et al., 2017). Herhangi bir satıcı yoğunlaşma ölçüsünde nispeten basit bir sayısal gösterge kullanılarak, endüstrideki işletmelerin sayı ve büyüklük dağılımının rekabetin yapısı üzerindeki etkilerinin yansıtılması amaçlanmaktadır.

Hem işletme sayısı hem de bunların büyüklük dağılımı önemlidir. Bu kapsamda, rekabete ilişkin ampirik çalışmalarda yoğunlaşmanın önemi göz önünde bulundurularak, bu konu Türk sivil hava taşımacılığı endüstrisi için üç aşamalı bir analizle test edilecektir. İlk aşamada, endüstrinin rekabet yapısını gösteren yoğunlaşma oranları havayolu işletmelerinin operasyonel ve finansal performansları ile tespit edilecektir. İkinci aşamada, Türk sivil hava taşımacılığında faaliyette bulunan havayolu işletmelerinin 2012-2022 yılları arasındaki etkinlik durumu ve değişimi veri zarflama analizi (VZA) ile ortaya konulacaktır. Birinci ve ikinci aşamadaki veriler, havayolu işletmelerinin (Türk Hava Yolları-AnadoluJet, Pegasus ve Sunexpress) yatırımcı ilişkileri sayfalarında yayınlanan faaliyet raporlarından sağlanmaktadır (Pegasus; THY). Son aşamada, endüstri yapısı verileriyle (CR₃ ve HHI) endüstri etkinliği arasındaki ilişki test edilecektir. Analizde kullanılan endüstri verileri (endüstri hasılatı, taşınan yolcu sayısı ve uçak trafiği sayısı) 2012-2022 yıllarına ait Sivil Havacılık Genel Müdürlüğü'nün (SHGM) ve Devlet Hava Meydanları İşletmesi Genel Müdürlüğü'nün (DHMİ) yıllık faaliyet ve sektör raporlarından temin edilmiştir (DHMİ, 2012; SHGM, 2012; DHMİ, 2013; SHGM, 2013; DHMİ, 2014; SHGM, 2014; DHMİ, 2015; SHGM, 2015; DHMİ, 2016; SHGM, 2016; DHMİ, 2017; SHGM, 2017; DHMİ, 2018; SHGM, 2018; DHMİ, 2019; SHGM, 2019; DHMİ, 2020; SHGM, 2020; DHMİ, 2021; SHGM, 2021; DHMİ, 2022; SHGM, 2022).

Çalışma metodolojisi üç bölüm halinde ele alınacaktır. İlk bölümde endüstrinin yoğunlaşma seviyesinin belirlenmesinde kullanılacak yöntemler açıklanacak, ikinci bölümde veri zarflama analizi (VZA) için endüstrinin etkinlik skorları tespit edilecektir. Son olarak, yoğunlaşma ile etkinlik arasında uzun vadeli istikrarlı bir denge ilişkisi olup olmadığını test etmek amacıyla eş bütünleşme yöntemi ve hata düzeltme modeli kullanılacaktır.

4.1. Türkiye Sivil Hava Taşımacılığı Endüstrisinin Pazar Yapısı Analizi

Hava taşımacılığı endüstrisi, halihazırda faaliyette olan havayolları için pazar çiftleri arasında düşük giriş maliyetlerine sahip gibi görünmektedir. Gerekli olan tek şey, bir uçağı bulunduğu yerden yeni kalkış ve varış noktası çiftine uçurmaktır. Yani, havayolu sektörü rekabet edilebilir bir pazar olarak görünmektedir. Ancak girişin görünürdeki kolaylığına rağmen, havayolu endüstrisi üzerine yapılan çalışmalar pazardaki yoğunlaşmanın ücretleri etkilediğini göstermektedir. Havayolu ücretlerini etkilemede potansiyel giriş değil, fiili giriş kritik öneme sahiptir (Carlton & Perloff, 2005). Bu alanda piyasa yoğunlaşmasını ölçmek için kullanılan ana göstergeler Lerner Endeksi, endüstri mutlak yoğunlaşması (CR_N) ve Herfindahl Hirschman endeksidir (HHI) (Dai et al., 2019). Alan yazında da görüldüğü üzere yoğunlaşma sorununu ele alan araştırmaların sayısı hem havacılıkta hem de diğer endüstrilerde önemli ölçüde artış göstermektedir. Her bir çalışma bu sürecin bir ölçüsünü sunmaktadır. Önerilen ölçümlerin çeşitliliği, ideal bir versiyonun henüz bulunmadığını göstermektedir. Önerilen ölçümlerin güçlü ve zayıf yönleri bulunmakta olup, ölçümün doğruluğu açısından farklılık göstermektedirler (Ginevičius & Čirba, 2007). Bu kapsamda, çalışmada yaygın olarak kullanılan CR_N ve HHI endeksleri hesaplanacaktır. Mutlak

yoğunlaşma endeksi (CR_N endeksi), sektörün ilgili pazarındaki en büyük n işletmenin toplam pazar payını ifade eder. Formül aşağıdaki gibidir:

$$CR_N = \frac{\sum(X_i)_n}{\sum(X_i)_N}, N > n \quad (1)$$

CR_N endeksi Türk sivil havacılığı için üç kategoride hesaplanacaktır. Bu kategoriler şu şekildedir: taşınan yolcu sayısına, uçak trafiğine ve faaliyetteki havayollarının satış hacimleridir. Türk sivil hava taşımacılığı endüstrisinde özellikle iç hat taşımacılığında üç havayolu işletmesinin hasılat ve taşınan yolcu sayısında baskın olması sebebiyle CR_3 ile endeks hesaplanmaktadır.

Tablo: 1
 CR_N Göre Endüstri Yapısı Sınıflandırması (Dai et al., 2019)

Endüstri Yapısı	Yoğunlaşma Oranı CR_3 (%)
Oligopol Tip I	$CR_3 \geq 85$
Oligopol Tip II	$75 \leq CR_3 < 85$
Oligopol Tip III	$50 \leq CR_3 < 75$
Oligopol Tip IV	$35 \leq CR_3 < 50$
Oligopol Tip V	$30 \leq CR_3 < 35$
Rekabetçi Yapı	$CR_3 < 30$

Buna ek olarak, diğer tercih edilen HHI endeksi şu formülle hesaplanacaktır:

$$HHI = \sum_{i=1}^N \left(\frac{X_i}{X}\right)^2 = \sum_{i=1}^N S_i^2 \quad (2)$$

Formül (2)'de: X_i , i işletmesinin çıktısıdır. N, sektördeki toplam işletme sayısıdır. S_i , i işletmesinin pazar payıdır.

Tablo: 2
HHI Göre Endüstri Yapısı Sınıflandırması (Dai et al., 2019)

Endüstri Yapısı	Yoğunlaşma Oranı HHI (0-10.000)
Yüksek Oligopol Tip I	$HHI \geq 3000$
Yüksek Oligopol Tip II	$1800 \leq HHI < 3000$
Düşük Oligopol Tip I	$1400 \leq HHI < 1800$
Düşük Oligopol Tip II	$1000 \leq HHI < 1400$
Rekabetçi Yapı Tip I	$500 \leq HHI < 1000$
Rekabetçi Yapı Tip II	$HHI < 500$

Türk sivil hava taşımacılığı endüstrisinin yoğunlaşma endeksleri, Dai vd. (2019) çalışmasında Bain (1951) kriterlerini referans alarak oluşturduğu sınıflandırma kriterleri dikkate alınarak değerlendirilecektir.

4.2. Türkiye Sivil Hava Taşımacılığı Endüstrisinin Üretim Etkinliği Analizi

Veri Zarflama Analizi (VZA) ilk olarak Charnes vd. (1978) tarafından parametrik olmayan bir istatistiksel tahmin yöntemi olarak önerilmiştir. Sistemin üretim verimliliği sınırlarını (yani en düşük girdi veya en yüksek çıktı) belirlemek için tüm aynı tip Karar Verme Birimlerini (KVB) kullanır ve karar verme birimlerinin VZA sınırlarından sapma

derecelerini karşılaştırarak göreceli etkinliklerini değerlendirir (Charnes et al., 1978). Bu da her bir karar verme biriminin göreceli etkinliği, ölçek geliri bilgisi olarak görülebilir. Bir karar verme biriminin göreceli etkinlik değeri 1 ise, karar verme biriminin en etkin olan cepheye düştüğü kabul edilebilir; aksi takdirde, karar verme birimi geçersizdir (Charnes et al., 1985). VZA'nın CCR ve BCC dahil olmak üzere birçok modeli bulunmaktadır. VZA modelinin etkisiz veya ölçeğin geçersiz olması durumunda CCR modelinin geçersiz olduğuna karar verilemeyeceğinden, bu çalışmada Türk sivil hava taşımacılığı sektörünün üretim verimliliğini değerlendirmek için Dai vd. (2019) çalışmalarında olduğu gibi BCC modeli kullanılacaktır. Sivil havacılık endüstrisinin etkinliğini değerlendirirken, karar birimini seçmek için üç yöntem vardır: (1) aynı KVB'nin farklı yıllarını veya dönemlerini seçmek; (2) farklı bölgeleri veya rotaları seçmek; (3) farklı bölgelerin veya rotaların farklı dönemlerini seçmek. Bu çalışma ilk yöntemi seçerek 2012-2022 yılları arasında, girdi ve çıktı tablosunda belirtilen değişkenleri kullanarak, VZA değerlendirmesini 11 karar verme birimini seçerek Türk sivil havacılık taşımacılığının genel üretim etkinliğini oluşturmuştur. VZA analizi Coelli (1996) tarafından oluşturulan DEAP 2.1 programıyla gerçekleştirilecektir.

Tablo: 3
Girdi ve Çıktı Değişkenleri

Girdi-Çıktı Türü	Değişken	Açıklama	Referans Çalışma
Çıktı	Taşınan Yolcu Sayısı	Her yıl içinde havayolları tarafından Türkiye'den aktarmalı/aktarmasız taşınan yolcu sayısı	Kiracı ve Asker (2019)
	Hasılat	Havayolu işletmelerinin elde ettiği satış hasılatı	Barbot vd. (2008)
Girdi	Uçulan Nokta Sayısı	Türkiye'den uçulabilen pazar (şehir) nokta sayısı	Kottas & Madas (2018)
	Koltuk Kapasitesi	Havayollarının yıllık satışa arz ettikleri koltuk adedi sayısı	Merkert & Hensher (2011)
	Personel Sayısı	Türk sivil havacılığında yıllık istihdam edilen toplam personel sayısı	Wanke vd. (2015)

4.3. Sivil Hava Taşımacılığı Endüstrisinde Yoğunlaşma ile Üretim Etkinliği Arasındaki Uzun Dönem Etkileşim Analizi

Yoğunlaşma ile üretim etkinliği arasında uzun vadeli istikrarlı bir denge ilişkisi olup olmadığını test etmek amacıyla, Türk hava taşımacılığı endüstrisinin HHI endeksini ve VZA üretim etkinliğini analiz etmek için eş-bütünleşme yöntemi ve hata düzeltme modeli kullanılacaktır. Rasyonel bilgilerin sınırlılığı nedeniyle, geleneksel ekonometrik model tarafından durağan olmayan ekonomik zaman serilerinin çoğu için birkaç düzeltmeden sonra kurulan regresyon modeli genellikle ekonomik anlamı belirsiz hale getirebilmektedir. Bu belirsizlik nedeniyle, durağan olmayan zaman dizisinin doğrudan regresyon modelini kurup kuramayacağını belirlememiz mümkün olmayabilmektedir. Engle ve Granger (1987) tarafından ortaya atılan teori bu sorunu çözümlenmiştir. Eş bütünleşme yöntemi ve hata düzeltme modeli, ekonomik değişkenlerin verilerinde gösterilen ilişkiye dayanır ve değişkenler ile modelde yer alan değişkenler arasındaki teorik ilişkiyi belirler, bu nedenle testin sonuçları istikrarlı ve güvenilirdir (Lee & Lee, 2015). İki değişken dizisi arasındaki ilişkiyi test etmek için ortak entegrasyon yöntemi ve hata düzeltme modeli kullanmanın temel adımları bu çalışmada da izlenecektir. İlk olarak birim kök testi yapılacak olup, Dickey ve Fuller (1979) yöntemi kullanılacaktır. Akabinde eş bütünleşme ve ardından da Davidson

vd. (1978) tarafından önerilen hata düzeltme modeli analizleri Eviews paket programı kullanılarak gerçekleştirilecektir.

5. Bulgular ve Tartışma

Yoğunlaşma endeksleri üç kategoride oluşturulmuş olup, Tablo 4'te endeks değerleri renk ölçeğinde sunulmaktadır. Türkiye kapsamında diğer çalışmalarda yapılan taşınan yolcu sayısı ve uçak trafiği pazar paylarının sıklıkla kullanıldığı gözlemlenmektedir (Saribaş & Tekiner, 2015; Yaşar & Gerede, 2018). Ancak, oligopol yapıda olduğu gözlemlenen hava taşımacılığı endüstrisinin oligopol seviyesinin, Holmes ve Schmitz Jr (2010), Lijesen ve Behrens (2017) ve Dai vd. (2019) çalışmalarında olduğu gibi, doğru tespit edilebilmesi için havayollarının hasılatlarına göre endeksler hesaplanmıştır. Bu çerçevede, piyasa yoğunlaşma değerlendirmesinin bu kategoride hesaplanan endeks değerleri üzerinden yapılmasının doğruluğu da test edilmiştir. Bu kapsamda, endüstrinin CR_N endeksine göre Oligopol Tip III ile IV arasında değişkenlik gösterdiği gözlemlenmektedir. HHI endeksine göre ise, piyasanın düşük oligopol yapıdan yüksek oligopol tipi bir yapıya dönüştüğü gözlemlenmektedir. CR_N 'de görülen dalgalanma HHI endeksinde görülmemekte olup, yoğunlaşmanın sosyoekonomik olayların yaşandığı yılları takip eden yıllar haricinde sürekli artış gösterdiği görülmektedir. Hasılat kategorisinde her iki yoğunlaşma endeksi yoğunlaşmanın daha düşük olduğunu gösterirken, taşınan yolcu sayısına ve uçak trafiğine göre yoğunlaşmanın daha yüksek olduğunu göstermektedir. Bu farklılık uçak trafiği yoğun ve taşıdıkları yolcu sayısı fazla olan havayolu işletmelerinin daha az sayıda yolcu ve uçak trafiği ile faaliyet gösteren diğer havayolu işletmeleriyle gelir paylaşımını gerçekleştirdiği gözlemlenmektedir.

Tablo: 4
CRN ve HHI Endeks Değerleri

Sınıflandırma	Endeksler	2012	2013	2014	2015	2016	2017	2018	2019	2020	2021	2022
Taşınan Yolcu Sayısına Göre Yoğunlaşma	CR3	0,814	0,838	0,860	0,876	0,888	0,903	0,914	0,931	0,985	0,960	0,960
	HHI	3382	3763	3947	4036	4171	4303	4329	4418	4677	4514	4675
Uçak Trafikğine Göre Yoğunlaşma	CR3	0,834	0,854	0,862	0,871	0,875	0,893	0,911	0,929	0,975	0,960	0,955
	HHI	3634	4049	4131	4147	4145	4212	4349	4466	4719	4639	4657
Hasılatla Göre Yoğunlaşma	CR3	0,489	0,462	0,488	0,523	0,520	0,432	0,546	0,531	0,522	0,438	0,570
	HHI	1586	1414	1571	1833	1812	1096	1982	2218	1966	1309	2226

Diğer bir ifadeyle, ülke içerisinde kurulan havayollarının elde ettikleri uçuş imtiyazlarının piyasa rekabetindeki etkisinin CR_3 'e göre fazla olmadığı ve HHI endeksine göre ise ivmelendiği değerlendirilmektedir.

Tablo 5'te 2012-2022 yıllarını kapsayan VZA analiz sonuçları gösterilmektedir. 11 yıl içerisinde 2013, 2014, 2015, 2018 ve 2022 yılları etkinlik skorları 1 olup, bu dönemler kapsamlı etkinlik olarak değerlendirilebilmektedir. Bu da üretimin etkin olarak gerçekleştirildiği ve girdilerden tam olarak faydalandığı anlamına gelmektedir. Etkinlik skorlarına göre diğer kalan 6 dönem tam etkin değildir. Teknik etkinlik skorları 1 olan 7 dönemde kaynak tahsisin en iyi şekilde yapıldığı ifade edilebilir. Tablodaki ölçek getirisi ölçeğine göre, Türk sivil havacılık endüstrisi 2012 yılında önce artan getiri durumunda, 2013

yılından sonra üç yıl boyunca sabit getiri durumundadır. Bu durum, Türk sivil havacılık endüstrisinin 2012 yılından önce optimal üretim ölçeğine ulaştığını göstermekte olup, inceleme dönemi boyunca değişken bir yapıda ölçeğin oluştuğu görülmektedir. Genel olarak, Türk sivil havacılık endüstrisinin teknik ve ölçek etkinlikleri dalgalı bir seyir izlemektedir. Covid-19 süreci haricinde etkinlik yapısının yüksek olduğu gözlemlenmektedir. Buna ek olarak, tam etkin olmayan dönemlerde düşük ölçek etkinliğinin genel etkinliğin ana nedeni olduğu anlaşılmaktadır. Girdi-çıktı etkinliği de genel etkinlik gibi dalgalı ancak yüksek seviyelerde olduğunu göstermektedir.

Tablo: 5
VZA Sonuçları

Yıl	Teknik Etkinlik	Ölçek Etkinliği	Ölçek
2012	1.000	0.943	Ölçeğe göre artan getiri
2013	1.000	1.000	Ölçeğe göre sabit getiri
2014	1.000	1.000	Ölçeğe göre sabit getiri
2015	1.000	1.000	Ölçeğe göre sabit getiri
2016	0.976	0.926	Ölçeğe göre artan getiri
2017	1.000	0.979	Ölçeğe göre artan getiri
2018	1.000	1.000	Ölçeğe göre sabit getiri
2019	0.972	1.000	Ölçeğe göre sabit getiri
2020	0.722	0.547	Ölçeğe göre artan getiri
2021	0.799	0.829	Ölçeğe göre artan getiri
2022	1.000	1.000	Ölçeğe göre sabit getiri

Son olarak, uzun vadeli istikrarlı bir denge ilişkisi olup olmadığını test etmek amacıyla, Türk hava taşımacılığı endüstrisinin HHI endeksini ve VZA üretim etkinliğini analiz etmek için eş bütünleşme analizinden faydalanılmıştır. Değişim hassasiyetinin daha net görülebilmesi için iki değişkenin logaritmik değerleri kullanılmıştır. Eş bütünleşme analizinde değişkenlere birim kök testi yapılarak serilerin istikrarlılığı test edilmiştir. ADF testinde her iki değişkenin istikrarlı bir yapıya birinci derece gecikmeli değerlerinde geçtiği tespit edilmiş olup, bu değerlerle analiz gerçekleştirilmiştir.

Şekil: 6
HHI Hasılat ve Logaritmik HHI Hasılat 1. Dereceden Fark Dizim Diyagramları

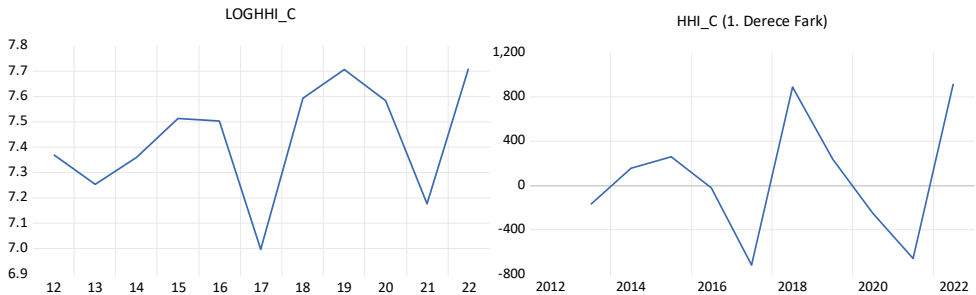

Şekil: 7
Etkinlik Skorları ve Logaritmik Etkinlik Skorları 1. Dereceden Fark Dizim Diyagramları

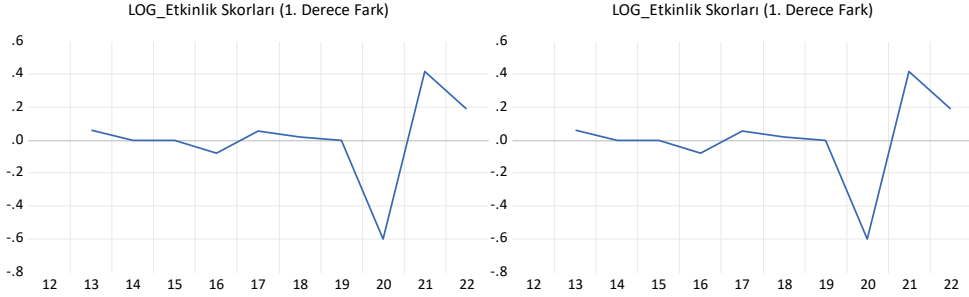

Şekil: 8
Artık Değerler ve Artık Değerler 1. Dereceden Fark Dizim Diyagramları

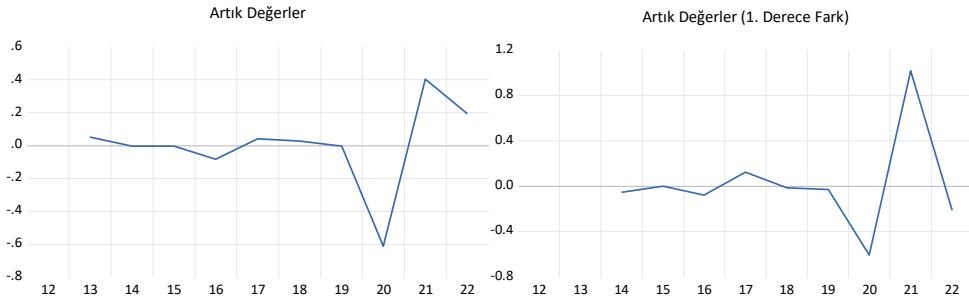

Her iki değişkenin ADF testinin t istatistik değerleri kritik değerden küçüktür ve %5 anlamlılık düzeyinde anlamlıdır. Bu da iki dizinin kararlılık testi ile var olmadığını gösterir. Özet olarak, durağan olmayan log HHI hasılat ve log etkinlik skorları dizileri birinci dereceden farktan sonra kararlıdır. Bu nedenle iki dizinin tümü birinci dereceden tek tamsayı dizilerdir. Bağımsız değişken olarak log HHI hasılat ve bağımlı değişken olarak log etkinlik skorları alındığında, log etkinlik skorları değişkeni log HHI hasılat için sıradan en küçük kareler regresyonunu gerçekleştirmek için kullanılır ve artık olan kalıntı değerleri elde edilir. Log_HHI_C ve Log Üretim Etkinliği (ÜE) arasındaki hata düzeltme modeli birinci dereceden otoregresif dağılım gecikme modeline dayanılarak aşağıdaki denklem (3) ve denklem (4)'e göre oluşturulmuştur:

$$Y_t = \beta_0 + \beta_1 x_t + \beta_2 y_{t-1} + \beta_3 x_{t-1} + \varepsilon_t \quad (3)$$

$$\text{Log ÜE} = \beta_0 + \beta_1 \text{Log_HHI_C}_{-1} + \beta_2 \text{Log ÜE}_{t-1} + \beta_3 \text{Log_HHI_C}_{-1} + \varepsilon_t \quad (4)$$

Regresyon sonucunda elde edilen sonuç denklemi de (5)'te gösterilmektedir.

$$D(\text{LOGUE}) = -0.0179618126327 * D(\text{LOGHHI_C}) + 0.00647778915034 \quad (5)$$

$$R^2 = 0.000615 \quad DW = 2.512088 \quad F = 0.004926$$

Üretim etkinliği ile yoğunlaşma (HHI_C) arasında negatif ilişki bulunduğu, Dai vd. (2019) çalışmalarındaki bulguyla örtüşmektedir. Ancak, anlamlılık düzeyine Durbin Watson ve F istatistiği haricinde %5 güven aralığında bir p değeri sağlanamadığından bu ilişkinin anlamlılığı Çin'de olduğu gibi Türkiye için de kabul edilememektedir. Çin'de R^2 değerinin yüksek seviyelerde gerçekleşmesine rağmen Türkiye için bu değer açıklayıcılık açısından çok düşük seviyelerde kalmaktadır. Buna rağmen, Türkiye'nin hava taşımacılığı ile üretim etkinliği arasında hem pozitif hem de anlamlı bir ilişkinin olduğu gözlemlenmiştir. Bu durumda, uluslararası uçuşların çoğunlukta olduğu THY ve Pegasus havayollarının faaliyet raporlarından da anlaşıldığı üzere, üretim etkinliğinin olumlu yönde etkilendiği test edilmiştir. Bu sonuçlar, bölgeler arasında üretim etkinliği ile piyasa yoğunlaşması arasında benzer olmayan ve tutarlılığı da değişken etkileşimlerin olabileceğini göstermektedir. Bu da benzer piyasa ve coğrafi koşullara sahip olduğu pazar çiftlerinin veya ülkelerin karşılaştırmalı analizinin yapılmasının anlamlı olabileceğini göstermektedir.

6. Sonuç ve Öneriler

Bu çalışma, Türk sivil hava taşımacılığı endüstrisi yapısıyla ekonomik etkinlik arasında uzun vadeli istikrarlı bir denge ilişkisi olup olmadığını belirlemek için ve SHGM ve DHMİ tarafından sağlanan sivil havacılık istatistikleri verileri kullanılarak Türkiye'nin 2012-2022 yılları arasında endüstrisinin piyasa yapısını, CR_N 'ni, HHI endeksini ve VZA üretim etkinliği endeksini hesaplamaktadır. HHI endeksi ve üretim etkinliği endeksi, eş bütünleşme yönetimi ve hata düzeltme modellerinde kullanılmaktadır. Yapılan ampirik analizle aşağıdaki sonuçlar çıkarılmıştır:

Türk sivil havacılık taşımacılığı pazarının yoğunluk analizi üç farklı kategoride yapılarak mevcut ulusal alan yazına katkı sağlanmıştır. CR_N endeksi düşük seviyelerde bir yoğunlaşmayı gösterse de HHI endeksi yıldan yıla artış göstermektedir. Alan yazında karşılaştırmaların HHI endeksiyle yapılması sebebiyle CR_N endeksiyle, özellikle hasılat bazında, benzer şekilde örtüşmediği gözlemlenmektedir. Üretim etkinliği ise yıldan yıla yoğunlaşma kadar stabil bir artış göstermemektedir. Yine de yoğunlaşma ile üretim etkinliği arasında zıt bir korelasyon olduğunu işaret etmektedir. Bu durum da artan yoğunlaşmanın belirli bir süre içerisinde üretim etkinliğini olumsuz etkileyebileceği anlamına gelmektedir.

Türk sivil havacılık sektörünün rekabet gücünü artırmak amacıyla bazı politika önerileri sunulabilir. İlk olarak, endüstriye giriş, teknoloji değişimi ve endüstri yapısı gibi sektöre girişi etkileyen unsurlarda Türkiye ile gelişmiş ülkeler arasında farklılık bulunmamaktadır. Bu gelişimin desteklenmesi için özellikle yakın coğrafya ile yoğun olan ticari faaliyetlerimizin taşımacılık endüstrisinde de ivmeli ilerleyebilmesi adına yasal düzenlemelerde tam uyumluluğun sağlanması gerekmektedir. İkinci olarak, sivil havacılık endüstrisi kitlesel olmalı ve mevcut kaynaklara ve modüllere entegre kolaylığı sağlanmalıdır. Sivil havacılık taşımacılığı endüstrisinin kendine has ölçek ekonomi özellikleri bulunmaktadır. Ancak sistem, yönetim, tarih ve pazar talebi gibi ilişkili faktörler

nedeniyle ölçek ekonomisi tam olarak etkin kullanılamamaktadır. Bu durumda, havayollarının mevcut kaynakları ve modülleri entegre etmesi ve sivil havacılık ulaşım operasyonunun yönetim seviyesinin iyileştirmesinin ölçek ekonomisinin daha etkin kullanımına katkı sağlayacağı değerlendirilmektedir. Üçüncü olarak, DHMİ endüstri raporlarında da belirtildiği gibi yurtdışı pazarların %40'ı yabancı havayolları tarafından sağlanmaktadır. Yurtiçi hatlarda faaliyet gösteren az sayıdaki taşıyıcıların, bağlantılı uçuş imkânlarını daha etkin kullanarak yurtdışı uçuşlardaki paylarını daha da artırmaları üretim etkinliklerini geliştirmek açısından önemli olacaktır. Bu doğrultuda, havacılık yönetiminde üretim etkinliğinin artırılması amacıyla kurumsallaşmanın güçlendirilmesinin kritik öneme sahip olduğu düşünülmektedir. Hava taşımacılığı endüstrisinde ikili hava taşımacılığı anlaşmalarının artırılarak ve daha fazla slot tahsisiyle endüstrinin üretim etkinliğine de katkı sağlanabilecektir.

Kaynaklar

- Acar, A.Z. & S. Karabulak (2015), "Competition between full-service network carriers and low-cost carriers in Turkish airline market", *Procedia-Social and Behavioral Sciences*, 207, 642-651.
- Acemoglu, D. et al. (2019), *Microeconomics* (2nd ed.), Pearson.
- Alderighi, M. et al. (2012), "Competition in the European aviation market: the entry of low-cost airlines", *Journal of Transport Geography*, 24, 223-233.
- Bain, J.S. (1951), "Relation of Profit Rate to Industry Concentration: American Manufacturing, 1936-1940", *The Quarterly Journal of Economics*, 65(3), 293-324.
- Bain, J.S. (1956), *Barriers to new competition: their character and consequences in manufacturing industries*, Harvard University Press.
- Barbot, C. et al. (2008), "Airlines performance in the new market context: A comparative productivity and efficiency analysis", *Journal of Air Transport Management*, 14(5), 270-274.
- Bilotkach, V. & P.A. Lakew (2014), "On sources of market power in the airline industry: Panel data evidence from the US airports", *Transportation Research Part A: Policy and Practice*, 59, 288-305.
- Cabral, L.M. (2017), *Introduction to industrial organization*, MIT Press.
- Calzada, J. & X. Fageda (2014), "Competition and public service obligations in European aviation markets", *Transportation Research Part A: Policy and Practice*, 70, 104-116.
- Carlsson, F. (2002), "Price and Frequency Choice under Monopoly and Competition in Aviation Markets", *Working Papers in Economics*, 71, University of Gothenburg, Department of Economics.
- Carlton, D.W. & J.M. Perloff (2005), *Modern Industrial Organization*, (4th ed.), Pearson/Addison Wesley, Boston.
- Caves, R.E. (2007), "In praise of the Old I.O.", *International Journal of Industrial Organization*, 25(1), 1-12.
- Chang, Y.-C. et al. (2022), "How aviation market is influenced by political policy-the case of Taiwan and China", *Transportation Research Procedia*, 65, 133-143.

- Charnes, A. et al. (1978), “Measuring the efficiency of decision making units”, *European Journal of Operational Research*, 2(6), 429-444.
- Charnes, A. et al. (1985), “A developmental study of data envelopment analysis in measuring the efficiency of maintenance units in the US air forces”, *Annals of Operations Research*, 2, 95-112.
- Coelli, T. (1996), “A guide to DEAP version 2.1: a data envelopment analysis (computer) program”, *Centre for Efficiency and Productivity Analysis, University of New England, Australia*, 96(08), 1-49.
- Çelik, T. & M. Kaplan (2010), “Türk Bankacılık Sektöründe Etkinlik ve Rekabet: 2002-2007”, *Sosyoekonomi*, 13(13), 7-28.
- Dai, Z. et al. (2019), “Market concentration measurement, administrative monopoly effect and efficiency improvement: empirical data from China civil aviation industry 2001-2015”, *Applied Economics*, 51(34), 3758-3769.
- Davidson, J.E. et al. (1978), “Econometric modelling of the aggregate time-series relationship between consumers' expenditure and income in the United Kingdom”, *The Economic Journal*, 88(352), 661-692.
- DHMİ (2012), *DHMİ Faaliyet Raporu 2012*, <<https://www.dhmi.gov.tr/Lists/FaaliyetRaporlari/Attachments/13/2012%20FAALİYET%20RAPORU%20web.pdf>>, 26.03.2023.
- DHMİ (2013), *DHMİ Faaliyet Raporu 2013*, <https://www.dhmi.gov.tr/Lists/FaaliyetRaporlari/Attachments/14/2013_Faaliyet_Raporu.pdf>, 26.03.2023.
- DHMİ (2014), *DHMİ Faaliyet Raporu 2014*, <<https://www.dhmi.gov.tr/Lists/FaaliyetRaporlari/Attachments/15/2014%20Faaliyet%20Raporu%20.pdf>>, 26.03.2023.
- DHMİ (2015), *DHMİ Faaliyet Raporu 2015*, <https://www.dhmi.gov.tr/Lists/AnnualReports/Attachments/9/Annual_Report_2015_sit e.pdf>, 26.03.2023.
- DHMİ (2016), *DHMİ Faaliyet Raporu 2016*, <https://www.dhmi.gov.tr/Lists/AnnualReports/Attachments/10/Annual_Report_2016.pdf>, 26.03.2023.
- DHMİ (2017), *DHMİ Faaliyet Raporu 2017*, <https://www.dhmi.gov.tr/Lists/AnnualReports/Attachments/11/Annual_Report_2017.pdf>, 26.03.2023.
- DHMİ (2018), *DHMİ Faaliyet Raporu 2018*, <https://www.dhmi.gov.tr/Lists/AnnualReports/Attachments/12/DHMI_2018_Annual_Report.pdf>, 26.03.2023.
- DHMİ (2019), *DHMİ Faaliyet Raporu 2019*, <<https://www.dhmi.gov.tr/Lists/AnnualReports/Attachments/13/2019.pdf>>, 26.03.2023.
- DHMİ (2020), *DHMİ Faaliyet Raporu 2020*, <https://www.dhmi.gov.tr/Lists/FaaliyetRaporlari/Attachments/21/DHMI_2020_Faaliyet_Raporu.pdf>, 26.03.2023.

- DHMİ (2021), *DHMİ Faaliyet Raporu 2021*, <[https://www.dhmi.gov.tr/Lists/FaaliyetRaporlari/Attachments/22/Faaliyet%20Raporu-31.05.2021web%20\(3\).pdf](https://www.dhmi.gov.tr/Lists/FaaliyetRaporlari/Attachments/22/Faaliyet%20Raporu-31.05.2021web%20(3).pdf)>, 26.03.2023.
- DHMİ (2022), *DHMİ Faaliyet Raporu 2022*, <<https://www.dhmi.gov.tr/Lists/FaaliyetRaporlari/Attachments/23/2022-faaliyet-raporu.pdf>>, 26.03.2023.
- Dickey, D.A. & W.A. Fuller (1979), "Distribution of the estimators for autoregressive time series with a unit root", *Journal of the American Statistical Association*, 74(366a), 427-431.
- Dođan, M.A. & E.M. Dođan (2023), "Türk Sivil Hava Tařımacılıđı Endüstrisinin Rekabet Gücünün Deđerlendirilmesi", *Cumhuriyet Üniversitesi İktisadi ve İdari Bilimler Dergisi*, 24(2), 266-278.
- Engle, R.F. & C.W. Granger (1987), "Co-integration and error correction: representation, estimation, and testing", *Econometrica*, 55(2), 251-276.
- Ginevičius, R. & S. Čirba (2007), "Determining Market Concentration", *Journal of Business Economics and Management*, 8(1), 3-10.
- Günalp, B. (2011), "Türk imalat endüstrilerinde yođunlařma oranlarının belirleyenleri: Bir dinamik panel veri analizi", *Sosyoekonomi*, 14(14), 23-50.
- Holmes, T.J. & J.A. Schmitz Jr (2010), "Competition and productivity: a review of evidence", *Annu. Rev. Econ.*, 2(1), 619-642.
- Ildırar, M. & E. Kırall (2018), "Piyasa Yapısı Ve Yođunlařma: Türk Otomotiv Sektörü Üzerine Bir Analiz", *Bolu Abant İzzet Baysal Üniversitesi SBE Dergisi*, 18(1), 93-117.
- Kıracı, K. & V. Asker (2019), "Etkinlik ve etkinliđi belirleyen faktörler: havayolu řirketleri üzerine ampirik bir inceleme", *Eskiřehir Osmangazi Üniversitesi İktisadi ve İdari Bilimler Dergisi*, 14(1), 25-50.
- Kıracı, K. et al. (2017), "A concentration analysis in the Turkish domestic air transportation industry using with CRm and Herfindahl-Hirschman indexes", *Gaziantep University Journal of Social Sciences*, 16(3), 687-704.
- Kottas, A.T. & M.A. Madas (2018), "Comparative efficiency analysis of major international airlines using Data Envelopment Analysis: Exploring effects of alliance membership and other operational efficiency determinants", *Journal of Air Transport Management*, 70, 1-17.
- Lee, H. & J. Lee (2015), "More powerful Engle-Granger cointegration tests", *Journal of Statistical Computation and Simulation*, 85(15), 3154-3171.
- Lenaerts, B. et al. (2021), "The economic impact of aviation: A review on the role of market access", *Journal of Air Transport Management*, 91, 102000.
- Lijesen, M. & C. Behrens (2017), "The spatial scope of airline competition", *Transportation Research Part E: Logistics and Transportation Review*, 99, 1-13.
- Lijesen, M.G. (2004), "Adjusting the Herfindahl index for close substitutes: an application to pricing in civil aviation", *Transportation Research Part E: Logistics and Transportation Review*, 40(2), 123-134.
- Lijesen, M.G. et al. (2001), "Hub premiums in European civil aviation", *Transport Policy*, 8(3), 193-199.
- Lijesen, M.G. et al. (2002), "Measuring competition in civil aviation", *Journal of Air Transport Management*, 8(3), 189-197.

- Lipczynsky, J. et al. (2017), *Industrial Organization: Competition, Strategy and Policy* (5 ed.), Pearson Education Limited.
- Mason, E.S. (1939), "Price and production policies of large-scale enterprise", *The American Economic Review*, 29(1), 61-74.
- Mason, E.S. (1948), "The current status of the monopoly problem in the United States", *Harv. L. Rev.*, 62, 1265.
- Merkert, R. & D.A. Hensher (2011), "The impact of strategic management and fleet planning on airline efficiency - A random effects Tobit model based on DEA efficiency scores", *Transportation Research Part A: Policy and Practice*, 45(7), 686-695.
- Moss, S. (1984), "The History of the Theory of the Firm from Marshall to Robinson and Chamberlin: the Source of Positivism in Economics", *Economica*, 51(203), 307-318.
- Oliveira, M.V. & A.V. Oliveira (2018), "What drives effective competition in the airline industry? An empirical model of city-pair market concentration", *Transport Policy*, 63, 165-175.
- Pegasus (N/A), *Faaliyet Raporları*, <<https://www.pegasusyatirimciliskileri.com/tr/operasyonel-ve-finansal-veriler/faaliyet-raporlari>>, 26.03.2023.
- Porter, M.E. et al. (2011), *HBR's 10 Must Reads on Strategy (including featured article "What Is Strategy?" by Michael E. Porter)*, Harvard Business Press.
- Pustay, M.W. (1999), "Competition and concentration in Canadian-US transborder aviation markets", *Transportation Journal*, 38(4), 5-17.
- Rodríguez-Castelán, C. et al. (2023), "Market concentration, trade exposure, and firm productivity in developing countries: Evidence from Mexico", *World Development*, 165, 106199.
- Sarıbaş, H. & İ. Tekiner (2015), "Türkiye Sivil Havacılık Sektöründe Yoğunlaşma", *Finans Politik ve Ekonomik Yorumlar*, (610), 21-33.
- Sarıdoğan, H.Ö. (2021), "Piyasa Yoğunlaşması: Yapısalcı Yaklaşım Bağlamında Bilişim Sektörü Üzerine Bir Uygulama", *KTÜ SBE Sosyal Bilimler Dergisi*, 11(21), 67-81.
- Schneider, J. S. (2009), Administrative monopoly and China's new Anti-Monopoly Law: lessons from Europe's state aid doctrine. *Wash. UL Rev.*, 87, 869.
- SHGM (2012), *SHGM Faaliyet Raporu 2012*, <<https://web.shgm.gov.tr/documents/sivilhavacilik/files/kurumsal/faaliyet/2012.pdf>>, 26.03.2023.
- SHGM (2013), *SHGM Faaliyet Raporu 2013*, <<https://web.shgm.gov.tr/documents/sivilhavacilik/files/kurumsal/faaliyet/2013.pdf>>, 26.03.2023.
- SHGM (2014), *SHGM Faaliyet Raporu 2014*, <<https://web.shgm.gov.tr/documents/sivilhavacilik/files/kurumsal/faaliyet/2014.pdf>>, 26.03.2023.
- SHGM (2015), *SHGM Faaliyet Raporu 2015*, <<https://web.shgm.gov.tr/documents/sivilhavacilik/files/kurumsal/faaliyet/2015.pdf>>, 26.03.2023.
- SHGM (2016), *SHGM Faaliyet Raporu 2016*, <<https://web.shgm.gov.tr/documents/sivilhavacilik/files/kurumsal/faaliyet/2016.pdf>>, 26.03.2023.

- SHGM (2017), *SHGM Faaliyet Raporu 2017*, <<https://web.shgm.gov.tr/documents/sivilhavacilik/files/kurumsal/faaliyet/2017.pdf>>, 26.03.2023.
- SHGM (2018), *SHGM Faaliyet Raporu 2018*, <<https://web.shgm.gov.tr/documents/sivilhavacilik/files/kurumsal/faaliyet/2018.pdf>>, 26.03.2023.
- SHGM (2019), *SHGM Faaliyet Raporu 2019*, <<https://web.shgm.gov.tr/documents/sivilhavacilik/files/kurumsal/faaliyet/2019.pdf>>, 26.03.2023.
- SHGM (2020), *SHGM Faaliyet Raporu 2020*, <<https://web.shgm.gov.tr/documents/sivilhavacilik/files/kurumsal/faaliyet/2020.pdf>>, 26.03.2023.
- SHGM (2021), *SHGM Faaliyet Raporu 2021*, <<https://web.shgm.gov.tr/documents/sivilhavacilik/files/kurumsal/faaliyet/2021.pdf>>, 26.03.2023.
- SHGM (2022), *SHGM Faaliyet Raporu 2022*, <<https://web.shgm.gov.tr/documents/sivilhavacilik/files/kurumsal/faaliyet/2022.pdf>>, 26.03.2023.
- Song, K.H. et al. (2020), “Competitiveness Evaluation Methodology for Aviation Industry Sustainability Using Network DEA”, *Sustainability*, 12(24), 10323.
- Su, M. et al. (2020), “The competition effects of low-cost carriers and high-speed rail on the Chinese aviation market”, *Transport Policy*, 95, 37-46.
- THY (N/A), *Faaliyet Raporları*, <<https://investor.turkishairlines.com/tr/mali-ve-operasyonel-veriler/faaliyet-raporlari>>, 26.03.2023.
- Van Reenen, J. (2011), “Does competition raise productivity through improving management quality?”, *International Journal of Industrial Organization*, 29(3), 306-316.
- Wanke, P. et al. (2015), “An analysis of Asian airlines efficiency with two-stage TOPSIS and MCMC generalized linear mixed models”, *International Journal of Production Economics*, 169, 110-126.
- Yaşar, M. & E. Gerede (2018), “Türkiye havayolu iç hat şehir çiftlerindeki pazar yapılarının piyasa yoğunlaşması ölçütleri ile belirlenmesi”, *Yönetim ve Ekonomi*, 25(1), 171-197.
- Yaşar, M. & K. Kiracı (2018), “Dünya Pazarlarında Piyasa Yapısı: Havayolu Sektöründe Rekabetin Ampirik Olarak Analizi”, *Uluslararası Yönetim İktisat ve İşletme Dergisi*, 14(3), 731-744.
- Yaşar, M. (2023), “Determinants of Market Structure and Demand: A Panel Data Study on Turkish Airports”, *Yönetim ve Ekonomi*, 30(1), 59-77.
- Young, G. et al. (1996), “‘Austrian’ and industrial organization perspectives on firm-level competitive activity and performance”, *Organization Science*, 7(3), 243-254.
- Yu, L. & W. Zhang (2013), “Research on the intensity and effect of industrial administrative monopoly in China”, in: *The Chinese Anti-Monopoly Law: New Developments and Empirical Evidence* (194-217), Edward Elgar, Cheltenham.
- Zhang, Q. et al. (2014), “Market power and its determinants in the Chinese airline industry”, *Transportation Research Part A: Policy and Practice*, 64, 1-13.

Kulüp Yakınsama Analizi Temelinde OECD Ülkelerinin Vergi Gayreti Performansı

Bilgen TAŞDOĞAN (https://orcid.org/0000-0001-5169-7862), Ankara Hacı Bayram Veli University, Türkiye; bilgen.tasdogan@hbv.edu.tr

Tax Effort Performance of OECD Countries Based on Club Convergence Analysis

Abstract

This study examines the tax effort performance of countries based on club convergence analysis. The study defined tax effort as a ratio of tax revenues to gross domestic product, and the estimation equation was analysed to converge countries in OECD and sub-clubs. According to the results of the estimation equation used for 34 OECD countries, although there is no statistically significant relationship between tax effort and the informal economy, it has been seen that the informal economy variable affects the tax effort for Club 4 countries where Türkiye is located. In addition, Denmark ranks first and Türkiye 24th in the tax effort ranking that considers OECD countries. In the ranking made for the club four countries, Israel is in the first place, and Türkiye is in the 4th place.

Keywords : Tax Effort, Club Convergence Analysis, Informal Economy, Tax Rates.

JEL Classification Codes : H2, H21, H26.

Öz

Bu çalışma, ülkelerin vergi gayreti performansını kulüp yakınsama analizi temelinde incelemektedir. Çalışmada vergi gayreti, vergi gelirlerinin gayrisafi yurtiçi hasılaya oranı olarak tanımlanmış ve tahmin denklemi OECD ülkeleriyle birbirine yakınsayan alt kulüplerde yer alan ülkeler için analiz edilmiştir. 34 OECD ülkesi için kullanılan tahmin denklemi sonuçlarına göre vergi gayreti ile kayıt dışı ekonomi arasında istatistiksel olarak anlamlı ilişki olmamasına rağmen, Türkiye'nin yer aldığı Kulüp 4 ülkeleri için kayıt dışı ekonomi değişkeninin vergi gayretini etkilediği görülmüştür. Ayrıca, OECD ülkelerinin tümünü dikkate alan vergi gayreti sıralamasında Danimarka ilk Türkiye 24. sırada yer almaktadır. Kulüp 4 ülkeleri için yapılan sıralamada ise İsrail ilk Türkiye ise 4. sırada bulunmaktadır.

Anahtar Sözcükler : Vergi Gayreti, Kulüp Yakınsama Analizi, Kayıt Dışı Ekonomi, Vergi Oranları.

1. Giriş

Hükümetler vergi politikalarının optimizasyonu ve mali performanslarını ölçmek için genellikle uluslararası karşılaştırmalara ihtiyaç duymaktadır. Vergi gayreti karşılaştırmalarının kullanımı ise genellikle iç mali analizler için gerekli görülmektedir. Vergi gayretini ölçmek amacıyla kullanılan modeller bir taraftan ülkenin performans sıralamasını gösterirken diğer taraftan vergilendirme kapasitesinin düşük olup olmadığını tespit ederek karar alıcılarının mevcut durumu iyileştirebilmesi için fizibilite imkânı sunmaktadır. Vergi gayreti kavramının literatürde yaygın olarak kullanılan şekli; tahsil edilen vergilerin tahakkuk edilen vergilere (tahmin edilen vergi gelirleri) oranından elde edilen bir endeksi temel almakta ve ülkeler arası karşılaştırmalarda sıklıkla kullanılmaktadır. Burada tahmin edilen vergi gelirleri bir ülkenin vergilendirilebilir kapasitesini temsil etmektedir. Bu yönetime göre bir ülkenin endeks değeri; örneklem olarak seçilen ülkelerin ortalama vergileme seviyesinin altında veya üstünde olduğunu göstermekle birlikte mevcut durumunu değiştirmek için ne yapılması gerektiğine dair bilgi vermemektedir (Bahl, 1971: 573-574). Oysaki gelişmiş veya gelişmekte olan ülkeler açısından vergi kapasitesi, vergi yükü ve/veya vergi gayretini belirleyen birçok değişken olduğu bilinmektedir. Özellikle vergi sisteminin yapısı, vergi idaresinin etkinliği, kayıt dışı ekonominin varlığı gibi değişkenlerin etkileri önemli görülmektedir (Çelikay, 2017: 171). Buna ek olarak bir ekonomide vergi kapasitesinin büyüklüğü yurtiçi hâsıla, gelir dağılımı, ekonominin parasallaşma derecesi, vergi ahlakı, ekonominin sektörel yapısı, vergi kaçakçılığı, vergiden kaçınma gibi birçok faktör tarafından da sınırlandırılmaktadır (Şen & Sağbaş, 2016: 165). Dolayısıyla vergi kapasitesi, vergi yükü/vergi gayreti performansının doğru bir şekilde ölçülebilmesi için bu değişkenleri etkileyen faktörlerin dikkate alınmasında yarar bulunmaktadır.

Vergi gayretini etkileyen değişkenleri dikkate alarak ülkelerin vergi performansını ölçen çalışmalarda; vergi gayreti değişkenini temsilen vergi gelirlerinin yurtiçi hasılaya oranı¹ yaygın bir şekilde kullanılmaktadır. Lotz ve Morss (1967) vergi gelirlerinin ulusal gelir içindeki paylarını vergi gayreti olarak tanımlayan ilk istatistiksel çalışmayı yaparak 72 ülke için bir sıralama yapmıştır. Çalışmada bağımlı değişken olarak vergi gelirlerinin yurtiçi hasılaya oranı (T/Y) ve bağımsız değişkenler kişi başına yurtiçi hasıla (Y_p) ve dış ticaretin yurtiçi hasılaya oranı (ülkenin dışa açıklık düzeyi) (F/Y) kullanılmıştır. Regresyon tahmin sonuçlarından elde edilen kalıntı değerlerine göre de ülkelerin vergi gayreti sıralanmış ve yüksek gelirli ülkeler ile düşük gelirli ülkeler için regresyon tahmini tekrarlanarak ülkelerin vergi gayreti sıralamasının bağımsız değişken sayısına bağlı olarak değişebildiği tespit edilmiştir. Çalışmada yer alan tahmin denklemi şu şekilde tanımlanmıştır;

$$\frac{T}{Y} = a_1 + b_1 Y_p \quad (1)$$

¹ Vergi Gelirlerinin Gayrisafi Yurtiçi Hasılaya Oranı literatürde kamu kesimi büyüklüğünün ölçümünde de kullanılmasına rağmen bu oranının kamu kesimi büyüklüğünü temsil edebilmesi için denk bütçe veya buna yakın bir durumun olması gerektiği vurgulanmaktadır (Şen & Kaya, 2019: 109).

Bu denklem ile kişi başına gelir seviyesindeki değişimin vergi gayreti üzerindeki etkileri dikkate alınarak gelir düzeylerine göre ülkelerin vergi gayreti sıralaması yapılmıştır. Buna ek olarak benzer bir şekilde denkleme ülkelerin dışa açıklık seviyesi bağımsız değişken olarak eklenmiş ve 49 ülke için yeniden tahmin sonuçları elde edilerek vergi gayreti sıralaması yapılmıştır.

$$\frac{T}{Y} = a_2 + b_2 Y_p + c_2 \frac{F}{Y} \quad (2)$$

Sonuç olarak bu iki tahmin denkleminde ülkelerin vergi gayreti sıralamasının değiştiği tespit edilmiştir. Shin (1969) gelişmiş ve gelişmekte olan ülkeleri temsil eden 47 ülke için Lotz ve Morss (1967)'de belirlenen denkleme tarım sektörünün ekonomideki payını, enflasyonu ve nüfus artışını ekleyerek tahmin yapmıştır. Bahl (1971) ve Chelliah vd., (1975) benzer bir metodolojiyi temel alarak farklı bağımsız değişkenleri modele dahil ederek vergi gayretini etkileyen faktörleri tahmin etmişlerdir.

$$\frac{T}{Y} = a_1 + b_1 Y_p + b_2 \frac{F}{Y} + b_3 (Y_p - X_p) + b_4 N_v + b_5 A_v + b_6 X_y \quad (3)$$

Bu denklemde ($Y_p - X_p$) ihracat gelirleri dışındaki kişi başına düşen geliri, N_v madencilik sektörünün yurtiçi hasıla içindeki payını, A_v tarımın yurtiçi hasıla içindeki payını ve X_y ihracat oranını temsil etmektedir. 47 ülke için yapılan bu çalışma her bir bağımsız değişken için tahmin denklemini tekrarlayarak ülkelerin vergi gayreti sıralamasını tespit etmektedir. Tait vd. (1979) aynı denklemi 63 ülke için tekrarlayarak tahminler yapmıştır. Piancastelli (2001) ise geleneksel vergi gayreti denklemi olarak kabul gören bu denklemi, 75 ülke için 1985-1995 dönemine ait panel veri seti kullanarak tahmin etmiştir.

Gupta (2007) geleneksel vergi gayreti denkleminde yer alan değişkenlerden farklı olarak yolsuzluk endeksini bağımsız değişken olarak eklemiş ve 105 ülke için 1980-2004 dönemi panel veri setini kullanarak tahmin yapmıştır. Le vd. (2012) bürokrasi ve kayıt dışı ekonomi değişkenlerini denkleme ekleyerek gelişmekte olan 110 ülke için vergi gayretini etkileyen değişkenleri tahmin etmiştir. Dioda (2012) sivil özgürlükler endeksi, politik haklar, siyasi istikrar, kentleşme, eğitim düzeyi ve kayıt dışı ekonomi değişkenleri gibi değişkenleri üç grupta toplayarak ekonomik, sosyodemografik ve politik değişkenleri içeren göstergeleri modele dahil ederek tahmin yapmıştır.

Vergi gayreti ölçümleri alanında ilgili literatür zaman içerisinde oldukça geniş bir değişken seti kullanmıştır. Bağımlı değişken olarak vergi gelirlerinin gayrisafi yurtiçi hasıla içindeki payının yanı sıra vergi ve vergi dışı gelirler, merkezi hükümet gelirleri, sosyal güvenlik katkıları dışında kalan vergiler yaygın olarak kullanılmaktadır. Bağımsız değişkenler ise üç grupta toplanmaktadır. Bunlar; Ekonomik, demografik ve yönetim veya kurumsal değişkenlerdir (McMabb et al., 2021: 3-4). Her ne kadar gözlem yapılan ülke sayısının değişmesi ve bağımlı veya bağımsız değişkenlerdeki farklılıklar bulgular açısından katkılar sunmuş olsa da vergi gayreti literatüründe yerleşik metodoloji tahmin

denklemindeki kalıntı değerlerini dikkate alarak ülkeleri veya ülke gruplarını tanımlayan bir sıralama oluşturmaktadır.

Bu çalışmanın literatürde yer alan geleneksel uygulamalardan farkı Phillips ve Sul (2007) tarafından geliştirilen kulüp yakınsama yöntemi ile tahmin denkleminde yer alacak ülke gruplarının önceden belirlenerek panel veri gözlemlerinin ayrıştırılması ve tahmin denkleminin birbirine yakınsayan ülkeleri dikkate almasıdır. Geleneksel yöntemde önce tahmin yapılmakta daha sonra ülkeler ve ülke grupları ayrıştırılmaktadır. Dolayısıyla elde edilen tahminlerde birbirine yapısal olarak benzemeyen ülke gözlemlerine dayanan bir tahmin sonucu ile vergi gayretini etkileyen değişkenler analiz edilmektedir. Bu çalışmada ise 34 OECD üyesi ülke önce kendi içinde yakınsama derecelerine göre alt kulüplere ayrıştırılmakta daha sonra da tahmin denklemi hem 34 OECD üyesi ülke için hem de içinde Türkiye'nin de yer aldığı alt kulüp için analiz edilerek kalıntı değerleri sonuçlarına göre vergi gayreti sıralamaları elde edilmektedir.

2. Ampirik Literatür

Vergi gayreti ile ilgili ampirik literatür incelendiğinde tahmin denklemindeki geleneksel değişkenlere eklenen ekonomik, demografik ve kurumsal değişkenlerin yanı sıra farklı dönemler için farklı ampirik yöntemler ile ülkeler ve ülke gruplarının karşılaştırıldığı görülmektedir.

Cukierman vd. (1992) 79 ülke için panel veri yöntemi ile enflasyon ve senyoraj oranlarının vergi gayreti üzerindeki etkilerini hesaplamışlardır. Stotsky ve WoldeMariam (1997) 43 Afrika ülkesi için panel sabit etkiler modelini uygulamış ve tarımın gayrisafi yurtiçi hasıla içindeki payı ile ticari açıklık değişkenin vergi gayreti ile pozitif ilişkisi olduğunu buna karşın madencilik sektörünün hasıla içindeki payının vergi gayreti ile negatif ilişkisi olduğunu tespit etmiştir. Ghura (1998) 39 Afrika ülkesi için panel veri analizi uygulayarak ekonomik değişkenlere ek olarak enflasyon, reel döviz kurundaki değişme, yapısal reformlar, yolsuzluklar ve beşerî sermaye endeksini bağımsız değişkenler olarak tanımlamıştır. Elde edilen bulgulara göre enflasyon, yolsuzluk endeksi ve döviz kurunun vergi oranlarını negatif etkilediğini hesaplamıştır. Bird vd. (2004) tahmin denklemine kurumsal değişkenler olarak tanımlanan yolsuzlukla mücadele endeksi, yasal düzenlemelere uyum, yönetim ve şeffaflık endeksleri, kayıt dışı ekonomi ve bürokratik süreçlerin kalitesini ekleyerek tahmin sonuçları elde etmiştir. Latin Amerika ülkeleri için panel veri setine en küçük kareler yöntemi uygulamıştır. Gupta (2007) 105 ülkeyi düşük, orta ve yüksek gelir gruplarına ayırarak panel veri analizi uygulamıştır.

Pessino ve Fenochietto (2010) bir üretim fonksiyonu tanımlayarak 96 ülke için 1991-2006 dönemine ait panel veriler etkin sınır analizi ile test etmiştir. Elde edilen bulgular geleneksel değişkenler için benzer sonuçlar vermekle birlikte yolsuzluk seviyesinin vergi

gayretinde teknik etkinsizliğe yol açtığını tespit etmiştir². Benzer bir şekilde Cyan vd., (2013) ile Langford ve Ohlenburg (2016)'da panel veriler ile etkin sınır analizi uygulayarak farklı değişkenlerin vergi gayreti üzerindeki etkilerini incelemiştir. Ajaz ve Ahmad (2010) 25 gelişmekte olan ülke için panel veri analizi ile iyi yönetim ve kurumsal değişkenlerin vergi gelirleri üzerinde etkisi olduğunu tespit etmiştir. Besley ve Persson (2014) gelişmekte olan 18 ülke için panel veri analizi kullanarak geleneksel değişkenlere ek olarak kamu yönetiminde şeffaflık değişkeninin vergi gayretini etkilediğini tespit etmiştir. Lien (2015) gelişmekte olan 82 ülke için yönetim kalitesi ile vergi performansı arasındaki ilişkiyi incelemiştir. Benzer şekilde Topal ve Şahin OECD ülkeleri için yapmış olduğu çalışmada yönetim kalitesi ve vergi gelirleri arasındaki pozitif ilişkinin yüksek gelirli 15 OECD ülkesi için anlamlı olduğunu tespit etmiştir. Bu çalışmada dikkat çeken husus panel veri seti içinde yer alan tüm OECD ülkeleri için tahmin denkleminin anlamlı olmadığı, yalnızca yüksek gelirli ülkelerde yönetim kalite göstergeleri ile vergileme arasında istatistiksel olarak anlamlı bir ilişki bulunduğuudur. Çevik (2018) ise 135 ülke için demokrasi endeksi ile vergi gelirleri arasındaki ilişkiyi incelemiştir. Bird vd. (2008) gelişmiş ve gelişmekte olan ülkelerde ifade özgürlüğü ve şeffaflık/hesap verilebilirlik göstergeleri ile demokrasi seviyesi ve vergi gayreti arasındaki ilişkiyi incelemiştir.

Gelinen noktada vergi gayreti çalışmalarının yerleşik tahmin denklemine yeni değişkenler eklenerek genişletildiği görülmektedir (Günay & Topal, 2021: 418).

$$\frac{T}{Y} = f \left(Y_p, \frac{F}{Y}, N_v, A_v, X_y, \text{Yabancı Yatırımlar}, \text{Hibeler}, \text{Kentleşme}, \text{İyi Yönetişim}, \dots \right) \quad (4)$$

Buna ek olarak ampirik literatürde panel veri analizleri yaygın olarak tercih edilmekte bazı çalışmalarda ülkelerin gelir seviyesi (yüksek, orta, düşük), coğrafi dağılım (Afrika, Asya, Latin Amerika) ve ülkelerin üye oldukları kuruluşlar (OECD) gibi alt gruplara göre karşılaştırmalar yapılabilmektedir.

Bu çalışmada ise yerleşik literatürden farklı olarak tahmin denkleminde yer alması planlanan ülke verileri yakınsama analizleri ile alt gruplara ayrıştırılmaktadır. Yakınsama hipotezinin test edilmesi çalışmaları özellikle 1990'lı yıllardan itibaren artmaya başlamıştır. Quah (1993) ortalama bir yakınsama değerinin yanıtıcı olduğunu eşitsizliklerin yerel düzeydeki yansımaları ile özdeş olmayabileceğini bu nedenle bölgesel gelir eşitsizliklerinin yakınsama değeri incelenirken bölgelerin hangi gelir gruplarına yakınsadığının tespit edilmesi gerektiğini belirtmiştir. Kulüp yakınsama olarak tanımlanan bu yaklaşım Phillips ve Sul (2007) tarafından geliştirilen kümeleme yöntemi ile literatürde daha fazla yoğunlaşmıştır. Bu yöntemde analize konu olan ülkeler benzerliklerine göre gruplandırılmakta ve her bir grup içinde yakınsama olup olmadığını test ederek kendi aralarında yakınsama olan ülkeler ayrıştırılmaktadır. Bu yöntem Türkiye'de bölgesel gelir eşitsizlikleri için kulüp yakınsama analizlerinde kullanılmıştır (Apergis & Payne, 2007: 367; Aksoy et al., 2019; Karagöl et al., 2019; Yazgan & Ceylan, 2021; Ursavaş & Mendez, 2022).

² *Yolsuzluk seviyesi ve vergi gayreti arasındaki negatif ilişkiyi tespit eden çalışmalar için bkz. Sanyal et al. (2000); Fjeldstat & Tungodden (2003); Atilla (2008); Aghion et al. (2016); Baum et al. (2017).*

Kılıçarslan ve Dedeoğlu (2020) OECD ülkelerinde ticari açıklık yakınsaması; Şahin (2021) orta gelir grubu ülkelerde kamu harcaması yakınsaması; Ulucak (2017) ekolojik ayak izi üzerinden çevresel yakınsama; Apaydın vd. (2021) ekolojik ayak izi üzerinde küreselleşmenin etkilerini inceleyen yakınsama; Corrado vd. (2005) ile Bartkowska ve Riedl (2012) Avrupa ülkelerinde kişi başına gelir yakınsaması; Cavallaro ve Villani (2021) Avrupa Birliği ülkelerinde sektörel verimlilik yakınsaması; Glawe ve Mendez (2022) Avrupa Birliği ülkelerinde beşeri sermaye yakınsaması; Apergis ve Cooray (2014a) Avrupa Birliği'nde borç yükü yüksek olan ülkeler için borç oranı yakınsaması; Regis vd. (2015) Avrupa Birliği üyesi ülkelerin kurumlar vergisi yakınsaması; Apergis vd. (2013) Avrupa Birliği ülkelerinde kamu harcamaları yakınsaması; Delgado ve Presno (2017) Avrupa Birliği üyesi ülkelerde vergi yükü yakınsaması; Apergis ve Cooray (2014b) Güney Asya, Asya Pasifik ve Okyanus ülkeleri için vergi gelirleri yakınsaması analizlerinde Phillips ve Sul (2007) metodolojisini takip ederek kulüp yakınsama testleri ile bulgular elde etmişlerdir.

Phillips ve Sul (2007) kulüp yakınsama analiz yöntemi literatürde birçok farklı değişken için kullanılmakla beraber bu çalışmada ilk aşamada 34 OECD üyesi ülke için kayıt dışı ekonomi, vergi oranı ve vergi gayreti değişkenlerinde ülkelerin yakınsama dereceleri incelenmektedir. Ampirik analizin ikinci aşamasında uygulanan panel veri analizinde ise bağımlı değişken olarak tanımlanan vergi gayreti (Intaxeffort) ile bağımsız değişkenler olarak tanımlanan kayıt dışı ekonomiyi temsil eden değişken (Ininformal) ve vergi oranları değişkeni (Intaxrate) arasındaki ilişki incelenmektedir.

3. Yöntem

Çalışmada kullanılan veriler OECD veri tabanından alınmış ve 34 OECD üyesi ülkenin 2001-2021 döneminde kayıt dışı ekonomi, vergi oranı ve vergi gayreti değişkenleri incelenmektedir. Kayıt dışılığın azalması durumunda ekonomilerin vergilendirme kapasitesinin artacağı varsayımından hareketle kayıt dışı ekonomi değişkeni olarak dolaşımdaki nakit miktarının M2 para arzına oranı kullanılmaktadır (Tanzi, 1980: 290). Vergi oranı değişkeni; katma değer vergi gelirlerinin toplam vergi gelirleri³ içindeki payı ve vergi gayreti değişkeni; vergi gelirlerinin gayrisafi yurtiçi hasıla içindeki payı olarak tanımlanmıştır. Çalışmada Phillips ve Sul (2007) yöntemi ile kayıt dışı ekonomi, vergi gayreti ve vergi oranı değişkenleri için kulüp yakınsama (club convergence) analizleri yapılmıştır. Bu yöntemde analizde yer alan ülkeler gruplara ayrılarak gruplar arasında yakınsama olup olmadığı "log t" testi ile incelenmiştir.

Phillips ve Sul (2007) kulüp yakınsama yaklaşımının birkaç avantajı bulunmaktadır. Bunlar; (1) mutlak düzey yakınsama kavramının aksine görece yatay kesit ortalamalarının görece yakınsamasını ölçmekte, (2) durağan olmayan ve kademeli olarak yakınsayan serilerin analizinde standart birim kök testlerinden daha iyi performans göstermekte, (3) bir panel eşbütünleşme testinde saptanamayan doğrusal olmayan serilerin uzun dönemde

³ Toplam vergilerde olası karışıklığı giderebilmek adına tüm yönetim birimlerindeki toplam vergiler ve sosyal güvenlik katkıları birlikte ele alınmıştır.

yakınsamalarını tespit edebilmekte ve ayrıca panel eşbütünleşme testinde durağan ve durağan olmayan serilerin karışımında spesifikasyon tanımlama sorununu ortadan kaldırmaktadır. Sonuç olarak Phillips ve Sul (2007) kulüp yakınsama yaklaşımı birim kök ve eşbütünleşme test kısıtlarına bağlı olmamaktadır (Apergis & Payne, 2017: 367). Bir başka ifade ile Phillips ve Sul (2007) kulüp yakınsama yaklaşımı birimler arasında heterojenliğe izin veren ve zaman geçişli etkiyi içinde barındıran bir katsayıya dayanmaktadır.

Phillips ve Sul (2007) kulüp yakınsama yaklaşımı gözlemlenebilir seriler için zamanla değişen (time-varying) ortak faktör gösterimi için şu metodolojiyi takip etmektedir.

$$X_{it} = g_{it} + a_{it} \quad (5)$$

Denklem 5'te yer alan vergi gayreti değişkeni X_{it} , sistematik g_{it} ve geçici a_{it} olmak üzere iki bileşene ayrılmaktadır. Denklem 5 ortak unsurları kendine özgü (idiosyncratic) bileşenlerden ayırmak için dönüştürüldüğünde,

$$X_{it} = \left(\frac{g_{it} + a_{it}}{\mu_t} \right) \mu_t = \delta_{it} \mu_t \quad (6)$$

Denklem 6'da yer alan μ_t ortak bileşenleri ve δ_{it} kendine özgü bileşenleri temsil etmektedir. δ_{it} ise μ_t ile X_{it} arasındaki uzaklığı ölçen kendine özgü bileşeni olmakla beraber panelde bulunan her bir birim için ortak etki çarpanı olan μ_t 'nin payını ölçmektedir. Bu modelde δ_{it} katsayısı için yarı parametrik bir süreç uygulanmaktadır. Bu durumda ortak bileşen μ_t panel ortalamasına bölünerek elimine edilmekte ve göreceli geçiş patikasına ulaşılmaktadır.

$$h_{it} = \frac{X_{it}}{N^{-1} \sum_{i=1}^N X_{it}} = \frac{\delta_{it}}{N^{-1} \sum_{i=1}^N \delta_{it}} \quad (7)$$

Denklem 7'de yer alan h_{it} göreceli geçiş parametresini temsil etmektedir. Göreceli geçiş parametresi ülkeler arasında farklı olabilmekte ve her bir ülke için 1'e yaklaştıkça uzun dönem yakınsama çıkarımı vermektedir. Ancak yakınsama çıkarımı için yatay kesit varyansının sifra yaklaşması gerekmektedir.

$$h_{it} = \log X_{it} / \overline{\log t} \quad (8)$$

Yatay kesit varyansının logaritmik değerinin ortalaması h_{it} göreceli geçiş parametresi kullanılarak hesaplanmaktadır (Uluçak & Apergis, 2018: 21-27).

Yatay kesit varyansı $H_t = \frac{1}{N} \sum_{i=1}^N (h_{it} - 1)^2$ denklemi kullanılarak hesaplanmaktadır. Bu denklem panelin ortak değere uzaklığını göstermektedir. Panelde yer alan her bir yatay kesitin ortak değere uzaklığının test edilmesinde kullanılan hipotezler;

$$H_t: \delta_i = \delta_t ; \alpha \geq 0$$

$$H_t: \delta_i \neq \delta_t ; \alpha < 0$$

Dikkate alınarak "log t" regresyon denklemi test edilmektedir.

$$\log\left(\frac{H_t}{H_{t-1}}\right) - 2\log L(t) = c + b \log t + u_t \quad (9)$$

Denklem 9 için "t" testi sonucu %5 hata payı ile -1.65'ten küçük olduğunda koşullu yakınsama hipotezi reddedilmektedir. Benzer bir şekilde bu test alt gruplarda yakınsama olup olmadığını analiz etmek için de tekrarlanmaktadır.

Ampirik analizin *ikinci aşamasında* ise hem OECD ülkelerinin tamamı hem de içinde Türkiye'nin yer aldığı Kulüp için panel veri analizi yapılmaktadır. Bu analizde yer alan model ise şu şekildedir;

$$\ln taxeffort_{it} = \beta_0 + \beta_1 \ln informal_{it} + \beta_2 \ln taxrate_{it} + \varepsilon_{it} \quad (10)$$

Denklem 10'da yer alan β_0 sabit terimi ε_{it} ise hata terimini ifade ederken i yatay kesitleri t 'de zamanı temsil etmektedir. $\ln taxeffort$ vergi gayretini, $\ln informal$ kayıt dışı ekonomi değişkenini ve $\ln taxrate$ vergi oranı değişkenini temsil etmektedir.

4. Bulgular

Analiz bulgularında yer alan katsayılar değişkenler için yakınsama hızını vermekte ve her bir dönem için dengeye ne oranda yaklaşıldığını ifade etmektedir. Phillips ve Sul (2007) yönteminde ilk olarak panelin tümü için log t testi sonuçları hesaplanmakta sonrasında da alt gruplar ve kulüpler belirlenerek yakınsama katsayıları elde edilmektedir.

Tablo 1 kayıt dışı ekonomi değişkeni için 34 OECD üyesi ülkenin oluşturduğu tüm panelin yakınsama sonuçlarını vermektedir.

Tablo: 1
Kayıt Dışı Ekonomi Değişkeni İçin Log t Test Sonuçları

Değişken	Katsayı	Standart Hata	T istatistiği*
Kayıt Dışı Ekonomi	-1.116	0.024	-45.41

* T istatistiği kritik değeri -1.65'ten küçükse yakınsamanın kabul edildiği hipotez reddedilmektedir.

Tablo 1'de görüldüğü gibi 34 OECD üyesi ülke için yapılan kulüp yakınsama analiz sonuçlarına göre 2001-2021 dönemi için ülkeler arasında %5 hata payı t istatistiği -45,41 olarak hesaplanmıştır. Bu durumda kayıt dışı ekonomi değişkeni için oluşturulan tüm panelde ülkeler arasında bir yakınsama görülmemektedir. Tablo 2'de ise panel içinde yer alan alt gruplar ve kulüpler için Log t testi sonuçları sunulmaktadır.

Tablo 2'de 34 OECD ülkesi 5 farklı kulübe ayrılmakta ve her bir kulüp içindeki ülkeler kendi aralarında değerlendirildiğinde 2001-2021 döneminde Log t test sonuçları yakınsamanın var olduğunu göstermektedir. Bu bulgular OECD üyesi ülkelerin kayıt dışı ekonomi değişkeni açısından başlangıç koşulları ve yapısal parametrelerinin özdeş olmadığının tespiti açısından önemli görülmektedir. Buna karşın OECD üyesi ülkelerin yer

aldığı 5 farklı kulüp oluşması ve yakınsama kulüplerinin var olması politika yapıcılar için önemli bir gösterge olarak değerlendirilmektedir.

Tablo: 2
Kayıt Dışı Ekonomi Değişkeninde Alt Gruplar İçin Log t Test Sonuçları

Kulüpler	Ülkeler	Katsayı	T istatistiği*
Kulüp 1	Kolombiya, Yunanistan, Macaristan, Meksika, Slovenya	0,813	2,07
Kulüp 2	Çek Cumhuriyeti, Estonya, Finlandiya, Fransa, İrlanda, İsrail, İtalya, Portekiz, Polonya, İspanya, Endonezya	0,063	3,31
Kulüp 3	Avusturya, Belçika, Almanya, İzlanda, Hollanda, ABD	0,028	0,28
Kulüp 4	Şili, Japonya, Güney Kore, Türkiye	0,115	0,93
Kulüp 5	Avustralya, Kosta Rika, Danimarka, Lüksemburg, Norveç, İsveç, Brezilya, Güney Afrika	-0,058	-1,57

* T istatistiği kritik değeri -1,65'ten küçükse yakınsamanın kabul edildiği hipotez reddedilmektedir.

Tablo 3'te görüldüğü gibi kulüpler arasındaki yakınsama analizinde yalnızca Kulüp 3 ve Kulüp 4'te yer alan ülkelerin kendi aralarında uzun dönem için Log t test istatistiği kritik değer olan -1,65'ten büyüktür. Bu durumda uzun dönemde söz konusu kulüplerde yer alan ülkeler için yakınsamanın varlığı kabul edilmektedir.

Tablo: 3
Kayıt Dışı Ekonomi Değişkeni için Kulüpler Arası Log t Test Sonuçları

Kulüpler	Katsayı	T istatistiği*
Kulüp 1+2	-0,62	-17,11
Kulüp 2+3	-0,329	-8,59
Kulüp 3+4	0,015	0,14
Kulüp 4+5	-0,483	-12,79

* T istatistiği kritik değeri -1,65'ten küçükse yakınsamanın kabul edildiği hipotez reddedilmektedir.

Tablo 4'te görüldüğü gibi 34 OECD üyesi ülke için yapılan kulüp yakınsama analiz sonuçlarına göre 2001-2021 dönemi için ülkeler arasında %5 hata payı t istatistiği -109,18 olarak hesaplanmıştır. Bu durumda vergi oranı değişkeni için oluşturulan tüm panelde ülkeler arasında bir yakınsama tespit edilememiştir.

Tablo: 4
Vergi Oranı Değişkeni İçin Log t Test Sonuçları

Değişken	Katsayı	Standart Hata	T istatistiği*
Vergi Oranı	-0,817	0,007	-109,18

* T istatistiği kritik değeri -1,65'ten küçükse yakınsamanın kabul edildiği hipotez reddedilmektedir.

Tablo: 5
Vergi Oranı Değişkeninde Alt Gruplar İçin Log t Test Sonuçları

Kulüpler	Ülkeler	Katsayı	T istatistiği*
Kulüp 1	Şili, Macaristan	0,088	11,42
Kulüp 2	Kolombiya, Kosta Rika, Çek Cumhuriyeti, Estonya, Finlandiya, Yunanistan, İsrail, Meksika, Polonya, Portekiz, Slovenya, Türkiye	0,356	1,28
Kulüp 3	Avustralya, Avusturya, Belçika, Danimarka, Fransa, Almanya, İzlanda, İrlanda, İtalya, Hollanda, Norveç, İspanya, İsveç, Endonezya	0,513	6,27
Kulüp 4	Japonya, Güney Kore, Lüksemburg, ABD, Brezilya, Güney Afrika	0,108	1,26

* T istatistiği kritik değeri -1,65'ten küçükse yakınsamanın kabul edildiği hipotez reddedilmektedir.

Tablo 5'te 34 OECD ülkesi 4 farklı kulübe ayrılmakta ve kulüp içindeki ülkeler kendi aralarında değerlendirildiğinde 2001-2021 döneminde Log t test sonuçları yakınsamanın var olduğunu göstermektedir. Bu bulgular OECD üyesi ülkelerin tümünde vergi oranı değişkeni

açısından başlangıç koşulları ve yapısal parametrelerinin özdeş olmadığı gösterirken OECD üyesi ülkelerin yer aldığı 4 farklı kulüp için yakınsama kulüplerinin var olduğu tespit edilmektedir.

Tablo: 6
Vergi Oranı Değişkeni için Kulüpler Arası Log t Test Sonuçları

Kulüpler	Katsayı	T istatistiği*
Kulüp 1+2	-0,578	-15,76
Kulüp 2+3	-0,576	-31,22
Kulüp 3+4	-0,436	-17,5

* T istatistiği kritik değeri -1,65'ten küçükse yakınsamanın kabul edildiği hipotez reddedilmektedir.

Tablo 6'da görüldüğü gibi kulüpler arasındaki yakınsama analizinde yer alan ülkelerin kendi aralarında uzun dönem için Log t test istatistiği kritik değer olan -1,65'ten küçüktür. Bu durumda uzun dönemde söz konusu kulüplerde yer alan ülkeler için yakınsamanın olmadığı görülmektedir.

Tablo 7 vergi gayreti değişkeni için 34 OECD üyesi ülkenin oluşturduğu tüm panelin yakınsama sonuçlarını vermektedir.

Tablo: 7
Vergi Gayreti Değişkeni İçin Log t Test Sonuçları

Değişken	Katsayı	Standart Hata	T istatistiği*
Vergi Gayreti	-1,035	0,018	-57,46

* T istatistiği kritik değeri -1,65'ten küçükse yakınsamanın kabul edildiği hipotez reddedilmektedir.

Tablo 7'de görüldüğü gibi 34 OECD üyesi ülke için yapılan kulüp yakınsama analiz sonuçlarına göre 2001-2021 dönemi için ülkeler arasında %5 hata payı t istatistiği -57,46 olarak hesaplanmıştır. Bu durumda vergi gayreti değişkeni için oluşturulan tüm panelde ülkeler arasında bir yakınsama görülmemektedir. Tablo 8'de ise panel içinde yer alan alt gruplar ve kulüpler için Log t testi sonuçları sunulmaktadır. Tablo 8'de 34 OECD ülkesi 6 farklı kulübe ayrılmakta ve bunlardan 5 kulüp içindeki ülkeler kendi aralarında değerlendirildiğinde 2001-2021 döneminde Log t test sonuçları yakınsamanın var olduğunu göstermektedir. 6. Kulüpte yer alan Endonezya için diğer ülkelerden farklı olarak yakınsama bulgusuna ulaşılamamaktadır.

Tablo: 8
Vergi Gayreti Değişkeninde Alt Gruplar İçin Log t Test Sonuçları

Kulüpler	Ülkeler	Katsayı	T istatistiği*
Kulüp 1	Danimarka, Fransa, Yunanistan, İtalya	0,868	5,68
Kulüp 2	Avusturya, Belçika, Finlandiya, Almanya, Japonya, Hollanda, Portekiz, İsveç	0,152	2,06
Kulüp 3	Çek Cumhuriyeti, Estonya, Macaristan, İzlanda, Lüksemburg, Norveç, Polonya, Slovenya, İspanya	0,036	0,43
Kulüp 4	Avustralya, Kosta Rika, İrlanda, İsrail, Güney Kore, Meksika, Türkiye, ABD, Brezilya, Güney Afrika	0,009	0,14
Kulüp 5	Şili, Kolombiya	0,0423	13,59
Kulüp 6	Endonezya	-	-

* T istatistiği kritik değeri -1,65'ten küçükse yakınsamanın kabul edildiği hipotez reddedilmektedir.

Dolayısıyla bu bulgular OECD üyesi ülkelerin vergi gayreti değişkeni açısından başlangıç koşulları ve yapısal parametrelerinin özdeş olmadığının tespiti açısından önemli

görülmektedir. Buna karşın OECD üyesi ülkelerin yer aldığı 5 farklı kulüp için yakınsama kulüplerinin var olduğu tespit edilmiştir.

Tablo: 9
Vergi Gayreti Değişkeni için Kulüpler Arası Log t Test Sonuçları

Kulüpler	Katsayı	T istatistiği*
Kulüp 1+2	0,105	1,47
Kulüp 2+3	-0,065	-0,13
Kulüp 3+4	-0,386	-10,11
Kulüp 4+5	-0,098	-1,83
Kulüp 5+6	-0,956	-205,12

* T istatistiği kritik değeri -1,65'ten küçükse yakınsamanın kabul edildiği hipotez reddedilmektedir.

Tablo 9'da görüldüğü gibi kulüpler arasındaki yakınsama analizinde yalnızca Kulüp 1 ve Kulüp 2 ile Kulüp 2 ve Kulüp 3'te yer alan ülkelerin kendi aralarında uzun dönem için Log t test istatistiği kritik değer olan -1,65'ten büyüktür. Bu durumda uzun dönemde söz konusu kulüplerde yer alan ülkeler için yakınsamanın var olduğu görülmektedir.

Kayıt dışı ekonomi, vergi gayreti ve vergi oranları değişkenlerini dikkate alan yakınsama analizleri ile tespit edilen duruma göre OECD ülkelerinin tümü dikkate alındığında ülkeler arasında uzun dönemde bir yakınsamanın olmadığı görülmüştür. Bununla birlikte ülkeleri alt kulüplere ayırarak yapılan yakınsama analizinde kayıt dışı ekonomi değişkeni için elde edilen 5 farklı kulüpte yer alan ülkelerin kendi içinde uzun dönemde yakınsadığı, benzer bir şekilde vergi gayreti değişkeni için elde edilen 5 farklı kulüpte (kulüp üyesi ülkeler değişmektedir) yer alan ülkelerin kendi aralarında yakınsadığı ve son olarak vergi oranı değişkeni için elde edilen 4 farklı kulüpte (kulüp üyesi ülkeler değişmektedir) yer alan ülkelerin de kendi aralarında yakınsadığı görülmüştür. Türkiye kayıt dışı ekonomi ve vergi gayreti değişkenleri için yapılan analizlerde Kulüp 4'teki ülkeler ile uzun dönemde yakınsama gösterirken vergi oranı değişkeninin de Kulüp 2'deki ülkelere yakınsamaktadır. Buna ek olarak kulüpler arasında bir yakınsamanın varlığı için yapılan testlerde ise vergi gayreti değişkeni açısından içinde Türkiye'nin de yer aldığı Kulüp 4 ile diğer kulüpler arasında uzun dönemde bir yakınsama olmadığı görülmektedir.

Elde edilen bulgulardan görüldüğü üzere OECD ülkelerinin tümü dikkate alındığında ülkeler arasında bir yakınsama olmadığı buna karşın alt kulüplere ayrıştırıldığında farklı kulüplerdeki ülkelerin kendi kulüplerindeki ülkelere yakınsadığı görülmektedir. Ayrıca tahmin denkleminde yer alan her bir değişken için yapılan analiz sonuçlarında da bir ülke seçilen değişkene göre farklı kulüpler içerisinde yer alabilmektedir. Bu çalışmanın odağında yer alan ve tahmin denkleminde bağımlı değişken olan vergi gayreti değişkenine göre Türkiye Kulüp 4'te yer alan ülkelere yakınsamakta bu nedenle analizin ikinci aşamasında Denklem 10'da yer alan model temelinde 34 OECD üyesi ülke ve vergi gayreti yakınsama analiz sonuçlarına göre içinde Türkiye'nin de bulunduğu Kulüp 4'te yer alan 10 ülke için panel veri analizi yapılmaktadır. Panel veri analizinde vergi gayretini etkilediği beklenen kayıt dışı ekonomi ve vergi oranı değişkenlerinin etkileri incelenerek tahmin denkleminin kalıntı değerlerine göre ülkelerin vergi gayreti sıralaması elde edilmektedir.

Tablo: 10
Modelde Yer Alan Değişkenlere Ait Özet İstatistikler

Değişken	Intaxeffort	lninformal	Intaxrate
Gözlem	646	646	646
Ortalama	3,42	-2,62	3,45
Std. Sapma	0,32	0,68	0,25
Varyans	0,10	0,46	0,06
Min	2,38	-5,75	2,77
Max	3,91	-1,43	4,12
Skewness	-1,19	-1,23	-0,27
Kurtosis	4,17	5,79	2,99
Olasılık (S-K)	0,000***	0,000***	0,021**
Jarque-Bera	29,12	50,99	23,24
Olasılık	0,000***	0,000***	0,000***

*** ve ** sırasıyla %1 ve %5 hata paylarını temsil etmektedir.

Tablo 10'da görüldüğü gibi 646 gözlem sayısı ile değişkenlerin panel veri analizi için uygun olduğu söylenebilir. Buna ek olarak vergi oranları değişkeni (Intaxrate) 4,12 ile maksimum değeri verirken kayıt dışı ekonomi değişkeni (lninformal) -5,75 ile en düşük değere sahip olmaktadır. Skewness (çarpıklık) ve Kurtosis (basıklık) istatistiklerinin değerleri, bir veri dağılımının normal dağılıma ne kadar benzediğini belirlemek için kullanılmaktadır. İdeal durumda normal bir dağılım için Skewness'in sıfıra eşit olması gerekmektedir. Negatif Skewness sola çarpık bir dağılımı göstermektedir. Normal dağılımın Kurtosis değeri ise genellikle 3'tür. Olasılık değerleri de Skewness ve Kurtosis değerlerinin istatistiksel olarak anlamlılığını ifade etmektedir. Jarque-Bera test sonuçlarına bakıldığında ise değişkenlerin normal bir dağılıma sahip olmadığı görülmektedir. Dolayısıyla değişkenler arasındaki korelasyonun incelenebilmesi için Spearman Korelasyon testi uygulanmıştır.

Tablo: 11
OECD Ülkeleri İçin Spearman Korelasyon Testi

	Intaxeffort	lninformal	Intaxrate
Intaxeffort	1		
lninformal	-0,19	1	
Intaxrate	-0,21	0,24	1

Tablo 11'e bakıldığında teorik ve ampirik literatüre benzer bir şekilde kayıt dışı ekonomi ve vergi oranları değişkenleri ile vergi gayreti değişkeni arasındaki ilişki negatif korelasyona sahip iken vergi oranları ile kayıt dışı ekonomi değişkeni arasındaki korelasyon pozitifdir. Buna ek olarak korelasyon katsayıları 0,80'nin altında olduğu için modelde çoklu bağlantı olmadığı sonucuna da ulaşılmaktadır.

Tablo: 12
Kulüp 4 Ülkeleri İçin Spearman Korelasyon Testi

	Intaxeffort	lninformal	Intaxrate
Intaxeffort	1		
lninformal	-0,37	1	
Intaxrate	-0,38	0,22	1

Tablo 12'de yer alan Kulüp 4 üyesi ülkeler için yapılan korelasyon testi sonuçlarının da OECD üyesi ülkeler için yapılan korelasyon testleri ile benzerlik gösterdiği tespit edilmiştir.

Tablo: 13
Model Seçimi

Modeller	F Testi		B-P LM		Hausman Testi		Belirlenen Model
	İstatistik	p değeri	İstatistik	p değeri	İstatistik	p değeri	
OECD	41,07	0,000***	5396,12	0,000***	1,63	0,44	Rassal Etkiler
Kulüp 4	10,17	0,000***	1100,72	0,000***	3,94	0,13	Rassal Etkiler

*** %1 hata payını temsil etmektedir.

Tablo 13'e göre model seçimi yapılırken F testi, Breusch-Pagan LM testi ve son olarak Hausman Testi kullanılmaktadır. Elde edilen bulgular çerçevesinde hem OECD ülkeleri hem de Kulüp 4 ülkeleri analizi için rassal etkiler modeli tercih edilmiştir. Bu model kapsamında yatay kesit bağımlılığı, otokorelasyon ve değişen varyans testleri de Tablo 14'te sunulmaktadır.

OECD ülkeleri verileri dikkate alındığında 34 ülkenin verileri kullanılmakta ve yatay kesit boyutu zaman boyutundan büyük ($N > T$) olduğu için CD testi uygulanmaktadır (Pesaran, 2004: 5). Otokorelasyon testi için Bhargava, Franzini ve Narendranathan (1982) Durbin-Watson Test İstatistiği ve Baltagi-Wu LBI (1999) istatistikleri kullanılmaktadır. Değişen varyans probleminin testi için de Değiştirilmiş Wald istatistiği uygulanmaktadır (Greene, 2012: 568).

Tablo: 14
Yatay Kesit Bağımlılığı, Değişen Varyans ve Otokorelasyon Testleri

	Pesaran CD		Wald İstatistiği		Durbin-Watson	Baltagi-Wu LBI
	χ^2	p istatistiği	χ^2	p istatistiği		
OECD	10,21	0,000***	7614,60	0,000***	0,42	0,57
	Breusch-Pagan LM					
Kulüp 4	135,89	0,000***	1787,32	0,000***	0,48	0,30

*** %1 hata payını temsil etmektedir.

Tablo 14'e bakıldığında Durbin Watson ve Baltagi-Wu istatistiklerinin 2 değerine yakın olması durumunda otokorelasyon sorunu olmadığına karar verilirken bu değerlerin söz konusu koşulu karşılayamadığı görülmektedir. Dolayısıyla modelde otokorelasyon sorunu bulunmaktadır. Pesaran CD (2004) yatay kesit bağımlılığı olmadığını temsil eden H_0 hipotezi reddedilirken benzer bir şekilde Wald istatistik değerine bakıldığında da değişen varyans yoktur şeklinde tanımlanan H_0 hipotezi reddedilmektedir. Sonuç olarak belirlenen modelde otokorelasyon, değişen varyans ve yatay kesit bağımlılığı problemleri bulunmaktadır.

Kulüp 4 ülkeleri verileri dikkate alındığında 10 ülkenin verileri kullanılmaktadır. Breusch ve Pagan (1980)'e göre yatay kesit boyutu zaman boyutundan küçük ($N < T$) olduğu için LM testi uygulanmaktadır. Tablo 14'te yer alan LM testi sonuçlarına göre modelde yatay kesit bağımlılığı bulunmaktadır. Benzer bir şekilde Wald testi sonucuna göre modelde değişen varyans sorunu tespit edilmiştir. Son olarak Bhargava, Franzini ve Narendranathan (1982) Durbin-Watson Test İstatistiği ve Baltagi-Wu LBI (1999) testleri sonuçları modelde otokorelasyon sorunu olduğunu göstermektedir.

Analizde kullanılan modelde değişen varyans, otokorelasyon ve yatay kesit bağımlılığı söz konusu olması hata teriminin varyans kovaryans matrisinin birim matrisine eşit olmadığı şeklinde yorumlanmaktadır. Bu tür durumlarda zaman tutarsızlığı ortaya çıkmakla beraber varyansların ve standart hataların (t), (F) istatistikleri ile (R^2) güven aralıkları geçerliliği etkilenmektedir. Dolayısıyla bahsi geçen sorunların olması durumunda parametre tahminlerine dokunulmadan dirençli standart hatalar elde edilmeli veya model sorunlardan arındırılarak yeniden tahmin edilmelidir (Dücan, 2015: 200).

Beck ve Katz (1995) dirençli standart hatalar elde edilebilmesi için "panel düzeltilmiş standart hataları (PCSE) yöntemini önermektedir. Değişen varyans ve birimler arası korelasyonun olduğu, hata yapısının genel AR(1) sürece sahip olduğu modelin Prais-Winsten AR(1) düzeltme regresyon yapısı kullanılarak düzeltilmesiyle elde edilen kalıntılarından panel düzeltilmiş standart hatalar (PCSE) elde edilmektedir. Bu yöntemde AR(1) Otokorelasyon katsayıları -1 ile 1 arasında kısıtlandığı için parametreler ve standart hatalar daha önce elde edilmiş sonuçlardan farklı çıkmaktadır (Dücan, 2015: 203). PCSE yöntemi değişen varyans ve otokorelasyonun olduğu durumda dahi güvenilir sonuçlar vermekte (Beck & Katz, 1995: 641) ve buna ek olarak Moundinbaye vd. (2018) çalışmasında PCSE tahmincisinin hem $1,50 < T/N$ hem de $1,50 > T/N$ olduğu durumlarda hipotez testi için anlamlı sonuçlar elde edilmektedir.

Tablo: 15
OECD Ülkeleri İçin PCSE Tahmin Sonuçları

Değişkenler (Bağımlı Değişken Intaxeffort)	Katsayı	Panel Düzeltilmiş Standart Hata	p olasılık değeri
Ininformal	-0,12	0,013	0,354
Intaxrate	-0,32	0,051	0,000***
Sabit	4,52	0,18	0,000***
Modellere ait istatistikler		R^2 0,95 Wald χ^2 45,51 Wald Olasılık 0,000***	

*** %1 hata payını temsil etmektedir.

Tablo 15'te görüldüğü üzere sabit parametrenin de dahil olduğu tüm parametrelerin istatistiki olarak anlamlılığını sınavan Wald testine göre model istatistiksel olarak anlamlıdır. R^2 değeri %95 olduğu ve AR(1) sürecinin uygulandığı Prais-Winsten regresyon modelinin tahmininde bağımlı değişkendeki değişimin %95'inin açıklandığı söylenebilir. Buna ek olarak bağımsız değişkenlerden Ininformal değişkenin istatistiksel olarak anlamsız olduğu tespit edilirken vergi oranlarını temsil eden Intaxrate değişkeni beklenildiği gibi negatif değer aldığı ve istatistiksel olarak %1 hata payı ile kabul edilebileceği görülmektedir. Dolayısıyla vergi gayreti ile vergi oranı arasındaki ilişki ters yönlü olarak tespit edilmiş ve vergi oranları %1 arttığında vergi gayretinin yaklaşık %0,32 azaldığı hesaplanmıştır.

OECD ülkeleri tahmin denkleminin kalıntı değerleri ise Tablo 16'da sunulmakta ve elde edilen kalıntı değerlerine göre ülkelerin vergi gayreti sıralaması yapılmaktadır.

Tablo: 16
OECD Ülkeleri Vergi Gayreti Sıralaması

	Vergi Gayreti Sırası	Kalıntı Değeri
Danimarka	1	0,36
Fransa	2	0,35
Finlandiya	3	0,34
İtalya	4	0,32
Belçika	5	0,30
Macaristan	6	0,30
Avusturya	7	0,29
Yunanistan	8	0,26
Slovenya	9	0,26
İsveç	10	0,23
Almanya	11	0,18
Hollanda	12	0,16
Norveç	13	0,15
Portekiz	14	0,15
Estonya	15	0,14
Çek Cumhuriyeti	16	0,13
Polonya	17	0,12
İzlanda	18	0,11
İspanya	19	0,07
Lüksemburg	20	0,03
İsrail	21	0,01
Brezilya	22	-0,05
Japonya	23	-0,11
Türkiye	24	-0,19
Avustralya	25	-0,20
İrlanda	26	-0,21
Güney Afrika	27	-0,28
Kosta Rika	28	-0,29
ABD	29	-0,29
Güney Kore	30	-0,30
Şili	31	-0,36
Kolombiya	32	-0,38
Meksika	33	-0,67
Endonezya	34	-0,93

Tablo 16'ya göre vergi gayreti sıralamasında 34 OECD ülkesi içinde Danimarka 0.36 kalıntı değeri ile ilk sıra da yer almaktadır. Türkiye ise 24. Sırada bulunmaktadır. Her ne kadar yapısal olarak birbirinden farklı ülkelerden oluşan OECD grubu içindeki sıralama literatürde yer alan geleneksel yöntemlere benzerlik göstermiş olsa da alt külelere ayrıştırılan ve vergi gayreti açısından birbirine yakınsayan ülkelerin tahmin sonuçları ve sıralamaları farklılık göstermektedir.

Tablo: 17
Kulüp 4 Ülkeleri İçin PCSE Tahmin Sonuçları

Değişkenler (Bağımlı Değişken Intaxeffort)	Katsayı	Panel Düzeltilmiş Standart Hata	p olasılık değeri
lninformal	-0,16	0,036	0,000***
Intaxrate	-0,21	0,036	0,000***
Sabit	3,48	0,20	0,000***
Modellere ait istatistikler		R ² 0,96 Wald χ^2 41,53 Wald Olasılık 0,000***	

*** %1 hata payını temsil etmektedir.

Tablo 17'de sunulan sabit parametrenin de dahil olduğu tüm parametrelerin istatistikî olarak anlamlılığını sınavan Wald testine göre model istatistiksel olarak anlamlıdır. R²

değeri %96 olduğu ve AR(1) sürecinin uygulandığı Prais-Winsten regresyon modelinin tahmininde bağımlı değişkendeki değişimin %96'sının açıklandığı görülmektedir. OECD ülkeleri için tahmin edilen modelden farklı olarak lninformatel değişkenin ve vergi oranlarını temsil eden Intaxrate değişkenlerinin beklenildiği gibi negatif değer aldığı ve istatistiksel olarak %1 hata payı ile anlamlı olduğu tespit edilmiştir. Dolayısıyla vergi gayreti ile vergi oranı ve kayıt dışı ekonomi arasındaki ilişki ters yönlüdür. Bu durumda kayıt dışı ekonomi ve vergi oranları %1 arttığında vergi gayretinin sırasıyla %0,16 ve 0,21 azaldığı görülmektedir.

Tablo: 18
Kulüp 4 Ülkeleri Vergi Gayreti Sıralaması

	Vergi Gayreti Sırası	Kalıntı Değeri
İsrail	1	0,26
Brezilya	2	0,15
İrlanda	3	0,08
Türkiye	4	0,07
ABD	5	0,05
Kosta Rika	6	-0,03
Avusturya	7	-0,07
Güney Afrika	8	-0,09
Güney Kore	9	-0,18
Meksika	10	-0,22

Tablo 18'e göre Türkiye OECD ülkeleri içinde vergi gayreti sıralamasında 24. sırada yer almasına rağmen Kulüp 4 ülkeleri içinde 4. sırada yer almaktadır.

5. Sonuç

Hükümetlerin mali performanslarını ölçmek için kullandığı vergi gayreti karşılaştırmalarında iki farklı yöntem uygulanmaktadır. Bunlardan birincisi, tahsil edilen vergilerin tahakkuk edilen (beklenen) vergilere oranından elde edilen bir endekstir. Uluslararası karşılaştırmalar için sıklıkla kullanılan bu endeksin en önemli dezavantajı vergi gayretini etkileyen değişkenlerin ne olduğuna dair bir bilgi sunmamasıdır. İkincisi ise vergi gayretini temsil eden vergi gelirlerinin gayrisafi yurtiçi hasılaya oranını bağımlı değişken olarak tanımlayan ve vergi gayretini etkileyen değişkenleri bir tahmin denklemi ile analiz ederek kalıntı değerlere göre ülkelerin vergi gayreti performanslarının sıralanmasıdır. Bu yöntemin üstünlüğü ise bir taraftan sıralama yapılmasına imkân verirken diğer taraftan vergi gayretini etkileyen değişkenlerin etkilerini tespit ederek karar alıcılara ek bilgi sunmasıdır.

İkinci yöntem literatürde, dışa açıklık düzeyinden gelir dağılımı adaletsizliğine, tarım kesiminin gayrisafi hasıladaki payından okuryazarlık oranına kadar farklı değişkenler kullanarak, farklı ülke ve ülke gruplarının farklı dönemlerde vergi gayreti sıralamaları için sıklıkla kullanılmaktadır. Genel olarak panel veri setlerinin kullanıldığı bu çalışmalarda ülke sayıları değişmekle birlikte elde edilen bulguların yorumlanması ve vergi gayreti sıralamalarında ülkelerin gelir düzeylerine, coğrafi dağılımlarına veya üye oldukları kuruluşlara göre ayrıştırılarak kendi içinde sıralandığı görülmekte ve ülkelere tekdüze gelirler politikası önerilerinde bulunmaktadır.

Bu çalışma literatürdeki yerleşik yaklaşımlardan farklı olarak görece yeni bir yöntem olan Kulüp Yakınsama Analizi temelinde birbirilerine yakınsayan ülkeler arasında alt kulüpler oluşturarak ikinci yöntem olarak belirtilen tahmin denklemini incelemektedir. Kulüp yakınsama yönteminin en önemli özelliği panel veri seti içinde seçilen değişken için alt panel veri seti oluşturulmasına imkân vermesidir. Dolayısıyla yapılan tahminler yapısal olarak birbirine benzer ülkeleri kapsadığı için ülkelerin performans açısından karşılaştırılması da daha anlamlı bir hale gelmektedir.

Çalışmada bu yöntemin farkını ve üstünlüğünü ortaya koymak amacıyla vergi gayretini ve bağımsız değişkenleri analiz edilmiştir. Çalışmanın ampirik uygulamasında 34 OECD ülkesinin verileri kullanılmış ve vergi oranları, kayıt dışı ekonomi ile vergi gayreti değişkenleri için yakınsama analizleri yapılmıştır. Elde edilen bulgulara göre 34 OECD ülkesinin seçilen değişkene göre farklı kulüplere ayrıştığı görülmüştür.

Çalışmanın odağında yer alan vergi gayreti yakınsama analizinin özellikle Türkiye'nin performansını tespit edebilmek açısından önemli ipuçları verdiği görülmektedir. 34 OECD ülkesi için analiz edilen tahmin denklemi vergi gayreti yakınsama sonuçlarından elde edilen Kulüp 4 için yeniden tahmin edildiğinde farklı bulgular elde edilmektedir.

34 OECD ülkesi için kullanılan tahmin denklemi sonuçlarına göre vergi gayreti ile kayıt dışı ekonomi arasında istatistiksel olarak anlamlı bir ilişki olmadığı görülmektedir. Oysa teorik olarak kayıt dışı ekonominin vergi gayretini olumsuz etkilemesi ve bu olumsuz etkinin, kayıt dışılığın ülkelerin vergi egemenlikleri içinde kalması şartıyla, dolaylı vergilerin toplam vergi gelirleri içindeki payının yüksekliği üzerinden tanzim edilmesi beklenmektedir. Ülkelerin ekonomik egemenlik sınırları içinde bulunan vergilendirilebilir kaynaklarının azalması, ülke vergi gelirlerini ve dolayısıyla vergi kapasitelerini olumsuz etkilemektedir. Bu beklenti, Kulüp 4 ülkeleri için yapılan analizde, kayıt dışı ekonomi değişkeninin vergi gayretini etkilemesi üzerinden görülmektedir. Buna göre Kulüp 4'te yer alan ülkelerde (Avusturalya, Kosta Rika, İrlanda, İsrail, Güney Kore, Meksika, Türkiye, ABD, Brezilya, Güney Afrika) kayıt dışı ekonominin %1 artması vergi gayretini %0,16 azaltmaktadır. Dolayısıyla OECD ülkeleri temel alındığında kayıt dışı ekonomi değişkeni için herhangi bir çıkarım elde edilmemesine rağmen Kulüp 4 ülkeleri temel alındığında karar alıcılar için önemli bir bilgi elde edilmektedir.

Vergi sistemleri, vergi oranları ve yasal düzenlemeleri farklı olan bu ülkelerin kayıt dışı ekonomilerinin vergi gayretlerini benzer düzeylerde negatif etkiliyor olması, mükelleflerin benzer düzeyde vergi direnci, vergiden kaçınma ve vergi kaçırma davranışları ile açıklanabilmektedir. İlgili kanun boşluklarına ve yaptırımlara karşı yakın davranışların sergilendiği ve hükümetlerin vergi kavrama güçlerinin yakın olduğu şeklinde yorumlanabilecek analiz sonucunun, etik değerleri içeren vergi ahlakı ve psikolojisi ile uluslararası vergi hukuku açısından incelenmesi gereken farklı bir çalışma konusu olduğu düşünülmektedir.

Vergi oranlarının vergi gayretini etkileme düzeyi açısından teorik olarak beklenen etkiye ulaşılma ile birlikte, etki oranı OECD ve kulüp ülkeleri için farklılaşmaktadır. Buna ek olarak hem OECD grubu hem de Kulüp 4 için dolaylı vergi oranlarının vergi gayretini negatif yönde etkilediği görülmektedir bu etki katsayısı OECD ülkeleri için %0,32 iken Kulüp 4 ülkeleri için %0,16 olarak hesaplanmıştır. Bir başka deyişle dolaylı vergilerin toplam vergiler içindeki payı %1 arttığında OECD ülke grubuna göre vergi gayreti %0,32 azalırken Kulüp 4 ülkeleri dikkate alındığında bunun etkisi %0,16'dır. Bu farklılaşma için kulüplerde yer alan ve rastgele seçilen ülke örneklerine bakıldığında; OECD ortalamasında analiz dönemi için katma değer vergilerinin ortalama oranı %19,6'dan %20,3'e yükseldiği görülmektedir. Aynı oran, aynı zaman aralığında, Kulüp 4'te yer alan Türkiye için %23'ten 18,1'e ya da Kosta Rika için %23,3'ten 18,5'e düşmektedir. Kulüp 1'de yer alan Şili'deki değişim 2001'de %40,9'dan 2021'de %39,9'a, Kulüp 3'te yer alan Avustralya için %12,6'dan 11,7'ye düşmektedir. Kulüp 5'te yer alan Japonya'da ise oranlar %9,1'den 13,2'ye çıkmaktadır (OECD, 2023b). Yani ülkeler kulüplere ortalama katma değer oranlarının eşik sınırlarına göre ayrıştırılmaktadır. OECD ülkeleri arasındaki vergi rekabeti dikkate alındığında, vergi yapılarının ve vergi düzeylerinin olumsuz vergi rekabetini önleme anlaşmaları, ayrımcı vergilemeyi önleme ve vergi uyumlaştırma anlaşmaları, ortak KDV rejimi üzerinden birbirine yaklaştırılmaya çalışıldığı mevcut süreçte bu farklılığın önemli olduğu düşünülmektedir. Vergi oranlarındaki artış kayıt dışılığı artırırken vergi gelirlerini düşürmektedir. Bu açıdan bakıldığında, ortalama %40 katma değer oranına sahip bir ülkenin ortalama %9 vergi oranına sahip bir ülke ile benzer vergi reformlarını yapması beklenilmemelidir.

Bu bulgunun geri planında ise, ülkelerin dolaylı ve dolaysız vergilerinin toplam vergiler içindeki payının farklılaşması ve dolaylı vergilerin gelişmiş ülke olarak sınıflandırılan bazı ekonomilerde göreceli olarak düşüklüğü olabilmektedir. Bunun doğal sonucu olarak hali hazırda düşük orana sahip ülkelerdeki vergi oranları payının azalmasının etkisi yüksek orana sahip ülkelere kıyasla daha az olmaktadır.

Ayrıca, vergi gayreti oranlarına bakıldığında Kulüp 1'de yer alan Fransa için değerler, 2001 ve 2021 yılları için, %43,10 - 44,89 ve Yunanistan için 31,94 - 39,48 arasında değişirken Kulüp 2'de yer alan Japonya için %değerler 25,53 - 31,41 ve Almanya için %35,13 - 38,62; Kulüp 3'te yer alan Polonya için %32,83 - 35,11; Kulüp 4'ye yer alan Türkiye için %25,36 - 23,10 ve ABD için %27,26 - 24,97; Kulüp 5'te yer alan Şili için %19,05 - 20,89 ve Kulüp 6'da yer alan Endonezya için %10,09 - 11,59 aralığında gerçekleşmektedir (OECD, 2023a). Bu veriler dikkate alındığında vergi gayreti oranlarının bazı ülkelerde göreceli olarak yüksek olduğu ve hali hazırda yüksek vergi gayreti olan ülkelerde dolaylı vergi oranlarının artırılmasının vergi gayreti üzerindeki etkisinin düşük vergi gayreti olan ülkelere kıyasla farklı olacağı söylenebilmektedir. Bu bulgular dolaylı vergilerin payının artırılması ile vergi gayretini artırmayı planlayan karar alıcılar açısından oldukça önemli bir ipucu olarak değerlendirilmektedir.

Son olarak OECD ülkelerinin tümünü hesaba katan tahmin denklemi kalıntı değerlerine göre vergi gayreti sıralamasında ilk sırada Danimarka yer alırken Türkiye 24.

Sırada yer almaktadır. Bununla birlikte Kulüp 4 ülkeleri olan 10 ülke için yapılan sıralama da İsrail ilk sırada yer alırken Türkiye 4. Sırada bulunmaktadır. Dolayısıyla karar alıcıların performans değerlendirmesini ve politika seçeneklerini daha sağlıklı yapabilmesi için seçilen ülke grubunun oldukça önemli olduğu düşünülmektedir.

Kaynaklar

- Aghion, P. et al. (2016), "Taxation, Corruption, and Growth", *European Economic Review*, 86, 24-51.
- Ajaz, T. & E. Ahmad (2010), "The Effects of Corruption and Governance on Tax Revenues", *The Pakistan Development Review*, 49(4), 405-417.
- Aksoy, T. et al. (2019), "Revisiting Income Convergence in Turkey: Are There Convergence Clubs?", *Growth and Change*, 50(3), 1185-1217.
- Apaydın, Ş. et al. (2021), "The Impact of Globalization on the Ecological Footprint: Do Convergence Clubs Matter?", *Environmental Science and Pollution Research*, 28, 53379-53393.
- Apergis, N. & A. Cooray (2014a), "Convergence in Sovereign Debt Ratios Across Heavily Indebted EU Countries: Evidence From Club Convergence", *Applied Economic Letters*, 21(11), 786-788.
- Apergis, N. & A. Cooray (2014b), "Tax Revenues Convergence Across ASEAN, Pacific and Oceania Countries: Evidence From Club Convergence", *Journal of Multinational Financial Management*, 27, 11-21.
- Apergis, N. & J.E. Payne (2017), "Per Capita Carbon Dioxide Emissions Across U.S. States by Sector and Fossil Fuel Source: Evidence from Club Convergence Tests", *Energy Economics*, 63, 365-372.
- Apergis, N. et al. (2013), "Convergence in Public Expenditures Across EU Countries: Evidence From Club Convergence", *Economics and Finance Research*, 1, 45-59.
- Attila, G. (2008), "Corruption, Taxation and Economic Growth: Theory and Evidence", *CERDI Working Paper*, No: 2008-29, Universite de Clermont, Clermont Ferrand, France.
- Bahl, R.W. (1971), "A Regression Approach to Tax Effort and Tax Ratio Analysis", *IMF Staff Papers*, 18(3), 570-612.
- Baltagi, B. & P.X. Wu (1999), "Unequally Spaced Panel Data Regressions with AR(1) Disturbances", *Econometric Theory*, 15(6), 814-823.
- Bartkowska, M. & A. Riedl (2012), "Regional Convergence Clubs in Europe: Identification and Conditioning Factors", *Economic Modelling*, 29, 22-31.
- Beck, N. & J.N. Katz (1995), "What To Do (and Not To Do) With Time-Series Cross-Section Data", *The American Political Science Review*, 89(3), 634-647.
- Besley, T. & T. Persson (2014), "Why Do Developing Countries Tax So Little?", *Journal of Economic Perspectives*, 28(4), 99-120.
- Bhargava, A. et al. (1982), "Serial Correlation and the Fixed Effects Model", *Review of Economic Studies*, 49(4), 533-549.
- Bird, R.M. et al. (2004), "Societal Institutions and Tax Effort in Developing Countries", *CREMA Working Paper 2004-21*, Zurich: Crema Vermögensverwaltung & Research.

- Bird, R.M. et al. (2008), "Tax Effort in Developing Countries and High-Income Countries: The Impact of Corruption, Voice and Accountability", *Economic Analysis and Policy*, 38(1), 55-71.
- Breusch, T. & A. Pagan (1980), "The Lagrange Multiplier Test and Its Application to Model Specification in Econometrics", *Review of Economic Studies*, 47, 239-253.
- Cavallaro, E. & H. Villani (2021), "Club Convergence in EU Countries: A Sectoral Perspective", *Journal of Economic Integration*, 36(1), 125-161.
- Chelliah, R.J. et al. (1975), "Tax Ratio and Tax Effort in Developing Countries", *IMF Staff Paper*, 22(1), 187-205.
- Corrado, L. et al. (2005), "Identifying and Interpreting Regional Convergence Clusters Across Europe", *The Economic Journal*, 115(502), 133-160.
- Cukierman, A. et al. (1992), "Seigniorage and Political Instability", *American Economic Review*, 82(3), 537-555.
- Cyan, M. et al. (2013), "Measuring Tax Effort: Does the Estimation Approach Matter and Should Effort be Linked to Expenditure Goals?", *ICEPP Working Paper 39*, International Center for Public Policy.
- Çelikay, F. (2017), "Milli Gelirin Vergi Yükü Üzerindeki Etkileri: ARDL Sınır Testi Yaklaşımı ile Türkiye Üzerine Bir İnceleme (1924-2014)", *Sosyoekonomi*, 25(32), 169-188.
- Çevik, S. (2018), "The Composition of Government Revenue and Democracy: A Cross-Country Examination", in: M.M. Erdoğan et al. (eds), *Public Sector Economics & Development* (15-32), United Kingdom, IJOPEC Publication.
- Delgado, F.J. & M.J. Presno (2017), "Tax Evolution in the EU: A Convergence Club Approach", *Panoeconomicus*, 64(5), 623-643.
- Dioda, L. (2012), *Structural Determinants of Tax Revenue in Latin America and the Caribbean 1990-2009*, December (ECLAC).
- Dücan, E. (2015), "Gelişmekte Olan Ülkelerin Yakın Komşularıyla Dış Ticaret Hacminin Doğrudan Yabancı Yatırımlar Üzerine Etkisi", *Doktora Tezi*, Sakarya Üniversitesi Sosyal Bilimler Enstitüsü.
- Fjeldstat, O. & B. Tungodden (2003), "Fiscal Corruption: A Vice or a Virtue?", *World Development*, 31(8), 1459-1467.
- Ghura, M.D. (1998), "Tax Revenue in Sub-Saharan Africa: Effects of Economic Policies and Corruption", *IMF Working Paper* (135), Washington, DC: International Monetary Fund.
- Glawe, L. & C. Mendez (2022), "Schooling Ain't Learning in Europe: A Club Convergence Perspective", *Comparative Economic Studies*, 65, 324-361.
- Greene, W.H. (2012), *Econometric Analysis*, International Edition, Pearson Education Limited, Seventh Edition.
- Gupta, A.S. (2007), "Determinants of Tax Revenue Effort in Developing Countries", *IMF Working Paper* WP/07/1184, Washington DC: IMF.
- Günay, H.F. & M.H. Topal (2021), "Does Quality of Governance Affect Tax Effort in Sub-Saharan Africa?", *Journal Emerging Economies and Policy*, 6(2), 414-434.
- Karagöl, E.T. et al. (2019), "Club Convergence in Turkey: Evidence From Provincial Income Data", *International Congress of Management, Economy and Policy*, İstanbul/Türkiye.

- Kılıçarslan, Z. & M. Dedeoğlu (2020), "OECD Ülkelerinde Ticari Açıklık Yakınsaması: Phillips-Sul Kültür Yakınsama Analizi", *Turkish Studies-Economics, Finance, Politics*, 15(1), 277-288.
- Langford, B. & T. Ohlenburg (2016), "Tax Revenue Potential and Effort: An Empirical Investigation", *IGC Working Paper S-43202-UGA-1*, London: International Growth Centre.
- Le, T.M. et al. (2012), "Tax Capacity and Tax Effort: Extended Cross-Country Analysis From 1994 to 2009", *World Bank Policy Research Working Paper 6252*, Washington: World Bank.
- Lien, N.P. (2015), "Impact of Institutional Quality on Tax Revenue in Developing Countries", *Asian Journal of Empirical Research*, 5(10), 181-195.
- Lotz J.R. & E.R. Morss (1967), "Measuring 'Tax Effort' in Developing Countries", *IMF Staff Papers*, XIV, 478-99.
- McNabb, K. et al. (2021), "Tax Effort Revisited: New Estimates From the Government Revenue Dataset", *WIDER Working Paper*, No. 2021/170, ISBN 978-92-9267-110-5, The United Nations University World Institute for Development Economics Research (UNU-WIDER), Helsinki.
- Moundigbaye M. et al. (2018), "Which Panel Data Estimator Should I Use?: A Corrigendum and Extension", *Economics: The Open-Access, Open-Assessment E-Journal*, 12(1), 1-31.
- OECD (2023a), *National Accounts at a Glance*, <<https://stats.oecd.org/index.aspx?lang=en#>>, 14.05.2023.
- OECD (2023b), *Global Revenue Statistics Database*, <<https://stats.oecd.org/index.aspx?lang=en#>>, 12.05.20239.
- Pesaran M.H. (2004), "General Diagnostic Tests for Cross-Sectional Dependence in Panels", *Empirical Economics*, 60(1), 13-50.
- Pessino, C. & R. Fenochietto (2010), "Determining Countries' Tax Effort", *Hacienda Pública Española/Revista de Economía Pública*, 195(4), 65-87.
- Phillips, P.C.B. & D. Sul (2007), "Transition Modeling and Econometric Convergence Tests", *Econometrica*, 75(6), 1771-1855.
- Piancastelli, M. (2001), *Measuring Tax Effort of Developed and Developing Countries: Cross Country Panel Data Analysis 1985/95*, Institute of Applied Economic Research (IPEA) - Directory of Macroeconomic Policy & Studies (DIMAC), Brazil.
- Quah, D. (1993), "Empirical Cross-Section Dynamics in Economic Growth", *European Economic Review*, 37, 426-434.
- Regis, P.J. et al. (2015), "Corporate Tax in Europe: Towards Convergence?", *Economic Letters*, 134, 9-12.
- Sanyal, A. et al. (2000), "Corruption, Tax Evasion and the Laffer Curve", *Public Choice*, 105, 61-78.
- Shin, K. (1969), "International Differences in Tax Revenue", *Review of Economics and Statistics*, 51(2), 213-230.
- Stotsky, J.G. & A. WoldeMariam (1997), "Tax Effort in Sub-Saharan Africa", *IMF Working Paper WP/97/107*, Washington, DC: International Monetary Fund.
- Şahin, B.Y. (2021), "Orta Gelir Grubu Ülkelerde Kamu Harcamaları Yakınsaması: Phillips Sul Kültür Yakınsama Analizi", içinde: A.N. Özker (ed.), *İşletme ve İktisadi Bilimler Araştırma ve Teori* (87-97), Bölüm 5.

- Şen H. & A. Kaya (2019), "Alternatif Göstergeler Bazında Türkiye’de Optimal Kamu Kesimi Büyüklüğünün Tahmini", *Bankacılar Dergisi*, 109, 49-81.
- Şen, H. & İ. Sağbaş (2016), *Vergi Teorisi ve Politikası*, 2. Baskı, Ankara: Kalkan Matbaacılık.
- Tait, A. et al. (1979), "International Comparison of Taxation for Selected Developing Countries 1972-76", *IMF Staff Papers*, 21(1), 123-156.
- Tanzi, V. (1980), "The Underground Economy in the United States: Annual Estimates, 1930-80", *IMF Staff Papers*, 30(2), 283-305.
- Topal, M.H. & M. Sahin (2017), "Governance Quality and Taxation: A Panel Cointegration Evidence for OECD Countries", in: R. Yılmaz & G. Löschnigg (eds.), *Studies on Balkan and Near Eastern Social Sciences* (265-279), Peterlang Academic, Frankfurt.
- Ulucak, R. & N. Apergis (2018), "Does Convergence Really Matter for The Environment? An Application Based on Club Convergence and on The Ecological Footprint Concept for The EU Countries", *Environmental Science and Policy*, 80, 21-27.
- Ulucak, R. (2017), "Çevre Kalitesi Açısından Yakınsama Hipotezine Yeni Bir Bakış: Ekolojik Ayak İzi ve Kulüp Yakınsamaya Dayalı Ampirik Bir Analiz", *Anadolu Üniversitesi Sosyal Bilimler Dergisi*, 18(4), 29-38.
- Ursavaş U. & C. Mendez (2022), "Regional Income Convergence and Conditioning Factors in Turkey: Revisiting the Role of Spatial Dependence and Neighbor Effects", *The Annals of Regional Science*, 8/7, 1-27.
- Yazgan, Ş. & R. Ceylan (2021), "Türkiye’de Düzey-2 Bölgeleri Arasında Kişi Başı Gelir Yakınsama Kulüpleri Var mıdır?", *Atatürk Üniversitesi İktisadi ve İdari Bilimler Dergisi*, 35(4), 1497-1519.

35 OECD Ülkesinde Vergi İdaresinin Etkinliği: VZA Yöntemi¹

Sevilay Ece GÜMÜŞ-ÖZUYAR (<https://orcid.org/0000-0002-1957-3648>), *Necmettin Erbakan University, Türkiye*; sevilayece.gumusozuyar@erbakan.edu.tr

Ayça ÖZEKİN (<https://orcid.org/0000-0002-0566-7168>), *Bandırma Onyeddi Eylül University, Türkiye*; aomezkin@bandirma.edu.tr

Tax Administration Efficiency in 35 OECD Countries: DEA Method²

Abstract

The efficiency of the tax administration should be evaluated for both tax costs and tax revenue. Modest tax cost, on the other hand, reduces tax losses by raising the taxpayer's voluntary compliance and increasing the public revenue. Moreover, fast and accurate taxation minimises the risk of the Tanzi effect as it shortens the taxation process. This research aims to detect the tax administration efficiency of 35 selected OECD countries in 2019 via DEA. The year is chosen to avoid the imbalances created by Covid-19. Efficiency scores are acquired under fixed and varying effects to the scale assumptions via two separate models, providing information on scale and technical activities.

Keywords : Tax Administration, Effectiveness, Data Envelopment Analysis, OECD Countries.

JEL Classification Codes : C67, E62, H21, H83, O57.

Öz

Vergi idarelerinin etkinliği gerek vergi maliyetleri gerekse vergi gelirleri bakımından analiz edilmelidir. Vergi maliyeti düşüklüğü mükellefin gönüllü uyumunu artırmak suretiyle vergi kayıplarını azaltır ve toplam kamu geliri miktarını artırır. Üstelik hızlı ve doğru vergilendirme, vergileme sürecini kısalttığından Tanzi etkisinin ortaya çıkma riskini de azaltır. Bu bilgiler dahilinde bu çalışmanın amacı, Veri Zarflama Analizi yöntemiyle 2019 yılı için seçilmiş 35 OECD ülkelerindeki vergi idarelerinin etkinliğinin saptanmasıdır. Bu yıl, Covid-19'un yarattığı dengesizliklerden korunmak adına seçilmiştir. Etkinlik skorları, ölçeye sabit ve değişen etkiler varsayımları altında farklı modeller kurularak elde edilmiştir ve incelenen ülkeler için ölçek ve teknik etkinlikler saptanmıştır.

Anahtar Sözcükler : Vergi İdaresi, Etkinlik, Veri Zarflama Analizi, OECD.

¹ Çalışma metni, 13-16 Mayıs 2022 tarihinde düzenlenen 6. Uluslararası Avrasya Sosyal Bilimler Kongresinde sunulan özet bildiriden türetilmiştir. Özeti tümü büyük ölçüde değiştirilmiştir.

² This text is derived from the abstract paper presented at the 6th International Eurasian Social Sciences Congress held on May 13-16, 2022. However, the entire abstract has been significantly modified.

1. Giriř

Vergiler, herhangi bir politik-ekonomik rejimin bel kemiđidir, bu nedenle vergi toplamak tüm ülkelerde hükümetlerin merkezi bir işlevidir. Vergi toplama sistemi ve yöntemleri ise tek tek ülkelerin siyasi, ekonomik ve sosyal özelliklerine göre büyük ölçüde deđişir ve sağlam bir vergi idaresi için genel olarak aynı kalır. Güçlü bir vergi idaresi sadece hükümetlerin deđil, aynı zamanda tüm vergi mükelleflerinin ve diđer paydařların da çıkarınadır. Vergi idaresinin verimsizliđi ve işlevsizliđi ile bađlantılı riskler, işletmeler için belirsizlik yaratmakta ve sonuç olarak ticareti ve yatırımı etkilemektedir. Artan bütçe kısıtları, vergi idaresinde daha fazla etkinlik ve etkililik talep edilmesine neden olmaktadır. Ayrıca, vergi mükelleflerinin vergi idaresinin adaleti ve etkinliđi hakkındaki algısı, ticari kararları ve kurumsal gönüllü uyumu etkiler. Bu nedenle, iyi işleyen bir vergi idaresi sadece devlet gelirinin anahtarı deđil, aynı zamanda ekonomik refahta da role sahiptir. Ek olarak, bir vergi idaresinin etkinliđi gerek vergi maliyetleri gerekse vergi gelirleri bakımından ele alınmalıdır. Vergi maliyetleri, iki boyutludur. Bunlar; vergi toplamakla yükümlü idarenin yükümlülükleri dahilindeki maliyetleri ile vergi ödemekle yükümlü kılınmış mükellefin sorumlulukları dahilindeki maliyetleridir. Bahsi geçen boyutların temel odađında yer alan mükellefin de idarenin de temel amacıysa maliyetlerini asgari tutara indirmektir. Bu maliyetlerin her iki boyutu da toplamda, vergi toplama maliyetlerinin en aza indirilmesi, mükellefi en az rahatsız edecek en dođru zamanda vergisel yükümlülüđünün yaratılması ve verginin ödenmesinin teşviki ile ilgilidir. Bu maliyetler ile vergi uyumu ters orantılı olmak üzere, bir vergiye uyum ne kadar yüksekse, vergiden kaçınma ve vergi kaçırma gibi motivasyonlar da o derece düşüktür. Sonuç olarak vergi maliyetlerinin düşük olması gelirlerin sabit kaldıđı varsayımı altında dahi vergi kârlılıđını artıran bir etken iken, düşük maliyetlerle birlikte kamuoyunda gelişen bir vergisel uyum sebebi ile kamu gelirlerinde beklenenden daha fazla artış olacaktır. Ayrıca idare zamanında bir vergilendirmeyi dođru bir şekilde gerçekleřtirdiđi için tarh-tahsil arasındaki vergileme süresinin kısalması toplanan vergi gelirlerinin Tanzi etkisine uğrama riskini düşürmektedir. Tüm bunların yanı sıra sade bir dil kullanılarak hazırlanmış, hedef ve amaçları net, kanuni bir vergi sistemi, mükelleflerin vergi bilinç ve ahlak düzeylerini dođrudan etkilemek suretiyle vergisel uyumlarını artırarak, son tahlilde kamu gelirlerinin artışını sağlayacaktır. İşte tüm bu hususlar, vergi idaresinin bir vergi sisteminde ne denli kapsamlı bir yaklaşım gerektiren çok dinamik ve karmařık bir olgu olduđunun da işaretidir.

Çalışmamızın amacı, seçilmiş 35 OECD ülkesi için 2019 yılında vergi idare etkinliđinin saptanmasıdır. OECD bünyesindeki ülkelerin birçođu hali hazırda vergisel sorunlarını halletmiş, vergi maliyetleri düşük ancak vergi karlılıkları yüksek gelişmiş ülkelerdir. Diđer yandan OECD içerisinde gerek objektif gerekse subjektif manada vergi yükü fazla, açıklık ve şeffaflık ilkesinin görece daha düşük olduđu karmařık vergi sistemi bulunan, çođunlukla enflasyonist bir ortamda Tanzi etkisi yaşama riskinin nisbi olarak daha fazla olduđu gelişmekte olan ve az gelişmiş üye ülkeler de bulunmaktadır. Dolayısı ile gelişmekte olan ülkelerde bütçe disiplininin sağlanarak, ülke ekonomik yönetiminin mali başarısını sağlayan bir husus olarak vergi idaresinin etkinliđi tartışılmaz bir öneme sahiptir. Bu çalışmanın yapılmasını sağlayan müşevvik de tam iktisadi kozmopolitizm yapısının

görüldüğü OECD’ye üye olan gelişmiş ve gelişmekte olan ülkeler arasında vergi idarelerinin etkinliği açısından beklenen farklılıkların saptanıp saptanmayacağına dair olan meraktır. Bu kapsamda çalışmanın birinci bölümünde vergi kavramı, vergi idareleri ve etkinlik kavramlarına ilişkin bir tanımsal çerçevenin yanı sıra bu kavramların birbirleri ile olan ilişkisi tartışılmaktadır. İkinci bölümde yoğunluk OECD ülkeleri üzerine yapılan çalışmalar olmak üzere, vergi idarelerinin etkinliğinin alanında yapılan teoride ön plana çıkan ve/veya güncel çalışmalar değerlendirilmektedir. Üçüncü bölümde veri, yöntem ve analizlere yer verilirken, dördüncü bölümde bulgular açıklanmaktadır. Son bölüm ise çalışmanın genel değerlendirmesine ayrılmıştır.

2. Vergi Kavramı, Vergi İdareleri ve Etkinlik

Devlet, yüklediği görevleri yerine getirebilmek adına yaptığı harcamaların finansmanı için gelir elde etmek mecburiyetindedir. Devletin ve diğer kamu kuruluşlarının yasalar çerçevesinde egemenlik güçlerine dayanarak cebren çeşitli kaynaklardan tahsil ettikleri gelirler ile yardım ve bağışlardan egemenlik gücü kullanılmaksızın elde edilen gelirlerin tamamına ise kamu gelirleri denmektedir. Kamu maliyesi terminolojisinde ise kamu gelirleri denildiğinde ilk çağrışım yapan vergilerdir. Ancak vergi kavramı yapısı itibari ile hem tanımlanması hem de betimlenmesi zor bir kavramdır (Messere & Owens, 1985: 94). İktisat bilimini sistematikleştiren Adam Smith (1776: 676-685)’e göre vergi, kamu refahı için gerekli harcamaları karşılamak için devlet tarafından bireyler veya şirketlere uygulanan zorunlu ödemeler bütünüdür. Ancak Kıta Avrupası’nda maliyenin kurucusu olarak tanınan Guston Jeze vergiyi kamu harcamalarına bir katılım olarak görerek, “*vergi, kişilerden kamu giderlerini karşılamak üzere, cebri, nihai ve karşılıksız olarak istenen parasal yükümlülüklerdir*” (Türk, 2002: 11) tanımını yapmaktadır. Seligman (1925: 304) vergiye kamu yararı için alınan bir tutar gözüyle bakarak “*bir kişiden devlete, herkesin ortak çıkarı için aktarılan zorunlu bir karşılık*” olarak yaklaşmaktadır. Zaman içinde verginin amaç ve fonksiyonların genişlemesi ve verginin alınışın yarattığı ekonomik etkilerin daha irdelenir olmasıyla birlikte vergi tanımlamaları da değişikliğe uğramıştır. Örneğin Dalton (1954: 23) “*karşılığında mükellefe verilen hizmetin tam miktarına bakılmaksızın, bir kamu otoritesi tarafından uygulanan zorunlu katkı*” olarak vergiyi nitelendirirken, vergiyi alan unsura önem atfetmiştir. Benzer şekilde, Tiley (1978: 3)’de vergi kavramını “*kamusal amaçlara yönelik olarak zorunlu olarak alınan, yasama organının yetkisi altında uygulanan ve bir kamu kurumu tarafından tahsil edilen parasal tutarlar*” şeklinde tanımlamaktadır. Bu tanımlamalardan hareketle vergilendirmenin, işletmesini finanse etmek için hükümet tarafından vergi kaynaklarından vergi idareleri aracılığıyla yapılan bir fon toplama işlemi olduğu söylenebilir.

Vergi idaresi temel olarak, vergi idaresinin vergi politikasının uygulanmasında sorumluluklarını yerine getirmesine rehberlik eden bir dizi kural ve düzenlemeden oluşur. Sınırları Smith’in 1776 Milletlerin Zenginliği kitabındaki ilk altı bölümde çizildiği üzere bir vergi sisteminin eşitlikçi, kesin, uygulamayı kolaylaştırıcı, basit ve anlaşılır, iktisadi olarak etkin ve verimli olması gerekmektedir ki bunu sağlayan da vergi idaresidir. Medeniyetin başlangıcı olarak kabul edilen Sümerlerde Kral Urukagina tarafından çıkarılan vergi afları,

bu afların uygulayıcıları ile birlikte kamu harcamalarını finanse etmek amacıyla vergi toplayan kamu görevlilerinin bilinen varlığı (Eliaçık, 2011: 42), vergi idarelerinin İlkçağdan bu yana devlet yönetimlerinin tam merkezinde olduğunun da bir kanıtı niteliğindedir. Öyle ki, Antik Yunan modern anayasalara uzanan zaman diliminde neredeyse tüm devletler "nullum tributum sine lege" (kanunsuz vergi olmaz) kavramı ile sınırları kurullarla belirlenen ve bu çerçevede toplanan parasal ve aynı unsurlar olarak, kanunen görev verilen meşru vergi toplayıcı kişi ve/veya kurumların da varlığını da zımnen kabul etmişler ve vergi sistemlerini yapılandırmışlardır. Bu bağlamda vergi idareleri, vergi kanunları tarafından konulan vergileri yönetmek için çok çeşitli yetkilerle donatılmıştır.

Vergi idaresi, bir ülkenin hukuk sisteminin içerisinde var olan ve ülkenin kamu idaresinin bir parçasını oluşturan bir unsur olarak çoğunlukla Maliye Bakanlıkları altında yapılanmaktadır. Geniş anlamda siyasi otoritenin yetki devri çerçevesinde ve belirli kurallar dâhilinde kurumsal kaynakları kullanarak mükellef ile vergi arasındaki ilişkileri dengeleyen kurumlar olarak tanımlanabilecek vergi idareleri, dar anlamda devlet için gelir toplayan bir gelir idaresi olarak değerlendirilmektedir. Geniş manada vergi idareleri tarihsel olarak bir vergileme sürecini yürüten ekonomik bir ajan olmanın yanı sıra vergi denetim işlemlerini gerçekleştiren, mükellefleri eğiten, uyuşmazlıkları çözen, vergi kayıp ve kaçaklarını engellemek için güvenlik çalışmaları yürüten, aksi halde yatırım uygulanabilmesi için güç kullanan bir kurum olarak değerlendirilmektedir³. Dar manada "vergi yönetimi yapan yasa uygulayıcıları" (Erdem, 1978: 4) olarak vergi örgütlenmeleri, tarh, tebliğ tahakkuk ve tahsil aşamaları ile iç içedir. Dar çerçevede, sadece gelir idareleri olarak vergi idarelerini nitelemek kamu sektöründe artan özerkliğe yönelik otuz yılı aşkın süredir artan bir eğilimin parçası olmuştur. Yönetişim kavramının gelişmesiyle birlikte bir bakanlıkta normal bir birime sağlanan özerlikten daha farklı ve fazla haklarla donatılan bir vergi idaresi oluşturulmasının temel mantığı ise, hesap verebilirliğin geçerli olduğu bir ortamda şeffaflığı devam ettirirken etkin, etkili ve verimli bir idare sağlayarak daha güçlü bir performans oluşturabilmektir. Öyle ki vergi idaresi son derece teknik bir kurum olduğundan, bazı kilit operasyonel konularda "kısıtlı ve çerçevesi belli özerklik" vergi/gelir dairesinin karar verme kapasitesini koruyarak, vergi gelirlerini mümkün olan en düşük maliyetle alma yönünde verimlilik ve etkinliğini de artırabilmektedir (Crandall & Kidd, 2010: 64-65). Bu çerçevede Vermeend vd. (2008, akt. Güler & Kaba, 2018: 302) gelir idaresini yeterli ve istikrarlı gelir getirisi, etkinlik ve eşitlik dengesi, minimum yönetim maliyetleri ve vergi uyumunu sağlayan kurum olarak nitelendirmektedir.

Genel geçer bir kabul olarak Uluslararası Yüksek Denetim Kurumları Teşkilatı (INTOSAI)'na göre bir kamu idaresi etkinlik, etkililik, ekonomiklik ve verimlilik kriterlerinde performans elde edildiğinde iyi bir yönetim örneği olarak işlevsel ve zamanlı hizmet sunumu gerçekleştirebilir (ISSAI 300, 2009: 3). Etkinliğin hem girdi hem de çıktı ile ilişkili çift yönlü bir işlemci olarak en temel tanımı girdi-çıkıtı oranı olsa da üretim olasılığı sınırı fikrini içerecek şekilde veri bir girdi ile en çok çıktı elde etmek ve/veya veri bir çıktı

³ Detaylı değerlendirmeler için bkz. Erdem, 1978: 3-8.

düzeyine minimum girdi ile ulaşmaktadır. Mandl vd. (2008: 3)’ne göre “*belirlenmiş bir girdi düzeyinden elde edilen çıktı ne ölçüde büyükse veya belirli bir çıktı elde etmek için kullanılan girdi ne ölçüde düşükse, faaliyet o kadar etkindir. Bu noktada verimlilik ise üretilen çıktuların kullanılan girdiye oranıdır*”. Due (1963: 126-127)’ya göre vergi maliyetlerinin asgari düzeye indirilmesi vergi yönetiminin etkinliğidir. Bu tanımdan hareketle bir vergi idaresinin etkinliğini daha önce de belirtildiği üzere maliyet, gelir ve getiri bağlamında değerlendirmekte fayda bulunmaktadır. Vergi maliyetleri gerek idarenin gerekse vergi mükelleflerinin katlandıkları, vergi toplamak için yapılan maliyetlerdir (Çaşkurlu & Arslan, 2017: 117-220). Düşük vergi maliyetleri, yüksek vergi uyumu yaratacağından vergi gelirlerini azaltıcı motivasyonlardan olan vergiden kaçınma ve vergi kaçırma müşevvikleri o kadar az, vergi gayreti ise o denli yüksek olacaktır. Ayrıca etkin vergi idaresinin yaptığı hızlı ve doğru vergilendirme sonucu vergi açığı azalacak ve verginin tarhi ile tahsilatı arasındaki süre kısılacak ve vergi gelirlerinin Tanzi etkisine maruz kalma riski düşecektir (Tanzi, 2001). Bu bağlamda maliyet/getiri oranı, bir vergi idaresinin vergi yönetiminde etkinliğini saptama için geçerli bir ölçüttür. Ek olarak bir vergi idaresinin etkinliğini saptamaya yarayan bir diğer ölçüt ise o vergi idaresinin çatısı altında görev yapan personeldir (Erdem, 1981: 48). Lakin çalışanların nitelik olarak sahip oldukları özelliklerin yanı sıra görev bilinç ve yeterlilikleri göreceli ve kolaylıkla nicelleştirilemeyen unsurlardır. Ancak o idarede bulunan personel sayısının iş ve işlem yükünü kaldırabilecek sayıda olup olmadığı tartışmaya yer bırakmayacak nicel bir ölçüttür (Şenyüz, 1995).

IMF, OECD, Birleşmiş Milletler (UN) ve Dünya Bankası Grubu (WBG) özellikle gelişmekte olan ülkelerdeki vergi kapasitesinin inşası için etkin dış destek sağlanması adına G20 ülkelerinin Maliye Bakanlarının katılımı ile 2016 yılında düzenlediği rapor kapsamında IMF’in önerdiği gelir idaresi reformları çerçevesinde kurum etkinliğinin artırılması için çalışmanın değerlendirmeye aldığı iki nicel faktörün hem durum iyileştirilmesi hem reform stratejilerinin belirlenmesi hem de uygulamalar için gerekli olduğu not edilmiştir (2016: 22). OECD (2014: 9, 23-30), üye ülkelerin yaklaşık yüzde ellisinin vergi kanunları yorumları, kurumsallaşma ve yönetim, bilgi teknolojileri, kurumsal yönetime ilişkin performans kriterleri ile personel sayı ve politikalarına dayanarak bir dereceye kadar özerkliğe sahip birleşik otoriteler oluşturduğunu göstermektedir. Ulusal gelir makamlarının, idarenin etkinliğinin bir ölçüsü olarak maliyet oranı, mükellef sayısı, toplanan vergi geliri ve çalışan sayısı hesaplaması ve yayınlaması oldukça yaygın bir uygulama haline gelmiştir. Bu çalışmada sadece vergilemenin vergi idaresi boyutunda etkinlik kavramı ele alındığı için vergi sistemi, incelenen ülke grubunun bahsedilen iyi uygulama örnekleri de baz alınarak, vergi yasaları, personel yönetiminde nitel unsurlar, otomasyon, araştırma ve geliştirme boyutunda nitel ya da nicel diğer etkinlik değerlendirmeleri kapsam dışı bırakılmıştır.

3. Literatür

Bu çalışma sadece maddi ve nicel unsurlar ele alınarak şekillendirilmesine rağmen, literatürde konunun yer aldığı gerek nicel gerekse nitel çalışmalar detaylı olarak incelenmiştir. İncelemeler sonucunda vergilemede etkinliğin vergi etkinliği ve vergi kurumlarının etkinliği şeklinde iki farklı şekilde değerlendirildiği, bunlardan vergi

etkinliğinin çoğunlukla vergi uyum ve vergi gayreti kavramları çerçevesinde ele alındığı görülmüştür. Literatürde yapılan genel bir kabul olarak bir birey ya da toplumun vergi ödeme etkinliği, yapısal ve gönüllü olmak üzere iki faktör tarafından belirlenir ki yapısal faktörler toplumda kişi başına düşen milli gelir ile makroekonomik açıdan ülkenin ve etkileyici ülkelerin durumu ve uygulanan politikalarıdır. Kircher (2007)'ye göre vergi ödenmesi ile ilgili kültürel normların bir toplumda gelişmesi, vergi sistemi ve kurumları hakkında kamuoyunun tutumu, vergi ahlak ve bilinci, reel iktisadi göstergelerin birey yaşamına olan olumlu ya da olumsuz etkileri gibi faktörler ise vergi ödemesinin etkinliğine dair iradi faktörlerdir.

Vergi idarelerinin etkinliği mevzubahis olduğunda hangi göstergelerin etkinlik ölçütü olarak seçildiğine ilişkin yakın dönem çalışmaları kontrol edilmelidir. Zira güncel veriler ile güncel metotları kullanarak yapılmış analizler, geçmişten ziyade bugünün uygulamalarına ışık tutmak açısından daha faydalı olacaktır. Barros (2005), Alm ve Duncan (2014), Araki ve Claus (2014), MacKenzie (2021) ve Martinez vd. (2022) vergi maliyetlerini idare etkinliğini gösteren bir girdi değişkeni olarak değerlendirirken, Katharaki ve Tsakas (2010), Robinson ve Slemrod (2011), Gonzalez ve Rubio (2013), Araki ve Claus (2014), Das-Gupta vd. (2016), Aziz ve Al-Hareti (2018), Yulia vd. (2020), MacKenzie (2021) ve Martinez vd. (2022) vergi idarelerinde çalışan personel sayısını bir girdi değişkeni olarak değerlendirmiştir. Ek olarak Barro (2005), Robinson ve Slemrod (2011), Araki ve Claus (2014), Alm ve Duncan (2014), Das-Gupta vd. (2016), Villar-Rubio vd. (2016), Yulia vd. (2020) ve MacKenzie (2021) vergi mükellefi sayısını da girdi olarak dikkate almışlardır. Ancak beyanname sayısı (Das-Gupta et al., 2016), idarelerin özerkliği ve şeffaflığı (Aziz & Al-Hareti, 2018), KDV ve Gelir vergisi gibi vergilerin gelirleri (Alm & Duncan, 2014; Das-Gupta et al., 2016), vergi idarelerinin payları (Yulia et al., 2020), vergi denetimi oranı ve denetim personeli (Yulia et al., 2020; Martinez et al., 2022) gibi farklı girdi değişkenleri kullanan çalışmalarda bulunmaktadır. Literatürde girdi konusunda olan uzlaşıdan daha yüksek oranda çıktılar konusunda bir uzlaşma bulunmaktadır. Tosun ve Güran (2002), Katharaki ve Tsakas (2010), Robinson ve Slemrod (2011), Gonzalez ve Rubio (2013), Araki ve Claus (2014), Das-Gupta vd. (2016), Ubaidillah ve Amah (2020), Yulia vd. (2020), MacKenzie (2021) ve Martinez vd. (2022) hem vergi gelirlerinin GSYH'ya oranını hem de kişi başına düşen GYSH'yı birer çıktı olarak analizlerine dahil etmişlerdir. Lakin Moesen ve Persoon (2002), Barros (2005) gibi farklı çıktı değişkenleri de kullanan az da olsa çalışma da mevcuttur.

Vergi idaresinin etkinliği ile ilgili çalışmalar incelendiğinde Veri Zarflama Analizi (DEA/VZA) ve Stokastik Sınır Analizi'nin (SFA) literatürde sıklıkla başvurulan bir yöntem olduğu görülmektedir (Thanassoulis et al., 1987; Moesen & Persoon, 2002; Gonzalez & Rubio, 2013; Alm & Duncan, 2014; Villar-Rubio, 2016; MacKenzie, 2021). Bu noktada, VZA'ya tek başına başvuran Tosun ve Güran (2002), Barros (2005), Lewis (2006), Ruy ve Lee (2013), Villar-Rubio (2016) gibi araştırmacıların yanı sıra, Alm ve Duncan (2014) ve MacKenzie (2021) gibi bu yöntemleri birlikte kullanan bilim insanları da mevcuttur. Ayrıca Thirtle vd. (2000) ve Forsund vd. (2015) gibi VZA ile birlikte Malmquist Endeksi kullanan ya da Moesen ve Persoon (2002) gibi VZA ile Serbest Atılabilir Zarf Modeli (FDH/SAZ)

kullanan araştırmacılar da bulunmaktadır. Ortak bir nokta olarak bu bilim insanlarının çalışmalarında VZA'yı seçmesinin nedeni ise VZA'nın özelliklerinden birisinin girdi ve çıktı sayısına göre örneklem büyüklüğü arttıkça göreceli olarak verimli karar verme birimlerini etkinliğini belirlemedeki başarısıdır.

Fakat Ubaidillah ve Amah (2020) gibi Kısmi En Küçük Kareler ve Yapısal Eşitlik modeli çalışanlar olduğu gibi, Araki ve Claus (2014) ve Aziz ve Al-Hareti (2018) gibi anket çalışması ile vergi idaresinin etkinliğini belirleyen çalışmalar da vardır. Robinson ve Slemrod (2011) korelasyon ve faktör analizi ile en küçük kareler yöntemini kullanırken, Yulia vd. (2020) regresyon analizine, Martinez vd. (2022) ise tesadüfi GLS regresyon analizi, panel veri analizi ve tobit regresyon analizine başvurmuşlardır. Bu noktada farklı yöntemler kullanılmasının temel sebebi, vergi idaresinin etkinliğinin belirlenmesinde kullanılacak yöntem konusundaki şüpheden kaynaklı olmamakla birlikte, etkinlik analizine ilişkin daha doğru sonuçlar üretebilen yöntemlerin sürekli olarak gelişmesi olarak yorumlanmalıdır.

Literatürde vergi idaresinin etkinliği ile ilgili yapılan çalışmalardan birçoğu sadece tek bir ülkedeki vergi ya da gelir idarelerinin etkinliğine odaklanmaktadır (Thanassoulis et al., 1987; Moesen & Persoon, 2002; Tosun & Güran, 2002; Das-Gupta et al., 2016; Aziz & Al-Hareti, 2018; Güler & Kaba, 2018; Ubaidillah & Amah, 2020, Yuliya et al., 2020). Robinson ve Slemrod (2011), Alm ve Duncan (2014), Mac Kenzie (2021) ve Martinez vd. (2022) ise bir ülkeler grubunun ve/veya bir organizasyonun her bir ülkesi ve dâhil geneli için vergi idarelerinde etkinlik analizi yapmışlardır. Bu çalışmanın odağı ile örtüşen de bu çalışmalardır. Robinson ve Slemrod (2011) yılında otuz OECD ülkesi ve on yedi OECD ülkesi olmayan ülke için 2006 ve 2008 yılları için yürüttüğü analizde, vergi maliyetleri ve vergi gelirleri ile GSYH'nın güçlü bir ilişkisi olduğunu, vergi geliri ve kişi başına milli geliri yüksek olan ülkelerin daha etkin vergi idarelerinin bulunduğunu iddia etmektedir. Etkin vergi dairesi olan ülkelerin topladıkları vergi gelirlerinin de yüksek olduğunu ifade eder. Wagner (1911)'in şehirleşme çalışmasında olduğu üzere parasal anlamda vatandaşın ve taleplerinin değeri arttıkça, hükümetler hizmetlerini daha düşük maliyetlerle üretip, daha çok gelir edeceği ve bunun da toplanan vergi/GSYH oranının yükselmesine neden olacağını dile getirmiştir. Ancak vergi maliyetleri yükseldiğinde hükümetlerin idari kapasitesi kısıtlanmakta ve yük mükelleflere kaymaktadır.

Alm ve Duncan (2014) ise 2007, 2009 ve 2011 yılları için yaptığı çalışmada vergi gelirlerinin etkinliği ölçmek için doğru bir ölçüt olduğunu, vergi maliyet ve idare etkinliği arasındaki ilişkinin ise tüm ülkeler için güçlü olduğunu ortaya koymuştur. Onlara göre, etkinlik skorları açısından Avusturya, Şile, Macaristan, İtalya, Güney Kore, Meksika, Norveç ve Türkiye vergi idareleri her sene için etkin iken; Avusturya 2007 ve 2009, Danimarka 2007 ve 2011, Polonya 2009 ve 2011 olmak üzere iki sene için, Slovenya ve Amerika 2007 senesinde, Belçika, İzlanda ve İngiltere 2009 senesinde, Portekiz ise sadece 2011 senesinde etkin durumdadır. MacKenzie (2021) ise Afrika ülkeleri (ATAF) için 2012-2017 yılları verileri kullanarak yaptığı analizlerde, ülkeler arasında oldukça küçük değer farklılıkları bulunmakla birlikte, vergi idarelerinin etkinliğinin çok yüksek olmadığını

gözlemlemiřtir. Vergi oranlarının ve toplanan vergi miktarının GSYH'ya oranının etkinlik üzerinde ciddi etkisi olduđunu ancak vergi mükellef sayısı ve çalışan sayısının idarenin etkinliđi açısından tam olarak deđerinin veri eksikliđi sebebiyle tespit edilemediđini de eklemiřtir. Son olarak Martinez vd. (2022)'de etkin vergilemenin etkin vergi dairesi ile olacađını, vergi maliyetleri azaldıkça toplanan gelir ve kiři bařına gelir artıřının yanı sıra idarenin etkinliđinin artacađını bu bađlamda çalışan sayısı artıřının etkinliđe hizmet ettiđini belirtmektedir.

4. Veri ve Yöntem

4.1. Veri Seti

Çalışmanın amacına uygun olarak 2019 yılı ile 35 OECD ülkesi, vergi idarelerinin etkinlik analizinde kullanılmıřtır. Covid-19 salgının yarattıđı normal ekonomik düzen ve dengeye aykırı dengesizliklerden korunmak adına 2019 yılı seçilmiřtir. Daha önce giriř kısmı son paragrafta belirtildiđi üzere, OECD üyesi olan ülkelerin birçođu gelişmiş ülkeler olarak halihazırda vergisel sorunlarını halletmiş, vergi maliyetleri düşük ancak vergi karlılıkları yüksek ülkeler olmalarına rağmen; gerek objektif gerekse subjektif manada vergi yükü fazla, açıklık ve řeffaflık ilkesinin görece daha düşük olduđu karmařık vergi sistemi bulunan, çođunlukla enflasyonist bir ortamda Tanzi etkisi yařama riskinin nispi olarak daha fazla olduđu gelişmekte olan ve az gelişmiş üye ülkelerde ülkeler de bulunmaktadır. Bu minvalde gelişmekte olan ülkelerde bütçe disiplinin sađlanarak, ülke ekonomik yönetiminin mali başarısını sađlayan bir husus olarak vergi idaresinin etkinliđi tartıřılmaz bir öneme sahiptir. Bu çalışmanın yapılmasını sađlayan müřevvik de tam iktisadi kozmopolitizm yapısının görüldüđu Örgüt'te gelişmiş ve gelişmekte olan ülkeler arasında vergi idarelerinin etkinliđi açısından literatür anlamında beklenen farklılıkların saptanıp saptanmayacađına dair sorgulamadır.

Çalışmada, vergi idaresi kurumlarının etkinliđi girdi deđiřkeni olarak seçilen deđiřkenlerin var olan seviyelerinde deđiřiklik yapılamayacađı için (bu deđiřkenlerdeki azalıřların literatürde vergi etkinliđini azaltması söz konusu olduđu için), konunun dođası geređi çıktı odaklı veri zarflama modelleri ile incelenmiřtir. Ölçek etkinliđindeki deđiřimlerin etkisini görebilmek adına ölçeđe göre gerek sabit gerekse deđiřken getiriler varsayımları kullanılmış ve yapılan analizlerde çıktı odaklı Charnes-Cooper-Rhodes (CCR) ve Banker-Charnes-Cooper (BCC) modelleri benimsenmiřtir. Analizlerde, 2019 yılı

verileri⁴ kullanılarak 35 OECD ülkesi⁵ için vergi idaresi kurumlarının etkinliği incelenecektir⁶. Tablo 1’de bu çalışma kapsamında seçilen girdi ve çıktılar verilmiştir.

Tablo: 1
Girdi ve Çıktı Değişkenlerinin Tanımlanması

Girdiler	Kullanılacak Kısaltma	Çıktılar	Kullanılacak Kısaltma
Toplam Vergi Maliyetlerinin GSMH içindeki payı (%)	TExp	Kişi başına düşen GSYİH (Milyon USD)	GDP
Vergi Mükellefi Sayısı (Bin kişi)	TPyr	Toplam Vergi Gelirinin GSMH içindeki payı (%)	TRev
Vergi İdare Kurumları Çalışan Sayısı (Bin kişi)	TSİf		

Bu çalışmada Tablo 1 ile seçilen göstergelerin kullanılmasının sebebi, literatür bölümünde açıklandığı üzere, vergi idaresinin etkinliği alanında yapılan çalışmalarda neredeyse tüm çalışmaların ortak noktası olarak en sık kullanılan girdi ve çıktı göstergeleri olmalarıdır. Bu durum vergi ödeyiciler ve çalışanlar ile elde edilen gelirlerin etkinlik üzerindeki etkileri bağlamında teorik olarak vergi idaresi ve etkinlik başlığı altında anlatılanlar ile de uyumludur.

4.2. Veri Zarflama Analizi

Veri zarflama analizi (VZA), çoklu girdilerle birlikte çıktıları kullanmak suretiyle çok sayıda homojen birbirine benzeyen (homojen) karar verme biriminin göreceli etkinliğini değerlendirme adına geliştirilmiştir. Bir grubun homojen olması Dyson vd. (2001: 245)’ne göre, ilgili karar verme ajanlarının benzer girdi ve çıktılar ve çevresel etkenler ile aynı süreçlerde üretim yapmaları anlamına gelir. Doğrusal programlama mantığına dayanan VZA’da bahsi geçen ajanların görece etkinlikleri, etkin ve etkin olmayan olmak üzere iki grup şeklinde kategorize edilir (Charnes et al., 1978). Bu karar verme birimleri her türlü şirket, organizasyon, kişi, ülke gibi ajanlar olabilir. Yöntem en basit anlatımla, çıktıların ağırlıklı toplamının girdilerin ağırlıklı toplamına oranını ölçerek bu birimleri kendi içinde kıyaslamaktadır. Bunun bir sonucu olarak karar verme birimleri için elde edilen etkinlik değerleri, görece etkinlik skorları olarak isimlendirilir. Bu şekilde çözümlenen amaç fonksiyon değeri, etkinlik skorlarını vermekte ve tüm birimlerin etkinlik skorları da 0-1 aralığında bulunmaktadır.

⁴ Veriler, Amerikalılar Arası Vergi İdareleri Merkezi (CIAT), Uluslararası Para Fonu (IMF), Avrupa İçi Vergi İdareleri Teşkilatı (IOTA), Ekonomik İşbirliği ve Kalkınma Örgütü (OECD) kurumlarının imzaladığı mutabakat ile uluslararası kamu yönetimi verilerini topladıkları Uluslararası Gelir İdaresi Anketi (ISORA) sonuçlarından elde edilmiştir (ISORA, 2022).

⁵ Amerika Birleşik Devletleri, Almanya, Avusturya, Belçika, Birleşik Krallık, Danimarka, Fransa, Hollanda, İrlanda, İspanya, İsveç, İtalya, İzlanda, Kanada, Lüksemburg, Norveç, Portekiz, Türkiye, Yunanistan, Japonya, Finlandiya, Avusturya, Yeni Zelanda, Meksika, Çekya, Macaristan, Polonya, Güney Kore, Slovakya, Şili, Estonya, Slovenya, İsrail, Letonya, Litvanya, İsviçre, vergi idare kurumlarında çalışan sayısı verisine 2019 yılı için ulaşamadığından analize dahil edilememiştir. Kolombiya ve Kostya Rika 2019 yılında OECD ülkelerine dahil olmadığı için analiz dışında bırakılmıştır.

⁶ Analizlerde STATA ve MDEAP2 programlarından yararlanılmıştır.

Karar verme birimlerinin etkinlik durumu, girdi-çıkıtı arasındaki teknik bağıntıyı belirleyen üretim sınırı dâhilindeki etkinlik sınırına göre belirlenir. Etkinlik sınırı, veri girdi ile elde edilebilecek optimal çıkıtıyı belirleyen fonksiyonel ilişkidir ve parçalı-doğrusal konveks örtü özelliğe ortaya çıkmaktadır. Bu sınırın altında kalan karar birimleri etkin olmayan (teknik etkinsizlik) birimler olarak değerlendirilirken, üzerinde bulunan karar-verme birimleri ise teknik etkin olarak yorumlanmaktadır (Ayçin, 2019: 269). Optimal etkinlikteki karar verme birimi baz alınmak suretiyle etkin olmayan diğer karar birimlerinin hangi girdi veya çıkıtıyı ne derece ve hangi yönde değiştirmesi gerektiği hakkında yorum yapılabilir (Kaynar vd., 2005: 362). Yöntem bu yönüyle, etkinlik yüzeyinde yer alan ve hedef olarak ifade edilebilecek varsayımsal referans birimlerini her karar verme birimi için en iyi performansı temsil eden projeksiyon değerlerini de belirleyebilmektedir. Göreceli etkinlik değerinin hesaplanması yöntemin sınırlılığı olarak değerlendirilmesine rağmen, etkin olmayan karar verme ajanları için referans (peer) grup oluşturularak, hedef değerler belirlenmesi ve böylece etkin olmayan birimlerinin etkinliklerini artırma imkânı sağlaması önemli bir avantaj olarak görülmektedir.

İlk kez Charnes vd. (1978) tarafından ortaya konan veri zarflama analizinin üzerine inşa edildiği çalışma Farrell (1957) tarafından gerçekleştirilmiştir. Farrell (1957)'a göre toplam etkinlik, toplam teknik etkinlik ile fiyat etkinliğinin toplamından oluşmaktadır. Toplam teknik etkinlikse, saf teknik etkinlikle ölçek etkinliğinin çarpımından teşkilidir. Charnes vd. (1978) tarafından ortaya konan temel veri zarflama modeli, ölçeğe sabit etkiler varsayımı altında toplam teknik etkinliği hesaplama yetisine sahipken, daha sonra Banker vd. (1984) tarafından ortaya konan model ise, ölçeğe değişen getiriler varsayımı altında saf teknik etkinlik puanını hesaplayabilmektedir. Böylece iki modelden elde edilen etkinlik katsayılarının birbirine bölünmesi ile ölçek etkinlik, yani uygun ölçekte üretim yapma başarısı hesaplanabilmektedir (Kumar & Gulati, 2008: 42-46).

VZA il etapta, karar verme birimlerinin sayısının belirlenmesi ile başlar. Bu karar verme ajanlarının sayısının belirlenmesi konusunda literatürde pek çok farklı görüş bulunmaktadır. Genel olarak ifade etmek gerekirse, n karar verme birimi sayısı, m girdi sayısı ve s çıkıtı sayısı olmak üzere; $R_v = n/(m+s)$, şeklinde hesaplanan oran çok küçük olursa veri zarflama analizi etkin ve etkinsiz birimlerin sayısı bakımından ayırım gücünü kaybedecektir (Pedraja-Chaparro et al., 1999).

R_v oranı için literatürde çeşitli değerler uygun görülmüştür. Golany ve Roll (1989) R_v oranı için $R_v > 2$ olduğunu kabul etmekte ve buna bağlı olarak da, karar verme birimi sayısının $n \geq 2(m+s)$ eşitsizliğinde verilen koşula uygun olacak şekilde belirlenmesi gerektiğini ifade etmektedirler. Banker vd. (1989) $R_v > 3$ olduğunu kabul etmekte ve karar verme birimi sayısının da $n \geq 3(m+s)$ eşitsizliğine uygun olacak şekilde belirlenmesi gerektiğini savunmaktadır. Banker vd. (1989)'nin karar verme birimi sayısı konusunda kabul ettikleri bu kural ayrıca Friedman ve Sinuany-Stern (1998) ile Cooper vd. (2011)'in çalışmalarında da kabul koşulu olarak yer almaktadır. Dyson vd. (2001) ise, $R_v > 2(m \times s)$ olduğunu kabul etmekte ve karar verme birimi sayısının $n \geq 2(m \times s)$ eşitsizliğine uygun olacak şekilde belirlenmesini uygun görmekteyiz. Cooper vd. (2000: 252) karar verme

birimi sayısı n 'i belirlerken Banker vd.'de olduğu gibi $3(m+s)$ veya $m \times s$ değerlerinden maksimum olanına eşit veya büyük bir sayı olması koşulunun uygun olacağını belirtmişlerdir. Bu doğrultuda, iddialarını $n \geq \max \{m \times s, 3(m+s)\}$ eşitsizliği ile ifade etmektedirler. Bunların dışında literatürde kullanılan bir başka karar verme birimi sayısı koşulu, Boussofiane vd. (1991) tarafından yapılan çalışmada $n \geq m+s+1$ eşitsizliği ile ifade edilmekte ve yaygın olarak kullanılmaktadır. Khezrimotlagh (2015)'e göre eğer karar verme birimi sayısı, değişken sayısından az ise, yani bu koşullardan hiçbirini sağlamıyorsa, Khezrimotlagh vd. (2013) tarafından ortaya konan Kourosh ve Arash Modeli (KAM) gibi farklı modeller kullanmak daha doğru sonuçlara ulaşılmasını sağlayacaktır.

Etkinliği ölçülecek karar verme birimlerinin sayısına bağlı olarak, bu etkinliği belirlediği düşünülen ve nedensel olarak birbirine bağlı girdi-çıkıtı değişkenleri belirlenir. Bu aşamada parametrik modellerde olduğu üzere girdiler ile çıktılar arasında fonksiyonel bir bağıntının olması beklenmez. Ancak etkinlik düzeyine etkileri, teorik bilgiler ile ortaya konabilecek ve homojen karar verme birimleri için ortak belirlenmiş faktörler olmalıdır (Aladağ vd., 2018: 3). Veri zarflama analizinin sınırlılığı olarak ortaya konan önemli bir özelliği, dışlanan bir değişkeni etkin olarak kullanan karar verme ajanının etkinlik puanının düşebilme ihtimalidir. Bu nedenle VZA aslında belirlenen bahsi geçen birimler adına sadece seçilen girdi-çıkıtı değişkenleri altında etkinlik değerini belirleyebilmektedir.

Bu noktada etkinliği yükseltmek için girdi ve çıktı değişkenlerinin artırılması bir çözüm gibi görünse de gereğinden fazla değişken eklenmesi veri zarflama analizinin ayrışma yeteneğinin düşmesine neden olmaktadır (Tepe, 2006: 68). Bu nedenle zaman zaman girdi ve çıktı değişkenlerinin azaltılması gereken durumlar ortaya çıkabilmektedir. Değişken azaltmak için genellikle korelasyon ilişkileri inceleme, AHP, DEMATEL gibi çok kriterli karar verme yöntemleri veya temel bileşenler analizi (PCA) gibi yöntemler kullanılmaktadır. Tepe (2006: 69)'ye göre, dual girdiler ile çıktılar arasında yüksek dereceden bir korelasyon ilişkisi söz konusu ise, içlerinden birinin çıkartılmasının, etkinlik değerlerinde değişime yol açmayacaktır. Fakat korelasyon ilişkisi girdi ve çıktı ikilileri arasında gözlemleniyorsa ve bu değişkenler birbirinin yerine kullanılacak durumda değilse, yine de birisi çıkartılabilmekte ancak böyle bir vaziyette etkisiz birimlerin birkaçının etkinlik skorlarında tekrar düşüş görülmesine rağmen etkin olanlarınsa durumdan etkilenmediği görülmektedir.

Girdiler ile çıktıların belirlenmesinin akabinde, ölçeğe göre getirilerin (ölçek etkinliklerinin) belirlenmesi gerekmektedir. Standart veri zarflama analizi modellerine ölçek etkinliği kalitatif olarak belirlenmektedir. Modelde girdilerin artırılmasıyla beraber çıktı düzeylerinde gözlemlenen artışın girdilerinkinden fazla olması ölçeğe artan getiri, az olması azalan getiri ve aynı düzeyde olması ise ölçeğe sabit getiri varsayımını göstermektedir. Veri zarflama analizinin temel modeli olarak görülen Charnes vd. (1978)'nin inşa ettiği CCR modelinin de ölçeğe sabit getiri (CRS) özelliğine sahip olduğu bilinmektedir. Buna karşılık, bu modelden birkaç yıl sonra ortaya konan diğer temel model olan Banker vd. (1984)'nin BCC modelinde ise ölçeğe değişen getiri (artan/azalan) (VRS) özelliği söz konusudur.

Ölçeğe göre getiri seçiminden sonra modelin yöneliminin belirlenmesi gerekmektedir. Modeller yönelimleri açısından değerlendirildiğindeyse girdi yönelimli, çıktı yönelimli ya da yönlendirilmemiş olmak üzere üç şekilde kategorize edilebilirler. Girdi yönelimli modellerde herhangi bir karar verme ajanının etkinliğini artırmak için, çıktıların seviyesini değiştirmeden girdilerin miktarını azaltmaya çalışırken, çıktı yönelimli modeller ise girdilerin seviyesini değiştirmeden çıktıların miktarını artırmaya çalışır. Bu nedenle girdi yönelimli ve çıktı yönelimli modellerden elde edilen etkinlik katsayıları farklı olabilir. Yönlendirilmemiş modeller, girdi ve çıktıları aynı anda geliştirerek karar verme biriminin etkinlik düzeyinin nasıl artırılacağı konusunda bilgi vermektedirler (Ren et al., 2019: 151629).

Buradan da anlaşılacağı gibi modelin yönelimine göre, klasik veri zarflama analizi modelleri girdileri azaltma veya çıktıları artırma üzerine kuruludur. Fakat modellerde girdi ve çıktı değişkenleri belirlenirken her zaman minimum olması gereken girdi veya maksimum olması gereken çıktı söz konusu olmayabilir. Aksi yönlü olması gereken değişkenler Koopmans (1951: 39) tarafından istenmeyen girdi ve istenmeyen çıktılar olarak isimlendirilir. İstenmeyen girdi ve çıktıların modelde yer alması durumunda karar verme birimlerinin etkinliğinin artırılması için bu değişkenlere doğrusal bir monoton azalan dönüşüm uygulanabilmektedir.

Yöntem son yıllarda, girdi ve çıktı değişkenlerinin aldığı değerlere göre yeni modeller ortaya çıkması ile gelişim göstermiştir. Tüm değişkenlerin zıt yönlü olması durumunda ters veri zarflama analizi, tüm değişkenlerin oran olması durumunda çarpımsal veri zarflama analizi kullanmak gibi, değişkenlerin aldığı değerlerin durumuna göre kullanılacak veri zarflama analizi modelini değiştirmek mümkündür. Son yıllarda farklı durumlar için geliştirilen veri zarflama analizi modellerinin sağladığı avantajlar, analizin etkinlik ölçümü amaçlı kullanımının yanında karşılaştırma ve endeks oluşturma amaçlı kullanımını da yaygınlaştırmıştır (Emreouzejad & Amin, 2009; Bogetoft & Otto, 2011; Pastor et al., 2022). Parametrik olmayan bir yöntem olması ve yönetime özgü kullanıcı dostu programların gelişmesi nedenleri ile birçok farklı alandaki araştırmacı tarafından yaygın olarak kullanılmaktadır.

4.2.1. Charnes, Cooper ve Rhodes (CCR) Modeli

Charnes vd. (1978) tarafından çıktı yönelimli CCR ile literatüre kazandırılan model, veri zarflama analizinin temel modellerinden birisi olarak benimsenmiştir. Ölçeğe sabit getiri varsayımı altında çoklu girdi ve çıktı değeri olan karar verme birimleri için görece etkinlik değerlerini Model 1’de gösterilen doğrusal programlama modeli ile her karar verme birimi için ayrı ayrı hesaplamaktadır.

$$\text{Min } \theta_k = \sum_{i=1}^m \omega_i x_{ik} \quad (1)$$

$$\sum_{i=1}^m \omega_i x_{ij} - \sum_{r=1}^s \mu_r y_{rj} \geq 0 \quad (2)$$

$$\sum_{r=1}^s \mu_r y_{rk} = 1 \quad (3)$$

$$\omega_i, \mu_r \geq \varepsilon \geq 0 \quad (i=1,2,\dots,m) \quad (r=1,2,\dots,s) \quad (\text{Model 1})$$

Model 1’de; m , girdi sayısı s , çıktı sayısı x_{ij} , j . karar birimi tarafından kullanılan i . girdi x_{ik} , k . karar birimi tarafından kullanılan i . girdi y_{rj} , j . karar birimi tarafından üretilen r . çıktı y_{rk} , k . karar birimi tarafından üretilen r . çıktı w_i , k . karar biriminin i . girdi için vereceği ağırlık ε ise yeterince küçük pozitif bir sayıyı ifade etmektedir.

4.2.2. Banker, Charnes ve Cooper Modeli (BCC)

Banker, Charnes ve Cooper (1984) tarafından ortaya konan BCC modelinde, görece etkinlik değerleri ölçeğe değişen getiri varsayımı altında hesaplanmaktadır. Bu yönüyle CCR modelinden farklı olarak modele konvekslik kısıtı eklenmektedir (Çağlar, 2003). Burada parçalı-doğrusal konveks örtü özelliğinde ortaya çıkan etkinlik sınırı, ölçeğe değişen (artan veya azalan) getiriye ifade edebilmesini sağlar. Çıktı Yönelimli BCC Modeli ise Model 2’de Model 1 ile aynı notasyonlar ile ifade edilmektedir.

$$\text{Min } \theta_k = \sum_{i=1}^m \omega_i x_{ik} - \omega_0 \quad (4)$$

$$\sum_{i=1}^m \omega_i x_{ij} - \sum_{r=1}^s \mu_r y_{rj} - \omega_0 \geq 0 \quad (5)$$

$$\sum_{r=1}^s \mu_r y_{rk} = 1 \quad (6)$$

$$\omega_i, \mu_r \geq \varepsilon > 0 \quad (i=1,2,\dots,m) \quad (r=1,2,\dots,s) \quad \omega_0 : \text{işareti kısıtlanmaz} \quad (\text{Model 2})$$

5. Bulgular

Analizde ele alınacak teorik problemin yapısı gereği, girdi azaltılması, vergi etkinliği açısından istenmeyen bir durum olarak görülmektedir. Her ne kadar burada seçilen girdi değişkenlerinin (toplam vergi maliyetlerinin GSMH içindeki payı, vergi mükellefi sayısı, vergi idare kurumları çalışan sayısı) vergi maliyetini artırıcı etkileri söz konusu olsa da girdi yönelimli bir model bu değişkenleri azaltırken veri çıktı düzeyini sabit tutacaktır. Modelde çıktı değişkeni olarak belirlenen kişi başına düşen GSYİH ve toplam vergi gelirin GSMH içindeki payı değişkenlerinin sabit olması, elde edilecek sonuçların vergi idaresi kurumlarının etkinlik katsayılarını göstermekten ziyade, mevcut gelirin daha az maliyet ile (daha etkin) elde edilebilmesi için seçilen girdi değişkenlerinde yapılacak azalışları göstermesi anlamına gelecektir. Bu nedenle yapılması gereken veri girdi miktarını kullanarak çıktıları artırma yöntemi ile vergi etkinliğinin artırılması, yani çıktı yönelimli model kullanılmasıdır. Böylece veri vergi mükellefi, vergi maliyetleri ve vergi idaresi kurumları çalışan sayısı değişkenleri ile birlikte, vergi gelirin ve GSYH’nın nasıl ve ne

kadar artırılabilirine yanıt aranacaktır. Bu noktada hem CCR hem BCC modelleri tahmin edilerek, ölçek etkinliklerine ilişkin varsayımlardaki deęişimlerin etkisi de gözlemlenmiş olacaktır.

Analizde kullanılan karar verme ajanlarının sayısının girdi-çıkıtı deęişken sayısı ile ilişkisi, Banker vd. (1989), Golany ve Roll (1989), Boussofiane vd. (1991), Cooper vd. (2000) ve Dyson (2001) tarafından yapılan çalışmalarda ifade edilen kuralların tümüne uyum sağlamaktadır. Çalışmaya başlamadan önce seçilen girdiler ve çıktılar arasındaki korelasyon ayrıca incelenmiştir. Sonuçlar Tablo 2’de verilmektedir.

Tablo: 2
Korelasyon Analizi Sonuçları

	TRev	TPyr	TExp	TSıf	GDP
TRev	1.00	-	-	-	-
TPyr	0.3073	1.00	-	-	-
TExp	0.5763	-0.3529	1.00	-	-
TSıf	0.0297	0.5989	-0.0615	1.00	-
GDP	0.2657	0.0194	0.0531	-0.0357	100

Not: Tüm katsayılar %5 anlamlılık düzeyinde istatistiksel olarak anlamlı bulunmuştur.

Deęişkenler arasındaki korelasyona ilişkin elde edilen katsayılar, aralarındaki ilişkilerin beklentiler ile uyumlu yönde olduğunu göstermektedir. Elde edilen korelasyon katsayıları, girdi ve çıkıtı deęişkeni olarak seçilen deęişkenlerin nedensel olarak birbirine baęlılığının beklenen düzeyde ve etkinlik skorlarını etkileyecek (yüksek korelasyondan dolayı gerçekte birbirinin yerine kullanılabilir) kadar yüksek ilişkide olmadıklarını göstermektedir.

5.1. CCR Modeli Sonuçları

Ölçeęe sabit getiri varsayımı altında her karar verme birimi için çözümlenen çıkıtı yönelimli CCR modeli sonucunda elde edilen toplam etkinlik katsayıları Tablo 3’te yer almaktadır. Burada etkinlik deęeri 1 olarak hesaplanan ülkeler tam etkindir. Etkinlik skorları 1’in altında olan karar verme birimleri ise “etkinsiz birimler” olarak isimlendirilmektedir.

Tablo 3
Etkinlik Skorları

Karar Verme Birimleri	Etkinlik Katsayısı	Etkinlik Durumu	Karar Verme Birimleri	Etkinlik Katsayısı	Etkinlik Durumu
Avustralya	0,539753		Japonya	0,734088	
Avusturya	0,727678		Güney Kore	0,921304	
Belçika	0,638798		Letonya	0,439379	
Kanada	0,431849		Litvanya	0,591072	
Şili	0,459538		Lüksemburg	1,000000	Etkin
Çekya	0,476825		Meksika	0,947536	
Danimarka	0,381669		Hollanda	0,424158	
Estonya	1,000000	Etkin	Yeni Zelanda	0,565033	
Finlandiya	0,701927		Norveç	0,723643	
Fransa	0,783096		Polonya	0,485069	
Almanya	0,364778		Portekiz	0,371113	
Yunanistan	0,621601		Slovakya	0,544539	
Macaristan	0,289327		Slovenya	0,392816	
İzlanda	1,000000	Etkin	İspanya	1,000000	Etkin
İrlanda	1,000000	Etkin	İsveç	0,713685	
İsrail	0,487639		Türkiye	0,673292	
İtalya	0,725143		Birleşik Krallık	0,593398	
			Amerika Birleşik Devletleri	1,000000	Etkin

Tablo 3'te yer alan sonuçlara göre, Estonya, İzlanda, İrlanda, Lüksemburg, İspanya ve Amerika Birleşik Devletleri'nde vergi idaresi kurumları tam etkin olarak çalışmaktadır. Buna karşılık etkinlik sınırın altında yer alan ülkelerin, etkinlik sınırına ulaşmaları için yapacakları iyileştirmeleri gösteren varsayımsal referans birimleri Tablo 4'te verilmiştir. Referans kümede yer alan ülkeler etkin ülkelerden oluşmaktadır ve referans olma sıklığına (frekansı) göre etkin ülkeleri de kendi içinde sıralayabilmek mümkündür. Bu yaklaşımla referans olma sıklığı en yüksek olan ülke, etkin ülkelerin içinde yapılacak sıralamada birinci sırada yer alacaktır.

Tablo: 4
Referans Birimler

Karar Verme Birimleri	Estonya	İzlanda	İrlanda	İspanya	Amerika Birleşik Devletleri
Avustralya	0,832		0,891		0,155
Avusturya	1,306		0,408	0,164	0,007
Belçika	1,483		0,38	0,255	
Kanada	0,506		0,695	1,329	
Şili	1,222			0,131	
Çekya	2,117			0,059	
Danimarka	2,464	0,791	0,55		
Finlandiya	1,527		0,412		0,004
Fransa				1,6	0,072
Almanya	1,187		0,711	1,454	
Yunanistan	1,477			0,406	
Macaristan	3,734			0,031	
İsrail	1,316	0,109	0,641		
İtalya	0,602			1,104	
Japonya	1,011		0,391	0,01	
Güney Kore	0,482		0,191	0,268	
Letonya	0,285	1,766			
Litvanya	1,506			0,023	
Meksika				0,249	0,343
Hollanda	1,892		0,876	0,291	
Yeni Zelanda	1,225	0,124	0,476		
Norveç	0,794	0,325	0,787		
Polonya	0,935			1,183	
Portekiz	2,476			0,288	
Slovakya	0,375	1,465			
Slovenya	2,127	0,673			
İsveç	1,296		0,456	0,19	
Türkiye	0,326			0,674	
Birleşik Krallık	1,282		0,518	0,023	
Referans olma sıklığı	27	7	15	20	5

Not: Sütünlarda, etkin olmasına rağmen referans birim olmayan karar verme birimlerine yer verilmemiştir.

Tablo 4'te yer alan katsayılar, etkinlik sınırın altında kalan ülkelerin, etkin hale gelmesi için ulaşması gereken iyileştirme hedefleri hakkında bilgi vermektedir. Yapılan analizlerde, her karar verme birimi için söz konusu iyileştirmeler gerçekleştirildiğinde, elde edilebilecek en iyi çıktı performansları Tablo 5'te yer almaktadır.

Tablo: 5
Projeksiyonlar

Karar Verme Birimleri	Toplam Vergi Geliri	Kişi Başına GSMH	Karar Verme Birimleri	Toplam Vergi Geliri	Kişi Başına GSMH
Avustralya	23,5942	46,792,1	Japonya	11,3742	14,771
Avusturya	15,9424	18,754,6	Güney Kore	2,33191	2,727,97
Belçika	24,1443	26,344,7	Letonya	39,8093	22,873,6
Kanada	44,4681	60,963,8	Litvanya	20,9628	13,543,3
Şili	24,5805	17,337,7	Meksika	0,902515	550,947
Çekya	38,1828	25,960,1	Hollanda	53,3541	71,242,4
Danimarka	75,4953	96,840,9	Yeni Zelanda	24,249	32,913,3
Finlandiya	17,9627	20,650,1	Norveç	15,2377	28,917,1
Fransa	12,4366	11,239,6	Polonya	37,2608	16,700,7
Almanya	67,2178	81,488,4	Portekiz	58,4637	39,536,4
Yunanistan	24,0455	11,647,6	Slovakya	28,94	16,145,8
Macaristan	89,6548	41,107,7	Slovenya	57,5008	40,100,5
İsrail	31,731	46,179,4	İsveç	17,1704	20,836,9
İtalya	16,0713	12,751,5	Türkiye	11,209	4,426,13
			Birleşik Krallık	22,4064	29,512,4

Tablo 5’te yer alan çıktılar için en iyi performans değerleri, sadece etkinlik sınırı altındaki karar verme birimleri için hesaplanabilmektedir. Bu nedenle etkin karar verme birimleri için projeksiyon değerleri söz konusu olmamaktadır.

5.2. BCC Modeli Sonuçları

Çalışmada ikinci aşama olarak, ölçek etkinliklerini hesaplayabilmek adına, ölçeğe değişen getiriler varsayımı altında çıktı yönelimli BCC modelinden elde edilen saf teknik etkinlik değerlerini her karar verme birimi için hesaplanmıştır. Sonuçlar, Tablo 6’da yer almaktadır.

Tablo: 6
Etkinlik Skorları

Karar Verme Birimleri	Etkinlik Katsayısı	Etkinlik Durumu	Karar Verme Birimleri	Etkinlik Katsayısı	Etkinlik Durumu
Avustralya	0,716848		Japonya	0,861256	
Avusturya	1,000000	Etkin	Güney Kore	1,000000	Etkin
Belçika	0,988186		Letonya	0,783422	
Kanada	0,766973		Litvanya	0,815721	
Şili	0,562281		Lüksemburg	1,000000	Etkin
Çekya	0,838399		Meksika	1,000000	Etkin
Danimarka	1,000000	Etkin	Hollanda	0,879222	
Estonya	1,000000	Etkin	Yeni Zelanda	0,768066	
Finlandiya	1,000000	Etkin	Norveç	0,979721	
Fransa	1,000000	Etkin	Polonya	0,790639	
Almanya	0,841902		Portekiz	0,77978	
Yunanistan	0,925038		Slovakya	0,870676	
Macaristan	0,798712		Slovenya	0,902088	
İzlanda	1,000000	Etkin	İspanya	1,000000	Etkin
İrlanda	1,000000	Etkin	İsveç	1,000000	Etkin
İsrail	0,718214		Türkiye	0,673292	
İtalya	1,000000	Etkin	Birleşik Krallık	0,812341	
			Amerika Birleşik Devletleri	1,000000	Etkin

Tablo 6’da yer alan sonuçlara göre etkin olan karar verme birimleri; Avusturya (AT), Danimarka (DK), Estonya (EE), Finlandiya (FI), Fransa (FR), İzlanda (IS), İrlanda (IE), İtalya (IT), Güney Kore (KR), Lüksemburg (LU), Meksika (MX), İspanya (ES), İsveç (SE)ve Amerika Birleşik Devletleri (USA)’dır.

Tablo: 7
Referans Birimler

Karar Verme Birimleri	AT	DK	EE	FI	FR	IS	IT	LU	ES	SE
Avustralya	0,091				0,175	0,411		0,323		
Belçika		0,085			0,042					0,873
Kanada		0,286			0,422			0,18		0,112
Şili	0,385		0,596				0,019			
Çekya		0,051		0,652				0,297		
Almanya		0,666			0,304			0,031		
Yunanistan	0,837				0,033					0,13
Macaristan		0,811		0,163				0,026		
İsrail		0,047		0,513				0,173		0,267
Japonya	0,268		0,361		0,003	0,367				
Letonya		0,12						0,88		
Litvanya			0,516	0,304				0,18		
Hollanda		0,504			0,162			0,092		0,241
Yeni Zelanda	0,174			0,616		0,153		0,057		
Norveç	0,527				0,01	0,044		0,419		
Polonya		0,144			0,498					0,358
Portekiz		0,371			0,017					0,613
Slovakya		0,101		0,018				0,881		
Slovenya		0,304						0,696		
Türkiye			0,326						0,674	
Birleşik Krallık			0,144	0,694		0,056		0,107		
Referans Olma Sıklığı	6	12	5	7	10	5	1	14	1	7

Not: Sütunlarda etkin olmasına rağmen referans birim olmayan karar verme birimlerine yer verilmemiştir.

Her karar verme biriminin, etkin hale gelebilmek için kendi referans kümesi içinde yer alan ülkelere göre yapacağı iyileştirmeler sonucunda elde edilebilecek en iyi çıktı performansları Tablo 8’de verilmiştir.

Tablo: 8
Projeksiyonlar

Karar Verme Birimleri	Toplam Vergi Geliri	Kişi Başına GSMH	Karar Verme Birimleri	Toplam Vergi Geliri	Kişi Başına GSMH
Avustralya	10,9295	21.675,5	Letonya	8,62526	4.955,89
Belçika	0,510486	557,009	Litvanya	6,84507	4.422,36
Kanada	10,2693	14.078,8	Hollanda	5,39861	7.208,63
Şili	16,2701	11.476	Yeni Zelanda	9,51208	12.910,8
Çekya	6,70769	4.560,49	Norveç	0,825872	1.567,29
Almanya	7,24859	8.787,48	Polonya	9,29446	4.165,88
Yunanistan	3,20094	1.550,53	Portekiz	9,74326	6.588,94
Macaristan	9,19858	4.217,65	Slovakya	5,13923	2.867,21
İsrail	11,8487	17.243,9	Slovenya	4,03768	2.815,84
Japonya	5,05839	6.569,08	Türkiye	11,209	4.426,13
			Birleşik Krallık	7,55404	9.949,73

5.3. Ölçek Etkinliklerinin Hesaplanması

Farrell (1957)’e göre toplam teknik etkinlik, saf teknik etkinlik ve ölçek etkinliğin çarpımından oluşmaktadır. Bu ifade matematiksel olarak $TTE = STE \times ÖE$ şeklinde gösterilebilir. Bu noktada, CCR modeli sonucunda elde edilen toplam teknik etkinlik ve BCC modeli sonucunda elde edilen saf teknik etkinlik skorlarının birbirine bölünmesi ile ölçek etkinlikleri hesaplanabilmektedir. Tablo 9’da ölçek etkinliklere yer verilmiştir.

Tablo: 9
Ölçek Etkinlik Katsayıları

Karar Verme Birimleri	Toplam Teknik Etkinlik	Saf Teknik Etkinlik	Ölçek Etkinlik	Getiriler
Avustralya	0,539753	0,716848	0,752953	Ölçeğe Azalan
Avusturya	0,727678	1,000000	0,727678	Ölçeğe Azalan
Belçika	0,638798	0,988186	0,646434	Ölçeğe Azalan
Kanada	0,431849	0,766973	0,563056	Ölçeğe Azalan
Şili	0,459538	0,562281	0,817274	Ölçeğe Azalan
Çekya	0,476825	0,838399	0,568732	Ölçeğe Azalan
Danimarka	0,381669	1,000000	0,381669	Ölçeğe Azalan
Estonya	1,000000	1,000000	1,000000	
Finlandiya	0,701927	1,000000	0,701927	Ölçeğe Azalan
Fransa	0,783096	1,000000	0,783096	Ölçeğe Azalan
Almanya	0,364778	0,841902	0,433278	Ölçeğe Azalan
Yunanistan	0,621601	0,925038	0,671973	Ölçeğe Azalan
Macaristan	0,289327	0,798712	0,362241	Ölçeğe Azalan
İzlanda	1,000000	1,000000	1,000000	
İrlanda	1,000000	1,000000	1,000000	
İsrail	0,487639	0,718214	0,678960	Ölçeğe Azalan
İtalya	0,725143	1,000000	0,725143	Ölçeğe Azalan
Japonya	0,734088	0,861256	0,852345	Ölçeğe Azalan
Güney Kore	0,921304	1,000000	0,921304	Ölçeğe Artan
Letonya	0,439379	0,783422	0,560845	Ölçeğe Azalan
Litvanya	0,591072	0,815721	0,724600	Ölçeğe Azalan
Lüksemburg	1,000000	1,000000	1,000000	
Meksika	0,947536	1,000000	0,947536	Ölçeğe Artan
Hollanda	0,424158	0,879222	0,482424	Ölçeğe Azalan
Yeni Zelanda	0,565033	0,768066	0,735656	Ölçeğe Azalan
Norveç	0,723643	0,979721	0,738621	Ölçeğe Azalan
Polonya	0,485069	0,790639	0,613515	Ölçeğe Azalan
Portekiz	0,371113	0,77978	0,475920	Ölçeğe Azalan
Slovakya	0,544539	0,870676	0,625420	Ölçeğe Azalan
Slovenya	0,392816	0,902088	0,435451	Ölçeğe Azalan
İspanya	1,000000	1,000000	1,000000	
İsviçre	0,713685	1,000000	0,713685	Ölçeğe Azalan
Türkiye	0,673292	0,673292	1,000000	Ölçeğe Azalan
Birleşik Krallık	0,593398	0,812341	0,730478	Ölçeğe Azalan
Amerika Birleşik Devletleri	1,000000	1,000000	1,000000	

Karar verme birimlerinin en verimli ölçek büyüklüğünde faaliyet gösterdiğini söyleyebilmek için her iki modelde de etkinlik katsayısının 1 olması beklenmektedir. Bu durumda karar verme birimine %100 etkindir denilebilir. Bu durumda olan karar verme birimlerinin ölçek etkinlikleri de 1 olacaktır. Ki bu durumda, bu ülkeler Tablo 9'dan da görüleceği üzere, Estonya, İzlanda, İrlanda, Lüksemburg, İspanya ve Amerika Birleşik Devletleri'dir. Güney Kore ve Meksika dışındaki tüm ülkelerde ölçeğe azalan getiri (çıktılardaki artış girdilerdeki artıştan daha az) mevcuttur.

TTE < 1 iken, STE = 1 ise, bu karar verme biriminin yerelde etkin iken, küresel düzeyde etkisiz olduğu anlaşılmaktadır. Hem CCR hem BCC modeli için etkinlik katsayısının <1 olması durumunda, karar verme birimi hem ölçeğe değişim getiri durumunda (saf teknik etkinlik < 1) girdileri verimli kullanamamakta, hem de bu girdilere uygun ölçekte çıktı üretme başarısı (ölçek etkinliği < 1) gösterememektedir (Aydın, 2019: 284). Ölçek etkinliği 1 olan ülkeler ise uygun ölçekte çıktı üretme başarısı gösterebilmektedir. Türkiye hem ölçeğe sabit hem de değişen getiri varsayımı altında etkinlik sınırının altında kalan bir karar verme birimi olması yönünden yerel ve küresel düzeyde etkisiz bir ülke olmasına rağmen, etkinlik skoru her iki düzey için aynı hesaplandığından ölçek etkinliği 1 olarak hesaplanmaktadır.

6. Sonuç ve Genel Değerlendirme

Yapılan analizler sonucunda, 2019 yılı için 35 OECD ülkesinin vergi idaresi kurumlarının etkinlik düzeyleri ve ölçek etkinlikleri belirlenmiştir. Elde edilen sonuçlar ölçeğe sabit getiriler varsayımı altında elde edilen CCR modeli sonuçlarına göre; Estonya, İzlanda, İrlanda, Lüksemburg, İspanya ve Amerika Birleşik Devletleri'nin, ölçeğe değişen getiriler varsayımı altında elde edilen BCC model sonuçlarına göre ise; Avusturya, Danimarka, Estonya, Finlandiya, Fransa, İzlanda, İrlanda, İtalya, Güney Kore, Lüksemburg, Meksika, İspanya, İsveç ve Amerika Birleşik Devletleri'nin vergi idaresi kurumlarının tam etkin çalıştığını göstermektedir. Ölçeğe değişen getiriler varsayımı altında, etkin ülke sayısının altıdan on dörde yükseldiği görülmektedir. Yani, küresel düzeyde etkinsiz olmasına rağmen, yerel düzeyde etkin olan sekiz ülke daha mevcuttur. Uygun ölçek düzeyinde üretim yapma başarısını gösteren ölçek etkinlikleri incelendiğinde ise, toplam teknik etkinliği 1 olan altı ülkenin etkin olduğu gözlenmektedir. Bu durum, söz konusu ülkelerin girdileri çıktıya dönüştürme sürecinde tam başarı gösterdiklerini ifade etmektedir.

Diğer yandan yapılan analizlerde, etkinlik sınırının altında kalan ülkeler için, veri girdi düzeyi ile etkin hale gelebilmelerini sağlayacak çıktı seviyeleri için projeksiyonlar hesaplanmıştır. Bu durumda olan ülkelerin, ilgili değerleri göz önüne alarak referans kümelerinde yer alan ülkelerin değerlerine göre strateji geliştirmesi ve karar alıcılar tarafından bu stratejilerin uygulanması gerekmektedir.

Bu makale literatüre birkaç şekilde katkı yapmaktadır. Ülkeler arasında vergi dairelerinin VZA/SFA görelî etkinlik puanlarını tahmin etmeye yönelik bilinen en güncel girişimdir. Literatürün vergilendirme tarafındaki mevcut makaleler, esas olarak belirli bir ülkedeki vergi dairelerine odaklanmaktadır (Thanassoulis et al., 1987; Moesen & Persoon, 2002; Robinson & Slemrod, 2011; Alm & Duncan, 2014; Das-Gupta et al., 2016; Aziz & Al-Hareti, 2018; Güler & Kaba, 2018; Ubaidillah & Amah, 2020; Yuliyu et al., 2020; MacKenzie, 2021; Martinez et al., 2022). Böyle bir ulus-ıçi bakış açısının bazı avantajları olsa da uluslararası bir çalışmanın günümüzün küreselleşmiş dünyasında daha etkili olduğu görüşü literatürde de hâkimdir (Alm & Duncan, 2014: 94). Ayrıca bu çalışmada gelir vergisi, kurumlar vergisi gibi tekil vergi oranlarının etkisel özelliklerinden ziyade vergi mükellefleri ve vergi idaresi çalışanları da olmak üzere vergi maliyetlerinin payı ve büyüme rakamları da dikkate alınmıştır. VZA'nın özelliklerinden biri, girdi ve çıktı sayısına göre örneklem büyüklüğü arttıkça göreceli olarak verimli karar verme birimlerini belirleme yeteneğinin artmasıdır. Böylece girdi ve çıktıların yanı sıra girdi olarak değerlendirdiğimiz unsurları etkileyen çevresel diğer faktörlerin de çalışmaya dâhil edilebilmesi söz konusu olmuştur. Tüm bunların yanı sıra ülkeler arasında tutarlı ve karşılaştırılabilir bir etkinlik puan seti oluşturulmuştur. Bu durum ülkelerin maliye politikalarını formüle ederlerken kendilerini çeşitli marjlarda karşılaştırmaya devam ettikleri mevcut ekonomik ortam özellikleri sebebiyle de ayrıca önemlidir. Politika yapıcılara karşılaştırılabilir bir şekilde diğer ülkelere kıyasla nerede durduklarına dair daha doğru bir tablo sunmaktadır. Nihai olarak görelî etkinlik puanlarını farklı bir açıdan ülkeler arasındaki görelî etkinliğin belirleyicileri olarak

kullanmak da mümkündür. Öyle ki bu hükümetlere vergi idarelerinin etkinliğini artırmak için izleyebilecekleri politikalar hakkında verisel bir değerlendirme imkânı yaratmaktadır.

Her bir ülke kendi referans kümesi içerisinde değerlendirildiğinde, her bir ülke için toplam vergi geliri ve kişi başına düşen GSMH miktarının artırılmasının kanunlarla net çizilmiş mali sınırları bulunan gelişmiş ülkelere göre daha az sıkı tutulduğu gelişmekte olan ülkelere doğru uygun bir politika projeksiyonu olarak ortaya çıktığı görülmektedir. Bu durumda sıkı iktisadi ve mali politikaların kanuni güvence altına alınarak siyasi ve dahil diğer olası baskılardan uzak yönetilebilmesinin gerekliliği de ortaya çıkmaktadır. Öte yandan ölçeğe göre azalan getiri ile çalışan karar verme birimlerinin maksimum verimlilikte bulunmaması aslen bu ülkelerin etkisiz olduğunun işareti de değildir. OECD ülkeleri içerisinde yer alan Türkiye saf teknik etkinlik skoru düşük olmasına rağmen tam teknik etkinliğe sahiptir. Bu durum ölçeğe değişen getiri durumunda girdilerini verimli kullanamamasına rağmen, bu girdilere uygun ölçekte çıktı üretme başarısı gösterdiğini ortaya koymaktadır. Uygun ölçekte çıktı üretme başarısı göstermesi hem yerel hem küresel olarak vergi idaresi kurumları etkinliğinde aynı performans sergilediğini ortaya koymaktadır. Lakin, küresel düzeyde tam etkinlik sağlamadığı böylesi bir durumda girdilerini artırarak çıktı düzeyini artırmak için politika hedefler koyması ve geliştirilmesi gerektiğini göstermektedir. Bu durumda vergi maliyetlerini artırmayan ve vergi gelirlerinin azalmasına sebebiyet veren vergi harcaması, Tanzi etkisi gibi olumsuz durumları bertaraf edecek politika reçetelerinin yazılması gerekir. Sistemin kanuni kayıpları olarak değerlendirilebilecek vergi harcamalarının - muafiyet ve istisna benzeri- özellikle kanuna uyma bilincinin yeteri kadar gelişmediği toplumlarda vergi bilinç ve ahlakının zedeleyebileceği göz önünde bulundurularak vergi erozyonu yaratmamak adına bu uygulamaların azaltılması gerekmektedir. Özellikle kamu gelirlerini ve dahil ülkenin milli gelirini artırıcı bir öge olarak vergi denetimlerinin etkin gerçekleştirilmemesinin yarattığı kayıtdışılık göz önüne alınmalıdır. Bu bağlamda kural ve kaidelerin mali sistemde yarattığı donatıların yeterliliğinin yanı sıra uygulama ve denetleme birimlerinin de yeterli ve nitelikli hale getirilmesi, ceza ve müeyyidelerin caydırıcılığının artırılması, teknik enformasyonel becerilerin geliştirilmesi de gerekmektedir.

Çalışma girdi ve çıktı değişkenlerin seçiminde Robinson ve Slemrod (2011), Alm ve Duncan (2014), Araki ve Claus (2014), Mackenzie (2021), Martinez vd. (2022) ve OECD (2011) çalışmalardan faydalanmıştır. Bunun dışında mümkün olduğunca ülkelerin özel durumlarını yansıtmayacak değişkenlerin seçilmesine özen gösterilmiştir. Ancak yine de veri zarflama analizi doğası gereği sadece seçilen girdi ve çıktı değişkenleri ve yıl için geçerli olan sonuçları gösterme sınırlılığına sahiptir. Çalışmanın bu anlamdaki kısıtlılığı, farklı girdi ve çıktılar ile farklı ülke/ülke grupları veya farklı yıllar için tekrar edilmesi durumunda farklı sonuçların ortaya çıkabileceğini işaret etmektedir. Bu çalışmada bulunan sonuçlar incelenen literatürle uyumludur. Diğer yandan çalışma, vergi idaresi kurumlarının etkinliğini ölçerken literatürdeki mevcut çalışmalardan hareketle vergi maliyeti ve vergi gelirlerinin GSYH içindeki payı gibi iki temel değişkenden hareket etmiştir. Bunun önemli bir nedeni, vergi idaresi kurumlarının etkinliğini belirleyen diğer değişkenlere ilişkin veri elde edilmesindeki kısıtlılıktır. Bu nedenle, uygun verilerin elde edilmesi halinde, gelecek

çalıřmalarda etkinliđi etkileyebilecek farklı veriler ve/veya farklı ülkeler için yenilenebilir. Ayrıca gün geçtikçe geliřmekte olan veri zarflama modelleri göz önünde bulundurulduğunda, örneđin seçilecek yeni deđiřkenlerin istenmeyen çıktı olması durumunda ters veri zarflama analizi ile çalıřılması gibi, yeni modellerle analizlerin yenilenmesi mümkün olacaktır.

Kaynaklar

- Aladađ, Z. vd. (2018), "Akademik Birimlerin Veri Zarflama Analizi ve Promethee Yöntemleri ile Performans Deđerlendirmesi: Kocaeli Üniversitesi Örneđi", *Erciyes Üniversitesi Fen Bilimleri Enstitüsü Dergisi*, 34(1), 1-13.
- Alm, J. & D. Duncan (2014), "Estimating tax agency efficiency", *Public Budgeting & Finance*, 34(3), 92-110.
- Ayçin, E. (2019), *Çok Kriterli Karar Verme Bilgisayar Uygulamalı Çözümler*, (1. Basım), Ankara: Nobel Yayınevi.
- Aziz, S.A. & A.R.S Al-Harethi (2018), "Factors Determining Tax Administration Efficiency in Hadhramout, Yemen: Perception from Individual Taxpayers", *Proceedings of the 5th International Conference on Accounting Studies (ICAS 2018) 16-17 October 2018*, Penang, Malaysia.
- Banker, R.D. et al. (1984), "Some Models For Estimating Technical and Scale Inefficiencies in Data Envelopment Analysis", *Management Science*, 30(9), 1078-1092.
- Banker, R.D. et al. (1989), "An Introduction to Data Envelopment Analysis with Some of Its Models and Their Uses", *Res. Gov. Non-Profit Account*, 5, 125-163.
- Barros, C.P. (2005), "Performance measurement in tax offices with a stochastic frontier model", *Journal of Economic Studies*, 32(6), 497-510.
- Bogetoft, P. & L. Otto (2011), *Benchmarking with DEA, SFA and R*, New York: Springer.
- Boussofiane, A. et al. (1991), "Applied Data Envelopment Analysis", *European Journal of Operational Research*, 52(1), 1-15.
- Charnes, A. et al. (1978), "Measuring The Efficiency of Decision-Making Units", *European Journal of Operational Research*, 2(6), 429-444.
- Cooper, W.W. et al. (2000), *Data Envelopment Analysis A Comprehensive Text With Models*, USA: Springer.
- Cooper, W.W. et al. (2011), "Data Envelopment Analysis: History, Models, and Interpretations", in: *Handbook On Data Envelopment Analysis* (1-39), Springer, Boston, MA.
- Crandall, W. & M. Kidd (2010), *Revenue Administration: A Toolkit for Implementing a Revenue Authority. Technical Notes and Manuals*, 10/08, IMF Fiscal Affairs Department.
- Çađlar, A. (2003), "Veri Zarflama Analizi ile Belediyelerin Etkinlik Ölçümü", *Doktora Tezi*, Hacettepe Üniversitesi Fen Bilimleri Enstitüsü.
- Çařkurulu, E. & C.B. Arslan (2021), *Kamu Maliyesine Giriř*, 4. Baskı, Gazi Kitabevi: Ankara.
- Dalton, H. (1954), *Principles of Public Finance*, Routledge: London.
- Due, J.F. (1963), *Maliye: Bir İktisadi Analiz*, (Çev. S. Görgün & İ. Önder), İstanbul.
- Dyson, R.G. et al. (2001), "Pitfalls and Protocols in DEA", *European Journal of Operational Research*, 132, 245-259.

- Eliaçık, R.İ. (2010), *Adalet Devleti: Ortak İyinin İktidarı*, İkinci Baskı, İnşa Yayınları: İstanbul.
- Emrouznejad, A. & G.R. Amin (2009), “DEA Models for Ratio Data: Convexity Consideration”, *Applied Mathematical Modelling*, 33(1), 486-498.
- Erdem, M.B. (1978), *Vergi Yönetimi ve Örgütlenmesi*, Eskişehir İktisadi ve Ticari İlimler Akademisi Tez 233/154, Eskişehir.
- Erdem, M.B. (1981), *Vergi Yönetimi ve Örgütlenmesi*, Eskişehir: Eskişehir İktisadi ve Ticari İlimler Akademisi Yayıncılık.
- Farrell, M.J. (1957), “The Measurement of Productive Efficiency”, *Journal of Royal Statistical Society*, 120, 253-281.
- Forsund, F.R. et al. (2015), “Productivity of tax offices in Norway”, *Journal of Productivity Analysis*, 43(3), 269-279.
- Golany, B.A. & Y. Roll (1989), “An Application Procedure for Data Envelopment Analysis”, *Omega*, 17(3), 237-250.
- González, P.E.B. & E.V. Rubio (2013), “The Efficiency of The Regional Management Centres of The Tax Administration in Spain”, *Journal of US-China Public Administration*, 10(1), 49-56.
- Güler, H. & H. Kaba (2018), “The Efficiency of Tax Administration in Turkey”, in: A. Gorecka et al. (eds.), *Economic Issues in Retrospect and Prospect II* (301-315), IJOPEC Publication: London.
- IMF, OECD, UN, WBG (2016), *Enhancing the Effectiveness of External Support in Building Tax Capacity in Developing Countries*, <<https://www.oecd.org/tax/enhancing-the-effectiveness-of-external-support-in-building-tax-capacity-in-developing-countries.pdf>>, 25.05.2023.
- ISORA (2022), *International Survey on Revenue Administration*, <<https://data.rafit.org/?sk=5a3bd47d-bec2-41a9-8f37-e5dbb98e3dcf&sl=1637191076670>>, 25.04.2022.
- ISSAI The International Standards of Supreme Audit Institutions (2009), *Fundamental Principles of Performance Auditing*, INTOSAI General Secretariat: Vienna.
- Katharaki, M. & M. Tsakas (2010), “Assessing the efficiency and managing the performance of Greek tax offices”, *Journal of Advances in Management Research*, 7(1), 58-75.
- Kaynar, O. vd. (2005), “Veri Zarflama Analizi ile OECD Ülkelerinin Telekomünikasyon Sektörlerinin Etkinliğinin Ölçülmesi”, *ÇÜ İktisadi ve İdari Bilimler Dergisi*, 6(1), 37-57.
- Khezrimotlagh, D. (2015), “How to Deal With Numbers of Decision Making Units And Variables in Data Envelopment Analysis”, *13th International Conference On Data Envelopment Analysis*.
- Khezrimotlagh, D. et al. (2013), “Nonlinear Arash Model in DEA”, *Research Journal of Applied Sciences, Engineering and Technology*, 5(17), 4268-4273.
- Kirchler, E. (2010), *The Economic Psychology of Tax Behavior*, Illustrated Edition, Cambridge University Press: Cambridge.
- Koopmans, T.C. (1951), “An Analysis of Production as an Efficient Combination of Activities”, in: T.C. Koopmans (ed.), *Activity Analysis of Production and Allocation*, Cowles Commission for Research in Economics (33-97), Monograph No. 13, Wiley.

- Kumar, S. & R. Gulati (2008), "An Examination of Technical, Pure Technical and Scale Efficiencies in India Public Sector Banks Using Data Envelopment Analysis", *Euroasian Journal of Business And Economics*, 1(2), 33-69.
- Lewis, B.D. (2006), "Local government taxation: An analysis of administrative cost inefficiency", *Bulletin of Indonesian Economic Studies*, 42, 213-33.
- Mackenzie, O.K. (2021), "Efficiency of Tax Revenue Administration in Africa", Stellenbosch University Economic Working Papers, WP02/2021.
- Mandl, U. et al. (2008), *The effectiveness and efficiency of public spending*, European Economy-Economic Papers Directorate General Economic and Financial Affairs (DG ECFIN), European Commission.
- Messere, K. & J.P. Owens (1985), "International Comparisons of Tax Levels: Pitfalls and Insights", *41st Conference of the International Institute of Public Finance* (93-119), Madrid.
- Moesen, W. & A. Persoon (2002), "Measuring and Explaining the Productive Efficiency of Tax Offices: A Non-parametric Best Practice Frontier Approach", *Tijdschrift Voor Economie En Management*, 47(3), 399-416.
- OECD (2014), *Tax Administration in OECD Countries: Comparative Information Series (2004)*, Centre for Tax Policy and Administration, <<https://www.oecd.org/tax/forum-on-tax-administration/publications-and-products/comparative/CIS-2004.pdf>>, 25.05.2023.
- Pastor, J.T. et al. (2022), *Benchmarking Economic Efficiency*, Switzerland: Springer.
- Pedraja-Chaparro, F. et al. (1999), "On The Quality of The Data Envelopment Analysis Model", *The Journal of Operational Research Society*, 50(6), 636-644.
- Ren, J. et al. (2019), "Performance Evaluation of Pallet Rental Companies: Non-Oriented Super-Efficiency Integer-Valued DEA Model", *IEEE Xplore*, 7, 151628-151637.
- Robinson, L. & J. Slemrod (2011), "Understanding Multidimensional Tax Systems", *International Tax and Public Finance*, 19(2), 237-267.
- Roghaniyan, P. et al. (2012), "Productivity Through Effectiveness and Efficiency in the Banking Industry", *The 2012 International Conference on Asia Pacific Business Innovation and Technology Management Procedia - Social and Behavioral Sciences*, 40, 550-556.
- Ruy, S. & S. Lee (2013), "An exploratory study of efficiency in tax jurisdictions", *Advanced Science and Technology Letters*, 34, 46-49.
- Seligman, E.R.A. (1925), *Essays in Taxation*, 10th edition, The Macmillan Co.: New York.
- Smith, A. (1776 [2005]), *An Inquiry into the Nature and Causes of the Welfare of Nations*, The Electronic Classics Series: The Pennsylvania State University.
- Şenyüz, D. (1995), *Vergilendirmede Yükümlü Psikolojisi*, Bursa.
- Tanzi, V. & H. Zee (2001), *Tax Policy for Developing Countries*, IMF Economic Issues, Washington D.C.
- Tepe, M. (2006), "Kıyaslama Çalışmasında Veri Zarflama Analizi Kullanımı", *Yüksek Lisans Tezi*, İstanbul Teknik Üniversitesi Fen Bilimler Enstitüsü.
- Thanassoulis, E. et al. (1987), "Relative Efficiency Assessments Using Data Envelopment Analysis: An Application to Data on Rates Departments", *The Journal of the Operational Research Society*, 38(5), 397-411.

- Thirtle, C. et al. (2000), “Size Does Matter: Technical and Scale Efficiency in Indian State Tax Jurisdictions”, *Review of Development Economics*, 4, 340-352.
- Tiley, J. (1978) *Revenue Law*, Butterworths: London.
- Tosun, U. & M.C. Güran (2002), “Vergi İdarelerinde Etkinlik Arayışları: Vergi Dairelerinde Etkinlik Ölçümüne Yönelik Bir Deneme”, *HÜ İİBF Dergisi*, 20(2), 187-215.
- Ubaidillah, M. & N. Amah (2020), “The Role of Administrative Modernization in Shaping Tax Moral to Increase Taxpayer Compliance: Case Study in Madiun, Indonesia”, *Semestre Económico*, 23(55), 221-238.
- Villar-Rubio, E. et al. (2016), “Relative Efficiency within a tax administration: The effects of result improvement”, *Revista Finanzas y Política Económica*, 9(1), 135-149.
- Zhou, P. et al. (2010), “Weighting and Aggregation in Composite Indicator Construction: A Multiplicative Optimization Approach”, *Social Indicators Research*, 96, 169-181.

Gümüř-Özuyar, S.E. & A. Özekin (2024), "35 OECD Ülkesinde Vergi İdaresinin Etkinliđi: VZA Yöntemi", *Sosyoekonomi*, 32(59), 475-499.

DÜZELTME: BIST Perakende Ticaret Sektöründe LOPCOW-RSMVC Modeli ile Performans Ölçümü [Sosyoekonomi, 31(57), 419-436; DOI: 10.17233/sosyoekonomi.2023.03.20]

Nazlı ERSOY (<https://orcid.org/0000-0003-0011-2216>), *Osmaniye Korkut Ata University, Türkiye;*
nazliersoy@osmaniye.edu.tr

ERRATUM: Performance Measurement in the BIST Retail and Trade Sector with the LOPCOW-RSMVC Model [Sosyoekonomi, 31(57), 419-436; DOI: 10.17233/sosyoekonomi.2023.03.20]

Erratum

The author acknowledges an error in the technique used under the heading “3.2. LOPCOW Technique” in the article titled [Ersoy, N. (2023), “Performance Measurement in the BIST Retail and Trade Sector with the LOPCOW-RSMVC Model”, *Sosyoekonomi*, 31(57), 419-436] with DOI Ref. Nr. <<https://doi.org/10.17233/sosyoekonomi.2023.03.20>> in the 31st volume, 57th issue of the journal. Specifically, in Step 2 of the technique outlined in the paper, it has been noticed that the cost and benefit formulas, identified as Formula 3 for cost and Formula 4 for benefit, were mistakenly interchanged. Due to this error, the values in Tables 8, 9, 11, 12, 13, and 14 in the application section and the corresponding interpretations below these tables have been affected. The author apologises for this mistake and provides corrections and explanations to rectify the inaccuracies in the reporting in the article. The corrections or explanations supplied aim to address reporting errors identified in the article.

Düzeltilme

Sosyoekonomi Dergisi'nin 31. cildinin 57. sayısında yer alan [Ersoy, N. (2023), “BIST Perakende Ticaret Sektöründe LOPCOW-RSMVC Modeli ile Performans Ölçümü”, *Sosyoekonomi*, 31(57), 419-436] referans tanımlı ve <<https://doi.org/10.17233/sosyoekonomi.2023.03.20>> DOI referans kodlu makalede yazar tarafından “3.2. LOPCOW Tekniği” başlığı altında yer alan ve çalışmada kullanılan teknikte belirtilen adımlardan “Adım 2”de gösterilen fayda ve maliyet formüllerinde 3 No.lu formül maliyet, 4 No.lu formül ise fayda olarak kullanılması gerekirken, yanlışlıkla birbirlerinin yerine kullanıldığı fark edilmiştir. Söz konusu hata, uygulama bölümündeki Tablo 8, 9, 11, 12, 13 ve 14'teki değerlerin ve tabloların altındaki yorumların değişmesine neden olmuştur. Yapılan bu hatadan dolayı yazar okuyuculardan özür dilemektedir. Makalede yer alan hatalı işlemlen kaynaklı raporlamanın giderilmesi amacıyla yapılan düzeltme ve açıklamalar aşağıdaki gibidir:

1) Sayfa 423'te “3.2. LOPCOW Tekniği” başlıklı parağraf aşağıdaki şekilde düzeltilmiştir:

Kriter ağırlıklarını belirlemek amacıyla Ecer & Pamucar (2022) tarafından ortaya konulan LOPCOW tekniği objektif teknikler arasında yer almaktadır ve ağırlıkların hesaplanmasında standart sapma değerlerini dikkate almaktadır.

2) Sayfa 424'te "Adım 2: Karar matrisi normalize edilir" aşamasında yer alan 3 No'lu formül maliyet, 4 No'lu formül ise fayda olarak kullanılması gerekirken, sehven birbirlerinin yerlerine kullanılmış olması nedeniyle çalışma analiz sonuçları itibariyle sayfa 428'de yer alan Tablo 8, sayfa 429'da yer alan Tablo 9 ve Tablo 11, sayfa 430'da yer alan Tablo 12 ile sayfa 431'de yer alan Tablo 13 ve Tablo 14'teki düzeltilmiş veriler ve açıklamalar aşağıda sunulmuştur:

Tablo: 8
Normalize Edilmiş Karar Matrisi

	K1	K2	K3	K4	K5	K6	K7
A1	0,095	0,176	0,245	0,724	0,736	0,351	0,974
A2	0,097	0,181	0,250	0,496	1,000	0,188	0,976
A3	0,040	0,053	1,000	0,000	0,631	0,000	1,000
A4	1,000	1,000	0,000	0,846	0,376	1,000	0,000
A5	0,138	0,386	0,222	0,752	0,433	0,386	0,938
A6	0,000	0,088	0,035	0,760	0,389	0,700	0,804
A7	0,053	0,088	0,555	0,425	0,656	0,114	0,987
A8	0,057	0,000	0,057	1,000	0,147	0,956	0,327
A9	0,046	0,035	0,539	0,476	0,889	0,136	0,984
A10	0,117	0,105	0,420	0,520	0,784	0,167	0,979
A11	0,172	0,181	0,297	0,925	0,432	0,445	0,922

Tablo: 9
PV Değerleri ve Kriter Ağırlıkları

		K1	K2	K3	K4	K5	K6	K7
2017	PV	1,167	0,467	113,960	71,999	44,828	82,407	116,279
	w	0,003	0,001	0,264	0,167	0,104	0,191	0,270
2018	PV	10,173	6,794	103,540	50,172	42,897	44,454	111,713
	w	0,028	0,018	0,280	0,136	0,116	0,120	0,302
2019	PV	13,862	14,804	9,208	39,293	59,435	36,623	98,051
	w	0,051	0,055	0,034	0,145	0,219	0,135	0,361
2020	PV	11,641	6,215	90,565	52,743	54,810	30,161	92,258
	w	0,034	0,018	0,268	0,156	0,162	0,089	0,273
2021	PV	5,197	13,955	38,994	78,954	73,038	34,520	87,923
	w	0,016	0,042	0,117	0,237	0,220	0,104	0,264

Tablo 9'a göre, önem derecesi en yüksek kriter 2017 yılı için K7 (finansman oranı), 2018 yılı için K7 (finansman oranı), 2019 yılı için K7 (finansman oranı), 2020 yılı için K7 (finansman oranı), 2021 yılı için ise K7 (finansman oranı) olarak tespit edilmiştir.

Tablo: 11
Ağırlıklı Matris ve Sıralama Sonuçları

	K1	K2	K3	K4	K5	K6	K7	Σ	Sıra
A1	0,094	0,210	0,821	1,424	0,878	0,622	1,586	5,636	5
A2	0,078	0,147	0,704	1,899	0,220	0,726	1,322	5,096	2
A3	0,157	0,378	0,117	2,611	1,317	1,141	0,264	5,986	7
A4	0,016	0,042	1,290	0,712	2,196	0,104	2,909	7,268	10
A5	0,047	0,084	0,938	1,187	1,537	0,519	1,851	6,162	8
A6	0,172	0,315	1,173	0,949	1,976	0,311	2,380	7,276	11
A7	0,125	0,315	0,235	2,374	1,098	1,037	0,529	5,712	6
A8	0,110	0,462	1,055	0,237	2,415	0,207	2,644	7,131	9
A9	0,141	0,420	0,352	2,136	0,439	0,934	0,793	5,215	3
A10	0,063	0,252	0,469	1,662	0,659	0,830	1,058	4,991	1
A11	0,031	0,147	0,586	0,475	1,757	0,415	2,115	5,526	4

Tablo 11'e göre, 2021 yılı itibariyle finansal performans bakımından firmalar **A10>A2>A9>A11>A1>A7>A3>A5>A8>A4>A6** şeklinde sıralanmıştır. Tüm yıllara ait karşılaştırmalı sonuçlar ise Tablo 12'de sunulmuştur.

Tablo: 12
Karşılaştırmalı Sonuçlar

	2017		2018		2019		2020		2021	
	Değer	Sıra	Değer	Sıra	Değer	Sıra	Değer	Sıra	Değer	Sıra
A1	4,475	2	3,665	1	4,397	1	3,542	1	5,636	5
A2	6,630	8	4,972	5	4,886	2	4,185	2	5,096	2
A3	7,868	11	6,418	7	5,636	5	7,760	10	5,986	7
A4	6,991	9	7,492	8	7,437	10	6,249	5	7,268	10
A5	4,159	1	4,831	4	6,120	7	7,086	8	6,162	8
A6	6,442	7	8,036	10	7,763	11	8,080	11	7,276	11
A7	4,722	4	7,541	9	6,058	6	6,711	7	5,712	6
A8	7,779	10	8,504	11	6,786	9	6,330	6	7,131	9
A9	5,985	5	4,730	3	5,132	3	3,848	2	5,215	3
A10	6,393	6	3,862	2	5,208	4	5,034	4	4,991	1
A11	4,555	3	5,949	6	6,577	8	7,175	9	5,526	4

Tablo 12'ye göre firmaların yıllar itibariyle finansal performans sıralamalarının değiştiği görülmektedir. Çalışma kapsamındaki beş dönem genel olarak değerlendirildiğinde ortalama sıra değerleri bakımından **A1, A2, A9** firmaları ilk üç sırada yer alırken, **A6, A8, A4** firmaları son üç sırada yer almıştır. Genel olarak **A1** firması çoğu dönemde (2018, 2019, 2020) en başarılı firma olarak tespit edilmiştir. Bahsi geçen dönemlerde önem derecesi en yüksek olan kriterlerin yüksek olması, **A1** firmasının ön sıralarda olmasını sağlamıştır.

Tablo 12'de yer alan sonuçlara göre firmaların COVID-19 öncesi (2017-2019) ve COVID-19 sürecindeki (2020,2021) performans sıralamaları incelendiğinde ortalama sıra değerlerine göre firma sıralamalarının değişimi şu şekildedir: **A1, A3, A5, A11** firmaları sıralamada gerilerken, **A2, A4, A8, A9, A10** firmalarının ilk döneme oranla sıralamada daha iyi bir durumda olduğu söylenebilir.

Tablo: 13
Farklı ÇKKV Yöntemleri Temelinde Elde Edilen Sıralamalar

	2017				2018				2019				2020				2021			
	RSMVC	SAW	WASPAS	PIV	RSMVC	SAW	WASPAS	PIV	RSMVC	SAW	WASPAS	PIV	RSMVC	SAW	WASPAS	PIV	RSMVC	SAW	WASPAS	PIV
A1	2	1	1	1	1	1	1	1	1	2	2	2	1	1	1	1	5	2	1	1
A2	8	7	7	7	5	3	2	3	2	1	1	1	2	2	2	2	2	1	2	2
A3	11	11	11	11	7	7	8	7	5	8	10	10	10	11	11	11	7	9	11	9
A4	9	9	9	10	8	9	10	10	10	10	8	11	5	5	5	9	10	8	9	11
A5	1	3	3	3	4	5	3	2	7	5	4	4	8	6	6	6	8	7	6	6
A6	7	4	4	4	10	8	7	7	11	9	9	7	11	9	9	7	11	10	9	8
A7	4	5	5	5	9	11	11	11	6	6	7	9	7	10	10	10	6	6	7	7
A8	10	8	8	8	11	10	9	9	9	11	11	5	6	8	8	8	9	11	10	10
A9	5	10	10	9	3	4	4	5	3	3	3	3	2	3	3	3	3	3	3	3
A10	6	6	6	6	2	2	5	4	4	4	5	8	4	4	4	4	1	4	4	5
A11	3	2	2	2	6	6	6	6	8	7	6	6	9	7	7	5	4	5	5	4

Tablo 13'e göre, farklı ÇKKV yöntemleri ile elde edilen sıralamalar küçük sapmalar göstererek birbirinden farklılaşmıştır. Aynı veri seti kullanılarak farklı algoritmalarla sahip

olan ÇKKV yöntemleri ile ulaşılan sonuçlar değişebilmektedir. Literatürde bu duruma örnek olabilecek pek çok çalışmaya (Mathew & Sahu, 2018; Goswami et al., 2021; Ecer & Pamucar, 2022; Nguyen et al., 2022) rastlamak mümkündür.

Tablo: 14
Farklı Ağırlıklandırma Teknikleri ile Elde Edilen RSMVC Sıralamaları

	2017			2018			2019			2020			2021		
	LOPCOW	Entropy	EA	LOPCOW	Entropy	EA	LOPCOW	Entropy	EA	LOPCOW	Entropy	EA	LOPCOW	Entropy	EA
A1	2	2	2	1	1	1	1	1	1	1	1	1	5	6	6
A2	8	7	7	5	3	3	2	3	2	2	3	3	2	2	2
A3	11	11	10	7	8	8	5	8	7	10	11	10	7	11	9
A4	9	5	4	8	5	5	10	4	3	5	2	2	10	3	5
A5	1	1	1	4	2	2	7	6	4	8	6	6	8	5	4
A6	7	6	6	10	9	10	11	11	10	11	10	9	11	10	11
A7	4	4	5	9	10	9	6	9	9	7	9	8	6	9	7
A8	10	10	11	11	11	11	9	2	1	6	4	4	9	8	10
A9	5	9	9	3	7	7	3	7	6	2	5	5	3	7	8
A10	6	8	8	2	6	6	4	10	8	4	8	6	1	4	3
A11	3	3	3	6	4	4	8	5	5	9	7	7	4	1	1

Tablo 14'ten de görüleceği üzere üç ağırlıklandırma tekniği temelinde elde edilen RSMVC sıralamaları birbirinden farklıdır ve küçük sapmalar göstermiştir. Entropy ve EA yöntemleri ile elde edilen sıralamalar LOPCOW tekniği ile elde edilen sıralamalara kıyasla daha homojendir. Aynı veri seti kullanılarak farklı ağırlıklar temelinde elde edilen ÇKKV sıralamaları değişebilmektedir ve literatürde bu durumun pek çok örneğini (Zavadskas & Podvezko, 2016; Hafezparast et al., 2015; Žižović et al., 2020) bulmak mümkündür.

3) *Sonuç kısmında LOPCOW ağırlıklarındaki değişime bağlı olarak firma sıralamaları ve sıralamalar arasındaki korelasyon değerleri de düzeltilmiş olup 2. ve 3. paragraflar aşağıdaki şekilde değiştirilmiştir:*

LOPCOW-RSMVC modeli ile ulaşılan sonuçlara göre firmaların finansal performansları genel olarak yıllar bazında değişiklik göstermiştir. Beş dönemin ortalama sıra değerleri dikkate alındığında ise firmaların sıralaması **A1>A9>A10>A2>A5>A11>A7>A3>A4>A8>A6** şeklinde gerçekleşmiştir. Çalışmada kullanılan modelin sağlamlığını test etmek amacıyla iki aşamadan oluşan bir duyarlılık analizi gerçekleştirilmiştir. İlk olarak, farklı ÇKKV yöntemleri (SAW, PIV, WASPAS, RSMVC) kullanılarak elde edilen sonuçlar kıyaslanmış, ikinci aşamada ise farklı kriter ağırlıklandırma teknikleri (Entropy, EA, LOPCOW) temelinde elde edilen sonuçlar kıyaslanmıştır. Farklı ÇKKV yöntemleri ve farklı kriter ağırlıklandırma teknikleri temelinde elde edilen sıralamalar genel olarak küçük sapmalar göstererek farklılaşırken, sonuçlar arasında pozitif yönlü yüksek bir ilişki tespit edilmiştir.

Beş farklı yöntem ile elde edilen sıralamalar arasında bir ilişki olup olmadığını belirlemek amacıyla Spearman korelasyon analizi yapılmıştır. 2017 yılı için en yüksek korelasyon katsayısı **SAW** ve **WASPAS (1)** arasında tespit edilirken, sırasıyla 2018 yılı için **PIV** ve **SAW (0,922)**, 2019 yılı için, **SAW** ve **WASPAS (0,922)**, 2020 yılı için **SAW** ve

WASPAS (1), 2021 yılı için ise **PIV** ve **WASPAS (0,952)** en yüksek korelasyon katsayısına sahip yöntemler olarak tespit edilmiştir. Entropy ve EA yöntemleri ile elde edilen sıralamaların ise LOPCOW tekniği ile elde edilen sıralamalara kıyasla daha homojen olduğu tespit edilmiştir.

NOTES FOR CONTRIBUTORS

1. Articles not published or submitted for publication elsewhere accepted in either *Turkish* or *British English*.

2. Manuscripts should be at most single-spaced 24 A4 pages with the *Times New Roman* 11-font character size. Only the DergiPark platform welcomes article submissions.

3. The first page of the Word file to be submitted should include (i) the title of the article; (ii) an abstract of not more than 100 words; (iii) the keywords; and (iv) the JEL Codes; also (i) the full name(s) of the author(s); (ii) the ORCID ID numbers; (iii) institutional affiliation(s) of the author(s); (iv) the e-mail address and phone numbers of the author(s) should be indicated on a separate page. "Ethics Committee Permission Certificate" obtained from the relevant institution in studies that required ethical approval and based on questionnaires should be uploaded at the time of submission.

4. Tables, figures, and graphs should be numbered consecutively and contain full references. The titles of the tables, figures, and graphs should be placed at their heading; the references of tables, figures, and graphs should be at the bottom. A comma should separate decimals. Equations should be numbered consecutively. Equation numbers should appear in parentheses at the right margin. The complete derivation of the formulas (if abridged in the text) should be provided on a separate sheet for referee use.

5. Footnotes should be placed at the bottom of the page.

6. All references should cite in the text (not in footnotes) and conform to the following examples:

It has been argued (Alkin, 1982: 210-5)....

Griffin (1970a: 15-20) states....

(Gupta et al., 1982: 286-7).

(Rivera-Batiz & Rivera-Batiz, 1989: 247-9; Dornbusch, 1980: 19-23).

7. References should appear at the end of the text as follows:

Books: Kenen, P.B. (1989), *The International Economy*, Englewood Cliffs, N.J.: Prentice-Hall, Inc.

Periodicals: Langeheine, B. & U. Weinstock (1985), "Graduate Integration", *Journal of Common Market Studies*, 23(3), 185-97.

Articles in edited books: Krugman, P. (1995), "The Move Toward Free Trade Zones", in: P. King (ed.), *International Economics and International Economic Policy: A Reader*, New York: McGraw-Hill, Inc., 163-82.

Other sources: Central Bank of the Republic of Turkey (2003), *Financial Stability*, Press Release, March 24, Ankara, <<http://www.tcmb.gov.tr>>.

Chang, R. (1998), "The Asian Crisis", *NBER Discussion Paper*, 4470, National Bureau of Economic Research, Cambridge, Mass.

8. Cited web pages should exist at the References with their complete address and cited date as follows:

....., <<http://www.sosyoekonomijournal.org>>, 18.12.2024.

YAZARLARA DUYURU

1. Sosyoekonomi Dergisinde sadece *Türkçe ve İngilizce* makaleler yayımlanmaktadır. Dergiye gönderilen makaleler başka bir yerde yayımlanmamış veya yayımlanmak üzere gönderilmemiş olmalıdır.

2. Yazılar A4 boyutunda kâğıda, tek aralıkla, *Times New Roman* karakterinde, 11 punto ile ve 24 sayfayı geçmeyecek şekilde yazılmalıdır. DergiPark platformu dışından yapılan gönderiler kesinlikle kabul edilmemektedir.

3. Gönderilecek Word dosyasının ilk sayfasında Türkçe ve İngilizce olarak şu bilgiler yer almalıdır: (i) yazının başlığı; (ii) en çok 100 kelimelik özet; (iii) anahtar sözcükler; ile (iv) çalışmanın JEL kodları; ayrı bir Word dosyasında ise (i) yazar(lar)ın adı; (ii) ORCID ID numaraları; (iii) yazar(lar)ın bağlı bulunduğu kurumun açık adı; ile (iv) yazar(lar)ın e-mail adresi ve telefon numarası belirtilmelidir. Etik onayı gerektiren ve ankete dayalı çalışmalarda ilgili kurumdan alınan “Etik Kurul İzni Belgesi” başvuru anında sisteme yüklenmelidir.

4. Tablo, şekil ve grafiklere başlık ve numara verilmeli, başlıklar tablo, şekil ve grafiklerin üzerinde yer almalı, kaynaklar ise tablo, şekil ve grafiklerin altına yazılmalıdır. Rakamlarda ondalık kesirler virgül ile ayrılmalıdır. Denklemlere verilecek sıra numarası parantez içinde sayfanın en sağında ve parantez içinde yer almalıdır. Denklemlerin türetilişi, yazıda açıkça gösterilmemişse, hakemlerin değerlendirmesi için, türetme işlemi bütün basamaklarıyla ayrı bir sayfada verilmelidir.

5. Yazılarda yapılan atıflara ilişkin dipnotlar sayfa altında yer almalıdır.

6. Kaynaklara göndermeler dipnotlarla değil, metin içinde, sayfa numaralarını da içererek, aşağıdaki örneklerde gösterildiği gibi yapılmalıdır:

.....belirtilmiştir (Alkin, 1982: 210-5).

.....Griffin (1970a: 15-20) ileri sürmektedir.

(Gupta vd., 1982: 286-7).

(Rivera-Batiz & Rivera-Batiz, 1989: 247-9; Dornbusch, 1980: 19-23).

7. Metinde gönderme yapılan bütün kaynaklar, sayfa numaraları ile birlikte, “Kaynaklar” (“Kaynakça” diye yazılmayacak) başlığı altında ve aşağıdaki örneklerle uygun olarak belirtilmelidir:

Kitaplar: Kenen, P.B. (1989), *The International Economy*, Englewood Cliffs, N.J.: Prentice-Hall, Inc.

Dergiler: Langeheine, B. & U. Weinstock (1985), “Graduate Integration”, *Journal of Common Market Studies*, 23(3), 185-97.

Derlemeler: Krugman, P. (1995), “The Move Toward Free Trade Zones”, P. King (ed.), *International Economics and International Economic Policy: A Reader* içinde, New York: McGraw-Hill, Inc., 163-82.

Diğer Kaynaklar: Türkiye Cumhuriyet Merkez Bankası (2001), *2002 Yılında Para ve Kur Politikası ve Muhtemel Gelişmeler*, Basın Duyurusu, 2 Ocak, Ankara, <<http://www.tcmb.gov.tr>>.

Chang, R. (1998), “The Asian Crisis”, *NBER Discussion Paper*, 4470, National Bureau of Economic Research, Cambridge, Mass.

8. Kaynaklar’da web sitelerine yapılan atıflar muhakkak, gün, ay, yıl olarak alındığı tarih itibariyle ve tam adresleriyle birlikte belirtilmelidir.

....., <<http://www.sosyoekonomijournal.org>>, 18.12.2024.